



16 cm

ABRIDOR ALUM LATA BORBOLETA 16CM 3092

Código:	Fábrica:	Unidade:
<b>44736</b>	<b>WINCY</b>	<b>UN/1</b> <b>F1 F4</b>



ABRIDOR COMBIN INOX LATA/GARR 1004 12X1

Código:	Fábrica:	Unidade:
<b>14382</b>	<b>JWC</b>	<b>DZ/12</b> <b>F1 F4</b>



ABRIDOR COMBINADO INOX LATA/GARRAFA 147

Código:	Fábrica:	Unidade:
<b>44771</b>	<b>NICOBEM</b>	<b>CT/1</b> <b>F1 F4</b>



ABRIDOR COMBINADO INOX LATA/GARRAFA 279

Código:	Fábrica:	Unidade:
<b>44503</b>	<b>PLANETA</b>	<b>CT/1</b> <b>F1 F4</b>



ABRIDOR COMBINADO LATA/GARRAFA 1001 12X1

Código:	Fábrica:	Unidade:
<b>1915</b>	<b>JWC</b>	<b>DZ/12</b> <b>F1 F4</b>



ABRIDOR COMBINADO+SACA ROLHA CTL 2028

Código:	Fábrica:	Unidade:
<b>33288</b>	<b>JWC</b>	<b>CR/1</b> <b>F1 F4</b>



ABRIDOR GARRAFA NA CX 1002 12X1

Código:	Fábrica:	Unidade:
<b>13925</b>	<b>JWC</b>	<b>DZ/12</b> <b>F1 F4</b>



ABRIDOR INOX GARRAFAS GARCON 280 12X1

Código:	Fábrica:	Unidade:
<b>48691</b>	<b>PLANETA</b>	<b>DZ/12</b> <b>F1 F4</b>



ABRIDOR INOX GARRAFAS GARCON 281 CTL

Código:	Fábrica:	Unidade:
<b>48694</b>	<b>PLANETA</b>	<b>CR/1</b> <b>F1 F4</b>



ABRIDOR SACA ROLHA CABO PLAST 1006 12X1

Código:	Fábrica:	Unidade:
<b>2886</b>	<b>JWC</b>	<b>DZ/12</b> <b>F1 F4</b>



ABRIDOR SACA ROLHA INOX MULTIUSOCTL 5385

Código:	Fábrica:	Unidade:
<b>43270</b>	<b>MEGAGIFT</b>	<b>UN/1</b> <b>F1 F4</b>



ABRIDOR SACA ROLHAS INOX DUPLO EST 12X1

Código:	Fábrica:	Unidade:
<b>46585</b>	<b>HERCULES</b>	<b>CX/12</b> <b>F1 F4</b>



ADAPTADOR PORTA FILTRO PLAST 5026 UN

Código:	Fábrica:	Unidade:
<b>49399</b>	<b>SBRISSA</b>	<b>UN/1</b> <b>F1 F4</b>



ADAPTADOR PORTA FILTRO PLAST 5026 20X1

Código:	Fábrica:	Unidade:
<b>31283</b>	<b>SBRISSA</b>	<b>PT/20</b> <b>F1 F4</b>



ADAPTADOR 1/2 TORNEI/MANG PTO AD51N 50X1

Código:	Fábrica:	Unidade:
<b>40147</b>	<b>REBOUCAS</b>	<b>PT/50</b> <b>F1 F4</b>



ADAPTADOR 3/4 TORNEI/MANG PTO AD52N 50X1

Código:	Fábrica:	Unidade:
<b>40148</b>	<b>REBOUCAS</b>	<b>PT/50</b> <b>F1 F4</b>



AFIADOR DE FACA C/VENTOSA PLAST 371

Código: 48689  
Fábrica: PLANETA  
Unidade: UN/1  
F1 F4



AGUA SANITARIA MAIS 1 LT

Código: 48940  
Fábrica: MAIS  
Unidade: UN/1  
F1 F4

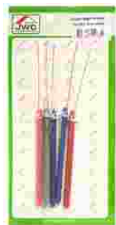

AGULHA P/DESENTUPIR FOGAO CTL 2023 5X1

Código: 33290  
Fábrica: JWC  
Unidade: CR/5  
F1 F4



AGULHA P/DESENTUPIR FOGAO 12X1

Código: 7374  
Fábrica: ALE  
Unidade: DZ/12  
F1 F4



26 cm



AMASSADOR ALUM INTEIRICO BATATA 2007 UN

Código: 48030  
Fábrica: COFAX  
Unidade: UN/1  
F1 F4



AMASSADOR INOX ALHO PRIME 061

Código: 49376  
Fábrica: RIOHOME  
Unidade: UN/1  
F1 F4

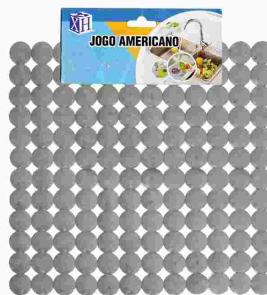

AMERICANO P/MESA 24X24CM TM-2424

Código: 39280  
Fábrica: XHADAY  
Unidade: UN/1  
F1 F4

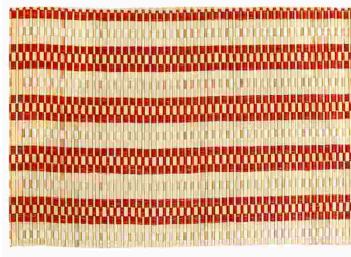

30cm  
45 cm

AMERICANO P/MESA 30X45CM 10221

Código: 45882  
Fábrica: ALMEGA  
Unidade: UN/1  
F1 F4



AMERICANO P/MESA 35X48CM JOGO 4PCS

Código: 29116  
Fábrica: FERREIRA  
Unidade: PT/4  
F1 F4



9 cm

ARCO ALUMINIO N1 P/PLANTA 1011

Código: 37169  
Fábrica: PAIOL  
Unidade: UN/1  
F1 F4



10 cm

ARCO ALUMINIO N2 P/PLANTA 3000

Código: 37170  
Fábrica: PAIOL  
Unidade: UN/1  
F1 F4



14 cm

ARCO ALUMINIO N3 P/PLANTA 3001

Código: 37172  
Fábrica: PAIOL  
Unidade: UN/1  
F1 F4



22 cm

ARCO ALUMINIO N5 P/PLANTA 3003

Código: 37173  
Fábrica: PAIOL  
Unidade: UN/1  
F1 F4



13 cm

ARRANJO BAMBU QUAD 6X6CM 8058

Código: 40590  
Fábrica: PAIOL  
Unidade: UN/1  
F1 F4



14,5 cm

ARRANJO BAMBU RED 5X5CM 8062

Código: 40591  
Fábrica: PAIOL  
Unidade: UN/1  
F1 F4



ASSADEIRA ALUM CORACAO 01 1263

Código: 37513  
Fábrica: MSR  
Unidade: UN/1  
F1 F4



ASSADEIRA ALUM CORACAO 02 1264

Código: 37254  
 Fábrica: MSR  
 Unidade: UN/1  
 F1 F4



ASSADEIRA ALUM CORACAO 03 1265

Código: 37252  
 Fábrica: MSR  
 Unidade: UN/1  
 F1 F4



ASSADEIRA ALUM FUNDO FALSO 01 648

Código: 35257  
 Fábrica: MSR  
 Unidade: UN/1  
 F1 F4



ASSADEIRA ALUM FUNDO FALSO 02 649

Código: 35258  
 Fábrica: MSR  
 Unidade: UN/1  
 F1 F4



ASSADEIRA ALUM FUNDO FALSO 03 650

Código: 37523  
 Fábrica: MSR  
 Unidade: UN/1  
 F1 F4



ASSADEIRA ALUM OVAL 01 651

Código: 37519  
 Fábrica: MSR  
 Unidade: UN/1  
 F1 F4



ASSADEIRA ALUM OVAL 02 652

Código: 37520  
 Fábrica: MSR  
 Unidade: UN/1  
 F1 F4



ASSADEIRA ALUM OVAL 03 653

Código: 37521  
 Fábrica: MSR  
 Unidade: UN/1  
 F1 F4



ASSADEIRA VIDRO RET KIT 3UN (2,2/1,6/1L)

Código: 47415  
 Fábrica: DIAMONDS  
 Unidade: CJ/1  
 F1 F4



AVENTAL NYLON PP 1,10X63CM PEIXEIRO 32

Código: 49687  
 Fábrica: MARIO BRITO  
 Unidade: UN/1  
 F1 F4



AVENTAL NYLON PP 45X65CM REDONDO LISO 01

Código: 49686  
 Fábrica: MARIO BRITO  
 Unidade: UN/1  
 F1 F4



AVENTAL NYLON 50X70CM C/BOLSO 72901

Código: 49580  
 Fábrica: ALMEGA  
 Unidade: UN/1  
 F1 F4



AVENTAL PVC GDE 56X85CM

Código: 32344  
 Fábrica: FERREIRA  
 Unidade: UN/1  
 F1 F4



AVENTAL PVC MED 50X75CM

Código: 28178  
 Fábrica: FERREIRA  
 Unidade: UN/1  
 F1 F4



AVENTAL PVC 50X70CM C/BOLSO (CANGURU)

Código: 44154  
 Fábrica: FERREIRA  
 Unidade: UN/1  
 F1 F4



BACIA ALUM LEVE 25 1,300 ML

Código: 5906  
 Fábrica: AVELAR  
 Unidade: UN/1  
 F1 F4

 <p>BACIA N23 23 LTSCANELADA PRETO 10080</p> <p>Código: <b>41441</b>      Fábrica: <b>PLASMARC</b>      Unidade: <b>UN/1</b> F1 F4</p>	 <p><b>8</b> Lts</p> <p>BACIA PLAST 2,3 LTS BRANCO</p> <p>Código: <b>40775</b>      Fábrica: <b>NUTRIPLAN</b>      Unidade: <b>UN/1</b> F1 F4</p>	 <p>BACIA PLAST 3 LTS PRETA 2001</p> <p>Código: <b>40378</b>      Fábrica: <b>FORMPLAST</b>      Unidade: <b>UN/1</b> F1 F4</p>	 <p><b>9</b>cm <b>26</b>cm <b>3,3</b>lts</p> <p>BACIA PLAST 3,3 LTS TRANSLUCIDA 0524</p> <p>Código: <b>7495</b>      Fábrica: <b>JAGUAR</b>      Unidade: <b>UN/1</b> F1 F4</p>
 <p>BACIA PLAST 3,5 LTS CANELADA 387</p> <p>Código: <b>35577</b>      Fábrica: <b>BH PLASTIC</b>      Unidade: <b>UN/1</b> F1 F4</p>	 <p><b>10</b>cm <b>33</b>cm <b>6,7</b>lts</p> <p>BACIA PLAST 6,7 LTS TRANSLUCIDA 0526</p> <p>Código: <b>8265</b>      Fábrica: <b>JAGUAR</b>      Unidade: <b>UN/1</b> F1 F4</p>	 <p><b>8</b> Lts</p> <p>BACIA PLAST 8 LTS BRANCO</p> <p>Código: <b>40776</b>      Fábrica: <b>NUTRIPLAN</b>      Unidade: <b>UN/1</b> F1 F4</p>	 <p>BACIA PLAST N18 13 LTS CANELAD PRETO 119</p> <p>Código: <b>41442</b>      Fábrica: <b>PLASMARC</b>      Unidade: <b>UN/1</b> F1 F4</p>
 <p>BACIA PLAST 12 LTS CANELADA 6614</p> <p>Código: <b>8705</b>      Fábrica: <b>INPLAST</b>      Unidade: <b>UN/1</b> F1 F4</p>	 <p>BACIA PLAST 12,0 LTS CANELADA</p> <p>Código: <b>30892</b>      Fábrica: <b>BH PLASTIC</b>      Unidade: <b>UN/1</b> F1 F4</p>	 <p><b>13</b> lts</p> <p>BACIA PLAST 13 LTS COLLOR 860</p> <p>Código: <b>39562</b>      Fábrica: <b>LUMAR</b>      Unidade: <b>UN/1</b> F1 F4</p>	 <p><b>14</b> Lts</p> <p>BACIA PLAST 14 LTS BRANCO</p> <p>Código: <b>40777</b>      Fábrica: <b>NUTRIPLAN</b>      Unidade: <b>UN/1</b> F1 F4</p>
 <p>BACIA PLAST 1,5 LTS COLOR</p> <p>Código: <b>20585</b>      Fábrica: <b>ECOPLASTIC</b>      Unidade: <b>UN/1</b> F1 F4</p>	 <p><b>17</b>cm <b>41</b>cm <b>15</b>lts</p> <p>BACIA PLAST 15 LTS TRANSLUCIDA 0528</p> <p>Código: <b>7496</b>      Fábrica: <b>JAGUAR</b>      Unidade: <b>UN/1</b> F1 F4</p>	 <p><b>47</b>cm <b>18</b>lts</p> <p>BACIA PLAST 18 LTS PRETA 105</p> <p>Código: <b>40404</b>      Fábrica: <b>FORMPLAST</b>      Unidade: <b>UN/1</b> F1 F4</p>	 <p>BACIA PLAST 2 LTS CANELADA PRETA 6304</p> <p>Código: <b>41493</b>      Fábrica: <b>KOZI PLAST</b>      Unidade: <b>UN/1</b> F1 F4</p>



BACIA PLAST 2,4 LTS 71493

Código: **31295** Fábrica: **Y888** Unidade: **UN/1**  
F1 F4



BACIA PLAST 3 LTS CANELADA PRETA 6305

Código: **41474** Fábrica: **KOZI PLAST** Unidade: **UN/1**  
F1 F4



BACIA PLAST 3,0 LTS LISA

Código: **17857** Fábrica: **ECOPLASTIC** Unidade: **UN/1**  
F1 F4



BACIA PLAST 7 LTS COLOR

Código: **45279** Fábrica: **MOLDE MINAS** Unidade: **UN/1**  
F1 F4

15 cm  
32 cm  
7 lts



BACIA 1,2 LTS CANELADA RECICLADA 6001

Código: **17981** Fábrica: **SBRISSA** Unidade: **UN/1**  
F1 F4



BACIA 2,5 LTS CANELADA RECICLADA 6002

Código: **17982** Fábrica: **SBRISSA** Unidade: **UN/1**  
F1 F4



BACIA 2,5 LTS CANELADA TRANSPARENTE 4007

Código: **19763** Fábrica: **SBRISSA** Unidade: **UN/1**  
F1 F4



BACIA 4,5 LTS CANELADA RECICLADA 6003

Código: **17983** Fábrica: **SBRISSA** Unidade: **UN/1**  
F1 F4



BACIA 4,5 LTS CANELADA TRANSPARENTE 4008

Código: **18713** Fábrica: **SBRISSA** Unidade: **UN/1**  
F1 F4



BACIAO PLAST 35 LTS CANELADA 719/92

Código: **36696** Fábrica: **LUMAR/PA** Unidade: **UN/1**  
F1 F4



BALDE METAL 5 LTS DEC FLAMENGO 1893

Código: **41121** Fábrica: **BRASFOOT** Unidade: **UN/1**  
F1 F4



BALDE PLAST 2,5 LTS P/PIPOCA 7008

Código: **31284** Fábrica: **SBRISSA** Unidade: **UN/1**  
F1 F4



BALDE PLAST 7,5 LTS C/ALCA METAL 90

Código: **36698** Fábrica: **P A SOUZA** Unidade: **UN/1**  
F1 F4

23cm  
25cm  
7,5lts

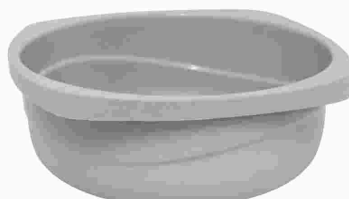

BALDE PLAST 9 LTS CINZA

Código: **40778** Fábrica: **NUTRIPLAN** Unidade: **UN/1**  
F1 F4

9 Lts



BALDE PLAST LATA CONCRETO 16 LTS PRETA

Código: **20661** Fábrica: **ECOPLASTIC** Unidade: **UN/1**  
F1 F4



BALDE PLAST 12 LTS ELEGANCE PRETO 413

Código: **50005** Fábrica: **PLASMARC** Unidade: **UN/1**  
F1 F4



BALDE PLAST 12 LTS PRETO P/CONCRETO 105

Código: **40719** Fábrica: **ECOPLASTIC** Unidade: **UN/1**  
F1 F4



BALDE PLAST 1,2LTS PIPOCA COLOR ADE 3105

Código: **50088** Fábrica: **LIDER PLUS** Unidade: **UN/1**  
F1 F4



BALDE PLAST 1,2LTS PIPOCA COLOR 3104

Código: **41785** Fábrica: **LIDER PLUS** Unidade: **UN/1**  
F1 F4



BALDE PLAST 13 LTS ALCA METAL 6615

Código: **14402** Fábrica: **INPLAST** Unidade: **UN/1**  
F1 F4



BALDE PLAST 13 LTS OVAL ALCA PLAST 102

Código: **40717** Fábrica: **PLASMARC** Unidade: **UN/1**  
F1 F4



BALDE PLAST 15 LTS PRETO ALCA METAL

Código: **17810** Fábrica: **SHANGRILA** Unidade: **UN/1**  
F1 F4

28cm  
32cm  
15lts



BALDE PLAST 15 LTS 753

Código: **37263** Fábrica: **LUMAR** Unidade: **UN/1**  
F1 F4



BALDE PLAST 20 LTS 720

Código: **37262** Fábrica: **LUMAR** Unidade: **UN/1**  
F1 F4

13 cm



BALDINHO PLAST P/PIPOCA 1065

Código: **37802** Fábrica: **ENGIPLAST** Unidade: **UN/1**  
F1 F4

07 cm  
21 cm  
34 cm  
02 lts



BANDEJA 15 CELULAS BAIXA 5 F PRETO 2134

Código: **33544** Fábrica: **NUTRIPLAN** Unidade: **UN/1**  
F1 F4



BANDEJA 30 CELULAS PRETO

Código: **33545** Fábrica: **NUTRIPLAN** Unidade: **UN/1**  
F1 F4

09 cm  
30 cm  
36 cm  
03 lts



BANDEJA BAMBU 39X15X1,2CM 114

Código: **47904** Fábrica: **CASITA** Unidade: **UN/1**  
F1 F4

4,5 cm  
30 cm

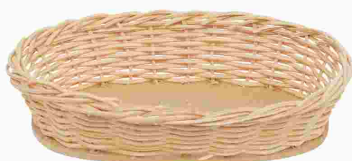

BANDEJA CIPO BRANCO OVAL GDE 8102

Código: **40599** Fábrica: **PAIOL** Unidade: **UN/1**  
F1 F4

4,5 cm  
23,5 cm



BANDEJA CIPO BRANCO OVAL PQ 8106

Código: **40595** Fábrica: **PAIOL** Unidade: **UN/1**  
F1 F4

5 cm  
22 cm

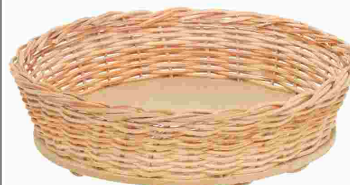

BANDEJA CIPO BRANCO RED GDE 8101

Código: **40602** Fábrica: **PAIOL** Unidade: **UN/1**  
F1 F4

2,5 cm  
21,5 cm

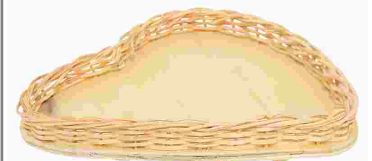

BANDEJA CORACAO CIPO BRANCO N4 8114

Código: **40606** Fábrica: **PAIOL** Unidade: **UN/1**  
F1 F4

1 2,5 cm  
2 25 cm



BANDEJA CORACAO CIPO BRANCO N5 8115

Código: 40607 Fábrica: PAIOL Unidade: UN/1  
F1 F4

1 5,5 cm  
2 30,5 cm  
3 31,5 cm



BANDEJA CORACAO FIO GDE BANANA 6999-2

Código: 39450 Fábrica: PAIOL Unidade: UN/1  
F1 F4

1 6 cm  
2 29 cm



BANDEJA CORACAO FIO MED ARGILA 7000-1

Código: 37206 Fábrica: PAIOL Unidade: UN/1  
F1 F4

1 5,5 cm  
2 26 cm  
3 26 cm



BANDEJA CORACAO FIO MED BANANA 7000-2

Código: 39451 Fábrica: PAIOL Unidade: UN/1  
F1 F4

1 6 cm  
2 22 cm



BANDEJA CORACAO FIO PEQ ARGILA 7001-1

Código: 37207 Fábrica: PAIOL Unidade: UN/1  
F1 F4

1 5,5 cm  
2 21 cm  
3 21 cm



BANDEJA CORACAO FIO PEQ BANANA 7001-2

Código: 39452 Fábrica: PAIOL Unidade: UN/1  
F1 F4



BANDEJA CORACAO PINUS ENVELHEC GDE 3103

Código: 41749 Fábrica: PAIOL Unidade: UN/1  
F1 F4



BANDEJA CORACAO PINUS ENVELHEC MED 3104

Código: 40845 Fábrica: PAIOL Unidade: UN/1  
F1 F4

1 6 cm  
2 35 cm



BANDEJA CORACAO PINUS ENVELHEC PEQ 3105

Código: 41750 Fábrica: PAIOL Unidade: UN/1  
F1 F4



BANDEJA FIO GDE 8013

Código: 37196 Fábrica: PAIOL Unidade: UN/1  
F1 F4

1 6 cm  
2 28 cm



BANDEJA FIO MED 8014

Código: 37197 Fábrica: PAIOL Unidade: UN/1  
F1 F4

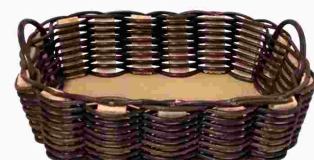

BANDEJA FIO PEQ 8015

Código: 37198 Fábrica: PAIOL Unidade: UN/1  
F1 F4

1 7,5 cm  
2 42 cm



BANDEJA FITA GDE 8010

Código: 37193 Fábrica: PAIOL Unidade: UN/1  
F1 F4

22 cm



BANDEJA INOX OVAL 22CM 800-17

Código: 40529 Fábrica: CASA ONZE Unidade: UN/1  
F1 F4

25 cm



BANDEJA INOX OVAL 25CM 800-18

Código: 40532 Fábrica: CASA ONZE Unidade: UN/1  
F1 F4

35 cm



BANDEJA INOX RED EMBORRACHAD 35CM 180205

Código: 39227 Fábrica: SATYAM Unidade: UN/1  
F1 F4

40 cm



BANDEJA INOX RED EMBORRACHAD 40CM 180206

Código: 39228  
Fábrica: SATYAM  
Unidade: UN/1  
F1 F4

17 cm  
40 cm



BANDEJA PINUS GDE 8016

Código: 37199  
Fábrica: PAIOL  
Unidade: UN/1  
F1 F4

10 cm  
35 cm



BANDEJA PINUS MED 8017

Código: 37200  
Fábrica: PAIOL  
Unidade: UN/1  
F1 F4

9,5 cm  
28 cm



BANDEJA PINUS PEQ 8018

Código: 37201  
Fábrica: PAIOL  
Unidade: UN/1  
F1 F4

5,5 cm  
30 cm  
18 cm



BANDEJA PLAST MULTI USO 1,5L 17X31CM 731

Código: 44083  
Fábrica: QUALYPLAS  
Unidade: UN/1  
F1 F4

65 cm

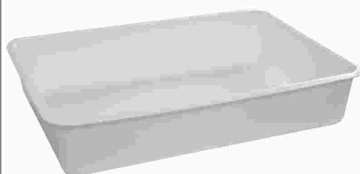

BANDEJA PLAST N5 BCA 26LTS 584

Código: 37781  
Fábrica: TRITEC  
Unidade: UN/1  
F1 F4

44cm  
32cm



BANDEJA PLAST 32,5X43,5CM MULTI USO 1562

Código: 47063  
Fábrica: JAGUAR  
Unidade: UN/1  
F1 F4

9,5 cm  
26 cm



BANDEJA TEXTURA PEQ 8009

Código: 37192  
Fábrica: PAIOL  
Unidade: UN/1  
F1 F4

104 cm  
27 cm  
53 cm  
2,5 lts



BANDEJA 128 CELULAS FINA PRETO

Código: 38916  
Fábrica: NUTRIPLAN  
Unidade: UN/1  
F1 F4



BANDEJA 200 CELULAS F08 FINA PRETO

Código: 33543  
Fábrica: NUTRIPLAN  
Unidade: UN/1  
F1 F4

80cm  
23lts



BANHEIRA INF TRANSP 23 LTS ROSA 7741

Código: 6191  
Fábrica: JAGUAR  
Unidade: UN/1  
F1 F4



BANQUETA ARAXA BRANCA

Código: 21134  
Fábrica: ANTARES  
Unidade: UN/1  
F1 F4



BANQUETA ARAXA PRETA

Código: 25105  
Fábrica: ANTARES  
Unidade: UN/1  
F1 F4



BANQUETA PLAST CARIBE PRETA 944

Código: 42760  
Fábrica: LUMAR  
Unidade: UN/1  
F1 F4



BANQUETA PLAST PRETA 8000

Código: 40410  
Fábrica: FORMPLAST  
Unidade: UN/1  
F1 F4

24,5 cm  
40 cm  
31,5 cm



BAU SINTETICO N3 40X30X24CM 8079

Código: 40332  
Fábrica: PAIOL  
Unidade: UN/1  
F1 F4



BEBEDOURO AMARELO P/BEIJA FLOR 280ML

Código: **27121** Fábrica: **NUTRIPLAN** Unidade: **UN/1**  
F1 F4



BEBEDOURO LARANJA P/BEIJA FLOR 280ML

Código: **18504** Fábrica: **NUTRIPLAN** Unidade: **UN/1**  
F1 F4



BICO ADAPTADOR AJUST P/TORNEIRA CTL 5364

Código: **43272** Fábrica: **MEGAGIFT** Unidade: **CT/1**  
F1 F4



BICO AREJADOR P/TORNEIRA 1021 12X1

Código: **50826** Fábrica: **JWC** Unidade: **DZ/1**  
F1 F4



BICO AREJADOR P/TORNEIRA 23453

Código: **45881** Fábrica: **ALMEGA** Unidade: **UN/1**  
F1 F4



BICO CONEXAO P/TORNEIRA C/ANEL VEDA 390

Código: **49739** Fábrica: **NOVA MARCA** Unidade: **UN/1**  
F1 F4



10 cm



BICO METAL MANGUEIRA 10CM CTL 37-20

Código: **44774** Fábrica: **NICOBEM** Unidade: **UN/1**  
F1 F4



BICO PLAST REGADOR PRETO 9754

Código: **50963** Fábrica: **ARBRA** Unidade: **UN/1**  
F1 F4



BICO P/TORNEIRA JARDIM B151N 12X1

Código: **33737** Fábrica: **REBOUCAS** Unidade: **PT/12**  
F1 F4



BICO P/TORNEIRA TANQUE PIA B152N 12X1

Código: **33736** Fábrica: **REBOUCAS** Unidade: **PT/12**  
F1 F4



BISNAGA PLAST 200 ML KATCHUP 394

Código: **36229** Fábrica: **TRITEC** Unidade: **UN/1**  
F1 F4

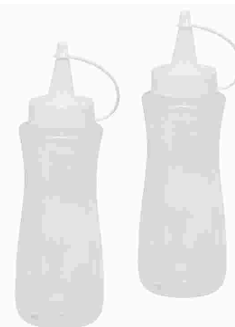

BISNAGA PLAST 200 ML MAIONESE 396

Código: **35945** Fábrica: **TRITEC** Unidade: **UN/1**  
F1 F4



BISNAGA PLAST 200 ML MOSTARDA 395

Código: **36230** Fábrica: **TRITEC** Unidade: **UN/1**  
F1 F4



BISNAGA PLAST 250 ML KATCHUP 106/422

Código: **44080** Fábrica: **QUALYPLAS** Unidade: **UN/1**  
F1 F4



BISNAGA PLAST 250 ML MAIONESE 421/105

Código: **44079** Fábrica: **QUALYPLAS** Unidade: **UN/1**  
F1 F4



BISNAGA PLAST 250 ML MOSTARDA 104/420

Código: **44081** Fábrica: **QUALYPLAS** Unidade: **UN/1**  
F1 F4



BOLEIRA PLAST 26,5X25X10,5CM FACILIT 450  
 Código: 45189 Fábrica: RISCHIOTO Unidade: UN/1  
 F1 F4



BOLSA TERMICA POLIESTER 24X22X14CM 0066  
 Código: 43685 Fábrica: MORMAII Unidade: UN/1  
 F1 F4



BOLSA TERMICA POLIESTER 24X22X14CM 0069  
 Código: 43680 Fábrica: MORMAII Unidade: UN/1  
 F1 F4



BOLSA TERMICA RET 9 LTS  
 Código: 30864 Fábrica: ANTARES Unidade: UN/1  
 F1 F4



BOLSA TERMICA RET 12 LTS TIRA COLO  
 Código: 30868 Fábrica: ANTARES Unidade: UN/1  
 F1 F4



BOLSA TERMICA RET 15 LTS  
 Código: 30865 Fábrica: ANTARES Unidade: UN/1  
 F1 F4



BOMBA MANUAL P/GALAO DE AGUA 16,5CM 861  
 Código: 26874 Fábrica: HAI BRASIL Unidade: UN/1  
 F1 F4



BOMBONIERE PLAST 10X11CM 15082  
 Código: 46247 Fábrica: CASITA Unidade: CX/1  
 F1 F4



BOMBONIERE VIDRO GDE 750  
 Código: 47361 Fábrica: ALTIHOME Unidade: UN/1  
 F1 F4



BOMBONIERE VIDRO 290ML RED 13CM EGITO  
 Código: 44781 Fábrica: CITY GLASS Unidade: CX/1  
 F1 F4



BORDA P/PRATELEIRA 1M X 6CM 2 2X1 1102  
 Código: 11328 Fábrica: PLAST-LEO Unidade: C//2  
 F1 F4

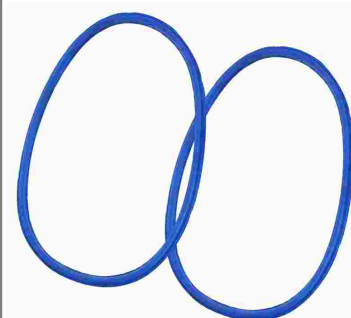

BORRACHA P PRESSAO SILIC 4,5 LTS 12X1  
 Código: 28808 Fábrica: ALPHA Unidade: DZ/12  
 F1 F4

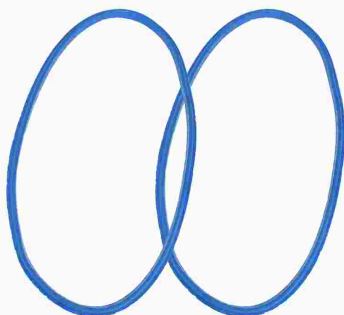

BORRACHA P PRESSAO SILIC 7,0 LTS 12X1  
 Código: 29925 Fábrica: ALPHA Unidade: DZ/12  
 F1 F4

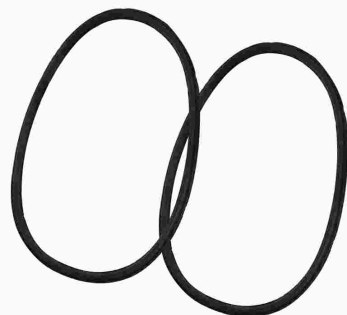

BORRACHA P PRESSAO 4,5 LTS PRETA 12X1  
 Código: 37725 Fábrica: ALPHA Unidade: DZ/12  
 F1 F4

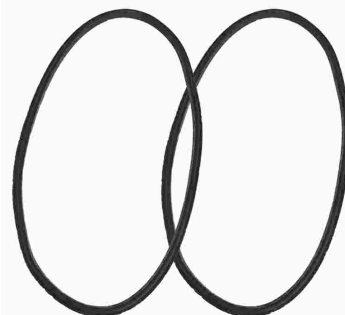

BORRACHA P PRESSAO 7,0 LTS PRETA 12X1  
 Código: 37783 Fábrica: ALPHA Unidade: DZ/12  
 F1 F4

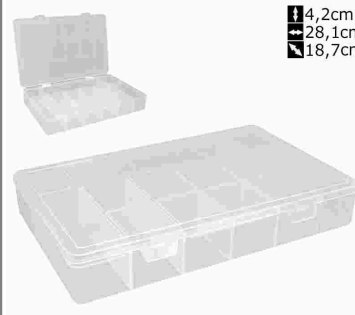

BOX ORGANIZADOR PLAST G C/13 DIV 490  
 Código: 44432 Fábrica: USUAL Unidade: UN/1  
 F1 F4

4,2cm  
 28,1cm  
 18,7cm

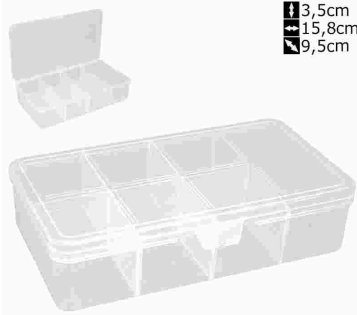

 3,5cm  
 15,8cm  
 9,5cm

BOX ORGANIZADOR PLAST P C/7 DIV 488

Código: 44431  
 Fábrica: USUAL  
 Unidade: UN/1  
 F1 F4



 14,5 cm  
 37 cm

BOX PRATIC RATTAN TENDENCIAS GDE 2010

Código: 38375  
 Fábrica: MONTE LIBANO  
 Unidade: UN/1  
 F1 F4



 13 cm  
 29,5 cm

BOX PRATIC RATTAN TENDENCIAS MED 2005

Código: 38374  
 Fábrica: MONTE LIBANO  
 Unidade: UN/1  
 F1 F4



 12 cm  
 24 cm

BOX PRATIC RATTAN TENDENCIAS PEQ 2000

Código: 38373  
 Fábrica: MONTE LIBANO  
 Unidade: UN/1  
 F1 F4



BULE ALUM CB BAQUELITE 02 654

Código: 35270  
 Fábrica: MSR  
 Unidade: UN/1  
 F1 F4



BULE ALUM CRAQUEADO CB BAQUELITE 655

Código: 35262  
 Fábrica: MSR  
 Unidade: UN/1  
 F1 F4

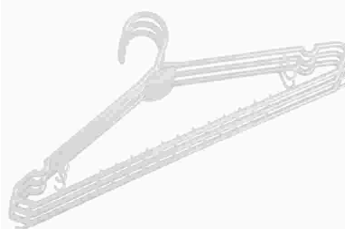

CABIDE ACRIL AD BRANCO 003 3X1

Código: 45751  
 Fábrica: DCASA  
 Unidade: CJ/3  
 F1 F4

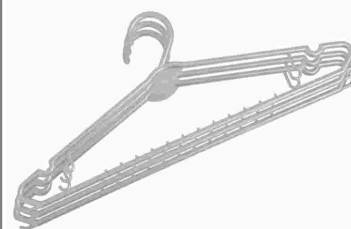

CABIDE ACRIL AD CINZA 002 3X1

Código: 45762  
 Fábrica: DCASA  
 Unidade: CJ/3  
 F1 F4



CABIDE ACRIL AD COBRE 008 3X1

Código: 45753  
 Fábrica: DCASA  
 Unidade: CJ/3  
 F1 F4

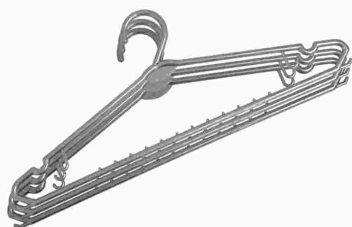

CABIDE ACRIL AD PLATINA 009 3X1

Código: 45752  
 Fábrica: DCASA  
 Unidade: CJ/3  
 F1 F4



CABIDE ACRIL AD VINTAGE BRANCO 102 3X1

Código: 45754  
 Fábrica: DCASA  
 Unidade: CJ/3  
 F1 F4



CABIDE ACRIL AD VINTAGE CINZA 110 3X1

Código: 45759  
 Fábrica: DCASA  
 Unidade: CJ/3  
 F1 F4

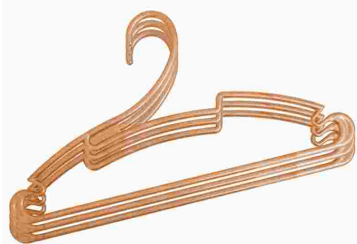

CABIDE ACRIL AD VINTAGE COBRE 103 3X1

Código: 45756  
 Fábrica: DCASA  
 Unidade: CJ/3  
 F1 F4

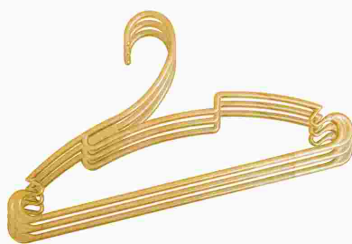

CABIDE ACRIL AD VINTAGE OURO 105 3X1

Código: 45758  
 Fábrica: DCASA  
 Unidade: CJ/3  
 F1 F4

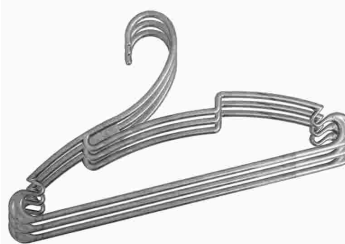

CABIDE ACRIL AD VINTAGE PLATINA 104 3X1

Código: 45757  
 Fábrica: DCASA  
 Unidade: CJ/3  
 F1 F4

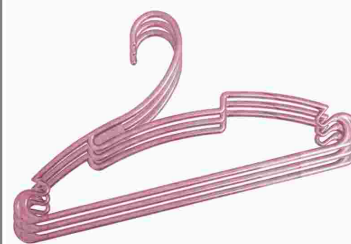

CABIDE ACRIL AD VINTAGE ROSE GOLD 112 3X1

Código: 45760  
 Fábrica: DCASA  
 Unidade: CJ/3  
 F1 F4



CABIDE ACRIL INF AZUL 200 3X1

Código: 45749 Fábrica: DCASA Unidade: CJ/3 F1 F4



CABIDE ACRIL INF BRANCO 400 3X1

Código: 45748 Fábrica: DCASA Unidade: CJ/3 F1 F4

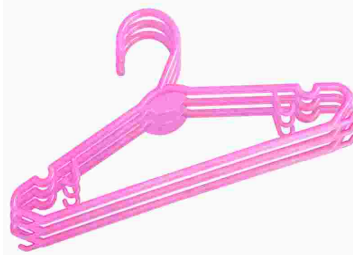

CABIDE ACRIL INF ROSA 100 3X1

Código: 45750 Fábrica: DCASA Unidade: CJ/3 F1 F4



CABIDE CROM POPULAR 792 12X1

Código: 7502 Fábrica: ARAMINAS Unidade: DZ/12 F1 F4



17 cm

CABIDE GALINHA C/1 GANCHO 5055

Código: 39230 Fábrica: PAIOL Unidade: UN/1 F1 F4



CABIDE PLAST AD PRETO 400 3X1

Código: 40952 Fábrica: P A SOUZA Unidade: CJ/3 F1 F4



CABIDE PLAST AD PRETO 401 6X1

Código: 40953 Fábrica: P A SOUZA Unidade: CJ/6 F1 F4



CABIDE PLAST AD PRETO 402 12X1

Código: 40954 Fábrica: P A SOUZA Unidade: CJ/12 F1 F4

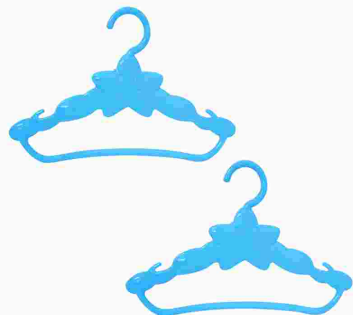

CABIDE PLAST BABY ESTRELA AZUL 3807 2X1

Código: 35489 Fábrica: TRITEC Unidade: CJ/2 F1 F4



CABIDE PLAST BABY ESTRELA ROSA 3808 2X1

Código: 35488 Fábrica: TRITEC Unidade: CJ/2 F1 F4



CABIDE PLAST PRETO 001 3X1

Código: 41490 Fábrica: KOZI PLAST Unidade: CJ/3 F1 F4



CABO MADEIRA PLAST 1,20 MTS C/ ROSCA

Código: 49869 Fábrica: HALLEY Unidade: UN/1 F1 F4



CABO MADEIRA 1,20 MTS C/ ROSCA

Código: 49896 Fábrica: HALLEY Unidade: UN/1 F1 F4



CACAROLA ALUM HOTEL 30 10LTS

Código: 50778 Fábrica: ASJ Unidade: UN/1 F1 F4



CACAROLA ALUM HOTEL 32 12LTS

Código: 50777 Fábrica: ASJ Unidade: UN/1 F1 F4



CACAROLA ALUM HOTEL 36 17LTS

Código: 50716 Fábrica: ASJ Unidade: UN/1 F1 F4



CACAROLA ALUM LEVE 14 C/TAMPA 1,0 LT  
 Código: 14755 Fábrica: AVELAR Unidade: UN/1  
 F1 F4



CACAROLA ALUM LEVE 16 C/TAMPA 1,3 LTS  
 Código: 14756 Fábrica: AVELAR Unidade: UN/1  
 F1 F4



CACHEPOT ALUM CANELADO SEM ALCA PEQ 206  
 Código: 39548 Fábrica: BMC ALUMINIO Unidade: UN/1  
 F1 F4



CACHEPOT ATHENAS JARDINEIRA 26 ENVELHECI  
 Código: 32759 Fábrica: NUTRIPLAN Unidade: UN/1  
 F1 F4



CACHEPOT ELEGANCE CONICO CYBIDIUM BRANCO  
 Código: 39645 Fábrica: NUTRIPLAN Unidade: UN/1  
 F1 F4



CACHEPOT ELEGANCE CONICO CYBIDIUM CAFE I  
 Código: 38910 Fábrica: NUTRIPLAN Unidade: UN/1  
 F1 F4



CACHEPOT ELEGANCE CONICO CYBIDIUM TRAVER  
 Código: 39646 Fábrica: NUTRIPLAN Unidade: UN/1  
 F1 F4



CACHEPOT ELEGANCE JARDINEIRA 01 BRANC 3L  
 Código: 32763 Fábrica: NUTRIPLAN Unidade: UN/1  
 F1 F4



CACHEPOT ELEGANCE JARDINEIRA 01 CAFE 3L  
 Código: 32760 Fábrica: NUTRIPLAN Unidade: UN/1  
 F1 F4



CACHEPOT ELEGANCE JARDINEIRA 01 PRETO 3L  
 Código: 32764 Fábrica: NUTRIPLAN Unidade: UN/1  
 F1 F4



CACHEPOT ELEGANCE JARDINEIRA 01 TRAVE 3L  
 Código: 32762 Fábrica: NUTRIPLAN Unidade: UN/1  
 F1 F4



CACHEPOT ELEGANCE PAREDE MINI PRETO 1,5L  
 Código: 33083 Fábrica: NUTRIPLAN Unidade: UN/1  
 F1 F4

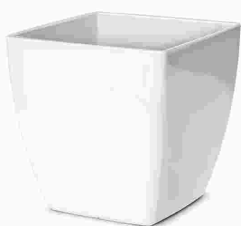

CACHEPOT ELEGANCE QUAD 01 BRANCO 950ML  
 Código: 48426 Fábrica: NUTRIPLAN Unidade: UN/1  
 F1 F4



CACHEPOT ELEGANCE QUAD 01 CAFE IMP 950ML  
 Código: 48427 Fábrica: NUTRIPLAN Unidade: UN/1  
 F1 F4



CACHEPOT ELEGANCE QUAD 01 TRAVERTI 950ML  
 Código: 32768 Fábrica: NUTRIPLAN Unidade: UN/1  
 F1 F4

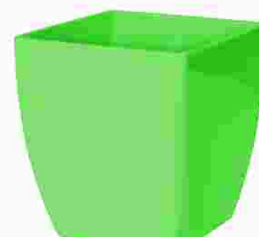

CACHEPOT ELEGANCE QUAD 02 VERDE LIM 1,7L  
 Código: 33087 Fábrica: NUTRIPLAN Unidade: UN/1  
 F1 F4



13 cm  
13 cm  
2,4 lts

CACHEPOT ELEGANCE QUAD 03 AZUL BB 2,4LTS

Código: 36791 Fábrica: NUTRIPLAN Unidade: UN/1 F1 F4



14,9 cm  
15,2 cm  
2,4 lts

CACHEPOT ELEGANCE QUAD 03 BRANCO 2,4LTS

Código: 32766 Fábrica: NUTRIPLAN Unidade: UN/1 F1 F4



14,9 cm  
15,2 cm  
2,4 lts

CACHEPOT ELEGANCE QUAD 03 CAFE IMPE 2,4L

Código: 32765 Fábrica: NUTRIPLAN Unidade: UN/1 F1 F4



13 cm  
13 cm  
2,4 lts

CACHEPOT ELEGANCE QUAD 03 ROSE 2,4LTS

Código: 36792 Fábrica: NUTRIPLAN Unidade: UN/1 F1 F4



14 cm  
15 cm  
1,7 lts

CACHEPOT ELEGANCE QUAD 03 TRAVERTIN 2,4L

Código: 33908 Fábrica: NUTRIPLAN Unidade: UN/1 F1 F4

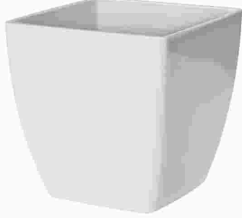

16 cm  
16 cm  
3 lts

CACHEPOT ELEGANCE QUAD 04 BRANCO 3LTS

Código: 38673 Fábrica: NUTRIPLAN Unidade: UN/1 F1 F4



16,6 cm  
16,1 cm  
3,0 lts

CACHEPOT ELEGANCE QUAD 04 CAFE IMPE 3LTS

Código: 33550 Fábrica: NUTRIPLAN Unidade: UN/1 F1 F4



5,5 cm

CACHEPOT ELEGANCE RED MINI AZUL BB 12X1

Código: 35719 Fábrica: NUTRIPLAN Unidade: PT/12 F1 F4



5,5 cm

CACHEPOT ELEGANCE RED MINI PRETO ON 12X1

Código: 35722 Fábrica: NUTRIPLAN Unidade: PT/12 F1 F4



5,5 cm

CACHEPOT ELEGANCE RED MINI ROSE 12X1

Código: 35723 Fábrica: NUTRIPLAN Unidade: PT/12 F1 F4



5,5 cm

CACHEPOT ELEGANCE RED MINI VINHO 12X1

Código: 35725 Fábrica: NUTRIPLAN Unidade: PT/12 F1 F4



5 cm  
6,5 cm  
350 ml

CACHEPOT ELEGANCE RED 00 BRAN 350ML 12X1

Código: 38907 Fábrica: NUTRIPLAN Unidade: PT/12 F1 F4



5 cm  
6,5 cm  
350 ml

CACHEPOT ELEGANCE RED 00 CAFE 350ML 12X1

Código: 38908 Fábrica: NUTRIPLAN Unidade: UN/1 F1 F4



5 cm  
6,5 cm  
350 ml

CACHEPOT ELEGANCE RED 00 DOUR 350ML 12X1

Código: 38906 Fábrica: NUTRIPLAN Unidade: PT/12 F1 F4



5 cm  
6,5 cm  
350 ml

CACHEPOT ELEGANCE RED 00 PRET 350ML 12X1

Código: 38909 Fábrica: NUTRIPLAN Unidade: PT/12 F1 F4



5 cm  
6,5 cm  
350 ml

CACHEPOT ELEGANCE RED 00 TRAV 350ML 12X1

Código: 38905 Fábrica: NUTRIPLAN Unidade: PT/12 F1 F4



 5 cm  
 6,5 cm  
 350 ml

CACHEPOT ELEGANCE RED 00 VINH 350ML 12X1  
 Código: 38911 Fábrica: NUTRIPLAN Unidade: PT/12 F1 F4



 8,7 cm  
 11,4 cm  
 0,6 lts

CACHEPOT ELEGANCE RED 01 AMARELO 600ML  
 Código: 32732 Fábrica: NUTRIPLAN Unidade: UN/1 F1 F4



 8 cm  
 11 cm  
 0,6 lts

CACHEPOT ELEGANCE RED 01 PRETO 600ML  
 Código: 33082 Fábrica: NUTRIPLAN Unidade: UN/1 F1 F4



 10,9 cm  
 13,6 cm  
 1,0 lts

CACHEPOT ELEGANCE RED 03 BRANCO 1,5LT  
 Código: 37750 Fábrica: NUTRIPLAN Unidade: UN/1 F1 F4



 12 cm  
 15 cm  
 1,5 lts

CACHEPOT ELEGANCE RED 03 CAFE IMPER 1,5L  
 Código: 33080 Fábrica: NUTRIPLAN Unidade: UN/1 F1 F4



 12 cm  
 15,4 cm  
 1,5 lts

CACHEPOT ELEGANCE RED 03 TRAVERTIN 1,5LT  
 Código: 32726 Fábrica: NUTRIPLAN Unidade: UN/1 F1 F4



 23,2 cm  
 25,4 cm  
 8,5 lts

CACHEPOT ELEGANCE RED 04 CAFE IMPER 8,5L  
 Código: 32728 Fábrica: NUTRIPLAN Unidade: UN/1 F1 F4



 26,7 cm  
 27,6 cm  
 12 lts

CACHEPOT ELEGANCE RED 05 VERDE LIM 12LTS  
 Código: 32729 Fábrica: NUTRIPLAN Unidade: UN/1 F1 F4



 15,3 cm  
 15,4 cm  
 2,0 lts

CACHEPOT ELEGANCE RED 3,5 PRETO ONIX 2LT  
 Código: 32727 Fábrica: NUTRIPLAN Unidade: UN/1 F1 F4



 26 cm  
 4 cm  
 4 lts

CACHEPOT ELEGANCE TRAPEZIO 01 AZUL BB 4LT  
 Código: 36793 Fábrica: NUTRIPLAN Unidade: UN/1 F1 F4



 26 cm  
 4 cm  
 4 lts

CACHEPOT ELEGANCE TRAPEZIO 01 ROSE 4LT  
 Código: 36794 Fábrica: NUTRIPLAN Unidade: UN/1 F1 F4



 26 cm  
 14 cm  
 4 lts

CACHEPOT ELEGANCE TRAPEZIO 01 BRANCO 4LT  
 Código: 35718 Fábrica: NUTRIPLAN Unidade: UN/1 F1 F4



 26 cm  
 14 cm  
 4 lts

CACHEPOT ELEGANCE TRAPEZIO 01 TRAVER 4LT  
 Código: 35460 Fábrica: NUTRIPLAN Unidade: UN/1 F1 F4



 26 cm  
 14 cm  
 4 lts

CACHEPOT ELEGANCE TRAPEZIO 01 VINHO 4LTS  
 Código: 35717 Fábrica: NUTRIPLAN Unidade: UN/1 F1 F4



 23 cm  
 32 cm  
 2,4 L

CACHEPOT PLAST PAREDE PRETO 2,4LTS  
 Código: 41655 Fábrica: INPLAST Unidade: UN/1 F1 F4



 23 cm  
 32 cm  
 2,4 L

CACHEPOT PLAST PAREDE TERRACOTA 2,4LTS  
 Código: 41656 Fábrica: INPLAST Unidade: UN/1 F1 F4



11 cm  
14 cm

CACHEPOT PLAST 11X14CM 1100

Código: 37805  
Fábrica: ENGIPLAST  
Unidade: UN/1  
F1 F4



CACHEPOT PLAST 220ML 6404 4X1

Código: 41492  
Fábrica: KOZI PLAST  
Unidade: CJ/4  
F1 F4



CACHEPOT QUADRADO CONICO 7CM 210

Código: 30832  
Fábrica: P A SOUZA  
Unidade: UN/1  
F1 F4



CACHEPOT QUADRADO CONICO 9CM 211

Código: 30831  
Fábrica: P A SOUZA  
Unidade: UN/1  
F1 F4



CACHEPOT QUADRADO CONICO 11CM 212

Código: 29220  
Fábrica: P A SOUZA  
Unidade: UN/1  
F1 F4



CACHEPOT QUADRADO CONICO 13CM 213

Código: 29221  
Fábrica: P A SOUZA  
Unidade: UN/1  
F1 F4



CACHEPOT QUADRADO CONICO 15CM 214

Código: 29222  
Fábrica: P A SOUZA  
Unidade: UN/1  
F1 F4



CACHEPOT QUADRADO RETO 7CM 215

Código: 30825  
Fábrica: P A SOUZA  
Unidade: UN/1  
F1 F4



CACHEPOT QUADRADO RETO 9CM 216

Código: 30824  
Fábrica: P A SOUZA  
Unidade: UN/1  
F1 F4



CACHEPOT QUADRADO RETO 11CM 217

Código: 30823  
Fábrica: P A SOUZA  
Unidade: UN/1  
F1 F4



CACHEPOT QUADRADO RETO 13CM 218

Código: 30822  
Fábrica: P A SOUZA  
Unidade: UN/1  
F1 F4

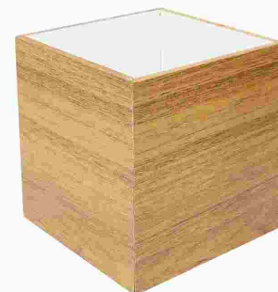

CACHEPOT QUADRADO RETO 15CM 219

Código: 30821  
Fábrica: P A SOUZA  
Unidade: UN/1  
F1 F4



CACHEPOT SEXTAVADO CONICO 7CM 200

Código: 30830  
Fábrica: P A SOUZA  
Unidade: UN/1  
F1 F4



CACHEPOT SEXTAVADO CONICO 9CM 201

Código: 30829  
Fábrica: P A SOUZA  
Unidade: UN/1  
F1 F4

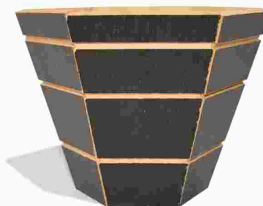

CACHEPOT SEXTAVADO CONICO 11CM 202

Código: 30828  
Fábrica: P A SOUZA  
Unidade: UN/1  
F1 F4



CACHEPOT SEXTAVADO CONICO 13CM 203

Código: 30827  
Fábrica: P A SOUZA  
Unidade: UN/1  
F1 F4

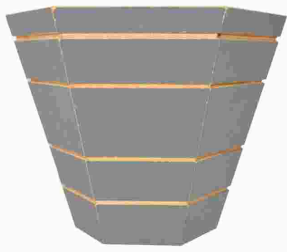

CACHEPOT SEXTAVADO CONICO 15CM 204

Código: 30826  
 Fábrica: P A SOUZA  
 Unidade: UN/1  
 F1 F4

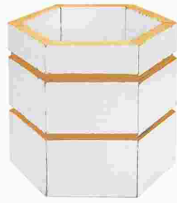

CACHEPOT SEXTAVADO RETO 7CM 205

Código: 30837  
 Fábrica: P A SOUZA  
 Unidade: UN/1  
 F1 F4



CACHEPOT SEXTAVADO RETO 9CM 206

Código: 30836  
 Fábrica: P A SOUZA  
 Unidade: UN/1  
 F1 F4



CACHEPOT SEXTAVADO RETO 11CM 207

Código: 30835  
 Fábrica: P A SOUZA  
 Unidade: UN/1  
 F1 F4

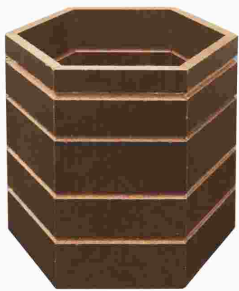

CACHEPOT SEXTAVADO RETO 13CM 208

Código: 30834  
 Fábrica: P A SOUZA  
 Unidade: UN/1  
 F1 F4



CACHEPOT SEXTAVADO RETO 15CM 209

Código: 30833  
 Fábrica: P A SOUZA  
 Unidade: UN/1  
 F1 F4



CADEIRA BISTRO PONTE NOVA BRANCA

Código: 21168  
 Fábrica: ANTARES  
 Unidade: UN/1  
 F1 F4



CADEIRA BISTRO PONTE NOVA PRETA

Código: 40038  
 Fábrica: ANTARES  
 Unidade: UN/1  
 F1 F4



88,5cm  
 38cm

CADEIRA COLONIAL PLAST DESMONTAVEL

Código: 22151  
 Fábrica: ANTARES  
 Unidade: UN/1  
 F1 F4



CADEIRA POLTRONA BOA VISTA BRANCA

Código: 21165  
 Fábrica: ANTARES  
 Unidade: UN/1  
 F1 F4



CAFETEIRA ALUM LEVE 1,2 LTS

Código: 5905  
 Fábrica: AVELAR  
 Unidade: UN/1  
 F1 F4



CAFETEIRA ALUM PADRAO 657

Código: 37512  
 Fábrica: MSR  
 Unidade: UN/1  
 F1 F4



CAIXA DE FRUTA GDE ENVELHECIDO 1461-1

Código: 41754  
 Fábrica: PAIOL  
 Unidade: UN/1  
 F1 F4



26 cm  
 48 cm

CAIXA DE FRUTA GDE PINTADO 1461

Código: 37178  
 Fábrica: PAIOL  
 Unidade: UN/1  
 F1 F4



19,5 cm  
 37 cm

CAIXA DE FRUTA MED ASSADO 1562

Código: 37175  
 Fábrica: PAIOL  
 Unidade: UN/1  
 F1 F4



19,5 cm  
 37 cm

CAIXA DE FRUTA MED PINT/ENVELH 1462

Código: 37179  
 Fábrica: PAIOL  
 Unidade: UN/1  
 F1 F4

16 cm  
30 cm



CAIXA DE FRUTA PEQ ASSADO 8005

Código: 37176 Fábrica: PAIOL Unidade: UN/1  
F1 F4

16 cm  
30 cm



CAIXA DE FRUTA PEQ PINT/ENVELH 1463

Código: 37180 Fábrica: PAIOL Unidade: UN/1  
F1 F4

12 cm  
23 cm



CAIXA DE FRUTA PP ENVELHECIDO 1453-1

Código: 37177 Fábrica: PAIOL Unidade: UN/1  
F1 F4

12 cm  
23 cm



CAIXA DE FRUTA PP PINTADO 1453-2

Código: 37181 Fábrica: PAIOL Unidade: UN/1  
F1 F4

17 cm  
35 cm



CAIXA DE FRUTA 2 CRISANTEMOS ENVE 2514-2

Código: 37183 Fábrica: PAIOL Unidade: UN/1  
F1 F4



CAIXA DE FRUTA 2 CRISANTEMOS PINT 2514-1

Código: 40842 Fábrica: PAIOL Unidade: UN/1  
F1 F4

9 cm  
25 cm

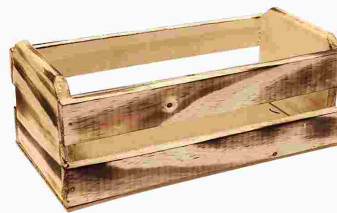

CAIXA DE FRUTA 2 VIOLETAS 2515

Código: 37182 Fábrica: PAIOL Unidade: UN/1  
F1 F4

8cm  
15cm  
8cm

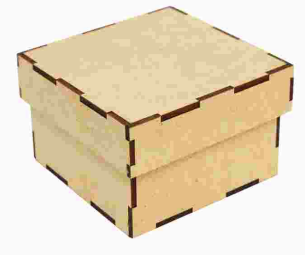

CAIXA MDF 5X5X5CM

Código: 51073 Fábrica: FEITOMAO Unidade: UN/1  
F1 F4

8cm  
5cm  
8cm



CAIXA MDF 8X8X5CM

Código: 47264 Fábrica: FEITOMAO Unidade: UN/1  
F1 F4

9cm  
5cm  
9cm



CAIXA MDF 9X9X5CM

Código: 47265 Fábrica: FEITOMAO Unidade: UN/1  
F1 F4

10cm  
5cm  
10cm

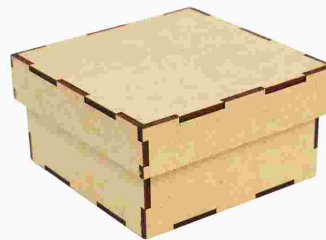

CAIXA MDF 10X10X5CM

Código: 47266 Fábrica: FEITOMAO Unidade: UN/1  
F1 F4

12cm  
12cm  
15cm



CAIXA MDF 12X12X5CM

Código: 47268 Fábrica: FEITOMAO Unidade: UN/1  
F1 F4

15cm  
5cm  
15cm

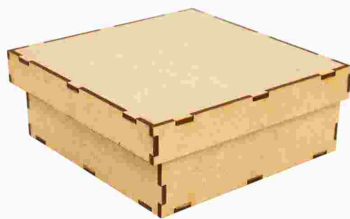

CAIXA MDF 15X15X5CM

Código: 47269 Fábrica: FEITOMAO Unidade: UN/1  
F1 F4

20cm  
20cm  
15cm



CAIXA MDF 20X20X5CM

Código: 50758 Fábrica: FEITOMAO Unidade: UN/1  
F1 F4



CAIXA MINI KIT 3 PCS ENVELHECIDO 8788-5

Código: 41056 Fábrica: PAIOL Unidade: CJ/1  
F1 F4



CAIXA MINI 1 ENVELHECIDO 8022-2

Código: 41751 Fábrica: PAIOL Unidade: UN/1  
F1 F4



7 cm  
 15 cm

CAIXA MINI 2 ENVELHECIDO 6664-2

Código: **37186** Fábrica: **PAIOL** Unidade: **UN/1**  
**F1 F4**



7 cm  
 13 cm

CAIXA MINI 2 PINTADO 6664-1

Código: **41752** Fábrica: **PAIOL** Unidade: **UN/1**  
**F1 F4**



CAIXA MULTI USO 11 LTS RET C/TPA 6649

Código: **24474** Fábrica: **INPLAST** Unidade: **UN/1**  
**F1 F4**



16 cm  
 37 cm  
 52 cm  
 21 lts

CAIXA ORG GDE BAIXA 21LTS C/TRAVA 1121

Código: **33035** Fábrica: **TRITEC** Unidade: **UN/1**  
**F1 F4**



35cm  
 38cm  
 27lts

CAIXA ORG MED ALTA 27LT C/TRAVA 1120

Código: **44256** Fábrica: **TRITEC** Unidade: **UN/1**  
**F1 F4**



19 cm  
 27 cm  
 3,5 lts

CAIXA ORG MINI MANDALA 3,5L MARROM 1892

Código: **37296** Fábrica: **MONTE LIBANO** Unidade: **UN/1**  
**F1 F4**



19 cm  
 27 cm  
 3,5 lts

CAIXA ORG MINI MANDALA 3,5L PRETA 1891

Código: **37295** Fábrica: **MONTE LIBANO** Unidade: **UN/1**  
**F1 F4**



CAIXA ORG MINI PORTA TUDO C/2GAV 1217

Código: **37293** Fábrica: **MONTE LIBANO** Unidade: **UN/1**  
**F1 F4**



22 cm

CAIXA ORG PEQ PORTA TUDO C/3GAV 1170

Código: **43655** Fábrica: **MONTE LIBANO** Unidade: **UN/1**  
**F1 F4**



31cm  
 13cm  
 22cm

CAIXA ORG PLAST RET C/TRAVA 5LTS 6845

Código: **41659** Fábrica: **INPLAST** Unidade: **UN/1**  
**F1 F4**



CAIXA ORG PLAST RET TRANSP 2,5 LTS 6882

Código: **41657** Fábrica: **INPLAST** Unidade: **UN/1**  
**F1 F4**



CAIXA ORG PLAST RET TRANSP 3,7 LTS 6886

Código: **41658** Fábrica: **INPLAST** Unidade: **UN/1**  
**F1 F4**



CAIXA ORG RATTAN 10 LTS PRETO 951895

Código: **41189** Fábrica: **PLASTSU** Unidade: **UN/1**  
**F1 F4**



19 cm  
 28 cm  
 38 cm  
 15 lts.

CAIXA ORG RATTAN 15LTS 1820

Código: **32667** Fábrica: **GIOTTO** Unidade: **UN/1**  
**F1 F4**



18 cm  
 40 cm  
 28 cm  
 15 lts

CAIXA ORG RATTAN 16 LTS PRETO 214PT

Código: **35958** Fábrica: **GIOTTO** Unidade: **UN/1**  
**F1 F4**



28 cm  
 38 cm  
 15 lts

CAIXA ORG RATTAN 18LTS 38X28CM BRAN 1900

Código: **37289** Fábrica: **MONTE LIBANO** Unidade: **UN/1**  
**F1 F4**



38cm  
28cm  
18lts

CAIXA ORG RATTAN 18LTS 38X28CM MARR 1902  
Código: **37290** Fábrica: **MONTE LIBANO** Unidade: **UN/1**  
F1 F4



38cm  
28cm  
18lts

CAIXA ORG RATTAN 18LTS 38X28CM PRET 1906  
Código: **37288** Fábrica: **MONTE LIBANO** Unidade: **UN/1**  
F1 F4



20cm  
23cm

CAIXA ORG 10LTS ALTA PRETO C/TRAVA 138  
Código: **47726** Fábrica: **FORMPLAST** Unidade: **UN/1**  
F1 F4



15cm  
45cm

CAIXA ORG 12LTS BAIXA PRETO C/TRAVA 8003  
Código: **40358** Fábrica: **FORMPLAST** Unidade: **UN/1**  
F1 F4



CAIXA ORG 18LTS BAIXA PRETO C/TRAVA 134  
Código: **47727** Fábrica: **FORMPLAST** Unidade: **UN/1**  
F1 F4



32cm  
45cm

CAIXA ORG 30LTS ALTA PRETO C/TRAVA 132  
Código: **40355** Fábrica: **FORMPLAST** Unidade: **UN/1**  
F1 F4



25cm  
60cm

CAIXA ORG 34LTS REFOR PRETO C/TRAVA 128  
Código: **47729** Fábrica: **FORMPLAST** Unidade: **UN/1**  
F1 F4



35cm  
60cm

CAIXA ORG 50 LTS REFOR PRETO C/TRAVA 126  
Código: **47730** Fábrica: **FORMPLAST** Unidade: **UN/1**  
F1 F4



12cm  
32cm

CAIXA ORG 5,5LTS BAIXA PRETO C/TRAV 3093  
Código: **47731** Fábrica: **FORMPLAST** Unidade: **UN/1**  
F1 F4



CAIXA ORGANI 20LTS PTO ALTA C/TRAVA 6123  
Código: **50202** Fábrica: **RISCHIOTO** Unidade: **UN/1**  
F1 F4

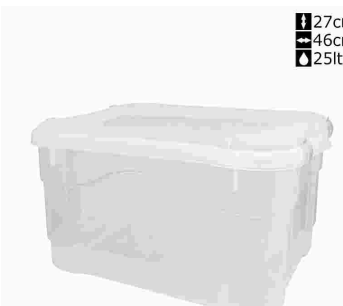

27cm  
46cm  
25lts

CAIXA ORGANIZADORA 25L TRAVA 0668T  
Código: **19692** Fábrica: **JAGUAR** Unidade: **UN/1**  
F1 F4



20cm  
66cm  
38lts

CAIXA ORGANIZADORA 38L TRAVA RODIN 2014T  
Código: **47093** Fábrica: **JAGUAR** Unidade: **UN/1**  
F1 F4

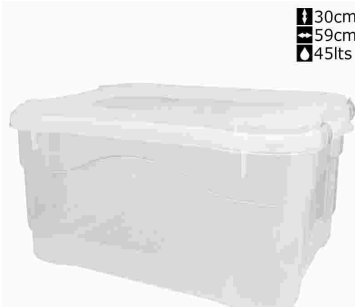

30cm  
59cm  
45lts

CAIXA ORGANIZADORA 45L TRAVA 0621T  
Código: **13169** Fábrica: **JAGUAR** Unidade: **UN/1**  
F1 F4



CAIXA ORGANIZATTA 1,6LTS C/TRAVA 118  
Código: **45192** Fábrica: **RISCHIOTO** Unidade: **UN/1**  
F1 F4



CAIXA ORGANIZATTA 3,2LTS C/TRAVA 119  
Código: **45195** Fábrica: **RISCHIOTO** Unidade: **UN/1**  
F1 F4

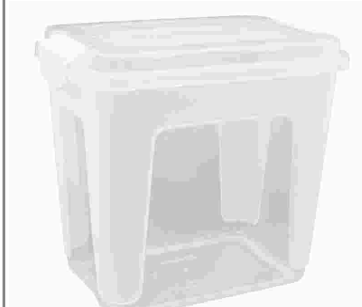

CAIXA ORGANIZATTA 5LTS C/TRAVA 127  
Código: **45197** Fábrica: **RISCHIOTO** Unidade: **UN/1**  
F1 F4



CAIXA ORGANIZATTA 6LTS C/TRAVA 122  
 Código: 45199 Fábrica: RISCHIOTO Unidade: UN/1  
 F1 F4



CAIXA ORGANIZATTA 10LTS C/TRAVA 121  
 Código: 45194 Fábrica: RISCHI/UNIN Unidade: UN/1  
 F1 F4

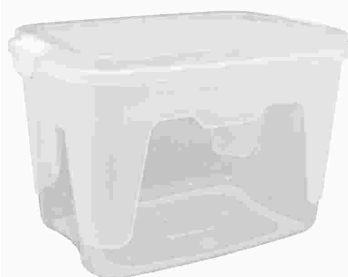

CAIXA ORGANIZATTA 12LTS C/TRAVA 124  
 Código: 45193 Fábrica: RISCHIOTO Unidade: UN/1  
 F1 F4



CAIXA ORGANIZATTA 20LTS ALTA C/TRAVA 123  
 Código: 45200 Fábrica: RISCHIOTO Unidade: UN/1  
 F1 F4

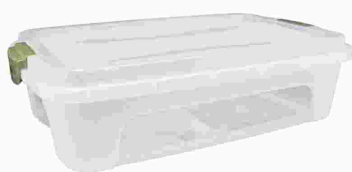

CAIXA ORGANIZATTA 20LTS C/TRAVA BAIXA 115  
 Código: 45202 Fábrica: RISCHIOTO Unidade: UN/1  
 F1 F4



CAIXA ORGANIZATTA 30LTS C/TRAVA ALTA 129  
 Código: 45201 Fábrica: RISCHI/UNIN Unidade: UN/1  
 F1 F4



CAIXA ORGANIZATTA 30LTS C/TRAVA 116  
 Código: 45212 Fábrica: RISCHIOTO Unidade: UN/1  
 F1 F4



CAIXA ORGANIZATTA 50LTS C/TRAVA ALTA 117  
 Código: 36976 Fábrica: RISCHIOTO Unidade: UN/1  
 F1 F4

138 cm  
 44 cm



CAIXA ORGANIZATTA 56LTS C/TRAVA ALTA 364  
 Código: 50823 Fábrica: UNINJET Unidade: UN/1  
 F1 F4

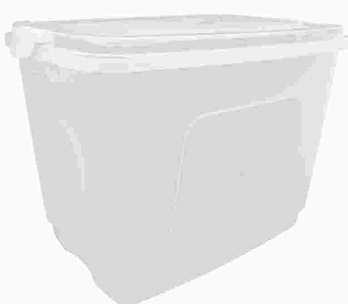

CAIXA ORGANIZATTA 80LTS C/TRAVA 128  
 Código: 45198 Fábrica: RISCHIOTO Unidade: UN/1  
 F1 F4



CAIXA P/CARNE 19 LTS MULTIUSO 25X41X59CM  
 Código: 18386 Fábrica: ANTARES Unidade: UN/1  
 F1 F4



CAIXA PLAST ORG 3LTS C/TRAVA TRANSL 417  
 Código: 44422 Fábrica: USUAL Unidade: UN/1  
 F1 F4

111cm  
 26cm  
 3lts



CAIXA PLAST ORG 5LTS C/TRAVA TRANSL 414  
 Código: 44421 Fábrica: USUAL Unidade: UN/1  
 F1 F4

14cm  
 30cm  
 5lts

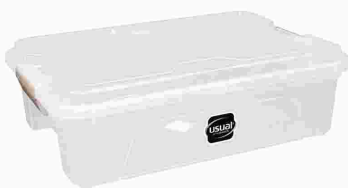

CAIXA PLAST ORG 10LTS C/TRAVA TRANSL 366  
 Código: 44420 Fábrica: USUAL Unidade: UN/1  
 F1 F4

13cm  
 42cm  
 10lts

















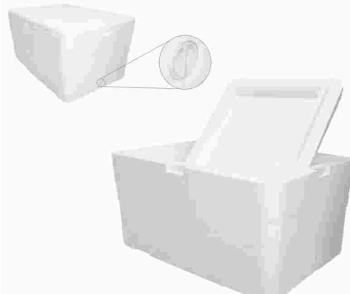

CAIXA PLAST ORG 20LTS C/TRAVA TRANSL 388  
 Código: 44419 Fábrica: USUAL Unidade: UN/1  
 F1 F4

25cm  
 42cm  
 20lts



CAIXA PLAST P/MASSA 20 LTS PRETA  
 Código: 45251 Fábrica: MOLDE MINAS Unidade: UN/1  
 F1 F4

14 cm  
 56 cm  
 20 lts

 <p>Produto * Altura: 16 cm * Comp: 57cm * Largura: 36 cm</p> <p>CAIXA PLAST P/MASSA 22 LTS BRANCA</p> <p>Código: <b>12905</b>      Fábrica: <b>ECOPLASTIC</b>      Unidade: <b>UN/1</b> F1 F4</p>	 <p>CAIXA PLAST P/MASSA 22 LTS PRETA</p> <p>Código: <b>20662</b>      Fábrica: <b>ECOPLASTIC</b>      Unidade: <b>UN/1</b> F1 F4</p>	 <p>CAIXA PLAST PRETA VAZADA AGRICOLA/SUPERM</p> <p>Código: <b>18385</b>      Fábrica: <b>ECOPLASTIC</b>      Unidade: <b>UN/1</b> F1 F4</p>	 <p>CAIXA PLAST 19 LTS P/MASSA PRETA</p> <p>Código: <b>12117</b>      Fábrica: <b>ANTARES</b>      Unidade: <b>UN/1</b> F1 F4</p> <p>13cm 57,5cm 38cm</p>
 <p>CAIXA PLAST 6,0 LTS VERSATIL TRANSP 786</p> <p>Código: <b>39555</b>      Fábrica: <b>LUMAR</b>      Unidade: <b>UN/1</b> F1 F4</p> <p>6 lts</p>	 <p>CAIXA PLAST 7 LTS P/FRIOS 1637</p> <p>Código: <b>47068</b>      Fábrica: <b>JAGUAR</b>      Unidade: <b>UN/1</b> F1 F4</p> <p>8cm 45cm</p>	 <p>CAIXA TERMICA ISOPOR 80 LTS COM DRENO</p> <p>Código: <b>47998</b>      Fábrica: <b>ISOMAX</b>      Unidade: <b>UN/1</b> F1 F4</p>	 <p>CAIXA TERMICA 16 LTS COLOR</p> <p>Código: <b>31769</b>      Fábrica: <b>ANTARES</b>      Unidade: <b>UN/1</b> F1 F4</p>
 <p>CAIXA TERMICA 34 LTS COLOR</p> <p>Código: <b>30863</b>      Fábrica: <b>ANTARES</b>      Unidade: <b>UN/1</b> F1 F4</p>	 <p>CAIXA VERSATIL QUADR 3,5 LTS 951</p> <p>Código: <b>34582</b>      Fábrica: <b>PLASTBON</b>      Unidade: <b>UN/1</b> F1 F4</p>	 <p>CAIXA VERSATIL RED 3,5 LTS 949</p> <p>Código: <b>34583</b>      Fábrica: <b>PLASTBON</b>      Unidade: <b>UN/1</b> F1 F4</p>	 <p>CAIXA VERSATIL RET 3,5 LTS 950</p> <p>Código: <b>34574</b>      Fábrica: <b>PLASTBON</b>      Unidade: <b>UN/1</b> F1 F4</p>
 <p>CAIXA VERSATIL 2,5LTS RET FACILITA 6340</p> <p>Código: <b>20696</b>      Fábrica: <b>RISCHIOTO</b>      Unidade: <b>UN/1</b> F1 F4</p>	 <p>CAIXA VERSATIL 3,6LTS RET FACILITTA 0120</p> <p>Código: <b>20703</b>      Fábrica: <b>RISCHIOTO</b>      Unidade: <b>UN/1</b> F1 F4</p>	 <p>CALDEIRAO ALUM HOTEL ESP 32 22LTS</p> <p>Código: <b>50714</b>      Fábrica: <b>ASJ</b>      Unidade: <b>UN/1</b> F1 F4</p>	 <p>CALDEIRAO ALUM HOTEL ESP 36 32LTS</p> <p>Código: <b>50715</b>      Fábrica: <b>ASJ</b>      Unidade: <b>UN/1</b> F1 F4</p>



CALDEIRAO ALUM HOTEL 30 18LTS

Código: 50713  
 Fábrica: ASJ  
 Unidade: UN/1  
 F1 F4



CANECA ALUM CHOPP

Código: 14754  
 Fábrica: AVELAR  
 Unidade: UN/1  
 F1 F4



CANECA ALUM ESCOLAR 02 1286

Código: 37527  
 Fábrica: MSR  
 Unidade: UN/1  
 F1 F4



CANECA ALUM LEVE 12 FRIZADO 1,0 LT

Código: 11261  
 Fábrica: AVELAR  
 Unidade: UN/1  
 F1 F4



11 cm  
 350ml

CANECA ALUM 350ML CHOPP BOMDIMAIS 9012

Código: 40400  
 Fábrica: UN-ART  
 Unidade: UN/1  
 F1 F4



11 cm  
 350ml

CANECA ALUM 350ML CHOPP CERVEJA GEL 9009

Código: 40399  
 Fábrica: UN-ART  
 Unidade: UN/1  
 F1 F4



11 cm  
 350ml

CANECA ALUM 350ML CHOPP DRAHMA 9007

Código: 40398  
 Fábrica: UN-ART  
 Unidade: UN/1  
 F1 F4



CANECA ESMALTADA COLOR 80ML 18151 3X1

Código: 50212  
 Fábrica: WELLMIX  
 Unidade: CX/3  
 F1 F4



CANECA ESMALTADA COLOR 90ML 9111295 4X1

Código: 39257  
 Fábrica: FRATELLI  
 Unidade: PT/4  
 F1 F4



CANECA ESMALTADA PRETO 350ML 18149 6X1

Código: 50210  
 Fábrica: WELLMIX  
 Unidade: CX/6  
 F1 F4



CANECA ESMALTADA VERMELH 350ML 18150 6X1

Código: 50211  
 Fábrica: WELLMIX  
 Unidade: CX/6  
 F1 F4



CANECA ESMALTADA 8CM 7017

Código: 43592  
 Fábrica: KEY  
 Unidade: UN/1  
 F1 F4



CANECA INOX TERM 710ML AZUL 14043

Código: 40667  
 Fábrica: INGA  
 Unidade: UN/1  
 F1 F4



CANECA INOX TERM 710ML BRANCO 14044

Código: 40666  
 Fábrica: INGA  
 Unidade: UN/1  
 F1 F4



CANECA INOX TERM 710ML CINZA 14042

Código: 40669  
 Fábrica: INGA  
 Unidade: UN/1  
 F1 F4



CANECA INOX TERM 710ML PRETO 14041

Código: 40668  
 Fábrica: INGA  
 Unidade: UN/1  
 F1 F4



H 14 cm  
L 7 cm  
C 350ml

CANECA INOX 350ML LATINHA 14022

Código: 40317 Fábrica: WINCY Unidade: UN/1 F1 F4



CANECA METAL INOX 300ML CRUZEIRO 10716

Código: 41112 Fábrica: BRASFOOT Unidade: UN/1 F1 F4



CANECA PLAST C/ALCA 300 ML CORES

Código: 45926 Fábrica: ANTARES Unidade: UN/1 F1 F4



CANECA PLAST DEC 430ML INFANTIL 1403

Código: 40130 Fábrica: KOZI PLAST Unidade: UN/1 F1 F4



CANECA PLAST ESC 250 ML KIT 3 PCS 4013

Código: 7204 Fábrica: SBRISSA Unidade: CJ/3 F1 F4



CANECA PLAST ESC 270 ML DEC 8016 12X1

Código: 35222 Fábrica: SBRISSA Unidade: PT/12 F1 F4



CANECA PLAST ESCOLAR 300 ML 105

Código: 22324 Fábrica: ECOPLASTIC Unidade: UN/1 F1 F4



CANECA PLAST GEL 300ML ADORO 11641 2X1

Código: 41125 Fábrica: BRASFOOT Unidade: CJ/2 F1 F4



CANECA PLAST GEL 300ML BONDIMAIS 3961

Código: 39126 Fábrica: BRASFOOT Unidade: UN/1 F1 F4



CANECA PLAST GEL 300ML DRAHMA 3863

Código: 39127 Fábrica: BRASFOOT Unidade: UN/1 F1 F4



CANECA PLAST GEL 300ML HARLEY DAVI 2933

Código: 39130 Fábrica: BRASFOOT Unidade: UN/1 F1 F4



CANECA PLAST GEL 300ML VC ME F 11619 2X1

Código: 41124 Fábrica: BRASFOOT Unidade: F1 F4



CANECA PLAST TERMICA 450ML PAI IDOLO 05

Código: 39271 Fábrica: BRASFOOT Unidade: UN/1 F1 F4



CANECA PLAST 270 ML COLOR 617

Código: 38661 Fábrica: TRITEC Unidade: UN/1 F1 F4



CANECA PLAST 310ML COLOR 623

Código: 44082 Fábrica: QUALYPLAS Unidade: UN/1 F1 F4



CANECA PLAST 400 ML C/ ALCA 7000 6X1

Código: 33895 Fábrica: SBRISSA Unidade: CJ/6 F1 F4



CANECA PLAST 400 ML C/ALCA DEC 8022 6X1  
 Código: 35223 Fábrica: SBRISSA Unidade: PT/6  
 F1 F4



CANECA PLAST 450ML SORT P/FREEZER/MIC 47  
 Código: 40989 Fábrica: PLASTIBRASIL Unidade: UN/1  
 F1 F4



CANECA PORC 220 ML CACHORRO 13  
 Código: 44345 Fábrica: PORCELANASLU Unidade: UN/1  
 F1 F4



CANECA PORC 220 ML CAFE/COFFEE 13  
 Código: 37247 Fábrica: PORCELANASLU Unidade: UN/1  
 F1 F4



CANECA PORC 220 ML CARROS 13  
 Código: 37246 Fábrica: PORCELANASLU Unidade: UN/1  
 F1 F4



CANECA PORC 220 ML CHOCOLATE 13  
 Código: 44350 Fábrica: PORCELANASLU Unidade: UN/1  
 F1 F4



CANECA PORC 220 ML GATO 13  
 Código: 44344 Fábrica: PORCELANASLU Unidade: UN/1  
 F1 F4



CANECA PORC 220 ML MEME BENTO 13  
 Código: 44342 Fábrica: PORCELANASLU Unidade: UN/1  
 F1 F4



CANECA PORC 220 ML PAI 13  
 Código: 37244 Fábrica: PORCELANASLU Unidade: UN/1  
 F1 F4



CANECA PORC 220 ML PERIGO 13  
 Código: 44346 Fábrica: PORCELANASLU Unidade: UN/1  
 F1 F4



CANECA PORC 270ML DEC 778 12X1  
 Código: 41433 Fábrica: OXFORD Unidade: C3/12  
 F1 F4



CANECA PORC 270ML LISA PTO/BCO 777 12X1  
 Código: 41434 Fábrica: OXFORD Unidade: CX/12  
 F1 F4



CANECA PORC 360 ML MEU GAME FORT 2955  
 Código: 38995 Fábrica: BRASFOOT Unidade: UN/1  
 F1 F4



CANECA PORC 360 ML MEU GAME MINE 2567  
 Código: 39010 Fábrica: BRASFOOT Unidade: UN/1  
 F1 F4



CANECA PORC 360 ML URBAN DIRIGE SEU 5836  
 Código: 39110 Fábrica: BRASFOOT Unidade: UN/1  
 F1 F4



CANECA PORC 360 ML URBAN O MUNDO 2790  
 Código: 39104 Fábrica: BRASFOOT Unidade: UN/1  
 F1 F4



CANECA PORC 360ML URBAN ADORO NOS 11494  
 Código: **41134** Fábrica: **BRASFOOT** Unidade: **UN/1**  
**F1 F4**



CANECA PORC 360ML URBAN AMIGAS 10041  
 Código: **39111** Fábrica: **BRASFOOT** Unidade: **UN/1**  
**F1 F4**



CANECA PORC 360ML URBAN ATLETICO 1627  
 Código: **39113** Fábrica: **BRASFOOT** Unidade: **UN/1**  
**F1 F4**



CANECA PORC 360ML URBAN VC ME FAZ 11325  
 Código: **41135** Fábrica: **BRASFOOT** Unidade: **UN/1**  
**F1 F4**



CANECA PORCELANA 50ML DECOR 6X1  
 Código: **42804** Fábrica: **INTERPONTE** Unidade: **CX/6**  
**F1 F4**



CANECA TERMICA INOX 340ML TRIANGLE 16015  
 Código: **40319** Fábrica: **WINCY** Unidade: **UN/1**  
**F1 F4**



CANECA TERMICA INOX 500ML C/TAMPA 1401  
 Código: **40318** Fábrica: **WINCY** Unidade: **UN/1**  
**F1 F4**



CANECA VIDRO 100ML CANADA 016 6X1  
 Código: **49432** Fábrica: **RIOHOME** Unidade: **CJ/6**  
**F1 F4**



CANECA VIDRO 255ML TRANSP LISA VD24 6X1  
 Código: **40294** Fábrica: **MAXXIMUS** Unidade: **CJ/6**  
**F1 F4**



CANECA VIDRO 268ML NOVO 1070 48X1  
 Código: **39523** Fábrica: **MULTIPRESENT** Unidade: **CX/48**  
**F1 F4**



CANECA VIDRO 370 ML CHOPP 057 2X1  
 Código: **49395** Fábrica: **RIOHOME** Unidade: **CJ/1**  
**F1 F4**



CANECAO ALUM BAT FUND 16 CB MAD 2L 1519  
 Código: **37449** Fábrica: **MSR** Unidade: **UN/1**  
**F1 F4**



CANECAO ALUM CHOPP 10 667  
 Código: **22732** Fábrica: **MSR** Unidade: **UN/1**  
**F1 F4**



CANECAO ALUM CRAQUEADO 14 CB MAD 1,9 LT  
 Código: **34761** Fábrica: **AVELAR** Unidade: **UN/1**  
**F1 F4**



CANECAO ALUM EXTRA 12 CB MAD 1,0 LT 661  
 Código: **10438** Fábrica: **MSR** Unidade: **UN/1**  
**F1 F4**



CANECAO ALUM EXTRA 14 CB MAD 1,5 LTS 662  
 Código: **24370** Fábrica: **MSR** Unidade: **UN/1**  
**F1 F4**



CANEAÇO ALUM EXTRA 16 CB MAD 2,0 LTS 658  
 Código: 24369 Fábrica: MSR Unidade: UN/1  
 F1 F4



CANEAÇO ALUM EXTRA 18 CB MAD 2,5 LTS 659  
 Código: 24368 Fábrica: MSR Unidade: UN/1  
 F1 F4



CANEAÇO ALUM EXTRA 20 CB MAD 660  
 Código: 24367 Fábrica: MSR Unidade: UN/1  
 F1 F4



CANEAÇO ALUM LEVE JAPONES 2,0 LTS  
 Código: 27598 Fábrica: AVELAR Unidade: UN/1  
 F1 F4



CANEAÇO ALUM LEVE 14 CB BAQ 1,5 LTS 672  
 Código: 35255 Fábrica: MSR Unidade: UN/1  
 F1 F4



CANEAÇO ALUM LEVE 16 1,9 LTS  
 Código: 5891 Fábrica: AVELAR Unidade: UN/1  
 F1 F4



CANEAÇO ALUM LUXO FORTE 18 CB BAQ 1130  
 Código: 35037 Fábrica: MSR Unidade: UN/1  
 F1 F4



CANEAÇO ALUM LUXO FORTE 20 CB BAQ 898  
 Código: 35036 Fábrica: MSR Unidade: UN/1  
 F1 F4



CANEAÇO ALUM LUXO 12 CB BAQ 1,0LT 664  
 Código: 25305 Fábrica: MSR Unidade: UN/1  
 F1 F4



CANEAÇO ALUM LUXO 14 CB BAQ 1,5LT 663  
 Código: 24371 Fábrica: MSR Unidade: UN/1  
 F1 F4



CANEAÇO ALUM LUXO 16 CB BAQ 2L 665  
 Código: 24372 Fábrica: MSR Unidade: UN/1  
 F1 F4



CANEAÇO ALUM TEFLON 14 CB BAQ 1425  
 Código: 45283 Fábrica: MSR Unidade: UN/1  
 F1 F4



CANECO ALUM LEVE BOJUDO 2,7 LTS  
 Código: 5892 Fábrica: AVELAR Unidade: UN/1  
 F1 F4



CANECO PLAST 040  
 Código: 10962 Fábrica: HM UTILIDADE Unidade: UN/1  
 F1 F4



CANIVETE LAMINA ESTREITA 80X14MM 6326  
 Código: 41349 Fábrica: CORNETA Unidade: UN/1  
 F1 F4



CANUDO PAPEL 19,7X0,6CM BRANCO 100X1  
 Código: 46909 Fábrica: VMP Unidade: CX/100  
 F1 F4



CANUDO PAPEL 19,7X0,6CM BRANCO 25X1  
 Código: 46907 Fábrica: VMP Unidade: PT/25  
 F1 F4



CANUDO PAPEL 19,7X0,6CM ROSA 25X1  
 Código: 46908 Fábrica: VMP Unidade: PT/25  
 F1 F4



CANUDO PAPEL 19,7X0,8CM BRANCO 5067 25X1  
 Código: 47902 Fábrica: CASITA Unidade: PT/25  
 F1 F4



CANUDO PLAST LISO FLEXIVEL COLOR 100X1  
 Código: 50420 Fábrica: PLAZAPEL Unidade: PT/100  
 F1 F4



CANUDO PLAST MILK S 8X21CM EMB IND 150X1  
 Código: 47651 Fábrica: JACARE Unidade: PT/150  
 F1 F4



CANUDO PLAST VITAMI 6X21CM EMB IND 100X1  
 Código: 47652 Fábrica: PLASTSUL Unidade: PT/100  
 F1 F4



CANUDO PLASTICO 21CM 65074 100X1  
 Código: 33209 Fábrica: PLASTSU/SHOK Unidade: PT/1  
 F1 F4



CAPA ALMOFADA PANO INF 34X34CM FRENT EST  
 Código: 40450 Fábrica: SUN WELLS Unidade: UN/1  
 F1 F4

34 cm  
 34 cm



CAPA P/BOTIJA UNIVERSAL 13 KG  
 Código: 7771 Fábrica: FERREIRA Unidade: UN/1  
 F1 F4



CAPA P/FILTRO 15124  
 Código: 35113 Fábrica: SATYAM Unidade: UN/1  
 F1 F4



CAPA P/MAQUINA LAVAR NAPA REFOR ATE11 KG  
 Código: 11339 Fábrica: FERREIRA Unidade: UN/1  
 F1 F4



CAPA P/TAMPA DE FOGAO 4 BOCAS 52X52CM  
 Código: 39277 Fábrica: FERREIRA Unidade: UN/1  
 F1 F4

52cm  
 52cm

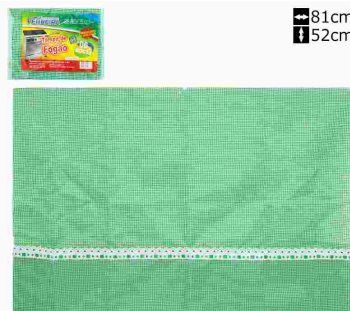

CAPA P/TAMPA DE FOGAO 6 BOCAS 52X81CM  
 Código: 11338 Fábrica: FERREIRA Unidade: UN/1  
 F1 F4



CARRETILHA INOX 20,8CM P/MASSAS 064  
 Código: 47333 Fábrica: NIX Unidade: UN/1  
 F1 F4

















21 cm  
 40 cm













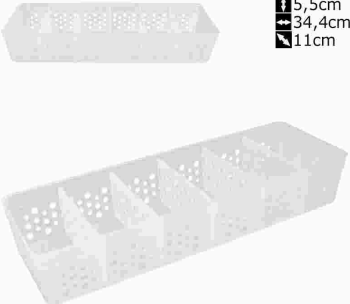

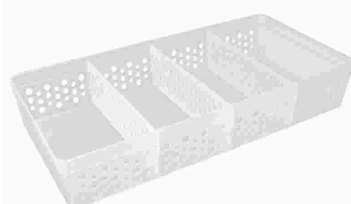

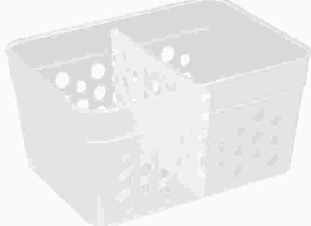
CARRIOLA PL CRISANTEMO CAFE 2390  
 Código: 37143 Fábrica: PAIOL Unidade: UN/1  
 F1 F4



CARRIOLA PL MADEIRA ENVELHECIDA P 5074-2  
 Código: 41403 Fábrica: PAIOL Unidade: UN/1  
 F1 F4

 <p><b>15,5 cm</b> <b>44 cm</b></p> <p>CARRIOLA PL 2 VIOLETAS CAFE 0126 Código: <b>37141</b> Fábrica: <b>PAIOL</b> Unidade: <b>UN/1</b> <b>F1 F4</b></p>	 <p>CASCA DE PINUS PO 1 KG Código: <b>22288</b> Fábrica: <b>VITAPLAN</b> Unidade: <b>PT/1</b> <b>F1 F4</b></p>	 <p>CASCA DE PINUS 300 GRS Código: <b>27463</b> Fábrica: <b>NOVATROPICAL</b> Unidade: <b>PT/1</b> <b>F1 F4</b></p>	 <p><b>38 cm</b> <b>16 cm</b></p> <p>CASINHA PLANTA GDE CAFE 130 Código: <b>37146</b> Fábrica: <b>PAIOL</b> Unidade: <b>UN/1</b> <b>F1 F4</b></p>
 <p><b>52 cm</b> <b>23 cm</b></p> <p>CASINHA PLANTA 2 ANDARES CAFE 0392 Código: <b>37145</b> Fábrica: <b>PAIOL</b> Unidade: <b>UN/1</b> <b>F1 F4</b></p>	 <p><b>40 cm</b> <b>27 cm</b></p> <p>CASINHA PLANTA 2 VIOLETAS CAFE 2460 Código: <b>37147</b> Fábrica: <b>PAIOL</b> Unidade: <b>UN/1</b> <b>F1 F4</b></p>	 <p><b>77 cm</b> <b>24 cm</b></p> <p>CASINHA PLANTA 3 ANDARES CAFE 0404 Código: <b>37144</b> Fábrica: <b>PAIOL</b> Unidade: <b>UN/1</b> <b>F1 F4</b></p>	 <p><b>33cm</b> <b>10,5cm</b> <b>23,5cm</b></p> <p>CESTA CAFE MANHA KRAFT 23,5X33X10,5CM UN Código: <b>44233</b> Fábrica: <b>PFEIFER</b> Unidade: <b>UN/1</b> <b>F1 F4</b></p>
 <p><b>19cm</b> <b>11cm</b></p> <p>CESTA FRALDEIRA 11CM RED PINUS 8940 Código: <b>50819</b> Fábrica: <b>PAIOL</b> Unidade: <b>UN/1</b> <b>F1 F4</b></p>	 <p><b>21cm</b> <b>13cm</b></p> <p>CESTA FRALDEIRA 13CM RED PINUS 8941 Código: <b>50820</b> Fábrica: <b>PAIOL</b> Unidade: <b>UN/1</b> <b>F1 F4</b></p>	 <p><b>23cm</b> <b>15cm</b></p> <p>CESTA FRALDEIRA 15CM RED PINUS 8942 Código: <b>50821</b> Fábrica: <b>PAIOL</b> Unidade: <b>UN/1</b> <b>F1 F4</b></p>	 <p><b>27cm</b> <b>18cm</b></p> <p>CESTA FRALDEIRA 18CM RED PINUS 8943 Código: <b>41297</b> Fábrica: <b>PAIOL</b> Unidade: <b>UN/1</b> <b>F1 F4</b></p>
 <p><b>31cm</b> <b>25cm</b></p> <p>CESTA FRALDEIRA 25CM RED PINUS 8944 Código: <b>41298</b> Fábrica: <b>PAIOL</b> Unidade: <b>UN/1</b> <b>F1 F4</b></p>	 <p><b>37cm</b> <b>30cm</b></p> <p>CESTA FRALDEIRA 30CM RED PINUS 8945 Código: <b>41299</b> Fábrica: <b>PAIOL</b> Unidade: <b>UN/1</b> <b>F1 F4</b></p>	 <p><b>32 cm</b> <b>31 cm</b></p> <p>CESTA VIME RED PEQ 5081 Código: <b>40611</b> Fábrica: <b>PAIOL</b> Unidade: <b>UN/1</b> <b>F1 F4</b></p>	 <p><b>25cm</b> <b>24cm</b></p> <p>CESTO PAPELEIRO TELADO QUAD PTO 24X24CM Código: <b>32922</b> Fábrica: <b>SHANGRILA</b> Unidade: <b>UN/1</b> <b>F1 F4</b></p>

 <p>                     24cm                      30cm                 </p> <p>                     CESTO PAPELEIRO TELADO RED PTO 23X30CM                      Código: <b>32923</b>    Fábrica: <b>SHANGRILA</b>    Unidade: <b>UN/1</b>                      F1 F4                 </p>	 <p>                     52cm                      75cm                      60Lts                 </p> <p>                     CESTO PLAST BASIC 60 LTS ECO 3081/79                      Código: <b>49172</b>    Fábrica: <b>JAGUAR</b>    Unidade: <b>UN/1</b>                      F1 F4                 </p>	 <p>                     55cm                      63cm                      95Lts                 </p> <p>                     CESTO PLAST FECHADO COLOR 95 LTS 6862                      Código: <b>41663</b>    Fábrica: <b>INPLAST</b>    Unidade: <b>UN/1</b>                      F1 F4                 </p>	 <p>                     5,5cm                      34,4cm                      11cm                 </p> <p>                     CESTO PLAST GDE C/5 DIV TRANSL 760                      Código: <b>44428</b>    Fábrica: <b>USUAL</b>    Unidade: <b>UN/1</b>                      F1 F4                 </p>
  <p>                     6cm                      34,4cm                      17cm                 </p> <p>                     CESTO PLAST MAXI C/3 DIV TRANSL 796                      Código: <b>44429</b>    Fábrica: <b>USUAL</b>    Unidade: <b>UN/1</b>                      F1 F4                 </p>	 <p>                     6cm                      24,4cm                      19cm                 </p> <p>                     CESTO PLAST MED 24,2X19,6,5CM PRETO 617                      Código: <b>44430</b>    Fábrica: <b>USUAL</b>    Unidade: <b>UN/1</b>                      F1 F4                 </p>	  <p>                     6cm                      34,4cm                      11cm                 </p> <p>                     CESTO PLAST MINI C/1 DIV TRANSL 757                      Código: <b>44427</b>    Fábrica: <b>USUAL</b>    Unidade: <b>UN/1</b>                      F1 F4                 </p>	 <p>                     CESTO PLAST ROUPEIRO 30 LTS COLOR 828                      Código: <b>51064</b>    Fábrica: <b>LUMAR</b>    Unidade: <b>UN/1</b>                      F1 F4                 </p>
 <p>                     CESTO PLAST ROUPEIRO 60 LTS 849                      Código: <b>46666</b>    Fábrica: <b>LUMAR</b>    Unidade: <b>UN/1</b>                      F1 F4                 </p>	 <p>                     64cm                      58cm                      100Lts                 </p> <p>                     CESTO PLAST ROUPEIRO 100 LTS PRETO 3100                      Código: <b>46667</b>    Fábrica: <b>LUMAR</b>    Unidade: <b>UN/1</b>                      F1 F4                 </p>	 <p>                     45cm                      52cm                 </p> <p>                     CESTO PLAST TELADO COLOR 62 LTS 6682                      Código: <b>41665</b>    Fábrica: <b>INPLAST</b>    Unidade: <b>UN/1</b>                      F1 F4                 </p>	 <p>                     24 cm                      25 cm                 </p> <p>                     CESTO PLAST TELADO RED BCO 24X25CM 340                      Código: <b>33032</b>    Fábrica: <b>TRITEC</b>    Unidade: <b>UN/1</b>                      F1 F4                 </p>
 <p>                     CESTO PLAST TELADO RED 30 LTS PRETO 789                      Código: <b>51062</b>    Fábrica: <b>LUMAR</b>    Unidade: <b>UN/1</b>                      F1 F4                 </p>	 <p>                     CESTO PLAST TELADO RED 60 LTS PRETO 937                      Código: <b>51063</b>    Fábrica: <b>LUMAR</b>    Unidade: <b>UN/1</b>                      F1 F4                 </p>	 <p>                     CESTO PLAST TELADO RET 35 LTS PRETO 1015                      Código: <b>51047</b>    Fábrica: <b>LUMAR</b>    Unidade: <b>UN/1</b>                      F1 F4                 </p>	 <p>                     CESTO PLAST TELADO RET 72 LTS PRETO 931                      Código: <b>51046</b>    Fábrica: <b>LUMAR</b>    Unidade: <b>UN/1</b>                      F1 F4                 </p>



CESTO PLAST TELADO 10 LTS PRETO 163

Código: **38656** Fábrica: **MOLDE MINAS** Unidade: **UN/1**  
F1 F4



CESTO PLAST TELADO 10 LTS 118

Código: **50003** Fábrica: **PLASMARC** Unidade: **UN/1**  
F1 F4



52cm  
10lts

CESTO PLAST TELADO 10 LTS 728

Código: **37264** Fábrica: **LUMAR** Unidade: **UN/1**  
F1 F4



52cm  
30lts

CESTO PLAST TELADO 30 LTS AZUL BABY 831

Código: **50943** Fábrica: **LUMAR** Unidade: **UN/1**  
F1 F4



52cm  
30lts

CESTO PLAST TELADO 30 LTS BRANCO 776

Código: **39552** Fábrica: **LUMAR** Unidade: **UN/1**  
F1 F4



30 lts

CESTO PLAST TELADO 30 LTS FENDI 873

Código: **39554** Fábrica: **LUMAR** Unidade: **UN/1**  
F1 F4

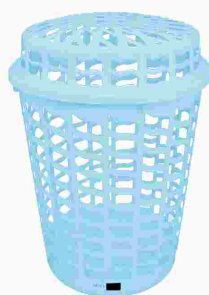

52cm  
30lts

CESTO PLAST TELADO 30 LTS ROSA BABY 831

Código: **48998** Fábrica: **LUMAR** Unidade: **UN/1**  
F1 F4

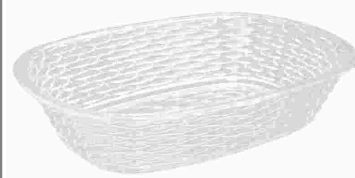

6cm  
30cm

CESTO P/PAO CRISTAL NATURAL 2342

Código: **44255** Fábrica: **TRITEC** Unidade: **UN/1**  
F1 F4



CESTO TELADO RET P/ROUPA 60 LTS CORES

Código: **40878** Fábrica: **ANTARES** Unidade: **UN/1**  
F1 F4



CESTO TELADO ROUPAS 30LTS COLOR 951765

Código: **41199** Fábrica: **PLASTSU** Unidade: **UN/1**  
F1 F4



CESTO TELADO ROUPAS 30LTS PRETO 951000

Código: **41198** Fábrica: **PLASTSU** Unidade: **UN/1**  
F1 F4



CHIPS DE COCO 1 LITRO

Código: **48533** Fábrica: **NOVATROPICAL** Unidade: **PT/1**  
F1 F4



CHUVEIRINHO P/TORNEIRA PIA TANQUE 1 12X1

Código: **33735** Fábrica: **REBOUCAS** Unidade: **PT/12**  
F1 F4



COADOR FLANELA CAFE SEM CABO 12X1

Código: **50969** Fábrica: **BEAUTY** Unidade: **DZ/12**  
F1 F4



COADOR FLANELA CAFE 102 CB MAD 12X1

Código: **27405** Fábrica: **MCPAN/BEAUTY** Unidade: **DZ/12**  
F1 F4



COADOR FLANELA CAFE 103 CB MAD 12X1

Código: **27406** Fábrica: **BEAU/AMO/MAR** Unidade: **DZ/12**  
F1 F4



COADOR FLANELA CAFE 104 CB ALUM 12X1

Código: 27412  
 Fábrica: FERREIRA  
 Unidade: DZ/12  
 F1 F4



COADOR FLANELA CAFE 104 CB MAD UN

Código: 46137  
 Fábrica: MC PANOS  
 Unidade: UN/1  
 F1 F4



COADOR FLANELA CAFE 104 CB MAD 12X1

Código: 27408  
 Fábrica: MC PANOS  
 Unidade: DZ/12  
 F1 F4



COADOR FLANELA CAFE 105 CB MAD 12X1

Código: 23956  
 Fábrica: MC PANOS  
 Unidade: DZ/12  
 F1 F4



COADOR FLANELA CAFE 107 CB MAD 12X1

Código: 34505  
 Fábrica: MC PANOS  
 Unidade: DZ/12  
 F1 F4



COADOR MALHA CAFE GDE CB PLAST 12X1

Código: 24949  
 Fábrica: NZA  
 Unidade: DZ/12  
 F1 F4



COADOR PLASTICO 07 CM 3020 UN

Código: 48015  
 Fábrica: SBRISSA  
 Unidade: UN/1  
 F1 F4



COADOR PLASTICO 12 CM 3021 UN

Código: 16642  
 Fábrica: SBRISSA  
 Unidade: UN/1  
 F1 F4



COADOR PLASTICO 18 CM 3023 UN

Código: 48009  
 Fábrica: SBRISSA  
 Unidade: UN/1  
 F1 F4



COLEIRA PET FIBRA C/SINO 30 CM 12X1

Código: 45878  
 Fábrica: ALMEGA  
 Unidade: PT/12  
 F1 F4



COLEIRA PET TIPO COURO 38 CM 15593 6X1

Código: 39244  
 Fábrica: ALIANCA  
 Unidade: PT/6  
 F1 F4



COLHER ACO INOX REFEICAO 21CM 14736 6X1

Código: 46490  
 Fábrica: NICOBEM  
 Unidade: PT/6  
 F1 F4



COLHER ACO INOX SOBREMESA 17CM 14771 6X1

Código: 46489  
 Fábrica: NICOBEM  
 Unidade: PT/6  
 F1 F4



COLHER ACO INOX 34CM GDE 14785

Código: 46488  
 Fábrica: NICOBEM  
 Unidade: UN/1  
 F1 F4



COLHER ALUM BATIDO 30CM ARROZ 2641

Código: 45293  
 Fábrica: MSR  
 Unidade: UN/1  
 F1 F4



COLHER ALUM 27CM INTEIRICO 2018 UN

Código: 48018  
 Fábrica: COFAX  
 Unidade: UN/1  
 F1 F4



**28 cm**

COLHER ALUM 28CM CB MAD 2003 UN  
 Código: 48035 Fábrica: COFAX Unidade: UN/1  
 F1 F4



**23cm**

COLHER BAMBU 23 CM 050  
 Código: 46252 Fábrica: CASITA Unidade: UN/1  
 F1 F4



**30cm**

COLHER BAMBU 30 CM 052  
 Código: 46253 Fábrica: CASITA Unidade: UN/1  
 F1 F4



COLHER DESCARTAVEL 50X1  
 Código: 42147 Fábrica: PLAZA/RIOFES Unidade: PT/50  
 F1 F4



**30 cm**

COLHER ESPATULA GARFO MADEIRA 30CM 6029  
 Código: 44738 Fábrica: WINCY Unidade: C/3  
 F1 F4



COLHER INOX CACIQUE 33CM 137  
 Código: 39351 Fábrica: PLANETA Unidade: UN/1  
 F1 F4



COLHER INOX CHA LINHA PRATA 110 12X1  
 Código: 47628 Fábrica: PLANETA Unidade: PT/12  
 F1 F4



COLHER INOX MESA LINHA AMERICA 2223 12X1  
 Código: 50620 Fábrica: STEEL Unidade: PT/12  
 F1 F4



COLHER INOX MESA UNIVERSO 2046 6X1  
 Código: 50136 Fábrica: GP6 Unidade: PT/6  
 F1 F4



COLHER INOX MESA 19CM VERSA PTO 954 12X1  
 Código: 50163 Fábrica: PLANETA Unidade: DZ/12  
 F1 F4



**32cm**

COLHER INOX P/ARROZ 35CM 173  
 Código: 19947 Fábrica: PLANETA Unidade: UN/1  
 F1 F4



COLHER INOX P/SUCO 30,5CM 8189  
 Código: 41541 Fábrica: ELITE Unidade: UN/1  
 F1 F4



COLHER INOX SOBREMESA BRONZE 522 12X1  
 Código: 39346 Fábrica: PLANETA Unidade: PT/12  
 F1 F4



COLHER INOX SOBREMESA VANGUARD 15CM 12X1  
 Código: 50906 Fábrica: GP INOX Unidade: CX/12  
 F1 F4



**19 cm**

COLHER INOX SORVETE C/EXTRATOR 19CM 3025  
 Código: 44728 Fábrica: WINCY Unidade: UN/1  
 F1 F4



**19 cm**

COLHER INOX SORVETE 19CM CB PLAST 3243  
 Código: 44727 Fábrica: WINCY Unidade: UN/1  
 F1 F4



COLHER MACARRAO NYLON PRETO 1085  
 Código: 37804 Fábrica: ENGIPLAST Unidade: UN/1  
 F1 F4



COLHER MADEIRA 23 CM 01  
 Código: 41315 Fábrica: MAD LAR Unidade: UN/1  
 F1 F4



COLHER MADEIRA 38 CM 105/05  
 Código: 30807 Fábrica: CSD/MAD LAR Unidade: UN/1  
 F1 F4



COLHER MEDIDORA CHA SOPA 400 4X1  
 Código: 37080 Fábrica: DELTA UTIL Unidade: PT/4  
 F1 F4



COLHER NYLON ARROZ 33,5CM CB CROMADO 424  
 Código: 41351 Fábrica: HAUSKRAFT Unidade: UN/1  
 F1 F4



COLHER NYLON BRANCA CB ACO 113-001  
 Código: 41487 Fábrica: HERCULES Unidade: UN/1  
 F1 F4



COLHER PLAST COLOR 24CM 1014  
 Código: 36953 Fábrica: ENGIPLAST Unidade: UN/1  
 F1 F4



COLHER PLAST COLOR 30CM 1015  
 Código: 36954 Fábrica: ENGIPLAST Unidade: UN/1  
 F1 F4



COLHER PLAST COLOR 36CM 1016  
 Código: 36955 Fábrica: ENGIPLAST Unidade: UN/1  
 F1 F4



COLHER PLAST COLOR 40CM 1017  
 Código: 36956 Fábrica: ENGIPLAST Unidade: UN/1  
 F1 F4



COLHER PLAST COLOR 5022  
 Código: 31279 Fábrica: SBRISSA Unidade: UN/1  
 F1 F4



COLHER PLAST P/SORVETE 19CM 290  
 Código: 39241 Fábrica: DELTA UTIL Unidade: UN/1  
 F1 F4



COLHER PLASTICA 17CM 12X1  
 Código: 14580 Fábrica: ECOPLASTIC Unidade: DZ/12  
 F1 F4



COLHER SILICONE ARROZ 27CM 110-11  
 Código: 44772 Fábrica: NICOBEM Unidade: UN/1  
 F1 F4



COLHER SILICONE VM CB ACO INOX 3098  
 Código: 33822 Fábrica: SATYAM Unidade: UN/1  
 F1 F4



COLHER SILICONE 30X8,5CM CORACAO 9701  
 Código: 50220 Fábrica: CASITA Unidade: UN/1  
 F1 F4



COLHER+CONCHA NYLON PTO 5003 2X1  
 Código: 18708 Fábrica: SBRISSA Unidade: KT/1  
 F1 F4



COLHER+PEGADOR MACARRAO NYLON 5004 2X1  
 Código: 18709 Fábrica: SBRISSA Unidade: KT/2  
 F1 F4



COMEDOIRO PLAST P/CAES MINI AZUL 170ML  
 Código: 24166 Fábrica: NUTRIPLAN Unidade: UN/1  
 F1 F4



COMEDOIRO PLAST P/CAES MINI ROSA 170ML  
 Código: 24164 Fábrica: NUTRIPLAN Unidade: UN/1  
 F1 F4



0,5 lts

COMEDOIRO PLAST PET 500 ML M COLOR  
 Código: 40037 Fábrica: ANTARES Unidade: UN/1  
 F1 F4



25cm

CONCHA ACO INOX FEIJAO 25CM 059  
 Código: 47490 Fábrica: PLANETA Unidade: UN/1  
 F1 F4



29cm

CONCHA ACO INOX MINI 29CM SAFIRA 160  
 Código: 28768 Fábrica: PLANETA Unidade: UN/1  
 F1 F4



30cm

CONCHA ALUM BATIDO 30CM 2643  
 Código: 45294 Fábrica: MSR Unidade: UN/1  
 F1 F4



CONCHA ALUM 27CM INTEIRICO 2020 UN  
 Código: 48022 Fábrica: COFAX Unidade: UN/1  
 F1 F4



CONCHA ALUM 28CM CB MAD 2000 UN  
 Código: 48019 Fábrica: COFAX Unidade: UN/1  
 F1 F4



CONCHA INOX CACIQUE 33CM 136  
 Código: 39350 Fábrica: PLANETA Unidade: UN/1  
 F1 F4



CONCHA INOX COZINHA 32CM 700-42  
 Código: 40534 Fábrica: CASA ONZE Unidade: UN/1  
 F1 F4



26 cm

CONCHA INOX FEIJAO 26 CM 147-48  
 Código: 44770 Fábrica: NICOBEM Unidade: UN/1  
 F1 F4



CONCHA INOX SAFIRA 23CM 159  
 Código: 39354 Fábrica: PLANETA Unidade: UN/1  
 F1 F4



CONCHA INOX VAZADA MINI 23CM SAFIRA 158  
 Código: 39353 Fábrica: PLANETA Unidade: UN/1  
 F1 F4



CONCHA INOX 30CM FDO CB MAD 32 12X1  
 Código: 38435 Fábrica: ARTE INOX Unidade: DZ/12  
 F1 F4



CONCHA INOX 32CM FDO INTEIRICO 50 6X1

Código: **38433** Fábrica: **ARTE INOX** Unidade: **PT/6**  
F1 F4



CONCHA INOX 32CM RASO CB MAD 33 12X1

Código: **38436** Fábrica: **ARTE INOX** Unidade: **DZ/12**  
F1 F4



CONCHA INOX 36CM RS S/SOL CB MAD 63 12X1

Código: **38442** Fábrica: **ARTE INOX** Unidade: **DZ/12**  
F1 F4



CONCHA NYLON BRANCA CB ACO 1103-002

Código: **41300** Fábrica: **HERCULES** Unidade: **UN/1**  
F1 F4



33,2 cm

CONCHA NYLON 33,2M CB CROMADO 069

Código: **41352** Fábrica: **HAUSKRAFT** Unidade: **UN/1**  
F1 F4



CONCHA PERFURADA INOX 27CM 72005

Código: **38429** Fábrica: **ALMEGA** Unidade: **UN/1**  
F1 F4



CONCHA PLAST COLOR 5023

Código: **31280** Fábrica: **SBRISSA** Unidade: **UN/1**  
F1 F4



28,5 cm

CONCHA SILICONE 28,5CM 110-12

Código: **44773** Fábrica: **NICOBEM** Unidade: **UN/1**  
F1 F4



CONCHA+COLHER+PEGADOR MACARR NYLON 5021

Código: **18711** Fábrica: **SBRISSA** Unidade: **KT/3**  
F1 F4



CONCHINHA PLAST MEDIDORA 150GRS 030

Código: **37881** Fábrica: **BENEDETTI** Unidade: **UN/1**  
F1 F4



CONEXAO PLAST ENGATE RAPIDO MANGUEIR 213

Código: **40240** Fábrica: **MONTEREY** Unidade: **UN/1**  
F1 F4



CONJ INOX P/SERVIR ARROZ 2PCS 152

Código: **41435** Fábrica: **MADEFERINOX** Unidade: **CJ/1**  
F1 F4



CONJ INOX P/SERVIR FEIJAO 2PCS 153

Código: **41436** Fábrica: **MADEFERINOX** Unidade: **CJ/1**  
F1 F4



CONJ INOX P/SERVIR MASSA 2PCS 150

Código: **41438** Fábrica: **MADEFERINOX** Unidade: **CJ/1**  
F1 F4



CONJ INOX P/SERVIR SALADA 2PCS 155

Código: **41437** Fábrica: **MADEFERINOX** Unidade: **CJ/1**  
F1 F4



CONJ INOX P/TORTA E BOLO 7PCS 42

Código: **41440** Fábrica: **MADEFERINOX** Unidade: **CJ/1**  
F1 F4



CONJ PANELA ALUM EXTR 14/16/18/20/22 720  
 Código: 35256 Fábrica: MSR Unidade: CJ/1 F1 F4



CONJ P/COZINHA ABRIDOR+DESCACADOR 7652  
 Código: 34805 Fábrica: IDEA Unidade: CR/1 F1 F4



CONJ SOBREMESA VIDRO BOWLS 150ML 3PC 014  
 Código: 49431 Fábrica: RIOHOME Unidade: UN/1 F1 F4



CONJ TALHERES CB MAD CHURRASCO 6007 12X1  
 Código: 44734 Fábrica: WINCY Unidade: CJ/12 F1 F4



CONJ UTENSILIOS INOX 4PCS 809  
 Código: 41439 Fábrica: MADEFERINOX Unidade: CJ/1 F1 F4



CONJ 6 TACA VIDRO 300ML BERLIM TRANSP  
 Código: 49428 Fábrica: RIOHOME Unidade: UN/1 F1 F4



CONJ 6 TACA VIDRO 320ML DIAMOND TRANSP  
 Código: 49804 Fábrica: FUTURO CASA Unidade: CJ/6 F1 F4



CONJ 6 TACA VIDRO 330ML BICO JACA TRANSP  
 Código: 48204 Fábrica: VIVA FLOR Unidade: CJ/6 F1 F4



CONJ 6 TACA VIDRO 335ML MADRID TRANSP  
 Código: 49429 Fábrica: RIOHOME Unidade: UN/1 F1 F4



CONJ 6 TACA VIDRO 340ML DIAMANTE TRANSP  
 Código: 48203 Fábrica: VIVA FLOR Unidade: CJ/6 F1 F4



CONJ 6 XICARAS CAFE CERAM 90 ML S/PIR 54  
 Código: 49434 Fábrica: RIOHOME Unidade: CJ/1 F1 F4



CONJ 6 XICARAS CHA VID C/PIRES ALEXA 10A  
 Código: 47416 Fábrica: DIAMONDS Unidade: CJ/1 F1 F4



CONJ 6 XICARAS CHA VID C/PIRES BELLA 753  
 Código: 47400 Fábrica: NUNESTAR Unidade: CJ/1 F1 F4



CONJ 6 XICARAS CHA VID C/PIRES STAR8983  
 Código: 47405 Fábrica: NUNESTAR Unidade: CJ/1 F1 F4



CONJ 6 XICARAS CHA VID C/PIRES STAR8984  
 Código: 47404 Fábrica: NUNESTAR Unidade: CJ/1 F1 F4



CONJ 6 XICARAS CHA VID C/PIRES STAR8986  
 Código: 47406 Fábrica: NUNESTAR Unidade: CJ/1 F1 F4



CONJ 6 XICARAS CHA VID C/PIRES TULIP 748  
 Código: 47399 Fábrica: NUNESTAR Unidade: CJ/1  
 F1 F4



CONJ 6 XICARAS CHA VID C/PIRES VINO 793  
 Código: 47403 Fábrica: NUNESTAR Unidade: CJ/1  
 F1 F4



CONJ 6 XICARAS PORC C/PIRES CAFE CUPC 29  
 Código: 41332 Fábrica: HAUSKRAFT Unidade: CJ/1  
 F1 F4



COOLER 10 LATAS 2674  
 Código: 45378 Fábrica: MSR Unidade: UN/1  
 F1 F4



COOLER 30 LATAS 2673  
 Código: 45377 Fábrica: MSR Unidade: UN/1  
 F1 F4



COPO ACRIL MEDIDOR GRADUADO 500ML 989  
 Código: 41641 Fábrica: QUALYPLAS Unidade: UN/1  
 F1 F4



COPO ALUM LEVE 300 ML LISO  
 Código: 34326 Fábrica: AVELAR Unidade: UN/1  
 F1 F4



COPO ALUM LISO 1285  
 Código: 37525 Fábrica: MSR Unidade: UN/1  
 F1 F4



COPO ALUM 200 ML 1423  
 Código: 37526 Fábrica: MSR Unidade: UN/1  
 F1 F4



COPO ALUM 290ML MUNICH MIX 76640  
 Código: 40401 Fábrica: UN-ART Unidade: UN/1  
 F1 F4



COPO ALUM 300 ML BRASIL  
 Código: 26860 Fábrica: AVELAR Unidade: UN/1  
 F1 F4



COPO ALUM 300 ML 666  
 Código: 35269 Fábrica: MSR Unidade: UN/1  
 F1 F4



COPO ALUM 410ML BERLIM MIX 76642  
 Código: 40402 Fábrica: UN-ART Unidade: UN/1  
 F1 F4



COPO CRISTAL PEQ TRANSP C/PISCA 70790/21  
 Código: 26452 Fábrica: Y888/HAI BRA Unidade: UN/1  
 F1 F4



COPO CRISTAL 550 ML GRADUADO TRANSP 1005  
 Código: 35493 Fábrica: TRITEC Unidade: UN/1  
 F1 F4



COPO DESCARTAVEL 50ML 100X1  
 Código: 50776 Fábrica: COPOPLAST Unidade: PT/100  
 F1 F4



COPO DESCARTAVEL 100ML (POTE) 100X1

Código: 50294 Fábrica: COPOPLAST Unidade: PT/100 F1 F4



COPO DESCARTAVEL 200ML 100X1

Código: 47738 Fábrica: COPO MAIS/FL Unidade: PT/100 F1 F4



COPO INOX TERM 500ML AZUL C/TPA ABRIDOR

Código: 40662 Fábrica: INGA Unidade: UN/1 F1 F4



COPO INOX TERM 500ML BRANCO C/TPA ABRIDO

Código: 40661 Fábrica: INGA Unidade: UN/1 F1 F4



COPO INOX TERM 500ML CINZA C/TPA ABRIDOR

Código: 40664 Fábrica: INGA Unidade: UN/1 F1 F4



COPO INOX TERM 500ML ROSA C/TPA ABRIDOR

Código: 40665 Fábrica: INGA Unidade: UN/1 F1 F4



COPO INOX 500ML 14X8,5X8,5CM 110021

Código: 39229 Fábrica: SATYAM Unidade: UN/1 F1 F4



COPO LONG DRINK CRISTAL 2654 UN

Código: 50677 Fábrica: TRITEC Unidade: UN/1 F1 F4



COPO LONG DRINK CRISTAL 2654 12X1

Código: 36234 Fábrica: TRITEC Unidade: PT/12 F1 F4



COPO PLAST DEC 430ML DONUTS 1405

Código: 40129 Fábrica: KOZI PLAST Unidade: UN/1 F1 F4



COPO PLAST DEC 430ML FELIZ NATAL 1406

Código: 40128 Fábrica: KOZI PLAST Unidade: UN/1 F1 F4



COPO PLAST INF C/TPA BIQUEIRA 985

Código: 20058 Fábrica: ERCAPLAST Unidade: UN/1 F1 F4



COPO PLAST INF P/SUCO PLUS 100 ML 130

Código: 14574 Fábrica: MAMITA Unidade: UN/1 F1 F4



COPO PLAST INF 245ML C/TPA 1490

Código: 47062 Fábrica: JAGUAR Unidade: UN/1 F1 F4



COPO PLAST INF 250 ML DEC 8017 12X1

Código: 35221 Fábrica: SBRISSA Unidade: PT/12 F1 F4



COPO PLAST INF 250 ML 7001 12X1

Código: 9797 Fábrica: SBRISSA Unidade: PT/12 F1 F4



COPO PLAST INF 250ML C/BIC DEC 8018 10X1  
 Código: 35216 Fábrica: SBRISSA Unidade: PT/10 F1 F4



COPO PLAST INF 250ML C/BICO 7011 10X1  
 Código: 31286 Fábrica: SBRISSA Unidade: PT/10 F1 F4



COPO PLAST INF 300 ML COLOR U020  
 Código: 45740 Fábrica: APAS Unidade: UN/1 F1 F4



COPO PLAST INF 300 ML C/TAMPA COLOR U060  
 Código: 45742 Fábrica: APAS Unidade: UN/1 F1 F4



COPO PLAST INF 300 ML C/TAMPA COLOR U061  
 Código: 45741 Fábrica: APAS Unidade: UN/1 F1 F4



COPO PLAST INOX 450ML FLAMENGO 2885  
 Código: 39042 Fábrica: BRASFOOT Unidade: UN/1 F1 F4



COPO PLAST INOX 450ML MEU GAME FORT 1154  
 Código: 39038 Fábrica: BRASFOOT Unidade: UN/1 F1 F4



COPO PLAST LONG DRINK 200ML AMARELO 2285  
 Código: 40101 Fábrica: MASSARI Unidade: UN/1 F1 F4



COPO PLAST LONG DRINK 200ML AZUL 2283  
 Código: 40100 Fábrica: MASSARI Unidade: UN/1 F1 F4



COPO PLAST LONG DRINK 200ML BRANCO 2281  
 Código: 40098 Fábrica: MASSARI Unidade: UN/1 F1 F4



COPO PLAST LONG DRINK 200ML CRISTAL 2280  
 Código: 40104 Fábrica: MASSARI Unidade: UN/1 F1 F4



COPO PLAST LONG DRINK 200ML ROSA 2282  
 Código: 40102 Fábrica: MASSARI Unidade: UN/1 F1 F4



COPO PLAST LONG DRINK 200ML VERMELH 2284  
 Código: 40103 Fábrica: MASSARI Unidade: UN/1 F1 F4



COPO PLAST LONG DRINK 350ML CANDY 1317  
 Código: 38132 Fábrica: KRIA KOISAS Unidade: UN/1 F1 F4



COPO PLAST MEDIDA TRANSP 5509  
 Código: 41667 Fábrica: INPLAST Unidade: UN/1 F1 F4



COPO PLAST P/CAIPIRINHA PEQ C/PILAO 403  
 Código: 33036 Fábrica: TRITEC Unidade: UN/1 F1 F4



11 08 cm

COPO PLAST RETRATIL 8734 6X1

Código: **36117** Fábrica: **PLASTSANDRI** Unidade: **PT/6**  
F1 F4



COPO PLAST TERMICO 200ML ATLETICO 2419

Código: **39040** Fábrica: **BRASFOOT** Unidade: **UN/1**  
F1 F4



COPO PLAST 350ML CONJ 0008 4X1

Código: **6187** Fábrica: **JAGUAR** Unidade: **CJ/4**  
F1 F4



COPO PLAST 350ML 0505

Código: **47058** Fábrica: **JAGUAR** Unidade: **UN/1**  
F1 F4



COPO PLAST 600ML C/TP CANUDO GUERREI 900

Código: **42757** Fábrica: **LUMAR** Unidade: **UN/1**  
F1 F4



COPO PLAST 600ML C/TP CANUDO PRINCES 901

Código: **42759** Fábrica: **LUMAR** Unidade: **UN/1**  
F1 F4



COPO PLAST 600ML C/TP CANUDO SPIDER 899

Código: **42756** Fábrica: **LUMAR** Unidade: **UN/1**  
F1 F4



COPO PLAST 600ML C/TP CANUDO UNICORN 902

Código: **42758** Fábrica: **LUMAR** Unidade: **UN/1**  
F1 F4



COPO TERM INOX 450ML 18X8CM 3696

Código: **41459** Fábrica: **MABEL** Unidade: **UN/1**  
F1 F4



COPO TERM 500ML STONE ATLETICO 10675

Código: **41149** Fábrica: **BRASFOOT** Unidade: **UN/1**  
F1 F4



COPO TERM 500ML STONE CRUZEIRO 10676

Código: **41148** Fábrica: **BRASFOOT** Unidade: **UN/1**  
F1 F4



11 6 cm  
1 50 ml

COPO VIDRO 50ML TRANSP 732 12X1

Código: **40228** Fábrica: **HAI BRASIL** Unidade: **CJ/12**  
F1 F4



11 9 cm  
1 4 cm  
1 74 ml

COPO VIDRO 74ML SHOT LEXINGTO 1063 96X1

Código: **39521** Fábrica: **MULTIPRESENT** Unidade: **CX/96**  
F1 F4



COPO VIDRO AMERICANO 190ML ATLETICO10845

Código: **41111** Fábrica: **BRASFOOT** Unidade: **UN/1**  
F1 F4



COPO VIDRO AMERICANO 190ML CRUZEIRO10846

Código: **41110** Fábrica: **BRASFOOT** Unidade: **UN/1**  
F1 F4



COPO VIDRO AMERICANO 190ML 24X1

Código: **47410** Fábrica: **NADIR** Unidade: **CX/24**  
F1 F4



COPO VIDRO AMERICANO 300ML 24X1

Código: **50369** Fábrica: **NADIR** Unidade: **CX/24**  
**F1 F4**



COPO VIDRO CAIPIRINHA FLAMENGO 9059

Código: **39013** Fábrica: **BRASFOOT** Unidade: **UN/1**  
**F1 F4**



COPO VIDRO CONJ CAIPIRINHA CRUZEIRO 2426

Código: **39123** Fábrica: **BRASFOOT** Unidade: **UN/1**  
**F1 F4**



COPO VIDRO CONJ CAIPIRINHA FLAMENGO 2429

Código: **39267** Fábrica: **BRASFOOT** Unidade: **UN/1**  
**F1 F4**



COPO VIDRO DOSE 60ML ATLETICO 2340

Código: **39121** Fábrica: **BRASFOOT** Unidade: **UN/1**  
**F1 F4**



COPO VIDRO DOSE 60ML FRASE DE BOTECO3916

Código: **39018** Fábrica: **BRASFOOT** Unidade: **UN/1**  
**F1 F4**



COPO VIDRO DOSE 60ML HARLEY DAVIDSO 2935

Código: **39019** Fábrica: **BRASFOOT** Unidade: **UN/1**  
**F1 F4**



COPO VIDRO DOSE 60ML PERAQUEFALTA 1648

Código: **39021** Fábrica: **BRASFOOT** Unidade: **UN/1**  
**F1 F4**



COPO VIDRO WHISKY ATOL 310ML ATLET 11220

Código: **41146** Fábrica: **BRASFOOT** Unidade: **UN/1**  
**F1 F4**



COPO VIDRO WHISKY ATOL 310ML CRUZE 11221

Código: **41147** Fábrica: **BRASFOOT** Unidade: **UN/1**  
**F1 F4**



COPO VIDRO WHISKY ATOL 310ML POKER 4524

Código: **39016** Fábrica: **BRASFOOT** Unidade: **UN/1**  
**F1 F4**



COPO VIDRO 145ML SCALE 017 6X1

Código: **49437** Fábrica: **RIOHOME** Unidade: **CX/1**  
**F1 F4**



COPO VIDRO 180 ML TRANSP 18899 6X1

Código: **48719** Fábrica: **WELLMIX** Unidade: **CJ/6**  
**F1 F4**



COPO VIDRO 180 ML TRANSP 18903 6X1

Código: **48717** Fábrica: **WELLMIX** Unidade: **CJ/6**  
**F1 F4**



COPO VIDRO 180 ML TRANSP 18905 6X1

Código: **48718** Fábrica: **WELLMIX** Unidade: **CJ/6**  
**F1 F4**



COPO VIDRO 200ML MUNICH DRAHMA 1255

Código: **39035** Fábrica: **BRASFOOT** Unidade: **UN/1**  
**F1 F4**



COPO VIDRO 200ML MUNICH MIX 14269  
 Código: 40397 Fábrica: UN-ART Unidade: UN/1  
 F1 F4



COPO VIDRO 200ML MUNICH SO VOU 1259  
 Código: 39037 Fábrica: BRASFOOT Unidade: UN/1  
 F1 F4



COPO VIDRO 207 ML TRANSP 60X1  
 Código: 39324 Fábrica: FUTURO Unidade: CJ/60  
 F1 F4



COPO VIDRO 250ML TRENTO CUBIC 943764 6X1  
 Código: 40891 Fábrica: CEDAR GLASS Unidade: CJ/4  
 F1 F4



COPO VIDRO 250ML TRENTO ROMAN 943765 6X1  
 Código: 40783 Fábrica: CEDAR GLASS Unidade: CJ/4  
 F1 F4



COPO VIDRO 290ML TRENTO SMALL 943762 6X1  
 Código: 40890 Fábrica: CEDAR GLASS Unidade: CJ/4  
 F1 F4



COPO VIDRO 300ML CHOPP ROSTOCK 1035 20X1  
 Código: 51078 Fábrica: MULTIPRESENT Unidade: CX/20  
 F1 F4



COPO VIDRO 300ML CHOPP ROSTOCK 1035 24X1  
 Código: 39531 Fábrica: MULTIPRESENT Unidade: CX/24  
 F1 F4



COPO VIDRO 340ML ALTO MONTECAR 1193 72X1  
 Código: 39529 Fábrica: MULTIPRESENT Unidade: CX/72  
 F1 F4



COPO VIDRO 348ML ALTO ALEGRO 1053 72X1  
 Código: 39525 Fábrica: MULTIPRESENT Unidade: CX/72  
 F1 F4



COPO VIDRO 350ML CHOPP TRANSP VD52 24X1  
 Código: 40300 Fábrica: MAXXIMUS Unidade: CX/24  
 F1 F4



COQUETEIRA INOX 500 ML 924  
 Código: 50068 Fábrica: PLANETA Unidade: UN/1  
 F1 F4



COQUETEIRA PLAST 600ML NOW OR NEVER75  
 Código: 39137 Fábrica: BRASFOOT Unidade: UN/1  
 F1 F4



COQUETEIRA PLAST 600ML PUSH YOUR LIMIT  
 Código: 39138 Fábrica: BRASFOOT Unidade: UN/1  
 F1 F4



COQUETEIRA PLAST 600ML TODA CONQUISTA  
 Código: 39139 Fábrica: BRASFOOT Unidade: UN/1  
 F1 F4



COQUETEIRA PLAST 600ML TREINE COMO UMA  
 Código: 39140 Fábrica: BRASFOOT Unidade: UN/1  
 F1 F4

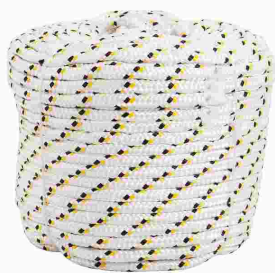

CORDA TRANCADA 14MM 50 MTS 4,5KG

Código: **46809** Fábrica: **VONDER** Unidade: **RL/1**  
**F1 F4**



CORDA VARAL ACO ENCAPADO 10 MTS 12X1

Código: **29842** Fábrica: **DEL WAL** Unidade: **PT/12**  
**F1 F4**



CORDA VARAL ACO ENCAPADO 15 MTS 12X1

Código: **29843** Fábrica: **DEL WAL** Unidade: **PT/12**  
**F1 F4**



CORDA VARAL ACO ENCAPADO 20 MTS 12X1

Código: **29844** Fábrica: **DEL WAL** Unidade: **PT/12**  
**F1 F4**



CORDA VARAL NYLON 3MM 10 MTS 1540

Código: **41539** Fábrica: **ELITE** Unidade: **UN/1**  
**F1 F4**



CORDA VARAL NYLON 4MM 10 MTS 2938

Código: **41545** Fábrica: **ELITE** Unidade: **UN/1**  
**F1 F4**



CORDA VARAL NYLON 5MM 20 MTS 3556

Código: **49628** Fábrica: **WINMAX** Unidade: **UN/1**  
**F1 F4**



CORDA VARAL PLAST MULTI USO 5 MTS 93003

Código: **45877** Fábrica: **ALMEGA** Unidade: **UN/1**  
**F1 F4**



CORDA VARAL PLAST MULTI USO 10 MTS 93002

Código: **34656** Fábrica: **ALMEGA** Unidade: **UN/1**  
**F1 F4**



CORDA VARAL PLAST 5MM 10 MTS 93002

Código: **45529** Fábrica: **WINMAX** Unidade: **UN/1**  
**F1 F4**



CORDA VARAL POLIESTER 15 MTS UNIVERS 614

Código: **46871** Fábrica: **PLANETA** Unidade: **UN/1**  
**F1 F4**

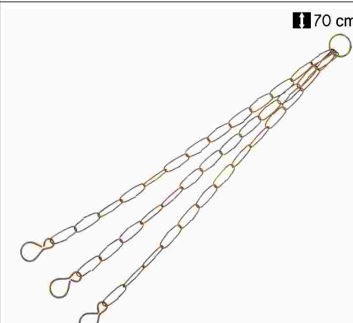

CORRENTAO METAL DOURADA XAXIM 70CM

Código: **39471** Fábrica: **WS CORRENTES** Unidade: **UN/1**  
**F1 F4**



CORRENTAO METAL DOURADA XAXIM 70CM 12X1

Código: **39470** Fábrica: **WS CORRENTES** Unidade: **PT/12**  
**F1 F4**



CORRENTE METAL DOURADA XAXIM 84CM 12X1

Código: **39472** Fábrica: **WS CORRENTES** Unidade: **PT/12**  
**F1 F4**



CORTADOR INOX MELANCIA 25,5CM 3029

Código: **44730** Fábrica: **WINCY** Unidade: **UN/1**  
**F1 F4**



CORTADOR INOX PASTEL CACIQUE 19,5CM 145

Código: **39356** Fábrica: **PLANETA** Unidade: **UN/1**  
**F1 F4**

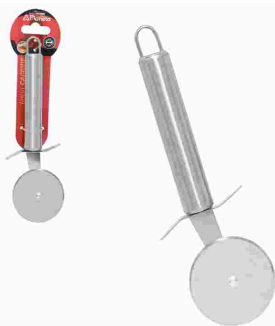

CORTADOR INOX PIZZA CACIQUE 20,5CM 146

Código: **39355** Fábrica: **PLANETA** Unidade: **UN/1**  
F1 F4



CORTADOR INOX QUEIJO 22X7,5CM 147-103

Código: **47149** Fábrica: **NICOBEM** Unidade: **UN/1**  
F1 F4

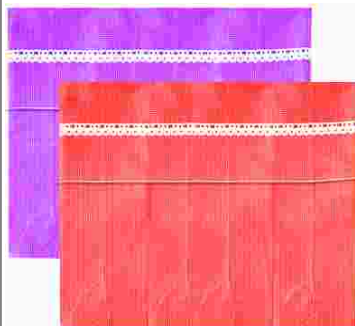

CORTINA P/PIA P 120X90CM

Código: **11294** Fábrica: **FERREIRA** Unidade: **UN/1**  
F1 F4



CUMBUCA BARRO 300 ML RED

Código: **30157** Fábrica: **AVELAR** Unidade: **UN/1**  
F4

06 cm  
12 cm  
300 ml



CUMBUCA BARRO 400 ML RED

Código: **36288** Fábrica: **AVELAR** Unidade: **UN/1**  
F1 F4



CUMBUCA PLAST 500 ML OVAL 11X15CM 683

Código: **50343** Fábrica: **QUALYPLAS** Unidade: **UN/1**  
F1 F4



CUMBUCA PLAST 650 ML COLOR 907

Código: **42762** Fábrica: **LUMAR** Unidade: **UN/1**  
F1 F4



CUSCUZEIRO ALUM 14 1147

Código: **35271** Fábrica: **MSR** Unidade: **UN/1**  
F1 F4



CUSCUZEIRO ALUM 16 668

Código: **35272** Fábrica: **MSR** Unidade: **UN/1**  
F1 F4



CUSCUZEIRO ALUM 18 669

Código: **35273** Fábrica: **MSR** Unidade: **UN/1**  
F1 F4



DEBULHADOR PLAST MILHO 11,5X7CM 3204

Código: **44724** Fábrica: **WINCY** Unidade: **UN/1**  
F1 F4



DECORADOR PLAST P/BOLO C/8 BICOS 7139

Código: **38346** Fábrica: **ALIANCA** Unidade: **UN/1**  
F1 F4

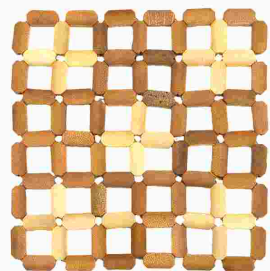

DESCANSO P/PANELAS BAMBU (ESTEIRA) 14752

Código: **44524** Fábrica: **NICOBEM** Unidade: **UN/1**  
F1 F4



DESCASCADOR FATIAD INOX 25CM LEGUMES 063

Código: **47334** Fábrica: **NIX** Unidade: **UN/1**  
F1 F4



DESCASCADOR MANUAL FRUTAS LEGUMES 147-57

Código: **46740** Fábrica: **NICOBEM** Unidade: **UN/1**  
F1 F4



DESENTUPIDOR DE PIA SANFONADO 5033

Código: **47251** Fábrica: **SHANGRILA** Unidade: **UN/1**  
F1 F4



DESENTUPIDOR SANITARIO WC 332

Código: **5544** Fábrica: **N.HORIZONTE** Unidade: **UN/1**  
F1 F4



DISPENSADOR VIDRO 210ML ACUCAR 18394

Código: **40902** Fábrica: **FUTURO** Unidade: **UN/1**  
F1 F4



DISPENSER INOX CILIND P/COPO AGUA 200ML

Código: **41851** Fábrica: **AURIMAR** Unidade: **UN/1**  
F1 F4



28cm

DISPENSER PLAST PAPEL HIG ROLAO 300/500M

Código: **47834** Fábrica: **NOBRE** Unidade: **UN/1**  
F1 F4



30cm

DISPENSER PLAST PAPEL TOALHA 1/3D 39999

Código: **47832** Fábrica: **NOBRE** Unidade: **UN/1**  
F1 F4



62cm

DISPENSER PLAST POUPADOR COPO AGUA 200ML

Código: **47831** Fábrica: **NOBRE** Unidade: **UN/1**  
F1 F4



25cm

DISPENSER PLAST SABONE LIQ/ALCOOL 800ML

Código: **47833** Fábrica: **NOBRE** Unidade: **UN/1**  
F1 F4



DOSADOR PLASTICO GARRAFA 707 2X1

Código: **27647** Fábrica: **CLINK** Unidade: **PT/2**  
F1 F4



EBULIDOR ALUMINIO 127 V 1000W PEQ 101/WA

Código: **22827** Fábrica: **IMC/RESIS** Unidade: **UN/1**  
F1 F4



EBULIDOR ALUMINIO 127 V 2000W GDE 103

Código: **27093** Fábrica: **IMC/RESISWAL** Unidade: **UN/1**  
F1 F4



EBULIDOR ALUMINIO 220 V 1000W PEQ 104

Código: **26118** Fábrica: **IMC/RESISWAL** Unidade: **UN/1**  
F1 F4



EBULIDOR ALUMINIO 220 V 2000W GDE GB

Código: **41653** Fábrica: **IMC/RESISWAL** Unidade: **UN/1**  
F1 F4



EMBALAGEM C/ALCA P/MUDA PL 21 LTS PRETO

Código: **41374** Fábrica: **NUTRIPLAN** Unidade: **UN/1**  
F1 F4



EMBALAGEM C/ALCA P/MUDA PL 33 LTS PRETO

Código: **41373** Fábrica: **NUTRIPLAN** Unidade: **UN/1**  
F1 F4



EMBALAGEM C/ALCA P/MUDA PL 39 LTS PRETO

Código: **41375** Fábrica: **NUTRIPLAN** Unidade: **UN/1**  
F1 F4



EMBALAGEM C/ALCA P/MUDA PL 40 LTS PRETO

Código: **41376** Fábrica: **NUTRIPLAN** Unidade: **UN/1**  
F1 F4



EMBALAGEM C/ALCA P/MUDA PL 50 LTS PRETO  
 Código: 41377 Fábrica: NUTRIPLAN Unidade: UN/1  
 F1 F4



EMBALAGEM C/ALCA P/MUDA PL 60 LTS PRETO  
 Código: 41378 Fábrica: NUTRIPLAN Unidade: UN/1  
 F1 F4



EMBALAGEM C/ALCA P/MUDA PL 85 LTS PRETO  
 Código: 41379 Fábrica: NUTRIPLAN Unidade: UN/1  
 F1 F4



EMBALAGEM C/ALCA P/MUDA PL 110 LTS PTO  
 Código: 41380 Fábrica: NUTRIPLAN Unidade: UN/1  
 F1 F4

12 cm  
 12 cm  
 1 lts



EMBALAGEM P/MUDA PL 1 LT PRETO  
 Código: 38912 Fábrica: NUTRIPLAN Unidade: UN/1  
 F1 F4

Altura : 15 cm  
 Larg : 18 cm



EMBALAGEM P/MUDA PL 2,8 LTS PRETO  
 Código: 30320 Fábrica: NUTRIPLAN Unidade: UN/1  
 F1 F4

Altura : 20 cm  
 Larg : 20 cm



EMBALAGEM P/MUDA PL 5 LTS PRETO  
 Código: 30318 Fábrica: NUTRIPLAN Unidade: UN/1  
 F1 F4



EMBALAGEM P/MUDA PL 7 LTS PRETO  
 Código: 41372 Fábrica: NUTRIPLAN Unidade: UN/1  
 F1 F4

Altura : 22 cm  
 Larg : 23 cm



EMBALAGEM P/MUDA PL 8 LTS PRETO  
 Código: 30319 Fábrica: NUTRIPLAN Unidade: UN/1  
 F1 F4

25cm  
 25 cm  
 10 lts



EMBALAGEM P/MUDA PL 10 LTS PRETO  
 Código: 38915 Fábrica: NUTRIPLAN Unidade: UN/1  
 F1 F4

24 cm  
 27,5 cm



EMBALAGEM P/MUDA PL 11 LTS PRETO  
 Código: 31389 Fábrica: NUTRIPLAN Unidade: UN/1  
 F1 F4

28cm  
 28 cm  
 14.3 lts



EMBALAGEM P/MUDA PL 14,3 LTS PRETO  
 Código: 38913 Fábrica: NUTRIPLAN Unidade: UN/1  
 F1 F4

30 cm  
 30 cm  
 18 lts



EMBALAGEM P/MUDA PL 18 LTS PRETO  
 Código: 33531 Fábrica: NUTRIPLAN Unidade: UN/1  
 F1 F4

35cm  
 34 cm  
 25 lts



EMBALAGEM P/MUDA PL 25 LTS PRETO  
 Código: 38914 Fábrica: NUTRIPLAN Unidade: UN/1  
 F1 F4



EMBALAGEM P/MUDA PL 35 LTS PRETO  
 Código: 41401 Fábrica: NUTRIPLAN Unidade: UN/1  
 F1 F4



EMENDA PLAST MANGUEIRA SMART 212  
 Código: 40239 Fábrica: MONTEREY Unidade: UN/1  
 F1 F4



ENGATE RAPIDO PLAST MANGUEIRA 4X1 4092

Código: 50145  
Fábrica: GP6  
Unidade: CR/1  
F1 F4



ESCORREDOR ACO INOX 18X10CM 9375

Código: 50219  
Fábrica: CASITA  
Unidade: UN/1  
F1 F4



ESCORREDOR ACO INOX 28X35X14CM 9376

Código: 50218  
Fábrica: CASITA  
Unidade: UN/1  
F1 F4



ESCORREDOR ALUM ARROZ 670

Código: 6733  
Fábrica: MSR  
Unidade: UN/1  
F1 F4



ESCORREDOR ALUM MACARRAO HOTEL 45

Código: 50168  
Fábrica: MSR  
Unidade: UN/1  
F1 F4



ESCORREDOR CROM PRAT/COP MEIA LUA 806

Código: 33913  
Fábrica: ARAMINAS  
Unidade: UN/1  
F1 F4



ESCORREDOR CROM PRAT/COP MINI 947

Código: 49960  
Fábrica: ARAMINAS  
Unidade: UN/1  
F1 F4



ESCORREDOR CROM PRAT/COP 2AND 39X25CM 31

Código: 24607  
Fábrica: ARAMINAS  
Unidade: UN/1  
F1 F4

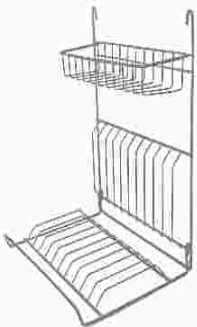

ESCORREDOR CROM PRATO PAREDE 563

Código: 28955  
Fábrica: ARAMINAS  
Unidade: UN/1  
F1 F4



ESCORREDOR CROM PRATO SIMPLES 697

Código: 20174  
Fábrica: ARAMINAS  
Unidade: UN/1  
F1 F4



ESCORREDOR CROM PRATO/COPO 32 BAIXO41X32

Código: 24608  
Fábrica: ARAMINAS  
Unidade: UN/1  
F1 F4



ESCORREDOR CROM 2AND TUBULAR 30

Código: 40248  
Fábrica: ARAMINAS  
Unidade: UN/1  
F1 F4



ESCORREDOR PLAST ARROZ CORES 467

Código: 46642  
Fábrica: QUALYPLAS  
Unidade: UN/1  
F1 F4



ESCORREDOR PLAST ARROZ 5589

Código: 35485  
Fábrica: TRITEC  
Unidade: UN/1  
F1 F4

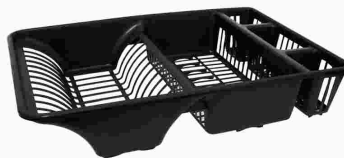

ESCORREDOR PLAST LOUCA PRETO 410

Código: 48378  
Fábrica: PLASMARC  
Unidade: UN/1  
F1 F4

46cm  
19cm  
32cm



ESCORREDOR PLAST MASSAS 0013

Código: 2675  
Fábrica: JAGUAR  
Unidade: UN/1  
F1 F4

11cm  
30cm



ESCORREDOR PLAST MULTI USO C/ALCAS 987

Código: 46673 Fábrica: LUMAR Unidade: UN/1  
F1 F4

10cm  
48cm



ESCORREDOR PLAST PRATO 503

Código: 35487 Fábrica: TRITEC Unidade: UN/1  
F1 F4



ESCORREDOR PLAST PRATOS 16

Código: 2076 Fábrica: JAGUAR Unidade: UN/1  
F1 F4

3 cm  
39 cm  
12,5cm



ESCORREDOR PLAST P/TINTA DE PINTURA

Código: 40076 Fábrica: MOLDE MINAS Unidade: UN/1  
F1 F4



ESCOVA LAVAR ROUPA MAD OVAL MAX 4 12X1

Código: 28872 Fábrica: N.HORIZONTE Unidade: PT/12  
F1 F4



ESCOVA LAVAR ROUPA MAD OVAL MED 3 12X1

Código: 7122 Fábrica: N.HORIZONTE Unidade: PT/12  
F1 F4



ESCOVA LAVAR ROUPA MAD OVAL PEQ 5 12X1

Código: 34403 Fábrica: N.HORIZONTE Unidade: PT/12  
F1 F4



ESCOVA LAVAR ROUPA MAD RET MED 26 12X1

Código: 28135 Fábrica: N.HORIZONTE Unidade: PT/12  
F1 F4



ESCOVA LAVAR ROUPA MAD RET PEQ 12X1

Código: 36310 Fábrica: N.HORIZONTE Unidade: PT/12  
F1 F4



ESCOVA LAVAR ROUPA MAD 16 MED 85175 12X1

Código: 6290 Fábrica: CONDOR Unidade: DZ/12  
F1 F4



ESCOVA LAVAR ROUPA PLAST ANTIDERRAP UN

Código: 20137 Fábrica: N.HORIZONTE Unidade: UN/1  
F1 F4



ESCOVA LAVAR ROUPA PLAST OVAL 25 12X1

Código: 22595 Fábrica: N.HORIZONTE Unidade: PT/12  
F1 F4



ESCOVA LAVAR ROUPA UN

Código: 47255 Fábrica: SHANG/NHORIZ Unidade: UN/1  
F1 F4



ESCOVA MAD P/SAPATO 6/287

Código: 28136 Fábrica: N.HORIZONTE Unidade: UN/1  
F1 F4



ESCOVA PLAST LIMPEZA 15,5CM 1467

Código: 41542 Fábrica: ELITE Unidade: UN/1  
F1 F4



ESCOVA P/ROUPA MAD RET MULTI USO 29/316

Código: 28873 Fábrica: N.HORIZONTE Unidade: UN/1  
F1 F4



ESCOVA SANIT LAVATINA NYLON 12X1

Código: **29313** Fábrica: **N.HORIZONTE** Unidade: **DZ/12**  
F1 F4



ESCOVA SANITARIA CB PLAST C/SUP AZUL 151

Código: **46865** Fábrica: **PLANETA** Unidade: **UN/1**  
F1 F4



ESCOVA SANITARIA CB PLAST C/SUP BCO 150

Código: **41564** Fábrica: **PLANETA** Unidade: **UN/1**  
F1 F4



ESCOVA SANITARIA CB PLAST C/SUP ROSA 152

Código: **46866** Fábrica: **PLANETA** Unidade: **UN/1**  
F1 F4



ESCOVA SANITARIA CB PLAST C/SUORTE 2355

Código: **38001** Fábrica: **DALCIN** Unidade: **UN/1**  
F1 F4



ESCUMADEIRA ACO INOX 25,5CM LAR 060

Código: **50101** Fábrica: **PLANETA** Unidade: **UN/1**  
F1 F4



ESCUMADEIRA ALUM BATIDO 30CM 2644

Código: **45295** Fábrica: **MSR** Unidade: **UN/1**  
F1 F4



ESCUMADEIRA ALUM FUNDIDO 30CM

Código: **29648** Fábrica: **AVELAR** Unidade: **UN/1**  
F1 F4



ESCUMADEIRA ALUM 27CM INTEIRIC 2019 UN

Código: **48020** Fábrica: **COFAX** Unidade: **UN/1**  
F1 F4



ESCUMADEIRA ALUM 28CM CB MAD 2001 UN

Código: **48036** Fábrica: **COFAX** Unidade: **UN/1**  
F1 F4



ESCUMADEIRA CROM 01 CB MADEIRA 01 33

Código: **28964** Fábrica: **ARAMINAS** Unidade: **UN/1**  
F1 F4



ESCUMADEIRA CROM 02 CB INTEIRICO 277

Código: **20177** Fábrica: **ARAMINAS** Unidade: **UN/1**  
F1 F4



ESCUMADEIRA CROM 02 CB MADEIRA 34

Código: **28965** Fábrica: **ARAMINAS** Unidade: **UN/1**  
F1 F4

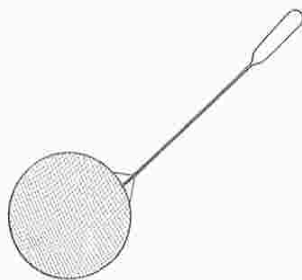

ESCUMADEIRA CROM 03 CB INTEIRICO 278

Código: **20178** Fábrica: **ARAMINAS** Unidade: **UN/1**  
F1 F4



ESCUMADEIRA CROM 03 CB MADEIRA 35

Código: **28966** Fábrica: **ARAMINAS** Unidade: **UN/1**  
F1 F4



ESCUMADEIRA CROM 04 CB INTEIRICO 279

Código: **29831** Fábrica: **ARAMINAS** Unidade: **UN/1**  
F1 F4



ESCUMADEIRA CROM 04 CB MADEIRA 36  
 Código: 28967 Fábrica: ARAMINAS Unidade: UN/1  
 F1 F4



ESCUMADEIRA CROM 05 CB INTEIR INDST 189  
 Código: 29832 Fábrica: ARAMINAS Unidade: UN/1  
 F1 F4



ESCUMADEIRA CROM 05 CB MAD INDUST 05  
 Código: 28968 Fábrica: ARAMINAS Unidade: UN/1  
 F1 F4

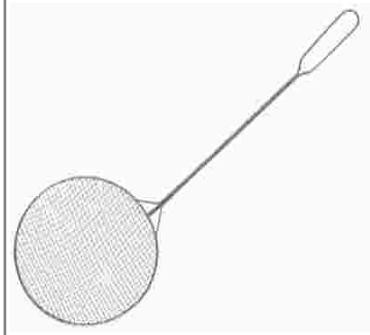

ESCUMADEIRA CROM 06 CB INTEI INDST 114  
 Código: 12165 Fábrica: ARAMINAS Unidade: UN/1  
 F1 F4



ESCUMADEIRA CROM 06 CB MAD INDST 38  
 Código: 28969 Fábrica: ARAMINAS Unidade: UN/1  
 F1 F4



ESCUMADEIRA INOX CACIQUE 33CM 138  
 Código: 39352 Fábrica: PLANETA Unidade: UN/1  
 F1 F4



ESCUMADEIRA NYLON BRANCA CB ACO 113-005  
 Código: 41599 Fábrica: HERCULES Unidade: UN/1  
 F1 F4



ESCUMADEIRA NYLON PRETO 28CM 1084  
 Código: 37803 Fábrica: ENGIPLAST Unidade: UN/1  
 F1 F4



ESCUMADEIRA NYLON 35CM CB CROMADO 66  
 Código: 41350 Fábrica: HAUSKRAFT Unidade: UN/1  
 F1 F4



ESCUMADEIRA PLAST 33CM COLOR 823  
 Código: 41644 Fábrica: QUALYPLAS Unidade: UN/1  
 F1 F4



ESCUMADEIRA SILICONE COLOR 29CM 17071  
 Código: 33951 Fábrica: PRATIBELLA Unidade: UN/1  
 F1 F4



ESGUICHO ADAP/CONEC/PISTOL MANGUEIR 1/2"  
 Código: 50968 Fábrica: FBG Unidade: CR/1  
 F1 F4



ESGUICHO PIST PLAST ADAPT MANGUEIR 1/2"  
 Código: 49642 Fábrica: WINMAX Unidade: UN/1  
 F1 F4



ESGUICHO PLAST ADAP/CONEC MANGUEIR 1/2"  
 Código: 50966 Fábrica: IMPORIENTE Unidade: CR/1  
 F1 F4



ESGUICHO PLAST ADAP/CONEC MANGUEIR 1/2"  
 Código: 49643 Fábrica: WINMAX Unidade: UN/1  
 F1 F4



ESPANADOR PENA 20 NOMO COLOR 100  
 Código: 48401 Fábrica: SHANGRILA Unidade: UN/1  
 F1 F4



ESPANADOR PENA 20 NOMO 86  
 Código: 48399 Fábrica: SHANGRILA Unidade: UN/1  
 F1 F4



ESPANADOR PENA 25 NOMO CLEAN 5844  
 Código: 50196 Fábrica: SHANGRILA Unidade: UN/1  
 F1 F4



ESPANADOR PENA 30 NOMO COLOR 101  
 Código: 48402 Fábrica: SHANGRILA Unidade: UN/1  
 F1 F4



ESPANADOR PENA 35 NOMO CLEAN 5718  
 Código: 50195 Fábrica: SHANGRILA Unidade: UN/1  
 F1 F4



ESPANADOR PENA 45 NOMO CLEAN 5719  
 Código: 50194 Fábrica: SHANGRILA Unidade: UN/1  
 F1 F4



ESPATULA ALUM FUNDIDO 30CM  
 Código: 32524 Fábrica: AVELAR Unidade: UN/1  
 F1 F4



ESPATULA BAMBU VAZADA 30CM CB COLOR 6025  
 Código: 44737 Fábrica: WINCY Unidade: UN/1  
 F1 F4



ESPATULA INOX P/BOLO 24CM CTL 1736  
 Código: 15922 Fábrica: SIMONAGGIO Unidade: UN/1  
 F1 F4



ESPATULA INOX P/BOLO 26CM 062  
 Código: 46841 Fábrica: PLANETA Unidade: UN/1  
 F1 F4



ESPATULA INOX RETA 24X12CM CB PLAST -25  
 Código: 45292 Fábrica: NICOBEM Unidade: UN/1  
 F1 F4



ESPATULA INOX 26,5CM P/BOLO 061  
 Código: 47326 Fábrica: NIX Unidade: UN/1  
 F1 F4



ESPATULA SILICONE CURVA VERMELH 24CM 328  
 Código: 46870 Fábrica: PLANETA Unidade: UN/1  
 F1 F4



ESPATULA SILICONE VAZADA 27CM PRETO 653  
 Código: 50099 Fábrica: PLANETA Unidade: UN/1  
 F1 F4



ESPATULA SILICONE VAZADA 27CM VERMEL 993  
 Código: 50098 Fábrica: PLANETA Unidade: UN/1  
 F1 F4



ESPATULA SILICONE VM CB ACO INOX 3094  
 Código: 33820 Fábrica: GEDEX Unidade: UN/1  
 F1 F4



ESPETO BAMBU CHURRASCO 25CM 24260 50X1  
 Código: 47880 Fábrica: BOMPACK Unidade: PT/50  
 F1 F4



ESPETO BAMBU CHURRASCO 30CM 24672 50X1  
 Código: 44763 Fábrica: BOMPACK Unidade: PT/50  
 F1 F4



ESPETO DUPLO 55 CM 02  
 Código: 24059 Fábrica: ARAMINAS Unidade: UN/1  
 F1 F4



ESPETO DUPLO 65 CM 03  
 Código: 24060 Fábrica: ARAMINAS Unidade: UN/1  
 F1 F4



ESPETO DUPLO 75 CM 04  
 Código: 24061 Fábrica: ARAMINAS Unidade: UN/1  
 F1 F4



ESPETO MAD CHURRASCO 18CM 64008 100X1  
 Código: 41178 Fábrica: THEOTO Unidade: PT/100  
 F1 F4



ESPETO MAD CHURRASCO 25CM 5000X1  
 Código: 49693 Fábrica: ESTILO Unidade: CX/5000  
 F1 F4



ESPETO MAD CHURRASCO 25CM 64021 100X1  
 Código: 1938 Fábrica: THEOTO Unidade: PT/100  
 F1 F4



ESPETO MAD CHURRASCO 25CM 80X1  
 Código: 49694 Fábrica: ESTILO Unidade: CX/80  
 F1 F4



ESPETO SIMPLES ACO ESTANHADO 55 CM 05  
 Código: 12947 Fábrica: ARAMINAS Unidade: UN/1  
 F1 F4



ESPETO SIMPLES ACO ESTANHADO 65 CM 06  
 Código: 12948 Fábrica: ARAMINAS Unidade: UN/1  
 F1 F4



ESPETO SIMPLES ACO ESTANHADO 75 CM 07  
 Código: 12949 Fábrica: ARAMINAS Unidade: UN/1  
 F1 F4



ESPETO SIMPLES ACO ESTANHADO 85 CM 0215  
 Código: 40264 Fábrica: ARAMIG Unidade: UN/1  
 F1 F4



ESPETO SIMPLES ACO ESTANHADO 85 CM 26  
 Código: 44718 Fábrica: ARAMINAS Unidade: UN/1  
 F1 F4

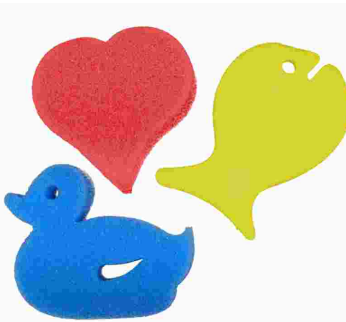

ESPUNJA BANHO INFANTIL UN  
 Código: 44333 Fábrica: MC PANOS Unidade: UN/1  
 F1 F4



ESPUNJA BANHO MASSAGADORA  
 Código: 50150 Fábrica: MC PANOS Unidade: UN/1  
 F1 F4



ESPUNJA LIMPEZA DUPLA FACE UN  
 Código: 46436 Fábrica: NOBRE Unidade: UN/1  
 F1 F4



ESPONJA LIMPEZA DUPLA FACE 3X1

Código: **50125** Fábrica: **ESPONFLORA** Unidade: **PT/3**  
**F1 F4**



ESPONJA MODELO LUVA P/LAVAR CARRO

Código: **11331** Fábrica: **FERREIRA** Unidade: **UN/1**  
**F1 F4**



ESPONJA P/LAVAR CARRO

Código: **11333** Fábrica: **FERREIRA** Unidade: **UN/1**  
**F1 F4**



Produto  
\* Altura: 90 cm  
\* Comp: 187 cm  
\* Largura: 70 cm

ESPREGUICADEIRA PITANGUI BRANCA

Código: **7749** Fábrica: **ANTARES** Unidade: **UN/1**  
**F1 F4**

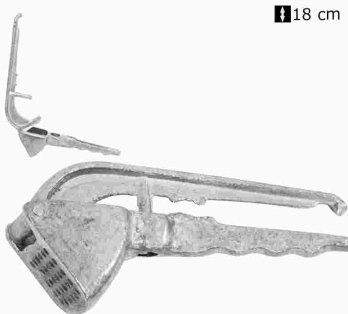

18 cm

ESPREDADOR ALUM INTEIR ALHO BIG 2008 UN

Código: **48034** Fábrica: **COFAX** Unidade: **UN/1**  
**F1 F4**

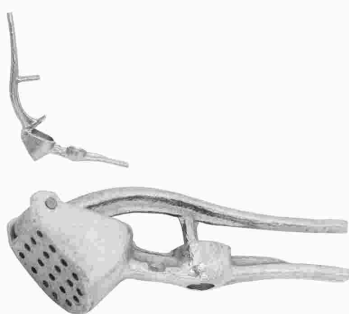

ESPREDADOR ALUM INTEIR ALHO 2F 2030 UN

Código: **48032** Fábrica: **COFAX** Unidade: **UN/1**  
**F1 F4**



7 cm  
9 cm

ESPREDADOR PLAST LARANJA 13X09CM 3174

Código: **40311** Fábrica: **WINCY** Unidade: **UN/1**  
**F1 F4**



ESTACA P/PLANTA FIBRA DE COCO 60X5X5CM

Código: **30295** Fábrica: **NUTRIPLAN** Unidade: **UN/1**  
**F1 F4**



80cm

ESTACA P/PLANTA FIBRA DE COCO 80X5X5CM

Código: **30296** Fábrica: **NUTRIPLAN** Unidade: **UN/1**  
**F1 F4**



Produto  
\* Altura: 128 cm  
\* Largura: 75 cm

ESTANTE MODULAR 4 PRATELEIRAS PRETA

Código: **12899** Fábrica: **ANTARES** Unidade: **UN/1**  
**F1 F4**

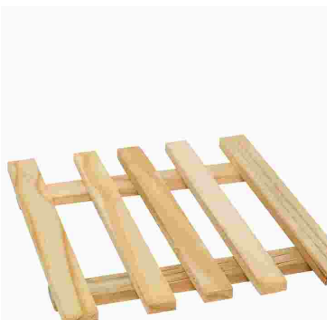

ESTEIRA MADEIRA FIXA 25 CM IND 162

Código: **41323** Fábrica: **MAD LAR** Unidade: **UN/1**  
**F1 F4**



ESTEIRA MADEIRA G 25 CM 156

Código: **41321** Fábrica: **MAD LAR** Unidade: **UN/1**  
**F1 F4**

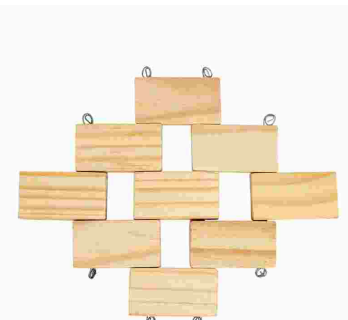

ESTEIRA MADEIRA M 20 CM 157

Código: **41322** Fábrica: **MAD LAR** Unidade: **UN/1**  
**F1 F4**



ESTERCO DE GALINHA 1 LITRO

Código: **48536** Fábrica: **NOVATROPICAL** Unidade: **PT/1**  
**F1 F4**



FAÇA INOX MESA LINHA AMERICA 2224 12X1

Código: **50621** Fábrica: **STEEL** Unidade: **PT/12**  
**F1 F4**



FAÇA ACO CARBONO 3" CB MAD LEGUMES 222

Código: **39348** Fábrica: **PLANETA** Unidade: **CR/1**  
**F1 F4**



23 cm

FACA ACO CARBONO 5" CB MAD 22950/5 12X1  
 Código: 34848 Fábrica: TRAMONTINA Unidade: DZ/12  
 F1 F4



23 cm

FACA ACO CARBONO 5" CB MAD 22953/5 12X1  
 Código: 34847 Fábrica: TRAMONTINA Unidade: DZ/12  
 F1 F4



29 cm

FACA ACO CARBONO 6" CB MAD 22953/6 12X1  
 Código: 34850 Fábrica: TRAMONTINA Unidade: DZ/12  
 F1 F4



FACA ACO CARBONO 6" CB MAD 252  
 Código: 39349 Fábrica: PLANETA Unidade: CR/1  
 F1 F4



26 cm

FACA ACO CARBONO 7" CB MAD 22953/7 12X1  
 Código: 34849 Fábrica: TRAMONTINA Unidade: DZ/12  
 F1 F4



FACA ACO INOX 3" CB PLAST COZINHA 12X1  
 Código: 36919 Fábrica: MABEL Unidade: CX/12  
 F1 F4



18 cm

FACA ACO INOX 3 1/4" CB PLAST LEGUMES  
 Código: 36573 Fábrica: MUNDIAL Unidade: UN/1  
 F1 F4



FACA ACO INOX 5" CB MAD CHURRSACO 6X1  
 Código: 46583 Fábrica: MUNDIAL Unidade: CX/6  
 F1 F4



FACA ACO INOX 5" CB PLAST BCO MAX 53  
 Código: 50100 Fábrica: PLANETA Unidade: CR/1  
 F1 F4



FACA ACO INOX 5" CB PLAST BCO TOMATE  
 Código: 46578 Fábrica: MUNDIAL Unidade: UN/1  
 F1 F4



FACA ACO INOX 5" CB PLAST PTO TOMATE  
 Código: 47376 Fábrica: SIMONAGGIO Unidade: UN/1  
 F1 F4



30 cm

FACA ACO INOX 6" CB PLAST BCO CARNE 815  
 Código: 36575 Fábrica: MUNDIAL Unidade: UN/1  
 F1 F4



FACA ACO INOX 6" CB PLAST BCO COZINHA  
 Código: 37807 Fábrica: NICOBEM Unidade: UN/1  
 F1 F4



27 cm

FACA ACO INOX 6" CB PLAST BCO COZINHA31  
 Código: 36576 Fábrica: MUNDIAL Unidade: UN/1  
 F1 F4



FACA ACO INOX 7" CB PLAST BCO COZINHA  
 Código: 50953 Fábrica: HAI BRASIL Unidade: UN/1  
 F1 F4



FACA ACO INOX 7" CB PLAST BCO MAX 55  
 Código: 47988 Fábrica: PLANETA Unidade: CR/1  
 F1 F4



FACA ACO INOX 7'' CB PLAST PTO CARNE 107  
 Código: **46577** Fábrica: **MUNDIAL** Unidade: **UN/1**  
**F1 F4**

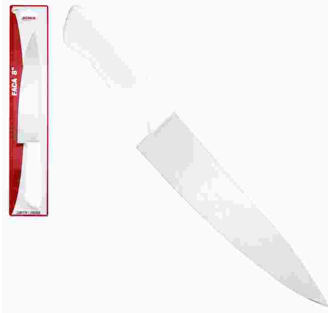

FACA ACO INOX 8'' CB PLAST BCO COZINHA  
 Código: **46492** Fábrica: **NICOBEM** Unidade: **UN/1**  
**F1 F4**



FACA ACO INOX 8'' CB PLAST BCO COZINHA  
 Código: **50945** Fábrica: **HAI BRASIL** Unidade: **UN/1**  
**F1 F4**



FACA ACO INOX 8'' CB PLAST BCO COZINHA31  
 Código: **36579** Fábrica: **MUNDIAL** Unidade: **UN/1**  
**F1 F4** 133 cm



FACA ACO INOX 8'' PAO CB PLAST BCO MAX57  
 Código: **47989** Fábrica: **PLANETA** Unidade: **CR/1**  
**F1 F4**



FACA ACO INOX 9'' CB PLAST BCO COZINHA  
 Código: **50952** Fábrica: **HAI BRASIL** Unidade: **UN/1**  
**F1 F4**



FACA ACO INOX 10'' CB PLAST BCO CARNE 781  
 Código: **36581** Fábrica: **MUNDIAL** Unidade: **UN/1**  
**F1 F4** 139 cm



FACA ACO INOX 10'' CB PLAST BCO CARNE 820  
 Código: **36582** Fábrica: **MUNDIAL** Unidade: **UN/1**  
**F1 F4** 138 cm



FACA ACO 7'' PAO CB PLAST PRETO 6013  
 Código: **44645** Fábrica: **MART/SIMONAG** Unidade: **UN/1**  
**F1 F4**



FACA INOX 5'' CB PLAST BCO COZINHA 3186  
 Código: **49646** Fábrica: **WINMAX** Unidade: **UN/1**  
**F1 F4**



FACA INOX 6'' CB PLAST BCO COZINHA 3187  
 Código: **49647** Fábrica: **WINMAX** Unidade: **UN/1**  
**F1 F4**



FACA INOX 7'' CB PLAST BCO COZINHA 3188  
 Código: **49648** Fábrica: **WINMAX** Unidade: **UN/1**  
**F1 F4**



FACA INOX CHURR 20CM VERSA AZ 731 12X1  
 Código: **50162** Fábrica: **PLANETA** Unidade: **DZ/12**  
**F1 F4**



FACA INOX KIT C/3 PLENUS CB PLAS BCO 312  
 Código: **40391** Fábrica: **TRAMONTINA** Unidade: **CR/1**  
**F1 F4**



FACA INOX KIT C/3 PLENUS CB PLAS PTO 612  
 Código: **40390** Fábrica: **TRAMONTINA** Unidade: **CR/1**  
**F1 F4**



FACA INOX MESA LINHA BRONZE 517 3X1  
 Código: **48008** Fábrica: **PLANETA** Unidade: **PT/3**  
**F1 F4**



FAÇA INOX 3PCS CB PLAST GOLDEN DARK 106  
 Código: 41348 Fábrica: HAUSKRAFT Unidade: CJ/1  
 F1 F4



FAÇA INOX 3,5" LINH MAX LEGUMES CB BC52  
 Código: 47629 Fábrica: PLANETA Unidade: CR/1  
 F1 F4



FAÇA INOX 3,5" LINH MERCOSU LEGUMES 234  
 Código: 46868 Fábrica: PLANETA Unidade: CR/1  
 F1 F4



FAÇA INOX 6" CB PLAST P/DEOSSAR 5421  
 Código: 43277 Fábrica: MAGAGIFT Unidade: CR/1  
 F1 F4



FAÇA INOX 7" CB MAD JATOBA CTL 225  
 Código: 48692 Fábrica: PLANETA Unidade: CR/1  
 F1 F4



FAÇA INOX 7" CB PLAST PROFISSIONAL 5423  
 Código: 43278 Fábrica: MAGAGIFT Unidade: CR/1  
 F1 F4



FAÇA INOX 8" CB MAD JATOBA CTL 226  
 Código: 48693 Fábrica: PLANETA Unidade: CR/1  
 F1 F4



FAÇA PEIXEIRA ACO CARBONO 5" CB MAD 319  
 Código: 44641 Fábrica: SIMONAGGIO Unidade: UN/1  
 F1 F4



FAÇA PEIXEIRA ACO CARBONO 7" CB MAD 321  
 Código: 47375 Fábrica: SIMONAGGIO Unidade: UN/1  
 F1 F4



FAÇA PEIXEIRA ACO CARBONO 8" CB MAD 322  
 Código: 44642 Fábrica: SIMONAGGIO Unidade: UN/1  
 F1 F4



FAÇA PEIXEIRA ACO 7" CB PLAST VM 321007  
 Código: 44644 Fábrica: SIMONAGGIO Unidade: UN/1  
 F1 F4



FAÇA ACO INOX 10" CB MAD 117  
 Código: 45531 Fábrica: WINMAX Unidade: UN/1  
 F1 F4



FAQUEIRO 12 PCS CB PLAST COLOR 80  
 Código: 41064 Fábrica: TAGLIATORI Unidade: CJ/12  
 F1 F4



FAQUEIRO 16 PCS CB PLAST COLOR 318  
 Código: 41065 Fábrica: TAGLIATORI Unidade: CJ/16  
 F1 F4



FAQUEIRO 20 PCS CB PLAST COLOR 313  
 Código: 41063 Fábrica: TAGLIATORI Unidade: CJ/20  
 F1 F4



FAQUEIRO 24 PCS CB PLAST COLOR 115  
 Código: 41062 Fábrica: TAGLIATORI Unidade: CJ/24  
 F1 F4



FAQUEIRO 24 PCS INOX 4829

Código: 49759 Fábrica: SQ Unidade: CJ/24 F1 F4



FAQUEIRO 25 PCS CB PLAST BCO PORTA TALHE

Código: 41337 Fábrica: HAUWKRAFT Unidade: CJ/16 F1 F4



FAQUEIRO 25 PCS CB PLAST PTO PORTA TALHE

Código: 41338 Fábrica: HAUWKRAFT Unidade: CJ/16 F1 F4



FAQUEIRO 25 PCS CB PLAST VM PORTA TALHE

Código: 41339 Fábrica: HAUWKRAFT Unidade: CJ/16 F1 F4



FARINHEIRO PLAST 800 ML LEITOSO 21

Código: 40374 Fábrica: FORMPLAST Unidade: UN/1 F1 F4



FATIADOR INOX PIZZA 18,9CM 8178

Código: 44729 Fábrica: WINCY Unidade: UN/1 F1 F4



FERRAMENTA ACO CB PLAST JARDIM 2X1 74307

Código: 49599 Fábrica: ALMEGA Unidade: CJ/1 F1 F4



FERRAMENTA ESPATULA METAL CB PLAST 3080

Código: 38453 Fábrica: FENIMA Unidade: UN/1 F1 F4



FERRAMENTA PLAST ARRANCADOR 28,6CM VERDE

Código: 47609 Fábrica: NUTRIPLAN Unidade: UN/1 F1 F4



FERRAMENTA PLAST KIT RAST/PA/ARRAN VERDE

Código: 47610 Fábrica: NUTRIPLAN Unidade: CJ/4 F1 F4



FERRAMENTA PLAST PAZINHA ESTR 28CM VERDE

Código: 47608 Fábrica: NUTRIPLAN Unidade: UN/1 F1 F4



FERRAMENTA PLAST PAZINHA 27,5CM VERDE

Código: 47607 Fábrica: NUTRIPLAN Unidade: UN/1 F1 F4



FERRAMENTA PLAST RATELO 24CM VERDE

Código: 47606 Fábrica: NUTRIPLAN Unidade: UN/1 F1 F4



FERRAMENTA TESOURA P/PODA 46CM AIH1239

Código: 42465 Fábrica: AIH Unidade: UN/1 F1 F4



FERRAMENTA TESOURA P/PODA 8" CTL 9165T

Código: 40077 Fábrica: IDEA Unidade: UN/1 F1 F4



FERTILIZANTE CACTOS SUCULENTAS 150GRS CX

Código: 33547 Fábrica: VITAPLAN Unidade: CX/1 F1 F4



FERTILIZANTE COMP ORGANICO JAPONES 800G  
 Código: **39213** Fábrica: **VITAPLAN** Unidade: **CX/1**  
**F1 F4**



FERTILIZANTE FARINHA DE OSSO 1KG C/CX  
 Código: **30303** Fábrica: **VITAPLAN** Unidade: **CX/1**  
**F1 F4**



FERTILIZANTE NUTRIFLORES 250 GRS POTE  
 Código: **39653** Fábrica: **VITAPLAN** Unidade: **CX/1**  
**F1 F4**



FERTILIZANTE NUTRIFLORES 500 GRS POTE  
 Código: **39212** Fábrica: **VITAPLAN** Unidade: **CX/1**  
**F1 F4**



FERTILIZANTE NUTRIFRUTAS 600 GRS POTE  
 Código: **49345** Fábrica: **VITAPLAN** Unidade: **CX/1**  
**F1 F4**



FERTILIZANTE NUTRIPLANTAS 250 GRS POTE  
 Código: **44136** Fábrica: **VITAPLAN** Unidade: **CX/1**  
**F1 F4**



FERTILIZANTE NUTRIPLANTAS 500 GRS POTE  
 Código: **44132** Fábrica: **VITAPLAN** Unidade: **UN/1**  
**F1 F4**



FERTILIZANTE NUTRIVERDE 250 GRS POTE  
 Código: **39654** Fábrica: **VITAPLAN** Unidade: **CX/1**  
**F1 F4**



FERTILIZANTE NUTRIVERDE 500 GRS POTE  
 Código: **23212** Fábrica: **VITAPLAN** Unidade: **CX/1**  
**F1 F4**



FERTILIZANTE NUTRIVERDE 600 GRS POTE  
 Código: **49344** Fábrica: **VITAPLAN** Unidade: **CX/1**  
**F1 F4**



FERTILIZANTE ORQUIDEAS 150 GRS C/CX  
 Código: **22292** Fábrica: **VITAPLAN** Unidade: **UN/1**  
**F1 F4**



FERTILIZANTE SAMAMBAIAS 150 GRS  
 Código: **22291** Fábrica: **VITAPLAN** Unidade: **CX/1**  
**F1 F4**



FERTILIZANTE TORTA MAMONA +FARIN OSSO 1K  
 Código: **30301** Fábrica: **VITAPLAN** Unidade: **CX/1**  
**F1 F4**



FERTILIZANTE VIOLETA 150 GR  
 Código: **22290** Fábrica: **VITAPLAN** Unidade: **CX/1**  
**F1 F4**

11,5 cm  
8,5 cm



FERTILIZANTE 04-14-08 1 KG C/CX  
 Código: **22294** Fábrica: **VITAPLAN** Unidade: **UN/1**  
**F1 F4**



FERTILIZANTE 04-14-08 1 KG SACO  
 Código: **30800** Fábrica: **FAZENDEIRO** Unidade: **KG/1**  
**F1 F4**



FERTILIZANTE 04-14-08 1 KG SACO  
 Código: 30297 Fábrica: VITAPLAN Unidade: UN/1  
 F1 F4

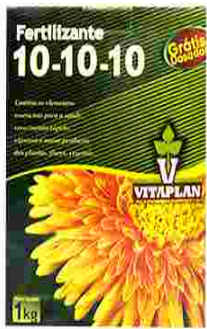

FERTILIZANTE 10-10-10 1 KG C/CX  
 Código: 22293 Fábrica: VITAPLAN Unidade: UN/1  
 F1 F4



FERTILIZANTE 10-10-10 1 KG SACO  
 Código: 30298 Fábrica: VITAPLAN Unidade: UN/1  
 F1 F4



FERVEDOR ALUM LEVE 14 C/ TAMP 1,7 LTS  
 Código: 5895 Fábrica: AVELAR Unidade: UN/1  
 F1 F4



FILME PVC TRANSP 25CMX15M 21752  
 Código: 50077 Fábrica: BOMPACK Unidade: RL/1  
 F1 F4



FILME PVC TRANSP 28CMX100M 23263  
 Código: 50078 Fábrica: BOMPACK Unidade: RL/1  
 F1 F4



FILTRA OLEO ALUM LEVE 1 1,0 LT  
 Código: 36286 Fábrica: AVELAR Unidade: UN/1  
 F1 F4



FILTRA OLEO ALUMINIO 12 673  
 Código: 24782 Fábrica: MSR Unidade: UN/1  
 F1 F4



FILTRO COADOR INOX P/CAFE 103 4380  
 Código: 49758 Fábrica: SQ Unidade: UN/1  
 F1 F4



FILTRO PERMANENTE P/ COAR CAFE 102 12X1  
 Código: 27442 Fábrica: FERREIRA Unidade: DZ/12  
 F1 F4



FILTRO PERMANENTE P/ COAR CAFE 103 12X1  
 Código: 27443 Fábrica: FERREIRA Unidade: DZ/12  
 F1 F4



FLANELA BRANCA 28X38 CM 12X1  
 Código: 34897 Fábrica: MC PANOS Unidade: PT/12  
 F1 F4



FLANELA BRANCA 36X56CM 12X1  
 Código: 34501 Fábrica: P & F Unidade: PT/12  
 F1 F4



FLANELA COLOR 38X58 CM 12X1  
 Código: 42841 Fábrica: MC PANOS Unidade: PT/12  
 F1 F4

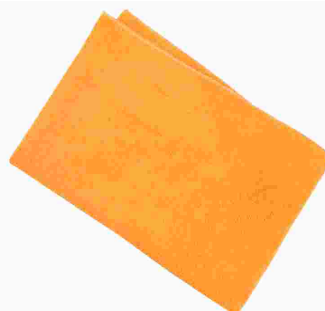

FLANELA MICROFIBRA 50X70 CM COLOR  
 Código: 44155 Fábrica: MC PANOS Unidade: UN/1  
 F1 F4



FORMA ALUM BOLO ALTA 01 1966  
 Código: 37514 Fábrica: MSR Unidade: UN/1  
 F1 F4



FORMA ALUM BOLO ALTA 02 1967

Código: **37515** Fábrica: **MSR** Unidade: **UN/1**  
**F1 F4**



FORMA ALUM BOLO ALTA 03 1968

Código: **37516** Fábrica: **MSR** Unidade: **UN/1**  
**F1 F4**



FORMA ALUM CB MAD BAURUTEX OVAL 2014 UN

Código: **48073** Fábrica: **COFAX** Unidade: **UN/1**  
**F1 F4**



FORMA ALUM EMPADA CRESPA 2 009 CTL 12X1

Código: **41356** Fábrica: **WESTERN** Unidade: **CR/12**  
**F1 F4**



FORMA ALUM EMPADA LISA 0 12X1

Código: **36896** Fábrica: **MABEL** Unidade: **DZ/12**  
**F1 F4**



FORMA ALUM EMPADA LISA 00 12X1

Código: **44386** Fábrica: **DAMIAO** Unidade: **DZ/12**  
**F1 F4**



FORMA ALUM EMPADA LISA 1 CTL 011 12X1

Código: **41357** Fábrica: **WESTERN** Unidade: **CR/12**  
**F1 F4**



FORMA ALUM EMPADA LISA 1 12X1

Código: **44388** Fábrica: **DAMIAO** Unidade: **DZ/12**  
**F1 F4**



FORMA ALUM EMPADA LISA 2 CTL 012 12X1

Código: **41355** Fábrica: **WESTERN** Unidade: **CR/12**  
**F1 F4**



FORMA ALUM EMPADA LISA 2 12X1

Código: **44389** Fábrica: **DAMIAO** Unidade: **DZ/12**  
**F1 F4**



FORMA ALUM EMPADA LISA 3 12X1

Código: **44390** Fábrica: **DAMIAO** Unidade: **DZ/12**  
**F1 F4**



FORMA ALUM EMPADA LISA 3 6X1

Código: **41448** Fábrica: **MABEL** Unidade: **PT/6**  
**F1 F4**



FORMA ALUM EMPADA LISA 4 12X1

Código: **44391** Fábrica: **DAMIAO** Unidade: **DZ/12**  
**F1 F4**



FORMA ALUM EMPADA LISA 5 12X1

Código: **44392** Fábrica: **DAMIAO** Unidade: **DZ/12**  
**F1 F4**



FORMA ALUM EMPADA LISA 6 12X1

Código: **25554** Fábrica: **DAMIAO** Unidade: **DZ/12**  
**F1 F4**



FORMA ALUM EMPADA LISA 7 12X1

Código: **38505** Fábrica: **DAMIAO** Unidade: **DZ/12**  
**F1 F4**



FORMA ALUM FDO REMOV 23/26/28CM 710 3X1  
 Código: 41250 Fábrica: 123UTIL Unidade: CX/3  
 F1 F4



FORMA ALUM LEVE PIZZA 30  
 Código: 5900 Fábrica: AVELAR Unidade: UN/1  
 F1 F4



FORMA ALUM LEVE PUDIM 18  
 Código: 27867 Fábrica: AVELAR Unidade: UN/1  
 F1 F4



FORMA ALUM LEVE TORTA 24  
 Código: 5901 Fábrica: AVELAR Unidade: UN/1  
 F1 F4



FORMA ALUM PAO 01 1253  
 Código: 37256 Fábrica: MSR Unidade: UN/1  
 F1 F4



FORMA ALUM PAO 02 1254  
 Código: 37255 Fábrica: MSR Unidade: UN/1  
 F1 F4



FORMA ALUM PAO 03 1255  
 Código: 37448 Fábrica: MSR Unidade: UN/1  
 F1 F4



FORMA ALUM PIZZA MINI 12 CM 696  
 Código: 37528 Fábrica: MSR Unidade: UN/1  
 F1 F4



FORMA ALUM PIZZA 25 1229  
 Código: 35274 Fábrica: MSR Unidade: UN/1  
 F1 F4



FORMA ALUM PIZZA 30 675  
 Código: 25308 Fábrica: MSR Unidade: UN/1  
 F1 F4



FORMA ALUM PIZZA 35 674  
 Código: 20736 Fábrica: MSR Unidade: UN/1  
 F1 F4



FORMA ALUM POLIDO 22 BOLO VITORIA  
 Código: 48127 Fábrica: ALEGRETE Unidade: UN/1  
 F1 F4



FORMA ALUM PUDIM 12 MINI 1955  
 Código: 37524 Fábrica: MSR Unidade: UN/1  
 F1 F4



FORMA ALUM PUDIM 16 679  
 Código: 24364 Fábrica: MSR Unidade: UN/1  
 F1 F4



FORMA ALUM PUDIM 18 680  
 Código: 24363 Fábrica: MSR Unidade: UN/1  
 F1 F4



FORMA ALUM PUDIM 20 681  
 Código: 24362 Fábrica: MSR Unidade: UN/1  
 F1 F4



FORMA ALUM PUDIM 22 682

Código: **24361** Fábrica: **MSR** Unidade: **UN/1**  
F1 F4



FORMA ALUM PUDIM 26 1969

Código: **37522** Fábrica: **MSR** Unidade: **UN/1**  
F1 F4



FORMA ALUM TORTA 25 676

Código: **8236** Fábrica: **MSR** Unidade: **UN/1**  
F1 F4



FORMA ALUM TORTA 30 677

Código: **22730** Fábrica: **MSR** Unidade: **UN/1**  
F1 F4



FORMA ALUM TORTA 35 678

Código: **8238** Fábrica: **MSR** Unidade: **UN/1**  
F1 F4

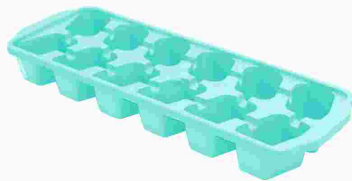

FORMA PLAST GELO COLOR 151

Código: **12666** Fábrica: **FORMPLAST** Unidade: **UN/1**  
F1 F4



FORMA PLAST GELO TRANSP FAFILLITA 6211

Código: **20713** Fábrica: **RISCHIOTO** Unidade: **UN/1**  
F1 F4

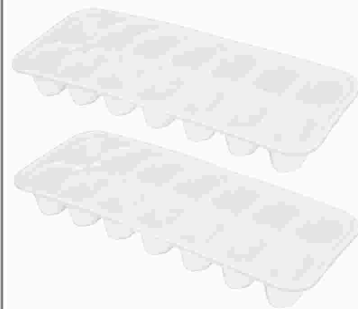

FORMA PLAST GELO 3105 2X1

Código: **47056** Fábrica: **JAGUAR** Unidade: **CJ/2**  
F1 F4

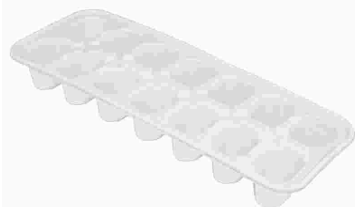

FORMA PLAST GELO 615

Código: **9986** Fábrica: **JAGUAR** Unidade: **UN/1**  
F1 F4



FORMA PLAST GELO 6626 2X1

Código: **22501** Fábrica: **INPLAST** Unidade: **CJ/2**  
F1 F4

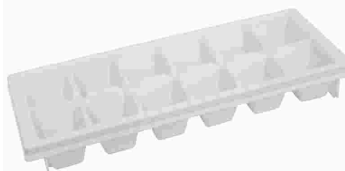

FORMA PLAST P/GELO 502

Código: **35497** Fábrica: **TRITEC** Unidade: **UN/1**  
F1 F4



FORMINHA INOX CORTADOR COOKIE 12X1

Código: **40525** Fábrica: **MINGJIAN** Unidade: **DZ/12**  
F1 F4



FORRO MESA LAMINADO 50M 614 0,10MM CRIST

Código: **39358** Fábrica: **PERFETTO** Unidade: **RL/1**  
F1 F4



FORRO MESA LAMINADO 50M 617 CRISTAL OUTO

Código: **39359** Fábrica: **PERFETTO** Unidade: **RL/1**  
F1 F4

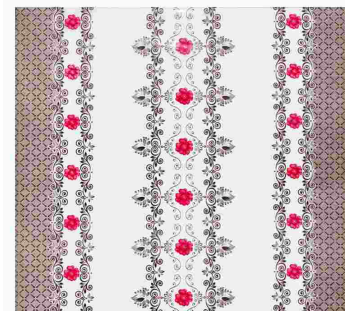

FORRO MESA LAMINADO 50M 619 CRISTAL HIBI

Código: **39360** Fábrica: **PERFETTO** Unidade: **RL/1**  
F1 F4

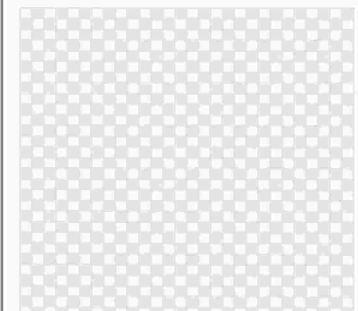

FORRO MESA LAMINADO 50M 623 CRISTAL XADR

Código: **39964** Fábrica: **PERFETTO** Unidade: **RL/1**  
F1 F4

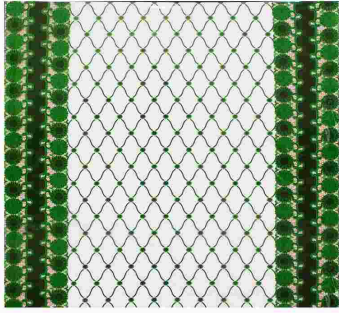

FORRO MESA LAMINADO 50M 626 CRISTAL FLOX  
 Código: 39963 Fábrica: PERFETTO Unidade: RL/1  
 F1 F4

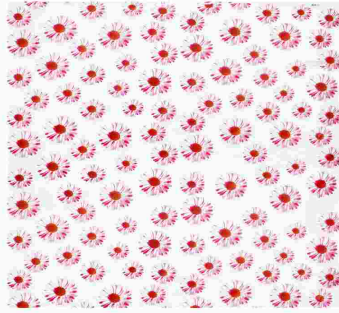

FORRO MESA LAMINADO 50M 659 CRISTAL MARG  
 Código: 39361 Fábrica: PERFETTO Unidade: RL/1  
 F1 F4

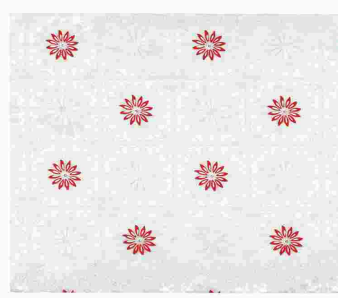

FORRO MESA LAMINADO 50M 663 CRISTAL FLOR  
 Código: 39362 Fábrica: PERFETTO Unidade: RL/1  
 F1 F4

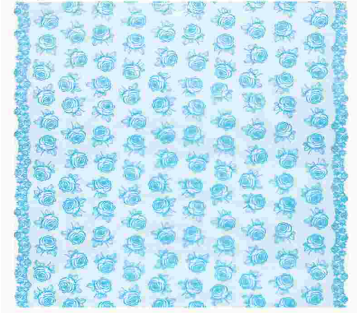

FORRO MESA LAMINADO 50M 665 CRISTAL ROSA  
 Código: 44661 Fábrica: PERFETTO Unidade: RL/1  
 F1 F4

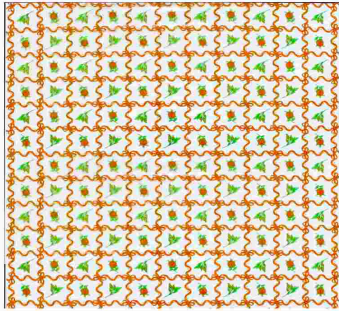

FORRO MESA LAMINADO 50M 669 CRISTAL FLOR  
 Código: 44659 Fábrica: PERFETTO Unidade: RL/1  
 F1 F4

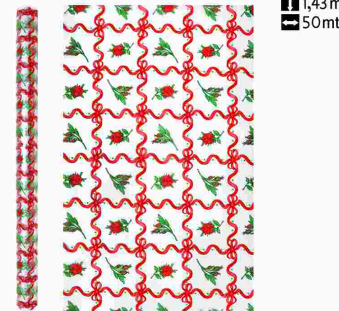

FORRO MESA LAMINADO 50M 670 CRISTAL LACO  
 Código: 39363 Fábrica: PERFETTO Unidade: RL/1  
 F1 F4

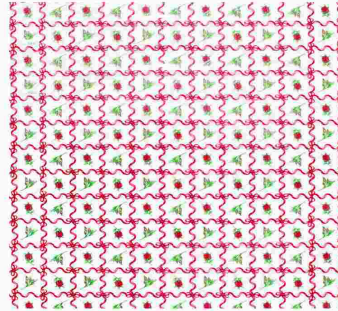

FORRO MESA LAMINADO 50M 670/1 XAD VERMEL  
 Código: 48662 Fábrica: PERFETTO Unidade: RL/1  
 F1 F4



FORRO MESA LAMINADO 50M 694 0,15MM CRIST  
 Código: 42507 Fábrica: PERFETTO Unidade: RL/1  
 F1 F4



FORRO MESA PEQ TERMICO 1,40X1,40CM T  
 Código: 14558 Fábrica: FERREIRA Unidade: UN/1  
 F1 F4



FORRO MESA TERMICO 30M 902 FLORAL ROSAS  
 Código: 39365 Fábrica: PERFETTO Unidade: RL/30  
 F1 F4



FORRO MESA TERMICO 30M 912 FLORAL MARIA  
 Código: 39366 Fábrica: PERFETTO Unidade: RL/30  
 F1 F4



FORRO MESA TERMICO 30M 1024 PONTO CRUZ M  
 Código: 40814 Fábrica: PERFETTO Unidade: RL/30  
 F1 F4



FORRO MESA TERMICO 30M 1107 VASO CORACAO  
 Código: 40815 Fábrica: PERFETTO Unidade: RL/30  
 F1 F4



FORRO MESA TERMICO 30M 1113 CAFE JADE  
 Código: 40816 Fábrica: PERFETTO Unidade: RL/30  
 F1 F4



FORRO MESA TERMICO 30M 1114 CAFE HOTENSI  
 Código: 42504 Fábrica: PERFETTO Unidade: RL/30  
 F1 F4



FORRO MESA TERMICO 30M 1115 GIRASSOL MAR  
 Código: 40817 Fábrica: PERFETTO Unidade: RL/30  
 F1 F4



FORRO MESA TERMICO 30M 1121 BANANEIRA PI  
 Código: 42498 Fábrica: PERFETTO Unidade: RL/30  
 F1 F4



FORRO MESA TERMICO 30M 1125 3 ESTACOES  
 Código: 42494 Fábrica: PERFETTO Unidade: RL/30  
 F1 F4



FORRO MESA TERMICO 30M 1128 LISTR HORTEN  
 Código: 44658 Fábrica: PERFETTO Unidade: RL/30  
 F1 F4



FORRO MESA TERMICO 30M 1133 BARRAD RENDA  
 Código: 47098 Fábrica: PERFETTO Unidade: RL/30  
 F1 F4

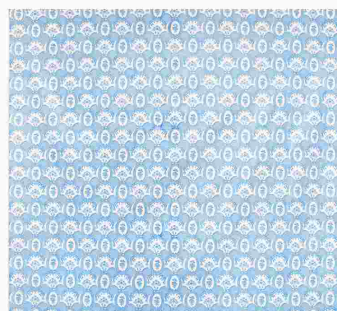

FORRO MESA TERMICO 30M 1137 RENDA AZULEJ  
 Código: 47096 Fábrica: PERFETTO Unidade: RL/30  
 F1 F4



FORRO MESA TERMICO 30M 1172 BUQUE FLORAL  
 Código: 47100 Fábrica: PERFETTO Unidade: RL/30  
 F1 F4



FORRO MESA TERMICO 30M 1176 JARRO TERRAC  
 Código: 39966 Fábrica: PERFETTO Unidade: RL/30  
 F1 F4



FORRO PAPEL P/AIR FRYER QUAD 130G 50X1  
 Código: 45908 Fábrica: WINMAX Unidade: PT/50  
 F1 F4



FORRO PAPEL P/AIR FRYER RED 111G 50X1  
 Código: 45907 Fábrica: WINMAX Unidade: PT/50  
 F1 F4



FRASCO PLAST 200 ML C/TAMPA (GARRAFA)  
 Código: 51074 Fábrica: DECOPLAST Unidade: UN/1  
 F1 F4



FRASCO PLAST 300 ML C/TAMPA (GARRAFA)  
 Código: 40505 Fábrica: ARBRA Unidade: UN/1  
 F1 F4



FRIGIDEIRA ALUM EXTRA FORTE 20 683  
 Código: 8490 Fábrica: MSR Unidade: UN/1  
 F1 F4



FRIGIDEIRA ALUM EXTRA FORTE 22 684  
 Código: 8241 Fábrica: MSR Unidade: UN/1  
 F1 F4



FRIGIDEIRA ALUM FRANCESA 18 PRIME 1557  
 Código: 45291 Fábrica: MSR Unidade: UN/1  
 F1 F4



FRIGIDEIRA ALUM FRANCESA 20 PRIME 1560  
 Código: 45287 Fábrica: MSR Unidade: UN/1  
 F1 F4



FRIGIDEIRA ALUM FRANCESA 22 ANTI IN 2547  
 Código: 45286 Fábrica: MSR Unidade: UN/1  
 F1 F4



FRIGIDEIRA ALUM FRANCESA 22 PRIME 1563  
 Código: 45290 Fábrica: MSR Unidade: UN/1  
 F1 F4



FRIGIDEIRA ALUM FRANCESA 24 ANTI IN 2548  
 Código: 45285 Fábrica: MSR Unidade: UN/1  
 F1 F4



FRIGIDEIRA ALUM FRANCESA 24 PRIME 1566  
 Código: 45289 Fábrica: MSR Unidade: UN/1  
 F1 F4



FRIGIDEIRA ALUM LEVE 16 685  
 Código: 35268 Fábrica: MSR Unidade: UN/1  
 F1 F4



FRIGIDEIRA ALUM LEVE 20 S/TAMPA 1,3LTS  
 Código: 5898 Fábrica: AVELAR Unidade: UN/1  
 F1 F4



FRIGIDEIRA ALUM 34 TOP QUALI FRANC CINZA  
 Código: 48121 Fábrica: ALEGRETE Unidade: UN/1  
 F1 F4



FRITURAMA CROM P/FRIGIDEIRA 116  
 Código: 28963 Fábrica: ARAMINAS Unidade: UN/1  
 F1 F4



FRITURAMA CROM REDONDA 15 42  
 Código: 28970 Fábrica: ARAMINAS Unidade: UN/1  
 F1 F4



FRITURAMA CROM REDONDA 20 43  
 Código: 28971 Fábrica: ARAMINAS Unidade: UN/1  
 F1 F4



FRITURAMA CROM REDONDA 25 44  
 Código: 28972 Fábrica: ARAMINAS Unidade: UN/1  
 F1 F4



FRITURAMA CROM REDONDA 30 45  
 Código: 28973 Fábrica: ARAMINAS Unidade: UN/1  
 F1 F4



FRUTEIRA CROM DE MESA 367  
 Código: 28956 Fábrica: ARAMINAS Unidade: UN/1  
 F1 F4



FRUTEIRA CROM RED 1 ANDAR 2378  
 Código: 40250 Fábrica: ARAMIG Unidade: UN/1  
 F1 F4



FRUTEIRA CROM RED 2 ANDARES 2377  
 Código: 40245 Fábrica: ARAMIG Unidade: UN/1  
 F1 F4



FRUTEIRA REF 119 32 CM  
 Código: 12128 Fábrica: PARAMOUNT Unidade: UN/1  
 F1 F4



FUMO P/PLANTA LIQUIDO 500 ML  
 Código: 30300 Fábrica: VITAPLAN Unidade: UN/1  
 F1 F4



FUMO P/PLANTA PO 400 GRS  
 Código: **30299** Fábrica: **VITAPLAN** Unidade: **CX/1**  
**F1 F4**



FUNIL PLAST 10 CM DIAM 5016 12X1  
 Código: **15315** Fábrica: **SBRISSA** Unidade: **DZ/12**  
**F1 F4**



FUNIL PLAST 12,5X25CM C/PENEIRA 0621  
 Código: **44505** Fábrica: **PLANETA** Unidade: **UN/1**  
**F1 F4**



FUNIL PLAST 15 CM DIAM C/PENEIRA 0622  
 Código: **44504** Fábrica: **PLANETA** Unidade: **UN/1**  
**F1 F4**



FUNIL PLAST 4" C/PENEIRA BICO FLEX 1473  
 Código: **51039** Fábrica: **BESTFER** Unidade: **UN/1**  
**F1 F4**



FUNIL PLASTICO 10 CM DIAM 32020  
 Código: **38425** Fábrica: **ALMEGA** Unidade: **UN/1**  
**F1 F4**



FUNIL PLASTICO 3PCS 9,5X8X6,5CM 13784  
 Código: **34443** Fábrica: **ALIANCA** Unidade: **CJ/1**  
**F1 F4**



FURA COCO INOX 10CM 1009 12X1  
 Código: **33291** Fábrica: **JWC** Unidade: **DZ/12**  
**F1 F4**



GANCHEIRA P/VASSOURAS 1521  
 Código: **12908** Fábrica: **CONDOR** Unidade: **UN/1**  
**F1 F4**



GANCHO CROM ACOUGUE 01 141  
 Código: **49013** Fábrica: **ARAMINAS** Unidade: **UN/1**  
**F1 F4**



GANCHO CROM ACOUGUE 02 140  
 Código: **49014** Fábrica: **ARAMINAS** Unidade: **UN/1**  
**F1 F4**



GANCHO CROM ACOUGUE 03 181  
 Código: **49015** Fábrica: **ARAMINAS** Unidade: **UN/1**  
**F1 F4**



GANCHO CROM ACOUGUE 04 182  
 Código: **48403** Fábrica: **ARAMINAS** Unidade: **UN/1**  
**F1 F4**



















GANCHO DECORATIVO MDF 13X9,5CM 804  
 Código: **40906** Fábrica: **FUTURO** Unidade: **UN/1**  
**F1 F4**



GANCHO PLAST C/VENTOSA 8 PCS 56045  
 Código: **40809** Fábrica: **BLESSED** Unidade: **CJ/1**  
**F1 F4**



GARFO ALUM BATIDO 30CM 2642  
 Código: **45296** Fábrica: **MSR** Unidade: **UN/1**  
**F1 F4**

 <p>GARFO ALUM FUNDIDO 30CM Código: <b>32525</b> Fábrica: <b>AVELAR</b> Unidade: <b>UN/1</b> <b>F1 F4</b></p>	 <p>GARFO ALUM INTERICO 28CM 12X1 Código: <b>41834</b> Fábrica: <b>COFAX</b> Unidade: <b>PT/6</b> <b>F1 F4</b></p>	 <p>GARFO ALUM 28CM CB MAD 2004 UN Código: <b>48074</b> Fábrica: <b>COFAX</b> Unidade: <b>UN/1</b> <b>F1 F4</b></p>	 <p><b>1</b> 35 cm GARFO CROM CABO MADEIRA 35 0050 Código: <b>40256</b> Fábrica: <b>ARAMINAS</b> Unidade: <b>UN/1</b> <b>F1 F4</b></p>
 <p><b>1</b> 45 cm GARFO CROM CABO MADEIRA 45 0051 Código: <b>40257</b> Fábrica: <b>ARAMINAS</b> Unidade: <b>UN/1</b> <b>F1 F4</b></p>	 <p><b>1</b> 55 cm GARFO CROM CABO MADEIRA 55 0052 Código: <b>40258</b> Fábrica: <b>ARAMINAS</b> Unidade: <b>UN/1</b> <b>F1 F4</b></p>	 <p>GARFO INOX MESA LINHA AMERICA 2221 12X1 Código: <b>50622</b> Fábrica: <b>STEEL</b> Unidade: <b>PT/12</b> <b>F1 F4</b></p>	 <p>GARFO INOX MESA UNIVERSO 2047 6X1 Código: <b>50137</b> Fábrica: <b>GP6</b> Unidade: <b>PT/6</b> <b>F1 F4</b></p>
 <p>GARFO INOX MESA 19CM VERS PTO 952 12X1 Código: <b>50161</b> Fábrica: <b>PLANETA</b> Unidade: <b>DZ/12</b> <b>F1 F4</b></p>	 <p>GARFO PLASTICO 402 12X1 Código: <b>10957</b> Fábrica: <b>ECOPLASTIC</b> Unidade: <b>DZ/12</b> <b>F1 F4</b></p>	 <p>GARRAFA INOX TERM 500ML DIGITAL LED 2117 Código: <b>41450</b> Fábrica: <b>EXCALIBUR</b> Unidade: <b>UN/1</b> <b>F1 F4</b></p>	 <p>GARRAFA INOX TERM 650ML 803-16 Código: <b>40670</b> Fábrica: <b>CASA ONZE</b> Unidade: <b>UN/1</b> <b>F1 F4</b></p>
 <p>GARRAFA PLAST 1,0 LT COLOR RED 840 Código: <b>35838</b> Fábrica: <b>LUMAR</b> Unidade: <b>UN/1</b> <b>F1 F4</b></p>	 <p>GARRAFA PLAST 1,0 LT COLOR RET 841 Código: <b>35839</b> Fábrica: <b>LUMAR</b> Unidade: <b>UN/1</b> <b>F1 F4</b></p>	 <p>GARRAFA PLAST 1,1 LTS AGUA 1092 Código: <b>33025</b> Fábrica: <b>TRITEC</b> Unidade: <b>UN/1</b> <b>F1 F4</b></p>	 <p><b>1</b> 1,5lts GARRAFA PLAST 1,5 LTS AGUA 1470 Código: <b>47061</b> Fábrica: <b>JAGUAR</b> Unidade: <b>UN/1</b> <b>F1 F4</b></p>



GARRAFA PLAST 1,5 LTS COLOR 812

Código: **35833** Fábrica: **LUMAR** Unidade: **UN/1**  
**F1 F4**



GARRAFA PLAST 1,5 LTS TRANSP 810

Código: **35834** Fábrica: **LUMAR** Unidade: **UN/1**  
**F1 F4**

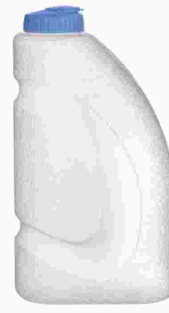

GARRAFA PLAST 2,0 LTS AGUA 697

Código: **33030** Fábrica: **TRITEC** Unidade: **UN/1**  
**F1 F4**



GARRAFA PLAST 2,0 LTS COLOR 813

Código: **35837** Fábrica: **LUMAR** Unidade: **UN/1**  
**F1 F4**



GARRAFA PLAST 2,0 LTS TRANSP 809

Código: **35836** Fábrica: **LUMAR** Unidade: **UN/1**  
**F1 F4**



3,2lts

GARRAFA PLAST 3,2 LTS RET C/TPA 3003

Código: **47064** Fábrica: **JAGUAR** Unidade: **UN/1**  
**F1 F4**



750ml

GARRAFA PLAST 750ML AGUA 1469

Código: **47060** Fábrica: **JAGUAR** Unidade: **UN/1**  
**F1 F4**



GARRAFA TERM 1LT BCA C/TAMPA COLOR 41458

Código: **41458** Fábrica: **MABEL** Unidade: **UN/1**  
**F1 F4**



GARRAFA TERM 500ML EMB CRUZEIRO 2913

Código: **39043** Fábrica: **BRASFOOT** Unidade: **UN/1**  
**F1 F4**



GARRAFA TERMICA 1 LT COLOR C/4 CANECAS

Código: **49733** Fábrica: **FUTURO CASA** Unidade: **UN/1**  
**F1 F4**



GARRAFA TERMICA 1 LT LOTUS COLOR

Código: **44784** Fábrica: **SOPRANO** Unidade: **UN/1**  
**F1 F4**



GARRAFA TERMICA 1 LT PRETO 6X1

Código: **36732** Fábrica: **INVICTA** Unidade: **CX/6**  
**F1 F4**

CORES



GARRAFA TERMICA 1 LT SONETO FEN SORT 6X1

Código: **45638** Fábrica: **SOPRANO** Unidade: **CX/6**  
**F1 F4**



GARRAFA TERMICA 1L INOX 965

Código: **50229** Fábrica: **FUTURO** Unidade: **UN/1**  
**F1 F4**



GARRAFA TERMICA 1L SAMOA AZUL 9397

Código: **51139** Fábrica: **GP6** Unidade: **UN/1**  
**F1 F4**



GARRAFA TERMICA 1,9L ACO 12418

Código: **46248** Fábrica: **CASITA** Unidade: **UN/1**  
**F1 F4**



GARRAFA TERMICA 1,9L INOX 12482

Código: 47313  
 Fábrica: CASITA  
 Unidade: UN/1  
 F1 F4



GARRAFA TERMICA 1,9L INOX 14X25CM 12489

Código: 50214  
 Fábrica: CASITA  
 Unidade: UN/1  
 F1 F4



GARRAFA TERMICA 500ML NEO EMB ATLETICO

Código: 39044  
 Fábrica: BRASFOOT  
 Unidade: UN/1  
 F1 F4



GARRAFA VIDRO 460ML C/CANUDO PLAST 16015

Código: 47899  
 Fábrica: CASITA  
 Unidade: UN/1  
 F1 F4



CORES

GARRAFA 1L SPORT PLAST COLOR 4101

Código: 42767  
 Fábrica: DITTOY  
 Unidade: UN/1  
 F1 F4



CORES

GARRAFA 500 ML GALAO PLAST COLOR 4014

Código: 42770  
 Fábrica: DITTOY  
 Unidade: UN/1  
 F1 F4



CORES

GARRAFA 500 ML SPORT PLAST COLOR 4103

Código: 42776  
 Fábrica: DITTOY  
 Unidade: UN/1  
 F1 F4



3 lts

GARRAFAO TERMICO 3 LTS AZUL

Código: 40035  
 Fábrica: ANTARES  
 Unidade: UN/1  
 F1 F4



GARRAFAO TERMICO 3 LTS VERMELHO

Código: 49919  
 Fábrica: ANTARES  
 Unidade: UN/1  
 F1 F4



5 lts

GARRAFAO TERMICO 5 LTS VERMELHO

Código: 40170  
 Fábrica: ANTARES  
 Unidade: UN/1  
 F1 F4



GRELHA DOBRAVEL ABAULADA 01 PQ 58X17CM

Código: 24062  
 Fábrica: ARAMINAS  
 Unidade: UN/1  
 F1 F4



GRELHA DOBRAVEL ABAULADA 02 MED 65X21CM

Código: 24063  
 Fábrica: ARAMINAS  
 Unidade: UN/1  
 F1 F4



GRELHA DOBRAVEL ABAULADA 03 GDE 74X26CM

Código: 24064  
 Fábrica: ARAMINAS  
 Unidade: UN/1  
 F1 F4



GRELHA DOBRAVEL RETA 01 PQ 58X17CM

Código: 24065  
 Fábrica: ARAMINAS  
 Unidade: UN/1  
 F1 F4



GRELHA DOBRAVEL RETA 02 MED 65X21CM

Código: 24066  
 Fábrica: ARAMINAS  
 Unidade: UN/1  
 F1 F4

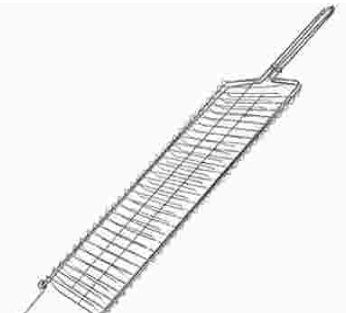

GRELHA DOBRAVEL RETA 03 GDE 74X26CM

Código: 24067  
 Fábrica: ARAMINAS  
 Unidade: UN/1  
 F1 F4



GUARDA SOL 1,80X2,0 MTS  
 Código: 32361 Fábrica: ANTARES Unidade: UN/1  
 F1 F4

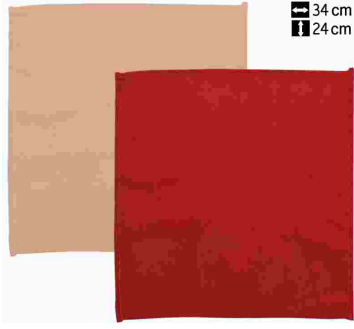

GUARDANAPO PANO LISO 34X24CM 1150 9X1  
 Código: 40449 Fábrica: SUN WELLS Unidade: PT/9  
 F1 F4



GUARDANAPO PAPEL 14X13CM C/500 4X1  
 Código: 40581 Fábrica: PANTANAL Unidade: PT/2000  
 F1 F4



GUARDANAPO PAPEL 22,5X20CM 50X1  
 Código: 47275 Fábrica: DOURADAO Unidade: PT/50  
 F1 F4



GUARDANAPO PAPEL 32,5X30CM 50X1  
 Código: 47263 Fábrica: DOURADAO Unidade: PT/50  
 F1 F4



GUIA PET 3 MTS 13345  
 Código: 39245 Fábrica: ALIANCA Unidade: UN/1  
 F1 F4



HASTE PLAST P/VASO 40 CM MARRON  
 Código: 39215 Fábrica: NUTRIPLAN Unidade: UN/1  
 F1 F4



HASTE PLAST P/VASO 40 CM PRETA  
 Código: 39214 Fábrica: NUTRIPLAN Unidade: UN/1  
 F1 F4



HUMUS DE MINHOCA 10 KG  
 Código: 30088 Fábrica: NOVATROPICAL Unidade: PT/1  
 F1 F4



JARDINEIRA ELEGANCE AUTOIRR 01 VERDE NEON  
 Código: 42167 Fábrica: NUTRIPLAN Unidade: UN/1  
 F1 F4



JARDINEIRA ELEGANCE AUTOIRR 01 CAFE IMP  
 Código: 36202 Fábrica: NUTRIPLAN Unidade: UN/1  
 F1 F4



JARDINEIRA ELEGANCE AUTOIRR 01 VINHO IMP  
 Código: 42166 Fábrica: NUTRIPLAN Unidade: UN/1  
 F1 F4



JARRA PLAST 1,0 LT C/ ESPREM COLOR 4032  
 Código: 17401 Fábrica: SBRISSA Unidade: UN/1  
 F1 F4



JARRA PLAST 1,0 LT GRAD C/ESP TRANSP4031  
 Código: 44234 Fábrica: SBRISSA Unidade: UN/1  
 F1 F4



JARRA PLAST 1,0 LT GRADUADA CORES 4010  
 Código: 17980 Fábrica: SBRISSA Unidade: UN/1  
 F1 F4



JARRA PLAST 1,0 LT GRADUADA TRANSP 4004  
 Código: 18714 Fábrica: SBRISSA Unidade: UN/1  
 F1 F4



JARRA PLAST 1,0 LT GRADUADA 866 UN  
 Código: 49483 Fábrica: TRITEC Unidade: UN/1 F1 F4



JARRA PLAST 1,5 LT RED C/TPA 6606  
 Código: 11211 Fábrica: INPLAST Unidade: UN/1 F1 F4



JARRA PLAST 1,5 LTS TRANSP 814  
 Código: 35841 Fábrica: LUMAR Unidade: UN/1 F1 F4



JARRA PLAST 2,1 LT QUAD C/TPA 6652  
 Código: 20146 Fábrica: INPLAST Unidade: UN/1 F1 F4



JARRA PLAST 2,0 LT QD C/TPA 0078  
 Código: 4462 Fábrica: JAGUAR Unidade: UN/1 F1 F4

2lts



JARRA PLAST 2,5 LTS TRANSP TPA COLOR 863  
 Código: 46674 Fábrica: LUMAR Unidade: UN/1 F1 F4

23cm  
2,5lts



JARRA PLAST 2,5LTS RED NOVELLE 6071  
 Código: 46798 Fábrica: RISCHIOTO Unidade: UN/1 F1 F4

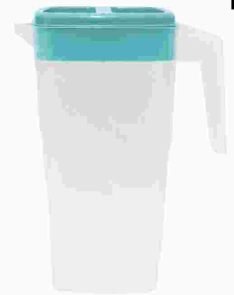

JARRA PLAST 3,3 LTS QUAD C/TPA 0002  
 Código: 18920 Fábrica: JAGUAR Unidade: UN/1 F1 F4

3,3lts



JARRA PLAST 3,7 LTS RED C/TPA 1565  
 Código: 4723 Fábrica: JAGUAR Unidade: UN/1 F1 F4

3,7lts



JARRA PLAST 3,8 LTS AQUARELA C/TPA 6814  
 Código: 41670 Fábrica: INPLAST Unidade: UN/1 F1 F4

JARRA PLAST 3,8 LTS TRANSP C/TPA 6813  
 Código: 41666 Fábrica: INPLAST Unidade: UN/1 F1 F4



JARRA PLAST 4,0 LT TRANSP C/TAMPA 398  
 Código: 33026 Fábrica: TRITEC Unidade: UN/1 F1 F4



JARRA VIDRO 1L P/CANTO GELADEIRA 234  
 Código: 47325 Fábrica: NIX Unidade: UN/1 F1 F4



JARRA VIDRO 1,1 LTS TPA PLAST C/CX 7694  
 Código: 47354 Fábrica: ALTIHOME Unidade: UN/1 F1 F4



JARRA VIDRO 1,1 LTS TPA PLAST C/CX 7695  
 Código: 47356 Fábrica: ALTIHOME Unidade: UN/1 F1 F4



JARRA VIDRO 1,1 LTS TPA PLAST FC019  
 Código: 49439 Fábrica: SATYAM Unidade: UN/1 F1 F4





JARRA VIDRO 1,1 LTS TPA PLAST FC020  
 Código: 49440 Fábrica: SATYAM Unidade: UN/1  
 F1 F4



JARRA VIDRO 1,1 LTS TRANSP TPA PLAST 016  
 Código: 50805 Fábrica: SATYAM Unidade: UN/1  
 F1 F4



JARRA VIDRO 1,1 LTS TRANSP TPA PLAST 017  
 Código: 50804 Fábrica: SATYAM Unidade: UN/1  
 F1 F4



JARRA VIDRO 1,6 LTS C/TPA PLAST 1090  
 Código: 49481 Fábrica: LEHAVI Unidade: UN/1  
 F1 F4



JARRA VIDRO 1,8 LTS C/TPA PLAST 1091  
 Código: 49482 Fábrica: LEHAVI Unidade: UN/1  
 F1 F4



JARRA VIDRO 1,8 LTS TRANSP C/TPA ACR 026  
 Código: 50803 Fábrica: PRATIBELLA Unidade: UN/1  
 F1 F4



JARRA VIDRO 1,8 LTS TRANSP C/TPA ACR 156  
 Código: 49801 Fábrica: FUTURO Unidade: UN/1  
 F1 F4



JARRA VIDRO 1,8 LTS TRANSP C/TPA ACR 157  
 Código: 49799 Fábrica: FUTURO Unidade: UN/1  
 F1 F4



JARRA 1,8 LT TRANSP C/TPA 4000  
 Código: 17979 Fábrica: SBRISSA Unidade: UN/1  
 F1 F4



JARRA 1,8 LT TRANSP DEC C/TPA 8013  
 Código: 35219 Fábrica: SBRISSA Unidade: UN/1  
 F1 F4



JARRA 1,8 LT TRANSP KIT C/4 COPOS 4041  
 Código: 31277 Fábrica: SBRISSA Unidade: UN/1  
 F1 F4



JOELHO 1/2 PRETO JO51N 50X1  
 Código: 40153 Fábrica: REBOUCAS Unidade: PT/50  
 F1 F4



JOELHO 3/4 PRETO JO52N 50X1  
 Código: 40154 Fábrica: REBOUCAS Unidade: PT/50  
 F1 F4

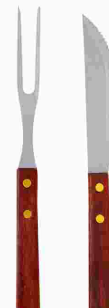

JOGO CHURRASCO FACA GARFO CB MAD 0091  
 Código: 41748 Fábrica: Q.P.BEST FER Unidade: CJ/1  
 F1 F4



JOGO CHURRASCO FACA GARFO CB MAD 204  
 Código: 41346 Fábrica: HAUSKRAFT Unidade: CJ/1  
 F1 F4



JOGO CHURRASCO FACA/CHAIRRA CB MAD 0071  
 Código: 41221 Fábrica: TALBERG Unidade: CJ/1  
 F1 F4



JOGO CHURRASCO FACA/GARF/PEGAD CB MAD 75  
 Código: 40458 Fábrica: TRAMONTINA Unidade: CJ/1  
 F1 F4



KIT CAIPIRINHA 3CS(COPO/TABUA/AMASSA 681  
 Código: 40392 Fábrica: TRAMONTINA Unidade: CJ/1  
 F1 F4



KIT COZINHA 3PCS(CAP BOT/CAP LIQ/FOR FOG  
 Código: 38506 Fábrica: FERREIRA Unidade: UN/1  
 F1 F4



KIT COZINHA 3PCS(CAP BOT/FOGAO/PUX SACO)  
 Código: 11332 Fábrica: FERREIRA Unidade: UN/1  
 F1 F4



KIT CUIA GDE NUTRICOCO (CORRENT/SUPORTE)  
 Código: 31903 Fábrica: NUTRIPLAN Unidade: UN/1  
 F1 F4



KIT CUIA GIG NUTRICOCO (CORRENT/SUPORTE)  
 Código: 31904 Fábrica: NUTRIPLAN Unidade: UN/1  
 F1 F4



KIT CUIA 1 MARROM (PRATO/CORREN/VASO)  
 Código: 18496 Fábrica: NUTRIPLAN Unidade: UN/1  
 F1 F4



KIT CUIA 1 PRETO (PRATO /CORREN/VASO)  
 Código: 18494 Fábrica: NUTRIPLAN Unidade: UN/1  
 F1 F4



KIT CUIA 1,5 MARROM (PRATO/CORREN/VASO)  
 Código: 27334 Fábrica: NUTRIPLAN Unidade: UN/1  
 F1 F4



KIT CUIA 2 MARROM (PRATO/CORREN/VASO)  
 Código: 22283 Fábrica: NUTRIPLAN Unidade: UN/1  
 F1 F4



KIT CUIA 2 PRETO (PRATO /CORREN/VASO)  
 Código: 22285 Fábrica: NUTRIPLAN Unidade: UN/1  
 F1 F4



KIT CUIA 3 MARROM (PRATO/CORREN/VASO)  
 Código: 31390 Fábrica: NUTRIPLAN Unidade: UN/1  
 F1 F4



KIT CUIA 3 PRETO (PRATO/CORREN/VASO)  
 Código: 30307 Fábrica: NUTRIPLAN Unidade: UN/1  
 F1 F4



KIT INF ESCOLAR PRATO+COLHER+CANECA 5013  
 Código: 41896 Fábrica: SBRISSA Unidade: CJ/1  
 F1 F4



KIT INOX 3 FACAS HERCULES MUNDIAL  
 Código: 41170 Fábrica: HERCULES Unidade: CJ/3  
 F1 F4



KIT MERENDA PLAST(PRATO/CUMB/CANECA/COLH  
 Código: 44236 Fábrica: SBRISSA Unidade: CJ/1  
 F1 F4



KIT MERENDA PLAST(PRATO/CUMB/CANECA/COLH  
Código: Fábrica: Unidade:  
**44235** **SBRISSA** **CJ/1**  
**F1 F4**



KIT P/BANHEIRO 4 PCS PLAST CORUJA 4054  
Código: Fábrica: Unidade:  
**47314** **CASITA** **CJ/1**  
**F1 F4**



KIT PIA (LIXEIRA/PA/PORTA DETE) DEC 8020  
Código: Fábrica: Unidade:  
**35224** **SBRISSA** **UN/1**  
**F1 F4**



KIT PIA (LIXEIRA/PA/PORTA DETE) 8002  
Código: Fábrica: Unidade:  
**34563** **SBRISSA** **UN/1**  
**F1 F4**

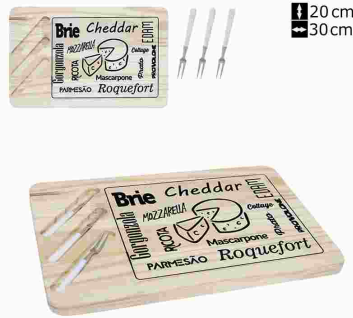

KIT STANDART/TABU MAD C/GARF 20X33CM 57H  
Código: Fábrica: Unidade:  
**41739** **DEBIASI** **UN/1**  
**F1 F4**



KIT 10 POTES RET 3500/1500/750/350/200ML  
Código: Fábrica: Unidade:  
**34573** **PLASTBON** **CJ/1**  
**F1 F4**



KIT 2 POTES ORGANIZA QUAD 3L 6332  
Código: Fábrica: Unidade:  
**47050** **JAGUAR** **CJ/1**  
**F1 F4**



KIT 2 POTES ORGANIZA RED 3L 6331  
Código: Fábrica: Unidade:  
**47049** **JAGUAR** **CJ/1**  
**F1 F4**



KIT 2 POTES ORGANIZA RET 3,6L 6333  
Código: Fábrica: Unidade:  
**47051** **JAGUAR** **CJ/1**  
**F1 F4**



KIT 2 POTES RED 4003/02  
Código: Fábrica: Unidade:  
**22916** **SBRISSA** **CJ/1**  
**F1 F4**



KIT 3 POTES ORGANIZA QUAD 1,2L 6328  
Código: Fábrica: Unidade:  
**47046** **JAGUAR** **CJ/1**  
**F1 F4**



KIT 3 POTES ORGANIZA RED 1,22L 6330  
Código: Fábrica: Unidade:  
**47048** **JAGUAR** **CJ/1**  
**F1 F4**



KIT 3 POTES ORGANIZA RET 1,270ML 6329  
Código: Fábrica: Unidade:  
**47047** **JAGUAR** **CJ/1**  
**F1 F4**



KIT 3 POTES QUAD MED 1200ML 5513  
Código: Fábrica: Unidade:  
**41478** **KOZI PLAST** **UN/1**  
**F1 F4**



KIT 3 POTES QUAD PMG 380/770/1400ML 7415  
Código: Fábrica: Unidade:  
**22917** **RISCHIOTO** **CJ/1**  
**F1 F4**



KIT 3 POTES QUAD 230/390/390ML 4128  
Código: Fábrica: Unidade:  
**8270** **JAGUAR** **CJ/1**  
**F1 F4**



KIT 3 POTES QUAD 230/390/690ML 4129  
 Código: 9836 Fábrica: JAGUAR Unidade: CJ/1 F1 F4



KIT 3 POTES RED 210/370/740ML 4054  
 Código: 8267 Fábrica: JAGUAR Unidade: CJ/1 F1 F4



KIT 3 POTES RED 4003  
 Código: 30698 Fábrica: SBRISSA Unidade: CJ/1 F1 F4



KIT 3 POTES RET PMG 380/740/1200ML 215  
 Código: 22918 Fábrica: RISCHIOTO Unidade: CJ/1 F1 F4



KIT 3 POTES RET 220/420/750ML 201  
 Código: 9838 Fábrica: JAGUAR Unidade: CJ/1 F1 F4



KIT 4 POTES QUAD 230/390/690/1200ML 4126  
 Código: 9076 Fábrica: JAGUAR Unidade: CJ/1 F1 F4



KIT 4 POTES QUAD 230/390/690/1200ML 4127  
 Código: 9077 Fábrica: JAGUAR Unidade: CJ/1 F1 F4



KIT 4 POTES RED 210/370/740/1220ML 4063  
 Código: 9835 Fábrica: JAGUAR Unidade: CJ/1 F1 F4



KIT 4 POTES RED 210/370/740/1220ML 4064  
 Código: 9078 Fábrica: JAGUAR Unidade: CJ/1 F1 F4

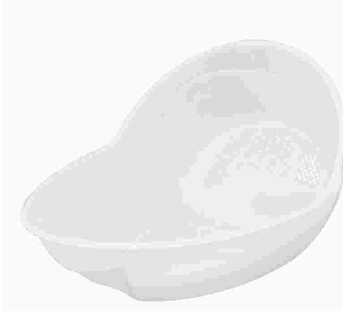

LAVA ARROZ PLAST 0795  
 Código: 47059 Fábrica: JAGUAR Unidade: UN/1 F1 F4



LAVA ARROZ PLAST 5015  
 Código: 14573 Fábrica: SBRISSA Unidade: UN/1 F1 F4



LAVA TUDO PLAST COLOR 5027  
 Código: 30262 Fábrica: SBRISSA Unidade: UN/1 F1 F4



LAVA TUDO PLAST COLOR 674  
 Código: 18306 Fábrica: ECOPLASTIC Unidade: UN/1 F1 F4



LEITEIRA ALUM EXTRA 14 C/TAMPA 1,7LTS  
 Código: 40290 Fábrica: AVELAR Unidade: UN/1 F1 F4



LICOREIRA VIDRO 250ML 19,3CM 22169  
 Código: 36770 Fábrica: MABEL Unidade: CX/1 F1 F4



LIMPA ALUMINIO DULAR 500 ML  
 Código: 48941 Fábrica: DULAR Unidade: UN/1 F1 F4



LIMPA TETO NYLON UN

Código: **50868** Fábrica: **HALLEY** Unidade: **UN/1**  
**F1 F4**



LIMPADOR MULT 500ML 8X3 AZULIM

Código: **48834** Fábrica: **AZULIM** Unidade: **PT/1**  
**F1 F4**

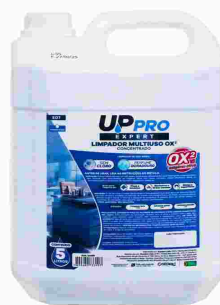

LIMPADOR MULTIUSO 5 LTS CONCENTRADO OX2

Código: **49516** Fábrica: **UP PRO** Unidade: **PT/1**  
**F1 F4**



37cm  
28cm  
15Lts

LIXEIRA C/ PEDAL 15 L ECO 3065

Código: **19089** Fábrica: **JAGUAR** Unidade: **UN/1**  
**F1 F4**



LIXEIRA CANELADA N 60 56 LTS FECH C/TPA

Código: **18340** Fábrica: **ANTARES** Unidade: **UN/1**  
**F1 F4**



LIXEIRA CANELADA N100 86 LTS FECH C/TP

Código: **22734** Fábrica: **ANTARES** Unidade: **UN/1**  
**F1 F4**



43cm

LIXEIRA INOX C/PEDAL 20 LTS 7022

Código: **47312** Fábrica: **CASITA** Unidade: **UN/1**  
**F1 F4**



39cm  
12Lts

LIXEIRA INOX 12 LTS 99-004

Código: **46893** Fábrica: **SATYAM** Unidade: **UN/1**  
**F1 F4**



LIXEIRA PLAST BASC 3 LTS 938

Código: **34576** Fábrica: **PLASTBON** Unidade: **UN/1**  
**F1 F4**



LIXEIRA PLAST BASC 3LTS DEC BIRDS 1741

Código: **37315** Fábrica: **MONTE LIBANO** Unidade: **UN/1**  
**F1 F4**



LIXEIRA PLAST BASC 3LTS DEC BLACK B 1743

Código: **37317** Fábrica: **MONTE LIBANO** Unidade: **UN/1**  
**F1 F4**



LIXEIRA PLAST BASC 3LTS DEC FENDI 1742

Código: **37316** Fábrica: **MONTE LIBANO** Unidade: **UN/1**  
**F1 F4**



LIXEIRA PLAST BASC 4,8 LTS PRETA

Código: **45447** Fábrica: **PLASMARC** Unidade: **UN/1**  
**F1 F4**



LIXEIRA PLAST BASC 6,2 LTS 6672

Código: **26199** Fábrica: **INPLAST** Unidade: **UN/1**  
**F1 F4**



40cm  
7,5Lts

LIXEIRA PLAST BASC 7,5 LTS ECO 3065

Código: **3077** Fábrica: **JAGUAR** Unidade: **UN/1**  
**F1 F4**



33cm  
29cm  
12Lts

LIXEIRA PLAST C/ PEDAL 12 LTS PRETA

Código: **34092** Fábrica: **SHANGRILA** Unidade: **UN/1**  
**F1 F4**



42cm  
32cm  
20Lts

LIXEIRA PLAST C/ PEDAL 20 LTS ECO 3073

Código: 49170 Fábrica: JAGUAR Unidade: UN/1 F1 F4



53cm  
40cm  
40Lts

LIXEIRA PLAST C/ PEDAL 40 LTS ECO 3074

Código: 49171 Fábrica: JAGUAR Unidade: UN/1 F1 F4



90cm  
50cm

LIXEIRA PLAST C/PEDAL E RODINHA 120 LTS

Código: 45930 Fábrica: ANTARES Unidade: UN/1 F1 F4



LIXEIRA PLAST C/PEDAL LTS DEC COLOR 1557

Código: 41465 Fábrica: MABEL Unidade: UN/1 F1 F4



LIXEIRA PLAST C/PEDAL 12 LTS BRANCA 300

Código: 39343 Fábrica: GUARANY Unidade: UN/1 F1 F4



LIXEIRA PLAST C/PEDAL 13 LTS 6313

Código: 40984 Fábrica: PLASTIBRASIL Unidade: UN/1 F1 F4

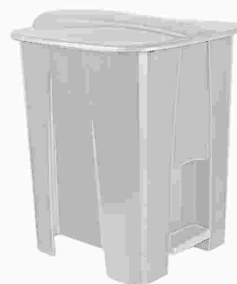

LIXEIRA PLAST C/PEDAL 15 LTS BRANCA 805

Código: 51048 Fábrica: LUMAR Unidade: UN/1 F1 F4



38cm  
15Lts

LIXEIRA PLAST C/PEDAL 15 LTS PRETO 383

Código: 44424 Fábrica: USUAL Unidade: UN/1 F1 F4



LIXEIRA PLAST C/PEDAL 15 LTS PRETO 808

Código: 51049 Fábrica: LUMAR Unidade: UN/1 F1 F4



67cm  
39cm

LIXEIRA PLAST C/PEDAL 60 LTS BRANCA

Código: 45929 Fábrica: ANTARES Unidade: UN/1 F1 F4



67cm  
39cm

LIXEIRA PLAST C/PEDAL 60 LTS PRETA

Código: 48663 Fábrica: ANTARES Unidade: UN/1 F1 F4



28cm  
7Lts

LIXEIRA PLAST C/PEDAL 7,0 LTS 281

Código: 45443 Fábrica: TRITEC Unidade: UN/1 F1 F4



25 cm  
25 cm

LIXEIRA PLAST C/PEDAL 7,5 LTS RED PRETA

Código: 45446 Fábrica: PLASMARC Unidade: UN/1 F1 F4



LIXEIRA PLAST C/TAMPA LTS 921

Código: 34577 Fábrica: PLASTBON Unidade: UN/1 F1 F4



LIXEIRA PLAST C/TAMPA 6 LTS PRETO 112

Código: 50004 Fábrica: PLASMARC Unidade: UN/1 F1 F4



36cm  
5,5Lts

LIXEIRA PLAST C/TPA 5,5 LTS 3067

Código: 492 Fábrica: JAGUAR Unidade: UN/1 F1 F4

13,5 cm



LIXEIRA PLAST DE MESA 13.5CM 57010

Código: **38423** Fábrica: **ALMEGA** Unidade: **UN/1**  
**F1 F4**



LIXEIRA PLAST PEDAL 7LT RATTAN PRET 1987

Código: **38377** Fábrica: **MONTE LIBANO** Unidade: **UN/1**  
**F1 F4**



LIXEIRA PLAST 13 LTS PRETA

Código: **28677** Fábrica: **ECOPLASTIC** Unidade: **UN/1**  
**F1 F4**



LIXEIRA PLAST 2 LTS BASIC P/PIA 4001

Código: **13891** Fábrica: **SBRISSA** Unidade: **UN/1**  
**F1 F4**



LIXEIRA PLAST 2,5 LTS P/PIA 7010

Código: **31285** Fábrica: **SBRISSA** Unidade: **UN/1**  
**F1 F4**



LIXEIRA PLAST 3,2 LTS BASIC 6650

Código: **20157** Fábrica: **INPLAST** Unidade: **UN/1**  
**F1 F4**

26cm  
8cm  
3,2lts



MACARICO PORTATIL PROF 17X6CM 1853

Código: **50956** Fábrica: **HAI BRASIL** Unidade: **UN/1**  
**F1 F4**



MANGUEIRA GAS 1,00M MANTAC 100

Código: **47883** Fábrica: **MANTAC** Unidade: **UN/1**  
**F1 F4**



MANGUEIRA GAS 1,25M C/2 ABRACADEIRAS 500

Código: **47884** Fábrica: **VINIGAS** Unidade: **UN/1**  
**F1 F4**



MANGUEIRA JD 10M ESG REG CAM DUPLA AZUL

Código: **18512** Fábrica: **NUTRIPLAN** Unidade: **UN/1**  
**F1 F4**



MANGUEIRA JD 10MTS TRANC CRISTAL 14017

Código: **48828** Fábrica: **ARQUA** Unidade: **UN/1**  
**F1 F4**



MANGUEIRA JD 10MTS TRANC FLEX VERD 14007

Código: **48830** Fábrica: **ARQUA** Unidade: **UN/1**  
**F1 F4**



MANGUEIRA JD 15MTS POP VERDE 14002

Código: **48826** Fábrica: **ARQUA** Unidade: **UN/1**  
**F1 F4**



MANGUEIRA JD 15MTS TRANC CRISTAL 14018

Código: **48831** Fábrica: **ARQUA** Unidade: **UN/1**  
**F1 F4**



MANGUEIRA JD 15MTS TRANC FLEX VERD 14008

Código: **48827** Fábrica: **ARQUA** Unidade: **UN/1**  
**F1 F4**



MANGUEIRA JD 20MTS POP VERDE 14003

Código: **48825** Fábrica: **ARQUA** Unidade: **UN/1**  
**F1 F4**



MANGUEIRA JD 20MTS TRANC CRISTAL 14019  
 Código: 48832 Fábrica: ARQUA Unidade: UN/1  
 F1 F4



MANGUEIRA JD 20MTS TRANC FLEX COLOR 158  
 Código: 40231 Fábrica: MONTEREY Unidade: UN/1  
 F1 F4



MANGUEIRA JD 20MTS TRANC FLEX VERD 14009  
 Código: 48833 Fábrica: ARQUA Unidade: UN/1  
 F1 F4



MANGUEIRA JD 30M ESG REG CAM DUPLA AZUL  
 Código: 27119 Fábrica: NUTRIPLAN Unidade: UN/1  
 F1 F4



MANGUEIRA JD 30MTS POP VERDE 14030  
 Código: 48824 Fábrica: ARQUA Unidade: UN/1  
 F1 F4



MANGUEIRA JD 30MTS TRANC FLEX COLOR 160  
 Código: 34405 Fábrica: MONTEREY Unidade: UN/1  
 F1 F4



MANGUEIRA JD 30MTS TRANC FLEX VERD 14011  
 Código: 48823 Fábrica: ARQUA Unidade: UN/1  
 F1 F4



MARMITA ALUM REDONDA 10 686  
 Código: 12305 Fábrica: MSR Unidade: UN/1  
 F1 F4



MARMITA ALUM REDONDA 12 687  
 Código: 10431 Fábrica: MSR Unidade: UN/1  
 F1 F4



MARMITA ALUM REDONDA 14 688  
 Código: 24365 Fábrica: MSR Unidade: UN/1  
 F1 F4



MARMITA ALUM REDONDA 16 689  
 Código: 22729 Fábrica: MSR Unidade: UN/1  
 F1 F4



MARMITA ALUM REDONDA 18 690  
 Código: 14610 Fábrica: MSR Unidade: UN/1  
 F1 F4



MARMITA PLAST INF 2 DIV C/COLHER 8345  
 Código: 26086 Fábrica: SATYAM Unidade: UN/1  
 F1 F4



MARMITA PLAST 1 LT C/TRAVA VALVULA 256  
 Código: 44436 Fábrica: USUAL Unidade: UN/1  
 F1 F4

8,5cm  
 11cm  
 17cm



MARMITA TERMICA ALUM RED 14 692  
 Código: 19605 Fábrica: MSR Unidade: UN/1  
 F1 F4



MARMITA TERMICA ALUM RED 16 C/BOLSA 694  
 Código: 26822 Fábrica: MSR Unidade: UN/1  
 F1 F4



MARMITA TERMICA ALUM RED 16 693

Código: 2218  
Fábrica: MSR  
Unidade: UN/1  
F1 F4



MARMITA TERMICA ALUM RET 16

Código: 2219  
Fábrica: MSR/DF  
Unidade: UN/1  
F1 F4



MARMITEC ISOPOR C/TAMPA 500 ML 100X1

Código: 50421  
Fábrica: ULTRA  
Unidade: PT/100  
F1 F4



MARTELO ALUM INTEIRICO 2006 UN

Código: 48023  
Fábrica: COFAX  
Unidade: UN/1  
F1 F4



MARTELO ALUM 19CM CB MAD 2021 UN

Código: 48021  
Fábrica: COFAX  
Unidade: UN/1  
F1 F4



MASSAGEADOR ROSTO E LIMPEZA FACIAL RECAR

Código: 35624  
Fábrica: FOREVER  
Unidade: CX/1  
F1 F4



MATA MOSCA PLAST 48CM CB MADEIRA 264 UN

Código: 45440  
Fábrica: TRITEC  
Unidade: PT/2  
F1 F4



MESA INFANTIL AZUL

Código: 22789  
Fábrica: ANTARES  
Unidade: UN/1  
F1 F4



MESA INFANTIL DOBRAVEL AZUL

Código: 28513  
Fábrica: ANTARES  
Unidade: UN/1  
F1 F4



MESA INFANTIL DOBRAVEL ROSA

Código: 28512  
Fábrica: ANTARES  
Unidade: UN/1  
F1 F4



MESA INFANTIL ROSA

Código: 23042  
Fábrica: ANTARES  
Unidade: UN/1  
F1 F4



MESA MADEIRA C/ 2 BANQUETAS STELL

Código: 35641  
Fábrica: AMOF  
Unidade: UN/1  
F1 F4



MESA MONOBLOCO BEGE

Código: 23044  
Fábrica: ANTARES  
Unidade: UN/1  
F1 F4



MESA MONOBLOCO BRANCA

Código: 22589  
Fábrica: ANTARES  
Unidade: UN/1  
F1 F4



MESA MONOBLOCO OURO PRETO PRETA

Código: 44669  
Fábrica: ANTARES  
Unidade: UN/1  
F1 F4



MESA MONOBLOCO VINHO

Código: 22591  
Fábrica: ANTARES  
Unidade: UN/1  
F1 F4



MESA PLASTICA RED BEGE DESMONTAVEL

Código: **20001** Fábrica: **ANTARES** Unidade: **UN/1**  
**F1 F4**



MESA PLASTICA RED BRANCA DESMONTAVEL

Código: **20002** Fábrica: **ANTARES** Unidade: **UN/1**  
**F1 F4**



MIX PERLITA CARVAO CASCA DE ARROZ 1 LITR

Código: **48529** Fábrica: **NOVATROPICAL** Unidade: **PT/1**  
**F1 F4**



MOP FLAT C/1 REFIL 474

Código: **41263** Fábrica: **123UTIL** Unidade: **UN/1**  
**F1 F4**



26cm  
1,2lts

MORINGA PLAST 1,2 LTS COLOR 817

Código: **35842** Fábrica: **LUMAR** Unidade: **UN/1**  
**F1 F4**



MUSGO SPHAGNUM 1 LITRO

Código: **48535** Fábrica: **NOVATROPICAL** Unidade: **PT/1**  
**F1 F4**



MUSGO VERDE 50 GRS 1 LITRO

Código: **34750** Fábrica: **NOVATROPICAL** Unidade: **PT/1**  
**F1 F4**



NHOQUEIRA ALUM INTERICO 22CM 2015 UN

Código: **48025** Fábrica: **COFAX** Unidade: **UN/1**  
**F1 F4**



ORGANIZADOR MOD RATTAN 10X7X11CM BABY942

Código: **38393** Fábrica: **MONTE LIBANO** Unidade: **UN/1**  
**F1 F4**



ORGANIZADOR MOD RATTAN 10X7X11CM BCO 940

Código: **38391** Fábrica: **MONTE LIBANO** Unidade: **UN/1**  
**F1 F4**



ORGANIZADOR MOD RATTAN 10X7X11CM TEND943

Código: **38394** Fábrica: **MONTE LIBANO** Unidade: **UN/1**  
**F1 F4**



ORGANIZADOR MOD RATTAN 15X10X11CM BAB932

Código: **38397** Fábrica: **MONTE LIBANO** Unidade: **UN/1**  
**F1 F4**



ORGANIZADOR MOD RATTAN 15X10X11CM BCO960

Código: **38395** Fábrica: **MONTE LIBANO** Unidade: **UN/1**  
**F1 F4**



ORGANIZADOR MOD RATTAN 15X10X11CM PTO961

Código: **38396** Fábrica: **MONTE LIBANO** Unidade: **UN/1**  
**F1 F4**

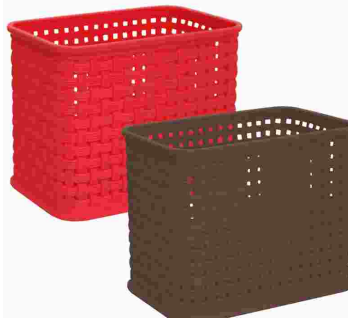

ORGANIZADOR MOD RATTAN 15X10X11CM TEN963

Código: **38398** Fábrica: **MONTE LIBANO** Unidade: **UN/1**  
**F1 F4**

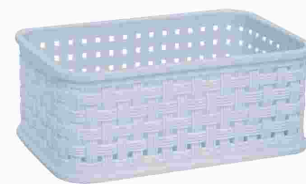

ORGANIZADOR MOD RATTAN 15X10X6CM BABY932

Código: **38402** Fábrica: **MONTE LIBANO** Unidade: **UN/1**  
**F1 F4**



ORGANIZADOR MOD RATTAN 15X10X6CM BCO 930  
 Código: 38388 Fábrica: MONTE LIBANO Unidade: UN/1  
 F1 F4

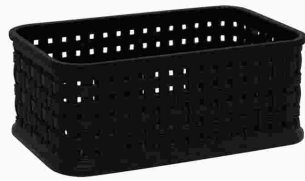

ORGANIZADOR MOD RATTAN 15X10X6CM PTO 931  
 Código: 38389 Fábrica: MONTE LIBANO Unidade: UN/1  
 F1 F4



ORGANIZADOR MOD RATTAN 15X10X6CM TEND933  
 Código: 38390 Fábrica: MONTE LIBANO Unidade: UN/1  
 F1 F4



ORGANIZADOR MOD RATTAN 20X15X6CM 970  
 Código: 38384 Fábrica: MONTE LIBANO Unidade: UN/1  
 F1 F4



ORGANIZADOR MOD RATTAN 20X15X6CM PTO 971  
 Código: 38386 Fábrica: MONTE LIBANO Unidade: UN/1  
 F1 F4



ORGANIZADOR MOD RATTAN 30X10X6CM BABY952  
 Código: 38382 Fábrica: MONTE LIBANO Unidade: UN/1  
 F1 F4

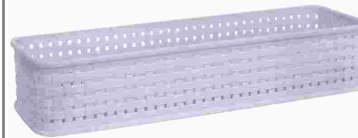

ORGANIZADOR MOD RATTAN 30X10X6CM BCO 950  
 Código: 38380 Fábrica: MONTE LIBANO Unidade: UN/1  
 F1 F4



ORGANIZADOR MOD RATTAN 30X10X6CM TEND953  
 Código: 38381 Fábrica: MONTE LIBANO Unidade: UN/1  
 F1 F4



ORGANIZADOR PLAST C/DIV 23X14,8X4CM 2015  
 Código: 37313 Fábrica: MONTE LIBANO Unidade: UN/1  
 F1 F4



ORGANIZADOR PLAST C/DIV 28X18X4,5CM 2020  
 Código: 37312 Fábrica: MONTE LIBANO Unidade: UN/1  
 F1 F4



ORGANIZADOR PLAST C/DIV 37X28,5X7CM 2025  
 Código: 38376 Fábrica: MONTE LIBANO Unidade: UN/1  
 F1 F4



ORGANIZADORA PLAST RED 5,5 LTS BCA 952  
 Código: 34581 Fábrica: PLASTBON Unidade: UN/1  
 F1 F4



ORGANIZADORA PLAST RED 5,5 LTS COLOR1088  
 Código: 34584 Fábrica: PLASTBON Unidade: UN/1  
 F1 F4



PA LIXO METAL CB MADEIRA 60CM  
 Código: 17510 Fábrica: HALLE Unidade: UN/1  
 F1 F4



PA LIXO PLAST C/CABO MAD LONGO 033  
 Código: 33514 Fábrica: BENEDETTI Unidade: UN/1  
 F1 F4



PA LIXO PLAST C/CABO PEQ COLOR PLUS 3051  
 Código: 49812 Fábrica: HALLEY Unidade: UN/1  
 F1 F4



PA LIXO PLAST C/CABO PEQ PRETA 2497  
 Código: 49813 Fábrica: EDS Unidade: UN/1  
 F1 F4



PA LIXO PLAST COLOR 28CM 09  
 Código: 44084 Fábrica: QUALYPLAS Unidade: UN/1  
 F1 F4



28cm  
 PA LIXO PLAST CORES  
 Código: 12902 Fábrica: ANTARES Unidade: UN/1  
 F1 F4



28cm  
 PA LIXO PLAST PRETA  
 Código: 34093 Fábrica: SHANGRILA Unidade: UN/1  
 F1 F4



PA LIXO PLAST TABACO  
 Código: 40779 Fábrica: NUTRIPLAN Unidade: UN/1  
 F1 F4



PA LIXO PLAST 032  
 Código: 23995 Fábrica: BENEDETTI Unidade: UN/1  
 F1 F4

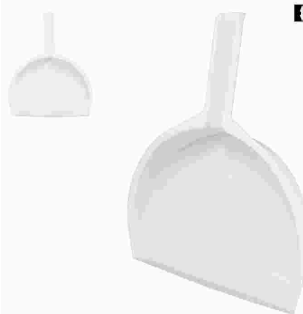

28cm  
 PA LIXO PLAST 0698  
 Código: 47067 Fábrica: JAGUAR Unidade: UN/1  
 F1 F4



PA LIXO PLAST 2466  
 Código: 49809 Fábrica: EDS Unidade: UN/1  
 F1 F4



PA LIXO PLAST 7003  
 Código: 14585 Fábrica: SBRISSA Unidade: UN/1  
 F1 F4



PA MADEIRA 30 CM (ESPATULA) 012  
 Código: 41318 Fábrica: MAD LAR Unidade: UN/1  
 F1 F4



PA MADEIRA 38 CM (ESPATULA) 014  
 Código: 41317 Fábrica: MAD LAR Unidade: UN/1  
 F1 F4



PA MADEIRA 38 CM 110  
 Código: 35827 Fábrica: CSD Unidade: UN/1  
 F1 F4



PANELA ALUM BATIDO 16 CB MADEIRA 1511  
 Código: 45371 Fábrica: MSR Unidade: UN/1  
 F1 F4



PANELA ALUM BATIDO 18 CB INTEIRICO 1551  
 Código: 45376 Fábrica: MSR Unidade: UN/1  
 F1 F4



PANELA ALUM BATIDO 18 CB MADEIRA 1512  
 Código: 45370 Fábrica: MSR Unidade: UN/1  
 F1 F4



PANELA ALUM BATIDO 20 CB INTEIRICO 1554  
 Código: 45375 Fábrica: MSR Unidade: UN/1  
 F1 F4



PANELA ALUM BATIDO 20 CB MADEIRA 1513

Código: 45369 Fábrica: MSR Unidade: UN/1  
F1 F4



PANELA ALUM BATIDO 22 CB INTEIRICO 1552

Código: 45374 Fábrica: MSR Unidade: UN/1  
F1 F4



PANELA ALUM BATIDO 24 CB INTEIRICO 1553

Código: 45373 Fábrica: MSR Unidade: UN/1  
F1 F4



PANELA ALUM BATIDO 28 CB MADEIRA 1517

Código: 45368 Fábrica: MSR Unidade: UN/1  
F1 F4



PANELA ALUM BATIDO 30 CB INTEIRICO 1576

Código: 45372 Fábrica: MSR Unidade: UN/1  
F1 F4



PANELA ALUM EXTRA 14 CB MADEIRA 697

Código: 24373 Fábrica: MSR Unidade: UN/1  
F1 F4



PANELA ALUM EXTRA 16 CB MADEIRA 698

Código: 24374 Fábrica: MSR Unidade: UN/1  
F1 F4



PANELA ALUM EXTRA 18 CB MADEIRA 699

Código: 24375 Fábrica: MSR Unidade: UN/1  
F1 F4



PANELA ALUM EXTRA 20 CB MADEIRA 700/701

Código: 24376 Fábrica: MSR Unidade: UN/1  
F1 F4



PANELA ALUM EXTRA 22 CB MADEIRA 701

Código: 24377 Fábrica: MSR Unidade: UN/1  
F1 F4



PANELA ALUM EXTRA 24 CB MADEIRA 702

Código: 24378 Fábrica: MSR Unidade: UN/1  
F1 F4



PANELA ALUM LEVE 14 C/TAMPA

Código: 5884 Fábrica: AVELAR Unidade: UN/1  
F1 F4



PANELA ALUM LEVE 16 C/TAMPA

Código: 5885 Fábrica: AVELAR Unidade: UN/1  
F1 F4



PANELA ALUM LEVE 18 S/TAMPA

Código: 5886 Fábrica: AVELAR Unidade: UN/1  
F1 F4



PANELA ALUM LEVE 20 S/TAMPA

Código: 5887 Fábrica: AVELAR Unidade: UN/1  
F1 F4



PANELA ALUM LUXO 14 CB BAQUELITE 703

Código: 25302 Fábrica: MSR Unidade: UN/1  
F1 F4



PANELA ALUM LUXO 16 CB BAQUELITE 704

Código: **25306** Fábrica: **MSR** Unidade: **UN/1**  
**F1 F4**



PANELA ALUM LUXO 18 CB BAQUELITE 705

Código: **25307** Fábrica: **MSR** Unidade: **UN/1**  
**F1 F4**



PANELA ALUM LUXO 20 CB BAQUELITE 706

Código: **25303** Fábrica: **MSR** Unidade: **UN/1**  
**F1 F4**



PANELA ALUM LUXO 22 CB BAQUELITE 707

Código: **25304** Fábrica: **MSR** Unidade: **UN/1**  
**F1 F4**



PANELA PRESSAO 7,0 LTS POLIDA ALUMINE

Código: **48116** Fábrica: **ALEGRETE** Unidade: **UN/1**  
**F1 F4**



PANELA PRESSAO 10,0 LTS POLIDA ALUMINE

Código: **48120** Fábrica: **ALEGRETE** Unidade: **UN/1**  
**F1 F4**

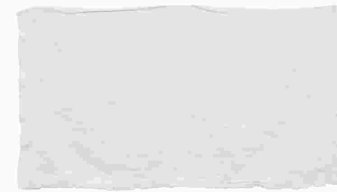

PANO CHAO SACO ALG ALVEJ COMBATE 38X58CM

Código: **49840** Fábrica: **TEXTIL** Unidade: **UN/1**  
**F1 F4**



PANO CHAO SACO ALG ALVEJ M 43X63CM

Código: **49831** Fábrica: **TEXTIL** Unidade: **UN/1**  
**F1 F4**



PANO CHAO SACO ALG ALVEJ PP 30X55CM

Código: **50090** Fábrica: **TEXTIL** Unidade: **UN/1**  
**F1 F4**



PANO CHAO SACO ALG ALVEJ TRAD 43X68CM

Código: **49839** Fábrica: **TEXTIL** Unidade: **UN/1**  
**F1 F4**



PANO CHAO SACO ALG XADREZ M 43X68CM

Código: **48794** Fábrica: **TEXTIL** Unidade: **UN/1**  
**F1 F4**



PANO CHAO SACO ALG XADREZ SG 78X53CM

Código: **20249** Fábrica: **TEXTIL** Unidade: **UN/1**  
**F1 F4**



PANO CHAO SACO CRU ECOPLUS 48X85CM

Código: **47137** Fábrica: **TEXTIL/ENCOP** Unidade: **UN/1**  
**F1 F4**



PANO MULTIUSO MICROFIBRA 30X30CM 010 3X1

Código: **49394** Fábrica: **RIOHOME** Unidade: **PT/3**  
**F1 F4**



PANO MULTIUSO 30X50CM AZUL 5X1

Código: **48716** Fábrica: **NOBRE** Unidade: **PT/5**  
**F1 F4**

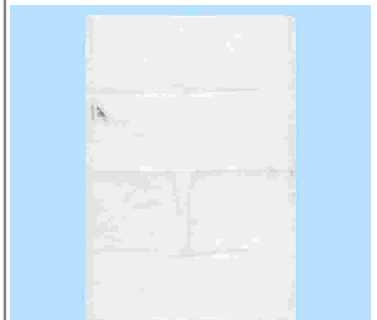

PANO PRATO ALGODAO LISO RUBI 65X40CM

Código: **49795** Fábrica: **ENGOMATEXIL** Unidade: **UN/1**  
**F1 F4**



PANO PRATO LISO EXTRA 100% ALGO 72X45CM  
 Código: 48813 Fábrica: ENGOMATEX Unidade: UN/1  
 F1 F4



PANO PRATO LISO RUBI 65X40CM 114 10X1  
 Código: 39380 Fábrica: ENGOMATEXIL Unidade: PT/10  
 F1 F4



PAPEIRO ALUM LEVE 16 708  
 Código: 20734 Fábrica: MSR Unidade: UN/1  
 F1 F4



PAPEL ALUMINIO 7,5MTSX30CM 19935  
 Código: 47844 Fábrica: THEOTO/MELLO Unidade: RL/1  
 F1 F4

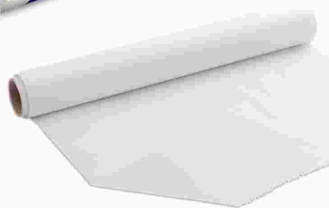

PAPEL MANTEIGA 28CMX4M 21754  
 Código: 50076 Fábrica: BOMPACK Unidade: RL/1  
 F1 F4



PAPEL MANTEIGA 28CMX7,5M  
 Código: 48695 Fábrica: BOMPACK Unidade: RL/1  
 F1 F4



PAPEL TOALHA 20X22CM BCO FOLHA DUPLA 2X1  
 Código: 47980 Fábrica: NOBRE SENSE Unidade: PT/2  
 F1 F4



PEDRA DOLOMITA BRANCO 3 1 KG  
 Código: 22888 Fábrica: NOVATROPICAL Unidade: PT/1  
 F1 F4



PEDRA SEIXO MARMORE 15 KG N0  
 Código: 34647 Fábrica: NOVATROPICAL Unidade: PT/1  
 F1 F4

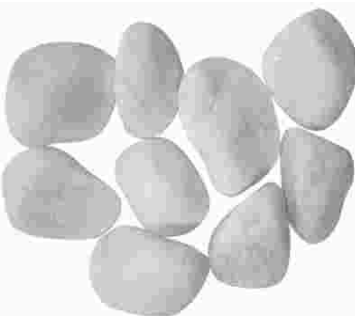

PEDRA SEIXO MARMORE 15 KG N1  
 Código: 33905 Fábrica: NOVATROPICAL Unidade: PT/1  
 F1 F4



PEDRA SEIXO MARMORE 15 KG N2  
 Código: 33430 Fábrica: NOVATROPICAL Unidade: PT/1  
 F1 F4

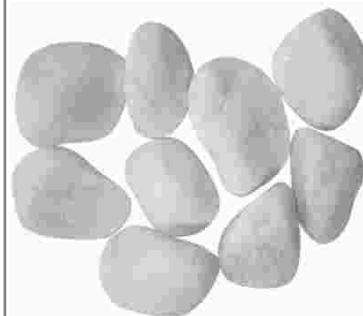

PEDRA SEIXO MARMORE 15 KG N3  
 Código: 33235 Fábrica: NOVATROPICAL Unidade: PT/1  
 F1 F4



PEGADOR INOX CHURRASCO 38CM CAB MAD 2038  
 Código: 41347 Fábrica: HAUSKRAFT Unidade: UN/1  
 F1 F4



PEGADOR INOX MASSAS 29CM ITALIA CTL 800  
 Código: 47990 Fábrica: PLANETA Unidade: CR/1  
 F1 F4



PEGADOR INOX MULTUSO 28CM PE60  
 Código: 46582 Fábrica: HERCULES Unidade: UN/1  
 F1 F4



PEGADOR MACARRAO NYLON REF 503  
 Código: 10988 Fábrica: PLASUTIL Unidade: UN/1  
 F1 F4

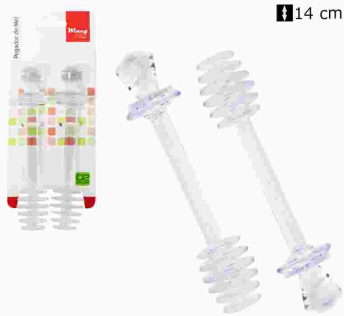

14 cm

PEGADOR MEL ACRILICO 14CM 2X1 CTL 3170

Código: 44725  
Fábrica: WINCY  
Unidade: CJ/2  
F1 F4



15 cm

PEGADOR MEL MADEIRA 15CM 6027 4X1

Código: 44726  
Fábrica: WINCY  
Unidade: CJ/4  
F1 F4



PEGADOR PLAST MACARRAO COLOR 5024

Código: 31281  
Fábrica: SBRISSA  
Unidade: UN/1  
F1 F4



14 cm

PENEIRA ACO INOX 14CM 003

Código: 41353  
Fábrica: HAUSKRAFT  
Unidade: UN/1  
F1 F4



PENEIRA ACO INOX 16 CM DUPLA CAMADA 345

Código: 44507  
Fábrica: PLANETA  
Unidade: UN/1  
F1 F4



PENEIRA ACO INOX 18 CM DUPLA CAMADA 346

Código: 44506  
Fábrica: PLANETA  
Unidade: UN/1  
F1 F4



PENEIRA PLAST C/CABO 07 CM 661

Código: 35494  
Fábrica: TRITEC  
Unidade: UN/1  
F1 F4



PENEIRA PLAST C/CABO 10 CM 660

Código: 35495  
Fábrica: TRITEC  
Unidade: UN/1  
F1 F4



PENEIRA PLAST C/CABO 18 CM 3182 6X1

Código: 37691  
Fábrica: MAMITA  
Unidade: PT/6  
F1 F4



PENEIRA PLAST C/CABO 28 CM 659

Código: 35496  
Fábrica: TRITEC  
Unidade: UN/1  
F1 F4



PENEIRA PLAST C/FUNIL COLOR 3024 6X1

Código: 41894  
Fábrica: SBRISSA  
Unidade: PT/1  
F1 F4



PENEIRA PLAST DE NYLON 8 CM 677

Código: 48664  
Fábrica: PLANETA  
Unidade: UN/1  
F1 F4



PENEIRA PLASTICA 16 CM 3011 12X1

Código: 11022  
Fábrica: SBRISSA  
Unidade: PT/12  
F1 F4



PENEIRA PLASTICA 20 CM 3012 12X1

Código: 2940  
Fábrica: SBRISSA  
Unidade: PT/12  
F1 F4



PERLITA EXPANDIDA 1 LITRO

Código: 48530  
Fábrica: NOVATROPICAL  
Unidade: PT/1  
F1 F4



PESO UNIV PANELA PRESS CROMADO 3002 10X1

Código: 19368  
Fábrica: PINOLAR  
Unidade: PT/10  
F1 F4



PESO UNIV PANELA PRESS ENCAPAD 4001 10X1  
 Código: **40032** Fábrica: **PINOLAR** Unidade: **PT/10**  
**F1 F4**



PESO UNIV PANELA PRESS ENCAPAD 4001 5X1  
 Código: **34633** Fábrica: **PINOLAR** Unidade: **PT/5**  
**F1 F4**



PILAO ALUM INTEIRICO ALHO GDE 2032 UN  
 Código: **46852** Fábrica: **COFAX** Unidade: **UN/1**  
**F1 F4**



PILAO ALUM INTEIRICO ALHO PEQ 2012 UN  
 Código: **48076** Fábrica: **COFAX** Unidade: **UN/1**  
**F1 F4**



PILAO MAD 08 CM C/SOCADOR 101  
 Código: **41324** Fábrica: **MAD LAR** Unidade: **UN/1**  
**F1 F4**



PILAO PLASTICO 8,5X17CM 1059/1070  
 Código: **20927** Fábrica: **ENGIPLAST** Unidade: **UN/1**  
**F1 F4**



PINCEL COZINHA COLOR SILICONE 24CM 16058  
 Código: **26125** Fábrica: **ALIANCA** Unidade: **UN/1**  
**F1 F4**



PIPOQUEIRA ALUM 20 709  
 Código: **22731** Fábrica: **MSR** Unidade: **UN/1**  
**F1 F4**



PLAFON PLAST C/SOQUETE PORCELANA BCO E27  
 Código: **48603** Fábrica: **REBOUCAS** Unidade: **UN/1**  
**F1 F4**



PLAINA INOX 25CM P/QUEIJOS 065  
 Código: **47332** Fábrica: **NIX** Unidade: **UN/1**  
**F1 F4**



PO DE CARVAO VEGETAL 1 LITRO  
 Código: **48528** Fábrica: **NOVATROPICAL** Unidade: **PT/1**  
**F1 F4**



PO DE COCO 1 LITRO  
 Código: **48532** Fábrica: **NOVATROPICAL** Unidade: **PT/1**  
**F1 F4**



PO DE PINUS 1 LITRO  
 Código: **48531** Fábrica: **NOVATROPICAL** Unidade: **PT/1**  
**F1 F4**



POLVILHADEIRA MATA FORMIGA CAP 1KG  
 Código: **38650** Fábrica: **GUARANY** Unidade: **UN/1**  
**F1 F4**



PORTA CHA MDF 10X10CM 470  
 Código: **45985** Fábrica: **R A ARTESANA** Unidade: **UN/1**  
**F1 F4**



PORTA CHAVE DE FERRO 5062  
 Código: **42171** Fábrica: **PAIOL** Unidade: **UN/1**  
**F1 F4**



PORTA COND PLAST COLORAU 499

Código: 46644 Fábrica: QUALYPLAS Unidade: UN/1 F1 F4



PORTA COND PLAST OREGANO 416

Código: 46645 Fábrica: QUALYPLAS Unidade: UN/1 F1 F4



PORTA COND PLAST PIMENTA DO REINO 418

Código: 46648 Fábrica: QUALYPLAS Unidade: UN/1 F1 F4



PORTA COND PLAST PIMENTA 417

Código: 46647 Fábrica: QUALYPLAS Unidade: UN/1 F1 F4



PORTA COND PLAST SAL419

Código: 46646 Fábrica: QUALYPLAS Unidade: UN/1 F1 F4



PORTA CONDIMENTO VIDRO 100ML 008 2X1

Código: 49375 Fábrica: RIOHOME Unidade: UN/1 F1 F4



PORTA COPOS MDF PEQ FLAMENGO 10688 6X1

Código: 41151 Fábrica: BRASFOOT Unidade: UN/1 F1 F4



PORTA COTONETE/ALGODAO PLAST 10CM 2638

Código: 41554 Fábrica: PLASUTIL Unidade: UN/1 F1 F4



PORTA DETERGENTE BUCHA 550 ML DISPEN 976

Código: 46671 Fábrica: LUMAR Unidade: UN/1 F1 F4



PORTA DETERGENTE E BUCHA RATTAN BCO 1970

Código: 37292 Fábrica: MONTE LIBANO Unidade: UN/1 F1 F4



PORTA DETERGENTE E BUCHA RATTAN BCO 920

Código: 38399 Fábrica: MONTE LIBANO Unidade: UN/1 F1 F4



PORTA DETERGENTE E BUCHA RATTAN PTO 1971

Código: 37291 Fábrica: MONTE LIBANO Unidade: UN/1 F1 F4



PORTA DETERGENTE E BUCHA RATTAN PTO 921

Código: 38400 Fábrica: MONTE LIBANO Unidade: UN/1 F1 F4



PORTA DETERGENTE E BUCHA RATTAN TEND 923

Código: 38401 Fábrica: MONTE LIBANO Unidade: UN/1 F1 F4



PORTA DETERGENTE SABAO ESPONJA 5028

Código: 10403 Fábrica: SBRISSA Unidade: UN/1 F1 F4



PORTA DETERGENTE SABAO PLAST 180CM 84

Código: 44087 Fábrica: QUALYPLAS Unidade: UN/1 F1 F4



21cm

PORTA ESCOVA DENTES PLAST 1616

Código: 47065 Fábrica: JAGUAR Unidade: UN/1 F1 F4



PORTA ESCOVA PLAST 20CM COLOR 669

Código: 44086 Fábrica: QUALYPLAS Unidade: UN/1 F1 F4



PORTA ESCOVAS DENTE C/TAMPA 980

Código: 46672 Fábrica: LUMAR Unidade: UN/1 F1 F4



PORTA FILTRO PLAST UN 5025

Código: 31282 Fábrica: SBRISSA Unidade: UN/1 F1 F4



8,5cm  
17,5cm  
23,5cm

PORTA FRIO PLAST 2 LTS C/TRAV TRANSL 393

Código: 44437 Fábrica: USUAL Unidade: UN/1 F1 F4

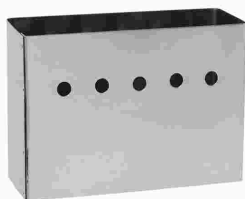

PORTA GUARDANAPO INOX 13X5,5X9CM 180225

Código: 39222 Fábrica: SATYAM Unidade: UN/1 F1 F4



PORTA GUARDANAPO INOX 15X3X6,5CM 110060

Código: 39221 Fábrica: SATYAM Unidade: UN/1 F1 F4



PORTA LEITE PLAST SAQUIN 16,5X7,5X16,5CM

Código: 20013 Fábrica: DELTA UTIL Unidade: UN/1 F1 F4



PORTA SABAO 335

Código: 28886 Fábrica: JOREAL Unidade: UN/1 F1 F4



PORTA SABAO/DET/BUCHA PLAST 6611

Código: 41671 Fábrica: INPLAST Unidade: UN/1 F1 F4



PORTA SABONETE LIQ PLAST 500 ML 981

Código: 46670 Fábrica: LUMAR Unidade: UN/1 F1 F4



PORTA SABONETE LIQUIDO PLAST 250ML 2636

Código: 41556 Fábrica: PLASUTIL Unidade: UN/1 F1 F4

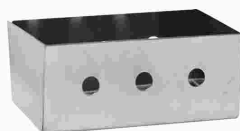

PORTA SACHES INOX 10X4,5X6,5CM 180224

Código: 39220 Fábrica: SATYAM Unidade: UN/1 F1 F4



PORTA TALHER CROM 561

Código: 20176 Fábrica: ARAMINAS Unidade: UN/1 F1 F4

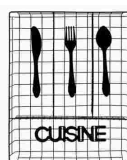

PORTA TALHER INOX ARAMADO 32X26X3,5CM

Código: 38529 Fábrica: WINCY Unidade: UN/1 F1 F4



PORTA TALHER PLAST COLOR 6699

Código: 41672 Fábrica: INPLAST Unidade: UN/1 F1 F4



PORTA TALHER PLASTICO C/TAMPA 517

Código: 35484  
 Fábrica: TRITEC  
 Unidade: UN/1  
 F1 F4



PORTA VINHO DEITADO ENVELHEC 3424-1

Código: 37189  
 Fábrica: PAIOL  
 Unidade: UN/1  
 F1 F4



PORTA VINHO E TACAS VIOLETA 4546

Código: 37188  
 Fábrica: PAIOL  
 Unidade: UN/1  
 F1 F4



POTE CAFE ACUCAR PORTA FILT/ADAPTAD 8001

Código: 34564  
 Fábrica: SBRISSA  
 Unidade: CJ/1  
 F1 F4



POTE CAFE ACUCAR PREMIUM 8005

Código: 34565  
 Fábrica: SBRISSA  
 Unidade: CJ/1  
 F1 F4



POTE HERMETICO 4,5LTS RET C/TRAVA 952

Código: 48669  
 Fábrica: LIG BRIN  
 Unidade: UN/1  
 F1 F4



POTE MANTIMENTO ALUM LEVE 14

Código: 11260  
 Fábrica: AVELAR  
 Unidade: UN/1  
 F1 F4



POTE PLAST C/TAMPA MULTIUSO G COLOR

Código: 41209  
 Fábrica: PLASTSU  
 Unidade: UN/1  
 F1 F4



POTE PLAST C/TRAVA GG COLOR 2,5LT 331030

Código: 41207  
 Fábrica: PLASTSU  
 Unidade: UN/1  
 F1 F4



POTE PLAST DESC 250 ML 50X1

Código: 47739  
 Fábrica: COPOZAN  
 Unidade: PT/50  
 F1 F4



POTE PLAST HERM 2,2 LTS ALTO TRANSP 183T

Código: 34068  
 Fábrica: GIOTTO  
 Unidade: UN/1  
 F1 F4



POTE PLAST MANT 2,5LTS QUAD ACUCAR 244

Código: 40367  
 Fábrica: FORMPLAST  
 Unidade: UN/1  
 F1 F4



POTE PLAST MANT 2,5LTS QUAD ARROZ 241

Código: 40370  
 Fábrica: FORMPLAST  
 Unidade: UN/1  
 F1 F4



POTE PLAST MANT 2,5LTS QUAD CAFE 245

Código: 40368  
 Fábrica: FORMPLAST  
 Unidade: UN/1  
 F1 F4



POTE PLAST MANT 2,5LTS QUAD FARINHA 243

Código: 40366  
 Fábrica: FORMPLAST  
 Unidade: UN/1  
 F1 F4



POTE PLAST MANT 2,5LTS QUAD FEIJAO 242

Código: 40365  
 Fábrica: FORMPLAST  
 Unidade: UN/1  
 F1 F4



POTE PLAST RED 5LTS PREMIUM FACILITT 155  
 Código: 45190 Fábrica: RISCHIOTO Unidade: UN/1  
 F1 F4

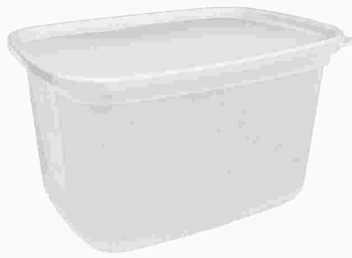

POTE PLAST RET ALTO 4,2LTS 342  
 Código: 45196 Fábrica: RISCHIOTO Unidade: UN/1  
 F1 F4



POTE PLAST RET FACILITTA ALTO 2,5LTS 341  
 Código: 45191 Fábrica: RISCHIOTO Unidade: UN/1  
 F1 F4

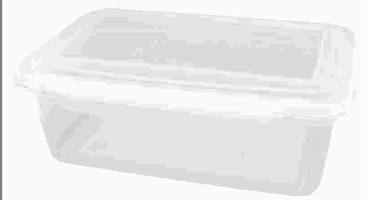

POTE PLAST RET 2,75L C/TRAVA 3312  
 Código: 47055 Fábrica: JAGUAR Unidade: UN/1  
 F1 F4

28cm  
 10cm  
 19cm



POTE PLAST RET 3,6LTS 1666  
 Código: 6195 Fábrica: JAGUAR Unidade: UN/1  
 F1 F4

30cm  
 10cm  
 20cm



POTE PLAST RET 5LTS C/TRAVA 3313  
 Código: 47057 Fábrica: JAGUAR Unidade: UN/1  
 F1 F4

28cm  
 17cm  
 19cm

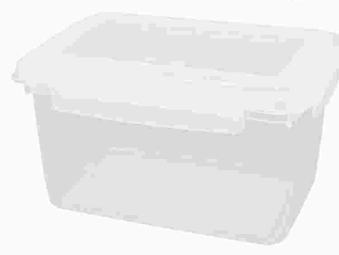

POTE PLAST RET 850 ML C/TRAVA 3306  
 Código: 47044 Fábrica: JAGUAR Unidade: UN/1  
 F1 F4

17cm  
 8cm  
 19cm



POTE PLAST SUPERCLICK 800ML 1545 UN  
 Código: 45442 Fábrica: TRITEC Unidade: UN/1  
 F1 F4

6,5 cm  
 22 cm  
 1250ml



POTE PLAST 1250 ML RET CLICK G 75832  
 Código: 40396 Fábrica: UN-ART Unidade: UN/1  
 F1 F4

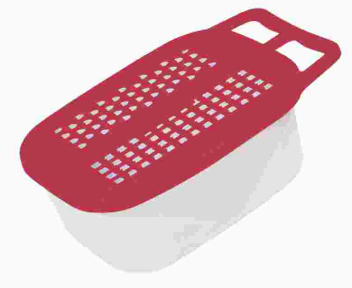

POTE PLAST 1,4 LTS C/RALADOR COLOR 4035  
 Código: 40376 Fábrica: FORMPLAST Unidade: UN/1  
 F1 F4



POTE PLAST 1,5 LTS COLOR 819  
 Código: 45843 Fábrica: LUMAR Unidade: UN/1  
 F1 F4



POTE PLAST 1,7 LTS DUPLO COLOR 14  
 Código: 40372 Fábrica: FORMPLAST Unidade: UN/1  
 F1 F4



POTE PLAST 2 LTS ALTO FRUTAS 002  
 Código: 36530 Fábrica: MAXIMAPLASTI Unidade: UN/1  
 F1 F4



POTE PLAST 2,5 LT RED P/ ALIMENT 4009  
 Código: 13912 Fábrica: SBRISSA Unidade: UN/1  
 F1 F4



POTE PLAST 2,5 LT RED P/ALIMENT DEC 8015  
 Código: 35220 Fábrica: SBRISSA Unidade: UN/1  
 F1 F4



POTE PLAST 3 LTS ALTO FRUTAS 003  
 Código: 36529 Fábrica: MAXIMAPLASTI Unidade: UN/1  
 F1 F4

 <p>4,5 cm 15,5 cm 380 ml</p> <p>POTE PLAST 380 ML RET CLICK P 75820</p> <p>Código: 40394 Fábrica: UN-ART Unidade: UN/1 F1 F4</p>	 <p>POTE PLAST 4,5LTS C/ROSCA SPINLOCK 7704</p> <p>Código: 50230 Fábrica: RISCHIOTO Unidade: UN/1 F1 F4</p>	 <p>POTE PLAST 5 LTS ALTO FRUTAS 004</p> <p>Código: 36528 Fábrica: MAXIMAPLASTI Unidade: UN/1 F1 F4</p>	 <p>5,5 cm 18,5 cm 740 ml</p> <p>POTE PLAST 740 ML RET CLICK M 75826</p> <p>Código: 40395 Fábrica: UN-ART Unidade: UN/1 F1 F4</p>
 <p>POTE PLAST 800ML QUAD TRANSP TP AZUL PER</p> <p>Código: 40134 Fábrica: KOZI PLAST Unidade: UN/1 F1 F4</p>	 <p>POTE PLAST 800ML QUAD TRANSP TP BRANCA</p> <p>Código: 40133 Fábrica: KOZI PLAST Unidade: UN/1 F1 F4</p>	 <p>POTE PLAST 800ML RED TRANSP TP AZUL PER</p> <p>Código: 40139 Fábrica: KOZI PLAST Unidade: UN/1 F1 F4</p>	 <p>POTE PLAST 800ML RED TRANSP TP AZUL ROY</p> <p>Código: 40140 Fábrica: KOZI PLAST Unidade: UN/1 F1 F4</p>
 <p>POTE PLAST 800ML RED TRANSP TP BRANCA</p> <p>Código: 40138 Fábrica: KOZI PLAST Unidade: UN/1 F1 F4</p>	 <p>POTE PLAST 800ML RED TRANSP TP ROSA PER</p> <p>Código: 40141 Fábrica: KOZI PLAST Unidade: UN/1 F1 F4</p>	 <p>POTE VIDRO 1 LT C/TPA PLAST 22011</p> <p>Código: 46889 Fábrica: SATYAM Unidade: UN/1 F1 F4</p>	 <p>POTE VIDRO 1,0 L C/TPA PLAST 0017</p> <p>Código: 35096 Fábrica: SATYAM Unidade: UN/1 F1 F4</p>
 <p>POTE VIDRO 1,0 L C/TPA PLAST 0022</p> <p>Código: 35097 Fábrica: SATYAM Unidade: UN/1 F1 F4</p>	 <p>POTE VIDRO 1,0 L C/TPA PLAST 9426</p> <p>Código: 47316 Fábrica: CASITA Unidade: UN/1 F1 F4</p>	 <p>POTE VIDRO 720 ML C/TPA PLAST 0016</p> <p>Código: 35098 Fábrica: SATYAM Unidade: UN/1 F1 F4</p>	 <p>PRATO ALUM FUNDO 1290</p> <p>Código: 37253 Fábrica: MSR/YANG Unidade: UN/1 F1 F4</p>



PRATO ALUM LEVE ESCOLAR

Código: 27596  
 Fábrica: AVELAR  
 Unidade: UN/1  
 F1 F4



PRATO CERAMICA BCO RASO LISO 10.5 12X1

Código: 41460  
 Fábrica: MABEL  
 Unidade: CX/12  
 F1 F4



PRATO DESCARTAVEL FUNDO N20 10UN

Código: 48319  
 Fábrica: COPOPLAST  
 Unidade: PT/1  
 F1 F4



PRATO INF FUNDO DECORADO 1648

Código: 7964  
 Fábrica: PLASUTIL  
 Unidade: UN/1  
 F1 F4



PRATO MELAMINE FUNDO 20 CM 528P

Código: 10059  
 Fábrica: IDEA  
 Unidade: UN/1  
 F1 F4



PRATO PL 09 PRETO 9X25CM 222

Código: 37709  
 Fábrica: BIG PLAST  
 Unidade: UN/1  
 F1 F4



PRATO PL 1 RED PRETO

Código: 18462  
 Fábrica: NUTRIPLAN  
 Unidade: UN/1  
 F1 F4



PRATO PL 11 PRETO 11X2,5CM 224

Código: 37708  
 Fábrica: BIG PLAST  
 Unidade: UN/1  
 F1 F4



PRATO PL 1,2 RED PEQ AMARELO CLARO

Código: 34596  
 Fábrica: NUTRIPLAN  
 Unidade: UN/1  
 F1 F4



PRATO PL 1,2 RED PEQ LILAS CLARO

Código: 34597  
 Fábrica: NUTRIPLAN  
 Unidade: UN/1  
 F1 F4



PRATO PL 1,2 RED PEQ ROSA BEBE

Código: 34599  
 Fábrica: NUTRIPLAN  
 Unidade: UN/1  
 F1 F4



PRATO PL 1,2 RED PEQ VERDE CLARO

Código: 34598  
 Fábrica: NUTRIPLAN  
 Unidade: UN/1  
 F1 F4



PRATO PL 1,5 RED PEQ MARROM

Código: 22296  
 Fábrica: NUTRIPLAN  
 Unidade: UN/1  
 F1 F4



PRATO PL 1,5 RED PEQ PRETO

Código: 18463  
 Fábrica: NUTRIPLAN  
 Unidade: UN/1  
 F1 F4



PRATO PL 2 RED MARROM

Código: 30286  
 Fábrica: NUTRIPLAN  
 Unidade: UN/1  
 F1 F4



PRATO PL 2 RED PRETO

Código: 18464  
 Fábrica: NUTRIPLAN  
 Unidade: UN/1  
 F1 F4

3 cm  
21 cm



PRATO PL 3 RED MARROM

Código: **30288** Fábrica: **NUTRIPLAN** Unidade: **UN/1**  
**F1 F4**

3 cm  
21 cm



PRATO PL 3 RED PRETO

Código: **18465** Fábrica: **NUTRIPLAN** Unidade: **UN/1**  
**F1 F4**

3,5 cm  
23 cm



PRATO PL 4 RED MARROM

Código: **18484** Fábrica: **NUTRIPLAN** Unidade: **UN/1**  
**F1 F4**

3,5 cm  
23 cm



PRATO PL 4 RED PRETO

Código: **18466** Fábrica: **NUTRIPLAN** Unidade: **UN/1**  
**F1 F4**

4 cm  
26 cm



PRATO PL 5 MARROM

Código: **30289** Fábrica: **NUTRIPLAN** Unidade: **UN/1**  
**F1 F4**

4 cm  
26 cm



PRATO PL 5 PRETO

Código: **30290** Fábrica: **NUTRIPLAN** Unidade: **UN/1**  
**F1 F4**

4 cm  
28 cm



PRATO PL 6 RED PRETO

Código: **18467** Fábrica: **NUTRIPLAN** Unidade: **UN/1**  
**F1 F4**

4,5 cm  
29 cm



PRATO PL 7 MARROM

Código: **18485** Fábrica: **NUTRIPLAN** Unidade: **UN/1**  
**F1 F4**

4,5 cm  
29 cm



PRATO PL 7 RED PRETO

Código: **18468** Fábrica: **NUTRIPLAN** Unidade: **UN/1**  
**F1 F4**



PRATO PL 8 RED PRETO

Código: **18469** Fábrica: **NUTRIPLAN** Unidade: **UN/1**  
**F1 F4**

5,5 cm  
36 cm



PRATO PL 9 PRETO

Código: **30291** Fábrica: **NUTRIPLAN** Unidade: **UN/1**  
**F1 F4**

3,4 cm  
17 cm



PRATO PL FLOREIRA 1 MARROM

Código: **18511** Fábrica: **NUTRIPLAN** Unidade: **UN/1**  
**F1 F4**

3,4 cm  
17 cm



PRATO PL FLOREIRA 1 17CM MARMORE

Código: **22299** Fábrica: **NUTRIPLAN** Unidade: **UN/1**  
**F1 F4**

11 cm  
35 cm



PRATO PL JARDINEIRA 35CM CAPUCCINO

Código: **35206** Fábrica: **NUTRIPLAN** Unidade: **UN/1**  
**F1 F4**

11 cm  
35 cm



PRATO PL JARDINEIRA 35CM CINZA

Código: **35207** Fábrica: **NUTRIPLAN** Unidade: **UN/1**  
**F1 F4**

35 cm

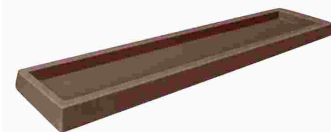

PRATO PL JARDINEIRA 35CM TABACO

Código: **33907** Fábrica: **NUTRIPLAN** Unidade: **UN/1**  
**F1 F4**

 <p>PRATO PL JARDINEIRA 50 CM CAPUCCINO</p> <p>Código: <b>35208</b> Fábrica: <b>NUTRIPLAN</b> Unidade: <b>UN/1</b> <b>F1 F4</b></p> <p>11cm 50cm</p>	 <p>PRATO PL JARDINEIRA 50 CM CINZA</p> <p>Código: <b>35209</b> Fábrica: <b>NUTRIPLAN</b> Unidade: <b>UN/1</b> <b>F1 F4</b></p> <p>11cm 50cm</p>	 <p>PRATO PL JARDINEIRA 80 CM CAPUCCINO</p> <p>Código: <b>35461</b> Fábrica: <b>NUTRIPLAN</b> Unidade: <b>UN/1</b> <b>F1 F4</b></p> <p>11 cm 35cm</p>	 <p>PRATO PL JARDINEIRA 80 CM CINZA</p> <p>Código: <b>35462</b> Fábrica: <b>NUTRIPLAN</b> Unidade: <b>UN/1</b> <b>F1 F4</b></p> <p>11 cm 35cm</p>
 <p>PRATO PL MINI FLOREIRA QUAD MARMORE</p> <p>Código: <b>22298</b> Fábrica: <b>NUTRIPLAN</b> Unidade: <b>UN/1</b> <b>F1 F4</b></p> <p>1,5 cm 8,5 cm</p>	 <p>PRATO PL MINI FLOREIRA QUAD MARROM</p> <p>Código: <b>22297</b> Fábrica: <b>NUTRIPLAN</b> Unidade: <b>UN/1</b> <b>F1 F4</b></p> <p>1,5 cm 8,5 cm</p>	 <p>PRATO PL MINI FLOREIRA QUAD PRETO</p> <p>Código: <b>30208</b> Fábrica: <b>NUTRIPLAN</b> Unidade: <b>UN/1</b> <b>F1 F4</b></p> <p>1,5 cm 8,5 cm</p>	 <p>PRATO PL 0,5 RED PEQ AMARELO CLARO</p> <p>Código: <b>35713</b> Fábrica: <b>NUTRIPLAN</b> Unidade: <b>UN/1</b> <b>F1 F4</b></p>
 <p>PRATO PL 0,5 RED PEQ LILAS CLARO</p> <p>Código: <b>35714</b> Fábrica: <b>NUTRIPLAN</b> Unidade: <b>UN/1</b> <b>F1 F4</b></p>	 <p>PRATO PL 0,5 RED PEQ ROSA BEBE</p> <p>Código: <b>35715</b> Fábrica: <b>NUTRIPLAN</b> Unidade: <b>UN/1</b> <b>F1 F4</b></p>	 <p>PRATO PL 0,5 RED PEQ VERDE CLARO</p> <p>Código: <b>35716</b> Fábrica: <b>NUTRIPLAN</b> Unidade: <b>UN/1</b> <b>F1 F4</b></p>	 <p>PRATO PL 10 MARROM</p> <p>Código: <b>30292</b> Fábrica: <b>NUTRIPLAN</b> Unidade: <b>UN/1</b> <b>F1 F4</b></p> <p>6 cm 41 cm</p>
 <p>PRATO PL 14 PRETO 14X3CM 226</p> <p>Código: <b>47291</b> Fábrica: <b>BIG PLAST</b> Unidade: <b>UN/1</b> <b>F1 F4</b></p> <p>3cm 14cm</p>	 <p>PRATO PL 14 RED 14CM PRETO 344</p> <p>Código: <b>40847</b> Fábrica: <b>JOREAL</b> Unidade: <b>UN/1</b> <b>F1 F4</b></p>	 <p>PRATO PL 17 PRETO 17X3,5CM 228</p> <p>Código: <b>37707</b> Fábrica: <b>BIG PLAST</b> Unidade: <b>UN/1</b> <b>F1 F4</b></p> <p>3,5 cm 17 cm</p>	 <p>PRATO PL 20 PRETO 20X3,5CM 230</p> <p>Código: <b>47290</b> Fábrica: <b>BIG PLAST</b> Unidade: <b>UN/1</b> <b>F1 F4</b></p> <p>3,5cm 20cm</p>

3,5cm  
22cm



PRATO PL 22 PRETO 22X3,5CM 232

Código: 37706 Fábrica: BIG PLAST Unidade: UN/1 F1 F4

5 cm  
30 cm



PRATO PL 29 QUAD TEXTUR AREIA

Código: 30342 Fábrica: NUTRIPLAN Unidade: UN/1 F1 F4

5 cm  
30 cm



PRATO PL 29 QUAD TEXTUR FERRUGEM

Código: 30343 Fábrica: NUTRIPLAN Unidade: UN/1 F1 F4

5 cm  
34 cm



PRATO PL 33 QUAD TEXTUR FERRUGEM

Código: 30344 Fábrica: NUTRIPLAN Unidade: UN/1 F1 F4

5 cm  
43 cm



PRATO PL 41 RED TEXTUR AREIA

Código: 36795 Fábrica: NUTRIPLAN Unidade: UN/1 F1 F4

5 cm  
43 cm



PRATO PL 41 RED TEXTUR FERRUGEM

Código: 30345 Fábrica: NUTRIPLAN Unidade: UN/1 F1 F4

5 cm  
46 cm

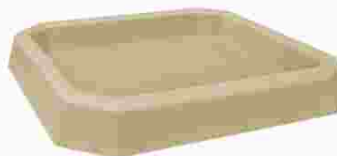

PRATO PL 44 QUAD LISO AREIA

Código: 30346 Fábrica: NUTRIPLAN Unidade: UN/1 F1 F4

5 cm  
47 cm



PRATO PL 46 RED LISO FERRUGEM

Código: 30341 Fábrica: NUTRIPLAN Unidade: UN/1 F1 F4

5 cm  
50 cm



PRATO PL 47 RED TEXTUR FERRUGEM

Código: 30347 Fábrica: NUTRIPLAN Unidade: UN/1 F1 F4

5 cm  
56 cm



PRATO PL 50 RED TEXTUR AREIA

Código: 36283 Fábrica: NUTRIPLAN Unidade: UN/1 F1 F4



PRATO PLAST FUNDO KIDS CORES 21X30CM 756

Código: 46643 Fábrica: QUALYPLAS Unidade: UN/1 F1 F4



PRATO PLAST FUNDO 3000

Código: 20712 Fábrica: SBRISSA Unidade: UN/1 F1 F4

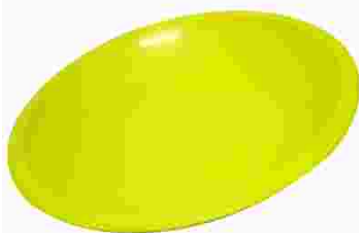

PRATO PLAST INF FUNDO 22 CM C/ABA 1276

Código: 18213 Fábrica: ECOPLASTIC Unidade: UN/1 F1 F4



PRATO PLAST INF RASO 20 CM S/ABA 1278

Código: 22322 Fábrica: ECOPLASTIC Unidade: UN/1 F1 F4



PRATO PLAST RASO 3007

Código: 14576 Fábrica: SBRISSA Unidade: UN/1 F1 F4



PRATO PORC FUNDO FEST BCO 23CM 7507 6X1

Código: 35059 Fábrica: CHEF LINE Unidade: PT/6 F1 F4



PRATO PORC FUNDO QUAD BCO 24CM 7500 6X1  
 Código: 35060 Fábrica: CHEF LINE Unidade: PT/6  
 F1 F4



PRATO PORC FUNDO RED BCO 24CM 7504 6X1  
 Código: 35058 Fábrica: CHEF LINE Unidade: PT/6  
 F1 F4

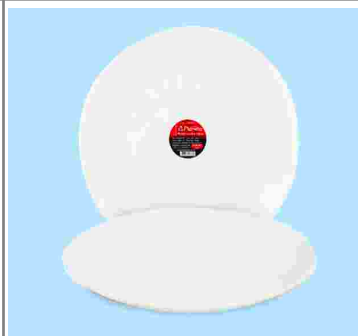

PRATO VIDRO RASO RED BCO 26,67CM 631 6X1  
 Código: 48680 Fábrica: PLANETA Unidade: CX/6  
 F1 F4

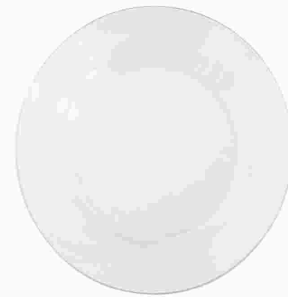

PRATO VIDRO TRANSP FUNDO 22CM MILLY 4X1  
 Código: 50167 Fábrica: WELLMIX Unidade: CJ/4  
 F1 F4



PRENDEDOR ROUPAS MADEIRA 7CM 12X1  
 Código: 23765 Fábrica: AGUIA BRANCA Unidade: DZ/12  
 F1 F4



PRENDEDOR ROUPAS MADEIRA 7,2CM 36X1  
 Código: 47001 Fábrica: PRENDE MAIS Unidade: PT/36  
 F1 F4



PRENDEDOR ROUPAS MADEIRA 9CM 12X1  
 Código: 47000 Fábrica: PRENDE MAIS Unidade: DZ/12  
 F1 F4



PRENDEDOR ROUPAS PLAST GDE 25X12  
 Código: 41238 Fábrica: POLICORDA Unidade: PT/300  
 F1 F4



PRENDEDOR ROUPAS PLAST 7CM 12X1 49 A  
 Código: 27432 Fábrica: DEBIASI Unidade: DZ/12  
 F1 F4



PRENDEDOR ROUPAS PLAST 8,5CM 12X1  
 Código: 24652 Fábrica: PRENDE MAIS Unidade: DZ/12  
 F1 F4



PREPARO P/ORQUIDEAS 1KG  
 Código: 32771 Fábrica: VITAPLAN Unidade: UN/1  
 F1 F4



PROCESSADOR PLAST ALIMENTOS MANUAL 200ML  
 Código: 44518 Fábrica: NICOBEM Unidade: UN/1  
 F1 F4



PROCESSADOR PLAST ALIMENTOS MANUAL 450ML  
 Código: 39793 Fábrica: HAI BRASIL Unidade: UN/1  
 F1 F4



PROCESSADOR PLAST ALIMENTOS MANUAL 500ML  
 Código: 40342 Fábrica: PLANETA Unidade: UN/1  
 F1 F4



PROCESSADOR PLAST ALIMENTOS MANUAL 500ML  
 Código: 49651 Fábrica: WINCY Unidade: UN/1  
 F1 F4



PROCESSADOR PLAST ALIMENTOS MANUAL 500ML  
 Código: 50138 Fábrica: GP6 Unidade: UN/1  
 F1 F4



18 cm

PROCESSADOR PLAST ALIMENTOS USB 220ML779  
 Código: 41598 Fábrica: EMILAR Unidade: UN/1  
 F1 F4



PULVERIZADOR BOMBA FLITZ 3267  
 Código: 50967 Fábrica: FGB Unidade: UN/1  
 F1 F4



29 cm

PULVERIZADOR DE COMPRESSAO PREVIA 1,2 LT  
 Código: 38649 Fábrica: GUARANY Unidade: UN/1  
 F1 F4



PULVERIZADOR PET PLAST 500ML TRANSP 7631  
 Código: 47358 Fábrica: ALTIHOME Unidade: UN/1  
 F1 F4



PULVERIZADOR PLAST P/GARRAFA PET 4017  
 Código: 50146 Fábrica: GP6 Unidade: UN/1  
 F1 F4



PULVERIZADOR PLAST 300 ML DISPENSER 001  
 Código: 49377 Fábrica: RIOHOME Unidade: UN/1  
 F1 F4



PULVERIZADOR PLAST 350 ML QUALITY 843  
 Código: 35831 Fábrica: LUMAR Unidade: UN/1  
 F1 F4



PULVERIZADOR PLAST 450 ML QUALITY 842  
 Código: 35832 Fábrica: LUMAR Unidade: UN/1  
 F1 F4



20 cm  
 500 ml

PULVERIZADOR PLAST 500 ML TRANSP 5028  
 Código: 39375 Fábrica: ARBRA Unidade: UN/1  
 F1 F4



PULVERIZADOR PLAST 500 ML VERDE  
 Código: 37222 Fábrica: NUTRIPLAN Unidade: UN/1  
 F1 F4



PULVERIZADOR PLAST 500ML TRANSP 35654  
 Código: 44098 Fábrica: NOBRE Unidade: UN/1  
 F1 F4



PULVERIZADOR PLAST 550 ML GIRAFA 430150  
 Código: 38894 Fábrica: PLASDURAN Unidade: UN/1  
 F1 F4



PULVERIZADOR PLAST 580 ML AZUL  
 Código: 18503 Fábrica: NUTRIPLAN Unidade: UN/1  
 F1 F4



PULVERIZADOR PLAST 750 ML QUALITY 847  
 Código: 35835 Fábrica: LUMAR Unidade: UN/1  
 F1 F4



PUXA SACO  
 Código: 11337 Fábrica: MC PANOS Unidade: UN/1  
 F1 F4

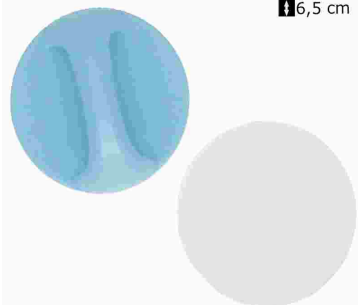

6,5 cm

PUXADOR PLAST AUTO COLANTE 6,5CM 106-9  
 Código: 44520 Fábrica: NICOBEM Unidade: UN/1  
 F1 F4



PUXADOR P/TAMPA DE PAINEL 105753113 2X1  
 Código: 33444 Fábrica: MAXPING Unidade: UN/1  
 F1 F4



QUADRO PL PAINEL 1 PINUS 3004  
 Código: 37163 Fábrica: PAIOL Unidade: UN/1  
 F1 F4

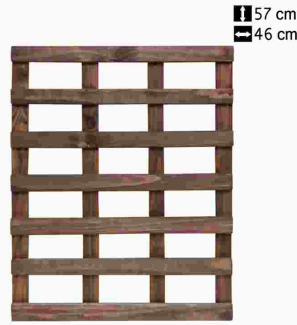

QUADRO PL PAINEL 2 PINUS 3005  
 Código: 37164 Fábrica: PAIOL Unidade: UN/1  
 F1 F4



QUADRO PL PAINEL 3 PINUS 3006  
 Código: 37165 Fábrica: PAIOL Unidade: UN/1  
 F1 F4

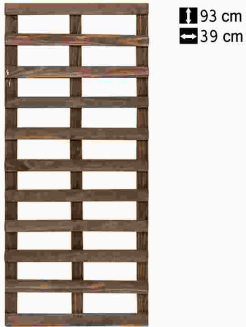

QUADRO PL PAINEL 4 PINUS 3007  
 Código: 37166 Fábrica: PAIOL Unidade: UN/1  
 F1 F4

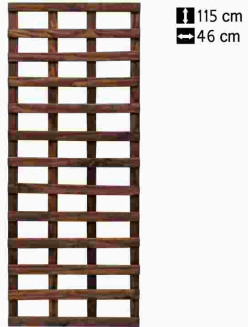

QUADRO PL PAINEL 5 PINUS 3008  
 Código: 37167 Fábrica: PAIOL Unidade: UN/1  
 F1 F4

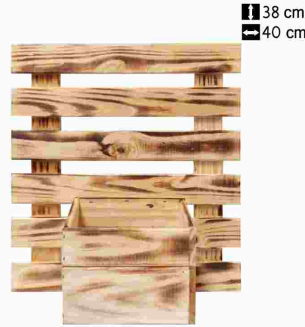

QUADRO PL 1 CRISANTEMO PINUS ENV 3201-2  
 Código: 37162 Fábrica: PAIOL Unidade: UN/1  
 F1 F4

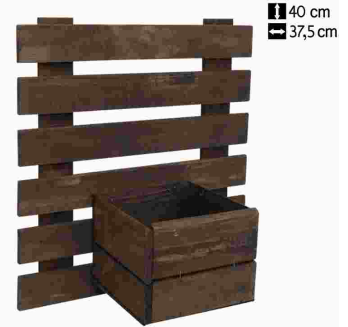

QUADRO PL 1 CRISANTEMO PINUS PINT 3201-1  
 Código: 39469 Fábrica: PAIOL Unidade: UN/1  
 F1 F4



QUADRO PL 1 VIOLETA PINOS PINTADO 0024-1  
 Código: 37156 Fábrica: PAIOL Unidade: UN/1  
 F1 F4

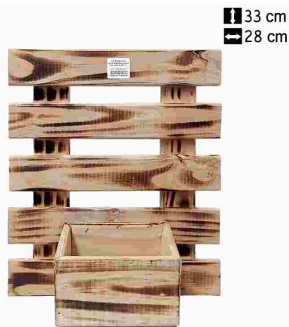

QUADRO PL 1 VIOLETA PINUS ENVELHE 0024-2  
 Código: 37155 Fábrica: PAIOL Unidade: UN/1  
 F1 F4



QUADRO PL 2 CRISANTEMO PINUS ENV 3200-2  
 Código: 37161 Fábrica: PAIOL Unidade: UN/1  
 F1 F4



QUADRO PL 2 CRISANTEMO PINUS PINT 3200-1  
 Código: 37957 Fábrica: PAIOL Unidade: UN/1  
 F1 F4

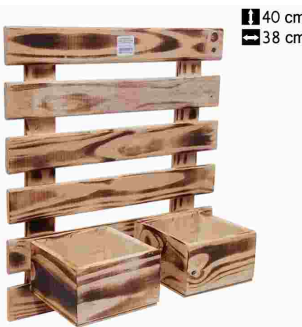

QUADRO PL 2 VIOLETAS PINUS ENVEHECI 26-1  
 Código: 37158 Fábrica: PAIOL Unidade: UN/1  
 F1 F4



QUADRO PL 2 VIOLETAS PINUS PINTADO 26-2  
 Código: 37157 Fábrica: PAIOL Unidade: UN/1  
 F1 F4



QUADRO PL 3 VIOLETAS PINUS ENVELHEC 23-2  
 Código: 37159 Fábrica: PAIOL Unidade: UN/1  
 F1 F4



QUEIJEIRA PLAST 0027  
 Código: 4269 Fábrica: JAGUAR Unidade: UN/1  
 F1 F4



RALADOR INOX 6 FACES CB PLAST BRANCO 59  
 Código: 46584 Fábrica: HERCULES Unidade: UN/1  
 F1 F4



RALADOR 1 FACE INOX 25CM 062  
 Código: 47327 Fábrica: NIX Unidade: UN/1  
 F1 F4



RALADOR 4 FACES FLANDRES CB PLAST 3201  
 Código: 38331 Fábrica: VIEL Unidade: UN/1  
 F1 F4

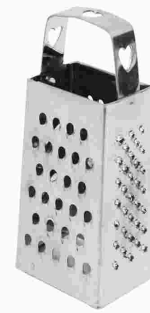

RALADOR 4 FACES INOX MINI 14713  
 Código: 46493 Fábrica: NICOBEM Unidade: UN/1  
 F1 F4

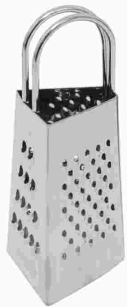

RALADOR 4 FACES INOX MINI 8CM 272  
 Código: 48681 Fábrica: PLANETA Unidade: UN/1  
 F1 F4



RALADOR 4 FACES PLAST 732  
 Código: 35845 Fábrica: LUMAR Unidade: UN/1  
 F1 F4



RALADOR 6 FACES INOX 22CM CB METAL 12946  
 Código: 41290 Fábrica: GP6 Unidade: UN/1  
 F1 F4



RALINHO INOX P/PIA 5,2CM CTL 348  
 Código: 44502 Fábrica: PLANETA Unidade: CR/1  
 F1 F4



RALINHO INOX P/PIA 5,5CM CTL 4472  
 Código: 49630 Fábrica: WINMAX Unidade: CR/1  
 F1 F4



RALINHO TELA GALV P/PIA 4,5 CM 1011 12X1  
 Código: 13446 Fábrica: JWC Unidade: DZ/12  
 F1 F4



RALINHO TELA GALV P/PIA 7 CM G 1010 12X1  
 Código: 25222 Fábrica: JWC Unidade: DZ/12  
 F1 F4



RALO INOX P/PIA 7CM CTL MG-2984  
 Código: 40303 Fábrica: MEGAGIFT Unidade: CR/1  
 F1 F4



RALO OCULTO SIFONADO 150X150MM BEGE  
 Código: 48608 Fábrica: REBOUCAS Unidade: UN/1  
 F1 F4



RALO OCULTO SIFONADO 150X150MM BRANCO  
 Código: 48604 Fábrica: REBOUCAS Unidade: UN/1  
 F1 F4

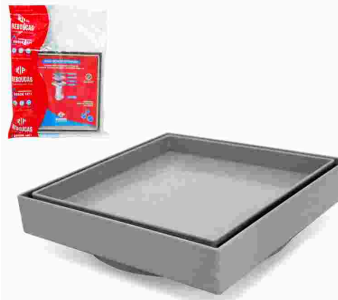

RALO OCULTO SIFONADO 150X150MM CINZA  
 Código: 48606 Fábrica: REBOUCAS Unidade: UN/1  
 F1 F4



RALO OCULTO SIFONADO 150X150MM MARROM  
 Código: 48607 Fábrica: REBOUCAS Unidade: UN/1  
 F1 F4



RALO OCULTO SIFONADO 150X150MM PRETO

Código: **48605** Fábrica: **REBOUCAS** Unidade: **UN/1**  
F1 F4



REFRESQUEIRA ALUM LEVE 14 1,2 LTS

Código: **5894** Fábrica: **AVELAR** Unidade: **UN/1**  
F1 F4



REGADOR ALUM MEDIO 600 ML 648

Código: **39542** Fábrica: **BMC ALUMINIO** Unidade: **UN/1**  
F1 F4



REGADOR PLAST 5 LTS RECICL VERDE 7006

Código: **49519** Fábrica: **ARBRA** Unidade: **UN/1**  
F1 F4



REGADOR PLAST 8 LTS RECICL PRETO 7004

Código: **9513** Fábrica: **ARBRA** Unidade: **UN/1**  
F1 F4



REGADOR PLAST 8 LTS RECICL VERDE 7005

Código: **39373** Fábrica: **ARBRA** Unidade: **UN/1**  
F1 F4



REGADOR PLAST PEQ 1,5LT C/CHUVEIRO LILAS

Código: **46044** Fábrica: **NUTRIPLAN** Unidade: **UN/1**  
F1 F4



REGADOR PLAST PEQ 1,5LT C/CHUVEIRO ROSA

Código: **46043** Fábrica: **NUTRIPLAN** Unidade: **UN/1**  
F1 F4



REGADOR PLAST 10 LTS RECICL PRETO 7001

Código: **49518** Fábrica: **ARBRA** Unidade: **UN/1**  
F1 F4



REGADOR PLAST 10 LTS RECICL VERDE 7002

Código: **44981** Fábrica: **ARBRA** Unidade: **UN/1**  
F1 F4



REGISTRO PRESSAO PVC BCO C/VOL 51N 12X1

Código: **40159** Fábrica: **REBOUCAS** Unidade: **PT/12**  
F1 F4



REGISTRO PRESSAO PVC BCO C/VOL 52N 12X1

Código: **40158** Fábrica: **REBOUCAS** Unidade: **PT/12**  
F1 F4



REGISTRO PRESSAO PVC BCO C/VOL 53N 12X1

Código: **40157** Fábrica: **REBOUCAS** Unidade: **PT/12**  
F1 F4



REGISTRO PRESSAO PVC BCO C/VOL 54N 12X1

Código: **40162** Fábrica: **REBOUCAS** Unidade: **PT/12**  
F1 F4



REGISTRO PRESSAO PVC MARR C/VOL 55N 12X1

Código: **40160** Fábrica: **REBOUCAS** Unidade: **PT/12**  
F1 F4



REGISTRO PRESSAO PVC MARR C/VOL 56N 12X1

Código: **40161** Fábrica: **REBOUCAS** Unidade: **PT/12**  
F1 F4



REGULADOR GAS 1KG COMPLETO 14400 163  
 Código: 47760 Fábrica: VINIGAS Unidade: UN/1  
 F1 F4



REGULADOR GAS 1KG C/REGISTRO 14300 162  
 Código: 47882 Fábrica: VINIGAS Unidade: UN/1  
 F1 F4



RODINHO DE PIA CABO MADEIRA 37  
 Código: 6293 Fábrica: N.HORIZONTE Unidade: UN/1  
 F1 F4



RODINHO DE PIA CABO PLAST 83  
 Código: 48937 Fábrica: N.HORIZONTE Unidade: UN/1  
 F1 F4



RODINHO PLAST PIA COLOR 744  
 Código: 44085 Fábrica: QUALYPLAS Unidade: UN/1  
 F1 F4



RODIZIO METAL E PLAST GIRATORIO C/FREIO  
 Código: 50834 Fábrica: GP6 Unidade: UN/1  
 F1 F4



RODO ALUM 40 CM C/CABO ALUM  
 Código: 50913 Fábrica: SANCHES Unidade: UN/1  
 F1 F4



RODO ALUM 60 CM C/CABO ALUM  
 Código: 50631 Fábrica: SANCHES Unidade: UN/1  
 F1 F4



RODO FIORY 30CM CM C/CABO MADEIRA UN  
 Código: 47252 Fábrica: SHANGRILA Unidade: UN/1  
 F1 F4



RODO FIORY 40CM CM C/CABO MADEIRA UN  
 Código: 47253 Fábrica: SHANGRILA Unidade: UN/1  
 F1 F4



RODO FIORY 60CM CM C/CABO MADEIRA UN  
 Código: 47254 Fábrica: SHANGRILA Unidade: UN/1  
 F1 F4



RODO MADEIRA 30CM 2700 12X1  
 Código: 37977 Fábrica: DALCIN Unidade: PT/12  
 F1 F4



RODO PLAST P/LIMPAR VIDRO 30X26CM 110-19  
 Código: 40659 Fábrica: CASA ONZE Unidade: UN/1  
 F1 F4













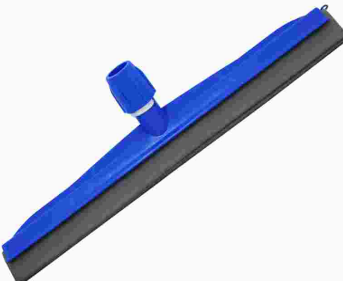





RODO PLAST PUXA SECA 30CM C/CB 5109 12X1  
 Código: 49814 Fábrica: EDS Unidade: PT/12  
 F1 F4



RODO PLAST PUXA SECA 60 CM C/CABO 5123  
 Código: 49808 Fábrica: EDS Unidade: UN/1  
 F1 F4



RODO PLAST 60 CM C/CABO MAD 85  
 Código: 50234 Fábrica: HALLEY Unidade: UN/1  
 F1 F4

 <p>RODO 45CM DRY BRALIMPIA AZUL S/CABO                  Código: <b>46721</b> Fábrica: <b>BRALIMPIA</b> Unidade: <b>UN/1</b>  <b>F1 F4</b></p>	 <p>ROLETE PLAST P/PAPEL HIGIENICO 1053 12X1                  Código: <b>33289</b> Fábrica: <b>JWC</b> Unidade: <b>PT/1</b>  <b>F1 F4</b></p>	 <p>ROLO MADEIRA P/MASSA 107                  Código: <b>41319</b> Fábrica: <b>MAD LAR</b> Unidade: <b>UN/1</b>  <b>F1 F4</b></p>	 <p>ROLO MADEIRA P/MASSA 4,5X40CM 083                  Código: <b>47900</b> Fábrica: <b>CASITA</b> Unidade: <b>UN/1</b>  <b>F1 F4</b> <span style="float: right;">40cm</span></p>
 <p>SABONETEIRA PET PLAST 500ML TRANSP 7632                  Código: <b>47359</b> Fábrica: <b>ALTIHOME</b> Unidade: <b>UN/1</b>  <b>F1 F4</b></p>	 <p>SABONETEIRA PLAST C/TELA 605 <span style="float: right;">10cm</span>                  Código: <b>12167</b> Fábrica: <b>JAGUAR</b> Unidade: <b>UN/1</b>  <b>F1 F4</b></p>	 <p>SACO P/LAVAR ROUPA 30X40CM 19006/15885                  Código: <b>36951</b> Fábrica: <b>ALIANCA</b> Unidade: <b>UN/1</b>  <b>F1 F4</b></p>	 <p>SACOLA NYLON 20X38CM MARIA C/BOTAO                  Código: <b>27404</b> Fábrica: <b>FERREIRA</b> Unidade: <b>UN/1</b>  <b>F1 F4</b></p>
 <p>SACOLA NYLON 24X36CM P UTIL C/ZIPER                  Código: <b>27401</b> Fábrica: <b>FERREIRA</b> Unidade: <b>UN/1</b>  <b>F1 F4</b></p>	 <p>SACOLA NYLON 32X29CM TULIPA                  Código: <b>29114</b> Fábrica: <b>FERREIRA</b> Unidade: <b>UN/1</b>  <b>F1 F4</b></p>	 <p>SACOLA NYLON 37X36CM ECONOMICA TRAD                  Código: <b>27402</b> Fábrica: <b>FERREIRA</b> Unidade: <b>UN/1</b>  <b>F1 F4</b></p>	 <p>SACOLA NYLON 39X41CM M TRAD                  Código: <b>27400</b> Fábrica: <b>FERREIRA</b> Unidade: <b>UN/1</b>  <b>F1 F4</b></p>
 <p>SACOLA NYLON 40X39CM FERREIRA                  Código: <b>27403</b> Fábrica: <b>FERREIRA</b> Unidade: <b>UN/1</b>  <b>F1 F4</b></p>	 <p>SACOLA PLAST PRES 20X30CM ESTAMP 100X1                  Código: <b>49637</b> Fábrica: <b>WINMAX</b> Unidade: <b>PT/100</b>  <b>F1 F4</b></p>	 <p>SACOLA PLAST PRES 25X35CM ESTAMP 100X1                  Código: <b>49638</b> Fábrica: <b>WINMAX</b> Unidade: <b>PT/100</b>  <b>F1 F4</b></p>	 <p>SACOLA PLAST PRES 30X40CM ESTAMP 100X1                  Código: <b>49639</b> Fábrica: <b>WINMAX</b> Unidade: <b>PT/100</b>  <b>F1 F4</b></p>



SACOLA PLAST PRES 35X45CM ESTAMP 100X1  
 Código: 49640 Fábrica: WINMAX Unidade: PT/100  
 F1 F4

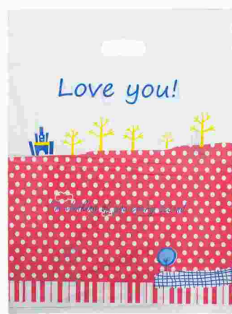

SACOLA PLAST PRES 40X50CM ESTAMP 100X1  
 Código: 49641 Fábrica: WINMAX Unidade: PT/100  
 F1 F4



SACOLA PLAST 45X50X20CM ESTAMP 150-11  
 Código: 42402 Fábrica: NICOBEM Unidade: UN/1  
 F1 F4



SACOLA PLAST 60X45X20CM ESTAMP 756  
 Código: 45911 Fábrica: WINMAX Unidade: UN/1  
 F1 F4

45cm  
 60cm  
 20cm



SACOLA PLAST 800X60X25CM ESTAMP 758  
 Código: 45912 Fábrica: WINMAX Unidade: UN/1  
 F1 F4

60cm  
 80cm  
 25cm



SALADEIRA PLAST C/TAMPA GDE 10,0LTS 825  
 Código: 39560 Fábrica: LUMAR Unidade: UN/1  
 F1 F4

10 lts



SALADEIRA PLAST C/TAMPA GDE 3,0LTS 854  
 Código: 39558 Fábrica: LUMAR Unidade: UN/1  
 F1 F4

3 lts



SALADEIRA PLAST C/TAMPA GDE 6,0LTS 820  
 Código: 39559 Fábrica: LUMAR Unidade: UN/1  
 F1 F4

6 lts



SALADEIRA PLAST C/TAMPA MED 1,5LTS 853  
 Código: 39557 Fábrica: LUMAR Unidade: UN/1  
 F1 F4

1 lts



SALADEIRA PLAST C/TAMPA PEQ 800ML 852  
 Código: 39556 Fábrica: LUMAR Unidade: UN/1  
 F1 F4

0,8 lts



SALADEIRA PLAST C/TPA ONDUL 2,6 LTS 42  
 Código: 49705 Fábrica: NOVA ERA Unidade: UN/1  
 F1 F4

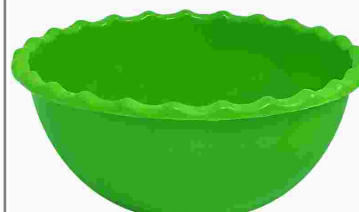

SALADEIRA PLAST GDE S/TAMPA 25X10CM 1053  
 Código: 36962 Fábrica: ENGIPLAST Unidade: UN/1  
 F1 F4



SALADEIRA PLAST MED S/TAMPA 20X8CM 1052  
 Código: 36961 Fábrica: ENGIPLAST Unidade: UN/1  
 F1 F4



SALADEIRA PLAST PEQ C/TAMPA 15X6CM 1055  
 Código: 36957 Fábrica: ENGIPLAST Unidade: UN/1  
 F1 F4



SALADEIRA PLAST PEQ S/TAMPA 15X6CM 1051  
 Código: 36960 Fábrica: ENGIPLAST Unidade: UN/1  
 F1 F4



SALEIRO CRISTAL P/MESA 700  
 Código: 37260 Fábrica: LUMAR Unidade: UN/1  
 F1 F4



SALEIRO PLAST GRANDE 366  
 Código: 10174 Fábrica: TRITEC Unidade: UN/1  
 F1 F4



SANDUICHEIRA REF 1315  
 Código: 11029 Fábrica: PLASUTIL Unidade: UN/1  
 F1 F4

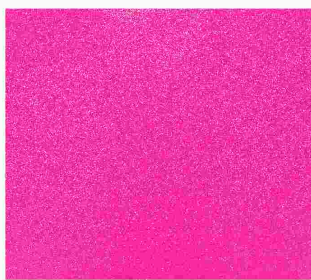

SELADORA PLAST 10X4CM PILHA AA 37-26  
 Código: 46967 Fábrica: NICOBEM Unidade: UN/1  
 F1 F4



SEMENTE ABOBORA HIROKO 550MG 25X1  
 Código: 33984 Fábrica: FELTRIN Unidade: PT/25  
 F1 F4

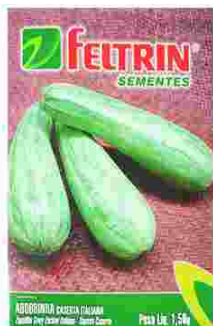

SEMENTE ABOBRINHA CASERT ITAL 1,50G 25X1  
 Código: 31427 Fábrica: FELTRIN Unidade: PT/25  
 F1 F4



SEMENTE ALFACE AMERICANA 700MG 25X1  
 Código: 31435 Fábrica: FELTRIN Unidade: PT/25  
 F1 F4



SEMENTE ALFACE MONICA 700MG 25X1  
 Código: 31423 Fábrica: FELTRIN Unidade: PT/25  
 F1 F4



SEMENTE ALMEIRAO PAO D ACUCAR 700MG 25X1  
 Código: 31410 Fábrica: FELTRIN Unidade: PT/25  
 F1 F4



SEMENTE BERINGELA EMBU 400MG 25X1  
 Código: 32288 Fábrica: FELTRIN Unidade: PT/25  
 F1 F4



SEMENTE BETERRABA KATRINA 1,20G 25X1  
 Código: 31419 Fábrica: FELTRIN Unidade: PT/25  
 F1 F4



SEMENTE CEBOLINHA NEBUKA 400MG 25X1  
 Código: 31440 Fábrica: FELTRIN Unidade: PT/25  
 F1 F4

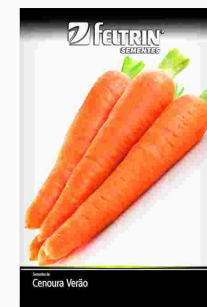

SEMENTE CENOURA BRASILIA IRECE 700G 25X1  
 Código: 31413 Fábrica: FELTRIN Unidade: PT/25  
 F1 F4



SEMENTE COENTRO PACIFICO 1,60G 25X1  
 Código: 32283 Fábrica: FELTRIN Unidade: PT/25  
 F1 F4



SEMENTE COENTRO VERDAO 1,6G 25X1  
 Código: 31418 Fábrica: FELTRIN Unidade: PT/25  
 F1 F4



SEMENTE COUVE MANTEIGA 1,00G 25X1  
 Código: 31431 Fábrica: FELTRIN Unidade: PT/25  
 F1 F4



SEMENTE JILO COMPRIDO GDE RIO 400MG 25X1  
 Código: 32302 Fábrica: FELTRIN Unidade: PT/25  
 F1 F4



SEMENTE MAMAO FORMOSA 120MG 25X1

Código: **31422** Fábrica: **FELTRIN** Unidade: **PT/25 F1 F4**



SEMENTE MELAO GAUCHO 100MG 20X1

Código: **32291** Fábrica: **FELTRIN/HORT** Unidade: **PT/20 F1 F4**



SEMENTE MORANGA EXPOSITAO 2,00G 25X1

Código: **31439** Fábrica: **FELTRIN** Unidade: **PT/25 F1 F4**



SEMENTE PIMENTA BICO 400MG 25X1

Código: **31429** Fábrica: **FELTRIN** Unidade: **PT/25 F1 F4**



SEMENTE PIMENTA CAYENNE LONG 400MG 25X1

Código: **32290** Fábrica: **FELTRIN** Unidade: **PT/25 F1 F4**



SEMENTE PIMENTA DEDO DE MOCA 400MG 25X1

Código: **49387** Fábrica: **FELTRIN** Unidade: **PT/25 F1 F4**



SEMENTE PIMENTAO AMARELO 400MG 25X1

Código: **49386** Fábrica: **FELTRIN** Unidade: **PT/25 F1 F4**



SEMENTE PIMENTAO RUBI GIGANTE 400MG 25X1

Código: **31412** Fábrica: **FELTRIN** Unidade: **PT/25 F1 F4**

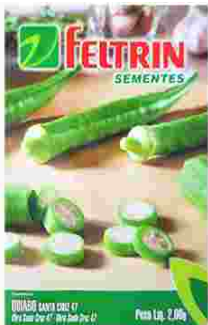

SEMENTE QUIABO SANTA CRUZ 2,00G 25X1

Código: **31411** Fábrica: **FELTRIN** Unidade: **PT/25 F1 F4**



SEMENTE RABANETE CRIMSON GIG 1,40G 25X1

Código: **31432** Fábrica: **FELTRIN** Unidade: **PT/25 F1 F4**



SEMENTE RUCULA CULTIVADA 1G 25X1

Código: **31424** Fábrica: **FELTRIN** Unidade: **PT/25 F1 F4**

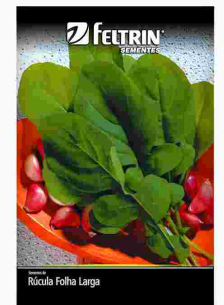

SEMENTE RUCULA FOLHA LARGA 700MG 25X1

Código: **32293** Fábrica: **FELTRIN** Unidade: **PT/25 F1 F4**



SEMENTE SALSA GRAUDA PORT NOV 900MG 25X1

Código: **31420** Fábrica: **FELTRIN** Unidade: **PT/25 F1 F4**



SEMENTE SALSA LISA 900MG 25X1

Código: **31434** Fábrica: **FELTRIN** Unidade: **PT/25 F1 F4**



SEMENTE TOMATE CAROLINA 100MG 25X1

Código: **31416** Fábrica: **FELTRIN** Unidade: **PT/25 F1 F4**

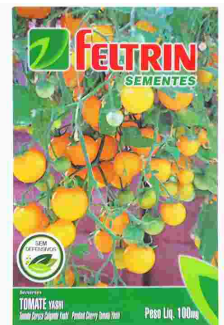

SEMENTE TOMATE YASHI 100MG 25X1

Código: **35086** Fábrica: **FELTRIN** Unidade: **PT/25 F1 F4**



SOCADOR FEIJAO 28 CM MADEIRA 115

Código: 1485  
 Fábrica: MAD LAR  
 Unidade: UN/1  
 F1 F4



SOLO (SUBSTRATO) 2 KG

Código: 31469  
 Fábrica: NOVATROPICAL  
 Unidade: PT/1  
 F1 F4



SOLO (SUBSTRATO) 5 KG

Código: 31470  
 Fábrica: NOVATROPICAL  
 Unidade: PT/1  
 F1 F4



SOLO (SUBSTRATO) 20 KG

Código: 31472  
 Fábrica: NOVATROPICAL  
 Unidade: PT/1  
 F1 F4



30cm

SOUPLA MDF 30CM 174

Código: 45986  
 Fábrica: R A ARTESANA  
 Unidade: UN/1  
 F1 F4



SQUEEZE PLAST 300 ML (GALAOZINHO) 982

Código: 49707  
 Fábrica: NOVA ERA  
 Unidade: UN/1  
 F1 F4



SQUEEZE PLAST 300 ML (GARRAFA) COLOR 972

Código: 49719  
 Fábrica: NOVA ERA  
 Unidade: UN/1  
 F1 F4



SQUEEZE PLAST 350 ML 846

Código: 35843  
 Fábrica: LUMAR  
 Unidade: UN/1  
 F1 F4



SQUEEZE PLAST 360ML REFIL FLAMENGO 10625

Código: 41106  
 Fábrica: BRASFOOT  
 Unidade: UN/1  
 F1 F4



SQUEEZE PLAST 500 ML (GARRAFA) COLOR 962

Código: 49712  
 Fábrica: NOVA ERA  
 Unidade: UN/1  
 F1 F4



SQUEEZE PLAST 600 ML (GARRAFA) QUAD 1199

Código: 49706  
 Fábrica: NOVA ERA  
 Unidade: UN/1  
 F1 F4



SQUEEZE PLAST 750 ML (GARRAFA) COLOR 952

Código: 49709  
 Fábrica: NOVA ERA  
 Unidade: UN/1  
 F1 F4



SQUEEZE 250 ML PLAST ARANHA 479

Código: 41636  
 Fábrica: QUALYPLAS  
 Unidade: UN/1  
 F1 F4



SQUEEZE 250 ML PLAST COELHO 584

Código: 41637  
 Fábrica: QUALYPLAS  
 Unidade: UN/1  
 F1 F4



SQUEEZE 250 ML PLAST DINOSSAURO 135/480

Código: 41635  
 Fábrica: QUALYPLAS  
 Unidade: UN/1  
 F1 F4



SQUEEZE 250 ML PLAST DRAGAO 1202

Código: 50341  
 Fábrica: QUALYPLAS  
 Unidade: UN/1  
 F1 F4



SQUEEZE 250 ML PLAST FROOZER 130/136

Código: 41645  
 Fábrica: QALYPLAS  
 Unidade: UN/1  
 F1 F4



SQUEEZE 250 ML PLAST PRINCESA 1142

Código: 50340  
 Fábrica: QALYPLAS  
 Unidade: UN/1  
 F1 F4



SQUEEZE 250 ML PLAST SEREIA 482

Código: 41638  
 Fábrica: QALYPLAS  
 Unidade: UN/1  
 F1 F4



SQUEEZE 250 ML PLAST TUBARAO 138/485

Código: 41640  
 Fábrica: QALYPLAS  
 Unidade: UN/1  
 F1 F4



SQUEEZE 250 ML PLAST UNICORNIO 483

Código: 41639  
 Fábrica: QALYPLAS  
 Unidade: UN/1  
 F1 F4



SQUEEZE 250 ML PLAST VIDEO GAME 1141

Código: 50342  
 Fábrica: QALYPLAS  
 Unidade: UN/1  
 F1 F4



SQUEEZE 600 ML PLAST NEON AZUL TPA CLICK

Código: 49827  
 Fábrica: CREATIVE  
 Unidade: UN/1  
 F1 F4



SQUEEZE 600 ML PLAST NEON ROSA TPA CLICK

Código: 49828  
 Fábrica: CREATIVE  
 Unidade: UN/1  
 F1 F4



SQUEEZE 700 ML PLAST DIAMANT FUME 22390

Código: 49822  
 Fábrica: CREATIVE  
 Unidade: UN/1  
 F1 F4



SQUEEZE 700 ML PLAST DIAMANT TIFFAN 2391

Código: 49823  
 Fábrica: CREATIVE  
 Unidade: UN/1  
 F1 F4



SQUEEZE 700 ML PLAST TOP TRANS FUME 2393

Código: 49824  
 Fábrica: CREATIVE  
 Unidade: UN/1  
 F1 F4



SQUEEZE 700 ML PLAST TOP TRANS TIFFA 384

Código: 49825  
 Fábrica: CREATIVE  
 Unidade: UN/1  
 F1 F4



SQUEEZE 700 ML PLAST TOP TRANS TPA COLOR

Código: 49826  
 Fábrica: CREATIVE  
 Unidade: UN/1  
 F1 F4

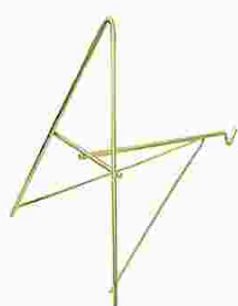

SUPORTE A MED METAL DOURADO P/PLANTAS

Código: 18493  
 Fábrica: NUTRIPLAN  
 Unidade: UN/1  
 F1 F4

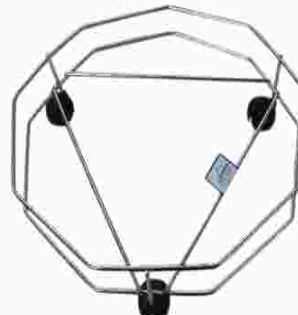

SUPORTE CROM BOTTILAO REFOR C/RODINHAS 21

Código: 24069  
 Fábrica: ARAMINAS  
 Unidade: UN/1  
 F1 F4



SUPORTE CROM BOTTILAO TUBULAR C/ROD 799

Código: 33634  
 Fábrica: ARAMINAS  
 Unidade: UN/1  
 F1 F4

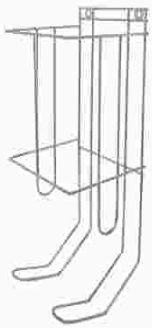

SUPORTE CROM P/PAPEL HIGIENICO 87

Código: **28961** Fábrica: **ARAMINAS** Unidade: **UN/1**  
F1 F4

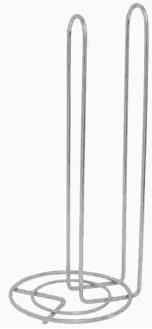

SUPORTE CROM P/PAPEL TOALHA DE MESA 89

Código: **38982** Fábrica: **ARAMINAS** Unidade: **UN/1**  
F1 F4

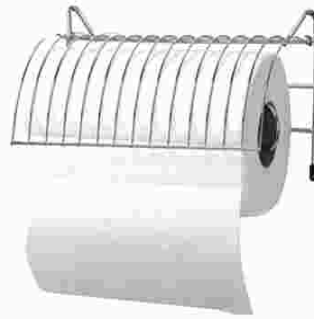

SUPORTE CROM P/PAPEL TOALHA PAREDE 22

Código: **18739** Fábrica: **ARAMINAS** Unidade: **UN/1**  
F1 F4



SUPORTE CROM 20 COPOS PAREDE 52X30CM 28

Código: **24068** Fábrica: **ARAMINAS** Unidade: **UN/1**  
F1 F4

Produto  
\* Altura: 52 cm  
\* Largura: 30 cm

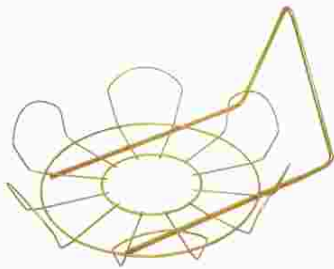

SUPORTE MARGARIDA MED DOURADO P/PLANTAS

Código: **33397** Fábrica: **NUTRIPLAN** Unidade: **UN/1**  
F1 F4



SUPORTE METAL RODIZIO PRATO 25CM PRETO

Código: **42182** Fábrica: **NUTRIPLAN** Unidade: **UN/1**  
F1 F4



SUPORTE METAL RODIZIO PRATO 28CM PRETO

Código: **42179** Fábrica: **NUTRIPLAN** Unidade: **UN/1**  
F1 F4



SUPORTE METAL RODIZIO PRATO 30CM PRETO

Código: **42180** Fábrica: **NUTRIPLAN** Unidade: **UN/1**  
F1 F4

30 cm

30 cm

30 cm



SUPORTE METAL RODIZIO PRATO 36CM PRETO

Código: **42181** Fábrica: **NUTRIPLAN** Unidade: **UN/1**  
F1 F4



SUPORTE OLEO PET 773

Código: **44719** Fábrica: **ARAMINAS** Unidade: **UN/1**  
F1 F4



SUPORTE PLAST BOTIJAJO SB054

Código: **45109** Fábrica: **BUDEPLAST** Unidade: **UN/1**  
F1 F4



SUPORTE PLAST BOTIJAJO 760

Código: **46631** Fábrica: **LUMAR** Unidade: **UN/1**  
F1 F4

36 cm



SUPORTE PLAST FILTRO CAFE 103 6920

Código: **47145** Fábrica: **INPLAST** Unidade: **UN/1**  
F1 F4



SUPORTE PLAST P/BOTIJAJO PRETO 91

Código: **22450** Fábrica: **MOLDE MINAS** Unidade: **UN/1**  
F1 F4













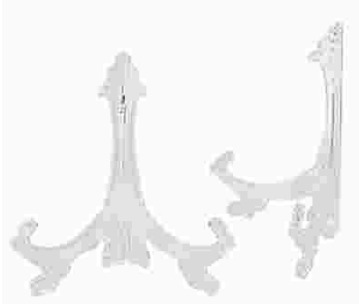



SUPORTE PLAST P/CAIXA SABAO EM PO 4418

Código: **10396** Fábrica: **NITRON** Unidade: **UN/1**  
F1 F4



SUPORTE PLAST P/GARRAFAO AGUA

Código: **50368** Fábrica: **HERC** Unidade: **UN/1**  
F1 F4

 <p>SUPORTE PLASTICO P/QUADRO CRISTAL 19 CM Código: <b>31482</b> Fábrica: <b>YING FA</b> Unidade: <b>UN/1</b> <b>F1 F4</b></p>	 <p>SUPORTE PLASTICO P/QUADRO CRISTAL 21 CM Código: <b>31483</b> Fábrica: <b>YING FA</b> Unidade: <b>UN/1</b> <b>F1 F4</b></p>	 <p>SUQUEIRA VIDRO 3,0 LTS 3182 Código: <b>34816</b> Fábrica: <b>BATIKI</b> Unidade: <b>UN/1</b> <b>F1 F4</b></p>	 <p>TABUA MAD HAMBURGUER NATURAL 20X19CM 48B Código: <b>41740</b> Fábrica: <b>DEBIASI</b> Unidade: <b>UN/1</b> <b>F1 F4</b></p>
 <p>TABUA MAD RED PETISCO NATURAL 20CM Código: <b>41741</b> Fábrica: <b>DEBIASI</b> Unidade: <b>UN/1</b> <b>F1 F4</b></p>	 <p>TABUA MAD RED P/FRIOS 25CM 57B Código: <b>41742</b> Fábrica: <b>DEBIASI</b> Unidade: <b>UN/1</b> <b>F1 F4</b></p>	 <p>TABUA MAD RED P/FRIOS C/GARF 25CM 57E Código: <b>41743</b> Fábrica: <b>DEBIASI</b> Unidade: <b>UN/1</b> <b>F1 F4</b></p>	 <p>TABUA PETISQUEIRA ACRÍ PTO 25CM Código: <b>41744</b> Fábrica: <b>DEBIASI</b> Unidade: <b>UN/1</b> <b>F1 F4</b></p>
 <p>TABUA PLAST COLOR 31X18CM 611 Código: <b>41634</b> Fábrica: <b>QUALYPLAS</b> Unidade: <b>UN/1</b> <b>F1 F4</b></p>	 <p>TABUA PLAST DE CORTE 320X220X4MM P 3050 Código: <b>46243</b> Fábrica: <b>JAGUAR</b> Unidade: <b>UN/1</b> <b>F1 F4</b></p>	 <p>TABUA PLAST DE CORTE 35X24X07CM CA08104 Código: <b>50644</b> Fábrica: <b>CASITA</b> Unidade: <b>UN/1</b> <b>F1 F4</b></p>	 <p>TABUA PLAST DE CORTE 360X260X6MM G 3051 Código: <b>49219</b> Fábrica: <b>JAGUAR</b> Unidade: <b>UN/1</b> <b>F1 F4</b></p>
 <p>TABUA PLAST DE CORTE 37X23CM 001 Código: <b>11000</b> Fábrica: <b>RIOHOME</b> Unidade: <b>UN/1</b> <b>F1 F4</b></p>	 <p>TABUA PLAST MEGA 969 Código: <b>46669</b> Fábrica: <b>LUMAR</b> Unidade: <b>UN/1</b> <b>F1 F4</b></p>	 <p>TABUA PLAST P/CARNE 36X21X0,5CM 514 Código: <b>33034</b> Fábrica: <b>TRITEC</b> Unidade: <b>UN/1</b> <b>F1 F4</b></p>	 <p>TABUA PLASTICA 33X20CM Código: <b>28706</b> Fábrica: <b>PLASTBRASIL</b> Unidade: <b>UN/1</b> <b>F1 F4</b></p>



TABULEIRO ALUM 1 ALTO 710

Código: **8256** Fábrica: **MSR** Unidade: **UN/1**  
**F1 F4**



TABULEIRO ALUM 1 PADRAO 30X21X3,0CM 715

Código: **22790** Fábrica: **MSR** Unidade: **UN/1**  
**F1 F4**



TABULEIRO ALUM 1 RET EXTRA 30X20X4,0CM

Código: **27599** Fábrica: **AVELAR** Unidade: **UN/1**  
**F1 F4**



TABULEIRO ALUM 2 ALTO 711

Código: **7908** Fábrica: **MSR** Unidade: **UN/1**  
**F1 F4**



TABULEIRO ALUM 2 PADRAO 33X23X3,0CM 716

Código: **8257** Fábrica: **MSR** Unidade: **UN/1**  
**F1 F4**



TABULEIRO ALUM 2 RET EXTRA 33X23X4,0CM

Código: **22791** Fábrica: **AVELAR** Unidade: **UN/1**  
**F1 F4**



TABULEIRO ALUM 3 ALTO 712

Código: **7909** Fábrica: **MSR** Unidade: **UN/1**  
**F1 F4**



TABULEIRO ALUM 3 PADRAO 40X30X3,5CM 717

Código: **22792** Fábrica: **MSR** Unidade: **UN/1**  
**F1 F4**



TABULEIRO ALUM 3 RET EXTRA 37X26X4,0CM

Código: **27601** Fábrica: **AVELAR** Unidade: **UN/1**  
**F1 F4**



TABULEIRO ALUM 4 ALTO 713 ASSAD 42X29X6

Código: **7911** Fábrica: **MSR** Unidade: **UN/1**  
**F1 F4**



TABULEIRO ALUM 4 PADRAO 45X33X4,0CM 718

Código: **22793** Fábrica: **MSR** Unidade: **UN/1**  
**F1 F4**



TABULEIRO ALUM 4 RET EXTRA 42X30X4,0CM

Código: **27602** Fábrica: **AVELAR** Unidade: **UN/1**  
**F1 F4**



TABULEIRO ALUM 5 ALTO 714

Código: **11262** Fábrica: **MSR** Unidade: **UN/1**  
**F1 F4**



TABULEIRO ALUM 5 PADRAO 48X35X4,5CM 719

Código: **22794** Fábrica: **MSR** Unidade: **UN/1**  
**F1 F4**



TABULEIRO ALUM 5 RET EXTRA 46X33X4,0CM

Código: **27603** Fábrica: **AVELAR** Unidade: **UN/1**  
**F1 F4**



TACA ACRILICO 190ML CHAMPANHE CRISTAL 14

Código: **50344** Fábrica: **QUALYPLAS** Unidade: **UN/1**  
**F1 F4**



TACA PLAST 360ML GIN BICOLOR VC11327 2X1  
 Código: 41130 Fábrica: BRASFOOT Unidade: CJ/2  
 F1 F4



TACA PLAST 580ML DEGRADE GIN 10565 2X1  
 Código: 39133 Fábrica: BRASFOOT Unidade: CJ/2  
 F1 F4



TACA PLAST 580ML DEGRADE GIN 10570 2X1  
 Código: 39134 Fábrica: BRASFOOT Unidade: CJ/2  
 F1 F4



TACA PLAST 580ML GIN ATLETICO 10800 2X1  
 Código: 41128 Fábrica: BRASFOOT Unidade: UN/1  
 F1 F4



TACA PLAST 580ML GIN FLAMENGO 10801 2X1  
 Código: 41129 Fábrica: BRASFOOT Unidade: CJ/2  
 F1 F4



TACA PLASTICO COPACABANA GDE 073  
 Código: 27699 Fábrica: HEMITOYS Unidade: UN/1  
 F1 F4



TACA VIDRO 300ML CERVEJA COLECCION 524093  
 Código: 39258 Fábrica: FRATELLI Unidade: UN/1  
 F1 F4



TACA VIDRO 300ML WINDSOR AGRADECA 2611  
 Código: 39034 Fábrica: BRASFOOT Unidade: UN/1  
 F1 F4



TACA VIDRO 300ML WINDSOR BEBO PRA E 2612  
 Código: 39031 Fábrica: BRASFOOT Unidade: UN/1  
 F1 F4



TACA VIDRO 300ML WINDSOR E MELHOR U 2613  
 Código: 39033 Fábrica: BRASFOOT Unidade: UN/1  
 F1 F4



TACA VIDRO 300ML WINDSOR FLAMENGO 1551  
 Código: 39026 Fábrica: BRASFOOT Unidade: UN/1  
 F1 F4



TACA VIDRO 300ML WINDSOR FLAMENGO 2661  
 Código: 39030 Fábrica: BRASFOOT Unidade: UN/1  
 F1 F4



TACA VIDRO 300ML WINDSOR QUEM BEBE 2610  
 Código: 39032 Fábrica: BRASFOOT Unidade: UN/1  
 F1 F4



TACA VIDRO 330ML WINDSOR ADORO 11597 2X1  
 Código: 41115 Fábrica: BRASFOOT Unidade: CJ/2  
 F1 F4

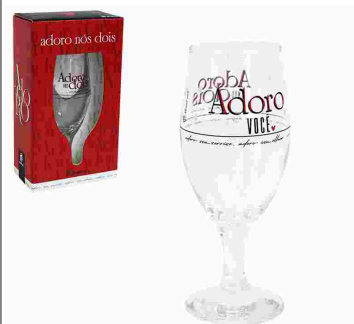

TACA VIDRO 330ML WINDSOR ADORO 11600  
 Código: 41117 Fábrica: BRASFOOT Unidade: UN/1  
 F1 F4



TACA VIDRO 330ML+AVENTAL ATLETICO 10000  
 Código: 41114 Fábrica: BRASFOOT Unidade: UN/1  
 F1 F4



TACA VIDRO 330ML+AVENTAL CRUZEIRO 10001  
 Código: 41113 Fábrica: BRASFOOT Unidade: UN/1  
 F1 F4



TACA VIDRO 385ML VINHO ADORO 11609  
 Código: 41118 Fábrica: BRASFOOT Unidade: UN/1  
 F1 F4



TACA VIDRO 40ML TRANSP 23353 6X1  
 Código: 36756 Fábrica: MABEL Unidade: CX/6  
 F1 F4



TACA VIDRO 40ML TRANSP 23354 6X1  
 Código: 36757 Fábrica: MABEL Unidade: CX/6  
 F1 F4



TACA VIDRO 400ML DUBLIN ATLETICO 10451  
 Código: 39109 Fábrica: BRASFOOT Unidade: UN/1  
 F1 F4



TACA VIDRO 400ML DUBLIN FLAMENGO 10453  
 Código: 39023 Fábrica: BRASFOOT Unidade: UN/1  
 F1 F4



TAMPA PLAST P/LAVATORIO PIA TV51N 100X1  
 Código: 33734 Fábrica: REBOUCAS Unidade: PT/100  
 F1 F4



TAMPA PLAST P/TANQUE TV52N 100X1  
 Código: 33733 Fábrica: REBOUCAS Unidade: PT/100  
 F1 F4



TAPETE ANTID BANHEIRO BCO 66X36CM 619  
 Código: 44508 Fábrica: PLANETA Unidade: UN/1  
 F1 F4



TAPETE ANTID BANHEIRO TRANSP 66X36CM 625  
 Código: 44509 Fábrica: PLANETA Unidade: UN/1  
 F1 F4



TAPETE ANTID BOX TRANSP 65X35CM 7692  
 Código: 47360 Fábrica: ALTIHOME Unidade: UN/1  
 F1 F4

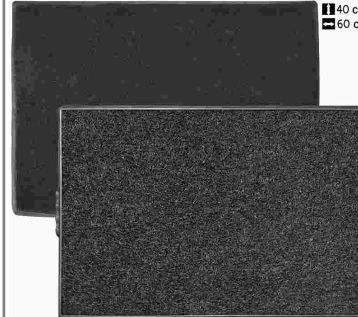

TAPETE BALME 40X60CM CORES 091  
 Código: 36935 Fábrica: RIOHOME Unidade: UN/1  
 F1 F4



TAPETE FIBRA COCO BORRACHA 40X60CM 088  
 Código: 49365 Fábrica: RIOHOME Unidade: UN/1  
 F1 F4



TAPETE MICROFIBRA ANTIDER 38X58CM 064  
 Código: 49363 Fábrica: RIOHOME Unidade: UN/1  
 F1 F4



TAPETE MICROFIBRA 38X58CM SOFT BALL 027  
 Código: 49364 Fábrica: RIOHOME Unidade: UN/1  
 F1 F4



TAPETE POLIESTER BEM VINDO 37X57CM 11611  
 Código: 44515 Fábrica: NICOBEM Unidade: UN/1  
 F1 F4

37cm  
57cm



TAPETE POLIESTER BEM VINDO 37X57CM 2167

Código: 47094 Fábrica: GP6 Unidade: UN/1  
F1 F4

39 cm  
59 cm



TAPETE POP POLIESTER ANTIDERRAP 59X39CM

Código: 39967 Fábrica: PERFETTO Unidade: RL/1  
F1 F4



TAPETE PVC ANTID BOX CORUJA 67X35CM 4048

Código: 47897 Fábrica: CASITA Unidade: UN/1  
F1 F4



TAPETE PVC/FLAN BANH CORUJA 40X60CM 4046

Código: 47898 Fábrica: CASITA Unidade: UN/1  
F1 F4

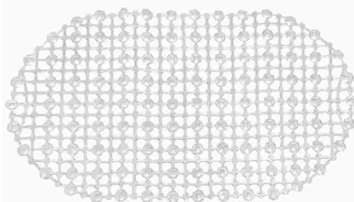

TAPETE SILIC ANTID BANHEIRO 62X35CM 7040

Código: 41536 Fábrica: ELITE Unidade: UN/1  
F1 F4



TEE 1/2 ACOPLAR MANGUEIRA PTO TE51N 50X1

Código: 40149 Fábrica: REBOUCAS Unidade: PT/50  
F1 F4



TEE 3/4 ACOPLAR MANGUEIRA PTO TE52N 50X1

Código: 40150 Fábrica: REBOUCAS Unidade: PT/50  
F1 F4



TERRA ESP P/CACTOS E SUCULENTAS 1,5 KG

Código: 35708 Fábrica: NUTRIPLAN Unidade: PT/1  
F1 F4



TERRA ORQUÍDEA 1 LITRO

Código: 48526 Fábrica: NOVATROPICAL Unidade: PT/1  
F1 F4



TERRA SAMAMBAIA 1 LITRO

Código: 48527 Fábrica: NOVATROPICAL Unidade: PT/1  
F1 F4



TERRA SAMAMBAIA 1,5 KG

Código: 22287 Fábrica: VITAPLAN Unidade: PT/1  
F1 F4



TERRA SAMAMBAIA 2 KG

Código: 47464 Fábrica: VITAPLAN Unidade: KG/1  
F1 F4



TERRA VEGETAL 2 KG

Código: 19888 Fábrica: NOVATROPICAL Unidade: PT/1  
F1 F4



TERRA VEGETAL 5 KG

Código: 19889 Fábrica: NOVATROPICAL Unidade: PT/1  
F1 F4



TERRA VEGETAL 10 KG

Código: 30504 Fábrica: NOVATROPICAL Unidade: PT/1  
F1 F4



TERRA VEGETAL 20 KG

Código: 30765 Fábrica: NOVATROPICAL Unidade: PT/1  
F1 F4



TERRA VEGETAL 25 KG  
 Código: 47378  
 Fábrica: NOVATROPICAL  
 Unidade: PT/1  
 F1 F4



TIGELA ACRILIC BOWL C/TAMPA COLOR 33127  
 Código: 41214  
 Fábrica: PLASTSU  
 Unidade: UN/1  
 F1 F4



TIGELA ALUM 20 1197  
 Código: 45284  
 Fábrica: MSR  
 Unidade: UN/1  
 F1 F4



TIGELA PLASTICA BOWL 350 ML 115  
 Código: 14583  
 Fábrica: ECOPLASTIC  
 Unidade: UN/1  
 F1 F4



12,5 cm  
 10,5 cm  
 620 ml

TIGELA VIDRO 620ML PREMIERE 1067 24X1  
 Código: 39522  
 Fábrica: MULTIPRESENT  
 Unidade: CX/24  
 F1 F4



TOALHA BANHO PROF 1,30X70XM BRANCA  
 Código: 47342  
 Fábrica: MARCOTEX  
 Unidade: UN/1  
 F1 F4



TOALHA LAVABO SLIM 45X29CM AMARELO 12X1  
 Código: 47661  
 Fábrica: MARCOTEX  
 Unidade: PT/12  
 F1 F4

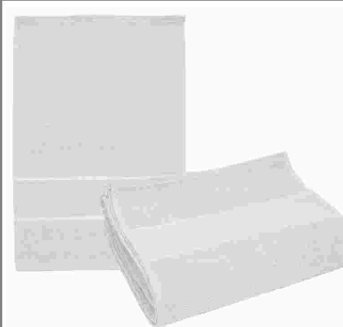

TOALHA LAVABO SLIM 45X29CM BRANCO 6X1  
 Código: 47654  
 Fábrica: MARCOTEX  
 Unidade: PT/6  
 F1 F4



TOALHA LAVABO SLIM 45X29CM LARANJA 6X1  
 Código: 47660  
 Fábrica: MARCOTEX  
 Unidade: PT/12  
 F1 F4



TOALHA LAVABO SLIM 45X29CM ROSA FLOR12X1  
 Código: 47657  
 Fábrica: MARCOTEX  
 Unidade: PT/12  
 F1 F4

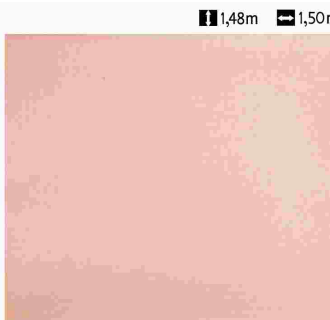

1,48m 1,50m

TOALHA MESA PANO 1,48X1,50M LISA 1101  
 Código: 40444  
 Fábrica: SUN WELLS  
 Unidade: UN/1  
 F1 F4

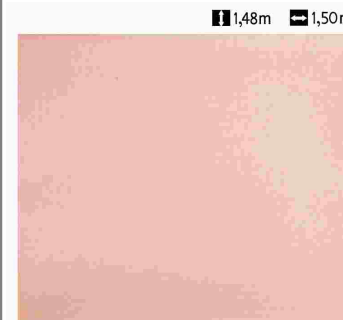

1,48m 1,50m

TOALHA MESA PANO 1,48X1,50M NATAL  
 Código: 40446  
 Fábrica: SUN WELLS  
 Unidade: UN/1  
 F1 F4



1,50m 2,20m

TOALHA MESA PANO 2,20X1,50M ESTAMP  
 Código: 40447  
 Fábrica: SUN WELLS  
 Unidade: UN/1  
 F1 F4



TOALHA MULTIUSO MICROFIBRA 30X30CM 163  
 Código: 50790  
 Fábrica: HOME&MORE  
 Unidade: UN/1  
 F1 F4



TOALHA SOCIAL LISA 36X23CM BRANCO 12X1  
 Código: 47668  
 Fábrica: MARCOTEX  
 Unidade: PT/12  
 F1 F4



TOALHA SOCIAL LISA 36X23CM PRETO 12X1  
 Código: 47669  
 Fábrica: MARCOTEX  
 Unidade: PT/12  
 F1 F4

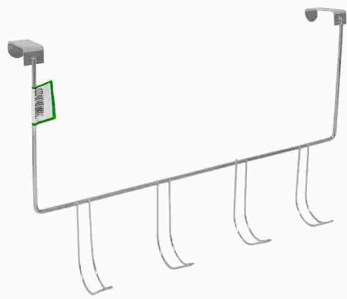

TOALHEIRO CROM DE PORTA 67

Código: **28958** Fábrica: **ARAMINAS** Unidade: **UN/1**  
F1 F4



TOALHEIRO CROM PAREDE N1 1 GANCHO 64

Código: **44242** Fábrica: **ARAMINAS** Unidade: **UN/1**  
F1 F4



TOALHEIRO CROM PAREDE N4 4 GANCHOS 66

Código: **40516** Fábrica: **ARAMINAS** Unidade: **UN/1**  
F1 F4



TORNEIRA JARDIM 1/2 C/BIC COL TVC1N 12X1

Código: **33726** Fábrica: **REBOUCAS** Unidade: **PT/12**  
F1 F4



TORNEIRA JARDIM 1/2 C/BICO PT TTV1N 12X1

Código: **30743** Fábrica: **REBOUCAS** Unidade: **PT/12**  
F1 F4



TORNEIRA JARDIM 3/4 1/2 10CM C/B B1N12X1

Código: **51130** Fábrica: **REBOUCAS** Unidade: **PT/12**  
F1 F4



TORNEIRA JARDIM 3/4 1/2 10CM C/B R1N12X1

Código: **35660** Fábrica: **REBOUCAS** Unidade: **PT/12**  
F1 F4



TORNEIRA P/FILTRO AUTOM MARROM 342 12X1

Código: **8042** Fábrica: **MINERAL** Unidade: **PT/12**  
F1 F4



TORNEIRA P/FILTRO CROMO AUTOMAT 31 12X1

Código: **27209** Fábrica: **MINERAL** Unidade: **PT/12**  
F1 F4



TORNEIRA P/FILTRO MANUAL MARROM 341 12X1

Código: **8043** Fábrica: **MINERAL** Unidade: **PT/12**  
F1 F4



TORNEIRA P/FILTRO TOC BRANCA 86 12X1

Código: **28807** Fábrica: **MINERAL** Unidade: **PT/12**  
F1 F4

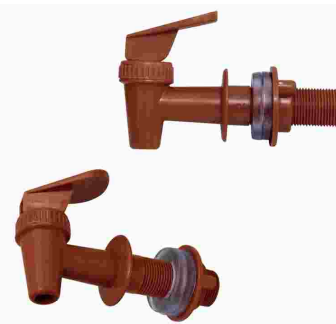

TORNEIRA P/FILTRO TOC MARROM 34 12X1

Código: **38332** Fábrica: **MINERAL** Unidade: **PT/12**  
F1 F4



TORNEIRA PIA LG 3/4 1/2 15CM C/B18N 12X1

Código: **47223** Fábrica: **REBOUCAS** Unidade: **PT/12**  
F1 F4

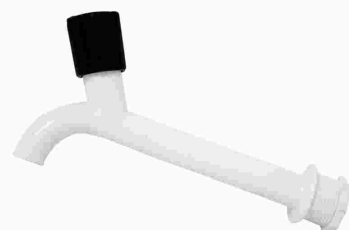

TORNEIRA PIA LONG 3/4 1/2 15CM TR5N 12X1

Código: **35659** Fábrica: **REBOUCAS** Unidade: **PT/12**  
F1 F4

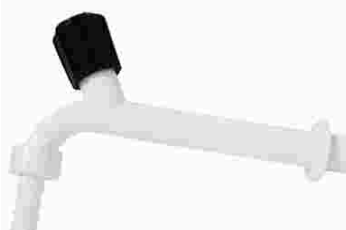

TORNEIRA PIA LONGA 1/2 15CM C/B 18N 12X1

Código: **33722** Fábrica: **REBOUCAS** Unidade: **PT/12**  
F1 F4



TORNEIRA PIA LONGA 1/2 15CM TTV5N 12X1

Código: **30742** Fábrica: **REBOUCAS** Unidade: **PT/12**  
F1 F4



TORNEIRA PIA LONGA 3/4X1/2 15CM TV5N UN

Código: **39370** Fábrica: **REBOUCAS** Unidade: **UN/1**  
F1 F4



TORNEIRA PIA 3/4X1/2 15CM UNIV TV5N 12X1

Código: **33729** Fábrica: **REBOUCAS** Unidade: **PT/12**  
F1 F4

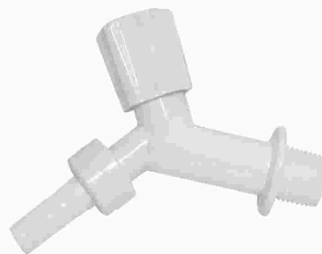

TORNEIRA PIA/TANQUE 1/2 15CM TVC5N 12X1

Código: **34844** Fábrica: **REBOUCAS** Unidade: **PT/12**  
F1 F4

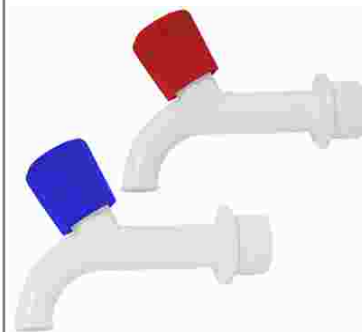

TORNEIRA PIA/TANQUE 3/4 10CM CL C4N 12X1

Código: **33727** Fábrica: **REBOUCAS** Unidade: **PT/12**  
F1 F4

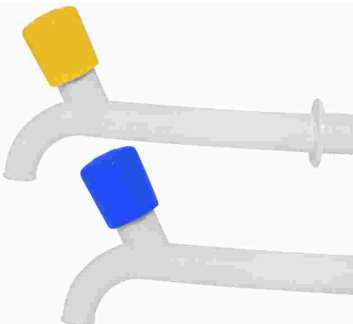

TORNEIRA P/JARDIM 1/2 10CM C/B VB1N 12X1

Código: **34846** Fábrica: **REBOUCAS** Unidade: **PT/12**  
F1 F4



TORNEIRA PLAST ESFERA 1/2 10CM UN

Código: **46804** Fábrica: **CAERUS** Unidade: **UN/1**  
F1 F4



TORNEIRA P/LAVATORIO 1/2 TTV7N 12X1

Código: **33217** Fábrica: **REBOUCAS** Unidade: **PT/12**  
F1 F4



TORNEIRA TANQ/MAQ 1/2 10CM C/A TV20N12X1

Código: **34845** Fábrica: **REBOUCAS** Unidade: **PT/12**  
F1 F4



TORNEIRA TANQUE CURT 1/2 10CM TTV3N 12X1

Código: **32565** Fábrica: **REBOUCAS** Unidade: **PT/12**  
F1 F4



TORNEIRA TANQUE 1/2 10CM C/B16N 12X1

Código: **33723** Fábrica: **REBOUCAS** Unidade: **PT/12**  
F1 F4



TORNEIRA TANQUE 3/4X1/2 10CM U TR3N 12X1

Código: **48609** Fábrica: **REBOUCAS** Unidade: **PT/12**  
F1 F4



TORNEIRA TANQUE 3/4X1/2 10CM U TV3N UN

Código: **40675** Fábrica: **REBOUCAS** Unidade: **PT/1**  
F1 F4



TORNEIRA TANQUE 3/4X1/2 10CM U TV3N 12X1

Código: **33730** Fábrica: **REBOUCAS** Unidade: **PT/12**  
F1 F4



TORNEIRA TANQUE/PIA 3/4 10CM TTV4N 12X1

Código: **31572** Fábrica: **REBOUCAS** Unidade: **PT/12**  
F1 F4



TRAVESSA ALUM PORCAO 1

Código: **37341** Fábrica: **MSR** Unidade: **UN/1**  
F1 F4



TRAVESSA ALUM PORCAO 2 1194

Código: **37342** Fábrica: **MSR** Unidade: **UN/1**  
F1 F4



TRAVESSA ALUM PORCAO 3

Código: **37343** Fábrica: **MSR** Unidade: **UN/1**  
F1 F4



TRAVESSA INOX 31X21CM (TABULEIRO)800-11

Código: **40530** Fábrica: **CASA ONZE** Unidade: **UN/1**  
F1 F4



TRAVESSA INOX 39X29CM (TABULEIRO)800-13

Código: **40658** Fábrica: **CASA ONZE** Unidade: **UN/1**  
F1 F4



TRAVESSA PLAST PEQ RET C/TAMPA 147

Código: **33502** Fábrica: **ARIPLAS** Unidade: **UN/1**  
F1 F4



TRAVESSA PLASTICA FUNDA

Código: **14579** Fábrica: **ECOPLASTIC** Unidade: **UN/1**  
F1 F4



TRAVESSA PORC 320ML PEQ BRANCA G14

Código: **40019** Fábrica: **TERRAMADA** Unidade: **UN/1**  
F1 F4



TRAVESSA PORC 450ML MED BRANCA G15

Código: **40020** Fábrica: **TERRAMADA** Unidade: **UN/1**  
F1 F4



TRITURADOR PLAST GIRATORIO P/ALHO 1032

Código: **50375** Fábrica: **ENGIPLAST** Unidade: **UN/1**  
F1 F4



TRITURADOR PLAST GIRATORIO P/ALHO 780

Código: **36963** Fábrica: **QUALYPLAS** Unidade: **UN/1**  
F1 F4

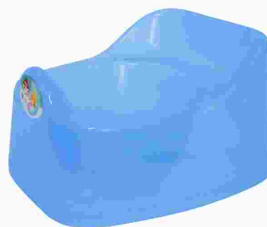

TRONINHO PLAST BABY AZUL 3638

Código: **35480** Fábrica: **TRITEC** Unidade: **UN/1**  
F1 F4



TRONINHO PLAST BABY ROSA 3636

Código: **6456** Fábrica: **TRITEC** Unidade: **UN/1**  
F1 F4



UNIAO PLAST MANGUEIRA STANDARD 215

Código: **40242** Fábrica: **MONTEREY** Unidade: **UN/1**  
F1 F4



UNIAO 1/2 P/IRRIGACAO INTERNA 25X1

Código: **50817** Fábrica: **MC LOREN** Unidade: **PT/25**  
F1 F4



UNIAO 1/2 P/MANGUEIRA PRETO UN51N 50X1

Código: **40151** Fábrica: **REBOUCAS** Unidade: **PT/50**  
F1 F4



UNIAO 3/4 P/MANGUEIRA PRETO UN52N 50X1

Código: **40152** Fábrica: **REBOUCAS** Unidade: **PT/50**  
F1 F4



URINOL GRANDE PLAST 5017

Código: **14026** Fábrica: **SBRISSA** Unidade: **UN/1**  
F1 F4



URINOL PLAST 713

Código: **37261** Fábrica: **LUMAR** Unidade: **UN/1**  
F1 F4



URINOL PLASTICO GDE 113

Código: **20915** Fábrica: **ECOPLASTIC** Unidade: **UN/1**  
F1 F4



VALVULA GATILHO P/PULVERIZADOR 28

Código: **49398** Fábrica: **ARBRA** Unidade: **UN/1**  
F1 F4



VALVULA P/TANQUE 1.1/4" MET VC53N 12X1

Código: **40155** Fábrica: **REBOUCAS** Unidade: **PT/12**  
F1 F4



VALVULA P/TANQUE 1.1/4" PLAS VO53N 12X1

Código: **40156** Fábrica: **REBOUCAS** Unidade: **PT/12**  
F1 F4



VALVULA SEG PAINELA PRESS METAL 2000 10X1

Código: **25505** Fábrica: **PINOLAR** Unidade: **PT/10**  
F1 F4



VALVULA SEG PAINELA PRESS SILIC 6000 10X1

Código: **31035** Fábrica: **PINOLAR** Unidade: **PT/10**  
F1 F4



VALVULA (SELO) PAINELA PRESSAO 62 2X1

Código: **49742** Fábrica: **NOVA MARCA** Unidade: **CR/2**  
F1 F4



VARAL MULTIUSO N1 08 PRENDEDORES 433

Código: **38887** Fábrica: **LIG BRIN** Unidade: **UN/1**  
F1 F4



VARAL MULTIUSO N2 16 PRENDEDORES 440

Código: **38888** Fábrica: **LIG BRIN** Unidade: **UN/1**  
F1 F4



VARAL MULTIUSO N3 26 PRENDEDORES 471

Código: **38886** Fábrica: **LIG BRIN** Unidade: **UN/1**  
F1 F4



VARAL MULTIUSO N4 36 PRENDEDORES 587

Código: **38889** Fábrica: **LIG BRIN** Unidade: **UN/1**  
F1 F4

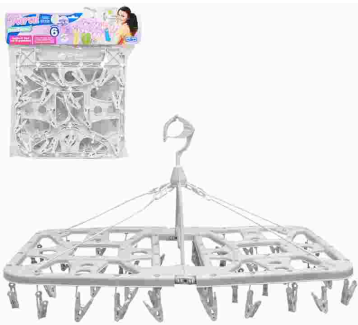

VARAL MULTIUSO N6 48 PRENDEDORES 624

Código: **38891** Fábrica: **LIG BRIN** Unidade: **UN/1**  
F1 F4



VARAL PLAST MULTIUSO 12 PRENDEDORES 0219

Código: **31365** Fábrica: **TALBERG** Unidade: **UN/1**  
F1 F4



2,6mts

VARAO (BASTAO) EXTENSIV METAL 1,40A2,60M

Código: **47374** Fábrica: **ALTHOME** Unidade: **UN/1**  
F1 F4



VARETA BAMBU ALGODAO DOCE 40CM 100X1

Código: **50075** Fábrica: **BOMPACK** Unidade: **PT/100**  
F1 F4



11 5,5 cm  
12 06 cm

VASO CERAMICA MINI 5,5X6CM 172116

Código: 34775  
Fábrica: FREECOM  
Unidade: UN/1  
F1 F4



11 12 cm  
12 15 cm  
13 1,3 lts

VASO ELEGANCE AUTOIRRIG 03 CAFE IMP 1,3L

Código: 34619  
Fábrica: NUTRIPLAN  
Unidade: UN/1  
F1 F4



11 16 cm  
12 15 cm  
13 1,8 lts

VASO ELEGANCE AUTOIRRIG 3,5 TRAVERT 1,8L

Código: 34620  
Fábrica: NUTRIPLAN  
Unidade: UN/1  
F1 F4



14 415 ml

VASO PL 1 RED PEQ MARROM 415ML

Código: 39638  
Fábrica: NUTRIPLAN  
Unidade: UN/1  
F1 F4



11 7,8cm  
12 10,2cm

VASO PL 1 RED PEQ PRETO 415ML

Código: 18470  
Fábrica: NUTRIPLAN  
Unidade: UN/1  
F1 F4



11 12cm  
12 16cm  
13 1lts

VASO PL 1,0 L RED PEQ TERRACOTA 6715

Código: 26766  
Fábrica: INPLAST  
Unidade: UN/1  
F1 F4



11 09 cm  
12 12 cm  
13 0,75 L

VASO PL 1,5 RED PEQ PRETO 750ML

Código: 33551  
Fábrica: NUTRIPLAN  
Unidade: UN/1  
F1 F4



11 09 cm  
12 13 cm  
13 01 L

VASO PL 2 RED PEQ MARROM 1LT

Código: 33537  
Fábrica: NUTRIPLAN  
Unidade: UN/1  
F1 F4



11 9,8cm  
12 13cm

VASO PL 2 RED PEQ PRETO 1LT

Código: 18471  
Fábrica: NUTRIPLAN  
Unidade: UN/1  
F1 F4



11 11 cm  
12 14 cm  
13 1,4 L

VASO PL 2,5 RED PEQ MARROM 1,4LTS

Código: 33538  
Fábrica: NUTRIPLAN  
Unidade: UN/1  
F1 F4



11 10,5cm  
12 14,5cm

VASO PL 2,5 RED PEQ PRETO 1,4LTS

Código: 18472  
Fábrica: NUTRIPLAN  
Unidade: UN/1  
F1 F4



VASO PL 3 LTS QUAD PRETO 7002

Código: 40417  
Fábrica: FORMPLAST  
Unidade: UN/1  
F1 F4



11 12 cm  
12 17 cm  
13 02 L

VASO PL 3 RED PEQ MARROM 2LTS

Código: 33539  
Fábrica: NUTRIPLAN  
Unidade: UN/1  
F1 F4



11 12,5cm  
12 17cm

VASO PL 3 RED PEQ PRETO 2LTS

Código: 18473  
Fábrica: NUTRIPLAN  
Unidade: UN/1  
F1 F4



11 15 cm  
12 20 cm  
13 03 L

VASO PL 3,5 RED MED MARROM 3LTS

Código: 33552  
Fábrica: NUTRIPLAN  
Unidade: UN/1  
F1 F4



11 17 cm  
12 21 cm  
13 4,9 L

VASO PL 4 RED MED MARROM 4,9LTS

Código: 26911  
Fábrica: NUTRIPLAN  
Unidade: UN/1  
F1 F4

 <p>                     17cm 21cm                 </p> <p>                     VASO PL 4 RED MED PRETO 4,9LTS                      Código: <b>18475</b>    Fábrica: <b>NUTRIPLAN</b>    Unidade: <b>UN/1</b>                      F1 F4                 </p>	 <p>                     23 cm 26 cm 8,7 L                 </p> <p>                     VASO PL 5 RED GDE MARROM 8,7LTS                      Código: <b>33553</b>    Fábrica: <b>NUTRIPLAN</b>    Unidade: <b>UN/1</b>                      F1 F4                 </p>	 <p>                     23cm 26cm                 </p> <p>                     VASO PL 5 RED GDE PRETO 8,7LTS                      Código: <b>18476</b>    Fábrica: <b>NUTRIPLAN</b>    Unidade: <b>UN/1</b>                      F1 F4                 </p>	 <p>                     VASO PL 5LTS MARFIM 6412                      Código: <b>41480</b>    Fábrica: <b>KOZI PLAST</b>    Unidade: <b>UN/1</b>                      F1 F4                 </p>
 <p>                     VASO PL 5LTS PRETO 6400                      Código: <b>41494</b>    Fábrica: <b>KOZI PLAST</b>    Unidade: <b>UN/1</b>                      F1 F4                 </p>	 <p>                     25 cm 20 cm 12 L                 </p> <p>                     VASO PL 6 RED GDE MARROM 12LTS                      Código: <b>33554</b>    Fábrica: <b>NUTRIPLAN</b>    Unidade: <b>UN/1</b>                      F1 F4                 </p>	 <p>                     25cm 30cm                 </p> <p>                     VASO PL 6 RED GDE PRETO 12LTS                      Código: <b>18477</b>    Fábrica: <b>NUTRIPLAN</b>    Unidade: <b>UN/1</b>                      F1 F4                 </p>	 <p>                     29 cm 37 cm 21,5 L                 </p> <p>                     VASO PL 7 RED GDE MARROM 21,5LTS                      Código: <b>33555</b>    Fábrica: <b>NUTRIPLAN</b>    Unidade: <b>UN/1</b>                      F1 F4                 </p>
 <p>                     29cm 37cm                 </p> <p>                     VASO PL 7 RED GDE PRETO 21,2LTS                      Código: <b>18478</b>    Fábrica: <b>NUTRIPLAN</b>    Unidade: <b>UN/1</b>                      F1 F4                 </p>	 <p>                     38 cm 44 cm 42,5 L                 </p> <p>                     VASO PL 8 RED GIG MARROM 42,5LTS                      Código: <b>33535</b>    Fábrica: <b>NUTRIPLAN</b>    Unidade: <b>UN/1</b>                      F1 F4                 </p>	 <p>                     38 cm 44 cm 42,5 L                 </p> <p>                     VASO PL 8 RED GIG PRETO 42,5LTS                      Código: <b>33536</b>    Fábrica: <b>NUTRIPLAN</b>    Unidade: <b>UN/1</b>                      F1 F4                 </p>	 <p>                     45 cm 51 cm 65Lts                 </p> <p>                     VASO PL 9 RED GIG PRETO 65LTS                      Código: <b>39639</b>    Fábrica: <b>NUTRIPLAN</b>    Unidade: <b>UN/1</b>                      F1 F4                 </p>
 <p>                     21,5cm 29 cm 30 lts                 </p> <p>                     VASO PL ADRI 30 PRETO 8L 788                      Código: <b>37712</b>    Fábrica: <b>BIG PLAST</b>    Unidade: <b>UN/1</b>                      F1 F4                 </p>	 <p>                     VASO PL AQUARELA 2,5 RED AMARELO CLARO                      Código: <b>35709</b>    Fábrica: <b>NUTRIPLAN</b>    Unidade: <b>UN/1</b>                      F1 F4                 </p>	 <p>                     VASO PL AQUARELA 2,5 RED LILAS CLARO                      Código: <b>35710</b>    Fábrica: <b>NUTRIPLAN</b>    Unidade: <b>UN/1</b>                      F1 F4                 </p>	 <p>                     VASO PL AQUARELA 2,5 RED ROSA BEBE                      Código: <b>35711</b>    Fábrica: <b>NUTRIPLAN</b>    Unidade: <b>UN/1</b>                      F1 F4                 </p>



VASO PL AQUARELA 2,5 RED VERDE CLARO

Código: **35712** Fábrica: **NUTRIPLAN** Unidade: **UN/1**  
**F1 F4**



VASO PL AQUARELA 3,5 RED AMARELO CL 1,7L

Código: **34600** Fábrica: **NUTRIPLAN** Unidade: **UN/1**  
**F1 F4**

14 cm  
15 cm  
1,6 lts



VASO PL AQUARELA 3,5 RED VERDE CLAR 1,7L

Código: **34603** Fábrica: **NUTRIPLAN** Unidade: **UN/1**  
**F1 F4**

14 cm  
15 cm  
1,6 lts



VASO PL AZALEIA QUAD CAFE 1132

Código: **37215** Fábrica: **PAIOL** Unidade: **UN/1**  
**F1 F4**

13 cm  
19 cm



VASO PL BACIA GREGA P AZUL 29-9

Código: **40022** Fábrica: **PAIOL** Unidade: **UN/1**  
**F1 F4**

35 cm  
28,5 cm



VASO PL BACIA GREGA P BEGE 29-1

Código: **40021** Fábrica: **PAIOL** Unidade: **UN/1**  
**F1 F4**

35 cm  
28,5 cm



VASO PL BAMBU OVAL 45 CARVALHO 22LTS

Código: **34609** Fábrica: **NUTRIPLAN** Unidade: **UN/1**  
**F1 F4**

45 cm  
28 cm



VASO PL BELLA FIOR RED 35 PTO 13,5L 9201

Código: **45208** Fábrica: **RISCHIOTO** Unidade: **UN/1**  
**F1 F4**

30 cm  
35 cm  
13,5 L



VASO PL BELLA FIORE RED 42 PTO 25L 9202

Código: **45209** Fábrica: **RISCHIOTO** Unidade: **UN/1**  
**F1 F4**

36 cm  
42 cm  
29,6 L



VASO PL BELLA QUAD 28 PTO 9,7LTS 9250

Código: **45204** Fábrica: **RISCHIOTO** Unidade: **UN/1**  
**F1 F4**

24 cm  
28 cm  
9,7 L



VASO PL BELLA RED 22 PTO 4LTS 9199

Código: **45206** Fábrica: **RISCHIOTO** Unidade: **UN/1**  
**F1 F4**

19 cm  
22 cm  
4 L



VASO PL BELLA RED 50 PTO 42,5LTS 9203

Código: **45210** Fábrica: **RISCHIOTO** Unidade: **UN/1**  
**F1 F4**

43 cm  
50 cm  
42,5 L



VASO PL CACHEPO GDE SISAL 1725

Código: **37217** Fábrica: **PAIOL** Unidade: **UN/1**  
**F1 F4**

25 cm  
26 cm



VASO PL CLASS CONE 70 VERDE GUATEMA 27,5L

Código: **39652** Fábrica: **NUTRIPLAN** Unidade: **UN/1**  
**F1 F4**

70 cm  
38 cm  
27,5 lts



VASO PL CLASS CONICO 66 VERDE GUATEMA 50L

Código: **39647** Fábrica: **NUTRIPLAN** Unidade: **UN/1**  
**F1 F4**

65 cm  
38 cm  
50 lts



VASO PL CLASS RED 33 VERDE GUATEMALA 22L

Código: **39648** Fábrica: **NUTRIPLAN** Unidade: **UN/1**  
**F1 F4**

33 cm  
35 cm  
22 lts

32 cm  
40 cm



VASO PL CLASSIC CILINDRICO 32 AREIA 35LT

Código: **30277** Fábrica: **NUTRIPLAN** Unidade: **UN/1**  
**F1 F4**

32 cm  
40,5 cm



VASO PL CLASSIC CILINDRICO 32 AZUL COB

Código: **41390** Fábrica: **NUTRIPLAN** Unidade: **UN/1**  
**F1 F4**

32 cm  
40 cm



VASO PL CLASSIC CILINDRICO 32 FERRU 35L

Código: **30278** Fábrica: **NUTRIPLAN** Unidade: **UN/1**  
**F1 F4**



VASO PL CLASSIC CILINDRICO 75 AREIA

Código: **42173** Fábrica: **NUTRIPLAN** Unidade: **UN/1**  
**F1 F4**



VASO PL CLASSIC CILINDRICO 75 AZUL COB

Código: **42169** Fábrica: **NUTRIPLAN** Unidade: **UN/1**  
**F1 F4**



VASO PL CLASSIC CILINDRICO 75 FERRUGEM

Código: **42172** Fábrica: **NUTRIPLAN** Unidade: **UN/1**  
**F1 F4**

30 cm



VASO PL CLASSIC CONE 30 AREIA

Código: **36801** Fábrica: **NUTRIPLAN** Unidade: **UN/1**  
**F1 F4**

30 cm



VASO PL CLASSIC CONE 30 COBRE

Código: **36803** Fábrica: **NUTRIPLAN** Unidade: **UN/1**  
**F1 F4**

30 cm



VASO PL CLASSIC CONE 30 FERRUGEM

Código: **36799** Fábrica: **NUTRIPLAN** Unidade: **UN/1**  
**F1 F4**

30 cm



VASO PL CLASSIC CONE 30 RUBI

Código: **36802** Fábrica: **NUTRIPLAN** Unidade: **UN/1**  
**F1 F4**

70 cm



VASO PL CLASSIC CONE 70 AREIA

Código: **36798** Fábrica: **NUTRIPLAN** Unidade: **UN/1**  
**F1 F4**

70 cm

38 cm



VASO PL CLASSIC CONE 70 AZUL COB

Código: **41382** Fábrica: **NUTRIPLAN** Unidade: **UN/1**  
**F1 F4**

70 cm



VASO PL CLASSIC CONE 70 GRAFITE

Código: **36797** Fábrica: **NUTRIPLAN** Unidade: **UN/1**  
**F1 F4**

45 cm  
26,5 cm  
18 lts



VASO PL CLASSIC CONICO 46 GRAFITE 18LTS

Código: **32739** Fábrica: **NUTRIPLAN** Unidade: **UN/1**  
**F1 F4**

65 cm  
38 cm



VASO PL CLASSIC CONICO 66 AZUL COB

Código: **41400** Fábrica: **NUTRIPLAN** Unidade: **UN/1**  
**F1 F4**

VASO PL CLASSIC CONICO 46 AZUL COB 50L

Código: **41384** Fábrica: **NUTRIPLAN** Unidade: **UN/1**  
**F1 F4**



65 cm  
38 cm  
50 lts

VASO PL CLASSIC CONICO 66 GRAFITE 50LTS

Código: 32738 Fábrica: NUTRIPLAN Unidade: UN/1 F1 F4



65 cm  
38 cm  
50 lts

VASO PL CLASSIC CONICO 66 RUBI 50LTS

Código: 32737 Fábrica: NUTRIPLAN Unidade: UN/1 F1 F4



26 cm  
27,5 cm  
11 lts

VASO PL CLASSIC REDONDO 26 AREIA 11LTS

Código: 33398 Fábrica: NUTRIPLAN Unidade: UN/1 F1 F4



26 cm  
27,5 cm  
11 lts

VASO PL CLASSIC REDONDO 26 FERRUGEM 11LT

Código: 33392 Fábrica: NUTRIPLAN Unidade: UN/1 F1 F4



40 cm  
42,6 cm  
45 lts

VASO PL CLASSIC REDONDO 40 RUBI 45LTS

Código: 34097 Fábrica: NUTRIPLAN Unidade: UN/1 F1 F4



62 cm  
67 cm

VASO PL CLASSIC REDONDO 62 FERRUG 170LTS

Código: 30331 Fábrica: NUTRIPLAN Unidade: UN/1 F1 F4



VASO PL COLOR M 951994

Código: 41203 Fábrica: PLASTSU Unidade: UN/1 F1 F4



VASO PL COLOR P 9LTS 951512

Código: 41201 Fábrica: PLASTSU Unidade: UN/1 F1 F4



28 cm  
21 cm  
8 lts

VASO PL COLUNA MARROM 8 LTS 2302

Código: 36994 Fábrica: ERCAPLAST Unidade: UN/1 F1 F4



34 cm  
25 cm  
13,5 lts

VASO PL COLUNA PRETO 13,5 LTS 2344

Código: 36992 Fábrica: ERCAPLAST Unidade: UN/1 F1 F4



28 cm  
21 cm  
8 lts

VASO PL COLUNA PRETO 8 LTS 2301

Código: 36993 Fábrica: ERCAPLAST Unidade: UN/1 F1 F4



35 cm  
28,5 cm

VASO PL COLUNA QUAD PEQ AZUL 79-7

Código: 39961 Fábrica: PAIOL Unidade: UN/1 F1 F4



35 cm  
28,5 cm

VASO PL COLUNA QUAD PEQ BEGE 79-3

Código: 39959 Fábrica: PAIOL Unidade: UN/1 F1 F4



35 cm  
28,5 cm

VASO PL COLUNA QUAD PEQ CIMENTO 79-4

Código: 39960 Fábrica: PAIOL Unidade: UN/1 F1 F4



35 cm  
28,5 cm

VASO PL COLUNA QUAD PEQ MARROM 79-7

Código: 39958 Fábrica: PAIOL Unidade: UN/1 F1 F4



27 cm  
22 cm

VASO PL COLUNA QUAD PP AZUL 99-7

Código: 39957 Fábrica: PAIOL Unidade: UN/1 F1 F4

 <p><b>27 cm</b> <b>22 cm</b></p> <p>VASO PL COLUNA QUAD PP BEGE 99-1 Código: <b>39955</b> Fábrica: <b>PAIOL</b> Unidade: <b>UN/1</b> <b>F1 F4</b></p>	 <p><b>27 cm</b> <b>22 cm</b></p> <p>VASO PL COLUNA QUAD PP CIMENTO 99-3 Código: <b>39956</b> Fábrica: <b>PAIOL</b> Unidade: <b>UN/1</b> <b>F1 F4</b></p>	 <p><b>27 cm</b> <b>22 cm</b></p> <p>VASO PL COLUNA QUAD PP MARROM 99-2 Código: <b>39954</b> Fábrica: <b>PAIOL</b> Unidade: <b>UN/1</b> <b>F1 F4</b></p>	 <p><b>26 cm</b> <b>21,5 cm</b></p> <p>VASO PL COLUNA RED PP BEGE 50-1 Código: <b>39948</b> Fábrica: <b>PAIOL</b> Unidade: <b>UN/1</b> <b>F1 F4</b></p>
 <p><b>26 cm</b> <b>21,5 cm</b></p> <p>VASO PL COLUNA RED PP CIMENTO 50-3 Código: <b>39949</b> Fábrica: <b>PAIOL</b> Unidade: <b>UN/1</b> <b>F1 F4</b></p>	 <p><b>29 cm</b> <b>26,5 cm</b></p> <p>VASO PL COLUNA RED PP LISO AZUL B50-9 Código: <b>40027</b> Fábrica: <b>PAIOL</b> Unidade: <b>UN/1</b> <b>F1 F4</b></p>	 <p><b>29 cm</b> <b>26,5 cm</b></p> <p>VASO PL COLUNA RED PP LISO BEGE B50-1 Código: <b>40025</b> Fábrica: <b>PAIOL</b> Unidade: <b>UN/1</b> <b>F1 F4</b></p>	 <p><b>29 cm</b> <b>26,5 cm</b></p> <p>VASO PL COLUNA RED PP LISO CIMENTO B50-5 Código: <b>40026</b> Fábrica: <b>PAIOL</b> Unidade: <b>UN/1</b> <b>F1 F4</b></p>
 <p><b>29 cm</b> <b>26,5 cm</b></p> <p>VASO PL COLUNA RED PP LISO MARROM B50-2 Código: <b>40024</b> Fábrica: <b>PAIOL</b> Unidade: <b>UN/1</b> <b>F1 F4</b></p>	 <p><b>26 cm</b> <b>21,5 cm</b></p> <p>VASO PL COLUNA RED PP MARROM 50-2 Código: <b>39947</b> Fábrica: <b>PAIOL</b> Unidade: <b>UN/1</b> <b>F1 F4</b></p>	 <p><b>18,5 cm</b> <b>23 cm</b></p> <p>VASO PL CONE BERLIAN GOLD PP AZUL A96-9 Código: <b>39942</b> Fábrica: <b>PAIOL</b> Unidade: <b>UN/1</b> <b>F1 F4</b></p>	 <p><b>18,5 cm</b> <b>23 cm</b></p> <p>VASO PL CONE BERLIAN GOLD PP BEGE A96-1 Código: <b>39940</b> Fábrica: <b>PAIOL</b> Unidade: <b>UN/1</b> <b>F1 F4</b></p>
 <p><b>18,5 cm</b> <b>23 cm</b></p> <p>VASO PL CONE BERLIAN GOLD PP MARRO A96-2 Código: <b>39939</b> Fábrica: <b>PAIOL</b> Unidade: <b>UN/1</b> <b>F1 F4</b></p>	 <p>VASO PL CONIC SINT S/BORDA M BANANA5011 Código: <b>41756</b> Fábrica: <b>PAIOL</b> Unidade: <b>UN/1</b> <b>F1 F4</b></p>	 <p><b>21 cm</b> <b>24 cm</b></p> <p>VASO PL CONIC SINT S/BORDA P BANANA3536 Código: <b>37124</b> Fábrica: <b>PAIOL</b> Unidade: <b>UN/1</b> <b>F1 F4</b></p>	 <p><b>24 cm</b> <b>17 cm</b></p> <p>VASO PL CRETA CONICO 24 BRANCO 3LTS Código: <b>34605</b> Fábrica: <b>NUTRIPLAN</b> Unidade: <b>UN/1</b> <b>F1 F4</b></p>



11 24 cm  
17 cm

VASO PL CRETA CONICO 24 TABACO 3LTS

Código: 34604 Fábrica: NUTRIPLAN Unidade: UN/1  
F1 F4

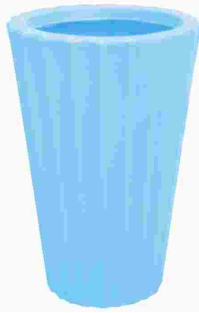

11 60 cm  
42 cm

VASO PL CRETA CONICO 60 AZUL CELESTE 50L

Código: 35456 Fábrica: NUTRIPLAN Unidade: UN/1  
F1 F4



11 60 cm  
42 cm

VASO PL CRETA CONICO 60 ENVELHECIDO 50LT

Código: 34607 Fábrica: NUTRIPLAN Unidade: UN/1  
F1 F4



11 12 cm  
17 cm

VASO PL CRISANTEMO CONE CAPIM 2582

Código: 37107 Fábrica: PAIOL Unidade: UN/1  
F1 F4



11 13 cm  
18 cm

VASO PL CRISANTEMO CONE SINT ARGILA 2674

Código: 37105 Fábrica: PAIOL Unidade: UN/1  
F1 F4



11 14 cm  
18 cm

VASO PL CRISANTEMO CONE SINT BANANA 2674

Código: 40118 Fábrica: PAIOL Unidade: UN/1  
F1 F4



11 14 cm  
19 cm

VASO PL CRISANTEMO RED MAD C/LACO 1459

Código: 37109 Fábrica: PAIOL Unidade: UN/1  
F1 F4



11 14 cm  
18 cm

VASO PL CRISANTEMO RED MADEIRA PT/BC5914

Código: 37116 Fábrica: PAIOL Unidade: UN/1  
F1 F4



11 14 cm  
20 cm

VASO PL CRISANTEMO RED SINT ARGILA 40435

Código: 37132 Fábrica: PAIOL Unidade: UN/1  
F1 F4



11 14 cm  
18,5 cm

VASO PL CRISANTEMO RED TEXTURA LACO 3208

Código: 40614 Fábrica: PAIOL Unidade: UN/1  
F1 F4



VASO PL CUIA CLASSIC 22 MARROM/PRETO

Código: 30348 Fábrica: NUTRIPLAN Unidade: UN/1  
F1 F4



VASO PL CUIA CLASSIC 22 PRETO

Código: 30349 Fábrica: NUTRIPLAN Unidade: UN/1  
F1 F4



11 12cm  
22cm  
2,7lts

VASO PL CUIA NOBRE 1 C/PRATO MARROM

Código: 37857 Fábrica: NUTRIPLAN Unidade: UN/1  
F1 F4



11 12cm  
22cm  
2,7lts

VASO PL CUIA NOBRE 1 C/PRATO PRETO

Código: 38674 Fábrica: NUTRIPLAN Unidade: UN/1  
F1 F4



11 13cm  
27cm

VASO PL CUIA NOBRE 1,5 PRETO 4,5LTS

Código: 48428 Fábrica: NUTRIPLAN Unidade: UN/1  
F1 F4



11 6,5 cm  
13 cm

VASO PL CUIA SINT 13 S/BORDA BANAN 27066

Código: 37099 Fábrica: PAIOL Unidade: UN/1  
F1 F4

<p> 6,5 cm 13 cm</p> <p>VASO PL CUIA SINT 13 S/BORDA CAFE 27066 Código: <b>39454</b> Fábrica: <b>PAIOL</b> Unidade: <b>UN/1</b> <b>F1 F4</b></p>	<p> 9 cm 18 cm</p> <p>VASO PL CUIA SINT 13 S/BORDA CAPUC 27066 Código: <b>42967</b> Fábrica: <b>PAIOL</b> Unidade: <b>UN/1</b> <b>F1 F4</b></p>	<p> 9,5 cm 19 cm</p> <p>VASO PL CUIA SINT 17 S/BORDA BANAN 26910 Código: <b>39455</b> Fábrica: <b>PAIOL</b> Unidade: <b>UN/1</b> <b>F1 F4</b></p>	<p> 9,5 cm 19 cm</p> <p>VASO PL CUIA SINT 17 S/BORDA CAFE 26910 Código: <b>37098</b> Fábrica: <b>PAIOL</b> Unidade: <b>UN/1</b> <b>F1 F4</b></p>
<p> 9,5 cm 19 cm</p> <p>VASO PL CUIA SINT 17 S/BORDA CAPUC 26910 Código: <b>39456</b> Fábrica: <b>PAIOL</b> Unidade: <b>UN/1</b> <b>F1 F4</b></p>	<p> 10 cm 21 cm</p> <p>VASO PL CUIA SINT 20 S/BORDA ARGIL 26909 Código: <b>39457</b> Fábrica: <b>PAIOL</b> Unidade: <b>UN/1</b> <b>F1 F4</b></p>	<p> 10 cm 22 cm</p> <p>VASO PL CUIA SINT 20 S/BORDA BANAN 26909 Código: <b>37097</b> Fábrica: <b>PAIOL</b> Unidade: <b>UN/1</b> <b>F1 F4</b></p>	<p> 10 cm 22 cm</p> <p>VASO PL CUIA SINT 20 S/BORDA CAFE 26909 Código: <b>39458</b> Fábrica: <b>PAIOL</b> Unidade: <b>UN/1</b> <b>F1 F4</b></p>
<p> 11 cm 25 cm</p> <p>VASO PL CUIA SINT 25 S/BORDA ARGIL 40468 Código: <b>39461</b> Fábrica: <b>PAIOL</b> Unidade: <b>UN/1</b> <b>F1 F4</b></p>	<p> 11 cm 26 cm</p> <p>VASO PL CUIA SINT 25 S/BORDA BANAN 40468 Código: <b>37096</b> Fábrica: <b>PAIOL</b> Unidade: <b>UN/1</b> <b>F1 F4</b></p>	<p> 11 cm 26 cm</p> <p>VASO PL CUIA SINT 25 S/BORDA CAFE 40468 Código: <b>39460</b> Fábrica: <b>PAIOL</b> Unidade: <b>UN/1</b> <b>F1 F4</b></p>	<p> 12 cm 31 cm</p> <p>VASO PL CUIA SINT 28 S/BORDA ARG 26896-1 Código: <b>37095</b> Fábrica: <b>PAIOL</b> Unidade: <b>UN/1</b> <b>F1 F4</b></p>
<p> 13 cm 34 cm</p> <p>VASO PL CUIA SINT 32 S/BORDA ARGIL 50523 Código: <b>37094</b> Fábrica: <b>PAIOL</b> Unidade: <b>UN/1</b> <b>F1 F4</b></p>	<p> 32cm 14cm</p> <p>VASO PL CUIA SINT 32 S/BORDA BANAN 50523 Código: <b>41055</b> Fábrica: <b>PAIOL</b> Unidade: <b>UN/1</b> <b>F1 F4</b></p>	<p> 17 cm 42 cm</p> <p>VASO PL CUIA SINT 40 S/BORDA ARGIL 26944 Código: <b>37093</b> Fábrica: <b>PAIOL</b> Unidade: <b>UN/1</b> <b>F1 F4</b></p>	<p> 17 cm 13 cm 350 ml</p> <p>VASO PL CUIA 13 PRETO C/ALCA 350ML 15 Código: <b>38359</b> Fábrica: <b>BIG PLAST</b> Unidade: <b>UN/1</b> <b>F1 F4</b></p>

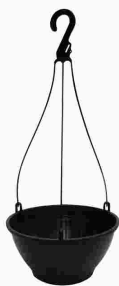

VASO PL CUIA 18 PRETO C/GANCHO 121  
 Código: 40795 Fábrica: NOVA BRASIL Unidade: UN/1  
 F1 F4



VASO PL CUIA 21 COLOR C/ALCA BA 2,4L 815  
 Código: 39854 Fábrica: BIG PLAST Unidade: UN/1  
 F1 F4

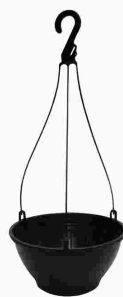

VASO PL CUIA 21 PRETO C/GANCHO 125  
 Código: 40796 Fábrica: NOVA BRASIL Unidade: UN/1  
 F1 F4



VASO PL CUIA 22 PRETO C/GANCHO 133  
 Código: 40797 Fábrica: NOVA BRASIL Unidade: UN/1  
 F1 F4



↑ 38 cm  
 → 26 cm

VASO PL DIAMANTE CONICO 38 AREIA 14LTS  
 Código: 32744 Fábrica: NUTRIPLAN Unidade: UN/1  
 F1 F4



↑ 38 cm  
 → 26 cm

VASO PL DIAMANTE CONICO 38 FERRUGEM 14LT  
 Código: 32743 Fábrica: NUTRIPLAN Unidade: UN/1  
 F1 F4



↑ 22cm  
 → 24,9cm

VASO PL ELO REDONDO 22 CARVALHO 6,5 L  
 Código: 38923 Fábrica: NUTRIPLAN Unidade: UN/1  
 F1 F4



↑ 22cm  
 → 24,9cm

VASO PL ELO REDONDO 22 CIMENTO 6,5 L  
 Código: 38922 Fábrica: NUTRIPLAN Unidade: UN/1  
 F1 F4



↑ 22cm  
 → 24,9cm

VASO PL ELO REDONDO 22 ENVELHECIDO 6,5 L  
 Código: 38921 Fábrica: NUTRIPLAN Unidade: UN/1  
 F1 F4



↑ 22cm  
 → 24,9cm

VASO PL ELO REDONDO 22 PRETO 6,5 L  
 Código: 38920 Fábrica: NUTRIPLAN Unidade: UN/1  
 F1 F4



↑ 35cm  
 → 38,5cm

VASO PL ELO REDONDO 35 CARVALHO 27 L  
 Código: 38927 Fábrica: NUTRIPLAN Unidade: UN/1  
 F1 F4



↑ 35cm  
 → 38,5cm

VASO PL ELO REDONDO 35 CIMENTO 27 L  
 Código: 38926 Fábrica: NUTRIPLAN Unidade: UN/1  
 F1 F4



↑ 35cm  
 → 38,5cm

VASO PL ELO REDONDO 35 PRETO 27 L  
 Código: 38924 Fábrica: NUTRIPLAN Unidade: UN/1  
 F1 F4



↑ 7 cm  
 → 6 cm  
 ▽ 160 ml

VASO PL ES 07 COLOR 160ML 386  
 Código: 38362 Fábrica: BIG PLAST Unidade: UN/1  
 F1 F4



↑ 16 cm  
 → 14 cm  
 ▽ 1,9 Lts

VASO PL ES 16 PRETO 1,9L 400  
 Código: 38360 Fábrica: BIG PLAST Unidade: UN/1  
 F1 F4



















↑ 24 cm  
 → 14 cm

VASO PL FACE HOMEM 24 BRANCO 2,75LT  
 Código: 42162 Fábrica: NUTRIPLAN Unidade: UN/1  
 F1 F4

 <p>VASO PL FACE HOMEM 24 CIMENTO 2,75LT Código: <b>42159</b> Fábrica: <b>NUTRIPLAN</b> Unidade: <b>UN/1</b> <b>F1 F4</b></p>	 <p>VASO PL FACE HOMEM 24 COBRE 2,75LT Código: <b>42161</b> Fábrica: <b>NUTRIPLAN</b> Unidade: <b>UN/1</b> <b>F1 F4</b></p>	 <p>VASO PL FACE HOMEM 24 PRETO 2,75LT Código: <b>42163</b> Fábrica: <b>NUTRIPLAN</b> Unidade: <b>UN/1</b> <b>F1 F4</b></p>	 <p>VASO PL FACE MULHER 17 BRANCO 2,19LT Código: <b>42156</b> Fábrica: <b>NUTRIPLAN</b> Unidade: <b>UN/1</b> <b>F1 F4</b></p>
 <p>VASO PL FACE MULHER 17 CIMENTO 2,19LT Código: <b>42157</b> Fábrica: <b>NUTRIPLAN</b> Unidade: <b>UN/1</b> <b>F1 F4</b></p>	 <p>VASO PL FACE MULHER 17 COBRE 2,19LT Código: <b>42153</b> Fábrica: <b>NUTRIPLAN</b> Unidade: <b>UN/1</b> <b>F1 F4</b></p>	 <p>VASO PL FACE MULHER 17 PRETO 2,19LT Código: <b>42155</b> Fábrica: <b>NUTRIPLAN</b> Unidade: <b>UN/1</b> <b>F1 F4</b></p>	 <p>VASO PL FACE MULHER 34 BRANCO 14,5LT Código: <b>42164</b> Fábrica: <b>NUTRIPLAN</b> Unidade: <b>UN/1</b> <b>F1 F4</b></p>
 <p>VASO PL FACE MULHER 34 PRETO 14,5LT Código: <b>42165</b> Fábrica: <b>NUTRIPLAN</b> Unidade: <b>UN/1</b> <b>F1 F4</b></p>	 <p>VASO PL FIBRA COCO PAREDE G 19,6X26X26CM Código: <b>30294</b> Fábrica: <b>NUTRIPLAN</b> Unidade: <b>UN/1</b> <b>F1 F4</b></p>	 <p>VASO PL FIBRA COCO PAREDE M 15,5X20,5CM Código: <b>30293</b> Fábrica: <b>NUTRIPLAN</b> Unidade: <b>UN/1</b> <b>F1 F4</b></p>	 <p>VASO PL FIBRA DE COCO CONE 21,5X13X9CM Código: <b>34907</b> Fábrica: <b>NUTRIPLAN</b> Unidade: <b>UN/1</b> <b>F1 F4</b></p>
 <p>VASO PL FIBRA DE COCO 2 9,5X16X16CM Código: <b>18499</b> Fábrica: <b>NUTRIPLAN</b> Unidade: <b>UN/1</b> <b>F1 F4</b></p>	 <p>VASO PL FIBRA DE COCO 4 13X25,5X25,5CM Código: <b>18501</b> Fábrica: <b>NUTRIPLAN</b> Unidade: <b>UN/1</b> <b>F1 F4</b></p>	 <p>VASO PL FIBRA DE COCO 5 14X31X31CM Código: <b>18502</b> Fábrica: <b>NUTRIPLAN</b> Unidade: <b>UN/1</b> <b>F1 F4</b></p>	 <p>VASO PL FLOREIRA MARRON 3 LTS 1377 Código: <b>37009</b> Fábrica: <b>ERCAPLAST</b> Unidade: <b>UN/1</b> <b>F1 F4</b></p>

 <p> <b>22303</b>                  Código: <b>22303</b>                  Fábrica: <b>NUTRIPLAN</b>                  Unidade: <b>UN/1</b>  <b>F1 F4</b> </p>	 <p> <b>22304</b>                  Código: <b>22304</b>                  Fábrica: <b>NUTRIPLAN</b>                  Unidade: <b>UN/1</b>  <b>F1 F4</b> </p>	 <p> <b>41668</b>                  Código: <b>41668</b>                  Fábrica: <b>INPLAST</b>                  Unidade: <b>UN/1</b>  <b>F1 F4</b> </p>	 <p> <b>30267</b>                  Código: <b>30267</b>                  Fábrica: <b>NUTRIPLAN</b>                  Unidade: <b>UN/1</b>  <b>F1 F4</b> </p>
 <p> <b>30266</b>                  Código: <b>30266</b>                  Fábrica: <b>NUTRIPLAN</b>                  Unidade: <b>UN/1</b>  <b>F1 F4</b> </p>	 <p> <b>33085</b>                  Código: <b>33085</b>                  Fábrica: <b>NUTRIPLAN</b>                  Unidade: <b>UN/1</b>  <b>F1 F4</b> </p>	 <p> <b>36194</b>                  Código: <b>36194</b>                  Fábrica: <b>NUTRIPLAN</b>                  Unidade: <b>UN/1</b>  <b>F1 F4</b> </p>	 <p> <b>30276</b>                  Código: <b>30276</b>                  Fábrica: <b>NUTRIPLAN</b>                  Unidade: <b>UN/1</b>  <b>F1 F4</b> </p>
 <p> <b>30275</b>                  Código: <b>30275</b>                  Fábrica: <b>NUTRIPLAN</b>                  Unidade: <b>UN/1</b>  <b>F1 F4</b> </p>	 <p> <b>33084</b>                  Código: <b>33084</b>                  Fábrica: <b>NUTRIPLAN</b>                  Unidade: <b>UN/1</b>  <b>F1 F4</b> </p>	 <p> <b>32751</b>                  Código: <b>32751</b>                  Fábrica: <b>NUTRIPLAN</b>                  Unidade: <b>UN/1</b>  <b>F1 F4</b> </p>	 <p> <b>36200</b>                  Código: <b>36200</b>                  Fábrica: <b>NUTRIPLAN</b>                  Unidade: <b>UN/1</b>  <b>F1 F4</b> </p>
 <p> <b>28675</b>                  Código: <b>28675</b>                  Fábrica: <b>NUTRIPLAN</b>                  Unidade: <b>UN/1</b>  <b>F1 F4</b> </p>	 <p> <b>27474</b>                  Código: <b>27474</b>                  Fábrica: <b>NUTRIPLAN</b>                  Unidade: <b>UN/1</b>  <b>F1 F4</b> </p>	 <p> <b>36201</b>                  Código: <b>36201</b>                  Fábrica: <b>NUTRIPLAN</b>                  Unidade: <b>UN/1</b>  <b>F1 F4</b> </p>	 <p> <b>41524</b>                  Código: <b>41524</b>                  Fábrica: <b>ARIPLAS</b>                  Unidade: <b>UN/1</b>  <b>F1 F4</b> </p>

<p>2,8 L</p>  <p>VASO PL GREGO PAREDE COLOR 2,8LTS 421 Código: 41522 Fábrica: ARIPLAS Unidade: UN/1 F1 F4</p>	<p>820ml</p>  <p>VASO PL GREGO PAREDE COLOR 820ML 422 Código: 41527 Fábrica: ARIPLAS Unidade: UN/1 F1 F4</p>	<p>1,6 L</p>  <p>VASO PL GREGO PAREDE PRETO 1,6LTS 421 Código: 41526 Fábrica: ARIPLAS Unidade: UN/1 F1 F4</p>	<p>2,8 L</p>  <p>VASO PL GREGO PAREDE PRETO 2,8LTS 424 Código: 41523 Fábrica: ARIPLAS Unidade: UN/1 F1 F4</p>
<p>820 ml</p>  <p>VASO PL GREGO PAREDE PRETO 820ML 422 Código: 41528 Fábrica: ARIPLAS Unidade: UN/1 F1 F4</p>	<p>2,2 L</p>  <p>VASO PL GREGO RED COLOR 2,2LTS 345 Código: 41515 Fábrica: ARIPLAS Unidade: UN/1 F1 F4</p>	<p>9 L</p>  <p>VASO PL GREGO RED COLOR 9 LTS 341 Código: 41510 Fábrica: ARIPLAS Unidade: UN/1 F1 F4</p>	<p>2,2 L</p>  <p>VASO PL GREGO RED PRETO 2,2LTS 346 Código: 41514 Fábrica: ARIPLAS Unidade: UN/1 F1 F4</p>
<p>4,8 L</p>  <p>VASO PL GREGO RED PRETO 4,8 LTS 344 Código: 41513 Fábrica: ARIPLAS Unidade: UN/1 F1 F4</p>	<p>9 L</p>  <p>VASO PL GREGO RED PRETO 9 LTS 342 Código: 41511 Fábrica: ARIPLAS Unidade: UN/1 F1 F4</p>	<p>5cm 5,8cm</p>  <p>VASO PL HOLAMBRA POTE NP06 PRETO 80ML Código: 39210 Fábrica: NUTRIPLAN Unidade: UN/1 F1 F4</p>	 <p>VASO PL HOLAMBRA POTE NP11 PRETO 415ML Código: 38917 Fábrica: NUTRIPLAN Unidade: UN/1 F1 F4</p>
<p>9 cm 12 cm 0,7 lts</p>  <p>VASO PL HOLAMBRA POTE NP13 PRETO 725ML Código: 39211 Fábrica: NUTRIPLAN Unidade: UN/1 F1 F4</p>	<p>9.8 cm 13 cm 1 lts</p>  <p>VASO PL HOLAMBRA POTE NP14 PRETO 1LT Código: 38918 Fábrica: NUTRIPLAN Unidade: UN/1 F1 F4</p>	<p>10,5 cm 14,5 cm 1,16 lts</p>  <p>VASO PL HOLAMBRA POTE NP15 PRETO 1,16LT Código: 38919 Fábrica: NUTRIPLAN Unidade: UN/1 F1 F4</p>	 <p>VASO PL JARDINEIRA 2 LTS PRETA 3072 Código: 40412 Fábrica: FORMPLAST Unidade: UN/1 F1 F4</p>



VASO PL JARDINEIRA 5 LTS PRETA 3080

Código: **40413** Fábrica: **FORMPLAST** Unidade: **UN/1**  
F1 F4

16 cm  
100 cm



VASO PL JARDINEIRA CAFE 1MT 145

Código: **37149** Fábrica: **PAIOL** Unidade: **UN/1**  
F1 F4

16 cm  
40 cm



VASO PL JARDINEIRA CAFE 40CM 148

Código: **37221** Fábrica: **PAIOL** Unidade: **UN/1**  
F1 F4

16 cm  
60 cm



VASO PL JARDINEIRA CAFE 60CM 0047

Código: **37151** Fábrica: **PAIOL** Unidade: **UN/1**  
F1 F4

16 cm  
80 cm



VASO PL JARDINEIRA CAFE 80CM 0046

Código: **37150** Fábrica: **PAIOL** Unidade: **UN/1**  
F1 F4



VASO PL JARDINEIRA 10 LTS PRETA 3087

Código: **40414** Fábrica: **FORMPLAST** Unidade: **UN/1**  
F1 F4

11 cm  
35 cm

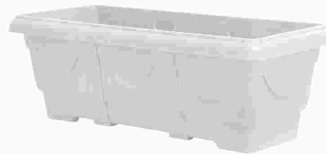

VASO PL JARDINEIRA 35 CM BRANCO 3,5L

Código: **13603** Fábrica: **NUTRIPLAN** Unidade: **UN/1**  
F1 F4

11 cm  
35 cm



VASO PL JARDINEIRA 35 CM CAPUCCINO 3,5L

Código: **35202** Fábrica: **NUTRIPLAN** Unidade: **UN/1**  
F1 F4

11 cm  
35 cm

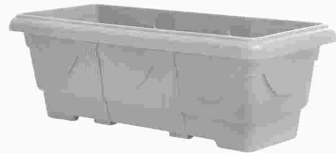

VASO PL JARDINEIRA 35 CM CINZA 3,5L

Código: **35203** Fábrica: **NUTRIPLAN** Unidade: **UN/1**  
F1 F4

11 cm  
35 cm

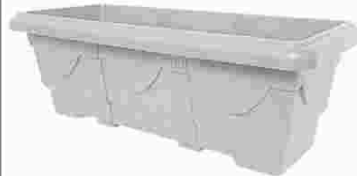

VASO PL JARDINEIRA 35 CM MARMORE 3,5L

Código: **30309** Fábrica: **NUTRIPLAN** Unidade: **UN/1**  
F1 F4

11 cm  
35 cm

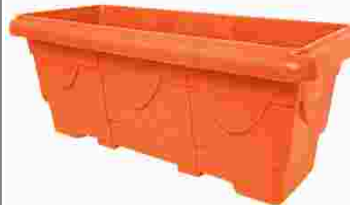

VASO PL JARDINEIRA 35 CM MARROM 3,5L

Código: **18507** Fábrica: **NUTRIPLAN** Unidade: **UN/1**  
F1 F4

11 cm  
35 cm



VASO PL JARDINEIRA 35 CM TABACO 3,5L

Código: **30308** Fábrica: **NUTRIPLAN** Unidade: **UN/1**  
F1 F4

11 cm  
80 cm



VASO PL JARDINEIRA 50 CM CAPUCCINO 11,5

Código: **35204** Fábrica: **NUTRIPLAN** Unidade: **UN/1**  
F1 F4

11 cm  
80 cm

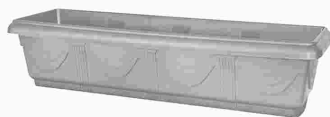

VASO PL JARDINEIRA 50 CM CINZA 11,5L

Código: **35205** Fábrica: **NUTRIPLAN** Unidade: **UN/1**  
F1 F4

11 cm  
80 cm



VASO PL JARDINEIRA 80 CM CAPUCCINO 24,5L

Código: **35457** Fábrica: **NUTRIPLAN** Unidade: **UN/1**  
F1 F4

11 cm  
80 cm

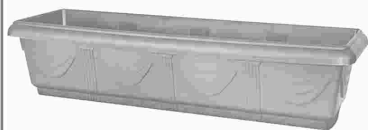

VASO PL JARDINEIRA 80 CM CINZA 34,5L

Código: **35458** Fábrica: **NUTRIPLAN** Unidade: **UN/1**  
F1 F4

11 cm  
35 cm

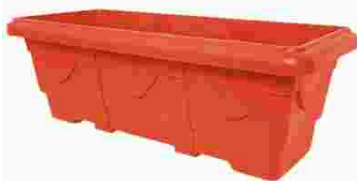

VASO PL JARDINEIRA 80 CM MARROM 24,5L

Código: 30310 Fábrica: NUTRIPLAN Unidade: UN/1 F1 F4

20 cm  
14 cm  
2,1 lts



VASO PL KIREY COLOR 2,1L 391

Código: 37720 Fábrica: BIG PLAST Unidade: UN/1 F1 F4

17 cm  
30 cm  
9 lts



VASO PL LUNA RED 17 TABACO 9LTS

Código: 37752 Fábrica: NUTRIPLAN Unidade: UN/1 F1 F4

17 cm  
30 cm  
9 lts



VASO PL LUNA RED 17 CIMENTO 9LTS

Código: 37754 Fábrica: NUTRIPLAN Unidade: UN/1 F1 F4

17 cm  
30 cm  
9 lts



VASO PL LUNA RED 17 ENVELHECIDO 9LTS

Código: 37753 Fábrica: NUTRIPLAN Unidade: UN/1 F1 F4

47 cm  
31 cm  
18 lts



VASO PL MING CONICO 47 AREIA 18LTS

Código: 33641 Fábrica: NUTRIPLAN Unidade: UN/1 F1 F4

23 cm  
36 cm  
12 lts



VASO PL MING RED BAIXO 23 AREIA 12LTS

Código: 33639 Fábrica: NUTRIPLAN Unidade: UN/1 F1 F4

23 cm  
36 cm  
12 lts



VASO PL MING RED BAIXO 23 CIMENTO 12LTS

Código: 33640 Fábrica: NUTRIPLAN Unidade: UN/1 F1 F4

23 cm  
36 cm  
12 lts



VASO PL MING RED BAIXO 23 FERRUGEM 12LTS

Código: 33644 Fábrica: NUTRIPLAN Unidade: UN/1 F1 F4

23 cm  
36 cm  
12 lts



VASO PL MING RED BAIXO 23 GRANITO 12LTS

Código: 33638 Fábrica: NUTRIPLAN Unidade: UN/1 F1 F4

33 cm  
53 cm  
44 lts



VASO PL MING RED BAIXO 33 AREIA 44LTS

Código: 33642 Fábrica: NUTRIPLAN Unidade: UN/1 F1 F4

33 cm  
53 cm  
44 lts



VASO PL MING RED BAIXO 33 FERRUGEM 44LTS

Código: 33643 Fábrica: NUTRIPLAN Unidade: UN/1 F1 F4

30 cm  
36 cm



VASO PL N99 VIME SINTETICO ARGILA 0106

Código: 37123 Fábrica: PAIOL Unidade: UN/1 F1 F4

21,5 cm  
28 cm



VASO PL ONDULADO PEQ AZUL 84-7

Código: 39953 Fábrica: PAIOL Unidade: UN/1 F1 F4

21,5 cm  
28 cm



VASO PL ONDULADO PEQ BEGE 84-1

Código: 39951 Fábrica: PAIOL Unidade: UN/1 F1 F4

21,5 cm  
28 cm



VASO PL ONDULADO PEQ CIMENTO 84-5

Código: 39952 Fábrica: PAIOL Unidade: UN/1 F1 F4

 <p>VASO PL ONDULADO PEQ MARROM 84-2 Código: <b>39950</b> Fábrica: <b>PAIOL</b> Unidade: <b>UN/1</b> <b>F1 F4</b></p> <p>21,5 cm 28 cm</p>	 <p>VASO PL ORIGAMI RED 22 BRANCO 5,5LTS Código: <b>34615</b> Fábrica: <b>NUTRIPLAN</b> Unidade: <b>UN/1</b> <b>F1 F4</b></p> <p>22 cm 20 cm</p>	 <p>VASO PL ORIGAMI RED 22 CIMENTO 5,5LTS Código: <b>34616</b> Fábrica: <b>NUTRIPLAN</b> Unidade: <b>UN/1</b> <b>F1 F4</b></p> <p>22 cm 20 cm</p>	 <p>VASO PL ORIGAMI RED 22 ENVELHECIDO 5,5LTS Código: <b>34617</b> Fábrica: <b>NUTRIPLAN</b> Unidade: <b>UN/1</b> <b>F1 F4</b></p> <p>22 cm 20 cm</p>
 <p>VASO PL ORIGAMI RED 22 RUBI 5,5LTS Código: <b>34618</b> Fábrica: <b>NUTRIPLAN</b> Unidade: <b>UN/1</b> <b>F1 F4</b></p> <p>22 cm 20 cm</p>	 <p>VASO PL ORQUIDEA CONE SINT ARGILA 2673-1 Código: <b>37104</b> Fábrica: <b>PAIOL</b> Unidade: <b>UN/1</b> <b>F1 F4</b></p> <p>19 cm 20 cm</p>	 <p>VASO PL ORQUIDEA CONE SINT ARGILA 2673-1 Código: <b>40119</b> Fábrica: <b>PAIOL</b> Unidade: <b>UN/1</b> <b>F1 F4</b></p> <p>19,5 cm 21 cm</p>	 <p>VASO PL ORQUIDEA CONE SINT BANANA 2673-2 Código: <b>40120</b> Fábrica: <b>PAIOL</b> Unidade: <b>UN/1</b> <b>F1 F4</b></p> <p>19,5 cm 21 cm</p>
 <p>VASO PL ORQUIDEA RED CAFE 00138 Código: <b>37119</b> Fábrica: <b>PAIOL</b> Unidade: <b>UN/1</b> <b>F1 F4</b></p> <p>23 cm 23 cm</p>	 <p>VASO PL ORQUIDEA RED MAD C/FLOR 1458/327 Código: <b>37108</b> Fábrica: <b>PAIOL</b> Unidade: <b>UN/1</b> <b>F1 F4</b></p> <p>20 cm 23 cm</p>	 <p>VASO PL ORQUIDEA RED MADEIRA PT/BC 5912 Código: <b>37117</b> Fábrica: <b>PAIOL</b> Unidade: <b>UN/1</b> <b>F1 F4</b></p> <p>20 cm 20 cm</p>	 <p>VASO PL PAREDE BELLA 1,7LTS PTO 9500 Código: <b>45182</b> Fábrica: <b>RISCHIOTO</b> Unidade: <b>UN/1</b> <b>F1 F4</b></p> <p>13 cm 26 cm 1,7 L</p>
 <p>VASO PL PAREDE GDE BANANA 27001-2 Código: <b>37101</b> Fábrica: <b>PAIOL</b> Unidade: <b>UN/1</b> <b>F1 F4</b></p> <p>18 cm 29 cm</p>	 <p>VASO PL PAREDE GDE C/BORD ARGILA 27001-1 Código: <b>37100</b> Fábrica: <b>PAIOL</b> Unidade: <b>UN/1</b> <b>F1 F4</b></p> <p>18 cm 29 cm</p>	 <p>VASO PL PAREDE MARROM 1650 ML 2470 Código: <b>37013</b> Fábrica: <b>ERCAPLAST</b> Unidade: <b>UN/1</b> <b>F1 F4</b></p> <p>18 cm 22 cm 1,6 lts</p>	 <p>VASO PL PAREDE MARROM 3400 ML 2472 Código: <b>37010</b> Fábrica: <b>ERCAPLAST</b> Unidade: <b>UN/1</b> <b>F1 F4</b></p> <p>17,5 cm 31 cm 3,4 lts</p>

<p> <b>11 cm</b></p> <p>VASO PL PAREDE MED PRETO 11CM 287                  Código: <b>40715</b> Fábrica: <b>PLASMARC</b> Unidade: <b>UN/1</b>  <b>F1 F4</b></p>	<p> <b>17 cm</b> <b>32 cm</b></p> <p>VASO PL PAREDE MED VERDE                  Código: <b>46045</b> Fábrica: <b>NUTRIPLAN</b> Unidade: <b>UN/1</b>  <b>F1 F4</b></p>	<p> <b>17 cm</b> <b>32 cm</b></p> <p>VASO PL PAREDE MEDIO MARROM                  Código: <b>30313</b> Fábrica: <b>NUTRIPLAN</b> Unidade: <b>UN/1</b>  <b>F1 F4</b></p>	<p> <b>17 cm</b> <b>32 cm</b></p> <p>VASO PL PAREDE MEDIO PRETO                  Código: <b>30314</b> Fábrica: <b>NUTRIPLAN</b> Unidade: <b>UN/1</b>  <b>F1 F4</b></p>
<p> <b>10 cm</b> <b>20 cm</b></p> <p>VASO PL PAREDE MEDIO TABACO                  Código: <b>30312</b> Fábrica: <b>NUTRIPLAN</b> Unidade: <b>UN/1</b>  <b>F1 F4</b></p>	<p> <b>10 cm</b> <b>20 cm</b></p> <p>VASO PL PAREDE MINI MARROM                  Código: <b>30316</b> Fábrica: <b>NUTRIPLAN</b> Unidade: <b>UN/1</b>  <b>F1 F4</b></p>	<p> <b>10 cm</b> <b>20 cm</b></p> <p>VASO PL PAREDE MINI PRETO                  Código: <b>30315</b> Fábrica: <b>NUTRIPLAN</b> Unidade: <b>UN/1</b>  <b>F1 F4</b></p>	<p> <b>10 cm</b> <b>20 cm</b></p> <p>VASO PL PAREDE MINI TABACO                  Código: <b>30317</b> Fábrica: <b>NUTRIPLAN</b> Unidade: <b>UN/1</b>  <b>F1 F4</b></p>
<p> <b>10 cm</b> <b>20 cm</b></p> <p>VASO PL PAREDE MINI VERDE                  Código: <b>47605</b> Fábrica: <b>NUTRIPLAN</b> Unidade: <b>UN/1</b>  <b>F1 F4</b></p>	<p> <b>10,5 cm</b> <b>16 cm</b></p> <p>VASO PL PAREDE PEQ ARGILA 27005-1                  Código: <b>37102</b> Fábrica: <b>PAIOL</b> Unidade: <b>UN/1</b>  <b>F1 F4</b></p>	<p> <b>08 cm</b></p> <p>VASO PL PAREDE PEQ PRETO 8CM 255                  Código: <b>40714</b> Fábrica: <b>PLASMARC</b> Unidade: <b>UN/1</b>  <b>F1 F4</b></p>	<p> <b>13 cm</b> <b>26 cm</b> <b>2 lts</b></p> <p>VASO PL PAREDE PEQ VERDE                  Código: <b>34611</b> Fábrica: <b>NUTRIPLAN</b> Unidade: <b>UN/1</b>  <b>F1 F4</b></p>
<p> <b>18 cm</b> <b>22 cm</b> <b>1,6 lts</b></p> <p>VASO PL PAREDE PRETO 1650 ML 2469                  Código: <b>37012</b> Fábrica: <b>ERCAPLAST</b> Unidade: <b>UN/1</b>  <b>F1 F4</b></p>	<p> <b>17,5 cm</b> <b>31 cm</b> <b>3,4 lts</b></p> <p>VASO PL PAREDE PRETO 3400 ML 2471                  Código: <b>37011</b> Fábrica: <b>ERCAPLAST</b> Unidade: <b>UN/1</b>  <b>F1 F4</b></p>	<p> <b>17 cm</b> <b>30 cm</b> <b>3 lts</b></p> <p>VASO PL PAREDE 30 PRETO 3L 268                  Código: <b>37701</b> Fábrica: <b>BIG PLAST</b> Unidade: <b>UN/1</b>  <b>F1 F4</b></p>	<p> <b>30 cm</b></p> <p>VASO PL PETRA CONE 30 C/PRATO AREIA                  Código: <b>36810</b> Fábrica: <b>NUTRIPLAN</b> Unidade: <b>UN/1</b>  <b>F1 F4</b></p>

 <p>VASO PL PETRA CONE 30 C/PRATO FERRUGEM Código: <b>36809</b> Fábrica: <b>NUTRIPLAN</b> Unidade: <b>UN/1</b> <b>F1 F4</b></p>	 <p>VASO PL PF 11 PRETO 300ML 130 Código: <b>38361</b> Fábrica: <b>BIG PLAST</b> Unidade: <b>UN/1</b> <b>F1 F4</b></p>	 <p>VASO PL POTE SINT 07 S/BORDA ARGIL 60623 Código: <b>39437</b> Fábrica: <b>PAIOL</b> Unidade: <b>UN/1</b> <b>F1 F4</b></p>	 <p>VASO PL POTE SINT 07 S/BORDA CAFE 60623 Código: <b>37087</b> Fábrica: <b>PAIOL</b> Unidade: <b>UN/1</b> <b>F1 F4</b></p>
 <p>VASO PL POTE SINT 07 S/BORDA CAPUC 60623 Código: <b>39438</b> Fábrica: <b>PAIOL</b> Unidade: <b>UN/1</b> <b>F1 F4</b></p>	 <p>VASO PL POTE SINT 09 S/BORDA CAFE 4046 Código: <b>39442</b> Fábrica: <b>PAIOL</b> Unidade: <b>UN/1</b> <b>F1 F4</b></p>	 <p>VASO PL POTE SINT 09 S/BORDA CAPUCI 4046 Código: <b>39444</b> Fábrica: <b>PAIOL</b> Unidade: <b>UN/1</b> <b>F1 F4</b></p>	 <p>VASO PL POTE SINT 11 S/BORDA ARGIL 40461 Código: <b>39439</b> Fábrica: <b>PAIOL</b> Unidade: <b>UN/1</b> <b>F1 F4</b></p>
 <p>VASO PL POTE SINT 11 S/BORDA BANAN 40461 Código: <b>39440</b> Fábrica: <b>PAIOL</b> Unidade: <b>UN/1</b> <b>F1 F4</b></p>	 <p>VASO PL POTE SINT 11 S/BORDA BRANC 40461 Código: <b>39441</b> Fábrica: <b>PAIOL</b> Unidade: <b>UN/1</b> <b>F1 F4</b></p>	 <p>VASO PL POTE SINT 11 S/BORDA CAFE 40461 Código: <b>37084</b> Fábrica: <b>PAIOL</b> Unidade: <b>UN/1</b> <b>F1 F4</b></p>	 <p>VASO PL POTE SINT 11 S/BORDA CAPUC 40461 Código: <b>39931</b> Fábrica: <b>PAIOL</b> Unidade: <b>UN/1</b> <b>F1 F4</b></p>
 <p>VASO PL PRETO G 24LTS 650011 Código: <b>41204</b> Fábrica: <b>PLASTSU</b> Unidade: <b>UN/1</b> <b>F1 F4</b></p>	 <p>VASO PL PRETO M 951710 Código: <b>41202</b> Fábrica: <b>PLASTSU</b> Unidade: <b>UN/1</b> <b>F1 F4</b></p>	 <p>VASO PL PRETO P 9LTS 951314 Código: <b>41200</b> Fábrica: <b>PLASTSU</b> Unidade: <b>UN/1</b> <b>F1 F4</b></p>	 <p>VASO PL PRIMAVERA 2 RED PEQ MARROM 3 L Código: <b>33540</b> Fábrica: <b>NUTRIPLAN</b> Unidade: <b>UN/1</b> <b>F1 F4</b></p>

13 cm  
17 cm  
1,9 L



VASO PL PRIMAVERA 2 RED PEQ PRETO 3 L

Código: **33541** Fábrica: **NUTRIPLAN** Unidade: **UN/1**  
**F1 F4**

14 cm  
19 cm



VASO PL PRIMAVERA 3 RED PEQ MARROM 3 L

Código: **22164** Fábrica: **NUTRIPLAN** Unidade: **UN/1**  
**F1 F4**

14 cm  
19 cm



VASO PL PRIMAVERA 3 RED PEQ PRETO 3L

Código: **22168** Fábrica: **NUTRIPLAN** Unidade: **UN/1**  
**F1 F4**

19 cm  
23 cm  
5,6 L



VASO PL PRIMAVERA 4 RED MED MARROM

Código: **22165** Fábrica: **NUTRIPLAN** Unidade: **UN/1**  
**F1 F4**

19 cm  
23 cm  
5,6 L



VASO PL PRIMAVERA 4 RED MED PRETO

Código: **33542** Fábrica: **NUTRIPLAN** Unidade: **UN/1**  
**F1 F4**

22 cm  
25 cm  
08 lts



VASO PL PRIMAVERA 5 RED MED CINZA

Código: **35215** Fábrica: **NUTRIPLAN** Unidade: **UN/1**  
**F1 F4**

22 cm  
25 cm  
8lts



VASO PL PRIMAVERA 5 RED MED MARROM

Código: **22166** Fábrica: **NUTRIPLAN** Unidade: **UN/1**  
**F1 F4**



VASO PL PRIMAVERA 5 RED MED PRETO

Código: **22170** Fábrica: **NUTRIPLAN** Unidade: **UN/1**  
**F1 F4**



VASO PL PRIMAVERA 6 RED GDE MARROM 6 L

Código: **22167** Fábrica: **NUTRIPLAN** Unidade: **UN/1**  
**F1 F4**



VASO PL PRIMAVERA 6 RED GDE PRETO

Código: **22171** Fábrica: **NUTRIPLAN** Unidade: **UN/1**  
**F1 F4**

40 cm  
29 cm

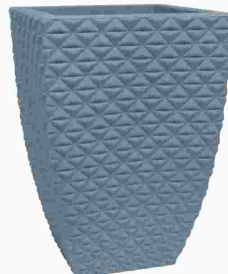

VASO PL QUAD BERLIAN GOLD P AZUL A82-9

Código: **40031** Fábrica: **PAIOL** Unidade: **UN/1**  
**F1 F4**

40 cm  
29 cm

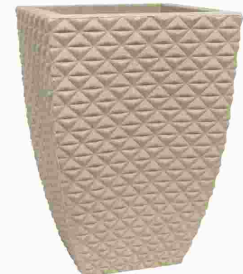

VASO PL QUAD BERLIAN GOLD P BEGE A82-1

Código: **40029** Fábrica: **PAIOL** Unidade: **UN/1**  
**F1 F4**

40 cm  
29 cm

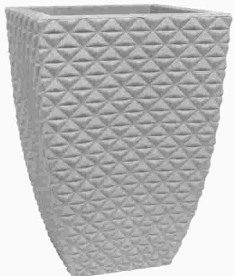

VASO PL QUAD BERLIAN GOLD P CIMENT A82-5

Código: **40030** Fábrica: **PAIOL** Unidade: **UN/1**  
**F1 F4**

40 cm  
29 cm



VASO PL QUAD BERLIAN GOLD P MAROM A82-2

Código: **40028** Fábrica: **PAIOL** Unidade: **UN/1**  
**F1 F4**

27 cm  
19,5 cm



VASO PL QUAD BOJO 0 AZUL 53-7











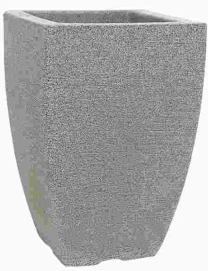
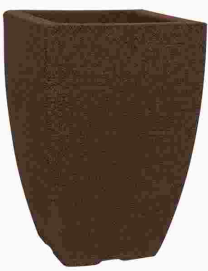





Código: **39946** Fábrica: **PAIOL** Unidade: **UN/1**  
**F1 F4**









27 cm  
19,5 cm



VASO PL QUAD BOJO 0 BEGE 53-2

Código: **39944** Fábrica: **PAIOL** Unidade: **UN/1**  
**F1 F4**

 <p>27 cm 19,5 cm</p> <p>VASO PL QUAD BOJO 0 CIMENTO 53-4 Código: <b>39945</b> Fábrica: <b>PAIOL</b> Unidade: <b>UN/1</b> <b>F1 F4</b></p>	 <p>27 cm 19,5 cm</p> <p>VASO PL QUAD BOJO 0 MARROM 53-3 Código: <b>39943</b> Fábrica: <b>PAIOL</b> Unidade: <b>UN/1</b> <b>F1 F4</b></p>	 <p>1,7 L</p> <p>VASO PL QUAD COLOR 1,7LTS 403 Código: <b>41516</b> Fábrica: <b>ARIPLAS</b> Unidade: <b>UN/1</b> <b>F1 F4</b></p>	 <p>3,5 L</p> <p>VASO PL QUAD COLOR 3,5LTS 405 Código: <b>41518</b> Fábrica: <b>ARIPLAS</b> Unidade: <b>UN/1</b> <b>F1 F4</b></p>
 <p>6 L</p> <p>VASO PL QUAD COLOR 6,4LTS 407 Código: <b>41520</b> Fábrica: <b>ARIPLAS</b> Unidade: <b>UN/1</b> <b>F1 F4</b></p>	 <p>14 cm 16 cm 2 lts</p> <p>VASO PL QUAD MARROM 2,0 LTS 1332 Código: <b>36988</b> Fábrica: <b>ERCAPLAST</b> Unidade: <b>UN/1</b> <b>F1 F4</b></p>	 <p>19 cm 22 cm 4,6 lts</p> <p>VASO PL QUAD MARROM 4,6 LTS 1334 Código: <b>36987</b> Fábrica: <b>ERCAPLAST</b> Unidade: <b>UN/1</b> <b>F1 F4</b></p>	 <p>11 cm 18 cm 0,8 lts</p> <p>VASO PL QUAD MARROM 800 ML 1384 2X1 Código: <b>36990</b> Fábrica: <b>ERCAPLAST</b> Unidade: <b>CJ/2</b> <b>F1 F4</b></p>
 <p>1,7 L</p> <p>VASO PL QUAD PRETO 1,7LTS 404 Código: <b>41517</b> Fábrica: <b>ARIPLAS</b> Unidade: <b>UN/1</b> <b>F1 F4</b></p>	 <p>14 cm 16 cm 2 lts</p> <p>VASO PL QUAD PRETO 2,0 LTS 1331 Código: <b>36989</b> Fábrica: <b>ERCAPLAST</b> Unidade: <b>UN/1</b> <b>F1 F4</b></p>	 <p>3,5 L</p> <p>VASO PL QUAD PRETO 3,5LTS 406 Código: <b>41519</b> Fábrica: <b>ARIPLAS</b> Unidade: <b>UN/1</b> <b>F1 F4</b></p>	 <p>6 L</p> <p>VASO PL QUAD PRETO 6,4LTS 408 Código: <b>41521</b> Fábrica: <b>ARIPLAS</b> Unidade: <b>UN/1</b> <b>F1 F4</b></p>
  <p>11 cm 18 cm 0,8 lts</p> <p>VASO PL QUAD PRETO 800 ML 1383 2X1 Código: <b>36991</b> Fábrica: <b>ERCAPLAST</b> Unidade: <b>CJ/2</b> <b>F1 F4</b></p>	 <p>24 cm 28 cm 9,5 lts</p> <p>VASO PL QUAD PRETO 9,5 LTS 1349 Código: <b>36985</b> Fábrica: <b>ERCAPLAST</b> Unidade: <b>UN/1</b> <b>F1 F4</b></p>	 <p>11 cm 16 cm 0,85 lts</p> <p>VASO PL QUARTZO 11 FERRUGEM 0,85 LTS Código: <b>37845</b> Fábrica: <b>NUTRIPLAN</b> Unidade: <b>UN/1</b> <b>F1 F4</b></p>	 <p>16 cm 23 cm 4,75 lts</p> <p>VASO PL QUARTZO 16 FERRUGEM 4,75 LTS Código: <b>37846</b> Fábrica: <b>NUTRIPLAN</b> Unidade: <b>UN/1</b> <b>F1 F4</b></p>

 <p> <b>22 cm</b>  <b>31 cm</b>  <b>8 lts</b> </p> <p>VASO PL QUARTZO 22 FERRUGEM 8LTS                  Código: <b>37847</b> Fábrica: <b>NUTRIPLAN</b> Unidade: <b>UN/1</b>  <b>F1 F4</b></p>	 <p> <b>30 cm</b>  <b>43 cm</b>  <b>25 lts</b> </p> <p>VASO PL QUARTZO 30 FERRUGEM 25LTS                  Código: <b>37848</b> Fábrica: <b>NUTRIPLAN</b> Unidade: <b>UN/1</b>  <b>F1 F4</b></p>	 <p> <b>18,5 cm</b>  <b>23 cm</b> </p> <p>VASO PL RED BOJO CONE 0 BEGE 96-1                  Código: <b>39934</b> Fábrica: <b>PAIOL</b> Unidade: <b>UN/1</b>  <b>F1 F4</b></p>	 <p> <b>18,5 cm</b>  <b>23 cm</b> </p> <p>VASO PL RED BOJO CONE 0 CIMENTO 96-5                  Código: <b>39933</b> Fábrica: <b>PAIOL</b> Unidade: <b>UN/1</b>  <b>F1 F4</b></p>
 <p> <b>29 cm</b>  <b>34 cm</b> </p> <p>VASO PL RED BOJO CONE 1 AZUL 73-7                  Código: <b>39938</b> Fábrica: <b>PAIOL</b> Unidade: <b>UN/1</b>  <b>F1 F4</b></p>	 <p> <b>29 cm</b>  <b>34 cm</b> </p> <p>VASO PL RED BOJO CONE 1 BEGE 73-2                  Código: <b>39936</b> Fábrica: <b>PAIOL</b> Unidade: <b>UN/1</b>  <b>F1 F4</b></p>	 <p> <b>29 cm</b>  <b>34 cm</b> </p> <p>VASO PL RED BOJO CONE 1 MARROM 73-1                  Código: <b>39935</b> Fábrica: <b>PAIOL</b> Unidade: <b>UN/1</b>  <b>F1 F4</b></p>	 <p> <b>16 cm</b>  <b>27 cm</b>  <b>6 lts</b> </p> <p>VASO PL RED CANELAD PRETO 6L C/ALCA 2617                  Código: <b>37002</b> Fábrica: <b>ERCAPLAST</b> Unidade: <b>UN/1</b>  <b>F1 F4</b></p>
 <p> <b>12,5 cm</b>  <b>25 cm</b>  <b>3 lts</b> </p> <p>VASO PL RED CUIA COLOR 3L 2598                  Código: <b>37006</b> Fábrica: <b>ERCAPLAST</b> Unidade: <b>UN/1</b>  <b>F1 F4</b></p>	 <p> <b>11 cm</b>  <b>12 cm</b>  <b>0,7 lts</b> </p> <p>VASO PL RED MARROM 700 ML 1382 2X1                  Código: <b>36984</b> Fábrica: <b>ERCAPLAST</b> Unidade: <b>CJ/2</b>  <b>F1 F4</b></p>	 <p> <b>37 cm</b>  <b>28 cm</b>  <b>7,5 lts</b> </p> <p>VASO PL RED MARROM 7,5 LTS 1323                  Código: <b>36979</b> Fábrica: <b>ERCAPLAST</b> Unidade: <b>UN/1</b>  <b>F1 F4</b></p>	 <p> <b>37 cm</b>  <b>28 cm</b>  <b>7,5 lts</b> </p> <p>VASO PL RED PRETO N22 3,7LTS 926                  Código: <b>51043</b> Fábrica: <b>LUMAR</b> Unidade: <b>UN/1</b>  <b>F1 F4</b></p>
 <p> <b>31 cm</b>  <b>35 cm</b>  <b>15 lts</b> </p> <p>VASO PL RED PRETO N28 8,0LTS 915                  Código: <b>51044</b> Fábrica: <b>LUMAR</b> Unidade: <b>UN/1</b>  <b>F1 F4</b></p>	 <p> <b>31 cm</b>  <b>35 cm</b>  <b>15 lts</b> </p> <p>VASO PL RED PRETO N36 16LTS 916                  Código: <b>51045</b> Fábrica: <b>LUMAR</b> Unidade: <b>UN/1</b>  <b>F1 F4</b></p>	 <p> <b>14 cm</b>  <b>17 cm</b>  <b>1,75 lts</b> </p> <p>VASO PL RED PRETO 15 LTS 1328                  Código: <b>36977</b> Fábrica: <b>ERCAPLAST</b> Unidade: <b>UN/1</b>  <b>F1 F4</b></p>	 <p> <b>14 cm</b>  <b>17 cm</b>  <b>1,75 lts</b> </p> <p>VASO PL RED PRETO 1,75 LTS 1305                  Código: <b>36982</b> Fábrica: <b>ERCAPLAST</b> Unidade: <b>UN/1</b>  <b>F1 F4</b></p>

 <p>VASO PL RED PRETO 3,8 LTS 1306 Código: <b>36981</b> Fábrica: <b>ERCAPLAST</b> Unidade: <b>UN/1</b> <b>F1 F4</b></p> <p>18 cm 22 cm 3,8 lts</p>	 <p>VASO PL RED PRETO 700 ML 1381 2X1 Código: <b>36983</b> Fábrica: <b>ERCAPLAST</b> Unidade: <b>CJ/2</b> <b>F1 F4</b></p> <p>11 cm 12 cm 0,7 lts</p>	 <p>VASO PL RED PRETO 7,5 LTS 1322 Código: <b>36978</b> Fábrica: <b>ERCAPLAST</b> Unidade: <b>UN/1</b> <b>F1 F4</b></p> <p>37 cm 28 cm 7,5 lts</p>	 <p>VASO PL RED RELEVO 40 PRETO Código: <b>41387</b> Fábrica: <b>NUTRIPLAN</b> Unidade: <b>UN/1</b> <b>F1 F4</b></p> <p>48 cm 40 cm</p>
 <p>VASO PL RED RELEVO 40 TABACO Código: <b>41386</b> Fábrica: <b>NUTRIPLAN</b> Unidade: <b>UN/1</b> <b>F1 F4</b></p> <p>48 cm 40 cm</p>	 <p>VASO PL RELEVO OVAL 23 CARVALHO Código: <b>44137</b> Fábrica: <b>NUTRIPLAN</b> Unidade: <b>UN/1</b> <b>F1 F4</b></p> <p>24 cm 54 cm</p>	 <p>VASO PL RELEVO OVAL 42 CARVALHO Código: <b>44139</b> Fábrica: <b>NUTRIPLAN</b> Unidade: <b>UN/1</b> <b>F1 F4</b></p> <p>42 cm 40 cm</p>	 <p>VASO PL RELEVO OVAL 42 CIMENTO Código: <b>44140</b> Fábrica: <b>NUTRIPLAN</b> Unidade: <b>UN/1</b> <b>F1 F4</b></p> <p>42 cm 40 cm</p>
 <p>VASO PL RELEVO REDONDO 67 97LT CIMENTO Código: <b>42183</b> Fábrica: <b>NUTRIPLAN</b> Unidade: <b>UN/1</b> <b>F1 F4</b></p> <p>67 cm 48 cm</p>	 <p>VASO PL RELEVO REDONDO 67 97LT CIMENTO Q Código: <b>42184</b> Fábrica: <b>NUTRIPLAN</b> Unidade: <b>UN/1</b> <b>F1 F4</b></p> <p>67 cm 48 cm</p>	 <p>VASO PL RELEVO REDONDO 67 97LT OURO ENVE Código: <b>42185</b> Fábrica: <b>NUTRIPLAN</b> Unidade: <b>UN/1</b> <b>F1 F4</b></p> <p>67 cm 48 cm</p>	 <p>VASO PL RISCATTO CONICO 42 FERRUGEM 20LT Código: <b>30280</b> Fábrica: <b>NUTRIPLAN</b> Unidade: <b>UN/1</b> <b>F1 F4</b></p> <p>42 cm 30 cm</p>
 <p>VASO PL RISCATTO CONICO 42 GRANITO 20LTS Código: <b>30281</b> Fábrica: <b>NUTRIPLAN</b> Unidade: <b>UN/1</b> <b>F1 F4</b></p> <p>42 cm 30 cm</p>	 <p>VASO PL RISCATTO CONICO 55 FERRUGEM 44LT Código: <b>30282</b> Fábrica: <b>NUTRIPLAN</b> Unidade: <b>UN/1</b> <b>F1 F4</b></p> <p>55 cm 39 cm</p>	 <p>VASO PL RISCATTO CONICO 55 GRANITO 44LTS Código: <b>30283</b> Fábrica: <b>NUTRIPLAN</b> Unidade: <b>UN/1</b> <b>F1 F4</b></p> <p>55 cm 39 cm</p>	 <p>VASO PL RISCATTO OVAL BAIXO 22 AREIA 12L Código: <b>30270</b> Fábrica: <b>NUTRIPLAN</b> Unidade: <b>UN/1</b> <b>F1 F4</b></p> <p>22 cm 31 cm</p>

<p> <b>22 cm</b> <b>31 cm</b></p> <p>VASO PL RISCATTO OVAL BAIXO 22 FERRU 12L Código: <b>30271</b> Fábrica: <b>NUTRIPLAN</b> Unidade: <b>UN/1</b> <b>F1 F4</b></p>	<p> <b>22 cm</b> <b>31 cm</b> <b>12 lts</b></p> <p>VASO PL RISCATTO OVAL BAIXO 22 GRANI 12L Código: <b>37410</b> Fábrica: <b>NUTRIPLAN</b> Unidade: <b>UN/1</b> <b>F1 F4</b></p>	<p> <b>30 cm</b> <b>43 cm</b></p> <p>VASO PL RISCATTO OVAL BAIXO 30 AREIA 32L Código: <b>30269</b> Fábrica: <b>NUTRIPLAN</b> Unidade: <b>UN/1</b> <b>F1 F4</b></p>	<p> <b>30 cm</b> <b>43 cm</b></p> <p>VASO PL RISCATTO OVAL BAIXO 30 FERRU 32L Código: <b>30268</b> Fábrica: <b>NUTRIPLAN</b> Unidade: <b>UN/1</b> <b>F1 F4</b></p>
<p> <b>35 cm</b> <b>28 cm</b></p> <p>VASO PL RISCATTO RED 34 AREIA 26,5LT Código: <b>30272</b> Fábrica: <b>NUTRIPLAN</b> Unidade: <b>UN/1</b> <b>F1 F4</b></p>	<p> <b>35 cm</b> <b>28 cm</b></p> <p>VASO PL RISCATTO RED 34 FERRUGEM 26,5LTS Código: <b>30273</b> Fábrica: <b>NUTRIPLAN</b> Unidade: <b>UN/1</b> <b>F1 F4</b></p>	<p> <b>35 cm</b> <b>28 cm</b></p> <p>VASO PL RISCATTO RED 34 GRANITO 26,5LTS Código: <b>30274</b> Fábrica: <b>NUTRIPLAN</b> Unidade: <b>UN/1</b> <b>F1 F4</b></p>	<p> <b>9,5 cm</b> <b>12,5 cm</b></p> <p>VASO PL ROMANO RED MINI MARROM 0,6L Código: <b>22309</b> Fábrica: <b>NUTRIPLAN</b> Unidade: <b>UN/1</b> <b>F1 F4</b></p>
<p> <b>14,5 cm</b> <b>19 cm</b></p> <p>VASO PL ROMANO 0 RED PEQ MARROM 2L Código: <b>22308</b> Fábrica: <b>NUTRIPLAN</b> Unidade: <b>UN/1</b> <b>F1 F4</b></p>	<p> <b>2 lts</b></p> <p>VASO PL ROMANO 0 RED PEQ PRETO 2L Código: <b>39641</b> Fábrica: <b>NUTRIPLAN</b> Unidade: <b>UN/1</b> <b>F1 F4</b></p>	<p> <b>19,5 cm</b> <b>25 cm</b></p> <p>VASO PL ROMANO 1 RED MED MARROM 5L Código: <b>22307</b> Fábrica: <b>NUTRIPLAN</b> Unidade: <b>UN/1</b> <b>F1 F4</b></p>	<p> <b>5 lts</b></p> <p>VASO PL ROMANO 1 RED MED PRETO 5L Código: <b>39642</b> Fábrica: <b>NUTRIPLAN</b> Unidade: <b>UN/1</b> <b>F1 F4</b></p>
<p> <b>23 cm</b> <b>30 cm</b></p> <p>VASO PL ROMANO 2 RED GDE MARROM 8,5L Código: <b>22306</b> Fábrica: <b>NUTRIPLAN</b> Unidade: <b>UN/1</b> <b>F1 F4</b></p>	<p> <b>8,5 lts</b></p> <p>VASO PL ROMANO 2 RED PRETO 8,5L Código: <b>39643</b> Fábrica: <b>NUTRIPLAN</b> Unidade: <b>UN/1</b> <b>F1 F4</b></p>	<p> <b>23 cm</b> <b>30 cm</b> <b>8,5 lts</b></p> <p>VASO PL ROMANO 2 RED TABACO 8,5L Código: <b>39855</b> Fábrica: <b>NUTRIPLAN</b> Unidade: <b>UN/1</b> <b>F1 F4</b></p>	<p> <b>30 cm</b> <b>39 cm</b> <b>19 lts</b></p> <p>VASO PL ROMANO 3 RED CAPUCCINO 19L Código: <b>36195</b> Fábrica: <b>NUTRIPLAN</b> Unidade: <b>UN/1</b> <b>F1 F4</b></p>

30 cm  
39 cm

19 lts

10 cm  
13 cm

10 cm  
14,5 cm



VASO PL ROMANO 3 RED MARROM 19 L

Código: **22305** Fábrica: **NUTRIPLAN** Unidade: **UN/1**  
**F1 F4**

VASO PL ROMANO 3 RED PRETO 19 L

Código: **39644** Fábrica: **NUTRIPLAN** Unidade: **UN/1**  
**F1 F4**

VASO PL SINT 13 S/BORDA ARGILA 0908-1

Código: **37083** Fábrica: **PAIOL** Unidade: **UN/1**  
**F1 F4**

VASO PL SINT 13 S/BORDA BANANA 0908-2

Código: **39445** Fábrica: **PAIOL** Unidade: **UN/1**  
**F1 F4**

14 cm  
15 cm

20 cm  
15 cm



VASO PL SINT 16 S/BORDA BANANA 3598-2

Código: **37082** Fábrica: **PAIOL** Unidade: **UN/1**  
**F1 F4**

VASO PL SINT 16 S/BORDA CAPUCINO 3598

Código: **39465** Fábrica: **PAIOL** Unidade: **UN/1**  
**F1 F4**

VASO PL SINT 18 S/BORDA ARGILA 909-1

Código: **37081** Fábrica: **PAIOL** Unidade: **UN/1**  
**F1 F4**

VASO PL SINT 18 S/BORDA BANANA 909-2

Código: **40843** Fábrica: **PAIOL** Unidade: **UN/1**  
**F1 F4**

15 cm  
20 cm



VASO PL SINT 18 S/BORDA CAFE 909-4

Código: **39462** Fábrica: **PAIOL** Unidade: **UN/1**  
**F1 F4**

VASO PL SINT 18 S/BORDA CAPUCINO 909

Código: **39463** Fábrica: **PAIOL** Unidade: **UN/1**  
**F1 F4**

VASO PL SINT 20 S/BORDA BANANA 8006-4

Código: **40844** Fábrica: **PAIOL** Unidade: **UN/1**  
**F1 F4**

VASO PL SINT 24 S/BORDA BANANA 3538-2

Código: **37089** Fábrica: **PAIOL** Unidade: **UN/1**  
**F1 F4**

2,5 cm  
66 cm

19 cm  
25 cm

30 cm  
24 cm

34 cm  
42 cm



VASO PL SINT 24 S/BORDA CAPUCINO 3538-3

Código: **39929** Fábrica: **PAIOL** Unidade: **UN/1**  
**F1 F4**

VASO PL SINT 27 S/BORDA ARGILA 3541-1

Código: **41755** Fábrica: **PAIOL** Unidade: **UN/1**  
**F1 F4**

VASO PL SINT 27 S/BORDA BANANA 3541-2

Código: **37088** Fábrica: **PAIOL** Unidade: **UN/1**  
**F1 F4**

VASO PL SINT 98 C/BORDA ARGILA 26958-1

Código: **37122** Fábrica: **PAIOL** Unidade: **UN/1**  
**F1 F4**

5 cm  
7 cm



VASO PL SISAL POTE MINI AVELA 8000-4

Código: **40594** Fábrica: **PAIOL** Unidade: **UN/1**  
**F1 F4**

5 cm  
7 cm



VASO PL SISAL POTE MINI MARROM 8000-1

Código: **40592** Fábrica: **PAIOL** Unidade: **UN/1**  
**F1 F4**

5,5 cm  
7,5 cm



VASO PL SISAL POTE MINI NATURAL 8000-2

Código: **37131** Fábrica: **PAIOL** Unidade: **UN/1**  
**F1 F4**



VASO PL SISAL POTE 10 AVELA 8001

Código: **39448** Fábrica: **PAIOL** Unidade: **UN/1**  
**F1 F4**



VASO PL SISAL POTE 10 CARAMELO 8001

Código: **39449** Fábrica: **PAIOL** Unidade: **UN/1**  
**F1 F4**



VASO PL SISAL POTE 10 MARROM 8001

Código: **39447** Fábrica: **PAIOL** Unidade: **UN/1**  
**F1 F4**

8 cm  
11 cm



VASO PL SISAL POTE 10 NATURAL 8001-3

Código: **37130** Fábrica: **PAIOL** Unidade: **UN/1**  
**F1 F4**

9 cm  
13 cm



VASO PL SISAL POTE 12 CORES 8002

Código: **37129** Fábrica: **PAIOL** Unidade: **UN/1**  
**F1 F4**

10 cm  
15 cm



VASO PL SISAL POTE 14 CORES 8003

Código: **37128** Fábrica: **PAIOL** Unidade: **UN/1**  
**F1 F4**

12 cm  
16 cm



VASO PL SISAL POTE 16 CORES 8004

Código: **37127** Fábrica: **PAIOL** Unidade: **UN/1**  
**F1 F4**

25 cm  
30 cm



VASO PL TERRACOTA 2 MED MARROM

Código: **18480** Fábrica: **NUTRIPLAN** Unidade: **UN/1**  
**F1 F4**

31 cm  
39 cm



VASO PL TERRACOTA 3 GDE MARROM 22 L

Código: **18482** Fábrica: **NUTRIPLAN** Unidade: **UN/1**  
**F1 F4**

22 lts



VASO PL TERRACOTA 3 GDE PTO 22 L

Código: **18483** Fábrica: **NUTRIPLAN** Unidade: **UN/1**  
**F1 F4**

19cm



VASO PL TEXTURIZADO OVAL 19 AREIA 5,3L

Código: **47612** Fábrica: **NUTRIPLAN** Unidade: **UN/1**  
**F1 F4**

19cm



VASO PL TEXTURIZADO OVAL 19 CIMENTO 5,3L

Código: **47614** Fábrica: **NUTRIPLAN** Unidade: **UN/1**  
**F1 F4**

19cm



VASO PL TEXTURIZADO OVAL 19 FERRUGE 5,3L

Código: **47611** Fábrica: **NUTRIPLAN** Unidade: **UN/1**  
**F1 F4**

<p><b>19cm</b></p>  <p>VASO PL TEXTURIZADO OVAL 19 GRANITO 5,3L                  Código: <b>47613</b> Fábrica: <b>NUTRIPLAN</b> Unidade: <b>UN/1</b>  <b>F1 F4</b></p>	<p><b>19cm</b></p>  <p>VASO PL TEXTURIZADO OVAL 19 PRETO 5,3L                  Código: <b>47615</b> Fábrica: <b>NUTRIPLAN</b> Unidade: <b>UN/1</b>  <b>F1 F4</b></p>	<p><b>34 cm</b> <b>41 cm</b></p>  <p>VASO PL TINA RED 34 CARVALHO 30LTS                  Código: <b>30311</b> Fábrica: <b>NUTRIPLAN</b> Unidade: <b>UN/1</b>  <b>F1 F4</b></p>	<p><b>45 cm</b> <b>54 cm</b></p>  <p>VASO PL TINA RED 45 CARVALHO 80LTS                  Código: <b>30332</b> Fábrica: <b>NUTRIPLAN</b> Unidade: <b>UN/1</b>  <b>F1 F4</b></p>
<p><b>30 cm</b> <b>14 cm</b> <b>6,5 lts</b></p>  <p>VASO PL TRECCIA CONICO 30 CARVALHO 6,5LT                  Código: <b>33388</b> Fábrica: <b>NUTRIPLAN</b> Unidade: <b>UN/1</b>  <b>F1 F4</b></p>	<p><b>30 cm</b> <b>14 cm</b> <b>6,5 lts</b></p>  <p>VASO PL TRECCIA CONICO 30 ENVELHECI 6,5L                  Código: <b>32745</b> Fábrica: <b>NUTRIPLAN</b> Unidade: <b>UN/1</b>  <b>F1 F4</b></p>	<p><b>39 cm</b> <b>30 cm</b> <b>33 lts</b></p>  <p>VASO PL TRECCIA CONICO 39 GRAFITE 33LTS                  Código: <b>36806</b> Fábrica: <b>NUTRIPLAN</b> Unidade: <b>UN/1</b>  <b>F1 F4</b></p>	<p><b>53 cm</b> <b>36 cm</b></p>  <p>VASO PL TRECCIA CONICO 53 CARVALHO 42LTS                  Código: <b>32747</b> Fábrica: <b>NUTRIPLAN</b> Unidade: <b>UN/1</b>  <b>F1 F4</b></p>
<p><b>33 cm</b> <b>43 cm</b></p>  <p>VASO PL TRECCIA OVAL 33 CARVALHO 19LTS                  Código: <b>32748</b> Fábrica: <b>NUTRIPLAN</b> Unidade: <b>UN/1</b>  <b>F1 F4</b></p>	<p><b>24 cm</b> <b>26,5 cm</b> <b>8,5 lts</b></p>  <p>VASO PL TRECCIA RED 24 CARVALHO 8,5LTS                  Código: <b>33389</b> Fábrica: <b>NUTRIPLAN</b> Unidade: <b>UN/1</b>  <b>F1 F4</b></p>	<p><b>24 cm</b> <b>26,5 cm</b> <b>8,5 lts</b></p>  <p>VASO PL TRECCIA RED 24 ENVELHECIDO 8,5LT                  Código: <b>33390</b> Fábrica: <b>NUTRIPLAN</b> Unidade: <b>UN/1</b>  <b>F1 F4</b></p>	<p><b>24 cm</b> <b>26,5 cm</b> <b>8,5 lts</b></p>  <p>VASO PL TRECCIA RED 24 RUBI 8,5LTS                  Código: <b>33391</b> Fábrica: <b>NUTRIPLAN</b> Unidade: <b>UN/1</b>  <b>F1 F4</b></p>
<p><b>31 cm</b> <b>34 cm</b> <b>20 lts</b></p>  <p>VASO PL TRECCIA RED 31 CARVALHO 20LTS                  Código: <b>33393</b> Fábrica: <b>NUTRIPLAN</b> Unidade: <b>UN/1</b>  <b>F1 F4</b></p>	<p><b>31 cm</b> <b>34 cm</b> <b>20 lts</b></p>  <p>VASO PL TRECCIA RED 31 ENVELHECIDO 20LTS                  Código: <b>32749</b> Fábrica: <b>NUTRIPLAN</b> Unidade: <b>UN/1</b>  <b>F1 F4</b></p>	<p><b>31 cm</b> <b>34 cm</b> <b>20 lts</b></p>  <p>VASO PL TRECCIA RED 31 GRAFITE 20LTS                  Código: <b>36804</b> Fábrica: <b>NUTRIPLAN</b> Unidade: <b>UN/1</b>  <b>F1 F4</b></p>	<p><b>31 cm</b> <b>34 cm</b> <b>20 lts</b></p>  <p>VASO PL TRECCIA RED 31 MARINHO 20LTS                  Código: <b>36805</b> Fábrica: <b>NUTRIPLAN</b> Unidade: <b>UN/1</b>  <b>F1 F4</b></p>

31 cm  
34 cm  
20 lts



VASO PL TRECCIA RED 31 RUBI 20LTS

Código: 33394 Fábrica: NUTRIPLAN Unidade: UN/1 F1 F4

109 cm



VASO PL TREVO PRETO 09CM 226

Código: 40716 Fábrica: PLASMARC Unidade: UN/1 F1 F4

22 cm  
25 cm  
5 lts



VASO PL VB 25 PRETO 5L 525

Código: 37716 Fábrica: BIG PLAST Unidade: UN/1 F1 F4

27 cm  
30 cm



VASO PL VB 30 S/BORDA 7059

Código: 37090 Fábrica: PAIOL Unidade: UN/1 F1 F4

30 cm  
34 cm  
13 lts



VASO PL VB 34 PRETO 13L 534

Código: 37711 Fábrica: BIG PLAST Unidade: UN/1 F1 F4

29 cm  
35 cm



VASO PL VB 35 S/BORDA ARGILA 7060-1

Código: 37091 Fábrica: PAIOL Unidade: UN/1 F1 F4

40 cm  
45 cm



VASO PL VB 45 S/BORDA 7061

Código: 37092 Fábrica: PAIOL Unidade: UN/1 F1 F4

17 cm  
22 cm



VASO PL VIME SINT N4 CORES 8006

Código: 37216 Fábrica: PAIOL Unidade: UN/1 F1 F4

10 cm  
15 cm



VASO PL VIOLETA QUAD CAFE 00140

Código: 37148 Fábrica: PAIOL Unidade: UN/1 F1 F4



VASO PL VIOLETA RED FIO ARGILA 4569-1

Código: 41753 Fábrica: PAIOL Unidade: UN/1 F1 F4

8 cm  
15 cm



VASO PL VIOLETA RED MADEIRA ENVELHE 1460

Código: 37110 Fábrica: PAIOL Unidade: UN/1 F1 F4

20 cm  
25 cm  
7 lts



VASO PL VQ 25 QUAD PRETO 7L 583

Código: 37703 Fábrica: BIG PLAST Unidade: UN/1 F1 F4

30 cm  
35 cm  
20 lts



VASO PL VQ 35 QUAD PRETO 20L 586

Código: 37702 Fábrica: BIG PLAST Unidade: UN/1 F1 F4

10 cm



VASO PL 0 RED PRETO 08CM 300

Código: 40713 Fábrica: PLASMARC Unidade: UN/1 F1 F4

11 cm



VASO PL 1 QUAD PRETO 11CM 234

Código: 40712 Fábrica: PLASMARC Unidade: UN/1 F1 F4

50 cm  
58 cm  
90 lts



VASO PL 10 RED GIG PRETO 90LTS

Código: 39640 Fábrica: NUTRIPLAN Unidade: UN/1 F1 F4

<p></p> <p><b>11 cm</b></p> <p>VASO PL 11CM C/PRATO 11CM PRETO 346                  Código: <b>40851</b> Fábrica: <b>JOREAL</b> Unidade: <b>UN/1</b>  <b>F1 F4</b></p>	<p></p> <p>VASO PL 12LTS MARFIM 6408                  Código: <b>41481</b> Fábrica: <b>KOZI PLAST</b> Unidade: <b>UN/1</b>  <b>F1 F4</b></p>	<p></p> <p><b>25cm</b>  <b>32cm</b>  <b>12,5Lts</b></p> <p>VASO PL 12,5 LTS QUAD GDE PRETO 6701                  Código: <b>26767</b> Fábrica: <b>INPLAST</b> Unidade: <b>UN/1</b>  <b>F1 F4</b></p>	<p></p> <p><b>15 cm</b>  <b>17 cm</b>  <b>1,8 lts</b></p> <p>VASO PL 17 PRETO 1,8L 308                  Código: <b>37718</b> Fábrica: <b>BIG PLAST</b> Unidade: <b>UN/1</b>  <b>F1 F4</b></p>
<p></p> <p><b>17 cm</b>  <b>20 cm</b>  <b>3,3 lts</b></p> <p>VASO PL 20 PRETO 3,3L 316                  Código: <b>37717</b> Fábrica: <b>BIG PLAST</b> Unidade: <b>UN/1</b>  <b>F1 F4</b></p>	<p></p> <p><b>20 cm</b>  <b>24 cm</b>  <b>6 lts</b></p> <p>VASO PL 24 PRETO 6L 324                  Código: <b>37715</b> Fábrica: <b>BIG PLAST</b> Unidade: <b>UN/1</b>  <b>F1 F4</b></p>	<p></p> <p><b>23 cm</b>  <b>27 cm</b>  <b>8,5 L</b></p> <p>VASO PL 27 PRETO 8,5L 332                  Código: <b>37714</b> Fábrica: <b>BIG PLAST</b> Unidade: <b>UN/1</b>  <b>F1 F4</b></p>	<p></p> <p><b>14 cm</b></p> <p>VASO PL 3 QUAD PRETO 14CM 129                  Código: <b>40711</b> Fábrica: <b>PLASMARC</b> Unidade: <b>UN/1</b>  <b>F1 F4</b></p>
<p></p> <p><b>26 cm</b>  <b>30 cm</b>  <b>11,5 lts</b></p> <p>VASO PL 30 PRETO 11,5L 340                  Código: <b>37713</b> Fábrica: <b>BIG PLAST</b> Unidade: <b>UN/1</b>  <b>F1 F4</b></p>	<p></p> <p><b>30 cm</b>  <b>35 cm</b>  <b>22 lts</b></p> <p>VASO PL 35 PRETO 22L 348                  Código: <b>37710</b> Fábrica: <b>BIG PLAST</b> Unidade: <b>UN/1</b>  <b>F1 F4</b></p>	<p></p> <p><b>5,5L</b></p> <p>VASO PL 5,5 LTS QUAD MED PTO 6700                  Código: <b>26762</b> Fábrica: <b>INPLAST</b> Unidade: <b>UN/1</b>  <b>F1 F4</b></p>	<p></p> <p><b>5,5 L</b></p> <p>VASO PL 5,5 LTS QUAD MED TERRACOTA 6718                  Código: <b>26765</b> Fábrica: <b>INPLAST</b> Unidade: <b>UN/1</b>  <b>F1 F4</b></p>
<p></p> <p><b>5,5 L</b></p> <p>VASO PL 5,5 LTS RED MED TERRACOTA 6712                  Código: <b>26764</b> Fábrica: <b>INPLAST</b> Unidade: <b>UN/1</b>  <b>F1 F4</b></p>	<p></p> <p>VASSOURA PELO SINTETICO M9 522 12X1                  Código: <b>38416</b> Fábrica: <b>N.HORIZONTE</b> Unidade: <b>DZ/12</b>  <b>F1 F4</b></p>	<p></p> <p>VASSOURA PIACAVA NYLON CECI C/CB 1293                  Código: <b>49806</b> Fábrica: <b>CECI JOIA</b> Unidade: <b>UN/1</b>  <b>F1 F4</b></p>	<p></p> <p>VASSOURA PIACAVA NYLON JOIA C/CB UN 3241                  Código: <b>49805</b> Fábrica: <b>CECI JOIA</b> Unidade: <b>UN/1</b>  <b>F1 F4</b></p>

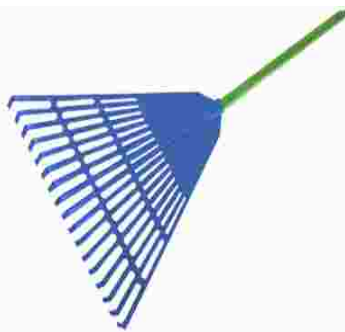

VASSOURA RASTELO PL AZUL P/GRAMA CB MAD  
 Código: 32770 Fábrica: NUTRIPLAN Unidade: UN/1  
 F1 F4



VASSOURA RASTELO PL P/GRAMA 46CM C/CB 80  
 Código: 49807 Fábrica: EDS Unidade: UN/1  
 F1 F4

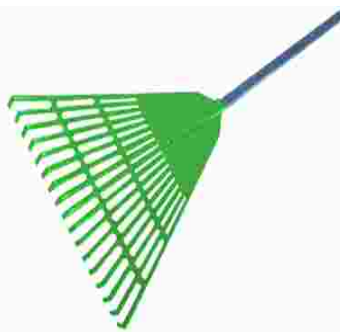

VASSOURA RASTELO PL VERDE P/GRAMA CB MA  
 Código: 18505 Fábrica: NUTRIPLAN Unidade: UN/1  
 F1 F4



VASSOURA RASTELO PLAST P/GRAMA CB MAD  
 Código: 48741 Fábrica: N.HORIZONTE Unidade: UN/1  
 F1 F4

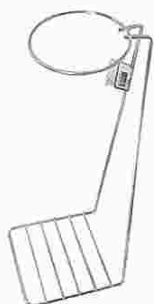

VELADOR CROM MED 18CM C/COADOR 426  
 Código: 30756 Fábrica: ARAMINAS Unidade: UN/1  
 F1 F4



VELADOR CROM MINI C/COADOR 15CM 722  
 Código: 3490 Fábrica: ARAMINAS Unidade: UN/1  
 F1 F4



VELADOR CROM 1 34CM 68  
 Código: 24070 Fábrica: ARAMINAS Unidade: UN/1  
 F1 F4



VELADOR CROM 2 GDE 48CM 69  
 Código: 30922 Fábrica: ARAMINAS Unidade: UN/1  
 F1 F4



VERMICULITA 1 LITRO  
 Código: 48534 Fábrica: NOVATROPICAL Unidade: PT/1  
 F1 F4



XICARA ACRIL CHA 180ML AZUL TIFFANY 1131  
 Código: 49320 Fábrica: QUALYPLAS Unidade: UN/1  
 F1 F4



XICARA VIDRO TRANSP 80ML 5CM 23339 12X1  
 Código: 36748 Fábrica: MABEL Unidade: CX/12  
 F1 F4



XICARAS CHA VID S/PIRES 6X1  
 Código: 47420 Fábrica: BBC GLASS Unidade: CJ/1  
 F1 F4