



ADESIVO GDE MORANGUINHO 10X1

Código: 46744 Fábrica: STICKERS Unidade: PT/10 F1 F4



ADESIVO GDE RELEVO BEN 10 10X1

Código: 37278 Fábrica: STICKERS Unidade: PT/10 F1 F4



ADESIVO GDE RELEVO BETTY BOOP 10X1

Código: 37274 Fábrica: STICKERS Unidade: PT/10 F1 F4



ADESIVO GDE RELEVO GATA MARIE 10X1

Código: 37272 Fábrica: STICKERS Unidade: PT/10 F1 F4



ADESIVO GDE RELEVO HELLO KITTY 10X1

Código: 37275 Fábrica: STICKERS Unidade: PT/10 F1 F4



ADESIVO GDE RELEVO JOLIE 10X1

Código: 37281 Fábrica: STICKERS Unidade: PT/10 F1 F4



ADESIVO GDE RELEVO MORANGUINHO 10X1

Código: 37273 Fábrica: STICKERS Unidade: PT/10 F1 F4



ADESIVO GDE RELEVO PALMEIRAS 10X1

Código: 44252 Fábrica: STICKERS Unidade: PT/10 F1 F4



ADESIVO GDE RELEVO PUCCA 10X1

Código: 37277 Fábrica: STICKERS Unidade: PT/10 F1 F4



ADESIVO GDE RELEVO SAO PAULO 10X1

Código: 37279 Fábrica: STICKERS Unidade: PT/10 F1 F4



ADESIVO GDE RELEVO SORTIDO 10X1

Código: 40709 Fábrica: STICKERS Unidade: PT/10 F1 F4



ADESIVO GDE RELEVO VASCO 10X1

Código: 37280 Fábrica: STICKERS Unidade: PT/10 F1 F4



ADESIVO GIGANTE BARBIE 10X1

Código: 37851 Fábrica: STICKERS Unidade: PT/10 F1 F4



ADESIVO GRANDE BORBOLETAS 12X1

Código: 36429 Fábrica: STICKERS Unidade: DZ/12 F4



ADESIVO GRANDE HELLO KITTY 12X1

Código: 37266 Fábrica: STICKERS Unidade: DZ/12 F1 F4



ADESIVO GRANDE NUMEROS 12X1

Código: 29715 Fábrica: STICKERS Unidade: DZ/12 F1 F4



ADESIVO GRANDE PIU PIU 12X1
 Código: 20769 Fábrica: STICKERS Unidade: DZ/12 F4



ADESIVO GRANDE SMURFS 12X1
 Código: 37267 Fábrica: STICKERS Unidade: DZ/12 F1 F4



ADESIVO GRANDE SNOOPY 12X1
 Código: 18179 Fábrica: STICKERS Unidade: DZ/12 F1 F4



ADESIVO GRANDE SORTIDO 12X1
 Código: 20606 Fábrica: STICKERS Unidade: DZ/12 F1 F4



ADESIVO GRANDE SUPER PODEROSAS 12X1
 Código: 37269 Fábrica: STICKERS Unidade: DZ/12 F1 F4



ADESIVO GRANDE TURMA DA MONICA 12X1
 Código: 29664 Fábrica: STICKERS Unidade: DZ/12 F1 F4



ADESIVO MED BRASIL 10X1
 Código: 51072 Fábrica: STICKERS Unidade: PT/10 F1 F4



ADESIVO MED RELEVO SORTIDO 10X1
 Código: 47212 Fábrica: STICKERS Unidade: PT/10 F1 F4



ADESIVO P BAHIA 12X1
 Código: 22034 Fábrica: STICKERS Unidade: DZ/12 F1 F4



ADESIVO P BARBIE 12X1
 Código: 22025 Fábrica: STICKERS Unidade: DZ/12 F1 F4



ADESIVO P BARNEY E SEUS AMIGOS 12X1
 Código: 46737 Fábrica: STICKERS Unidade: DZ/12 F1 F4



ADESIVO P BAT MAN 12X1
 Código: 25021 Fábrica: STICKERS Unidade: DZ/12 F1 F4



ADESIVO P BORBOLETAS 12X1
 Código: 24028 Fábrica: STICKERS Unidade: DZ/12 F1 F4



ADESIVO P CARROS 12X1
 Código: 18175 Fábrica: STICKERS Unidade: DZ/12 F1 F4



ADESIVO P COCORICO 12X1
 Código: 25721 Fábrica: STICKERS Unidade: DZ/12 F4



ADESIVO P CORACAO 12X1
 Código: 22028 Fábrica: STICKERS Unidade: DZ/12 F1 F4



ADESIVO P CORINTHIANS 12X1

Código: 51080 Fábrica: STICKERS Unidade: DZ/12 F1 F4



ADESIVO P CORUJAS 12X1

Código: 34866 Fábrica: STICKERS Unidade: DZ/12 F1 F4



ADESIVO P CRUZEIRO 12X1

Código: 24853 Fábrica: STICKERS Unidade: DZ/12 F1 F4



ADESIVO P DINOSSAUROS 12X1

Código: 50427 Fábrica: STICKERS Unidade: DZ/12 F1 F4



ADESIVO P DRAGON BALL Z 12X1

Código: 4536 Fábrica: STICKERS Unidade: DZ/12 F1 F4



ADESIVO P ESTRELAS BRILHA NO ESCURO 12X1

Código: 22030 Fábrica: STICKERS Unidade: DZ/12 F4



ADESIVO P GARFIELD 12X1

Código: 16431 Fábrica: STICKERS Unidade: DZ/12 F1 F4



ADESIVO P GASPARZINHO 12X1

Código: 51112 Fábrica: STICKERS Unidade: DZ/12 F4



ADESIVO P HELLO KITT 12X1

Código: 22036 Fábrica: STICKERS Unidade: DZ/12 F1 F4



ADESIVO P LETRAS 12X1

Código: 7354 Fábrica: STICKERS Unidade: DZ/12 F1 F4



ADESIVO P NARUTO 12X1

Código: 51114 Fábrica: STICKERS Unidade: DZ/12 F4



ADESIVO P NATAL 12X1

Código: 37231 Fábrica: STICKERS Unidade: DZ/12 F1 F4



ADESIVO P NUMEROS 12X1

Código: 4758 Fábrica: STICKERS Unidade: DZ/12 F4



ADESIVO P OS INCRIVEIS 12X1

Código: 25724 Fábrica: STICKERS Unidade: DZ/12 F1 F4



ADESIVO P PALME 12X1

Código: 37229 Fábrica: STICKERS Unidade: DZ/12 F1 F4



ADESIVO P PIU PIU 12X1

Código: 24029 Fábrica: STICKERS Unidade: DZ/12 F1 F4



ADESIVO P POKEMON 12X1

Código: 30531 Fábrica: STICKERS Unidade: DZ/12 F1 F4



ADESIVO P POWER RANGERS 12X1

Código: 22029 Fábrica: STICKERS Unidade: DZ/12 F1 F4



ADESIVO P PRINCESAS 12X1

Código: 18181 Fábrica: STICKERS Unidade: DZ/12 F1 F4



ADESIVO P SAO PAUL 12X1

Código: 37230 Fábrica: STICKERS Unidade: DZ/12 F1 F4



ADESIVO P SCOOBY DOO 12X1

Código: 24851 Fábrica: STICKERS Unidade: DZ/12 F4



ADESIVO P SMILINGUIDO 12X1

Código: 22031 Fábrica: STICKERS Unidade: DZ/12 F4



ADESIVO P SORTIDO 12X1

Código: 3806 Fábrica: STICKERS Unidade: DZ/12 F1 F4



ADESIVO P SPIDERMAN 12X1

Código: 22033 Fábrica: STICKERS Unidade: DZ/12 F4



ADESIVO P SUPER MARIO 12X1

Código: 18180 Fábrica: STICKERS Unidade: DZ/12 F1 F4



ADESIVO P SUPER PODEROSAS 12X1

Código: 18174 Fábrica: STICKERS Unidade: DZ/12 F1 F4



ADESIVO P YU GI OH 12X1

Código: 51113 Fábrica: STICKERS Unidade: DZ/12 F4



ADESIVO PAREDE WALL STICKER P DECORATIVO

Código: 16429 Fábrica: HAI BRASIL Unidade: UN/1 F1 F4



ADESIVO PEQ RELEVO BEN 10 10X1

Código: 46103 Fábrica: STICKERS Unidade: PT/10 F1 F4



ADESIVO PEQ RELEVO BETY BOOP 10X1

Código: 46093 Fábrica: STICKERS Unidade: PT/10 F1 F4



ADESIVO PEQ RELEVO HELLO KITTY 10X1

Código: 46104 Fábrica: STICKERS Unidade: PT/10 F1 F4



ADESIVO PEQ RELEVO JOLIE 10X1

Código: 46101 Fábrica: STICKERS Unidade: PT/10 F1 F4



ADERIVO PEQ RELEVO MICKEY MINNIE 10X1

Código: 47213 Fábrica: STICKERS Unidade: PT/10 F1 F4



AGENDA PERMAN DIARI 15X21CM 406PGS 6102

Código: 42633 Fábrica: CIRCULO Unidade: UN/1 F1 F4



AGENDA PERMAN ESP COR 11X15CM 176FL 2005

Código: 43756 Fábrica: WIN PAPER Unidade: UN/1 F1 F4



AGENDA PERMAN ESP GLI 11X15CM 176FL 2006

Código: 43760 Fábrica: WIN PAPER Unidade: UN/1 F1 F4



AGENDA PERMAN ESP MAR 11X15CM 176FL 2004

Código: 43755 Fábrica: WIN PAPER Unidade: UN/1 F1 F4



AGENDA PERMAN ESP 11X15CM 176FL 2001

Código: 43757 Fábrica: WIN PAPER Unidade: UN/1 F1 F4



AGENDA PERMAN ESP 11X15CM 176FL 2002

Código: 43759 Fábrica: WIN PAPER Unidade: UN/1 F1 F4

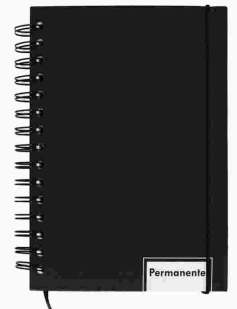

AGENDA PERMAN ESP 11X15CM 320PAG 10046

Código: 42815 Fábrica: WIN PAPER Unidade: UN/1 F1 F4



AGENDA PERMAN ESP 11X15CM 352 PAG 1021

Código: 43777 Fábrica: WIN PAPER Unidade: UN/1 F1 F4



AGENDA PERMAN ESP 15X11CM 320PAG 10002

Código: 43812 Fábrica: WIN PAPER Unidade: UN/1 F1 F4



AGENDA PERMAN ESP 15X21CM 160FL 2007

Código: 43761 Fábrica: WIN PAPER Unidade: UN/1 F1 F4

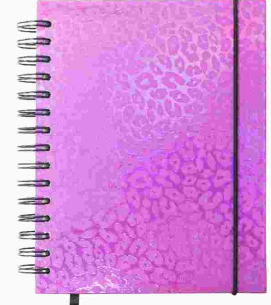

AGENDA PERMAN ESP 15X21CM 160FL 2009

Código: 43762 Fábrica: WIN PAPER Unidade: UN/1 F1 F4



AGENDA PERMAN ESP 15X21CM 320 PAG 52344

Código: 42939 Fábrica: WIN PAPER Unidade: UN/1 F1 F4



AGENDA PERMAN ESP 15X21CM 320PAG 10005

Código: 43763 Fábrica: WIN PAPER Unidade: UN/1 F1 F4



AGENDA PERMAN ESPIR 15X21CM 320PAG 1006

Código: 42816 Fábrica: WINPAPER Unidade: UN/1 F1 F4



AGENDA PERMAN INF 17X11,8CM 64PAG 1487

Código: 42817 Fábrica: WIN PAPER Unidade: UN/1 F1 F4



AGENDA PERMAN SOCIAL 15X21CM 320PAG 1015
 Código: 15905 Fábrica: WINPAPER Unidade: UN/1
 F1 F4



AGENDA PERMANENTE 14X20CM 122FLS
 Código: 41330 Fábrica: ARTS GRAF Unidade: UN/1
 F1 F4



AGENDA PERMANENTE 15X21CM 320 PGS 50010
 Código: 48386 Fábrica: WIN PAPER Unidade: UN/1
 F1 F4



AGENDA PLANNER 10,5X15CM 320PAG 5004
 Código: 43531 Fábrica: WIN PAPER Unidade: UN/1
 F1 F4

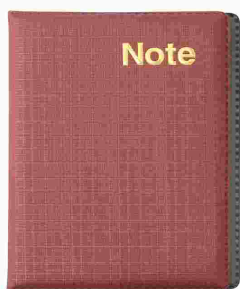

AGENDA TELEFONIC 14X10CM COURO SINT 101
 Código: 43780 Fábrica: WIN PAPER Unidade: UN/1
 F1 F4



AGENDA 2025 EXECUTIVA 15X21CM ESP 320 PG
 Código: 48398 Fábrica: WIN PAPER Unidade: UN/1
 F1 F4

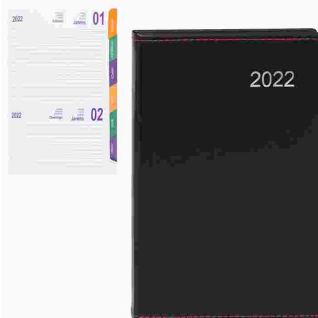

AGENDA 2025 13,2X20CM 328PAG C/HORAS
 Código: 42404 Fábrica: NOVO OLHAR Unidade: UN/1
 F1 F4

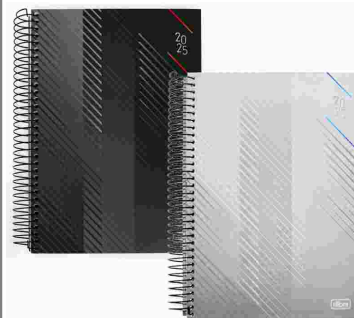

AGENDA 2025 20X27CM ESP 200 FOLHAS
 Código: 49244 Fábrica: TILIBRA Unidade: UN/1
 F1 F4



AGENDA 2026 1307X18,7XM 168 PGS
 Código: 29796 Fábrica: RIO MASTER Unidade: UN/1
 F1 F4



ALFABETO E NUMEROS EVA 5CM AMARELO 40X1
 Código: 38589 Fábrica: BRASILPAPERS Unidade: PT/40
 F1 F4



ALFABETO E NUMEROS EVA 5CM BRANCO 40X1
 Código: 38590 Fábrica: BRASILPAPERS Unidade: PT/40
 F1 F4

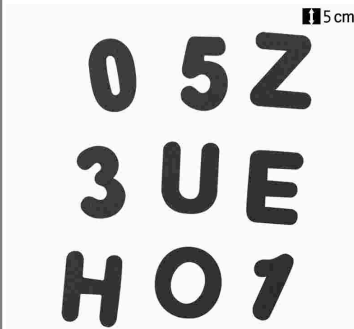

ALFABETO E NUMEROS EVA 5CM PRETO 40X1
 Código: 38595 Fábrica: BRASILPAPERS Unidade: PT/40
 F1 F4

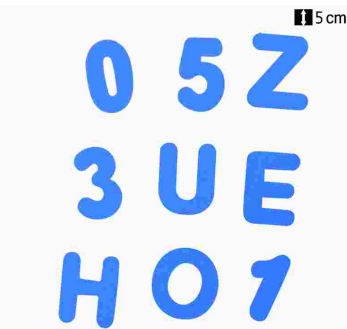

ALFABETO E NUMEROS EVA 5CM ROSA 40X1
 Código: 38593 Fábrica: BRASILPAPERS Unidade: PT/40
 F1 F4



ALFABETO E NUMEROS EVA 5CM SORTIDO 40X1
 Código: 38594 Fábrica: BRASILPAPERS Unidade: PT/40
 F1 F4

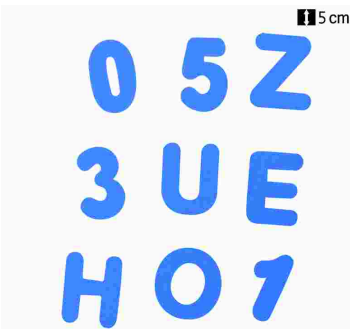

ALFABETO E NUMEROS EVA 5CM VERDE 40X1
 Código: 38592 Fábrica: BRASILPAPERS Unidade: PT/40
 F1 F4

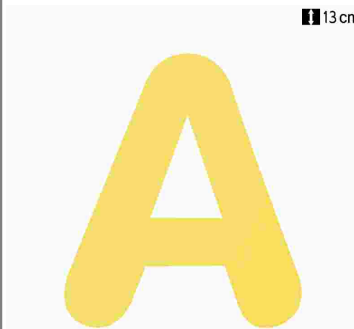

ALFABETO EVA 13CM LETRA A AMARELO 10X1
 Código: 38623 Fábrica: BRASILPAPERS Unidade: PT/10
 F4

13 cm



ALFABETO EVA 13CM LETRA A AZUL 10X1

Código: **38737** Fábrica: **BRASILPAPERS** Unidade: **PT/10 F4**

13 cm



ALFABETO EVA 13CM LETRA A BRANCO 10X1

Código: **38710** Fábrica: **BRASILPAPERS** Unidade: **PT/10 F4**

13 cm



ALFABETO EVA 13CM LETRA A PRETO 10X1

Código: **38633** Fábrica: **BRASILPAPERS** Unidade: **PT/10 F4**

13 cm



ALFABETO EVA 13CM LETRA A ROSA 10X1

Código: **38596** Fábrica: **BRASILPAPERS** Unidade: **PT/10 F4**

13 cm

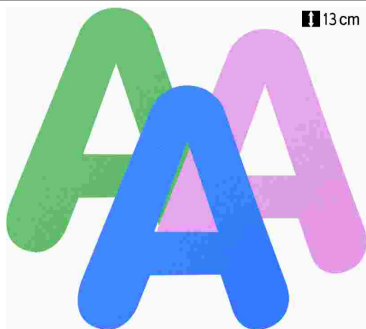

ALFABETO EVA 13CM LETRA A SORTIDO 10X1

Código: **38821** Fábrica: **BRASILPAPERS** Unidade: **PT/10 F4**

13 cm



ALFABETO EVA 13CM LETRA A VERDE 10X1

Código: **38767** Fábrica: **BRASILPAPERS** Unidade: **PT/10 F4**

13 cm



ALFABETO EVA 13CM LETRA A VERMELHO 10X1

Código: **38794** Fábrica: **BRASILPAPERS** Unidade: **PT/10 F4**

13 cm



ALFABETO EVA 13CM LETRA B AMARELO 10X1

Código: **38709** Fábrica: **BRASILPAPERS** Unidade: **PT/10 F4**

13 cm



ALFABETO EVA 13CM LETRA B AZUL 10X1

Código: **38738** Fábrica: **BRASILPAPERS** Unidade: **PT/10 F4**

13 cm



ALFABETO EVA 13CM LETRA B BRANCO 10X1

Código: **38711** Fábrica: **BRASILPAPERS** Unidade: **PT/10 F4**

13 cm



ALFABETO EVA 13CM LETRA B PRETO 10X1

Código: **38634** Fábrica: **BRASILPAPERS** Unidade: **PT/10 F4**

13 cm



ALFABETO EVA 13CM LETRA B VERDE 10X1

Código: **38768** Fábrica: **BRASILPAPERS** Unidade: **PT/10 F4**

13 cm

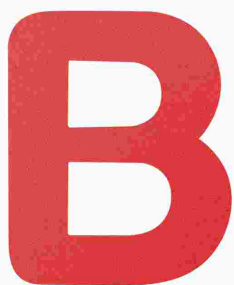

ALFABETO EVA 13CM LETRA B VERMELHO 10X1

Código: **38795** Fábrica: **BRASILPAPERS** Unidade: **PT/10 F4**

13 cm



ALFABETO EVA 13CM LETRA C AMARELO 10X1

Código: **38682** Fábrica: **BRASILPAPERS** Unidade: **PT/10 F4**

13 cm



ALFABETO EVA 13CM LETRA Ç AMARELO 10X1

Código: **38697** Fábrica: **BRASILPAPERS** Unidade: **PT/10 F4**

13 cm



ALFABETO EVA 13CM LETRA C AZUL 10X1

Código: **38739** Fábrica: **BRASILPAPERS** Unidade: **PT/10 F4**

 <p>ALFABETO EVA 13CM LETRA Ç AZUL 10X1 Código: 38766 Fábrica: BRASILPAPERS Unidade: PT/10 F4</p>	 <p>ALFABETO EVA 13CM LETRA C BRANCO 10X1 Código: 38712 Fábrica: BRASILPAPERS Unidade: PT/10 F4</p>	 <p>ALFABETO EVA 13CM LETRA Ç BRANCO 10X1 Código: 38736 Fábrica: BRASILPAPERS Unidade: PT/10 F4</p>	 <p>ALFABETO EVA 13CM LETRA C PRETO 10X1 Código: 38639 Fábrica: BRASILPAPERS Unidade: PT/10 F4</p>
 <p>ALFABETO EVA 13CM LETRA Ç PRETO 10X1 Código: 38702 Fábrica: BRASILPAPERS Unidade: PT/10 F4</p>	 <p>ALFABETO EVA 13CM LETRA C ROSA 10X1 Código: 38598 Fábrica: BRASILPAPERS Unidade: PT/10 F4</p>	 <p>ALFABETO EVA 13CM LETRA Ç ROSA 10X1 Código: 38622 Fábrica: BRASILPAPERS Unidade: PT/10 F4</p>	 <p>ALFABETO EVA 13CM LETRA C VERDE 10X1 Código: 38769 Fábrica: BRASILPAPERS Unidade: PT/10 F4</p>
 <p>ALFABETO EVA 13CM LETRA Ç VERDE 10X1 Código: 38793 Fábrica: BRASILPAPERS Unidade: PT/10 F4</p>	 <p>ALFABETO EVA 13CM LETRA C VERMELHO 10X1 Código: 38796 Fábrica: BRASILPAPERS Unidade: PT/10 F4</p>	 <p>ALFABETO EVA 13CM LETRA D AMARELO 10X1 Código: 38624 Fábrica: BRASILPAPERS Unidade: PT/10 F4</p>	 <p>ALFABETO EVA 13CM LETRA D AZUL 10X1 Código: 38740 Fábrica: BRASILPAPERS Unidade: PT/10 F4</p>
 <p>ALFABETO EVA 13CM LETRA D BRANCO 10X1 Código: 38713 Fábrica: BRASILPAPERS Unidade: PT/10 F4</p>	 <p>ALFABETO EVA 13CM LETRA D PRETO 10X1 Código: 38636 Fábrica: BRASILPAPERS Unidade: PT/10 F4</p>	 <p>ALFABETO EVA 13CM LETRA D ROSA 10X1 Código: 38599 Fábrica: BRASILPAPERS Unidade: PT/10 F4</p>	 <p>ALFABETO EVA 13CM LETRA D VERDE 10X1 Código: 38770 Fábrica: BRASILPAPERS Unidade: PT/10 F4</p>

13 cm



ALFABETO EVA 13CM LETRA D VERMELHO 10X1
 Código: 38797 Fábrica: BRASILPAPERS Unidade: PT/10 F4

13 cm



ALFABETO EVA 13CM LETRA E AMARELO 10X1
 Código: 38683 Fábrica: BRASILPAPERS Unidade: PT/10 F4

13 cm



ALFABETO EVA 13CM LETRA E AZUL 10X1
 Código: 38741 Fábrica: BRASILPAPERS Unidade: PT/10 F4

13 cm



ALFABETO EVA 13CM LETRA E BRANCO 10X1
 Código: 38714 Fábrica: BRASILPAPERS Unidade: PT/10 F4

13 cm



ALFABETO EVA 13CM LETRA E ROSA 10X1
 Código: 38600 Fábrica: BRASILPAPERS Unidade: PT/10 F4

13 cm



ALFABETO EVA 13CM LETRA E SORTIDO 10X1
 Código: 38825 Fábrica: BRASILPAPERS Unidade: PT/10 F4

13 cm



ALFABETO EVA 13CM LETRA E VERDE 10X1
 Código: 38771 Fábrica: BRASILPAPERS Unidade: PT/10 F4

13 cm



ALFABETO EVA 13CM LETRA E VERMELHO 10X1
 Código: 38798 Fábrica: BRASILPAPERS Unidade: PT/10 F4

13 cm



ALFABETO EVA 13CM LETRA F AMARELO 10X1
 Código: 38625 Fábrica: BRASILPAPERS Unidade: PT/10 F4

13 cm



ALFABETO EVA 13CM LETRA F AZUL 10X1
 Código: 38742 Fábrica: BRASILPAPERS Unidade: PT/10 F4

13 cm



ALFABETO EVA 13CM LETRA F BRANCO 10X1
 Código: 38715 Fábrica: BRASILPAPERS Unidade: PT/10 F4

13 cm



ALFABETO EVA 13CM LETRA F PRETO 10X1
 Código: 38640 Fábrica: BRASILPAPERS Unidade: PT/10 F4

13 cm



ALFABETO EVA 13CM LETRA F ROSA 10X1
 Código: 38601 Fábrica: BRASILPAPERS Unidade: PT/10 F4

13 cm



ALFABETO EVA 13CM LETRA F VERDE 10X1
 Código: 38777 Fábrica: BRASILPAPERS Unidade: PT/10 F4

13 cm



ALFABETO EVA 13CM LETRA F VERMELHO 10X1
 Código: 38799 Fábrica: BRASILPAPERS Unidade: PT/10 F4

13 cm



ALFABETO EVA 13CM LETRA G AMARELO 10X1
 Código: 38626 Fábrica: BRASILPAPERS Unidade: PT/10 F4

13 cm



ALFABETO EVA 13CM LETRA G AZUL 10X1

Código: **38743** Fábrica: **BRASILPAPERS** Unidade: **PT/10 F4**

13 cm



ALFABETO EVA 13CM LETRA G BRANCO 10X1

Código: **38716** Fábrica: **BRASILPAPERS** Unidade: **PT/10 F4**

13 cm



ALFABETO EVA 13CM LETRA G PRETO 10X1

Código: **38641** Fábrica: **BRASILPAPERS** Unidade: **PT/10 F4**

13 cm



ALFABETO EVA 13CM LETRA G ROSA 10X1

Código: **38602** Fábrica: **BRASILPAPERS** Unidade: **PT/10 F4**

13 cm



ALFABETO EVA 13CM LETRA G VERDE 10X1

Código: **38772** Fábrica: **BRASILPAPERS** Unidade: **PT/10 F4**

13 cm



ALFABETO EVA 13CM LETRA G VERMELHO 10X1

Código: **38800** Fábrica: **BRASILPAPERS** Unidade: **PT/10 F4**

13 cm

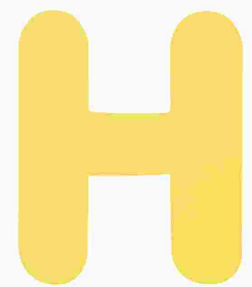

ALFABETO EVA 13CM LETRA H AMARELO 10X1

Código: **38684** Fábrica: **BRASILPAPERS** Unidade: **PT/10 F4**

13 cm



ALFABETO EVA 13CM LETRA H AZUL 10X1

Código: **38744** Fábrica: **BRASILPAPERS** Unidade: **PT/10 F4**

13 cm



ALFABETO EVA 13CM LETRA H BRANCO 10X1

Código: **38717** Fábrica: **BRASILPAPERS** Unidade: **PT/10 F4**

13 cm



ALFABETO EVA 13CM LETRA H PRETO 10X1

Código: **38704** Fábrica: **BRASILPAPERS** Unidade: **PT/10 F4**

13 cm



ALFABETO EVA 13CM LETRA H ROSA 10X1

Código: **38603** Fábrica: **BRASILPAPERS** Unidade: **PT/10 F4**

13 cm



ALFABETO EVA 13CM LETRA H VERDE 10X1

Código: **38773** Fábrica: **BRASILPAPERS** Unidade: **PT/10 F4**

13 cm



ALFABETO EVA 13CM LETRA H VERMELHO 10X1

Código: **38801** Fábrica: **BRASILPAPERS** Unidade: **PT/10 F4**

13 cm



ALFABETO EVA 13CM LETRA I AMARELO 10X1

Código: **38685** Fábrica: **BRASILPAPERS** Unidade: **PT/10 F4**

13 cm



ALFABETO EVA 13CM LETRA I AZUL 10X1

Código: **38745** Fábrica: **BRASILPAPERS** Unidade: **PT/10 F4**

13 cm



ALFABETO EVA 13CM LETRA I BRANCO 10X1

Código: **38718** Fábrica: **BRASILPAPERS** Unidade: **PT/10 F4**



13 cm

ALFABETO EVA 13CM LETRA I PRETO 10X1

Código: **38637** Fábrica: **BRASILPAPERS** Unidade: **PT/10 F4**



13 cm

ALFABETO EVA 13CM LETRA I ROSA 10X1

Código: **38604** Fábrica: **BRASILPAPERS** Unidade: **PT/10 F4**

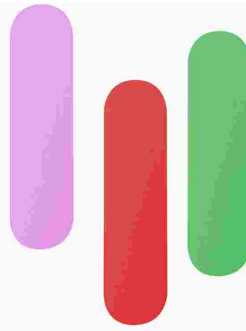

13 cm

ALFABETO EVA 13CM LETRA I SORTIDO 10X1

Código: **38829** Fábrica: **BRASILPAPERS** Unidade: **PT/10 F4**



13 cm

ALFABETO EVA 13CM LETRA I VERDE 10X1

Código: **38774** Fábrica: **BRASILPAPERS** Unidade: **PT/10 F4**



13 cm

ALFABETO EVA 13CM LETRA I VERMELHO 10X1

Código: **38806** Fábrica: **BRASILPAPERS** Unidade: **PT/10 F4**



13 cm

ALFABETO EVA 13CM LETRA J AMARELO 10X1

Código: **38627** Fábrica: **BRASILPAPERS** Unidade: **PT/10 F4**

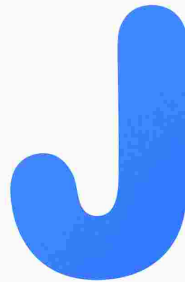

13 cm

ALFABETO EVA 13CM LETRA J AZUL 10X1

Código: **38746** Fábrica: **BRASILPAPERS** Unidade: **PT/10 F4**



13 cm

ALFABETO EVA 13CM LETRA J BRANCO 10X1

Código: **38719** Fábrica: **BRASILPAPERS** Unidade: **PT/10 F4**

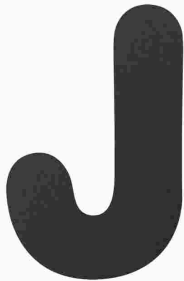

13 cm

ALFABETO EVA 13CM LETRA J PRETO 10X1

Código: **38642** Fábrica: **BRASILPAPERS** Unidade: **PT/10 F4**

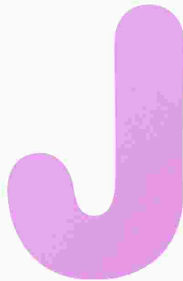

13 cm

ALFABETO EVA 13CM LETRA J ROSA 10X1

Código: **38605** Fábrica: **BRASILPAPERS** Unidade: **PT/10 F4**



13 cm

ALFABETO EVA 13CM LETRA J VERDE 10X1

Código: **38775** Fábrica: **BRASILPAPERS** Unidade: **PT/10 F4**

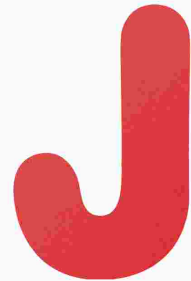

13 cm

ALFABETO EVA 13CM LETRA J VERMELHO 10X1

Código: **38802** Fábrica: **BRASILPAPERS** Unidade: **PT/10 F4**

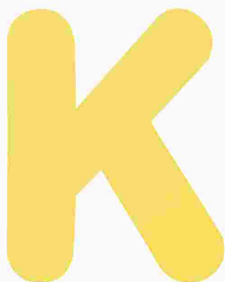

13 cm

ALFABETO EVA 13CM LETRA K AMARELO 10X1

Código: **38686** Fábrica: **BRASILPAPERS** Unidade: **PT/10 F4**

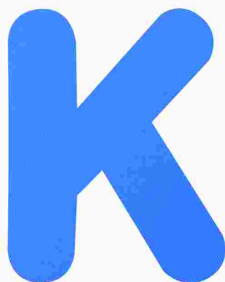

13 cm

ALFABETO EVA 13CM LETRA K AZUL 10X1

Código: **38747** Fábrica: **BRASILPAPERS** Unidade: **PT/10 F4**



13 cm

ALFABETO EVA 13CM LETRA K BRANCO 10X1

Código: **38720** Fábrica: **BRASILPAPERS** Unidade: **PT/10 F4**

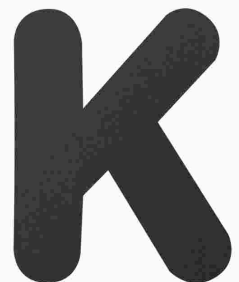

13 cm

ALFABETO EVA 13CM LETRA K PRETO 10X1

Código: **38698** Fábrica: **BRASILPAPERS** Unidade: **PT/10 F4**

13 cm



ALFABETO EVA 13CM LETRA K ROSA 10X1
 Código: 38606 Fábrica: BRASILPAPERS Unidade: PT/10 F4

13 cm



ALFABETO EVA 13CM LETRA K SORTIDO 10X1
 Código: 38831 Fábrica: BRASILPAPERS Unidade: PT/10 F4

13 cm



ALFABETO EVA 13CM LETRA K VERDE 10X1
 Código: 38776 Fábrica: BRASILPAPERS Unidade: PT/10 F4

13 cm



ALFABETO EVA 13CM LETRA K VERMELHO 10X1
 Código: 38803 Fábrica: BRASILPAPERS Unidade: PT/10 F4

13 cm



ALFABETO EVA 13CM LETRA L AMARELO 10X1
 Código: 38628 Fábrica: BRASILPAPERS Unidade: PT/10 F4

13 cm



ALFABETO EVA 13CM LETRA L AZUL 10X1
 Código: 38748 Fábrica: BRASILPAPERS Unidade: PT/10 F4

13 cm



ALFABETO EVA 13CM LETRA L BRANCO 10X1
 Código: 38721 Fábrica: BRASILPAPERS Unidade: PT/10 F4

13 cm



ALFABETO EVA 13CM LETRA L PRETO 10X1
 Código: 38643 Fábrica: BRASILPAPERS Unidade: PT/10 F4

13 cm



ALFABETO EVA 13CM LETRA L ROSA 10X1
 Código: 38607 Fábrica: BRASILPAPERS Unidade: PT/10 F4

13 cm



ALFABETO EVA 13CM LETRA L VERDE 10X1
 Código: 38778 Fábrica: BRASILPAPERS Unidade: PT/10 F4

13 cm



ALFABETO EVA 13CM LETRA L VERMELHO 10X1
 Código: 38804 Fábrica: BRASILPAPERS Unidade: PT/10 F4

13 cm



ALFABETO EVA 13CM LETRA M AMARELO 10X1
 Código: 38629 Fábrica: BRASILPAPERS Unidade: PT/10 F4

13 cm



ALFABETO EVA 13CM LETRA M AZUL 10X1
 Código: 38749 Fábrica: BRASILPAPERS Unidade: PT/10 F4

13 cm



ALFABETO EVA 13CM LETRA M BRANCO 10X1
 Código: 38722 Fábrica: BRASILPAPERS Unidade: PT/10 F4

13 cm



ALFABETO EVA 13CM LETRA M PRETO 10X1
 Código: 38638 Fábrica: BRASILPAPERS Unidade: PT/10 F4

13 cm



ALFABETO EVA 13CM LETRA M ROSA 10X1
 Código: 38608 Fábrica: BRASILPAPERS Unidade: PT/10 F4

13 cm



ALFABETO EVA 13CM LETRA M VERDE 10X1
 Código: 38779 Fábrica: BRASILPAPERS Unidade: PT/10 F4

13 cm



ALFABETO EVA 13CM LETRA M VERMELHO 10X1
 Código: 38805 Fábrica: BRASILPAPERS Unidade: PT/10 F4

13 cm



ALFABETO EVA 13CM LETRA N AMARELO 10X1
 Código: 38687 Fábrica: BRASILPAPERS Unidade: PT/10 F4

13 cm



ALFABETO EVA 13CM LETRA N AZUL 10X1
 Código: 38750 Fábrica: BRASILPAPERS Unidade: PT/10 F4

13 cm



ALFABETO EVA 13CM LETRA N BRANCO 10X1
 Código: 38723 Fábrica: BRASILPAPERS Unidade: PT/10 F4

13 cm



ALFABETO EVA 13CM LETRA N PRETO 10X1
 Código: 38699 Fábrica: BRASILPAPERS Unidade: PT/10 F4

13 cm



ALFABETO EVA 13CM LETRA N ROSA 10X1
 Código: 38609 Fábrica: BRASILPAPERS Unidade: PT/10 F4

13 cm



ALFABETO EVA 13CM LETRA N SORTIDO 10X1
 Código: 38834 Fábrica: BRASILPAPERS Unidade: PT/10 F4

13 cm



ALFABETO EVA 13CM LETRA N VERDE 10X1
 Código: 38780 Fábrica: BRASILPAPERS Unidade: PT/10 F4

13 cm



ALFABETO EVA 13CM LETRA N VERMELHO 10X1
 Código: 38807 Fábrica: BRASILPAPERS Unidade: PT/10 F4

13 cm



ALFABETO EVA 13CM LETRA O AMARELO 10X1
 Código: 38688 Fábrica: BRASILPAPERS Unidade: PT/10 F4

13 cm



ALFABETO EVA 13CM LETRA O AZUL 10X1
 Código: 38751 Fábrica: BRASILPAPERS Unidade: PT/10 F4

13 cm



ALFABETO EVA 13CM LETRA O BRANCO 10X1
 Código: 38724 Fábrica: BRASILPAPERS Unidade: PT/10 F4

13 cm



ALFABETO EVA 13CM LETRA O PRETO 10X1
 Código: 38644 Fábrica: BRASILPAPERS Unidade: PT/10 F4

13 cm











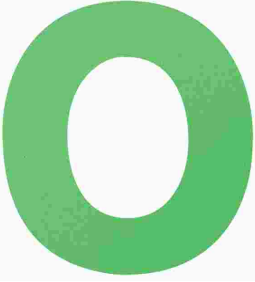
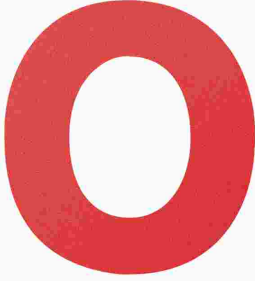



ALFABETO EVA 13CM LETRA O ROSA 10X1
 Código: 38610 Fábrica: BRASILPAPERS Unidade: PT/10 F4

13 cm

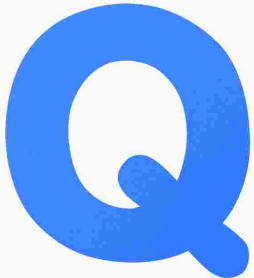

ALFABETO EVA 13CM LETRA O SORTIDO 10X1
 Código: 38835 Fábrica: BRASILPAPERS Unidade: PT/10 F4

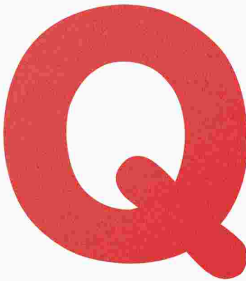
<p style="text-align: right;">13 cm</p>  <p>ALFABETO EVA 13CM LETRA O VERDE 10X1 Código: 38781 Fábrica: BRASILPAPERS Unidade: PT/10 F4</p>	<p style="text-align: right;">13 cm</p>  <p>ALFABETO EVA 13CM LETRA O VERMELHO 10X1 Código: 38808 Fábrica: BRASILPAPERS Unidade: PT/10 F4</p>	<p style="text-align: right;">13 cm</p>  <p>ALFABETO EVA 13CM LETRA P AMARELO 10X1 Código: 38630 Fábrica: BRASILPAPERS Unidade: PT/10 F4</p>	<p style="text-align: right;">13 cm</p>  <p>ALFABETO EVA 13CM LETRA P AZUL 10X1 Código: 38752 Fábrica: BRASILPAPERS Unidade: PT/10 F4</p>
<p style="text-align: right;">13 cm</p>  <p>ALFABETO EVA 13CM LETRA P BRANCO 10X1 Código: 38725 Fábrica: BRASILPAPERS Unidade: PT/10 F4</p>	<p style="text-align: right;">13 cm</p>  <p>ALFABETO EVA 13CM LETRA P PRETO 10X1 Código: 38645 Fábrica: BRASILPAPERS Unidade: PT/10 F4</p>	<p style="text-align: right;">13 cm</p>  <p>ALFABETO EVA 13CM LETRA P ROSA 10X1 Código: 38611 Fábrica: BRASILPAPERS Unidade: PT/10 F4</p>	<p style="text-align: right;">13 cm</p>  <p>ALFABETO EVA 13CM LETRA P VERDE 10X1 Código: 38782 Fábrica: BRASILPAPERS Unidade: PT/10 F4</p>
<p style="text-align: right;">13 cm</p>  <p>ALFABETO EVA 13CM LETRA P VERMELHO 10X1 Código: 38809 Fábrica: BRASILPAPERS Unidade: PT/10 F4</p>	<p style="text-align: right;">13 cm</p>  <p>ALFABETO EVA 13CM LETRA Q AMARELO 10X1 Código: 38689 Fábrica: BRASILPAPERS Unidade: PT/10 F4</p>	<p style="text-align: right;">13 cm</p>  <p>ALFABETO EVA 13CM LETRA Q AZUL 10X1 Código: 38753 Fábrica: BRASILPAPERS Unidade: PT/10 F4</p>	<p style="text-align: right;">13 cm</p>  <p>ALFABETO EVA 13CM LETRA Q BRANCO 10X1 Código: 38726 Fábrica: BRASILPAPERS Unidade: PT/10 F4</p>
<p style="text-align: right;">13 cm</p>  <p>ALFABETO EVA 13CM LETRA Q PRETO 10X1 Código: 38706 Fábrica: BRASILPAPERS Unidade: PT/10 F4</p>	<p style="text-align: right;">13 cm</p>  <p>ALFABETO EVA 13CM LETRA Q ROSA 10X1 Código: 38612 Fábrica: BRASILPAPERS Unidade: PT/10 F4</p>	<p style="text-align: right;">13 cm</p>  <p>ALFABETO EVA 13CM LETRA Q VERDE 10X1 Código: 38783 Fábrica: BRASILPAPERS Unidade: PT/10 F4</p>	<p style="text-align: right;">13 cm</p>  <p>ALFABETO EVA 13CM LETRA Q VERMELHO 10X1 Código: 38810 Fábrica: BRASILPAPERS Unidade: PT/10 F4</p>

 <p>ALFABETO EVA 13CM LETRA R AMARELO 10X1 Código: 38631 Fábrica: BRASILPAPERS Unidade: PT/10 F4</p>	 <p>ALFABETO EVA 13CM LETRA R AZUL 10X1 Código: 38754 Fábrica: BRASILPAPERS Unidade: PT/10 F4</p>	 <p>ALFABETO EVA 13CM LETRA R BRANCO 10X1 Código: 38727 Fábrica: BRASILPAPERS Unidade: PT/10 F4</p>	 <p>ALFABETO EVA 13CM LETRA R PRETO 10X1 Código: 38646 Fábrica: BRASILPAPERS Unidade: PT/10 F4</p>
 <p>ALFABETO EVA 13CM LETRA R ROSA 10X1 Código: 38613 Fábrica: BRASILPAPERS Unidade: PT/10 F4</p>	 <p>ALFABETO EVA 13CM LETRA R VERDE 10X1 Código: 38784 Fábrica: BRASILPAPERS Unidade: PT/10 F4</p>	 <p>ALFABETO EVA 13CM LETRA R VERMELHO 10X1 Código: 38811 Fábrica: BRASILPAPERS Unidade: PT/10 F4</p>	 <p>ALFABETO EVA 13CM LETRA S AMARELO 10X1 Código: 38632 Fábrica: BRASILPAPERS Unidade: PT/10 F4</p>
 <p>ALFABETO EVA 13CM LETRA S AZUL 10X1 Código: 38758 Fábrica: BRASILPAPERS Unidade: PT/10 F4</p>	 <p>ALFABETO EVA 13CM LETRA S BRANCO 10X1 Código: 38728 Fábrica: BRASILPAPERS Unidade: PT/10 F4</p>	 <p>ALFABETO EVA 13CM LETRA S PRETO 10X1 Código: 38647 Fábrica: BRASILPAPERS Unidade: PT/10 F4</p>	 <p>ALFABETO EVA 13CM LETRA S ROSA 10X1 Código: 38614 Fábrica: BRASILPAPERS Unidade: PT/10 F4</p>
 <p>ALFABETO EVA 13CM LETRA S VERDE 10X1 Código: 38785 Fábrica: BRASILPAPERS Unidade: PT/10 F4</p>	 <p>ALFABETO EVA 13CM LETRA S VERMELHO 10X1 Código: 38812 Fábrica: BRASILPAPERS Unidade: PT/10 F4</p>	 <p>ALFABETO EVA 13CM LETRA T AMARELO 10X1 Código: 38690 Fábrica: BRASILPAPERS Unidade: PT/10 F4</p>	 <p>ALFABETO EVA 13CM LETRA T AZUL 10X1 Código: 38759 Fábrica: BRASILPAPERS Unidade: PT/10 F4</p>

 13 cm

ALFABETO EVA 13CM LETRA T BRANCO 10X1
 Código: 38729 Fábrica: BRASILPAPERS Unidade: PT/10 F4

 13 cm

ALFABETO EVA 13CM LETRA T PRETO 10X1
 Código: 38703 Fábrica: BRASILPAPERS Unidade: PT/10 F4

 13 cm

ALFABETO EVA 13CM LETRA T ROSA 10X1
 Código: 38615 Fábrica: BRASILPAPERS Unidade: PT/10 F4

 13 cm

ALFABETO EVA 13CM LETRA T SORTIDO 10X1
 Código: 38840 Fábrica: BRASILPAPERS Unidade: PT/10 F4

 13 cm

ALFABETO EVA 13CM LETRA T VERDE 10X1
 Código: 38786 Fábrica: BRASILPAPERS Unidade: PT/10 F4

 13 cm

ALFABETO EVA 13CM LETRA T VERMELHO 10X1
 Código: 38813 Fábrica: BRASILPAPERS Unidade: PT/10 F4

 13 cm

ALFABETO EVA 13CM LETRA U AMARELO 10X1
 Código: 38691 Fábrica: BRASILPAPERS Unidade: PT/10 F4

 13 cm

ALFABETO EVA 13CM LETRA U AZUL 10X1
 Código: 38760 Fábrica: BRASILPAPERS Unidade: PT/10 F4

 13 cm

ALFABETO EVA 13CM LETRA U BRANCO 10X1
 Código: 38730 Fábrica: BRASILPAPERS Unidade: PT/10 F4

 13 cm

ALFABETO EVA 13CM LETRA U PRETO 10X1
 Código: 38648 Fábrica: BRASILPAPERS Unidade: PT/10 F4

 13 cm

ALFABETO EVA 13CM LETRA U ROSA 10X1
 Código: 38616 Fábrica: BRASILPAPERS Unidade: PT/10 F4

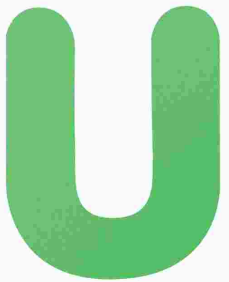
 13 cm

ALFABETO EVA 13CM LETRA U VERDE 10X1
 Código: 38787 Fábrica: BRASILPAPERS Unidade: PT/10 F4

 13 cm

ALFABETO EVA 13CM LETRA U VERMELHO 10X1
 Código: 38814 Fábrica: BRASILPAPERS Unidade: PT/10 F4

 13 cm

ALFABETO EVA 13CM LETRA V AMARELO 10X1
 Código: 38692 Fábrica: BRASILPAPERS Unidade: PT/10 F4

 13 cm

ALFABETO EVA 13CM LETRA V AZUL 10X1
 Código: 38761 Fábrica: BRASILPAPERS Unidade: PT/10 F4

 13 cm

ALFABETO EVA 13CM LETRA V BRANCO 10X1
 Código: 38731 Fábrica: BRASILPAPERS Unidade: PT/10 F4

 13 cm

ALFABETO EVA 13CM LETRA V PRETO 10X1
 Código: 38707 Fábrica: BRASILPAPERS Unidade: PT/10 F4

 13 cm

ALFABETO EVA 13CM LETRA V VERDE 10X1
 Código: 38788 Fábrica: BRASILPAPERS Unidade: PT/10 F4

 13 cm

ALFABETO EVA 13CM LETRA V VERMELHO 10X1
 Código: 38815 Fábrica: BRASILPAPERS Unidade: PT/10 F4

 13 cm

ALFABETO EVA 13CM LETRA W AMARELO 10X1
 Código: 38693 Fábrica: BRASILPAPERS Unidade: PT/10 F4

 13 cm

ALFABETO EVA 13CM LETRA W AZUL 10X1
 Código: 38762 Fábrica: BRASILPAPERS Unidade: PT/10 F4

 13 cm

ALFABETO EVA 13CM LETRA W BRANCO 10X1
 Código: 38732 Fábrica: BRASILPAPERS Unidade: PT/10 F4

 13 cm

ALFABETO EVA 13CM LETRA W PRETO 10X1
 Código: 38708 Fábrica: BRASILPAPERS Unidade: PT/10 F4

 13 cm

ALFABETO EVA 13CM LETRA W ROSA 10X1
 Código: 38618 Fábrica: BRASILPAPERS Unidade: PT/10 F4

 13 cm

ALFABETO EVA 13CM LETRA W VERDE 10X1
 Código: 38792 Fábrica: BRASILPAPERS Unidade: PT/10 F4

 13 cm

ALFABETO EVA 13CM LETRA X AMARELO 10X1
 Código: 38694 Fábrica: BRASILPAPERS Unidade: PT/10 F4

 13 cm

ALFABETO EVA 13CM LETRA X AZUL 10X1
 Código: 38763 Fábrica: BRASILPAPERS Unidade: PT/10 F4

 13 cm

ALFABETO EVA 13CM LETRA X BRANCO 10X1
 Código: 38733 Fábrica: BRASILPAPERS Unidade: PT/10 F4

 13 cm

ALFABETO EVA 13CM LETRA N PRETO 10X1
 Código: 38700 Fábrica: BRASILPAPERS Unidade: PT/10 F4

 13 cm















ALFABETO EVA 13CM LETRA X ROSA 10X1
 Código: 38619 Fábrica: BRASILPAPERS Unidade: PT/10 F4

 13 cm

ALFABETO EVA 13CM LETRA X VERDE 10X1
 Código: 38789 Fábrica: BRASILPAPERS Unidade: PT/10 F4

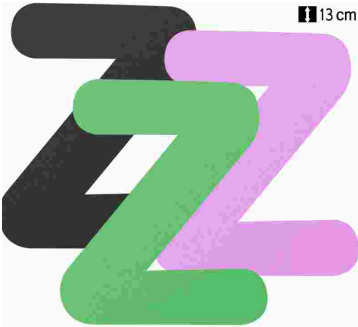
 13 cm

ALFABETO EVA 13CM LETRA X VERMELHO 10X1
 Código: 38816 Fábrica: BRASILPAPERS Unidade: PT/10 F4

 <p>ALFABETO EVA 13CM LETRA Y AMARELO 10X1 Código: 38695 Fábrica: BRASILPAPERS Unidade: PT/10 F4</p>	 <p>ALFABETO EVA 13CM LETRA Y AZUL 10X1 Código: 38764 Fábrica: BRASILPAPERS Unidade: PT/10 F4</p>	 <p>ALFABETO EVA 13CM LETRA Y BRANCO 10X1 Código: 38734 Fábrica: BRASILPAPERS Unidade: PT/10 F4</p>	 <p>ALFABETO EVA 13CM LETRA Y PRETO 10X1 Código: 38705 Fábrica: BRASILPAPERS Unidade: PT/10 F4</p>
 <p>ALFABETO EVA 13CM LETRA Y VERDE 10X1 Código: 38790 Fábrica: BRASILPAPERS Unidade: PT/10 F4</p>	 <p>ALFABETO EVA 13CM LETRA Y VERMELHO 10X1 Código: 38819 Fábrica: BRASILPAPERS Unidade: PT/10 F4</p>	 <p>ALFABETO EVA 13CM LETRA Z AMARELO 10X1 Código: 38696 Fábrica: BRASILPAPERS Unidade: PT/10 F4</p>	 <p>ALFABETO EVA 13CM LETRA Z AZUL 10X1 Código: 38765 Fábrica: BRASILPAPERS Unidade: PT/10 F4</p>
 <p>ALFABETO EVA 13CM LETRA Z BRANCO 10X1 Código: 38735 Fábrica: BRASILPAPERS Unidade: PT/10 F4</p>	 <p>ALFABETO EVA 13CM LETRA Z PRETO 10X1 Código: 38701 Fábrica: BRASILPAPERS Unidade: PT/10 F4</p>	 <p>ALFABETO EVA 13CM LETRA Z ROSA 10X1 Código: 38621 Fábrica: BRASILPAPERS Unidade: PT/10 F4</p>	 <p>ALFABETO EVA 13CM LETRA Z SORTIDO 10X1 Código: 38846 Fábrica: BRASILPAPERS Unidade: PT/10 F4</p>
 <p>ALFABETO EVA 13CM LETRA Z VERDE 10X1 Código: 38791 Fábrica: BRASILPAPERS Unidade: PT/10 F4</p>	 <p>ALFABETO EVA 13CM LETRA Z VERMELHO 10X1 Código: 38817 Fábrica: BRASILPAPERS Unidade: PT/10 F4</p>	 <p>ALMOFADA CARIMBO N3 S/TINTA 105X64MM 168 Código: 45069 Fábrica: CARBRINK Unidade: UN/1 F1 F4</p>	 <p>ALMOFADA P/CARIMBO N2 PRETA ENTINTADA Código: 41963 Fábrica: CARBRINK Unidade: UN/1 F1 F4</p>



ALMOFADA P/CARIMBO N3 AZUL ENTINTADA

Código: 10460 Fábrica: CARBRINK Unidade: UN/1
F1 F4



ALMOFADA P/CARIMBO N3 AZUL TPA METAL 772

Código: 23964 Fábrica: MASTERPRINT Unidade: UN/1
F1 F4



ALMOFADA P/CARIMBO N3 PRETA ENTINTADA

Código: 15529 Fábrica: CARBRINK Unidade: UN/1
F1 F4



ALMOFADA P/CARIMBO N3 PRETO TPA METAL 773

Código: 41732 Fábrica: MASTERPRINT Unidade: UN/1
F1 F4



ALMOFADA P/CARIMBO N3 VERM ENTINTADA

Código: 41801 Fábrica: CARBRINK Unidade: UN/1
F1 F4



ALMOFADA P/CARIMBO N3 VERM TPA METAL 774

Código: 41733 Fábrica: MASTERPRINT Unidade: UN/1
F1 F4



ALMOFADA P/CARIMBO N3 VERMELHA ENTINTADA

Código: 6792 Fábrica: RADEX Unidade: UN/1
F1 F4



ALMOFADA P/CARIMBO N4 AZUL ENTINTADA 173

Código: 42250 Fábrica: CARBRINK Unidade: UN/1
F1 F4



ALMOFADA P/CARIMBO N4 PRETA ENTINTADA 74

Código: 41964 Fábrica: CARBRINK Unidade: UN/1
F1 F4



ANILINA ALCOOL 4GRS SORTIDO 12X1

Código: 45520 Fábrica: GLIART Unidade: DZ/12
F1 F4



APAGADOR P/QUADRO BCO ANATOMICO EVA 331

Código: 45632 Fábrica: CORTIARTE Unidade: UN/1
F1 F4



APAGADOR P/QUADRO BRANCO C/DEP P/MAR 469

Código: 41804 Fábrica: CARBRINK Unidade: UN/1
F1 F4



APAGADOR P/QUADRO BRANCO C/IMA 3100

Código: 44127 Fábrica: MASTERPRINT Unidade: UN/1
F1 F4



APAGADOR P/QUADRO BRANCO C/2 MARCADORES

Código: 48222 Fábrica: ROKE Unidade: KI/1
F1 F4



APAGADOR P/QUADRO BRANCO C/4 MARCADORES

Código: 46413 Fábrica: KAZ Unidade: KI/1
F1 F4



APAGADOR P/QUADRO BRANCO FLIP TOP 102

Código: 43193 Fábrica: BRW Unidade: UN/1
F1 F4



APAGADOR P/QUADRO BRANCO MAGNETICO AZUL
 Código: 11221 Fábrica: BRW Unidade: UN/1
 F1 F4



APAGADOR P/QUADRO BRANCO 468/470
 Código: 41805 Fábrica: CARBRINK Unidade: UN/1
 F1 F4



APAGADOR P/QUADRO C/SUPOORTE VERDE 8189
 Código: 11222 Fábrica: SOUZA/STALO Unidade: UN/1
 F1 F4

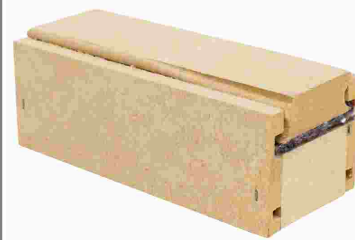

APAGADOR P/QUADRO MAD C/DEPOSITO 324
 Código: 45631 Fábrica: CORTIARTE Unidade: UN/1
 F1 F4



APAGADOR P/QUADRO MADEIRA 320
 Código: 6835 Fábrica: CORTIARTE Unidade: UN/1
 F1 F4



APONTADOR C/DEP BLOCO 6CM 4531 24X1
 Código: 9579 Fábrica: LEO&LEO Unidade: CX/24
 F1 F4



APONTADOR C/DEP C/BORRACHA HONGSI
 Código: 40910 Fábrica: TRIS Unidade: UN/1
 F1 F4



APONTADOR C/DEP CESTINHA DUPLO 4568 12X1
 Código: 40914 Fábrica: LEO&LEO Unidade: CX/12
 F1 F4



APONTADOR C/DEP CILINDR METAL BETTY 12X1
 Código: 38550 Fábrica: SUMMIT Unidade: CX/12
 F4



APONTADOR C/DEP CORCAO HANNAH MONT 24X1
 Código: 38549 Fábrica: TRIS Unidade: CX/24
 F1 F4



APONTADOR C/DEP DUPLO LOL SURPRISE 3060
 Código: 41614 Fábrica: LOL Unidade: UN/1
 F4



APONTADOR C/DEP OVAL DUPLO 12X1
 Código: 49268 Fábrica: COLORARE Unidade: CX/12
 F1 F4



APONTADOR C/DEP OVAL DUPLO 4534 12X1
 Código: 41613 Fábrica: LEO&LEO Unidade: CX/12
 F1 F4



APONTADOR C/DEP OVAL DUPLO 4752 SOLAPA
 Código: 47390 Fábrica: LEO&LEO Unidade: UN/1
 F1 F4



APONTADOR C/DEP OVAL DUPLO 903891 12X1
 Código: 49942 Fábrica: BAZZE Unidade: CX/12
 F1 F4



APONTADOR C/DEP OVAL PLAST 2005 12X1
 Código: 21472 Fábrica: BRW Unidade: CX/12
 F1 F4



APONTADOR C/DEP OVAL 5CM 2003 24X1

Código: 47014 Fábrica: BRW Unidade: CX/24 F1 F4



APONTADOR C/DEP PLAST QUAD 1207 48X1

Código: 46751 Fábrica: MASTERPRINT Unidade: CX/48 F1 F4



APONTADOR C/DEP PLAST RET 1208 24X1

Código: 49274 Fábrica: MASTERPRINT Unidade: CX/24 F1 F4



APONTADOR C/DEP RET BLOCO 4CM 040 24X1

Código: 49265 Fábrica: COLORARE Unidade: CX/24 F1 F4



APONTADOR C/DEP RETANG HIGH SCHOOL 24X1

Código: 21140 Fábrica: TRIS Unidade: CX/24 F1 F4



APONTADOR ELETRIC AUTOMAT PILHA AA 245

Código: 46741 Fábrica: KAZ Unidade: UN/1 F1 F4



APONTADOR METAL RET CLASSICO 4207 24X1

Código: 44243 Fábrica: LEO&LEO Unidade: CX/24 F1 F4



APONTADOR METAL RET SIMPLES 4209 24X1

Código: 6557 Fábrica: LEO&LEO Unidade: CX/24 F1 F4



APONTADOR METAL RET 20026 24X1

Código: 50684 Fábrica: WINPAPER Unidade: CX/24 F1 F4



APONTADOR METAL 5579 20X1

Código: 14682 Fábrica: GOLLER Unidade: CX/20 F1 F4



APONTADOR PLAST C/DEP MINI 4540 24X1

Código: 42143 Fábrica: LEO&LEO Unidade: CX/24 F1 F4



APONTADOR PLAST MANIVELA MANUAL 20207

Código: 44750 Fábrica: WIN PAPER Unidade: UN/1 F1 F4



APONTADOR RED SIMPLES 0322 24X1

Código: 42594 Fábrica: LEO&LEO Unidade: CX/24 F1 F4



APONTADOR RET SIMPLES 10400 24X1

Código: 29998 Fábrica: GATTE Unidade: CX/24 F1 F4



APONTADOR RET SIMPLES 4529 24X1

Código: 40918 Fábrica: LEO&LEO Unidade: CX/24 F1 F4



APONTADOR RETANGULAR PLAST 1203 100X1

Código: 21138 Fábrica: BRW Unidade: PT/100 F1 F4

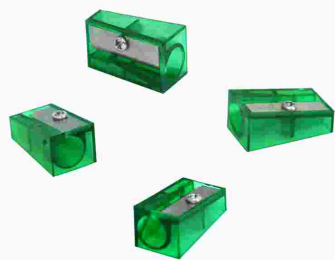

APONTADOR TRIANGULO RETANG PLAST 100X1
 Código: 37997 Fábrica: FELE Unidade: PT/100
 F1 F4



AREIA MAGICA CORES 200 GRS MASSA UN
 Código: 43024 Fábrica: ACRILEX Unidade: UN/1
 F1 F4



AREIA MAGICA 550 GRS 101 VERDE
 Código: 44847 Fábrica: ACRILEX Unidade: UN/1
 F1 F4



AREIA MAGICA 550 GRS 105 LARANJA
 Código: 44848 Fábrica: ACRILEX Unidade: UN/1
 F1 F4



AREIA MAGICA 550 GRS 106 ROXO
 Código: 44850 Fábrica: ACRILEX Unidade: UN/1
 F1 F4



AREIA MAGICA 550 GRS 107 ROSA MARAVILHA
 Código: 44849 Fábrica: ACRILEX Unidade: UN/1
 F1 F4



AREIA MAGICA 550 GRS 109 AZUL
 Código: 44846 Fábrica: ACRILEX Unidade: UN/1
 F1 F4



AVENTAL INF C/BOLSO ARCO IRI 49,5X39,5CM
 Código: 41704 Fábrica: LEO&LEO Unidade: UN/1
 F1 F4



AVENTAL INF C/BOLSO CRISTAL 49,5X39,5CM
 Código: 41693 Fábrica: LEO&LEO Unidade: UN/1
 F1 F4



AVENTAL INF C/BOLSO DINO 49,5X39,5CM
 Código: 46356 Fábrica: LEO&LEO Unidade: UN/1
 F1 F4



AVENTAL INF C/BOLSO FUND MAR 49,5X39,5CM
 Código: 46355 Fábrica: LEO&LEO Unidade: UN/1
 F1 F4



AVENTAL INF C/BOLSO JOY 48X39,5CM 79644
 Código: 46354 Fábrica: LEO&LEO Unidade: UN/1
 F1 F4



AVENTAL INF ESC AZUL 40X45CM 10214AZ
 Código: 46107 Fábrica: ACP Unidade: UN/1
 F1 F4



AVENTAL INF ESC CRISTAL 40X45CM 10214CR
 Código: 46105 Fábrica: ACP Unidade: UN/1
 F1 F4



AVENTAL INF ESC ROSA 41X46CM 10214RS
 Código: 46106 Fábrica: ACP Unidade: UN/1
 F1 F4



AVENTAL INF NYLON PP 34X47CM EST/LISO 20
 Código: 49682 Fábrica: MARIO BRITO Unidade: UN/1
 F1 F4



BASE ACRILICA ARTESANATO 120 ML 3412
 Código: 44815 Fábrica: ACRILEX Unidade: UN/1
 F1 F4



BASE ACRILICA ARTESANATO 250 ML 3425
 Código: 44816 Fábrica: ACRILEX Unidade: UN/1
 F1 F4

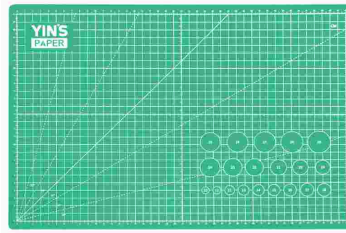

BASE DE CORTE A3 DUPLA FACE 7856
 Código: 48346 Fábrica: YIN'S PAPER Unidade: PT/20
 F1 F4



BETUME 100 ML 15810
 Código: 44818 Fábrica: ACRILEX Unidade: UN/1
 F1 F4

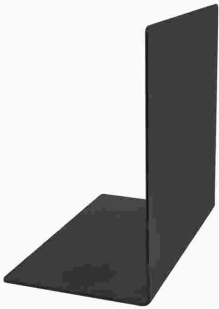

BIBLIO CANTO L METAL 2X1
 Código: 49526 Fábrica: CARBRINK Unidade: PT/1
 F1 F4

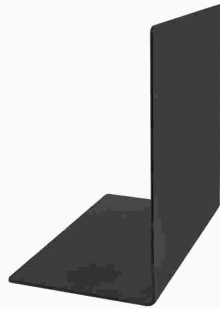

BIBLIO CANTO L 684 2X1
 Código: 45502 Fábrica: ACRINIL Unidade: PT/2
 F1 F4



BLOCO ANOT C/CANETA 13X18,5CM 80FLS 2155
 Código: 43779 Fábrica: WIN PAPER Unidade: UN/1
 F1 F4



BLOCO AQUARELA A3 300GR 12 FLS FILIART
 Código: 50267 Fábrica: USAPEL Unidade: PT/1
 F1 F4



BLOCO BINGO PQ 100 CARTELAS 1 A 75 6X1
 Código: 12544 Fábrica: PARRKE Unidade: PT/6
 F1 F4



BLOCO CD ANOT 120F 7,3X7,4CM 1117
 Código: 44799 Fábrica: WIN PAPER Unidade: UN/1
 F1 F4



BLOCO P/ANOTACOES S/P 100X138SERR 50FLS
 Código: 42696 Fábrica: PARRKE Unidade: UN/1
 F1 F4



BLOCO PAPEL A4 MILIMETRADO 50FLS 10X1
 Código: 17969 Fábrica: PARRKE Unidade: PT/10
 F1 F4



BLOCO PAPEL QUADRICULADO A4 50FLS 10X1
 Código: 14424 Fábrica: PARRKE Unidade: PT/10
 F1 F4



BLOCO PAUTADO GDE 1/9 S/COPIA 50FL 10X1
 Código: 21417 Fábrica: PARRKE Unidade: PT/10
 F1 F4



BLOCO PAUTADO PEQ 1/18 S/COPIA 50FL 20X1
 Código: 21570 Fábrica: PARRKE Unidade: PT/20
 F1 F4



BLOCO RASCUNHO 7X10CM 50FLS 40X1
 Código: 17971 Fábrica: PARRKE Unidade: PT/40
 F1 F4



BLOCO RASCUNHO 10X15CM 50FLS 20X1
 Código: 17970 Fábrica: PARRKE Unidade: PT/20
 F1 F4



BLOCO RECADOS 76X76MM 500X1
 Código: 46250 Fábrica: IMPORIENTE Unidade: CX/500
 F1 F4

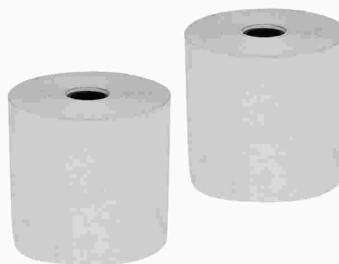

BOBINA CALCULADORA 57MM 22MTS 2VIAS 30X1
 Código: 29191 Fábrica: PRIMUS Unidade: CX/30
 F1 F4

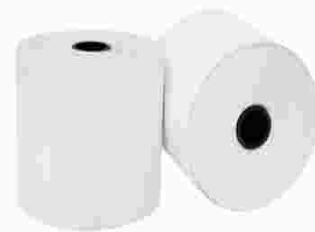

BOBINA CALCULADORA 57MM 30MTS 1VIA 30X1
 Código: 21580 Fábrica: PRIMUS Unidade: CX/30
 F1 F4



BOBINA FAX 30 MTS
 Código: 26060 Fábrica: PRIMUS Unidade: RL/1
 F1 F4



BOBINA TERMICA 57MMX30M 1VIA 30X1
 Código: 27782 Fábrica: PRIMUS Unidade: CX/30
 F1 F4



BOBINA TERMICA 57MMX300M 1VIA BRANCA
 Código: 29790 Fábrica: PRIMUS Unidade: UN/1
 F1 F4



BOBINA TERMICA 57MMX40M 1VIA 30X1
 Código: 50249 Fábrica: PRIMUS Unidade: CX/30
 F1 F4

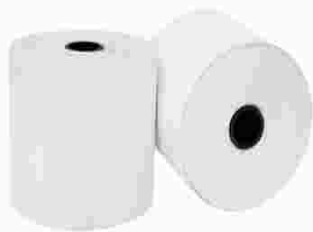

BOBINA TERMICA 79MM UN
 Código: 42947 Fábrica: PRIMUS Unidade: UN/1
 F1 F4



BOBINA TERMICA 79MMX30M 1VIA 30X1
 Código: 27758 Fábrica: CLEAR/PRIMUS Unidade: CX/30
 F1 F4

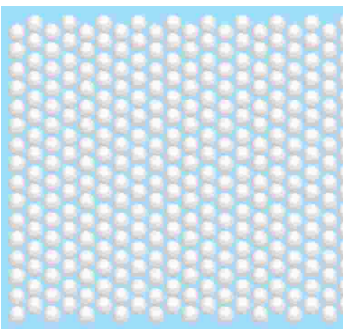

BOLA ISOPOR MOLD EPS DIAM 8MM 200X1
 Código: 48276 Fábrica: ISOMAX Unidade: PT/200
 F1 F4

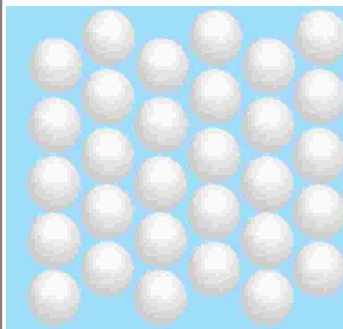

BOLA ISOPOR MOLD EPS DIAM 15MM 200X1
 Código: 48275 Fábrica: ISOMAX Unidade: PT/200
 F1 F4

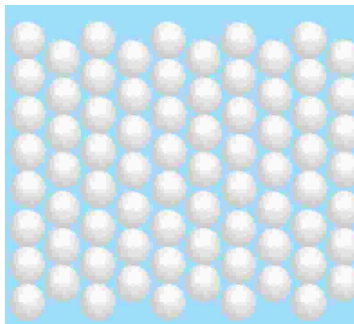

BOLA ISOPOR MOLD EPS DIAM 20MM 100X1
 Código: 48277 Fábrica: ISOMAX Unidade: PT/100
 F1 F4

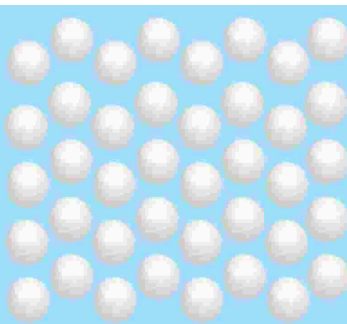

BOLA ISOPOR MOLD EPS DIAM 25MM 100X1
 Código: 48278 Fábrica: ISOMAX Unidade: PT/100
 F1 F4

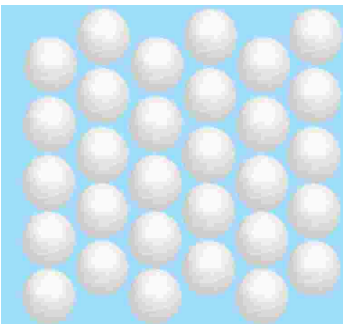

BOLA ISOPOR MOLD EPS DIAM 30MM 100X1
 Código: 47956 Fábrica: ISOMAX Unidade: PT/100
 F1 F4

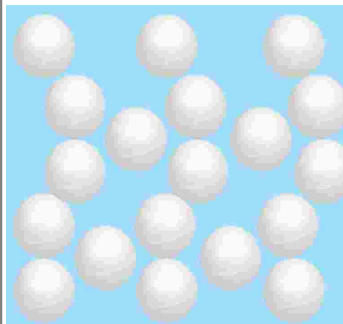

BOLA ISOPOR MOLD EPS DIAM 35MM 100X1
 Código: 30106 Fábrica: ISOMAX Unidade: PT/100
 F1 F4



BOLA ISOPOR MOLD EPS DIAM 40MM 40X1

Código: **30107** Fábrica: **ISOMAX** Unidade: **PT/40**
F1 F4



BOLA ISOPOR MOLD EPS DIAM 50MM 50X1

Código: **30108** Fábrica: **ISOMAX** Unidade: **PT/50**
F1 F4



BOLA ISOPOR MOLD EPS DIAM 60MM 30X1

Código: **30109** Fábrica: **ISOMAX** Unidade: **PT/30**
F1 F4



BOLA ISOPOR MOLD EPS DIAM 70MM 25X1

Código: **47957** Fábrica: **ISOMAX** Unidade: **PT/25**
F1 F4



BOLA ISOPOR MOLD EPS DIAM 75MM 25X1

Código: **30092** Fábrica: **ISOMAX** Unidade: **PT/25**
F1 F4



BOLA ISOPOR MOLD EPS DIAM 80MM 20X1

Código: **48279** Fábrica: **ISOMAX** Unidade: **PT/20**
F1 F4



BOLA ISOPOR MOLD EPS DIAM 90MM 12X1

Código: **48280** Fábrica: **ISOMAX** Unidade: **PT/20**
F1 F4



BOLA ISOPOR MOLD EPS DIAM 100MM 10X1

Código: **30110** Fábrica: **ISOMAX** Unidade: **PT/10**
F1 F4



BOLA ISOPOR MOLD EPS DIAM 125MM 6X1

Código: **30940** Fábrica: **ISOMAX** Unidade: **PT/6**
F1 F4



BOLA ISOPOR MOLD EPS DIAM 150MM 5X1

Código: **30941** Fábrica: **ISOMAX** Unidade: **PT/5**
F1 F4



BOLA ISOPOR MOLD EPS DIAM 175MM 4X1

Código: **30942** Fábrica: **ISOMAX** Unidade: **PT/4**
F1 F4



BOLA ISOPOR MOLD EPS DIAM 200MM 3X1

Código: **30943** Fábrica: **ISOMAX** Unidade: **PT/3**
F1 F4



BOLA ISOPOR MOLD EPS DIAM 250MM 2X1

Código: **30944** Fábrica: **ISOMAX** Unidade: **PT/2**
F1 F4



BOLA ISOPOR MOLD EPS DIAM 300MM 1X1

Código: **30945** Fábrica: **ISOMAX** Unidade: **UN/1**
F1 F4



BOLO ISOPOR REDONDO CIRCULO 100X100MM

Código: **41302** Fábrica: **ISOMAX** Unidade: **PT/1**
F1 F4



BOLO ISOPOR REDONDO 250X250X100MM

Código: **35706** Fábrica: **ISOMAX** Unidade: **PT/1**
F1 F4



BOLO ISOPOR REDONDO 350X350X100MM

Código: 35707 Fábrica: ISOMAX Unidade: PT/1 F1 F4



BORRACHA PONTEIRA 100X1

Código: 41967 Fábrica: VMP Unidade: CX/100 F1 F4



BORRACHA ANATOM PRETA TS2000 24X1

Código: 31873 Fábrica: ECOLE Unidade: CX/24 F1 F4



BORRACHA BICOLOR 40 40X1

Código: 18703 Fábrica: RED BOR/ZAP Unidade: CX/40 F1 F4



BORRACHA BICOLOR 906281 40X1

Código: 49941 Fábrica: BAZZE Unidade: CX/40 F1 F4



BORRACHA BRANCA OVAL GDE BOR6008 24X1

Código: 32951 Fábrica: CLASSE Unidade: CX/24 F1 F4



BORRACHA BRANCA PONTEIRA 50X1

Código: 28029 Fábrica: RED BOR Unidade: CX/50 F1 F4



BORRACHA BRANCA 2B BLISTER 7351 2X1

Código: 46950 Fábrica: YIN'S PAPER Unidade: PT/2 F1 F4



BORRACHA BRANCA 20 GRANDE 20X1

Código: 49263 Fábrica: COLORARE Unidade: CX/20 F1 F4



BORRACHA BRANCA 20 GRANDE 20X1

Código: 13146 Fábrica: PREMIER Unidade: CX/20 F1 F4



BORRACHA BRANCA 20 4420 20X1

Código: 41695 Fábrica: LEO&LEO Unidade: CX/20 F1 F4



BORRACHA BRANCA 40 MEDIA 40X1

Código: 13147 Fábrica: RED BOR Unidade: CX/40 F1 F4



BORRACHA BRANCA 40 MEDIA 40X1

Código: 50791 Fábrica: BAZZE Unidade: CX/40 F1 F4



BORRACHA BRANCA 40 MEDIA 40X1

Código: 49266 Fábrica: COLORARE Unidade: CX/40 F1 F4



BORRACHA BRANCA 40 4419 40X1

Código: 41694 Fábrica: LEO&LEO Unidade: CX/40 F1 F4



BORRACHA BRANCA 60 PEQUENA 60X1

Código: 13148 Fábrica: PREMIER/RED Unidade: CX/60 F1 F4

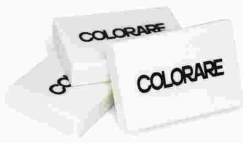

BORRACHA BRANCA 60 PEQUENA 60X1
 Código: 49264 Fábrica: COLORARE Unidade: CX/60
 F1 F4



BORRACHA BRANCA 60 20072 60X1
 Código: 50683 Fábrica: WINPAPER Unidade: CX/60
 F1 F4



BORRACHA BRANCA 60 4418 60X1
 Código: 41696 Fábrica: LEO&LEO Unidade: CX/60
 F1 F4



BORRACHA COLORIDA 4126 24X1
 Código: 41650 Fábrica: LEO&LEO Unidade: C/24
 F1 F4



BORRACHA KIT CHAPEU/BOTA/BOCAFLO 5X1
 Código: 41676 Fábrica: MONALIZA Unidade: CR/5
 F4



BORRACHA MECANICA (REFIL) 24X1
 Código: 12047 Fábrica: JL Unidade: PT/24
 F1 F4



BORRACHA PLAST HANNAH MONTANA 24X1
 Código: 38554 Fábrica: TRIS Unidade: CX/24
 F1 F4



BORRACHA PLAST HIGH SCHOOL MUSICAL 24X1
 Código: 38555 Fábrica: TRIS Unidade: CX/24
 F1 F4



BORRACHA PONTEIRA BRANCA 4352 48X1
 Código: 42145 Fábrica: LEO&LEO Unidade: C/48
 F1 F4



BORRACHA QUAD BRANCA CAPA PLAST 584 24X1
 Código: 41227 Fábrica: LEO&LEO Unidade: CX/24
 F1 F4



BORRACHA QUADR BRANCA C/CAPA PLAST 24X1
 Código: 44116 Fábrica: PLANETA Unidade: CX/24
 F1 F4

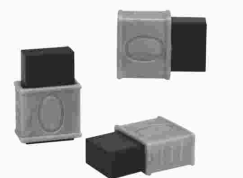

BORRACHA SILVER P C/CAPA PLAST 7147 12X1
 Código: 23220 Fábrica: GOLLER Unidade: CX/12
 F1 F4



BORRACHA VERDE 15 GRANDE 15X1
 Código: 4253 Fábrica: RED BOR/PREM Unidade: CX/15
 F1 F4



BORRACHA 40 MEDIA 4X1 CTL
 Código: 33832 Fábrica: GOLLER Unidade: CT/4
 F1 F4



BROCAL 3 GRS AZUL 12X1
 Código: 6755 Fábrica: CITY BRILHO Unidade: CX/12
 F1 F4



BROCAL 3 GRS DOURADO 12X1
 Código: 6760 Fábrica: CITY BRILHO Unidade: CX/12
 F1 F4



BROCAL 3 GRS MULTICOR 12X1
 Código: 6759 Fábrica: CITY BRILHO Unidade: CX/12 F1 F4



BROCAL 3 GRS PEROLADO 12X1
 Código: 6758 Fábrica: CITY BRILHO Unidade: CX/12 F1 F4



BROCAL 3 GRS PINK 12X1
 Código: 6907 Fábrica: CITY BRILHO Unidade: CX/12 F1 F4



BROCAL 3 GRS PRATA 12X1
 Código: 25 Fábrica: CITY BRILHO Unidade: CX/12 F1 F4



BROCAL 3 GRS PRETO 12X1
 Código: 21975 Fábrica: CITY BRILHO Unidade: CX/12 F1 F4



BROCAL 3 GRS ROSA 12X1
 Código: 6761 Fábrica: CITY BRILHO Unidade: CX/12 F1 F4



BROCAL 3 GRS ROXO 12X1
 Código: 7477 Fábrica: CITY BRILHO Unidade: CX/12 F1 F4



BROCAL 3 GRS VERDE 12X1
 Código: 6756 Fábrica: CITY BRILHO Unidade: CX/12 F1 F4



BROCAL 3 GRS VERMELHO 12X1
 Código: 6757 Fábrica: CITY BRILHO Unidade: CX/12 F1 F4



BROCAL 100 GRS AZUL PISCINA
 Código: 43646 Fábrica: CITY BRILHO Unidade: PT/1 F1 F4



BROCAL 100 GRS AZUL ROYAL
 Código: 43649 Fábrica: CITY BRILHO Unidade: PT/1 F1 F4



BROCAL 100 GRS AZUL TURQUESA
 Código: 43647 Fábrica: CITY BRILHO Unidade: PT/1 F1 F4



BROCAL 100 GRS MARROM
 Código: 43648 Fábrica: CITY BRILHO Unidade: PT/1 F1 F4



BROCAL 100 GRS OURO
 Código: 26352 Fábrica: CITY BRILHO Unidade: PT/1 F1 F4



BROCAL 100 GRS PEROLADO
 Código: 26359 Fábrica: CITY BRILHO Unidade: PT/1 F1 F4



BROCAL 100 GRS PINK
 Código: 26357 Fábrica: CITY BRILHO Unidade: PT/1 F1 F4



BROCAL 100 GRS PRATA

Código: 26353
 Fábrica: CITY BRILHO
 Unidade: PT/1
 F1 F4



BROCAL 100 GRS PRETO

Código: 21647
 Fábrica: CITY BRILHO
 Unidade: PT/1
 F1 F4



BROCAL 100 GRS ROSA

Código: 26356
 Fábrica: CITY BRILHO
 Unidade: PT/1
 F1 F4



BROCAL 100 GRS ROXO

Código: 26361
 Fábrica: CITY BRILHO
 Unidade: PT/1
 F1 F4



BROCAL 100 GRS VERDE BANDEIRA

Código: 26355
 Fábrica: CITY BRILHO
 Unidade: PT/1
 F1 F4



BROCAL 100 GRS VERDE OLIVA

Código: 43645
 Fábrica: CITY BRILHO
 Unidade: PT/1
 F1 F4



BROCAL 100 GRS VERMELHO

Código: 26354
 Fábrica: CITY BRILHO
 Unidade: PT/1
 F1 F4



BROCAL 500 GRS AZUL

Código: 43637
 Fábrica: CITY BRILHO
 Unidade: PT/1
 F1 F4



BROCAL 500 GRS OURO

Código: 43639
 Fábrica: CITY BRILHO
 Unidade: PT/1
 F1 F4



BROCAL 500 GRS PRATA

Código: 43640
 Fábrica: CITY BRILHO
 Unidade: PT/1
 F1 F4



BROCAL 500 GRS PRETO

Código: 43641
 Fábrica: CITY BRILHO
 Unidade: PT/1
 F1 F4



BROCAL 500 GRS ROSA

Código: 43642
 Fábrica: CITY BRILHO
 Unidade: PT/1
 F1 F4



BROCAL 500 GRS VERDE

Código: 43643
 Fábrica: CITY BRILHO
 Unidade: PT/1
 F1 F4



BROCAL 500 GRS VERMELHO

Código: 43644
 Fábrica: CITY BRILHO
 Unidade: PT/1
 F1 F4



CADERNETA CD 1/8 ESP 96FLS FURRY BE 10X1

Código: 20343
 Fábrica: MAXMA
 Unidade: PT/10
 F1 F4



CADERNETA CD 1/8 ESP 96FLS LOUISE 10X1

Código: 34002
 Fábrica: MAXIMA
 Unidade: PT/10
 F1 F4



CADERNETA CD 1/8 ESP 96FLS LOVE 10X1

Código: 33609 Fábrica: MAXIMA Unidade: PT/10
F1 F4

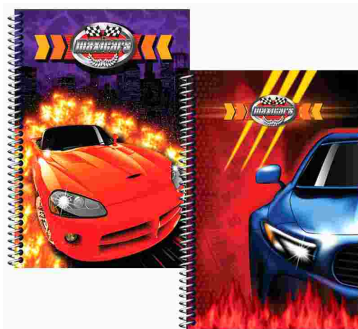

CADERNETA CD 1/8 ESP 96FLS MAXICARS10X1

Código: 33999 Fábrica: MAXIMA Unidade: PT/10
F1 F4



CADERNETA CD 1/8 ESP 96FLS X-PHOTO 10X1

Código: 34001 Fábrica: MAXIMA Unidade: PT/10
F1 F4



CADERNETA CD 1/8 ESP 96FLS X-SPIDER 10X1

Código: 33997 Fábrica: MAXIMA Unidade: PT/10
F1 F4



CADERNETA CD 1/8 ESP 96FLS X-SPORT 10X1

Código: 33998 Fábrica: MAXIMA Unidade: PT/10
F1 F4



CADERNETA 1/16 APONTAMENTO 40FLS 40X1

Código: 45842 Fábrica: CREDEAL Unidade: PT/40
F1 F4



CADERNETA 1/16 BOLSO ESPIRAL 40FLS 40X1

Código: 12473 Fábrica: PAUTA/NOVA Unidade: PT/40
F1 F4



CADERNETA 1/16 BOLSO ESPIRAL 40FLS 50X1

Código: 45819 Fábrica: NEEDS Unidade: PT/50
F1 F4



CADERNETA 1/8 ANOTACOES 48FLS ESP 20X1

Código: 20286 Fábrica: PANAMER/CRED Unidade: PT/20
F1 F4



CADERNETA 1/8 ANOTACOES 96FLS ESP 10X1

Código: 5252 Fábrica: CREDEAL Unidade: PT/10
F1 F4



CADERNETA 1/8 DEVE/HAVER 16FLS 30X1

Código: 15707 Fábrica: PARRKE Unidade: PT/30
F1 F4



CADERNETA 1/8 ESP 96FLS 10X1

Código: 42912 Fábrica: NEEDS Unidade: PT/10
F1 F4



CADERNO 1MAT 96FLS UNIVERS FLEX 4X1

Código: 44110 Fábrica: ROMITEC Unidade: PT/4
F1 F4

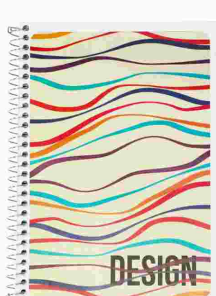

CADERNO 1MAT 96FLS UNIVERS FLEX 5X1

Código: 45252 Fábrica: ROMITEC Unidade: PT/5
F1 F4



CADERNO ALIBOMBOM CD 80F 123 C/P VD 5X1

Código: 33780 Fábrica: MAXIMA Unidade: PT/5
F1 F4



CADERNO ALIBOMBOM CD 80F 123 S/P AZ 5X1

Código: 33781 Fábrica: MAXIMA Unidade: PT/5
F1 F4



CADERNO ALIBOMBOM CD 80F 123X C/P VM 5X1
 Código: 23696 Fábrica: MAXIMA Unidade: PT/5
 F1 F4



CADERNO ALIBOMBOM CF 60F 123 C/P VD 10X1
 Código: 33779 Fábrica: MAXIMA Unidade: PT/10
 F1 F4



CADERNO ALIBOMBOM CF 60F 123 S/P AZ
 Código: 40756 Fábrica: MAXIMA Unidade: UN/1
 F1 F4



CADERNO ALIBOMBOM CF 60F 123X C/P VM 10X
 Código: 23695 Fábrica: MAXIMA Unidade: PT/10
 F1 F4



CADERNO ARG PP 80FLS STYLES DREAM C/6DIV
 Código: 46055 Fábrica: ACP Unidade: UN/1
 F1 F4



CADERNO ARG PP 80FLS STYLES LOVE C/6DIV
 Código: 46102 Fábrica: ACP Unidade: UN/1
 F1 F4

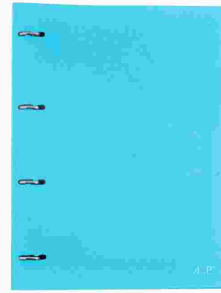

CADERNO ARG PP 96FLS SWEET C/6DIV AZUL
 Código: 46099 Fábrica: ACP Unidade: UN/1
 F1 F4



CADERNO ARG PP 96FLS SWEET C/6DIV PRETO
 Código: 46100 Fábrica: ACP Unidade: UN/1
 F1 F4

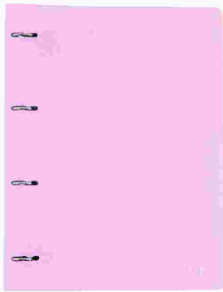

CADERNO ARG PP 96FLS SWEET C/6DIV ROSA
 Código: 46098 Fábrica: ACP Unidade: UN/1
 F1 F4



CADERNO ARG PVC 96FLS C/6DIV AMARELO
 Código: 46089 Fábrica: ACP Unidade: UN/1
 F1 F4



CADERNO ARG PVC 96FLS C/6DIV LARANJA
 Código: 46091 Fábrica: ACP Unidade: UN/1
 F1 F4



CADERNO ARG PVC 96FLS C/6DIV PINK
 Código: 46090 Fábrica: ACP Unidade: UN/1
 F1 F4

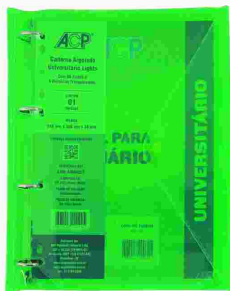

CADERNO ARG PVC 96FLS C/6DIV VERDE
 Código: 46088 Fábrica: ACP Unidade: UN/1
 F1 F4

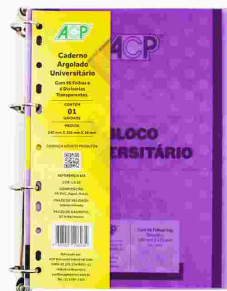

CADERNO ARG PVC 96FLS POA C/6DIV LILAS
 Código: 46092 Fábrica: ACP Unidade: UN/1
 F1 F4



CADERNO ARG PVC 96FLS POA C/6DIV PRETO
 Código: 46094 Fábrica: ACP Unidade: UN/1
 F1 F4



CADERNO ARG PVC 96FLS POA C/6DIV ROSA
 Código: 46095 Fábrica: ACP Unidade: UN/1
 F1 F4



CADERNO ARG 96FLS SWEET C/6DIV P LAP LIL
 Código: 46127 Fábrica: ACP Unidade: UN/1
 F1 F4



CADERNO ARG 96FLS SWEET C/6DIV P LAP ROS
 Código: 46126 Fábrica: ACP Unidade: UN/1
 F1 F4



CADERNO BROC CD 40FLS CALIGRAFIA 10X1
 Código: 50702 Fábrica: CREDEAL Unidade: PT/10
 F1 F4



CADERNO BROC CD 80FLS C/P AMARELO 5X1
 Código: 49100 Fábrica: CREDEAL/MAXI Unidade: PT/5
 F1 F4

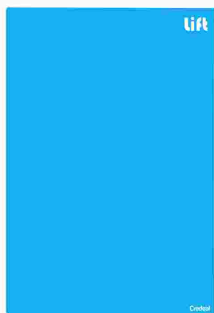

CADERNO BROC CD 80FLS C/P AZUL 5X1
 Código: 49099 Fábrica: CREDEAL/MAXI Unidade: PT/5
 F1 F4



CADERNO BROC CD 80FLS C/P LALA PETS 5X1
 Código: 43807 Fábrica: CREDEAL Unidade: PT/5
 F1 F4

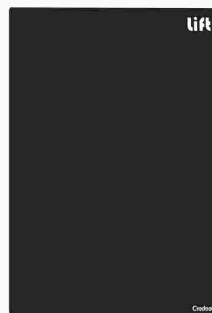

CADERNO BROC CD 80FLS C/P PRETO 5X1
 Código: 49103 Fábrica: CREDEAL Unidade: PT/5
 F1 F4



CADERNO BROC CD 80FLS C/P VERDE 5X1
 Código: 49102 Fábrica: CREDEAL/MAXI Unidade: PT/5
 F1 F4

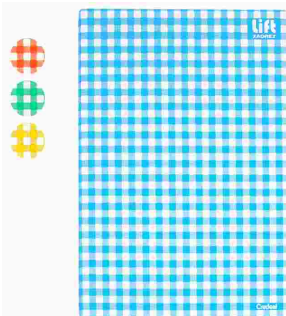

CADERNO BROC CD 80FLS C/P XADREZ 5X1
 Código: 49104 Fábrica: CREDEAL Unidade: PT/5
 F1 F4



CADERNO BROC CD 96FLS CALIGRAFIA 5X1
 Código: 33996 Fábrica: MAXIMA Unidade: PT/5
 F1 F4



CADERNO BROC CD 96FLS C/P AMARELO 5X1
 Código: 19351 Fábrica: MAXIM/CREDEA Unidade: PT/5
 F1 F4



CADERNO BROC CD 96FLS C/P AZUL 5X1
 Código: 20603 Fábrica: MAXIMA Unidade: PT/5
 F1 F4



CADERNO BROC CD 96FLS C/P DEC FEM 50X1
 Código: 50893 Fábrica: MAXIMA Unidade: CX/50
 F1 F4



CADERNO BROC CD 96FLS C/P DEC MASC 50X1
 Código: 50894 Fábrica: MAXIMA Unidade: CX/50
 F1 F4

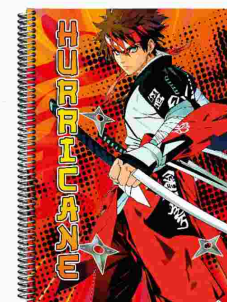

CADERNO BROC CD 96FLS C/P HURRACANE 5X1
 Código: 46626 Fábrica: MAXIMA Unidade: PT/5
 F1 F4

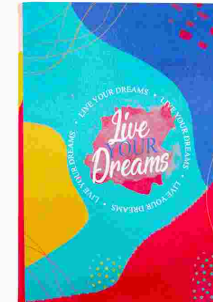

CADERNO BROC CD 96FLS C/P I LIKE 5X1
 Código: 43311 Fábrica: MAXIMA Unidade: PT/5
 F1 F4



CADERNO BROCD CD 96FLS C/P LALA FEM 5X1
 Código: 43808 Fábrica: CREDEAL Unidade: PT/5
 F1 F4



CADERNO BROCD CD 96FLS C/P LALA MASC 5X1
 Código: 29792 Fábrica: CREDEAL Unidade: PT/5
 F1 F4



CADERNO BROCD CD 96FLS C/P LARANJA 5X1
 Código: 40827 Fábrica: MAXIMA Unidade: PT/5
 F1 F4

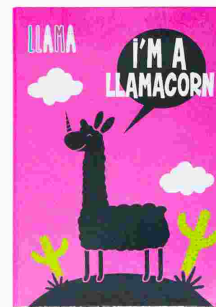

CADERNO BROCD CD 96FLS C/P LLAMAS 5X1
 Código: 44979 Fábrica: MAXIMA Unidade: PT/5
 F1 F4



CADERNO BROCD CD 96FLS C/P LOUISE 5X1
 Código: 33263 Fábrica: MAXIMA Unidade: PT/5
 F1 F4

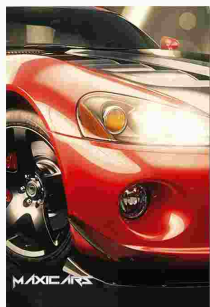

CADERNO BROCD CD 96FLS C/P MAXICARS 5X1
 Código: 36291 Fábrica: MAXIMA Unidade: PT/5
 F1 F4

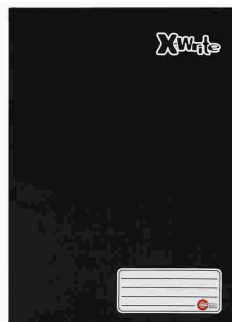

CADERNO BROCD CD 96FLS C/P PRETO 5X1
 Código: 40826 Fábrica: MAXIMA Unidade: PT/5
 F1 F4

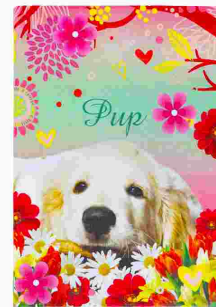

CADERNO BROCD CD 96FLS C/P PUP 5X1
 Código: 33268 Fábrica: MAXIMA Unidade: PT/5
 F1 F4



CADERNO BROCD CD 96FLS C/P SEASON 5X1
 Código: 31549 Fábrica: MAXIMA Unidade: PT/5
 F1 F4

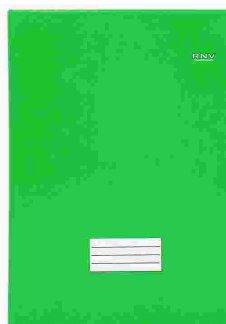

CADERNO BROCD CD 96FLS C/P VERDE 5X1
 Código: 23502 Fábrica: MAX/CREDE/TIL Unidade: PT/5
 F1 F4



CADERNO BROCD CD 96FLS C/P VERMELHO 5X1
 Código: 20641 Fábrica: MAXIM/CREDEA Unidade: PT/5
 F1 F4

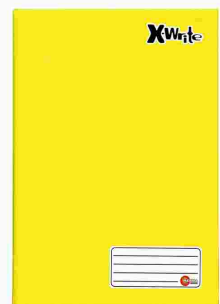

CADERNO BROCD CD 96FLS S/P AMARELO 5X1
 Código: 20643 Fábrica: MAXIMA Unidade: PT/5
 F1 F4

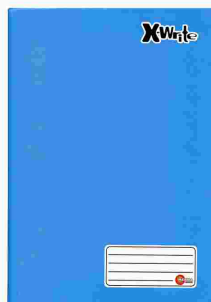

CADERNO BROCD CD 96FLS S/P AZUL 5X1
 Código: 36312 Fábrica: MAXIMA Unidade: PT/5
 F1 F4



CADERNO BROCD CD 96FLS S/P CORUJAS 5X1
 Código: 49460 Fábrica: MAXIMA Unidade: PT/5
 F1 F4



CADERNO BROCD CD 96FLS S/P FLAMINGOS 5X1
 Código: 50891 Fábrica: MAXIMA Unidade: PT/5
 F1 F4



CADERNO BROCD CD 96FLS S/P LOUISES 5X1
 Código: 50890 Fábrica: MAXIMA Unidade: PT/5
 F1 F4

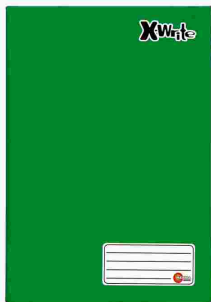

CADERNO BROCCD 96FLS S/P VERDE 5X1

Código: 20600 Fábrica: MAXIMA Unidade: PT/5 F1 F4



CADERNO BROCCD 96FLS S/P VERMELHO 5X1

Código: 20604 Fábrica: MAXIMA Unidade: PT/5 F1 F4

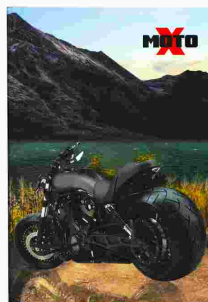

CADERNO BROCCD 96FLS S/P X-MOTO 5X1

Código: 50892 Fábrica: MAXIMA Unidade: PT/5 F1 F4



CADERNO BROCCF 40FL 1/4 CALIGRAFIA 20X1

Código: 43376 Fábrica: CREDEAL Unidade: PT/20 F1 F4



CADERNO BROCCFORT 48FLS CALIGRAFIA 10X1

Código: 42917 Fábrica: NEEDS Unidade: PT/10 F1 F4

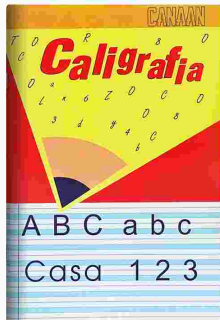

CADERNO BROCCFORT 60FLS CALIGRAFIA 10X1

Código: 19853 Fábrica: MINEIRO Unidade: PT/10 F1 F4



CADERNO BROCCFORTE 60FLS C/P 10X1

Código: 50903 Fábrica: MAXIMA Unidade: PT/10 F1 F4



CADERNO BROCCFORTE 60FLS S/P 10X1

Código: 50904 Fábrica: MAXIMA Unidade: PT/10 F1 F4



CADERNO BROCCFORTE 80FL 1MA AMIGAS 10X1

Código: 43818 Fábrica: FORONI Unidade: PT/10 F1 F4



CADERNO BROCCFORTE 80FLS 1MAT JUDY 10X1

Código: 43832 Fábrica: FORONI Unidade: PT/10 F1 F4



CADERNO BROCCFLEX 60FLS C/P LALA 15X1

Código: 19556 Fábrica: CREDEAL Unidade: PT/15 F1 F4



CADERNO BROCCFLEX 60FLS C/P 10X1

Código: 9737 Fábrica: MAXIMA/JAND Unidade: PT/10 F1 F4

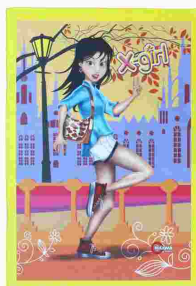

CADERNO BROCCFLEX 80FLS C/P LALA 10X1

Código: 4043 Fábrica: CREDEAL Unidade: PT/10 F1 F4



CADERNO BROCCFLEX 80FLS C/P 10X1

Código: 14644 Fábrica: MAXIMA Unidade: PT/10 F1 F4



CADERNO BROCCFLEX 96FLS C/P 10X1

Código: 40828 Fábrica: MAXIMA Unidade: PT/10 F1 F4

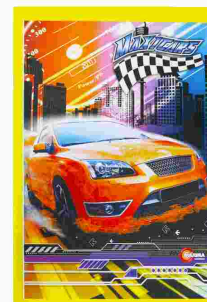

CADERNO BROCCFLEX 96FLS S/P 10X1

Código: 35513 Fábrica: MAXIMA/PANAM Unidade: PT/10 F1 F4

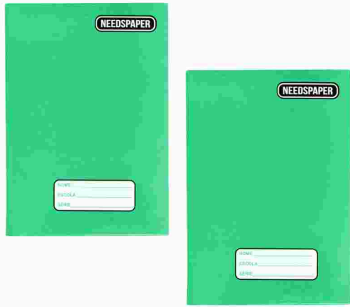

CADERNO BROC 1/4 CD 40FLS PAUTA VERDE
 Código: 42308 Fábrica: NEEDS Unidade: UN/1
 F1 F4



CADERNO BROC 1/4 CD 96FLS CECI 5X1
 Código: 50896 Fábrica: MAXIMA Unidade: PT/5
 F1 F4



CADERNO BROC 1/4 CD 96FLS CHILLIN 5X1
 Código: 40824 Fábrica: MAXIMA Unidade: PT/5
 F1 F4



CADERNO BROC 1/4 CD 96FLS CORUJAS 5X1
 Código: 34003 Fábrica: MAXIMA Unidade: PT/5
 F1 F4



CADERNO BROC 1/4 CD 96FLS DINO 5X1
 Código: 36127 Fábrica: MAXIMA Unidade: PT/5
 F1 F4



CADERNO BROC 1/4 CD 96FLS FLAMINGO 5X1
 Código: 40841 Fábrica: MAXIMA Unidade: PT/5
 F1 F4

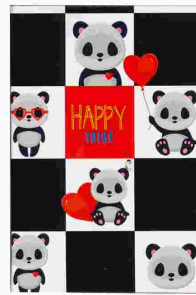

CADERNO BROC 1/4 CD 96FLS HAPPY TRIB 5X1
 Código: 50897 Fábrica: MAXIMA Unidade: PT/5
 F1 F4



CADERNO BROC 1/4 CD 96FLS HURRANE 5X1
 Código: 50895 Fábrica: MAXIMA Unidade: PT/5
 F1 F4

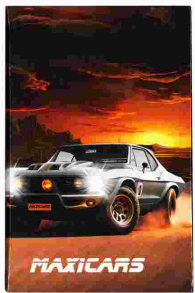

CADERNO BROC 1/4 CD 96FLS MAXICARS 5X1
 Código: 34434 Fábrica: MAXIMA Unidade: PT/5
 F1 F4



CADERNO BROC 1/4 CD 96FLS MERMAID 5X1
 Código: 40825 Fábrica: MAXIMA Unidade: PT/5
 F1 F4



CADERNO BROC 1/4 CD 96FLS PUP 5X1
 Código: 34004 Fábrica: MAXIMA Unidade: PT/5
 F1 F4



CADERNO BROC 1/4 CD 96FLS UNICORNS 5X1
 Código: 34006 Fábrica: MAXIMA Unidade: PT/5
 F1 F4



CADERNO BROC 1/4 CD 96FLS X-MOTO 5X1
 Código: 34010 Fábrica: MAXIMA Unidade: PT/5
 F1 F4

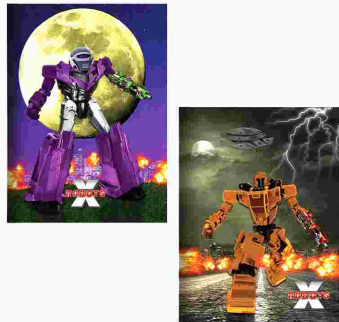

CADERNO BROC 1/4 CD 96FLS X-ROBOTS 5X1
 Código: 34011 Fábrica: MAXIMA Unidade: PT/5
 F1 F4

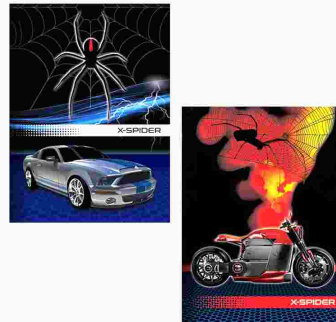

CADERNO BROC 1/4 CD 96FLS X-SPIDER 5X1
 Código: 34009 Fábrica: MAXIMA Unidade: PT/5
 F1 F4



CADERNO BROC 1/4 FLEX 48FLS C/P 20X1
 Código: 13440 Fábrica: MAXIM/CREDEA Unidade: PT/20
 F1 F4



CADERNO BROC 1/4 FLEX 60 FLS 20X1
 Código: 43269 Fábrica: JANDAINHA Unidade: PT/20
 F1 F4



CADERNO BROC 1/4 FLEX 96FLS C/P 10X1
 Código: 160 Fábrica: MAXIMA/JA Unidade: PT/10
 F1 F4



CADERNO BROC 1/4 QUADRICULADO 80FLS 10X1
 Código: 44715 Fábrica: SULAMERICANA Unidade: PT/10
 F1 F4



CADERNO BROC 40 FLS 1/4 CALIGRAFIA 20X1
 Código: 14041 Fábrica: PANAMERICANA Unidade: PT/20
 F1 F4



CADERNO CD 1MAT 80 FLS POP 5X1
 Código: 34080 Fábrica: CADERNIL Unidade: PT/5
 F1 F4



CADERNO CD 1MAT 80FLS ESSENC PRETO 4X1
 Código: 50701 Fábrica: CREDEAL Unidade: PT/4
 F1 F4



CADERNO CD 1MAT 80FLS ESSENCIALE 5X1
 Código: 43658 Fábrica: CREDEAL Unidade: PT/5
 F1 F4



CADERNO CD 1MAT 80FLS MY COLL MASC 4X1
 Código: 50417 Fábrica: CREDEAL Unidade: PT/4
 F1 F4



CADERNO CD 1MAT 80FLS PERFORMANCE 4X1
 Código: 49105 Fábrica: CREDEAL Unidade: PT/4
 F1 F4



CADERNO CD 1MAT 96FLS AYRTON SENA UN
 Código: 40099 Fábrica: POMBO Unidade: UN/1
 F1 F4



CADERNO CD 1MAT 96FLS AYRTON SENA 6X1
 Código: 27829 Fábrica: POMBO Unidade: PT/6
 F1 F4

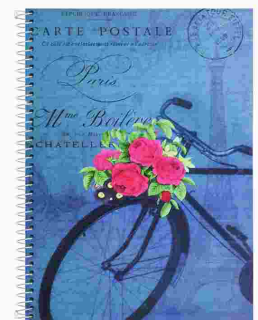

CADERNO CD 1MAT 96FLS BICYCLE 6X1
 Código: 33757 Fábrica: MAXIMA Unidade: PT/6
 F1 F4

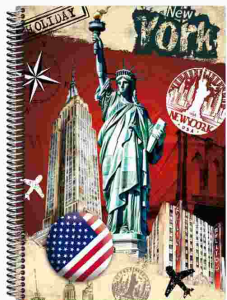

CADERNO CD 1MAT 96FLS CITY TOUR 6X1
 Código: 33269 Fábrica: MAXIMA Unidade: PT/6
 F1 F4



CADERNO CD 1MAT 96FLS COPDOGS B/A 6X1
 Código: 50901 Fábrica: MAXIMA Unidade: PT/6
 F1 F4

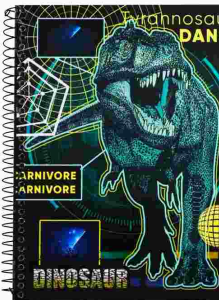

CADERNO CD 1MAT 96FLS DINO B/A 6X1
 Código: 36305 Fábrica: MAXIMA Unidade: PT/6
 F1 F4



CADERNO CD 1MAT 96FLS FLAMINGO B/A 6X1
 Código: 33777 Fábrica: MAXIMA Unidade: PT/6
 F1 F4

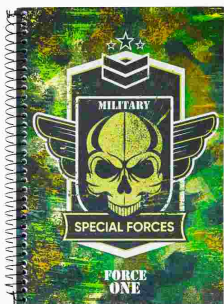

CADERNO CD 1MAT 96FLS FORCE ONE 6X1

Código: 44814 Fábrica: MAXIMA Unidade: PT/6 F1 F4



CADERNO CD 1MAT 96FLS FURRY BEA B/A 6X1

Código: 37733 Fábrica: MAXIMA Unidade: PT/6 F1 F4



CADERNO CD 1MAT 96FLS GO AHEAD UN

Código: 33356 Fábrica: POMBO Unidade: UN/1 F1 F4

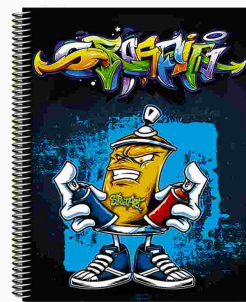

CADERNO CD 1MAT 96FLS GRAFFIX 6X1

Código: 36131 Fábrica: MAXIMA Unidade: PT/6 F1 F4

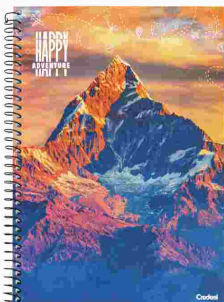

CADERNO CD 1MAT 96FLS HAPPY ADVENTU 4X1

Código: 45838 Fábrica: CREDEAL Unidade: PT/4 F1 F4



CADERNO CD 1MAT 96FLS HAPPY TRI B/A 5X1

Código: 23718 Fábrica: MAXIMA Unidade: UN/1 F1 F4



CADERNO CD 1MAT 96FLS JEANS WORLD 6X1

Código: 29793 Fábrica: MAXIMA Unidade: PT/6 F1 F4



CADERNO CD 1MAT 96FLS LINDINHAS 6X1

Código: 26482 Fábrica: MAXIMA Unidade: PT/6 F1 F4



CADERNO CD 1MAT 96FLS LOUISE B/A 6X1

Código: 37735 Fábrica: MAXIMA Unidade: PT/6 F1 F4

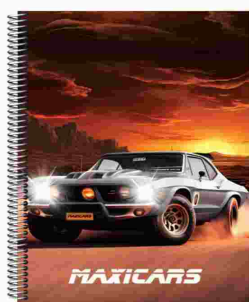

CADERNO CD 1MAT 96FLS MAXICARS 6X1

Código: 26637 Fábrica: MAXIMA Unidade: PT/6 F1 F4

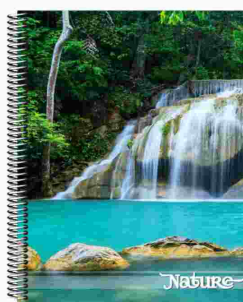

CADERNO CD 1MAT 96FLS NATURE 6X1

Código: 34308 Fábrica: MAXIMA Unidade: PT/6 F1 F4



CADERNO CD 1MAT 96FLS OP ART 6X1

Código: 40833 Fábrica: MAXIMA Unidade: PT/6 F1 F4

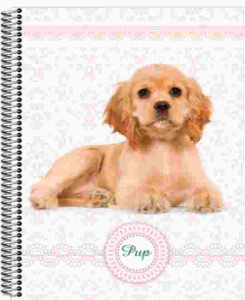

CADERNO CD 1MAT 96FLS PUP 6X1

Código: 26478 Fábrica: MAXIMA Unidade: PT/6 F1 F4

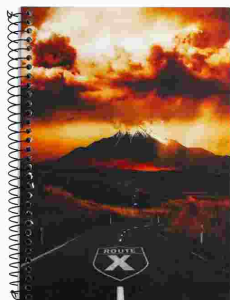

CADERNO CD 1MAT 96FLS ROUTE B/A 6X1

Código: 50900 Fábrica: MAXIMA Unidade: PT/6 F1 F4



CADERNO CD 1MAT 96FLS SEASON B/A 6X1

Código: 33758 Fábrica: MAXIMA Unidade: PT/6 F1 F4

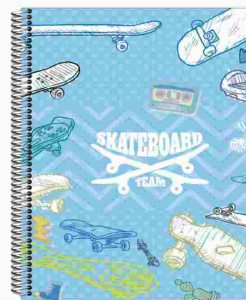

CADERNO CD 1MAT 96FLS SKATE 6X1

Código: 37825 Fábrica: MAXIMA Unidade: PT/6 F1 F4



CADERNO CD 1MAT 96FLS SUPER CHI B/A 6X1
 Código: 37990 Fábrica: MAXIMA Unidade: PT/6
 F1 F4



CADERNO CD 1MAT 96FLS X-ANIMAL 6X1
 Código: 26480 Fábrica: MAXIMA Unidade: PT/6
 F1 F4

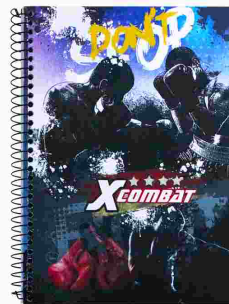

CADERNO CD 1MAT 96FLS X-COMBAT B/A 6X1
 Código: 30653 Fábrica: MAXIMA Unidade: PT/6
 F1 F4



CADERNO CD 1MAT 96FLS X-DAYS 6X1
 Código: 50703 Fábrica: MAXIMA Unidade: PT/6
 F1 F4

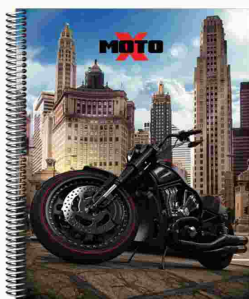

CADERNO CD 1MAT 96FLS X-MOTO 6X1
 Código: 26676 Fábrica: MAXIMA Unidade: PT/6
 F1 F4

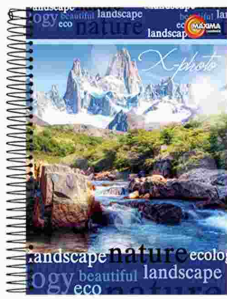

CADERNO CD 1MAT 96FLS X-PHOTO 6X1
 Código: 27459 Fábrica: MAXIMA Unidade: PT/6
 F1 F4

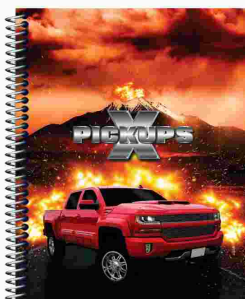

CADERNO CD 1MAT 96FLS X-PICKUP 6X1
 Código: 26484 Fábrica: MAXIMA Unidade: PT/6
 F1 F4

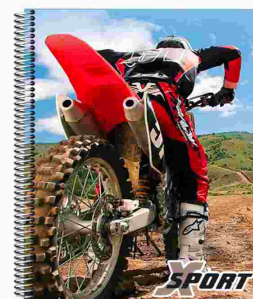

CADERNO CD 1MAT 96FLS X-SPORT 6X1
 Código: 29812 Fábrica: MAXIMA Unidade: PT/6
 F1 F4



CADERNO CD 1MAT 96FLS X-STUDIO 6X1
 Código: 32516 Fábrica: MAXIMA Unidade: PT/6
 F1 F4

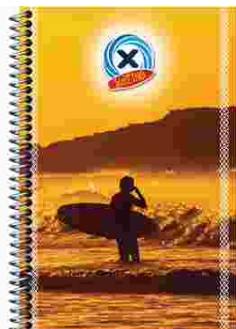

CADERNO CD 1MAT 96FLS X-SURFING 6X1
 Código: 33270 Fábrica: MAXIMA Unidade: PT/6
 F1 F4



CADERNO CD 1MAT 96FLS 177X240MM 4X1
 Código: 50440 Fábrica: TILIBRA Unidade: PT/4
 F1 F4



CADERNO CD PEDAG QUADRICULADO 48FLS UN
 Código: 45827 Fábrica: NEEDS Unidade: UN/1
 F1 F4

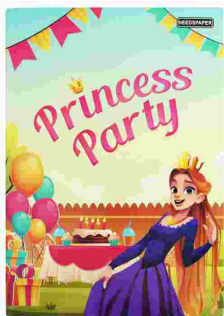

CADERNO CD PEDAG QUADRICULADO 48FLS 10X1
 Código: 45822 Fábrica: NEEDS Unidade: PT/10
 F1 F4

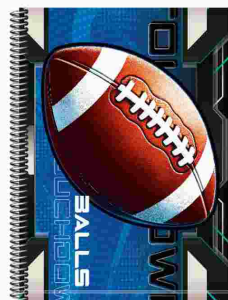

CADERNO CD 10MAT 160FLS BALLS 4X1
 Código: 50898 Fábrica: MAXIMA Unidade: PT/4
 F1 F4

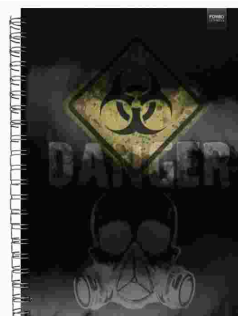

CADERNO CD 10MAT 160FLS GO AHEAD UN
 Código: 33361 Fábrica: POMBO Unidade: UN/1
 F1 F4

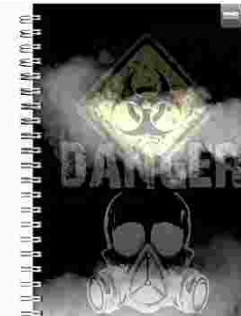

CADERNO CD 10MAT 160FLS GO AHEAD 6X1
 Código: 32805 Fábrica: POMBO Unidade: PT/6
 F1 F4

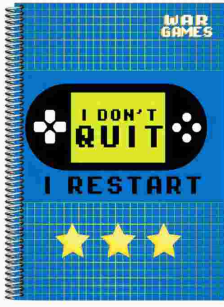

CADERNO CD 10MAT 160FLS WAR GAME 4X1
 Código: 50899 Fábrica: MAXIMA Unidade: PT/4
 F1 F4



CADERNO CD 10MAT 200 FLS X-SPIDE B/A 3X1
 Código: 38175 Fábrica: MAXIMA Unidade: PT/3
 F1 F4

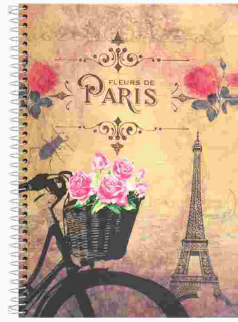

CADERNO CD 10MAT 200FLS BICYCLE 4X1
 Código: 33766 Fábrica: MAXIMA Unidade: PT/4
 F1 F4

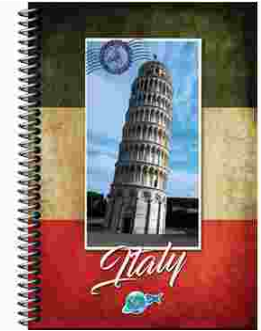

CADERNO CD 10MAT 200FLS CITY TOUR 4X1
 Código: 33261 Fábrica: MAXIMA Unidade: PT/4
 F1 F4

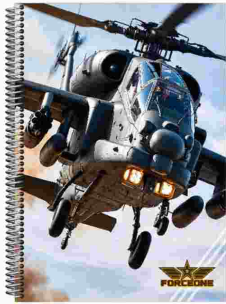

CADERNO CD 10MAT 200FLS FORCE ONE 4X1
 Código: 50709 Fábrica: MAXIMA Unidade: PT/4
 F1 F4

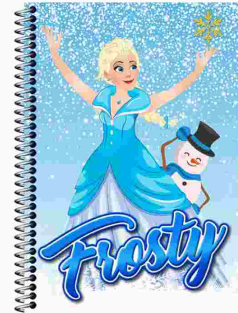

CADERNO CD 10MAT 200FLS FROSTY B/A 4X1
 Código: 33765 Fábrica: MAXIMA Unidade: PT/4
 F1 F4

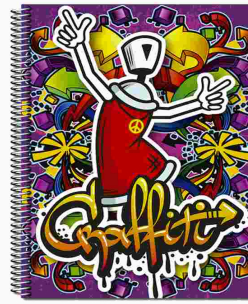

CADERNO CD 10MAT 200FLS GRAFFIX 4X1
 Código: 36289 Fábrica: MAXIMA Unidade: PT/4
 F1 F4

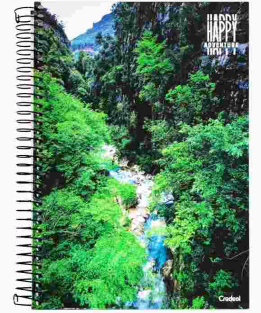

CADERNO CD 10MAT 200FLS HAPPY ADVENT 3X1
 Código: 43657 Fábrica: CREDEAL Unidade: PT/3
 F1 F4



CADERNO CD 10MAT 200FLS JEANS WORLD 4X1
 Código: 24633 Fábrica: MAXIMA Unidade: PT/4
 F1 F4



CADERNO CD 10MAT 200FLS MAXICARS 4X1
 Código: 24635 Fábrica: MAXIMA Unidade: PT/4
 F1 F4



CADERNO CD 10MAT 200FLS MY COLL FEM 3X1
 Código: 43804 Fábrica: CREDEAL Unidade: PT/3
 F1 F4

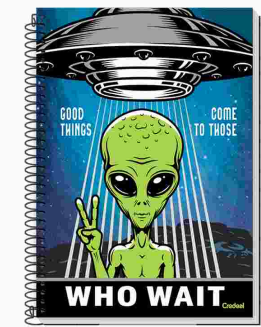

CADERNO CD 10MAT 200FLS MY COLL MASC 3X1
 Código: 43803 Fábrica: CREDEAL Unidade: PT/3
 F1 F4

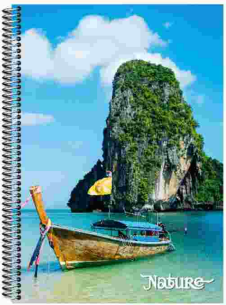

CADERNO CD 10MAT 200FLS NATURE 4X1
 Código: 50706 Fábrica: MAXIMA Unidade: PT/4
 F1 F4



CADERNO CD 10MAT 200FLS PUP B/A4X1
 Código: 37682 Fábrica: MAXIMA Unidade: PT/4
 F1 F4

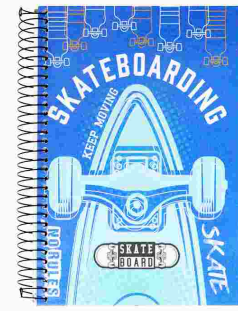

CADERNO CD 10MAT 200FLS SKATE 4X1
 Código: 34348 Fábrica: MAXIMA Unidade: PT/4
 F1 F4

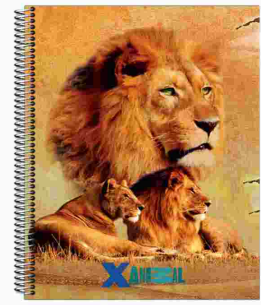

CADERNO CD 10MAT 200FLS X-ANIMAL 4X1
 Código: 24634 Fábrica: MAXIMA Unidade: PT/4
 F1 F4



CADERNO CD 10MAT 200FLS X-DAYS 4X1

Código: 50704 Fábrica: MAXIMA Unidade: PT/4
F1 F4

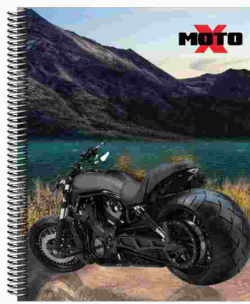

CADERNO CD 10MAT 200FLS X-MOTO 4X1

Código: 20653 Fábrica: MAXIMA Unidade: PT/4
F1 F4



CADERNO CD 10MAT 200FLS X-PHOTO 4X1

Código: 24319 Fábrica: MAXIMA Unidade: PT/4
F1 F4

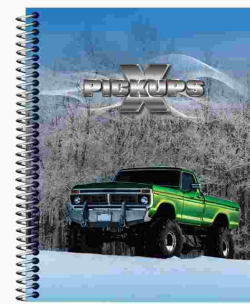

CADERNO CD 10MAT 200FLS X-PICKUP 4X1

Código: 26288 Fábrica: MAXIMA Unidade: PT/4
F1 F4

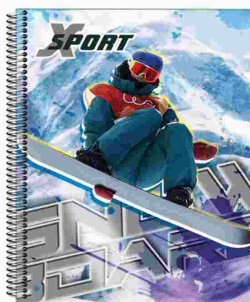

CADERNO CD 10MAT 200FLS X-SPORTS 4X1

Código: 24305 Fábrica: MAXIMA Unidade: PT/4
F1 F4

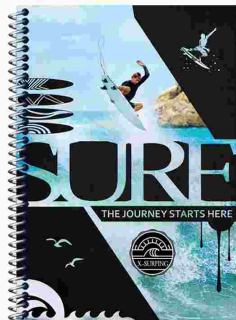

CADERNO CD 10MAT 200FLS X-SURFING 4X1

Código: 28777 Fábrica: MAXIMA Unidade: PT/4
F1 F4



CADERNO CD 1/4 ESP 96FLS UN

Código: 45865 Fábrica: SULAMERICANA Unidade: PT/1
F1 F4

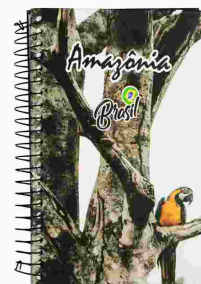

CADERNO CD 1/4 ESP 200FLS UN

Código: 45768 Fábrica: NEEDS Unidade: UN/1
F1 F4



CADERNO CD 1/4 ESP 200FLS X-PHOTO 4X1

Código: 34013 Fábrica: MAXIMA Unidade: PT/4
F1 F4

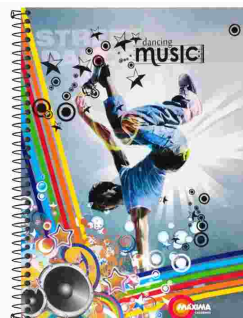

CADERNO CD 15MAT 300FLS DANCING B/A 3X1

Código: 36669 Fábrica: MAXIMA Unidade: PT/3
F1 F4

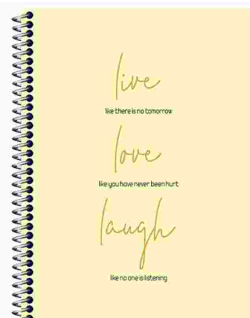

CADERNO CD 15MAT 300FLS I LIKE B/A 3X1

Código: 36134 Fábrica: MAXIMA Unidade: PT/3
F1 F4

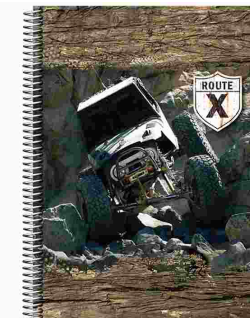

CADERNO CD 15MAT 300FLS ROUTE 3X1

Código: 37992 Fábrica: MAXIMA Unidade: PT/3
F1 F4



CADERNO CD 15MAT 300FLS WONDERLA B/A 3X1

Código: 36687 Fábrica: MAXIMA Unidade: PT/3
F1 F4



CADERNO CD 15MAT 300FLS X-ANIMAL 3X1

Código: 20658 Fábrica: MAXIMA Unidade: PT/3
F1 F4



CADERNO CD 15MAT 300FLS X-DAYS 3X1

Código: 50705 Fábrica: MAXIMA Unidade: PT/3
F1 F4



CADERNO CD 15MAT 300FLS X-GIRLS 3X1

Código: 24380 Fábrica: MAXIMA Unidade: PT/3
F1 F4

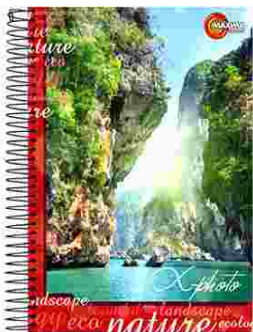

CADERNO CD 15MAT 300FLS X-PHOTO 3X1

Código: **24308** Fábrica: **MAXIMA** Unidade: **PT/3**
F1 F4

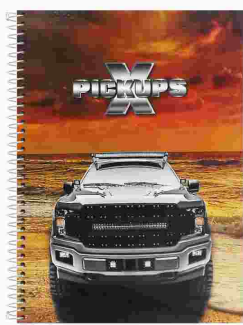

CADERNO CD 15MAT 300FLS X-PICKUP 3X1

Código: **33769** Fábrica: **MAXIMA** Unidade: **PT/3**
F1 F4



CADERNO CD 16MAT 320FLS LINDINHAS 3X1

Código: **37821** Fábrica: **MAXIMA** Unidade: **PT/3**
F1 F4



CADERNO CD 20MAT 400FLS LOVE B/A 2X1

Código: **37988** Fábrica: **MAXIMA** Unidade: **PT/2**
F1 F4

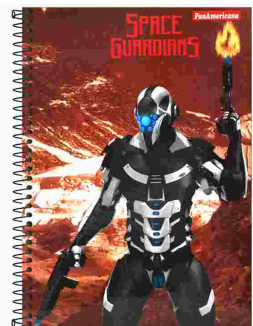

CADERNO CD 20MAT 400FLS SPACE B/A 2X1

Código: **38164** Fábrica: **PANAMERICANA** Unidade: **PT/2**
F1 F4

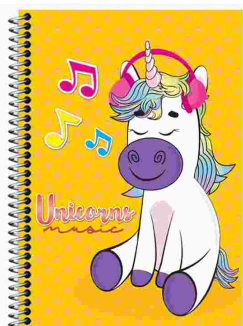

CADERNO CD 20MAT 400FLS UNICORNS B/A2X1

Código: **36650** Fábrica: **MAXIMA** Unidade: **PT/2**
F1 F4



CADERNO CD 20MAT 400FLS X-GIRLS 2X1

Código: **24383** Fábrica: **MAXIMA** Unidade: **PT/2**
F1 F4

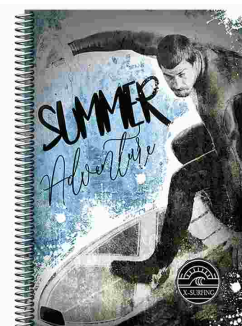

CADERNO CD 20MAT 400FLS X-SURFIN B/A 2X1

Código: **37823** Fábrica: **MAXIMA** Unidade: **PT/2**
F1 F4

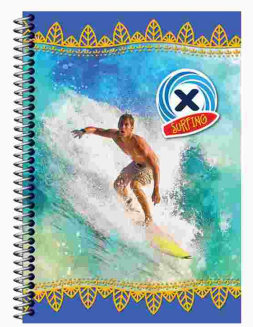

CADERNO CD 20MAT 400FLS X-SURFING 2X1

Código: **33776** Fábrica: **MAXIMA** Unidade: **PT/2**
F1 F4



CADERNO CD 40FLS CALIGRA 19X24CM PAUVERD

Código: **48077** Fábrica: **SAO DOMINGOS** Unidade: **UN/1**
F1 F4



CADERNO COST C/FLEX 25X18CM 32FLS C/P UN

Código: **47917** Fábrica: **YIN'S PAPER** Unidade: **UN/1**
F1 F4



CADERNO COST 1/4 CD 48FLS AMARE C/P10X1

Código: **24896** Fábrica: **MAXIMA** Unidade: **PT/10**
F1 F4

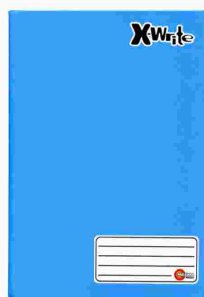

CADERNO COST 1/4 CD 48FLS AZUL C/P 10X1

Código: **23221** Fábrica: **MAXIMA** Unidade: **PT/10**
F1 F4

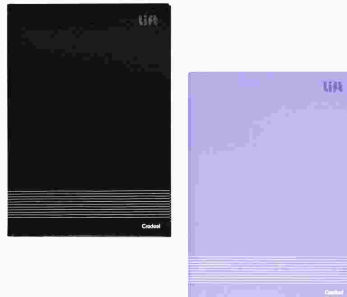

CADERNO COST 1/4 CD 48FLS COLOR C/P 5X1

Código: **45791** Fábrica: **CREDEAL** Unidade: **PT/5**
F1 F4



CADERNO COST 1/4 CD 48FLS C/P MAGIC 5X1

Código: **38465** Fábrica: **NOVA** Unidade: **PT/5**
F1 F4

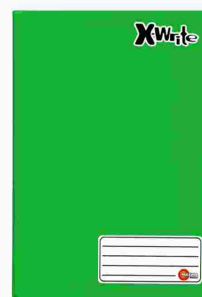

CADERNO COST 1/4 CD 48FLS VERDE C/P10X1

Código: **27066** Fábrica: **MAXIMA** Unidade: **PT/10**
F1 F4

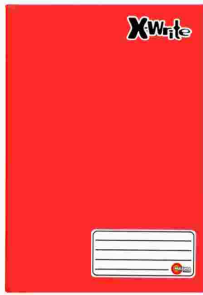

CADERNO COST 1/4 CD 48FLS VERME C/P10X1
 Código: 26636 Fábrica: MAXIMA Unidade: PT/10
 F1 F4



CADERNO COST 1/4 CD 96FLS AZUL C/P 5X1
 Código: 6166 Fábrica: MAXIM/CREDEA Unidade: PT/5
 F1 F4



CADERNO COST 1/4 CD 96FLS BARBI C/P 10X1
 Código: 35593 Fábrica: FORONI Unidade: PT/10
 F1 F4



CADERNO COST 1/4 CD 96FLS FEM C/P 10X1
 Código: 35335 Fábrica: RENOVO Unidade: PT/10
 F1 F4



CADERNO COST 1/4 CD 96FLS VERDE C/P 5X1
 Código: 19572 Fábrica: MAXIM/CREDEA Unidade: PT/5
 F1 F4



CADERNO COST 1/4 CD 96FLS VERME C/P 5X1
 Código: 6167 Fábrica: CREDEAL Unidade: PT/5
 F1 F4

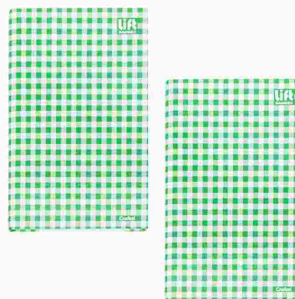

CADERNO COST 1/4 CD 96FLS XADREZ C/P 5X1
 Código: 43656 Fábrica: CREDEAL Unidade: PT/5
 F1 F4



CADERNO DESENHO BROCH 1/4 FLEX 40FL 20X1
 Código: 46800 Fábrica: JANDAIA Unidade: PT/20
 F1 F4



CADERNO DESENHO CD GR MILIMETR 96FLS 5X1
 Código: 42916 Fábrica: NEEDS Unidade: PT/5
 F1 F4



CADERNO DESENHO CD GR 48FLS S/SEDA UN
 Código: 46731 Fábrica: NEEDS Unidade: UN/1
 F1 F4



CADERNO DESENHO CD GR 48FLS S/SEDA 10X1
 Código: 1364 Fábrica: MAXIMA Unidade: PT/10
 F1 F4



CADERNO DESENHO CD GR 80FLS VERDE 5X1
 Código: 50689 Fábrica: CREDEAL Unidade: PT/5
 F1 F4



CADERNO DESENHO CD MEIA PAUTA 40FLS 4X1
 Código: 49107 Fábrica: CREDEAL Unidade: PT/4
 F1 F4



CADERNO DESENHO CF GR 48FLS C/SEDA 10X1
 Código: 14042 Fábrica: CREDEAL Unidade: PT/10
 F1 F4



CADERNO DESENHO CF GR 48FLS S/SEDA 10X1
 Código: 43631 Fábrica: CREDEAL Unidade: PT/10
 F1 F4



CADERNO DESENHO ESP 1/4 FLEX 40FL 15X1
 Código: 46946 Fábrica: PANAMERICANA Unidade: PT/15
 F1 F4

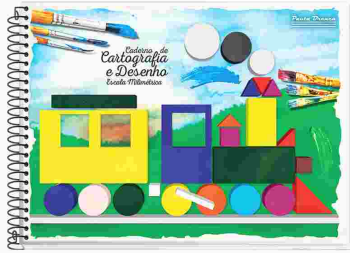

CADERNO DESENHO GR 48FLS S/SEDA FLE 10X1
 Código: 24704 Fábrica: MAXIMA Unidade: PT/10
 F1 F4



CADERNO DESENHO GR 96FLS S/SEDA FLE 10X1
 Código: 19178 Fábrica: NEEDS Unidade: PT/10
 F1 F4

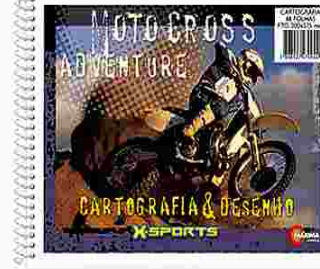

CADERNO DESENHO GR 96FLS S/SEDA FLEX 5X1
 Código: 24703 Fábrica: MAXIMA Unidade: PT/5
 F1 F4



CADERNO ESP 1/4 CD 96FLS PRINCY 5X1
 Código: 38462 Fábrica: NOVA Unidade: PT/5
 F1 F4



CADERNO ESP 1/4 FLEX 48FLS C/P 20X1
 Código: 23469 Fábrica: MAXIMA Unidade: PT/20
 F1 F4



CADERNO ESP 1/4 FLEX 96FLS C/P 10X1
 Código: 1366 Fábrica: MAXI/3B/PAN Unidade: PT/10
 F1 F4

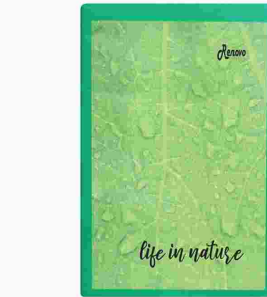

CADERNO FLEX 1/4 96FLS C/P UN
 Código: 42446 Fábrica: MAXIMA Unidade: UN/1
 F1 F4



CADERNO LIVRO ATA 50FLS UN
 Código: 42149 Fábrica: PAGINABRASIL Unidade: UN/1
 F1 F4



CADERNO LIVRO ATA 50FLS 10X1
 Código: 8038 Fábrica: PAGINABRASIL Unidade: PT/10
 F1 F4

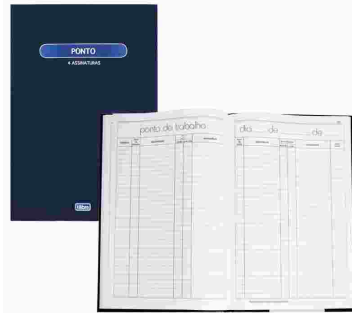

CADERNO LIVRO ATA 100FLS GDE UN
 Código: 42052 Fábrica: TILIBRA Unidade: UN/1
 F1 F4



CADERNO LIVRO ATA 100FLS UN
 Código: 41692 Fábrica: GRIFFE/PAGIN Unidade: UN/1
 F1 F4



CADERNO LIVRO ATA 200FLS UN
 Código: 41685 Fábrica: PAGINABRASIL Unidade: UN/1
 F1 F4



CADERNO LIVRO ATA 200FLS 3X1
 Código: 35263 Fábrica: PAGINABRASIL Unidade: PT/3
 F1 F4



CADERNO MUSICA CD 1/4 ESP 80 FLS 5X1
 Código: 43536 Fábrica: CREDEAL Unidade: PT/5
 F1 F4

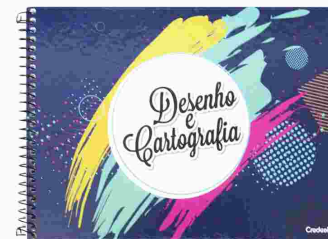

CADERNO MUSICA CF ESP 50 FLS 5X1
 Código: 43635 Fábrica: CREDEAL Unidade: PT/5
 F1 F4

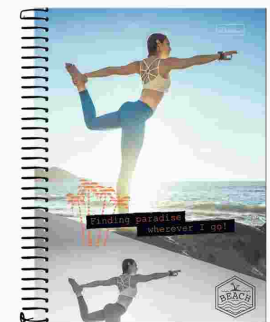

CADERNO PASTA 10MAT 200FLS BEACH B/A
 Código: 21566 Fábrica: CADERSIL Unidade: UN/1
 F1 F4



CAIXA ARQ MORTO OF PARDO 36X24X13CM UN
 Código: 12480 Fábrica: DELPAP/JUSSA Unidade: UN/1
 F1 F4



CAIXA ARQ MORTO POLION 30X18,5X39CM AZUL
 Código: 49909 Fábrica: POLIBRAS Unidade: PT/1
 F1 F4



CAIXA ARQ MORTO POLIONDA
 Código: 8979 Fábrica: ALAPLAST Unidade: UN/1
 F1 F4



CAIXA ARQ MORTO POLIONDA AMARELO
 Código: 41183 Fábrica: ALAPLAST Unidade: UN/1
 F1 F4



CAIXA ARQ MORTO POLIONDA AZUL
 Código: 46080 Fábrica: ALAPLAST Unidade: UN/1
 F1 F4



CAIXA ARQ MORTO POLIONDA BRANCO
 Código: 46081 Fábrica: ALAPLAST Unidade: UN/1
 F1 F4



CAIXA ARQ MORTO POLIONDA CINZA
 Código: 41184 Fábrica: ALAPLAST Unidade: UN/1
 F1 F4



CAIXA ARQ MORTO POLIONDA GIG AMARELO 50X1
 Código: 42420 Fábrica: ALAPLAST Unidade: PT/50
 F1 F4



CAIXA ARQ MORTO POLIONDA GIG AMARELO UN
 Código: 48783 Fábrica: ALAPLAST Unidade: UN/1
 F1 F4



CAIXA ARQ MORTO POLIONDA GIG AZUL UN
 Código: 48779 Fábrica: ALAPLAST Unidade: UN/1
 F1 F4



CAIXA ARQ MORTO POLIONDA GIG CINZA UN
 Código: 48782 Fábrica: ALAPLAST Unidade: UN/1
 F1 F4



CAIXA ARQ MORTO POLIONDA GIG PRETA 50X1
 Código: 43872 Fábrica: ALAPLAST Unidade: PT/50
 F1 F4



CAIXA ARQ MORTO POLIONDA GIG PRETO UN
 Código: 48784 Fábrica: ALAPLAST Unidade: UN/1
 F1 F4



CAIXA ARQ MORTO POLIONDA GIG VERDE UN
 Código: 48786 Fábrica: ALAPLAST Unidade: UN/1
 F1 F4



CAIXA ARQ MORTO POLIONDA GIG VERDE 50X1
 Código: 43293 Fábrica: ALAPLAST Unidade: PT/50
 F1 F4



CAIXA ARQ MORTO POLIONDA GIG VERMEL 50X1
 Código: 42419 Fábrica: ALAPLAST Unidade: PT/50
 F1 F4

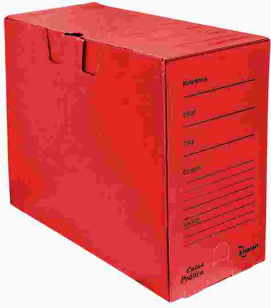

CAIXA ARQ MORTO POLIONDA GIG VERMELHO UN
 Código: 48785 Fábrica: ALAPLAST Unidade: UN/1
 F1 F4



CAIXA ARQ MORTO POLIONDA PRAT AMARE 50X1
 Código: 42425 Fábrica: ALAPLAST Unidade: PT/50
 F1 F4



CAIXA ARQ MORTO POLIONDA PRAT CINZA 50X1
 Código: 42426 Fábrica: ALAPLAST Unidade: PT/50
 F1 F4



CAIXA ARQ MORTO POLIONDA PRAT PRETA 50X1
 Código: 43079 Fábrica: ALAPLAST Unidade: PT/50
 F1 F4

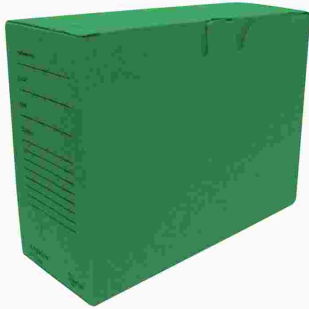

CAIXA ARQ MORTO POLIONDA PRAT VERDE 50X1
 Código: 42424 Fábrica: ALAPLAST Unidade: PT/50
 F1 F4



CAIXA ARQ MORTO POLIONDA PRAT VERME 50X1
 Código: 42695 Fábrica: ALAPLAST Unidade: PT/50
 F1 F4



CAIXA ARQ MORTO POLIONDA PRETO
 Código: 46079 Fábrica: ALAPLAST Unidade: UN/1
 F1 F4



CAIXA ARQ MORTO POLIONDA VERDE
 Código: 13256 Fábrica: ALAPLAST Unidade: UN/1
 F1 F4

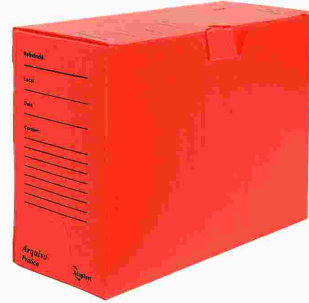

CAIXA ARQ MORTO POLIONDA VERMELHO
 Código: 41182 Fábrica: ALAPLAST Unidade: UN/1
 F1 F4



CAIXA ARQ MULTIBOX POLIOND GDE AMADEIRAD
 Código: 43786 Fábrica: ALAPLAST Unidade: UN/1
 F1 F4

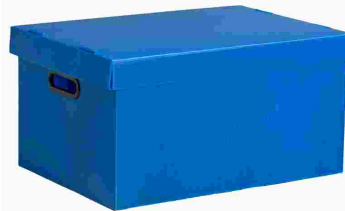

CAIXA ARQ MULTIBOX POLIOND GDE AZUL
 Código: 43301 Fábrica: ALAPLAST Unidade: UN/1
 F1 F4

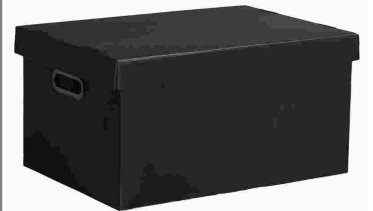

CAIXA ARQ MULTIBOX POLIOND GDE PRETO
 Código: 43785 Fábrica: ALAPLAST Unidade: UN/1
 F1 F4



CAIXA ARQ MULTIBOX POLIOND MED AMADEIRAD
 Código: 43788 Fábrica: ALAPLAST Unidade: UN/1
 F1 F4

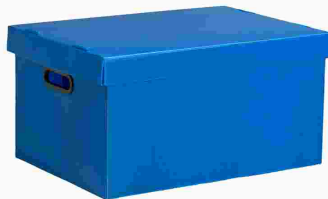

CAIXA ARQ MULTIBOX POLIOND MED AZUL
 Código: 43300 Fábrica: ALAPLAST Unidade: UN/1
 F1 F4



CAIXA ARQ MULTIBOX POLIOND MED PRETO
 Código: 43787 Fábrica: ALAPLAST Unidade: UN/1
 F1 F4

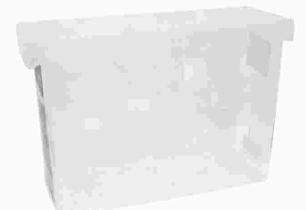

CAIXA ARQ P/PASTA SUSPENZA CRISTAL
 Código: 42735 Fábrica: DELLO Unidade: PT/50
 F1 F4



CAIXA ARQ P/PASTA SUSPENSa PRETA

Código: 42742 Fábrica: DELLO Unidade: UN/1
F1 F4

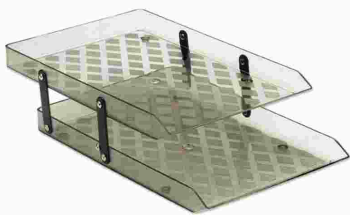

CAIXA CORRESP DUPLA FUME 37X25,5CM 46

Código: 48057 Fábrica: MAXCRIL Unidade: UN/1
F1 F4



CAIXA CORRESP DUPLA PRETA 25X35CM 217

Código: 41799 Fábrica: CARBRINK Unidade: UN/1
F1 F4

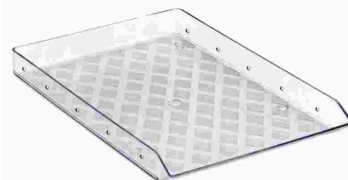

CAIXA CORRESP SIMPL CRISTAL 37X25,5CM 43

Código: 48058 Fábrica: MAXCRIL Unidade: UN/1
F1 F4



CAIXA CORRESP SIMPLS PRETA 25X35CM 216

Código: 41797 Fábrica: CARBRINK Unidade: UN/1
F1 F4

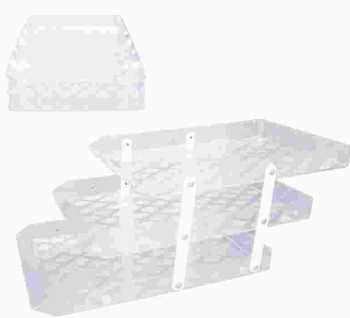

CAIXA CORRESP TRIPLA CRIST 37X25,2CM 50

Código: 44676 Fábrica: MAXCRIL Unidade: UN/1
F1 F4



CAIXA CORRESP TRIPLA PRETA NOV VAZAD 441

Código: 50770 Fábrica: CARBRINK Unidade: UN/1
F1 F4



CAIXA CORRESP TRIPLA PRETA 25X35CM 218

Código: 41798 Fábrica: CARBRINK Unidade: UN/1
F1 F4

21cm
28cm
37cm



CAIXA ORG KRAFT RESINADA 37X28X21CM 1021

Código: 45744 Fábrica: JUSSARA Unidade: UN/1
F1 F4

21cm
31cm
44cm



CAIXA ORG KRAFT RESINADA 46X32X23CM 1022

Código: 45745 Fábrica: JUSSARA Unidade: UN/1
F1 F4



CAIXA ORGANIZADORA POLIONDA LISA MED UN

Código: 43012 Fábrica: ALAPLAST Unidade: UN/1
F1 F4



CAIXA PAPELAO CV N00 CORREIO 1005 25X1

Código: 42700 Fábrica: SANTECK Unidade: PT/25
F1 F4



CAIXA PAPELAO CV N01 CORREIO 1000 25X1

Código: 39979 Fábrica: SANTECK Unidade: PT/25
F1 F4



CAIXA PAPELAO CV N02 CORREIO 1002 25X1

Código: 39980 Fábrica: SANTECK Unidade: PT/24
F1 F4



CAIXA PAPELAO CV N04 CORREIO 1004 25X1

Código: 42702 Fábrica: SANTECK Unidade: PT/25
F1 F4



10 cm
19 cm
28 cm

CAIXA PVC PORTA TRECOS BARBIE 2558

Código: 15404 Fábrica: POLIBRAS. Unidade: UN/1
F1 F4

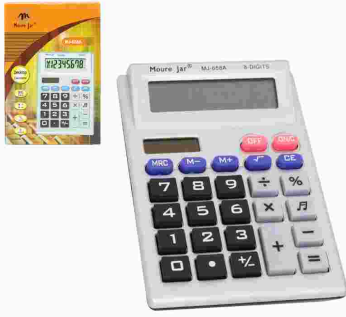

CALCULADORA 8 DIG A PILHA MJ-658A
Código: 13084 Fábrica: MJ Unidade: UN/1
F1 F4



CALCULADORA 8 DIG MED KK-800A BAT
Código: 41647 Fábrica: GATE Unidade: UN/1
F1 F4



CALCULADORA 8 DIG MED KK-8008V BAT
Código: 41648 Fábrica: GATE Unidade: UN/1
F1 F4



CALCULADORA 8 DIG PQ PILHA AA S/API 402
Código: 23639 Fábrica: RELINX Unidade: UN/1
F1 F4



CALCULADORA CIENTIF 10+2 DIG BATER 9318C
Código: 35296 Fábrica: IDEA Unidade: UN/1
F1 F4



CALCULADORA CIENTIFICA 12DIG 240 FUNC 82
Código: 49908 Fábrica: MJ Unidade: UN/1
F1 F4



CALCULADORA 12 DIG COLOR PILHA 9136D-12
Código: 43292 Fábrica: XHADAY Unidade: UN/1
F1 F4



CALCULADORA 12 DIG PILHA AA 0036
Código: 46867 Fábrica: PLANETA Unidade: UN/1
F1 F4



CALCULADORA 12 DIG PILHA 837B
Código: 42231 Fábrica: MJ Unidade: UN/1
F1 F4



CALCULADORA 12 DIG PILHA 838B-12
Código: 43204 Fábrica: XHADAY Unidade: UN/1
F1 F4



CALCULADORA 8 DIG BAT C/APITO 9844
Código: 22056 Fábrica: DOTAD Unidade: UN/1
F1 F4



CALCULADORA 8+2 DIG CIENTIF PILH AA 7722
Código: 47929 Fábrica: YIN'S PAPER Unidade: UN/1
F1 F4

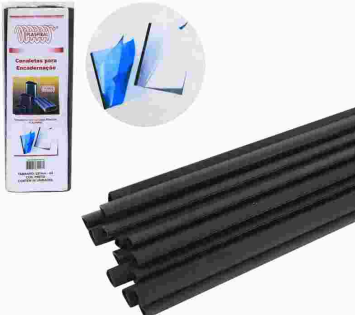

CANAETA P/ENCADERNACAO A4 PRETA 50X1
Código: 41677 Fábrica: PLASPIRAL Unidade: PT/50
F1 F4



CANETA CORRETIVA UN
Código: 42508 Fábrica: MASTERPRINT Unidade: UN/1
F1 F4



CANETA CORRETIVA 4ML 131 12X1
Código: 46415 Fábrica: KAZ Unidade: CX/12
F1 F4



CANETA CORRETIVA 7 ML 904539 12X1
Código: 49494 Fábrica: BAZZE Unidade: DZ/12
F1 F4



CANETA CORRETIVA 7ML 435 24X1

Código: **13096** Fábrica: **MASTERPRINT** Unidade: **CX/24 F1 F4**

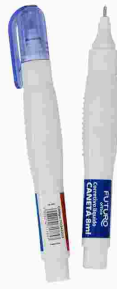

CANETA CORRETIVA 8ML 242203 24X1

Código: **44107** Fábrica: **FUTURO** Unidade: **CX/24 F1 F4**



CANETA DETECTORA DE DH FALSO CTL 96059

Código: **40934** Fábrica: **JOCAROFFICE** Unidade: **CR/1 F1 F4**



CANETA ESF CLIC 0.55MM BROW 12X1

Código: **48561** Fábrica: **NEWPEN** Unidade: **DZ/12 F1 F4**



CANETA ESF CLIC 0.55MM GREEN 12X1

Código: **48560** Fábrica: **NEWPEN** Unidade: **DZ/12 F1 F4**



CANETA ESF CLIC 0.55MM LIGHT GREEN 12X1

Código: **48563** Fábrica: **NEWPEN** Unidade: **DZ/12 F1 F4**



CANETA ESF CLIC 0.55MM LIGHT PINK 12X1

Código: **48562** Fábrica: **NEWPEN** Unidade: **DZ/12 F1 F4**



CANETA ESF CLIC 0.55MM SILVER 12X1

Código: **48559** Fábrica: **NEWPEN** Unidade: **DZ/12 F1 F4**



CANETA ESF CLIC 0.55MM YELLOW 12X1

Código: **48564** Fábrica: **NEWPEN** Unidade: **DZ/12 F1 F4**



CANETA ESF CLIC 1.0MM AZUL 1135 48X1

Código: **48556** Fábrica: **NEWPEN** Unidade: **CX/48 F1 F4**



CANETA ESF CLIC 1.0MM PRETA 1134 48X1

Código: **48557** Fábrica: **NEWPEN** Unidade: **CX/48 F1 F4**



CANETA ESF CRISTAL 0.8MM AZUL FINA 50X1

Código: **31710** Fábrica: **BIC** Unidade: **CX/50 F1 F4**



CANETA ESF CRISTAL 0.8MM PRETA FINA 50X1

Código: **29642** Fábrica: **BIC** Unidade: **CX/50 F1 F4**



CANETA ESF CRISTAL 0.8MM VERM FINA 50X1

Código: **34032** Fábrica: **BIC** Unidade: **CX/50 F1 F4**



CANETA ESF CRISTAL 1.0MM AZUL MED 50X1

Código: **12538** Fábrica: **BIC** Unidade: **CX/50 F1 F4**



CANETA ESF CRISTAL 1.0MM VERM MED 50X1

Código: **29783** Fábrica: **BIC** Unidade: **CX/50 F1 F4**



CANETA ESF CRISTAL 1.6MM AZUL BOLD 25X1
 Código: 50120 Fábrica: BIC Unidade: CX/25 F1 F4



CANETA ESF CRISTAL 1.6MM PRETA BOLD 25X1
 Código: 50121 Fábrica: BIC Unidade: CX/25 F1 F4



CANETA ESF FIXO AZUL C/CORRENTE+RECARG
 Código: 48573 Fábrica: NEWPEN Unidade: UN/1 F1 F4



CANETA ESF GELOCIY 0.5MM AZUL FINA 12X1
 Código: 50122 Fábrica: BIC Unidade: CX/12 F1 F4



CANETA ESF GELOCIY 0.5MM PT/VM FINA 12X1
 Código: 50123 Fábrica: BIC Unidade: CX/12 F1 F4



CANETA ESF INOX 1.0MM AZUL 12X1
 Código: 43815 Fábrica: PILOT Unidade: CX/12 F1 F4



CANETA ESF INOX 1.0MM PRETA 12X1
 Código: 43816 Fábrica: PILOT Unidade: CX/12 F1 F4



CANETA ESF INOX 1.0MM VERMELHO 12X1
 Código: 43817 Fábrica: PILOT Unidade: CX/12 F1 F4



CANETA ESF 0.7 AZUL 100X1
 Código: 35991 Fábrica: COMPACTOR Unidade: CX/100 F1 F4



CANETA ESF 0.7 AZUL 50X1
 Código: 4082 Fábrica: COMPACTOR Unidade: CX/50 F1 F4



CANETA ESF 0.7 MM MY TECH AZUL 7330 25X1
 Código: 46362 Fábrica: JOCAROFFICE Unidade: PT/25 F1 F4



CANETA ESF 0.7 MM MY TECH PRETO 25X1
 Código: 46363 Fábrica: JOCAROFFICE Unidade: CX/25 F1 F4



CANETA ESF 0.7 MM MY TECH VERMELHO 25X1
 Código: 46364 Fábrica: JOCAROFFICE Unidade: CX/25 F1 F4



CANETA ESF 0.7 MM PICNIC COLORIDA 50X1
 Código: 46376 Fábrica: LEO&LEO Unidade: PT/50 F1 F4



CANETA ESF 0.7 MM SILK AZUL 12X1
 Código: 42730 Fábrica: JOCAROFFICE Unidade: CX/12 F1 F4



CANETA ESF 0.7 MM SILK PRETO 12X1
 Código: 42731 Fábrica: JOCAROFFICE Unidade: CX/12 F1 F4



CANETA ESF 0.7 MM TIP CLICK 97945 8X1
 Código: **46361** Fábrica: **JOCAROFFICE** Unidade: **CT/8 F1 F4**



CANETA ESF 0.7 PRETA 50X1
 Código: **3198** Fábrica: **COMPACTOR** Unidade: **CX/50 F1 F4**



CANETA ESF 0.7 ROSA PINK 25X1
 Código: **35994** Fábrica: **COMPACTOR** Unidade: **CX/25 F1 F4**



CANETA ESF 0.7 VERMELHA 50X1
 Código: **3199** Fábrica: **COMPACTOR** Unidade: **CX/50 F1 F4**



CANETA ESF 0.7 VIOLETA 25X1
 Código: **35995** Fábrica: **COMPACTOR** Unidade: **CX/25 F1 F4**



CANETA ESF 0.7MM AZUL POTE 57718 24X1
 Código: **48172** Fábrica: **CIS** Unidade: **PT/24 F1 F4**



CANETA ESF 0.7MM ESPIRAL 98159 5X1
 Código: **46391** Fábrica: **KAZ** Unidade: **CT/5 F1 F4**



CANETA ESF 0.7MM GEL AZUL/PT/VM 4X1
 Código: **48221** Fábrica: **SHARPIE** Unidade: **CR/4 F1 F4**



CANETA ESF 0.7MM INKJOY GEL RETRATIL 2X1
 Código: **48206** Fábrica: **PAPER MATE** Unidade: **CR/2 F1 F4**



CANETA ESF 0.7MM INKJOY GEL RETRATIL 4X1
 Código: **48207** Fábrica: **PAPER MATE** Unidade: **CR/4 F1 F4**



CANETA ESF 0.7MM KIT 5 CORES
 Código: **46249** Fábrica: **PILOT** Unidade: **KT/1 F1 F4**



CANETA ESF 0.7MM PRETA POTE 57719 24X1
 Código: **48173** Fábrica: **CIS** Unidade: **PT/24 F1 F4**



CANETA ESF 0.7MM SORT POTE 57717 24X1
 Código: **48174** Fábrica: **CIS** Unidade: **PT/24 F1 F4**



CANETA ESF 0.7MM SUPER GRIP LARANJA 12X1
 Código: **46150** Fábrica: **PILOT** Unidade: **CX/12 F1 F4**



CANETA ESF 0.7MM SUPER GRIP VERDE 12X1
 Código: **46152** Fábrica: **PILOT** Unidade: **CX/12 F1 F4**



CANETA ESF 0.7MM SUPER GRIP VERMELH 12X1
 Código: **46154** Fábrica: **PILOT** Unidade: **CX/12 F1 F4**



CANETA ESF 0.7MM SUPER GRIP VIOLETA 12X1
 Código: 46153 Fábrica: PILOT Unidade: CX/12 F1 F4



CANETA ESF 0.7MM WAVE 3 CORES 3X1
 Código: 49498 Fábrica: BAZZE Unidade: PT/3 F1 F4



CANETA ESF 0.7MM WAVE 3CORES POTE 24X1
 Código: 49496 Fábrica: BAZZE Unidade: PT/24 F1 F4



CANETA ESF 0.8MM PONTA FINA AZUL 50X1
 Código: 20614 Fábrica: INJEX PEN Unidade: CX/50 F1 F4



CANETA ESF 0.8MM PONTA FINA PRETA 50X1
 Código: 20617 Fábrica: INJEX PEN Unidade: CX/50 F1 F4



CANETA ESF 0.8MM PONTA FINA VERMELH 50X1
 Código: 20615 Fábrica: INJEX PEN Unidade: CX/50 F1 F4



CANETA ESF 1.0 ECONOMIC FINA AZUL 50X1
 Código: 47847 Fábrica: COMPACTOR Unidade: CX/50 F1 F4



CANETA ESF 1.0 ECONOMIC FINA PRETA 50X1
 Código: 47848 Fábrica: COMPACTOR Unidade: CX/50 F1 F4



CANETA ESF 1.0 ECONOMIC FINA VERMEL 50X1
 Código: 47849 Fábrica: COMPACTOR Unidade: CX/50 F1 F4



CANETA ESF 1.0 ECONOMIC MED AZUL 100X1
 Código: 35992 Fábrica: COMPACTOR Unidade: CX/100 F1 F4



CANETA ESF 1.0 ECONOMIC MED AZUL 50X1
 Código: 27813 Fábrica: COMPACTOR Unidade: CX/50 F1 F4



CANETA ESF 1.0 ECONOMIC MED VERMEL 100X1
 Código: 50416 Fábrica: COMPACTOR Unidade: CX/100 F1 F4



CANETA ESF 1.0 ECONOMIC MED VERMEL 50X1
 Código: 31347 Fábrica: COMPACTOR Unidade: CX/50 F1 F4



CANETA ESF 1.0MM COLOR MINI 04577 24X1
 Código: 49955 Fábrica: BAZZE WAVE Unidade: CX/24 F1 F4



CANETA ESF 1.0MM COLOR 653358 24X1
 Código: 49954 Fábrica: BAZZE WAVE Unidade: CX/24 F1 F4



CANETA ESF 1.0MM COR PASTEIS 98154 6X1
 Código: 46388 Fábrica: KAZ Unidade: CT/6 F1 F4



CANETA ESF 1.0MM CORES 98118 5X1

Código: 46389
 Fábrica: KAZ
 Unidade: CT/5
 F1 F4



CANETA ESF 1.0MM DUO AZ/VM POTE 24X1

Código: 48558
 Fábrica: NEWPEN
 Unidade: CX/24
 F1 F4



CANETA ESF 1.0MM HEXAG AZUL 402 50X1

Código: 49945
 Fábrica: BAZZE SIX
 Unidade: CX/50
 F1 F4



CANETA ESF 1.0MM HEXAG PRETA 3396 50X1

Código: 49946
 Fábrica: BAZZE SIX
 Unidade: CX/50
 F1 F4

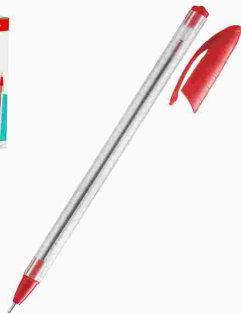

CANETA ESF 1.0MM HEXAG VERMEL 419 50X1

Código: 49944
 Fábrica: BAZZE SIX
 Unidade: CX/50
 F1 F4



CANETA ESF 1.0MM HYPER COLOR 97921 10X1

Código: 46357
 Fábrica: JOCAROFFICE
 Unidade: CT/10
 F1 F4



CANETA ESF 1.0MM JET LUX 8X1

Código: 48154
 Fábrica: COMPACTOR
 Unidade: CR/8
 F1 F4



CANETA ESF 1.0MM OURO 12X1

Código: 8456
 Fábrica: CIS
 Unidade: DZ/12
 F1 F4



CANETA ESF 1.0MM OURO/PRATA 1415 24X1

Código: 49952
 Fábrica: BAZZE WAVE
 Unidade: CX/24
 F1 F4



CANETA ESF 1.0MM PEROLA 4 CORES 4X1

Código: 20678
 Fábrica: INJEX PEN
 Unidade: PT/4
 F1 F4



CANETA ESF 1.0MM PONTA MED AZUL 50X1

Código: 20621
 Fábrica: INJEX PEN
 Unidade: CX/50
 F1 F4



CANETA ESF 1.0MM PONTA MED AZ/VM/PT 3X1

Código: 47259
 Fábrica: INJEX PEN
 Unidade: PT/3
 F1 F4



CANETA ESF 1.0MM PONTA MED PRETA 50X1

Código: 20618
 Fábrica: INJEX PEN
 Unidade: CX/50
 F1 F4



CANETA ESF 1.0MM PONTA MED VERMELHA 50X1

Código: 20620
 Fábrica: INJEX PEN
 Unidade: CX/50
 F1 F4



CANETA ESF 1.0MM PRATA 12X1

Código: 48348
 Fábrica: CIS
 Unidade: DZ/12
 F1 F4



CANETA ESF 1.0MM TENDENCE 98146 10X1

Código: 46390
 Fábrica: KAZ
 Unidade: CT/10
 F1 F4



CANETA ESF 1.0MM 4 CORES MED 12X1

Código: **50124** Fábrica: **BIC** Unidade: **CX/12 F1 F4**



CANETA ESF 1.2MM 4 CORES MED FASHION

Código: **6895** Fábrica: **BIC** Unidade: **CR/4 F1 F4**



CANETA EXECUTIVA ATENA ESCRITA PRETA CX

Código: **47910** Fábrica: **YIN'S PAPER** Unidade: **UN/1 F1 F4**



CANETA FIXA METAL C/CORRENTE CTL 234

Código: **46781** Fábrica: **CARBRINK** Unidade: **CR/1 F1 F4**



CANETA FLAIR BOLD 1.2MM PONTA POROSA 6X1

Código: **48209** Fábrica: **PAPER MATE** Unidade: **CR/6 F1 F4**



CANETA GEL GLITTER 1.0MM COLOR 980 6X1

Código: **41900** Fábrica: **LYKE** Unidade: **CR/6 F1 F4**



CANETA GEL GLITTER 1,0MM PRATA 1120 12X1

Código: **42593** Fábrica: **JOCAROFFICE** Unidade: **CR/12 F1 F4**



CANETA GEL GLITTER 1.0MM PRATA 12X1

Código: **41932** Fábrica: **TRIS** Unidade: **CR/12 F1 F4**



CANETA GEL GLITTER 1.0MM SORT 97933 40X1

Código: **46159** Fábrica: **JOCAROFFICE** Unidade: **PT/40 F1 F4**



CANETA GEL METAL 0.7MM OURO/PRATA UN

Código: **42830** Fábrica: **JOCAROFFICE** Unidade: **UN/1 F1 F4**



CANETA GEL NEON 1.0MM COLOR 966 6X1

Código: **41901** Fábrica: **LYKE** Unidade: **CR/6 F1 F4**



CANETA GEL 0.5 MM APAGAVEL AZUL 251 12X1

Código: **48169** Fábrica: **MJ** Unidade: **CX/12 F1 F4**



CANETA GEL 0.5 MM APAGAVEL AZUL 606 12X1

Código: **48167** Fábrica: **MJ** Unidade: **CX/12 F1 F4**



CANETA GEL 0.5 MM APAGAVEL AZUL 998 12X1

Código: **48168** Fábrica: **MJ** Unidade: **CX/12 F1 F4**



CANETA GEL 0.55 MM POP UP 97924 8X1

Código: **46360** Fábrica: **JOCAROFFICE** Unidade: **CT/8 F1 F4**



CANETA GEL 0.7 MM HAPPY 5 CORES 50X1

Código: **46366** Fábrica: **JOCAROFFICE** Unidade: **PT/50 F1 F4**



CANETA GEL 0.7 MM RAINBOW 6 CORES 50X1
 Código: 46365 Fábrica: JOCAROFFICE Unidade: PT/50
 F1 F4



CANETA GEL 0.7 MM RAINBOW 97936 6X1
 Código: 46359 Fábrica: JOCAROFFICE Unidade: CT/6
 F1 F4



CANETA GEL 1.0 MM CORES 232214 8X1
 Código: 46384 Fábrica: FUTURO Unidade: CT/8
 F1 F4



CANETA GEL 1.0MM GLITTER 98121 10X1
 Código: 46393 Fábrica: KAZ Unidade: CT/10
 F1 F4



CANETA GEL 1.0MM GLITTER 98152 6X1
 Código: 46392 Fábrica: KAZ Unidade: CT/5
 F1 F4



CANETA HIDROG 0.4 MM 6 CORES 6183
 Código: 40676 Fábrica: GOLLER Unidade: CR/6
 F1 F4



CANETA HIDROG 0.4 FINELINER AZUL ES 12X1
 Código: 43607 Fábrica: BRW Unidade: PT/12
 F1 F4



CANETA HIDROG 0.4 FINELINER PINK NE 12X1
 Código: 44992 Fábrica: BRW Unidade: PT/12
 F1 F4



CANETA HIDROG 0.4 FINELINER PRETO 12X1
 Código: 44991 Fábrica: BRW Unidade: PT/12
 F1 F4



CANETA HIDROG 0.4 FINELINER SORT 6X1
 Código: 46827 Fábrica: BRW Unidade: PT/6
 F1 F4



CANETA HIDROGRAFICA BIG 12 CORES 4585
 Código: 42590 Fábrica: LEO&LEO Unidade: CR/1
 F1 F4



CANETA KILOMETRICA 0.7MM AZUL 12X1
 Código: 45522 Fábrica: PAPER MATE Unidade: CX/12
 F1 F4



CANETA KILOMETRICA 0.7MM AZUL 50X1
 Código: 29037 Fábrica: PAPER MATE Unidade: CX/50
 F1 F4



CANETA KILOMETRICA 0.7MM PRETA 50X1
 Código: 29038 Fábrica: PAPER MATE Unidade: CX/50
 F1 F4



CANETA KILOMETRICA 0.7MM PRETO 12X1
 Código: 45523 Fábrica: PAPER MATE Unidade: CX/12
 F1 F4



CANETA KILOMETRICA 0.7MM VERMELHO 50X1
 Código: 29908 Fábrica: PAPER MATE Unidade: CX/50
 F1 F4



CANETA KILOMETRICA 1.0MM AZUL 50X1
 Código: 26807 Fábrica: PAPER MATE Unidade: CX/50
 F1 F4



CANETA KILOMETRICA 1.0MM COLOR 4X1
 Código: 29841 Fábrica: PAPER MATE Unidade: PT/4
 F1 F4



CANETA KILOMETRICA 1.0MM COLOR 8X1
 Código: 26805 Fábrica: PAPER MATE Unidade: PT/8
 F1 F4



CANETA KILOMETRICA 1.0MM COLOR 10X1
 Código: 45521 Fábrica: PAPER MATE Unidade: PT/10
 F1 F4



CANETA KILOMETRICA 1.0MM COLOR 24X1
 Código: 26787 Fábrica: PAPER MATE Unidade: PT/24
 F1 F4



CANETA KILOMETRICA 1.0MM POP AZUL 60X1
 Código: 45524 Fábrica: PAPER MATE Unidade: CX/60
 F1 F4



CANETA KILOMETRICA 1.0MM POP PRETA 60X1
 Código: 45525 Fábrica: PAPER MATE Unidade: CX/60
 F1 F4



CANETA KILOMETRICA 1.0MM POP VERMEL 60X1
 Código: 45526 Fábrica: PAPER MATE Unidade: CX/60
 F1 F4



CANETA KILOMETRICA 1.0MM RETR AZUL 12X1
 Código: 48208 Fábrica: PAPER MATE Unidade: CX/12
 F1 F4



CANETA KILOMETRICA 1.0MM RETR AZUL 12X1
 Código: 41619 Fábrica: PAPER MATE Unidade: CX/12
 F1 F4



CANETA KILOMETRICA 1.0MM VERMELHA 50X1
 Código: 26806 Fábrica: PAPER MATE Unidade: CX/50
 F1 F4



CANETA MARC PERMANENTE COSMIC COLOR 5X1
 Código: 48217 Fábrica: SHARPIE Unidade: CR/5
 F1 F4



CANETA MARC PERMANENTE FINA PRATA CTL
 Código: 48214 Fábrica: SHARPIE Unidade: CR/1
 F1 F4



CANETA MARC PERMANENTE FINA PRETO CTL
 Código: 48218 Fábrica: SHARPIE Unidade: CR/1
 F1 F4



CANETA MARC PERMANENTE FINA VERM 12X1
 Código: 48215 Fábrica: SHARPIE Unidade: CX/12
 F1 F4



CANETA MARC PERMANENTE 8 CORES BRUSH TIP
 Código: 48219 Fábrica: SHARPIE Unidade: CR/8
 F1 F4



CANETA MARCA CD/DVD PONT DUPLA AZUL 12X1
 Código: 49956 Fábrica: BAZZE Unidade: DZ/12 F1 F4



CANETA MARCA CD/DVD PONT DUPLA PTO 12X1
 Código: 49957 Fábrica: BAZZE Unidade: DZ/12 F1 F4



CANETA MARCA CD/DVD/RETROP VERDE 12X1
 Código: 43741 Fábrica: FIX PAPER Unidade: DZ/12 F1 F4



CANETA MARCA CD/RETROPROJ VERMELHA 12X1
 Código: 24884 Fábrica: ONDA Unidade: DZ/12 F1 F4



CANETA MARCADOR TECIDO PERM 501 AZUL
 Código: 41765 Fábrica: ACRILEX Unidade: UN/1 F1 F4



CANETA MARCADOR TECIDO PERM 503 AZUL
 Código: 43538 Fábrica: ACRILEX Unidade: UN/1 F1 F4



CANETA MARCADOR TECIDO PERM 507 VERMELH
 Código: 41768 Fábrica: ACRILEX Unidade: UN/1 F1 F4



CANETA MARCADOR TECIDO PERM 510 VERDE
 Código: 44976 Fábrica: ACRILEX Unidade: UN/1 F1 F4



CANETA MARCADOR TECIDO PERM 513 VERDE
 Código: 41764 Fábrica: ACRILEX Unidade: UN/1 F1 F4



CANETA MARCADOR TECIDO PERM 516 VIOLETA
 Código: 44975 Fábrica: ACRILEX Unidade: UN/1 F1 F4



CANETA MARCADOR TECIDO PERM 517 LARANJA
 Código: 44974 Fábrica: ACRILEX Unidade: UN/1 F1 F4



CANETA MARCADOR TECIDO PERM 520 PRETO
 Código: 41767 Fábrica: ACRILEX Unidade: UN/1 F1 F4



CANETA MARCADOR TECIDO PERM 531 MARROM
 Código: 43539 Fábrica: ACRILEX Unidade: UN/1 F1 F4



CANETA MARCADOR TECIDO PERM 537 ROSA
 Código: 44973 Fábrica: ACRILEX Unidade: UN/1 F1 F4



CANETA MARCADOR TECIDO PERM 565 VINHO
 Código: 43540 Fábrica: ACRILEX Unidade: UN/1 F1 F4



CANETA MARCADOR TECIDO PRETO 4917015
 Código: 46846 Fábrica: ONDA Unidade: CR/1 F1 F4



CANETA 0.4MM MARCA CD/DVD/RETR 7530 12X1
 Código: 48148 Fábrica: YIN'S PAPER Unidade: DZ/12 F1 F4



CANETA 0.4MM MICROLINE SORT 6X1
 Código: 48155 Fábrica: COMPACTOR Unidade: CR/6 F1 F4



CANETA 0.4MM MICROLINE SORT 10X1
 Código: 48156 Fábrica: COMPACTOR Unidade: CR/10 F1 F4



CANETA 0.4MM MICROLINE SORT 12X1
 Código: 35993 Fábrica: COMPACTOR Unidade: CR/12 F1 F4



CANETA 0.4MM MICROLINER AMAREL 7409 10X1
 Código: 48301 Fábrica: YIN'S PAPER Unidade: CX/10 F1 F4



CANETA 0.4MM MICROLINER LILAS 7379 10X1
 Código: 47922 Fábrica: YIN'S PAPER Unidade: CX/10 F1 F4



CANETA 0.4MM MICROLINER ROSA 7378 10X1
 Código: 47920 Fábrica: YIN'S PAPER Unidade: CX/10 F1 F4



CANETA 0.4MM MICROLINER VERDE 7380 10X1
 Código: 47921 Fábrica: YIN'S PAPER Unidade: CX/10 F1 F4



CANETA 0.4MM MICROLINER VERMEL 7377 10X1
 Código: 47919 Fábrica: YIN'S PAPER Unidade: CX/10 F1 F4



CANETA 1.0MM COLOR 5X1
 Código: 46278 Fábrica: MOLIN Unidade: CR/5 F1 F4



CANETINHA HIDR NEO PEN GIG 12 CORES
 Código: 6897 Fábrica: COMPACTOR Unidade: CX/1 F1 F4



CANETINHA HIDR NEO PEN GIG 24 CORES UN
 Código: 47862 Fábrica: COMPACTOR Unidade: CX/1 F1 F4



CANETINHA HIDR NEO PEN MIRIM 06 CORES
 Código: 45062 Fábrica: COMPACTOR Unidade: CX/1 F1 F4



CANETINHA HIDR NEO PEN MIRIM 12 CORES
 Código: 45061 Fábrica: COMPACTOR Unidade: CX/1 F1 F4



CANETINHA HIDR PQ GROSSA 07 CORES CS-007
 Código: 45221 Fábrica: MCAVM Unidade: PT/7 F1 F4



CANETINHA HIDROCOR 6 CORES 614878
 Código: 49958 Fábrica: BAZZE WAVE Unidade: CR/1 F1 F4



CANETINHA HIDROCOR 12 CORES UN 614816

Código: 49959 Fábrica: BAZZE WAVE Unidade: CR/1 F1 F4



CANETINHA HIDROCOR 24 CORES WAVE CTL

Código: 41933 Fábrica: TRIS Unidade: CT/1 F1 F4



CANETINHA HIDROCOR 24 CORES 6X1

Código: 38256 Fábrica: WALEU Unidade: PT/6 F1 F4



CANETINHA HIDROGRAFICA 06 CORES 720

Código: 41649 Fábrica: LEO&LEO Unidade: CR/1 F1 F4



CANETINHA HIDROGRAFICA 12 CORES 12X1

Código: 49270 Fábrica: COLORARE Unidade: PT/12 F1 F4

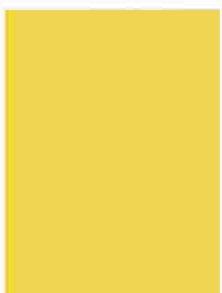

CAPA LINE A4 FRENTE AMARELO ENCAD 100X1

Código: 30450 Fábrica: LASSANE Unidade: PT/100 F1 F4



CAPA LINE A4 FRENTE AZUL ENCAD 100X1

Código: 30452 Fábrica: LASSANE Unidade: PT/100 F1 F4

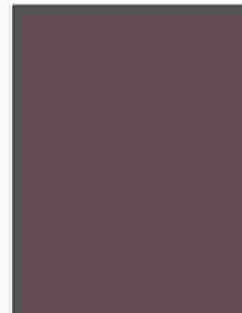

CAPA LINE A4 FRENTE FUME ENCAD 100X1

Código: 36622 Fábrica: LASSANE Unidade: PT/100 F1 F4



CAPA LINE A4 FRENTE INCOLOR ENCAD 100X1

Código: 8955 Fábrica: LASSANE Unidade: PT/100 F1 F4



CAPA LINE A4 FRENTE ROSA ENCAD 100X1

Código: 36621 Fábrica: LASSANE Unidade: PT/100 F1 F4



CAPA LINE A4 FRENTE VERMELHO ENCAD 100X1

Código: 30453 Fábrica: LASSANE Unidade: PT/100 F1 F4



CAPA LINE A4 FUNDO AMARELO ENCAD 10X1

Código: 30451 Fábrica: LASSANE Unidade: PT/100 F1 F4



CAPA LINE A4 FUNDO AZUL ENCAD 100X1

Código: 30454 Fábrica: LASSANE Unidade: PT/100 F1 F4

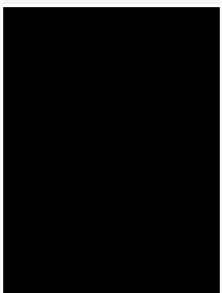

CAPA LINE A4 FUNDO PRETO ENCAD 100X1

Código: 8957 Fábrica: LASSANE Unidade: PT/100 F1 F4



CAPA LINE A4 FUNDO VERDE ENCAD 100X1

Código: 30456 Fábrica: LASSANE Unidade: PT/100 F1 F4



CAPA LINE A4 FUNDO VERMELHO ENCAD 100X1

Código: 30455 Fábrica: LASSANE Unidade: PT/100 F1 F4



CAPA LINE OF2 FRENTE INCOLOR ENCAD 100X1
 Código: 41849 Fábrica: LASSANE Unidade: PT/100
 F1 F4

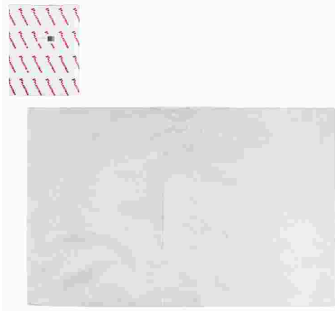

CAPA P/CADERNO BROCHURAO TRANSP 50X1
 Código: 21621 Fábrica: PLASTIBAN Unidade: PT/50
 F1 F4

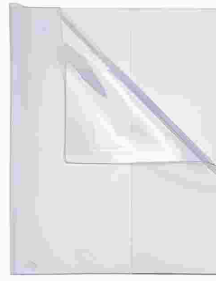

CAPA P/CADERNO CD 1/4 48/96 FLS HP3 50X1
 Código: 41284 Fábrica: HP PLAST Unidade: PT/50
 F1 F4

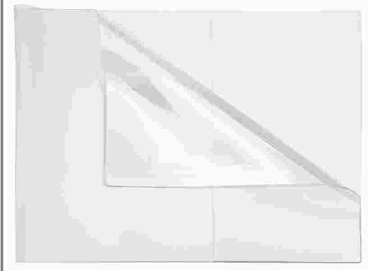

CAPA P/CADERNO DESENHO SOLTA HP25 50X1
 Código: 41282 Fábrica: HP PLAST Unidade: PT/50
 F1 F4



CAPA P/CADERNO UNIVERSITARIO TRANSP 50X1
 Código: 21623 Fábrica: PLASTIBAN Unidade: PT/50
 F1 F4



CAPA P/CADERNO 1/4 48/96 FLS HP2 50X1
 Código: 41283 Fábrica: HP PLAST Unidade: PT/50
 F1 F4



CARBONO COST 44X66CM RISC/BOR AMAR 100X1
 Código: 48067 Fábrica: PRINTERS Unidade: CE/100
 F1 F4



CARBONO COST 44X66CM RISC/BOR AZUL 100X1
 Código: 48066 Fábrica: PRINTERS Unidade: CE/100
 F1 F4



CARBONO COST 44X66CM RISC/BOR BCO 100X1
 Código: 48068 Fábrica: PRINTERS Unidade: CE/100
 F1 F4

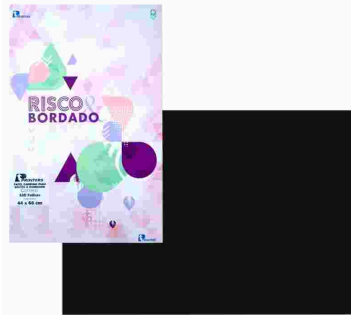

CARBONO COST 44X66CM RISC/BOR PTO 100X1
 Código: 48069 Fábrica: PRINTERS Unidade: CE/100
 F1 F4



CARBONO COST 44X66CM RISC/BOR VERM 100X1
 Código: 50833 Fábrica: PRINTERS Unidade: CE/100
 F1 F4



CARBONO DUPLA FACE AZUL 5861 100X1
 Código: 22898 Fábrica: GOLLER Unidade: CX/100
 F1 F4



CARBONO DUPLA FACE AZUL 98688 100X1
 Código: 48323 Fábrica: BAZZE Unidade: CX/100
 F1 F4



CARBONO DUPLA FACE ROXO 17139 100X1
 Código: 41926 Fábrica: TRIS Unidade: CX/100
 F1 F4



CARBONO FILM AZUL 1 FACE 100X1
 Código: 6845 Fábrica: KORES Unidade: CE/100
 F1 F4



CARBONO P/RISCO 33X44CM AZUL 2602 12X1
 Código: 45504 Fábrica: GLIART Unidade: PT/12
 F1 F4

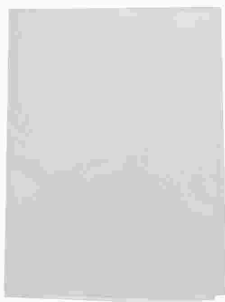

CARBONO P/RISCO 33X44CM BRANCO 2601 12X1
 Código: 36251 Fábrica: GLIART Unidade: PT/12 F1 F4

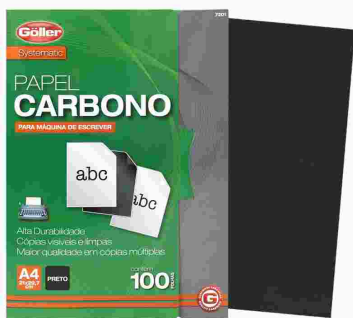

CARBONO 1 FACE PRETO A4 100X1
 Código: 6844 Fábrica: GRAMP LINE Unidade: PT/100 F1 F4



CARIMBO AUTOM AUTO ENTINTAD 14X38MM 2501
 Código: 46649 Fábrica: CARBRINK Unidade: UN/1 F1 F4



CARIMBO AUTOM AUTO ENTINTAD 18X47MM 2521
 Código: 50134 Fábrica: CARBRINK Unidade: UN/1 F1 F4



CARIMBO AUTOM AUTO ENTINTAD 60X40MM 2521
 Código: 50987 Fábrica: CARBRINK Unidade: UN/1 F1 F4



CARIMBO AUTOM NUMERADOR 6 DIG
 Código: 49177 Fábrica: CARBRINK Unidade: UN/1 F1 F4



CARIMBO ENTINTADO INF NUMEROS 10X1
 Código: 41974 Fábrica: VMP Unidade: UN/1 F1 F4



CARIMBO ENTINTADO INF SORT 2 26X1
 Código: 46010 Fábrica: VMP Unidade: CX/26 F1 F4



CARIMBO ENTINTADO INF SORT 3 26X1
 Código: 46011 Fábrica: VMP Unidade: CX/26 F1 F4



CARIMBOS ALFABETO MAD 28PCS 50932
 Código: 49529 Fábrica: XALINGO Unidade: UN/1 F1 F4



CARIMBOS ANIMAIS SITIO MAD C/GIZ 50787
 Código: 49554 Fábrica: XALINGO Unidade: UN/1 F1 F4



CARIMBOS FOFOSAURUS MAD C/GIZ CER 54287
 Código: 49527 Fábrica: XALINGO Unidade: UN/1 F1 F4



CARIMBOS LETRAS E NUMEROS MAD 40PC 50910
 Código: 49528 Fábrica: XALINGO Unidade: UN/1 F1 F4



CARIMBOS VOGAIS MAD MINHA ESCOLINHA 1543
 Código: 49821 Fábrica: XALINGO Unidade: UN/1 F1 F4



CARNE GPS (GUIA PREVIDENCIA SOCIAL) 20X1
 Código: 24938 Fábrica: PARRKE Unidade: PT/20 F1 F4



CARTA COBRANCA 100X1
 Código: 1330 Fábrica: UNICART Unidade: CE/100 F1 F4



CARTAO G-11 REF 155 BODAS 10X1

Código: 5129 Fábrica: UNICART Unidade: PT/10 F1 F4

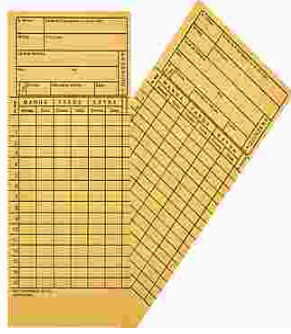

CARTAO PONTO MENSAL SIMPLES 100X1

Código: 27101 Fábrica: GRIFFE Unidade: PT/100 F1 F4



CARTAZ ALUGA-SE 157X320MM 50X1

Código: 39289 Fábrica: TAMOIO Unidade: PT/50 F1 F4



CARTAZ VENDE-SE 157X320MM 50X1

Código: 39290 Fábrica: TAMOIO Unidade: PT/50 F1 F4

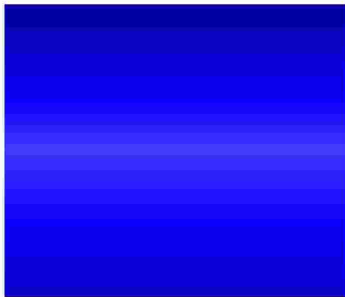

CARTOLINA LAMINADA 48X58CM AZUL 20X1

Código: 12804 Fábrica: EMBALE Unidade: PT/20 F1 F4



CARTOLINA LAMINADA 48X58CM OURO 20X1

Código: 12805 Fábrica: EMBALE Unidade: PT/20 F1 F4

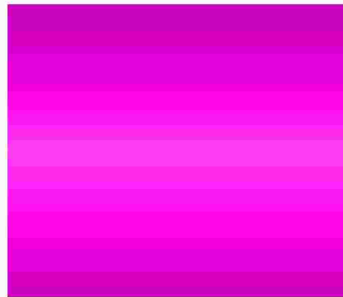

CARTOLINA LAMINADA 48X58CM PINK 20X1

Código: 12806 Fábrica: EMBALE Unidade: PT/20 F1 F4

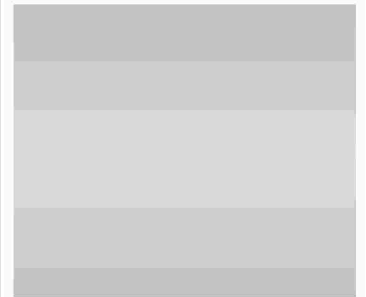

CARTOLINA LAMINADA 48X58CM PRATA 20X1

Código: 7134 Fábrica: EMBALE Unidade: PT/20 F1 F4



CARTOLINA LAMINADA 48X58CM VERDE 20X1

Código: 12807 Fábrica: EMBALE Unidade: PT/20 F1 F4

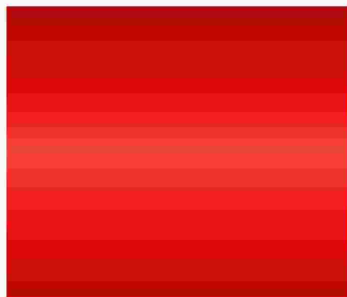

CARTOLINA LAMINADA 48X58CM VERMELHO 20X1

Código: 12808 Fábrica: EMBALE Unidade: PT/20 F1 F4



CARTOLINA SORTIDA 100X1

Código: 29236 Fábrica: MINASPEL Unidade: CE/100 F1 F4



CARTOLINA 47X65CM AMARELA 100X1

Código: 13184 Fábrica: MINASPEL Unidade: CE/100 F1 F4



CARTOLINA 47X65CM AZUL 100X1

Código: 13186 Fábrica: MINASPEL Unidade: CE/100 F1 F4



CARTOLINA 47X65CM BRANCA 100X1

Código: 838 Fábrica: MINASPEL Unidade: CE/100 F1 F4



CARTOLINA 47X65CM ROSA 100X1

Código: 13185 Fábrica: MINASPEL Unidade: CE/100 F1 F4



CARTOLINA 47X65CM VERDE 100X1

Código: 13187 Fábrica: MINASPEL Unidade: CE/100 F1 F4



71cm

CAVALETE P/TELA PINTURA NEO 071 CM 9922

Código: **47878** Fábrica: **STALO** Unidade: **UN/1**
F1 F4



CD-R GRAVAVEL 80 MIN 700 MB 50X1

Código: **18272** Fábrica: **MAKETECH** Unidade: **PT/50**
F1 F4



CHAVEIRO E ETIQUETA CORES C/SUORTE 8X1

Código: **48056** Fábrica: **MAXCRIL** Unidade: **CR/8**
F1 F4



CHAVEIRO E ETIQUETA CORES POTE 120X1

Código: **40483** Fábrica: **ACRINIL** Unidade: **C//120**
F1 F4



CHAVEIRO E ETIQUETA CORES POTE 48X1

Código: **46742** Fábrica: **KAZ** Unidade: **C//48**
F1 F4



CHAVEIRO E ETIQUETA CORES POTE 60X1

Código: **40482** Fábrica: **ACRIMET** Unidade: **C//60**
F1 F4



CHAVEIRO E ETIQUETA CRISTAL POTE 120X1

Código: **46008** Fábrica: **ACRINIL** Unidade: **C//120**
F1 F4



CHAVEIRO E ETIQUETA CRISTAL POTE 24X1

Código: **46007** Fábrica: **ACRINIL** Unidade: **C//24**
F1 F4



CLAVICULARIO UN

Código: **43476** Fábrica: **MENNO** Unidade: **UN/1**
F1 F4



CLIPS 0 METAL P/PAPEL 500 GRS

Código: **11059** Fábrica: **BRW** Unidade: **CX/1**
F1 F4



CLIPS 0 METAL P/PAPEL 770X1

Código: **35869** Fábrica: **LVC** Unidade: **CX/770**
F1 F4



CLIPS 1 P/PAPEL 500G

Código: **24776** Fábrica: **GASPER** Unidade: **CX/940**
F1 F4



CLIPS 1/0 METAL P/PAPEL 100X1

Código: **41773** Fábrica: **JUSSARA** Unidade: **CX/100**
F1 F4



CLIPS 1/0 METAL P/PAPEL 100X1

Código: **42187** Fábrica: **BACCHI** Unidade: **CX/100**
F1 F4



CLIPS 1/0 (0) METAL P/PAPEL 770X1

Código: **44183** Fábrica: **BACCHI** Unidade: **CX/770**
F1 F4



CLIPS 2 METAL ORGAN PENSAMENTOS 800X1

Código: **22489** Fábrica: **CHAPARRAU** Unidade: **CX/800**
F1 F4



CLIPS 2 METAL P/PAPEL 28MM 7553 100X1

Código: 48141 Fábrica: YIN'S PAPER Unidade: CX/100 F1 F4

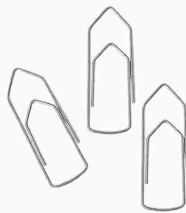

CLIPS 2/0 (0)METAL P/PAPEL APROX 720X1

Código: 27438 Fábrica: BRW Unidade: CX/720 F1 F4

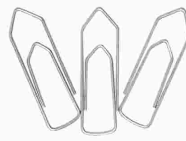

CLIPS 2/0 (00) METAL P/PAPEL 720X1

Código: 44182 Fábrica: BACCHI Unidade: CX/720 F1 F4



CLIPS 3 METAL P/PAPEL 25MM 7552 100X1

Código: 48140 Fábrica: YIN'S PAPER Unidade: CX/100 F1 F4



CLIPS 3 METAL P/PAPEL 500 GRS

Código: 26699 Fábrica: CHAPARRAU Unidade: CX/960 F1 F4



CLIPS 3 METAL P/PAPEL 960X1

Código: 41609 Fábrica: LVC Unidade: CX/960 F1 F4



CLIPS 3/0 METAL P/PAPEL 50X1

Código: 46895 Fábrica: JUSSARA Unidade: CX/50 F1 F4



CLIPS 3/0 METAL P/PAPEL 440X1

Código: 35866 Fábrica: LVC Unidade: CX/440 F1 F4

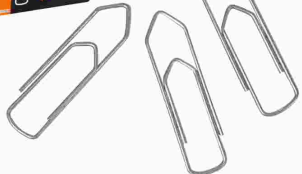

CLIPS 4/0 METAL P/PAPEL 400X1

Código: 35868 Fábrica: LVC Unidade: CX/400 F1 F4

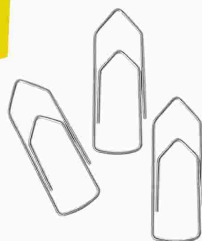

CLIPS 4/0 METAL P/PAPEL 50X1

Código: 43522 Fábrica: TOP Unidade: CX/50 F1 F4



CLIPS 6/0 METAL P/PAPEL 50X1

Código: 46898 Fábrica: JUSSARA Unidade: CX/50 F1 F4

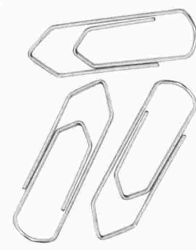

CLIPS 6/0 METAL P/PAPEL 220X1

Código: 46897 Fábrica: JUSSARA Unidade: CX/220 F1 F4



CLIPS 6/0 METAL P/PAPEL 50X1

Código: 42587 Fábrica: BACCHI Unidade: CX/50 F1 F4



CLIPS 8/0 METAL P/PAPEL 170X1

Código: 46899 Fábrica: JUSSARA Unidade: CX/170 F1 F4

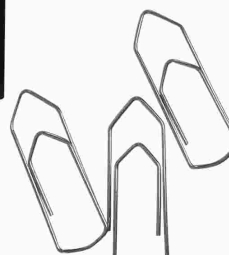

CLIPS 8/0 METAL P/PAPEL 170X1

Código: 35867 Fábrica: CHAPARRAU Unidade: CX/170 F1 F4



CLIPS 8/0 METAL P/PAPEL 170X1

Código: 42664 Fábrica: TOP/BACCHI Unidade: CX/170 F1 F4

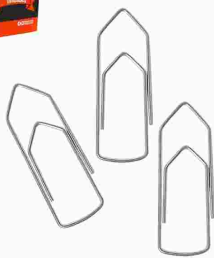

CLIPS 8/0 METAL P/PAPEL 25X1
 Código: 34104 Fábrica: CHAPARRAU Unidade: CX/25
 F1 F4



CLIPS 8/0 METAL P/PAPEL 25X1
 Código: 42743 Fábrica: BACCHI Unidade: CX/25
 F1 F4



CLIPS BINDER 15MM PRETO 292200 60X1
 Código: 46380 Fábrica: FUTURO Unidade: PT/60
 F1 F4



CLIPS BINDER 19MM (PRENDEDOR) COLOR 40X1
 Código: 41931 Fábrica: TRIS Unidade: PT/40
 F1 F4



CLIPS BINDER 25MM COLOR 48X1
 Código: 41930 Fábrica: TRIS Unidade: PT/48
 F1 F4



CLIPS BINDER 32MM PRETO 618913 24X1
 Código: 49940 Fábrica: BAZZE Unidade: PT/24
 F1 F4



CLIPS BINDER 41MM PRETO 292204 24X1
 Código: 46379 Fábrica: FUTURO Unidade: PT/24
 F1 F4



CLIPS BINDER 51MM PRETO 93092 12X1
 Código: 42727 Fábrica: JOCAROFFICE Unidade: PT/12
 F1 F4

2,5 cm



CLIPS MINI 5 GALVANIZADO P/PAPEL 100X1
 Código: 46070 Fábrica: BACCHI Unidade: CX/100
 F1 F4



CLIPS P/PAPEL COLOR 28MM 80207 100X1
 Código: 44541 Fábrica: WIN PAPER Unidade: CX/100
 F1 F4

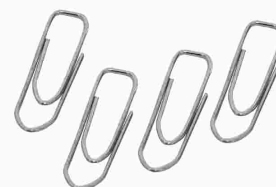

CLIPS P/PAPEL NIQUEL 5 MINI 80193 100X1
 Código: 44743 Fábrica: WIN PAPER Unidade: CX/100
 F1 F4



CLIPS REMOVIVEL JACARE C/ALCA 100X1
 Código: 9732 Fábrica: DAC Unidade: CE/100
 F1 F4

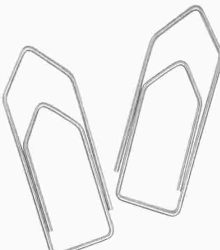

CLIPS 10/0 METAL P/PAPEL 18X1
 Código: 44186 Fábrica: BACCHI Unidade: CX/18
 F1 F4



CLIPS 12/0 METAL P/PAPEL 105X1
 Código: 44188 Fábrica: BACCHI Unidade: CX/105
 F1 F4



CLIPS 12/0 METAL P/PAPEL 12X1
 Código: 44187 Fábrica: BACCHI Unidade: CX/12
 F1 F4



COLA ISOPOR & EVA 90 GRS COLA MAIS 6X1
 Código: 42574 Fábrica: COLA MAIS Unidade: PT/6
 F1 F4



COLA 25 GRS 6 CORES C/GLITER SORT
 Código: 46433 Fábrica: KAZ Unidade: CX/6
 F1 F4



COLA ADESIVO INSTANTANEO 20 GRS UN
 Código: 42934 Fábrica: GLIART Unidade: UN/1
 F1 F4



COLA ADESIVO PVC P/CANO 17 GRS UN
 Código: 50754 Fábrica: TEK BOND Unidade: UN/1
 F1 F4



COLA ADESIVO SPRAY CONTATO 500ML
 Código: 50979 Fábrica: TEK BOND Unidade: UN/1
 F1 F4



COLA BASTAO 10 GRS
 Código: 15350 Fábrica: ACRILEX Unidade: UN/1
 F1 F4



COLA BASTAO 10 GRS 02710 10X1
 Código: 41326 Fábrica: ACRILEX Unidade: PT/10
 F1 F4



COLA BASTAO 10 GRS 10101 12X1
 Código: 41327 Fábrica: GATTE KIDS Unidade: DZ/12
 F1 F4



COLA BASTAO 10 GRS 12X1
 Código: 50031 Fábrica: BAZZE Unidade: CX/12
 F1 F4



COLA BASTAO 20 GRS 12X1
 Código: 50759 Fábrica: MARIPEL Unidade: CX/12
 F1 F4



COLA BASTAO 20 GRS 12X1
 Código: 50032 Fábrica: BAZZE Unidade: CX/12
 F1 F4



COLA BASTAO 40 GRS 6X1
 Código: 50207 Fábrica: BAZZE Unidade: CX/6
 F1 F4



COLA BRANCA 40 GRS UN
 Código: 51069 Fábrica: TEK BOND Unidade: UN/1
 F1 F4



COLA BRANCA 40 GRS 84X1
 Código: 30509 Fábrica: COPLAMIX Unidade: CX/84
 F1 F4



COLA BRANCA 1 KG
 Código: 42575 Fábrica: FIRST Unidade: UN/1
 F1 F4



COLA BRANCA 1 KG EXTRA USO PROFISSIONAL
 Código: 1181 Fábrica: APLICOLA Unidade: UN/1
 F1 F4



COLA BRANCA 1 KG NEW MAGIC
Código: **19689** Fábrica: **NEW MAGIC** Unidade: **UN/1**
F1 F4



COLA BRANCA 100 GRS ACRILEX UN
Código: **40900** Fábrica: **ACRILEX** Unidade: **UN/1**
F1 F4



COLA BRANCA 110 GRS COLA MAIS 6X1
Código: **45152** Fábrica: **COLA MAIS** Unidade: **PT/6**
F1 F4



COLA BRANCA 110 GRS COLA UN
Código: **46511** Fábrica: **COLA MAIS** Unidade: **UN/1**
F1 F4



COLA BRANCA 37 GRS UN
Código: **42019** Fábrica: **ACRILEX** Unidade: **UN/1**
F1 F4



COLA BRANCA 40 GRS COLEX UN
Código: **46797** Fábrica: **INJEX PEN** Unidade: **UN/1**
F1 F4



COLA BRANCA 40 GRS NEW MAGIC 72X1
Código: **30112** Fábrica: **NEW MAGIC** Unidade: **CX/72**
F1 F4



COLA BRANCA 40 GRS UN
Código: **42783** Fábrica: **NEW MAGIC** Unidade: **UN/1**
F1 F4



COLA BRANCA 40 GRS 12X1
Código: **44031** Fábrica: **PALHACINHO** Unidade: **DZ/12**
F1 F4



COLA BRANCA 500 GRS
Código: **3347** Fábrica: **COPLAMIX** Unidade: **UN/1**
F1 F4



COLA BRANCA 500 GRS
Código: **42576** Fábrica: **COLA MAIS** Unidade: **UN/1**
F1 F4



COLA BRANCA 90 GRS NEW MAGIC UN
Código: **50642** Fábrica: **NEW MAGIC** Unidade: **UN/1**
F1 F4



COLA BRANCA 90 GRS NEW MAGIC 48X1
Código: **35872** Fábrica: **NEW MAGIC** Unidade: **CX/48**
F1 F4



COLA BRANCA 90 GRS NEW MAGIC 6X1
Código: **27904** Fábrica: **NEW MAGIC** Unidade: **CX/6**
F1 F4



COLA BRANCA 90 GRS UN
Código: **51070** Fábrica: **TEK BOND** Unidade: **UN/1**
F1 F4



COLA BRANCA 90 GRS 12X1
Código: **19086** Fábrica: **PALHACINHO** Unidade: **PT/12**
F1 F4



COLA BRANCA 90 GRS 6X1
 Código: 39834 Fábrica: COLA MAIS/IR Unidade: PT/6 F1 F4



COLA BRILHANTE VERD C/GLITER 25 GRS 4X1
 Código: 5826 Fábrica: APLICOLA Unidade: CX/4 F1 F4



COLA BRILHANTE 6 COR SORT C/GLIT 25 GRS
 Código: 3352 Fábrica: APLICOLA Unidade: CX/6 F1 F4



COLA C/GLITER 25 GRS 6 CORES SORT
 Código: 46256 Fábrica: COLA MAIS Unidade: CX/6 F1 F4



COLA COLORIDA 23 GRS 4 CORES SORT
 Código: 45280 Fábrica: ACRILEX Unidade: CX/4 F1 F4



COLA COLORIDA 23 GRS 6 CORES SORT
 Código: 19855 Fábrica: ACRILEX Unidade: CX/6 F1 F4



COLA EVA E ISOPOR 35 GRS UN
 Código: 48424 Fábrica: ACRILEX Unidade: UN/1 F1 F4



COLA GEL 120 ML DECOUPAGE MULTICOLOR 18112
 Código: 44819 Fábrica: ACRILEX Unidade: UN/1 F1 F4



COLA GEL 60 GRS DECOUPAGE MULTICOLAG 1816
 Código: 43612 Fábrica: ACRILEX Unidade: UN/1 F1 F4



COLA INSTAN 20 GRS ALTA VISCOSIDAD 12X1
 Código: 47928 Fábrica: YIN'S PAPER Unidade: CX/12 F1 F4



COLA INSTAN 20 GRS ARTESANATO N1 10X1
 Código: 48639 Fábrica: TEK BOND Unidade: CX/10 F1 F4



COLA INSTAN 20 GRS ARTESANATO N2 10X1
 Código: 48640 Fábrica: TEK BOND Unidade: CX/10 F1 F4



COLA INSTAN 20 GRS ARTESANATO N3 10X1
 Código: 48641 Fábrica: TEK BOND Unidade: CX/10 F1 F4



COLA ISOPOR & EVA 35 GRS COLA MAIS 6X1
 Código: 39833 Fábrica: COLA MAIS Unidade: PT/6 F1 F4



COLA MADEIRA 100 GRS UN
 Código: 50720 Fábrica: TEK BOND Unidade: UN/1 F1 F4



COLA PANO 35 GRS 16812 UN
 Código: 44822 Fábrica: ACRILEX Unidade: UN/1 F1 F4



COLA PANO 37 GRS 16840 UN
 Código: 45497 Fábrica: ACRILEX Unidade: UN/1
 F1 F4



COLA PANO 100 GRS (TECIDO) UN
 Código: 45402 Fábrica: ACRILEX Unidade: UN/1
 F1 F4



COLA PERMANENTE 250 GRS UN
 Código: 50266 Fábrica: ACRILEX Unidade: UN/1
 F1 F4



COLA PERMANENTE 37 GRS UN
 Código: 42950 Fábrica: ACRILEX Unidade: UN/1
 F1 F4



COLA PERMANENTE 37 GRS UN
 Código: 50733 Fábrica: TEK BOND Unidade: UN/1
 F1 F4



COLA QUENTE FINA REFIL 175 8X1
 Código: 30471 Fábrica: FUTURO Unidade: PT/8
 F1 F4



COLA QUENTE GROSSA REFIL 176 5X1
 Código: 50225 Fábrica: FUTURO Unidade: PT/5
 F1 F4



COLA QUENTE 1 KG FINA REFIL APROX 77X1
 Código: 5953 Fábrica: PLANETA Unidade: KG/1
 F1 F4



COLA QUENTE 1 KG FINA REFIL 84X1
 Código: 50027 Fábrica: BAZZE Unidade: KG/1
 F1 F4



COLA QUENTE 1 KG GROSSA REFIL APROX 32X1
 Código: 46425 Fábrica: KAZ Unidade: KG/1
 F1 F4

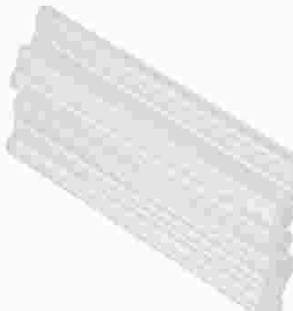

COLA QUENTE 1 KG GROSSA REFIL APROX 32X1
 Código: 3016 Fábrica: IB/REN/FU/PL Unidade: KG/1
 F1 F4



COLA SILICONE LIQUIDA 100ML UN
 Código: 31876 Fábrica: LEO&LEO Unidade: UN/1
 F1 F4



COLA SILICONE LIQUIDA 54 GRS UN
 Código: 48950 Fábrica: LEO&LEO Unidade: UN/1
 F1 F4



COLA SILICONE LIQUIDA 54 GRS 60ML 6X1
 Código: 50029 Fábrica: BAZZE Unidade: CX/6
 F1 F4



COLA SILICONE LIQUIDA 60 GRS 0060 12X1
 Código: 33685 Fábrica: BRW Unidade: CX/12
 F1 F4



COLA SILICONE LIQUIDA 90 GRS 100ML 12X1
 Código: 41705 Fábrica: LEO&LEO Unidade: CX/12
 F1 F4



COLA SILICONE LIQUIDA 90 GRS 100ML 6X1
 Código: 50030 Fábrica: BAZZE Unidade: CX/6
 F1 F4



COLA SUPER COLA TP SUP BOND 3 GRS 12X1
 Código: 21631 Fábrica: WINMAX/HAI Unidade: CR/12
 F1 F4



COLA TEK BOND INSTAN 2 GRS BLISTER UN
 Código: 51068 Fábrica: TEK BOND Unidade: CR/1
 F1 F4



COLA TRANSP ECOLOGICA 1 KG APLICOLA
 Código: 45578 Fábrica: APLICOLA Unidade: UN/1
 F1 F4



COLA TRANSP ECOLOGICA 40 GRS APLIC 72X1
 Código: 30111 Fábrica: APLICOLA Unidade: CX/72
 F1 F4



COLA TRANSP 90 GRS ECOLOGICA APLIC 48X1
 Código: 36330 Fábrica: APLICOLA Unidade: CX/48
 F1 F4



COLA TRANSPARENTE 37 GRS 19937
 Código: 21340 Fábrica: ACRILEX Unidade: UN/1
 F1 F4



COLA 35 GRS C/GLITTER 102 AMARELO LIMA
 Código: 47787 Fábrica: ACRILEX Unidade: UN/1
 F1 F4



COLA 35 GRS C/GLITTER 105 LARANJA
 Código: 47788 Fábrica: ACRILEX Unidade: UN/1
 F1 F4



COLA 35 GRS C/GLITTER 201 AMARELO OURO
 Código: 47789 Fábrica: ACRILEX Unidade: UN/1
 F1 F4



COLA 35 GRS C/GLITTER 202 PRATA
 Código: 47790 Fábrica: ACRILEX Unidade: UN/1
 F1 F4



COLA 35 GRS C/GLITTER 204 AZUL
 Código: 47791 Fábrica: ACRILEX Unidade: UN/1
 F1 F4



COLA 35 GRS C/GLITTER 205 VERMELHO
 Código: 47792 Fábrica: ACRILEX Unidade: UN/1
 F1 F4



COLA 35 GRS C/GLITTER 206 VERDE BANDEIRA
 Código: 47793 Fábrica: ACRILEX Unidade: UN/1
 F1 F4



COLA 35 GRS C/GLITTER 207 VIOLETA
 Código: 47794 Fábrica: ACRILEX Unidade: UN/1
 F1 F4



COLA 35 GRS C/GLITTER 209 CRISTAL
 Código: 47795 Fábrica: ACRILEX Unidade: UN/1
 F1 F4



COLA 35 GRS C/GLITTER 221 CEU ESTRELADO
 Código: 47796 Fábrica: ACRILEX Unidade: UN/1
 F1 F4



COLA 35 GRS C/GLITTER 527 PINK
 Código: 47797 Fábrica: ACRILEX Unidade: UN/1
 F1 F4



COLA 35 GRS C/GLITTER 528 LILAS
 Código: 47798 Fábrica: ACRILEX Unidade: UN/1
 F1 F4



COLCHETE LATONADO N02 1,6CM 40FLS 72X1
 Código: 47228 Fábrica: FIX PAPER Unidade: CX/72
 F1 F4



COLCHETE LATONADO N03 1,7CM 60FLS 72X1
 Código: 47229 Fábrica: FIX PAPER Unidade: CX/72
 F1 F4

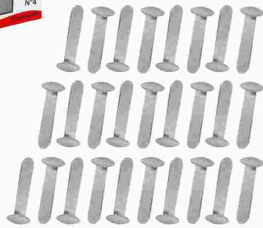

COLCHETE LATONADO N04 2,2CM 80FLS 72X1
 Código: 47230 Fábrica: FIX PAPER Unidade: CX/72
 F1 F4



COLCHETE LATONADO N05 2,6CM 110FLS 72X1
 Código: 47231 Fábrica: FIX PAPER Unidade: CX/72
 F1 F4



COLCHETE LATONADO N06 2,8CM 120FLS 72X1
 Código: 47232 Fábrica: FIX PAPER Unidade: CX/72
 F1 F4

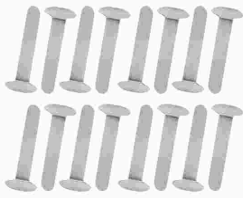

COLCHETE LATONADO N07 3,2CM 140FLS 72X1
 Código: 47233 Fábrica: FIX PAPER Unidade: CX/72
 F1 F4



COLCHETE LATONADO N08 4CM 180FLS 72X1
 Código: 47234 Fábrica: FIX PAPER Unidade: CX/72
 F1 F4



COLCHETE LATONADO N09 4,5CM 200FLS 72X1
 Código: 47235 Fábrica: FIX PAPER Unidade: CX/72
 F1 F4



COLCHETE LATONADO N10 5CM 210FLS 72X1
 Código: 47236 Fábrica: FIX PAPER Unidade: CX/72
 F1 F4



COLCHETE LATONADO N11 5,5CM 240FLS 72X1
 Código: 47237 Fábrica: FIX PAPER Unidade: CX/72
 F1 F4



COLCHETE LATONADO N12 6CM 270FLS 72X1
 Código: 47239 Fábrica: FIX PAPER Unidade: CX/72
 F1 F4



COLCHETE LATONADO N13 7,5CM 360FLS 72X1
 Código: 47240 Fábrica: FIX PAPER Unidade: CX/72
 F1 F4



COLCHETE LATONADO N14 8,2CM 400FLS 72X1
 Código: 47241 Fábrica: FIX PAPER Unidade: CX/72
 F1 F4



COLCHETE LATONADO N15 10CM 450FLS 72X1
 Código: 43718 Fábrica: FIX PAPER Unidade: CX/72
 F1 F4



COLCHETE LATONADO N17 11CM 455FLS 72X1
 Código: 47242 Fábrica: FIX PAPER Unidade: CX/72
 F1 F4



COLCHETE METAL N07 3,2CM 140 FLS 72X1
 Código: 43513 Fábrica: BACCHI Unidade: CX/72
 F1 F4



COLCHETE METAL N09 4,5CM 200 FLS 72X1
 Código: 43515 Fábrica: BACCHI Unidade: CX/72
 F1 F4



COLCHETE METAL N11 5,5CM 240 FLS 72X1
 Código: 43514 Fábrica: BACCHI Unidade: CX/72
 F1 F4



COLCHETE METAL N13 7,5CM 360 FLS 72X1
 Código: 43516 Fábrica: BACCHI Unidade: CX/72
 F1 F4



COMPASSO JOLLY 12X1
 Código: 6889 Fábrica: COMPACTOR Unidade: CX/12
 F1 F4



COMPASSO METAL C/ESTOJO GRAFITE EXT 7302
 Código: 48345 Fábrica: YIN'S PAPER Unidade: UN/1
 F1 F4



COMPASSO METAL C/ESTOJO 4458
 Código: 42599 Fábrica: LEO&LEO Unidade: UN/1
 F1 F4



COMPASSO PINUS P/GIZCM 2930
 Código: 49901 Fábrica: SOUZA Unidade: UN/1
 F1 F4

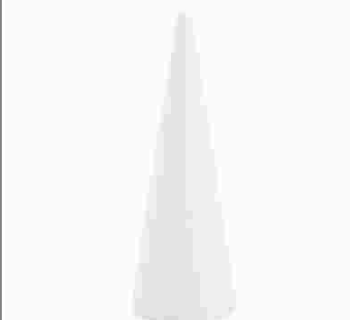

CONE ISOPOR 360X140MM
 Código: 30093 Fábrica: ISOMAX Unidade: UN/1
 F1 F4



CONVITE SIMPLES ANIVERSARIO 10X1
 Código: 29839 Fábrica: UNICART Unidade: PT/10
 F1 F4



CONVITE SIMPLES CHA COZINHA/PANELA 10X1
 Código: 5130 Fábrica: UNICART Unidade: PT/10
 F1 F4



CONVITE SIMPLES CHA DO BEBE AZUL 10X1
 Código: 5600 Fábrica: UNICART Unidade: PT/10
 F1 F4



CONVITE SIMPLES CHA DO BEBE ROSA 10X1
 Código: 32365 Fábrica: UNICART Unidade: PT/10
 F1 F4



CORACAO EVA 8CM GLITER VERMELHO 6X1
 Código: 47913 Fábrica: YIN'S PAPER Unidade: PT/6
 F1 F4



CORACAO 15 GRS MULTICOR

Código: **39436** Fábrica: **MINAS BRILHO** Unidade: **PT/1 F1 F4**



CORACAO 3 GR MULTICOR 12X1

Código: **15078** Fábrica: **MINAS BRILHO** Unidade: **DZ/12 F1 F4**



CORANTE LIQ 10 ML ANILINA AMARELO DAM

Código: **50304** Fábrica: **MIX** Unidade: **UN/1 F1 F4**



CORANTE LIQ 10 ML ANILINA AMARELO GEMA

Código: **50357** Fábrica: **MIX** Unidade: **UN/1 F1 F4**



CORANTE LIQ 10 ML ANILINA AZUL JEANS

Código: **50301** Fábrica: **MIX** Unidade: **UN/1 F1 F4**



CORANTE LIQ 10 ML ANILINA BRANCO LEITE

Código: **50358** Fábrica: **MIX** Unidade: **UN/1 F1 F4**



CORANTE LIQ 10 ML ANILINA LARANJA

Código: **50352** Fábrica: **MIX** Unidade: **UN/1 F1 F4**



CORANTE LIQ 10 ML ANILINA MARROM CHOCOLA

Código: **50354** Fábrica: **MIX** Unidade: **UN/1 F1 F4**



CORANTE LIQ 10 ML ANILINA PRETO INTENSO

Código: **50302** Fábrica: **MIX** Unidade: **UN/1 F1 F4**



CORANTE LIQ 10 ML ANILINA ROSA CEREJA

Código: **50356** Fábrica: **MIX** Unidade: **UN/1 F1 F4**



CORANTE LIQ 10 ML ANILINA ROSA PINK

Código: **50350** Fábrica: **MIX** Unidade: **UN/1 F1 F4**



CORANTE LIQ 10 ML ANILINA VERDE FOLHA

Código: **50303** Fábrica: **MIX** Unidade: **UN/1 F1 F4**



CORANTE LIQ 10 ML ANILINA VERDE HORTELA

Código: **50349** Fábrica: **MIX** Unidade: **UN/1 F1 F4**



CORANTE LIQ 10 ML ANILINA VERDE LIMAO

Código: **50355** Fábrica: **MIX** Unidade: **UN/1 F1 F4**



CORANTE LIQ 10 ML ANILINA VERMELHO MORAN

Código: **50305** Fábrica: **MIX** Unidade: **UN/1 F1 F4**



CORANTE LIQ 10 ML ANILINA VERMELHO NATAL

Código: **50353** Fábrica: **MIX** Unidade: **UN/1 F1 F4**



CORANTE LIQ 10 ML ANILINA VINHO BORDO

Código: 50351
 Fábrica: MIX
 Unidade: UN/1
 F1 F4



CORDAO P/CRACHA C/JACARE 40CM AZUL 10X1

Código: 45601
 Fábrica: KAZ
 Unidade: PT/10
 F1 F4



CORDAO P/CRACHA C/JACARE 40CM PRETO 10X1

Código: 45602
 Fábrica: KAZ
 Unidade: PT/10
 F1 F4



CORDAO P/CRACHA C/JACARE 40CM VERDE 10X1

Código: 45603
 Fábrica: DAC
 Unidade: PT/10
 F1 F4



CORRETIVO LIQUIDO REFIX 18 ML 12X1

Código: 49503
 Fábrica: TRIS
 Unidade: DZ/12
 F1 F4



CORRETIVO LIQUIDO 18 ML UN

Código: 42298
 Fábrica: NEW MAGIC EC
 Unidade: UN/1
 F1 F4



CORRETIVO LIQUIDO 18 ML 12X1

Código: 3348
 Fábrica: NEW MAGIC
 Unidade: DZ/12
 F1 F4



CRACHA BH-05 9,3X6,7CM 100X1

Código: 41787
 Fábrica: MP
 Unidade: CE/100
 F1 F4



CRACHA HORIZ AB LAT 7X10CM C-9 100X1

Código: 46175
 Fábrica: ACP
 Unidade: PT/100
 F1 F4



CRACHA HORIZ AB SUP 7X10CM C-9/S 100X1

Código: 46172
 Fábrica: ACP
 Unidade: CE/100
 F1 F4



CRACHA HORIZ C/PRESILH 7X10CM C-7 100X1

Código: 46204
 Fábrica: ACP
 Unidade: CE/100
 F1 F4

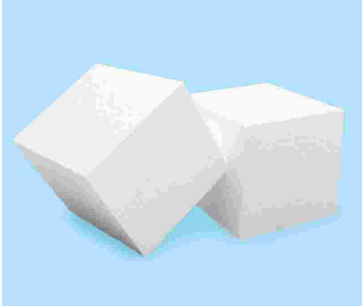

CUBO ISOPOR 100X100X100MM 10X1

Código: 30094
 Fábrica: ISOMAX
 Unidade: PT/10
 F1 F4



DIARIO DE ESCRITURACAO MERCANTIL 10X1

Código: 28916
 Fábrica: GRAMULI
 Unidade: PT/10
 F1 F4



DICIONARIO MINI ESPANHOL 101

Código: 42686
 Fábrica: CULTURAMA
 Unidade: UN/1
 F1 F4

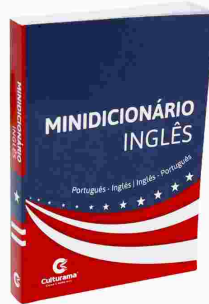

DICIONARIO MINI INGLES 102

Código: 42687
 Fábrica: CULTURAMA
 Unidade: UN/1
 F1 F4

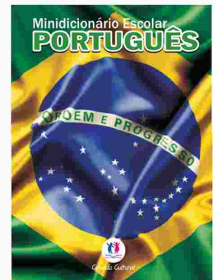

DICIONARIO MINI PORTUGUES JORNAL

Código: 33425
 Fábrica: CIRANDACULT
 Unidade: UN/1
 F1 F4

14 cm



DICIONARIO MINI PORTUGUES JORNAL

Código: **12962** Fábrica: **CIRANDA CULT** Unidade: **UN/1 F1 F4**



DICIONARIO MINI PORTUGUES 103

Código: **42688** Fábrica: **CULTURAMA** Unidade: **UN/1 F1 F4**



DICIONARIO MINI SCOTTINI ESPANHOL

Código: **48484** Fábrica: **TODOLIVRO** Unidade: **UN/1 F1 F4**



DICIONARIO MINI SCOTTINI INGLES

Código: **30919** Fábrica: **TODOLIVRO** Unidade: **UN/1 F1 F4**



DICIONARIO MINI SCOTTINI PORTUGUES

Código: **30918** Fábrica: **TODOLIVRO** Unidade: **UN/1 F1 F4**



DILUENTE P/TINTA TECIDO 60 ML 19360 UN

Código: **44983** Fábrica: **ACRILEX** Unidade: **UN/1 F1 F4**



DISPLAY FRONTAL A4 31X23X0,3CM 10090013

Código: **44677** Fábrica: **MAXCRIL** Unidade: **UN/1 F1 F4**



DIVISORIA P/ FICHARIO 12 MATERIAS 855

Código: **19469** Fábrica: **ACP** Unidade: **UN/1 F1 F4**



DVD-R GRAVAVEL 120 MIN 4,7 GB 50X1

Código: **14632** Fábrica: **MAKETECH** Unidade: **PT/50 F1 F4**



ELASTICO P/DINH N18 (GOMINHA) KG 1200X1

Código: **28031** Fábrica: **RED BOR** Unidade: **PT/1 F1 F4**



ELASTICO P/DINH N18 (GOMINHA) 100G 120X1

Código: **13142** Fábrica: **PREMIER/MAMU** Unidade: **PT/1 F1 F4**



ELASTICO P/DINH N18 (GOMINHA) 100X1

Código: **41228** Fábrica: **PREMIER** Unidade: **PT/1 F1 F4**



ELASTICO P/DINH N18 (GOMINHA) 200X1

Código: **41226** Fábrica: **MERCUR** Unidade: **PT/1 F1 F4**



ELASTICO P/DINH N18 (GOMINHA) 25G 30X1

Código: **28030** Fábrica: **PREMIER** Unidade: **CX/1 F1 F4**



ELASTICO P/DINH N18 (GOMINHA) 250G 300X1

Código: **49144** Fábrica: **PREMIER** Unidade: **PT/1 F1 F4**



ELASTICO P/DINH N18 (GOMINHA) 50G 60X1

Código: **22488** Fábrica: **PREMIER** Unidade: **PT/1 F1 F4**



ELASTICO P/DINH N18 (GOMINHA)500G 600X1
 Código: 35961 Fábrica: PREMIER Unidade: PT/1 F1 F4

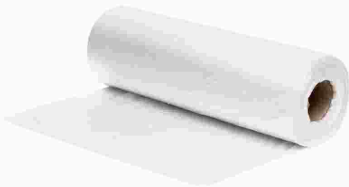

EMBALAGEM PLAST BOBINA 25CM KG
 Código: 46254 Fábrica: ACP Unidade: KG/1 F1 F4

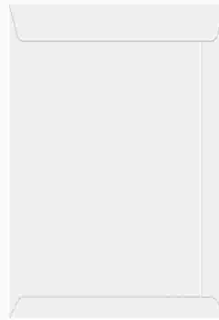

ENVELOPE BRANCO SACO 176X250MM O25 250X1
 Código: 28126 Fábrica: REIPEL Unidade: CX/250 F1 F4



ENVELOPE BRANCO SACO 176X250MM 725 100X1
 Código: 19602 Fábrica: SCRITY Unidade: CX/100 F1 F4

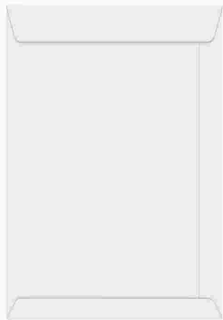

ENVELOPE BRANCO SACO 200X280MM O28 250X1
 Código: 12189 Fábrica: REIPEL Unidade: CX/250 F1 F4



ENVELOPE BRANCO SACO 229X324MM O32 250X1
 Código: 28127 Fábrica: REIPEL/SCRIT Unidade: CX/250 F1 F4

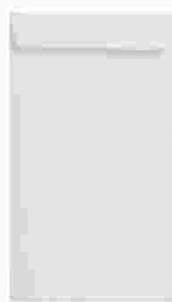

ENVELOPE BRANCO SACO 229X324MM 732 100X1
 Código: 27863 Fábrica: SCRITY Unidade: CX/100 F1 F4

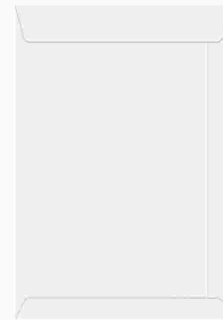

ENVELOPE BRANCO SACO 240X340MM O34 250X1
 Código: 28128 Fábrica: REIPEL/SCRIT Unidade: CX/250 F1 F4



ENVELOPE BRANCO SACO 240X340MM 734 100X1
 Código: 28125 Fábrica: SCRITY Unidade: CX/100 F1 F4

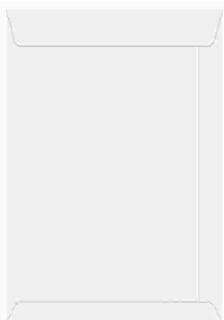

ENVELOPE BRANCO SACO 260X360MM O36 250X1
 Código: 46598 Fábrica: REIPEL Unidade: CX/250 F1 F4



ENVELOPE BRANCO SACO 260X360MM 100X1
 Código: 46918 Fábrica: SCRITY Unidade: CX/100 F1 F4



ENVELOPE BRANCO SACO 310X410MM 100X1
 Código: 50623 Fábrica: REIPEL Unidade: CX/100 F1 F4



ENVELOPE BRANCO 121X190MM 100X1
 Código: 50630 Fábrica: REIPEL Unidade: CX/100 F1 F4



ENVELOPE COM 110X162MM AZUL BAHAMA 100X1
 Código: 45240 Fábrica: AGAPE Unidade: CE/100 F1 F4



ENVELOPE COM 110X162MM AZUL GRECIA 100X1
 Código: 45238 Fábrica: AGAPE Unidade: CE/100 F1 F4



ENVELOPE COM 110X162MM AZUL GRECIA 100X1
 Código: 35303 Fábrica: AGAPE Unidade: CE/100 F1 F4

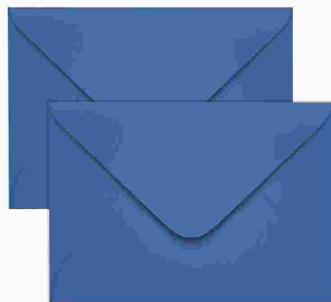

ENVELOPE COM 110X162MM AZUL P SEGU 100X1
 Código: 45239 Fábrica: AGAPE Unidade: CE/100
 F1 F4



ENVELOPE COM 110X162MM LARANJ CART 100X1
 Código: 45245 Fábrica: AGAPE Unidade: CE/100
 F1 F4

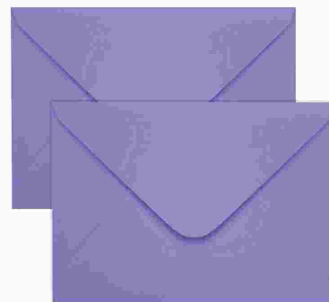

ENVELOPE COM 110X162MM LILAS AMSTE 100X1
 Código: 45250 Fábrica: AGAPE Unidade: CE/100
 F1 F4



ENVELOPE COM 110X162MM PRETO LOS A 100X1
 Código: 45242 Fábrica: AGAPE Unidade: CE/100
 F1 F4

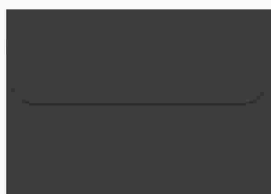

ENVELOPE COM 110X162MM PRETO 50X1
 Código: 35881 Fábrica: AGAPE Unidade: PT/50
 F1 F4



ENVELOPE COM 110X162MM RECICLADO 100X1
 Código: 45249 Fábrica: AGAPE Unidade: CE/100
 F1 F4



ENVELOPE COM 110X162MM ROSA CHICLE 100X1
 Código: 45247 Fábrica: AGAPE Unidade: CE/100
 F1 F4



ENVELOPE COM 110X162MM ROSA 50X1
 Código: 35883 Fábrica: AGAPE Unidade: PT/50
 F1 F4



ENVELOPE COM 110X162MM VERDE BRASI 100X1
 Código: 45246 Fábrica: AGAPE Unidade: CE/100
 F1 F4



ENVELOPE COM 110X162MM VERMELH TOQ 100X1
 Código: 14398 Fábrica: AGAPE Unidade: CE/100
 F1 F4



ENVELOPE COM 114X162MM AEREO 015 100X1
 Código: 498 Fábrica: SCRITY Unidade: CE/100
 F1 F4



ENVELOPE COM 114X162MM AMARELO RIO 100X1
 Código: 45241 Fábrica: AGAPE Unidade: CE/100
 F1 F4



ENVELOPE COM 114X162MM AZUL GRECIA 100X1
 Código: 15932 Fábrica: SCRITY Unidade: CE/100
 F1 F4

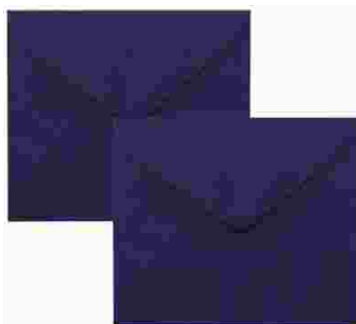

ENVELOPE COM 114X162MM AZUL P SEG 100X1
 Código: 14397 Fábrica: SCRITY Unidade: CE/100
 F1 F4

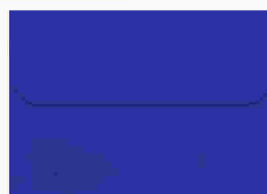

ENVELOPE COM 114X162MM AZUL P SEGUR 50X1
 Código: 35884 Fábrica: AGAPE Unidade: PT/50
 F1 F4

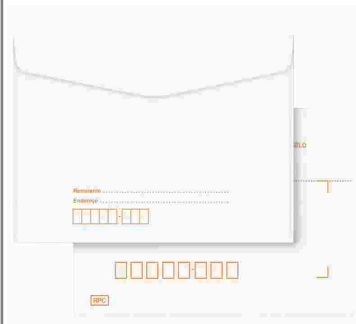

ENVELOPE COM 114X162MM BCO C/CEP 1000X1
 Código: 37408 Fábrica: SCRITY Unidade: CX/1000
 F1 F4



ENVELOPE COM 114X162MM BCO S/CEP 100X1
 Código: 2299 Fábrica: SCRITY Unidade: CE/100
 F1 F4



ENVELOPE COM 114X162MM BCO S/CEP 1000X1
 Código: 14396 Fábrica: REIPEL/SCRIT Unidade: CX/1000
 F1 F4



ENVELOPE COM 114X162MM CREM MARFIM 100X1
 Código: 9136 Fábrica: SCRITY Unidade: CE/100
 F1 F4

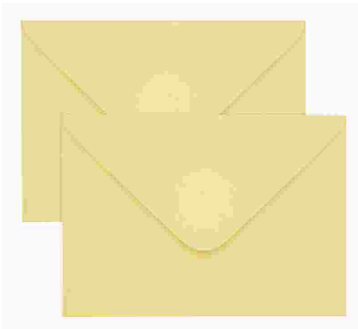

ENVELOPE COM 114X162MM CREME 100X1
 Código: 45248 Fábrica: AGAPE Unidade: CE/100
 F1 F4



ENVELOPE COM 114X162MM LARANJA CAR 100X1
 Código: 14399 Fábrica: SCRITY Unidade: CE/100
 F1 F4



ENVELOPE COM 114X162MM LILAS 50X1
 Código: 35882 Fábrica: AGAPE Unidade: PT/50
 F1 F4



ENVELOPE COM 114X162MM OFIC JANEL 1000X1
 Código: 45059 Fábrica: CELUCAT Unidade: CX/1000
 F1 F4



ENVELOPE COM 114X162MM PRETO LOS 100X1
 Código: 43813 Fábrica: SCRITY Unidade: CE/100
 F1 F4



ENVELOPE COM 114X162MM VERDE BRASI 100X1
 Código: 44180 Fábrica: SCRITY Unidade: PT/1
 F1 F4

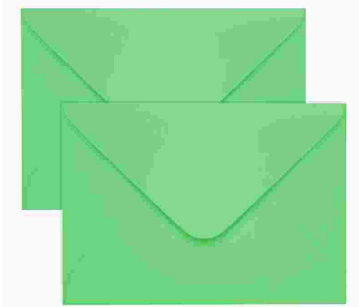

ENVELOPE COM 114X162MM VERDE BUENO 100X1
 Código: 45243 Fábrica: AGAPE Unidade: CE/100
 F1 F4



ENVELOPE COM 114X162MM VERDE NEON 100X1
 Código: 45244 Fábrica: AGAPE Unidade: CE/100
 F1 F4

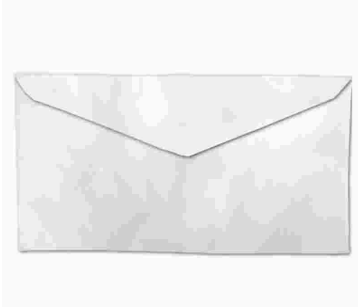

ENVELOPE COM 114X229MM OFICIO 020 100X1
 Código: 7135 Fábrica: SCRITY Unidade: CE/100
 F1 F4



ENVELOPE COM 114X229MM OFICIO 020 1000X1
 Código: 20438 Fábrica: REIPEL/SCRIT Unidade: CX/1000
 F1 F4

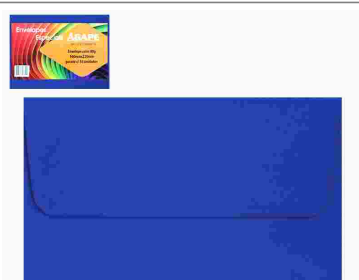

ENVELOPE CONV AZUL ESC 160X220MM 50X1
 Código: 35891 Fábrica: AGAPE Unidade: PT/50
 F1 F4



ENVELOPE CONV CINZ METAL 163X225MM 50X1
 Código: 35591 Fábrica: ROMITEC Unidade: C//50
 F1 F4

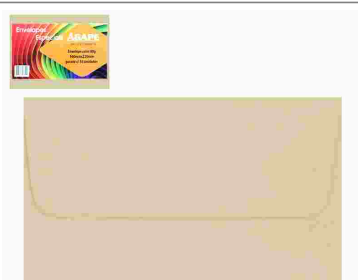

ENVELOPE CONV CREME 160X220MM 50X1
 Código: 41547 Fábrica: AGAPE Unidade: PT/50
 F1 F4



ENVELOPE CONV LILAS AMST 160X235MM 100X1
 Código: 43822 Fábrica: SCRITY Unidade: CE/100
 F1 F4

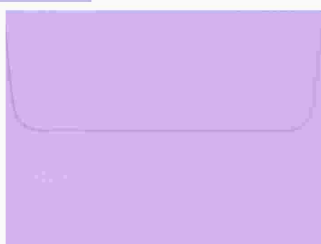

ENVELOPE CONV LILAS 160X220MM 50X1
 Código: 35890 Fábrica: AGAPE Unidade: PT/50
 F1 F4

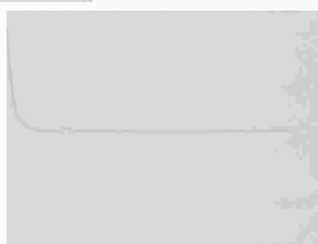

ENVELOPE CONV MARFIM 160X220MM 50X1
 Código: 35892 Fábrica: AGAPE Unidade: PT/50
 F1 F4



ENVELOPE CONV MARFIM 160X235MM 100X1
 Código: 43825 Fábrica: SCRITY Unidade: CE/100
 F1 F4



ENVELOPE CONV PINK 163X225MM 50X1 3230
 Código: 35589 Fábrica: ROMITEC Unidade: C//50
 F1 F4

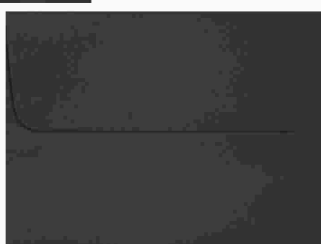

ENVELOPE CONV PRETO 160X220MM 50X1
 Código: 35887 Fábrica: AGAPE Unidade: PT/50
 F1 F4

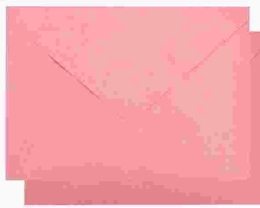

ENVELOPE CONV ROSA FIDJI 160X235MM 100X1
 Código: 43820 Fábrica: SCRITY Unidade: CE/100
 F1 F4



ENVELOPE CONV ROSA METAL 163X225MM 50X1
 Código: 35590 Fábrica: ROMITEC Unidade: C//50
 F1 F4

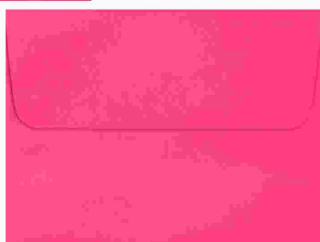

ENVELOPE CONV ROSA 160X220MM 50X1
 Código: 35886 Fábrica: AGAPE Unidade: PT/50
 F1 F4



ENVELOPE CONV ROXO 163X225MM 100X1
 Código: 35592 Fábrica: ROMITEC Unidade: C//100
 F1 F4



ENVELOPE CONV VERD BRASI 160X235MM 100X1
 Código: 43821 Fábrica: SCRITY Unidade: CE/100
 F1 F4

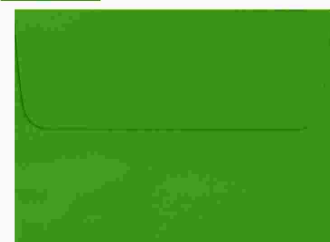

ENVELOPE CONV VERDE BAND 160X220MM 50X1
 Código: 35888 Fábrica: AGAPE Unidade: PT/50
 F1 F4



ENVELOPE CONV VERM TOQUI 160X235MM 100X1
 Código: 43823 Fábrica: SCRITY Unidade: CE/100
 F1 F4

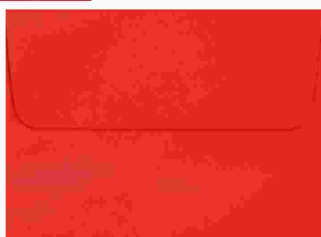

ENVELOPE CONV VERMELHO 160X220MM 50X1
 Código: 35889 Fábrica: AGAPE Unidade: PT/50
 F1 F4



ENVELOPE KRAFT SACO 110X170MM 100X1
 Código: 50629 Fábrica: REIPEL Unidade: CX/100
 F1 F4



ENVELOPE KRAFT SACO 110X170MM KN17 250X1
 Código: 15929 Fábrica: SCRITY Unidade: CX/250
 F1 F4



ENVELOPE KRAFT SACO 125X176MM KN18 250X1
 Código: 29999 Fábrica: SCRITY Unidade: CX/250
 F1 F4



ENVELOPE KRAFT SACO 162X229MM KN23 250X1
 Código: 47016 Fábrica: REIPEL Unidade: CX/250
 F1 F4



ENVELOPE KRAFT SACO 176X250MM KN18 250X1
 Código: 9124 Fábrica: SCRITY Unidade: CX/250
 F1 F4



ENVELOPE KRAFT SACO 176X250MM 325 100X1
 Código: 12188 Fábrica: SCRITY Unidade: CX/100
 F1 F4



ENVELOPE KRAFT SACO 200X280MM KN28 250X1
 Código: 26698 Fábrica: SCRITY Unidade: CX/250
 F1 F4



ENVELOPE KRAFT SACO 200X280MM 353 100X1
 Código: 19796 Fábrica: SCRITY Unidade: CX/100
 F1 F4



ENVELOPE KRAFT SACO 200X280MM 38 500X1
 Código: 45056 Fábrica: CELUCAT Unidade: CX/500
 F1 F4



ENVELOPE KRAFT SACO 229X324MM KN32 250X1
 Código: 23223 Fábrica: SCRITY Unidade: CX/250
 F1 F4



ENVELOPE KRAFT SACO 229X324MM 332 100X1
 Código: 9128 Fábrica: CELUCAT/SCRI Unidade: CX/100
 F1 F4



ENVELOPE KRAFT SACO 240X340MM KN34 250X1
 Código: 8469 Fábrica: SCRITY Unidade: CX/250
 F1 F4



ENVELOPE KRAFT SACO 250X353MM KN35 250X1
 Código: 6044 Fábrica: REIPEL/SCRI Unidade: CX/250
 F1 F4



ENVELOPE KRAFT SACO 260X360MM KN36 250X1
 Código: 42635 Fábrica: REIPEL Unidade: CX/250
 F1 F4



ENVELOPE KRAFT SACO 260X360MM KN36 250X1
 Código: 19031 Fábrica: SCRITY Unidade: CX/250
 F1 F4



ENVELOPE KRAFT SACO 310X410MM KN41 250X1
 Código: 42626 Fábrica: REIPEL/CELUC Unidade: CX/250
 F1 F4



ENVELOPE KRAFT SACO 310X410MM 341 100X1
 Código: 42073 Fábrica: SCRITY Unidade: CX/100
 F1 F4



ENVELOPE KRAFT SACO 370X470MM 347 100X1
 Código: 44179 Fábrica: SCRITY/CELUC Unidade: CX/100
 F1 F4



ENVELOPE OURO SACO 110X170MM 100X1
 Código: 50628 Fábrica: REIPEL Unidade: CX/100
 F1 F4



ENVELOPE OURO SACO 162X229MM KO 100X1
 Código: 50625 Fábrica: REIPEL Unidade: PT/1
 F1 F4



ENVELOPE OURO SACO 162X229MM KO23 250X1
 Código: 47616 Fábrica: REIPEL Unidade: CX/250
 F1 F4



ENVELOPE OURO SACO 185X248MM 100X1
 Código: 50624 Fábrica: REIPEL Unidade: CX/100
 F1 F4



ENVELOPE OURO SACO 240X340MM KO34 250X1
 Código: 47595 Fábrica: REIPEL Unidade: CX/250
 F1 F4



ENVELOPE VIS 80GR AMAR RJ 72X108MM 100X1
 Código: 12192 Fábrica: SCRITY Unidade: CE/100
 F1 F4



ENVELOPE VIS 80GR AMARELO 75X115MM 100X1
 Código: 9137 Fábrica: AGAPE Unidade: CE/100
 F1 F4



ENVELOPE VIS 80GR AZUL BA 72X108MM 100X1
 Código: 43827 Fábrica: SCRITY Unidade: CE/100
 F1 F4



ENVELOPE VIS 80GR AZUL ESC 75X115MM 50X1
 Código: 44667 Fábrica: AGAPE Unidade: PT/50
 F1 F4



ENVELOPE VIS 80GR AZUL GR 72X108MM 100X1
 Código: 43826 Fábrica: SCRITY Unidade: CE/100
 F1 F4

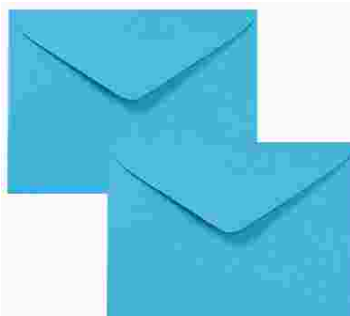

ENVELOPE VIS 80GR AZUL 75X115MM 100X1
 Código: 12191 Fábrica: AGAPE Unidade: CE/100
 F1 F4



ENVELOPE VIS 80GR BEGE 78X115MM 100X1
 Código: 12190 Fábrica: AGAPE Unidade: CE/100
 F1 F4



ENVELOPE VIS 80GR LILAS 75X115MM 50X1
 Código: 35879 Fábrica: AGAPE Unidade: PT/50
 F1 F4



ENVELOPE VIS 80GR MARFIM 72X108MM 100X1
 Código: 43829 Fábrica: SCRITY Unidade: CE/100
 F1 F4



ENVELOPE VIS 80GR PRETO L 72X108MM 100X1
 Código: 43830 Fábrica: SCRITY Unidade: CE/100
 F1 F4



ENVELOPE VIS 80GR PRETO 75X115MM 50X1
 Código: 35880 Fábrica: AGAPE Unidade: PT/50
 F1 F4



ENVELOPE VIS 80GR ROSA CA 72X108MM 100X1
 Código: 12193 Fábrica: SCRITY Unidade: CE/100
 F1 F4



ENVELOPE VIS 80GR ROSA CL 78X115MM 100X1
 Código: 14400 Fábrica: AGAPE Unidade: CE/100
 F1 F4



ENVELOPE VIS 80GR ROSA FI 72X108MM 100X1
 Código: 43831 Fábrica: SCRITY Unidade: CE/100
 F1 F4



ENVELOPE VIS 80GR ROSA 75X115MM 100X1
 Código: 9139 Fábrica: AGAPE Unidade: CE/100
 F1 F4



ENVELOPE VIS 80GR ROSA 75X115MM 50X1
 Código: 35878 Fábrica: AGAPE Unidade: PT/50
 F1 F4



ENVELOPE VIS 80GR VERDE T 72X108MM 100X1
 Código: 43828 Fábrica: SCRITY Unidade: CE/100
 F1 F4



ENVELOPE VIS 80GR VERDE 75X115MM 100X1
 Código: 35304 Fábrica: AGAPE Unidade: CE/100
 F1 F4



ENVELOPE VIS 80GR VERM T 72X108MM 100X1
 Código: 29596 Fábrica: SCRITY Unidade: CE/100
 F1 F4

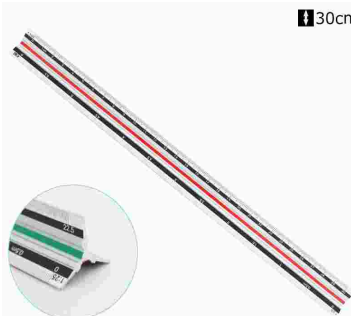

ESCALIMETRO 30CM METAL 2008
 Código: 46743 Fábrica: KAZ Unidade: UN/1
 F1 F4



ESCALIMETRO 30CM PLAST 970107
 Código: 46745 Fábrica: KAZ Unidade: UN/1
 F1 F4



ESPATULA PLAST ARTIST PINTURA 16,4CM 548
 Código: 45492 Fábrica: CONDOR Unidade: UN/1
 F1 F4



ESPATULA PLAST ARTIST PINTURA 17,2CM 541
 Código: 45495 Fábrica: CONDOR Unidade: UN/1
 F1 F4



ESPATULA PLAST ARTIST PINTURA 18CM 543
 Código: 45494 Fábrica: CONDOR Unidade: UN/1
 F1 F4

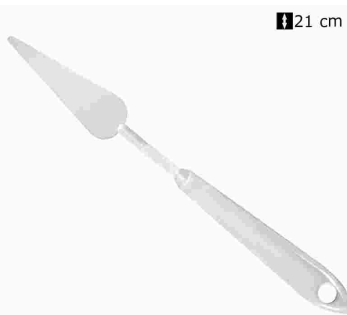

ESPATULA PLAST ARTIST PINTURA 21CM 545
 Código: 45493 Fábrica: CONDOR Unidade: UN/1
 F1 F4



ESPATULA PLAST 14CM 992 86314
 Código: 45485 Fábrica: CONDOR Unidade: UN/1
 F1 F4

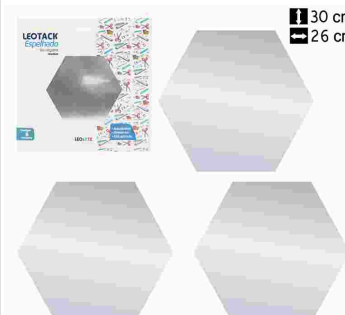

ESPELHADO AUTOADES HEXAGONOS 30X26CM 6X1
 Código: 39820 Fábrica: LEO&LEO Unidade: PT/5
 F1 F4

12 mm
70 folhas

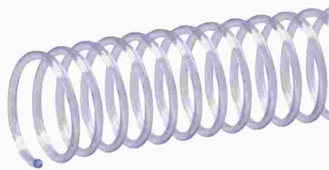

ESPIRAL CRIS 12MM 70 FLS P/ ENCADERNACAO

Código: 8999 Fábrica: AFORPLASTIC Unidade: PT/100
F1 F4

17 mm
100 folhas

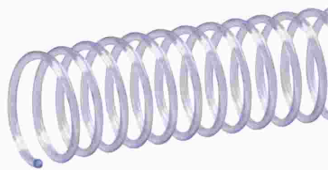

ESPIRAL CRIS 17MM 100 FLS P/ ENCAD 100X1

Código: 9001 Fábrica: AFORPLASTIC Unidade: PT/100
F1 F4

20 mm
120 folhas

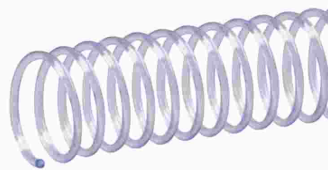

ESPIRAL CRIS 20MM 120 FLS P/ ENCADERNACA

Código: 9002 Fábrica: AFROPLASTIC Unidade: PT/70
F1 F4

45 mm
450 folhas

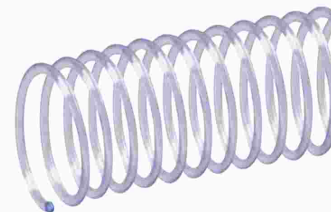

ESPIRAL CRIS 45MM 450 FLS P/ ENCADERNACA

Código: 9008 Fábrica: AFORPLASTIC Unidade: PT/16
F1 F4

07mm

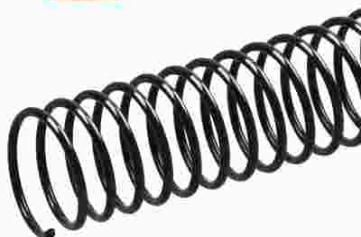

ESPIRAL PTO 07 MM 25 FLS P/ ENCAD 100X1

Código: 8980 Fábrica: AFORPLASTIC Unidade: PT/100
F1 F4

09 mm

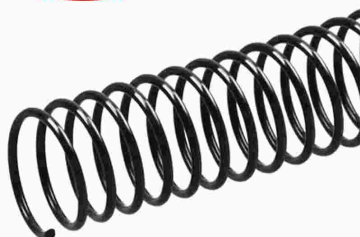

ESPIRAL PTO 09 MM 50 FLS P/ ENCAD 100X1

Código: 8981 Fábrica: AFORPLASTIC Unidade: PT/100
F1 F4

12 mm



ESPIRAL PTO 12 MM 70 FLS P/ ENCAD 100X1

Código: 8982 Fábrica: AFORPLASTIC Unidade: PT/100
F1 F4

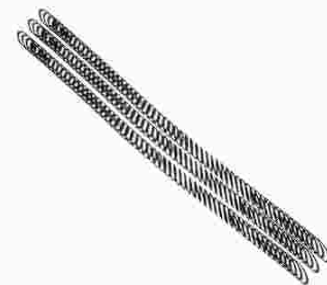

ESPIRAL PTO 14 MM 85 FLS P/ ENCAD 100X1

Código: 8983 Fábrica: AFORPLASTIC Unidade: PT/100
F1 F4

17mm

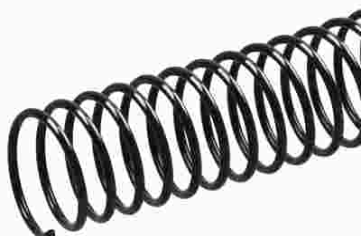

ESPIRAL PTO 17 MM 100 FLS P/ ENCAD 100X1

Código: 8984 Fábrica: AFORPLASTIC Unidade: PT/100
F1 F4



ESPIRAL PTO 20 MM 120 FLS P/ ENCAD 80X1

Código: 8985 Fábrica: AFORPLASTIC Unidade: PT/80
F1 F4

23mm

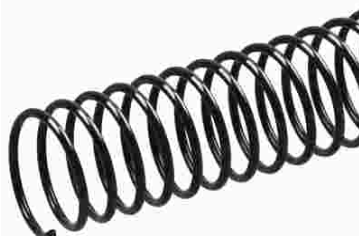

ESPIRAL PTO 23 MM 140 FLS P/ ENCAD 60X1

Código: 8986 Fábrica: AFORPLASTIC Unidade: PT/60
F1 F4



ESPIRAL PTO 25 MM 160 FLS P/ ENCAD 48X1

Código: 8987 Fábrica: AFORPLASTIC Unidade: PT/48
F1 F4

29mm

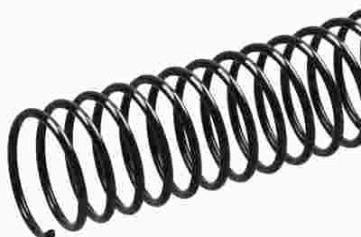

ESPIRAL PTO 29 MM 200 FLS P/ ENCAD 36X1

Código: 8988 Fábrica: AFORPLASTIC Unidade: PT/36
F1 F4

33mm

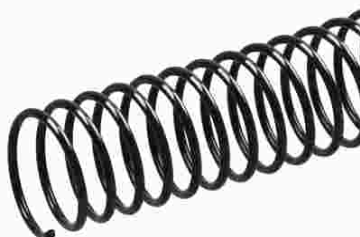

ESPIRAL PTO 33 MM 300 FLS P/ ENCAD 27X1

Código: 8989 Fábrica: AFORPLASTIC Unidade: PT/27
F1 F4

40mm

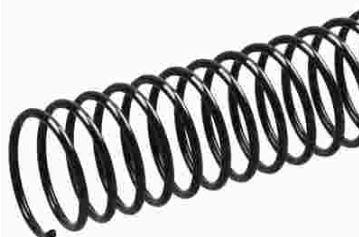

ESPIRAL PTO 40 MM 400 FLS P/ ENCAD 18X1

Código: 8990 Fábrica: AFORPLASTIC Unidade: PT/18
F1 F4

45mm

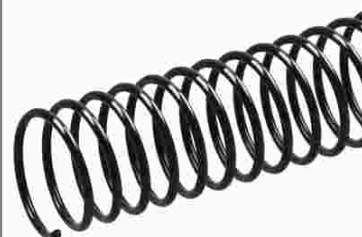

ESPIRAL PTO 45 MM 450 FLS P/ ENCAD 15X1

Código: 8992 Fábrica: AFORPLASTIC Unidade: PT/15
F1 F4



ESPIRAL PTO 50 MM 500 FLS P/ ENCAD 12X1
 Código: 8994 Fábrica: AFORPLASTIC Unidade: PT/12
 F1 F4

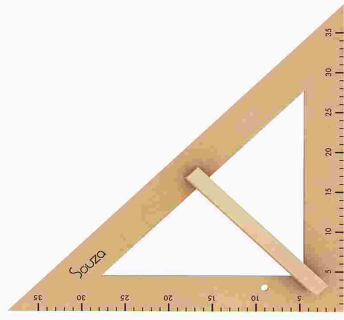

ESQUADRO MDF 45 GRAUS 2934
 Código: 49903 Fábrica: SOUZA Unidade: UN/1
 F1 F4

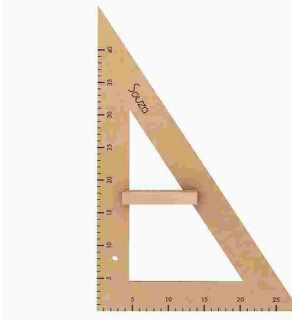

ESQUADRO MDF 60 GRAUS 2936
 Código: 49902 Fábrica: SOUZA Unidade: UN/1
 F1 F4

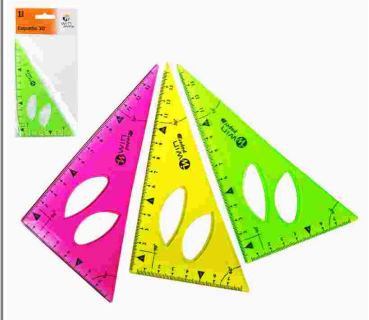

ESQUADRO 30° FLEXIVEL COLOR 218
 Código: 44742 Fábrica: WIN PAPER Unidade: PT/10
 F1 F4

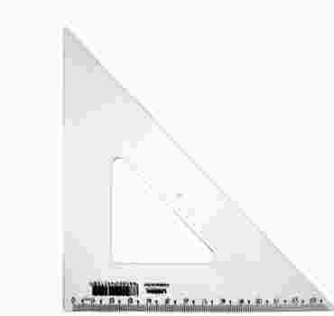

ESQUADRO 45 GRAUS 10X1
 Código: 10110 Fábrica: WALEU Unidade: PT/10
 F1 F4

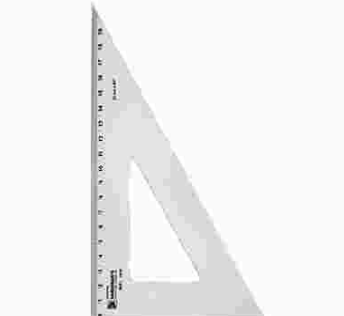

ESQUADRO 60 GRAUS 10X1
 Código: 23662 Fábrica: WALEU Unidade: PT/10
 F1 F4



ESTECAS KIT P/ESCUPIR 7640 8X1
 Código: 47937 Fábrica: YIN'S PAPER Unidade: KI/1
 F1 F4



ESTILETE CORTADOR CIRCUL MANUAL EVA 45MM
 Código: 48729 Fábrica: LEO&LEO Unidade: CR/1
 F1 F4



ESTILETE ESTREITO 9MM COLOR 12X1
 Código: 39908 Fábrica: FUTURO Unidade: DZ/12
 F1 F4



ESTILETE ESTREITO 9MM COLOR 450 24X1
 Código: 6768 Fábrica: MASTERPRINT Unidade: CX/24
 F1 F4



ESTILETE ESTREITO 9MM COLOR 91410 12X1
 Código: 50666 Fábrica: LEOARTE Unidade: DZ/12
 F1 F4



ESTILETE ESTREITO 9MM PLAST EMBOR 91419
 Código: 42603 Fábrica: JOCAROFFICE Unidade: UN/1
 F1 F4



ESTILETE ESTREITO 10MM PLAST EMBOR 5434
 Código: 43281 Fábrica: MAGAGIFT Unidade: UN/1
 F1 F4



ESTILETE LARGO 18MM CB EMBORR CTL 900517
 Código: 48320 Fábrica: BAZZE Unidade: CR/1
 F1 F4



ESTILETE LARGO 18MM CB EMBORRA CTL 1804
 Código: 23642 Fábrica: BRW Unidade: UN/1
 F1 F4



ESTILETE LARGO 18MM COLOR CTL 12X1
 Código: 44810 Fábrica: FBG Unidade: DZ/12
 F1 F4



ESTILETE LARGO 18MM COLOR NA CX 12X1

Código: **19317** Fábrica: **FUTURO** Unidade: **DZ/12 F1 F4**



ESTILETE LARGO 18MM METAL EMBORR 91421

Código: **42592** Fábrica: **LEO&LEO** Unidade: **UN/1 F1 F4**



ESTILETE LARGO 18MM PLAST C/5LAMINAS

Código: **46746** Fábrica: **KAZ** Unidade: **CT/1 F1 F4**



ESTILETE LARGO 18MM PLAST TR GIRAT 1883

Código: **46432** Fábrica: **KAZ** Unidade: **CT/1 F1 F4**



ESTOJO ESCOLAR LATA CILINDRICO C/APONT 6

Código: **15288** Fábrica: **ALFA RIO** Unidade: **UN/1 F1 F4**



ESTOJO PLAST MULTIUSO COLOR 190 12X1

Código: **37678** Fábrica: **MAMITA** Unidade: **PT/12 F1 F4**



ESTRELINHA 2,3 GRS C/FURO COLOR 12X1

Código: **46910** Fábrica: **GLITTER VMP** Unidade: **CT/12 F1 F4**



ESTRELINHA 3 GR 12X1

Código: **15077** Fábrica: **CITY BRILHO** Unidade: **DZ/12 F1 F4**



ETIQUETA ADESIV TERMICA 10X15CM 200X1

Código: **46981** Fábrica: **MASTERPRINT** Unidade: **RL/200 F1 F4**

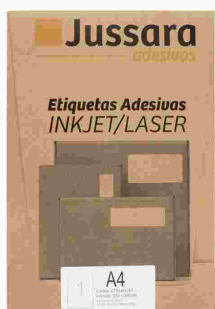

ETIQUETA ADESIVA A4 BCA 210X297MM 100X1

Código: **48111** Fábrica: **JUSSARA** Unidade: **PT/100 F1 F4**



ETIQUETA ADESIVA BCA 216X279MM 100X1

Código: **48112** Fábrica: **JUSSARA** Unidade: **PT/100 F1 F4**

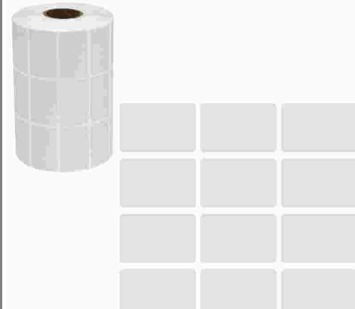

ETIQUETA ADESIVA 33X21X3 30MTS

Código: **40124** Fábrica: **PRIMUS** Unidade: **RL/1 F1 F4**



ETIQUETA DEC C/AMOR 300 100X1

Código: **2903** Fábrica: **KARINA** Unidade: **RL/100 F1 F4**



ETIQUETA DEC C/CARINHO DE/PARA 01 100X1

Código: **18827** Fábrica: **KARINA** Unidade: **RL/100 F1 F4**



ETIQUETA DEC C/CARINHO 435 100X1

Código: **18755** Fábrica: **KARINA** Unidade: **RL/100 F1 F4**



ETIQUETA DEC C/CARINHO 536 100X1

Código: **16057** Fábrica: **KARINA** Unidade: **RL/100 F1 F4**



ETIQUETA DEC DE/PARA 503 100X1

Código: **16035** Fábrica: **KARINA** Unidade: **RL/100**
F1 F4



ETIQUETA DEC FELICIDADES 70 100X1

Código: **16052** Fábrica: **KARINA** Unidade: **RL/100**
F1 F4



ETIQUETA DEC FELICIDADES DE/PA 256 100X1

Código: **16036** Fábrica: **KARINA** Unidade: **RL/100**
F1 F4



ETIQUETA DEC FELICIDADES DE/PA 548 100X1

Código: **41878** Fábrica: **KARINA** Unidade: **RL/100**
F1 F4



ETIQUETA DEC FELICIDADES 005 100X1

Código: **14169** Fábrica: **KARINA** Unidade: **RL/100**
F1 F4



ETIQUETA DEC FELICIDADES 278 100X1

Código: **3094** Fábrica: **KARINA** Unidade: **RL/100**
F1 F4



ETIQUETA DEC FELICIDADES 295 100X1

Código: **10846** Fábrica: **KARINA** Unidade: **RL/100**
F1 F4



ETIQUETA DEC FELICIDADES 585 100X1

Código: **16061** Fábrica: **KARINA** Unidade: **RL/100**
F1 F4



ETIQUETA DEC FELICIDADES 628 100X1

Código: **16026** Fábrica: **KARINA** Unidade: **RL/100**
F1 F4



ETIQUETA DEC JESUS TE AMA 08 100X1

Código: **30927** Fábrica: **KARINA** Unidade: **RL/100**
F1 F4



ETIQUETA DEC MENININHA DE PARA 50 100X1

Código: **31887** Fábrica: **KARINA** Unidade: **RL/100**
F1 F4



ETIQUETA DEC PARABENS 125 100X1

Código: **18819** Fábrica: **KARINA** Unidade: **RL/100**
F1 F4



ETIQUETA DEC TRENZINHO DE PARA 95 100X1

Código: **31886** Fábrica: **KARINA** Unidade: **RL/100**
F1 F4



ETIQUETA DEC URSINHO DE PARA 97 100X1

Código: **31888** Fábrica: **KARINA** Unidade: **RL/100**
F1 F4



ETIQUETA ESC AUTO ADES 78X35MM VERD 12X1

Código: **47934** Fábrica: **YIN'S PAPER** Unidade: **PT/12**
F1 F4



ETIQUETA ESC AUTO ADES 78X35MM VERM 2X1

Código: **47933** Fábrica: **YIN'S PAPER** Unidade: **PT/12**
F1 F4



ETIQUETA ESC AUTO ADES 80X53MM AZUL 8X1
 Código: 47931 Fábrica: YIN'S PAPER Unidade: PT/8 F1 F4



ETIQUETA ESC AUTO ADES 80X53MM SORT 8X1
 Código: 47932 Fábrica: YIN'S PAPER Unidade: PT/8 F1 F4



ETIQUETA ESC DEC ATLETICO 6X20
 Código: 23310 Fábrica: MINEIRO Unidade: PT/120 F1 F4



ETIQUETA ESC DEC BARBIE 6X20
 Código: 9471 Fábrica: MINEIRO Unidade: PT/120 F1 F4



ETIQUETA ESC DEC CARROS GLITER 6X10
 Código: 23302 Fábrica: MINEIRO Unidade: PT/60 F1 F4



ETIQUETA ESC DEC CARROSSEL 6X20
 Código: 15624 Fábrica: MINEIRO Unidade: PT/120 F1 F4

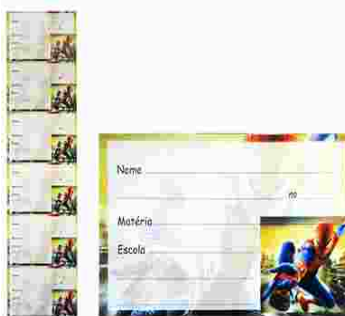

ETIQUETA ESC DEC HOMEM ARANHA 6X20
 Código: 23325 Fábrica: MINEIRO Unidade: PT/120 F1 F4



ETIQUETA ESC DEC HOT WELLS 6X20
 Código: 15623 Fábrica: MINEIRO Unidade: PT/120 F1 F4



ETIQUETA ESC DEC JOLIE 6X20
 Código: 23312 Fábrica: MINEIRO Unidade: PT/120 F1 F4

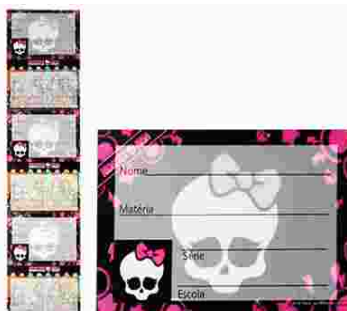

ETIQUETA ESC DEC MONSTER HIGH 6X20
 Código: 18816 Fábrica: MINEIRO Unidade: PT/120 F1 F4



ETIQUETA ESC DEC MORANGUINHO 6X20
 Código: 9475 Fábrica: MINEIRO Unidade: PT/120 F1 F4



ETIQUETA ESC DEC PATATI PATATA 6X20
 Código: 23322 Fábrica: MINEIRO Unidade: PT/120 F1 F4



ETIQUETA ESC DEC PICA PAU 6X20
 Código: 23308 Fábrica: MINEIRO Unidade: PT/120 F1 F4



ETIQUETA ESC DEC PUCCA 6X20
 Código: 9476 Fábrica: MINEIRO Unidade: PT/120 F1 F4

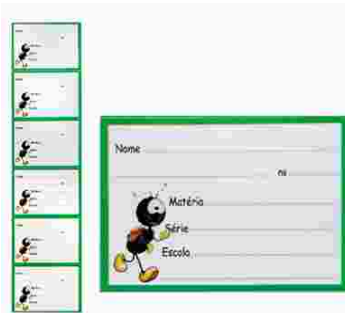

ETIQUETA ESC DEC SMILINGUIDO 6X20
 Código: 9468 Fábrica: MINEIRO Unidade: PT/120 F1 F4



ETIQUETA ESC SIMPLES 12X10
 Código: 26789 Fábrica: MIN Unidade: PT/120 F1 F4



ETIQUETA ETIQUETADORA BRANCO 10X500

Código: **49563** Fábrica: **ALIANCA** Unidade: **RL/10**
F1 F4

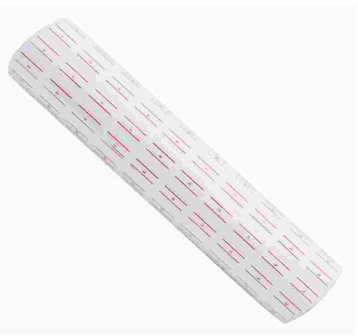

ETIQUETA ETIQUETADORA BRANCO 3551 10X300

Código: **36331** Fábrica: **WINMAX** Unidade: **RL/10**
F1 F4



ETIQUETA ETIQUETADORA BRANCO 3552 10X500

Código: **16058** Fábrica: **WINMAX** Unidade: **RL/10**
F1 F4

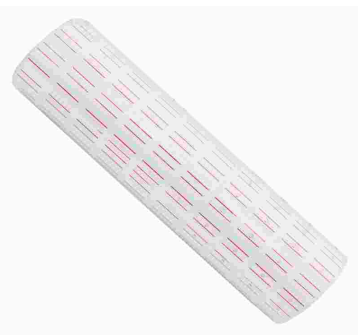

ETIQUETA ETIQUETADORA BRANCO 3553 10X700

Código: **49626** Fábrica: **WINMAX** Unidade: **RL/10**
F1 F4



ETIQUETA ETIQUETADORA BRANCO 554 10X1000

Código: **49625** Fábrica: **WINMAX** Unidade: **RL/10**
F1 F4



ETIQUETA ETIQUETADORA 10328 10X1000

Código: **22743** Fábrica: **LETRON** Unidade: **RL/1**
F1 F4

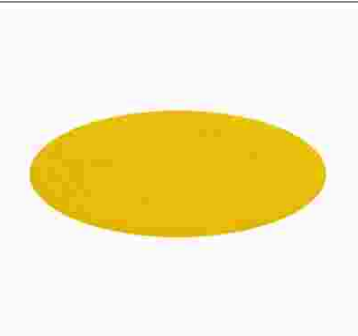

ETIQUETA OVAL P/CONVITE OURO 133 200X1

Código: **16047** Fábrica: **KARINA** Unidade: **RL/200**
F1 F4

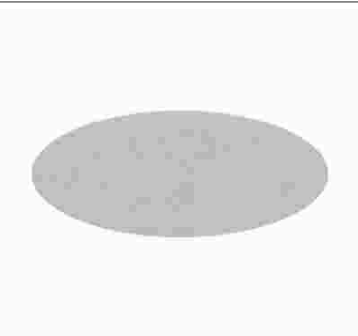

ETIQUETA OVAL P/CONVITE PRATA 134 200X1

Código: **16048** Fábrica: **KARINA** Unidade: **RL/200**
F1 F4



ETIQUETA PRECO N 1 22X15MM C/REF10X66UN

Código: **37775** Fábrica: **CARVALHO** Unidade: **RL/10**
F1 F4



ETIQUETA PRECO N 2 22X15MM 10X80UN

Código: **5865** Fábrica: **FERREIRA** Unidade: **RL/10**
F1 F4



ETIQUETA PRECO N 3 10X20MM 10X100UN

Código: **8355** Fábrica: **CARVALHO** Unidade: **RL/10**
F1 F4



ETIQUETA PRECO N 3 19X10MM 10X120UN

Código: **22738** Fábrica: **FERREIRA** Unidade: **RL/10**
F1 F4



ETIQUETA PRECO N 4 22X12MM 10X100UN

Código: **10294** Fábrica: **FERREIRA** Unidade: **RL/10**
F1 F4



ETIQUETA PRECO N 5 19X40MM 10X30UN

Código: **8358** Fábrica: **FERREIRA** Unidade: **RL/10**
F1 F4



ETIQUETA PRECO N 6 50X30MM 4X40UN

Código: **22737** Fábrica: **FERREIRA** Unidade: **RL/4**
F1 F4



ETIQUETA PRECO N 7 76X40MM 3X30UN

Código: **50097** Fábrica: **FERREIRA** Unidade: **PT/30**
F1 F4



ETIQUETA PRECO N 8 19X30MM 10X40UN

Código: **8357** Fábrica: **FERREIRA** Unidade: **RL/10**
F1 F4



ETIQUETA PRECO N 9 29X15MM 8X80UN

Código: **37684** Fábrica: **FERREIRA** Unidade: **RL/10**
F1 F4



ETIQUETA PRECO N 11 43X25MM 4X40UN

Código: **37778** Fábrica: **CARVALHO** Unidade: **RL/4**
F1 F4



ETIQUETA PRECO N 15 60X40MM 2X250UN

Código: **37686** Fábrica: **FERREIRA** Unidade: **RL/2**
F1 F4



ETIQUETA PRECO 30MMX5MTS 2124 4X312UN

Código: **37422** Fábrica: **ADERE** Unidade: **RL/4**
F1 F4



ETIQUETA RED AUTO ADESIV 15MM OURO 210X1

Código: **46940** Fábrica: **YIN'S PAPER** Unidade: **PT/210**
F1 F4



ETIQUETA RED AUTO ADESIV 15MM SORT 210X1

Código: **42813** Fábrica: **YIN'S PAPER** Unidade: **PT/210**
F1 F4



ETIQUETA RED P/CONVITE AMARELO 79 300X1

Código: **16042** Fábrica: **KARINA** Unidade: **RL/300**
F1 F4



ETIQUETA RED P/CONVITE AZUL 77 300X1

Código: **16044** Fábrica: **KARINA** Unidade: **RL/300**
F1 F4

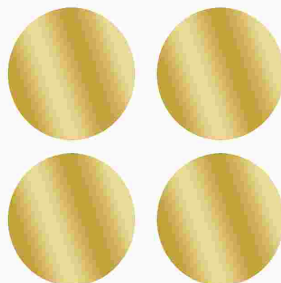

ETIQUETA RED P/CONVITE OURO 27 200X1

Código: **35852** Fábrica: **KARINA** Unidade: **RL/200**
F1 F4

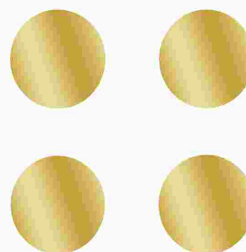

ETIQUETA RED P/CONVITE OURO 96 300X1

Código: **6727** Fábrica: **KARINA** Unidade: **RL/1**
F1 F4

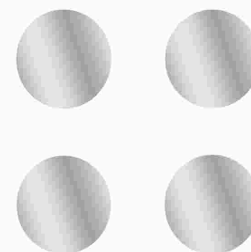

ETIQUETA RED P/CONVITE PRATA 101 300X1

Código: **6728** Fábrica: **KARINA** Unidade: **RL/300**
F1 F4

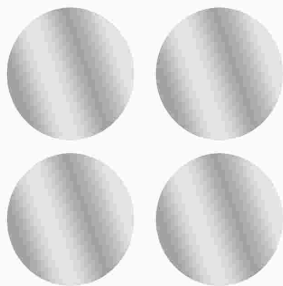

ETIQUETA RED P/CONVITE PRATA 153 200X1

Código: **47148** Fábrica: **KARINA** Unidade: **RL/200**
F1 F4

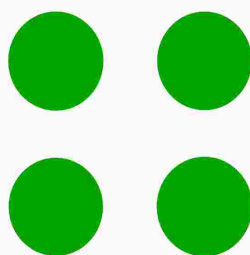

ETIQUETA RED P/CONVITE VERDE 78 300X1

Código: **16040** Fábrica: **KARINA** Unidade: **RL/300**
F1 F4

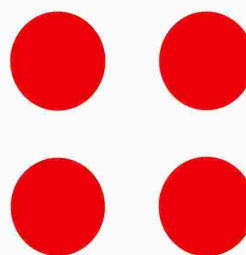

ETIQUETA RED P/CONVITE VERMELHO 76 300X1

Código: **16041** Fábrica: **KARINA** Unidade: **RL/300**
F1 F4



EXTRATOR GRAMPO METAL CROM 109 12X1

Código: **26146** Fábrica: **MASTERPRINT** Unidade: **DZ/12**
F1 F4



EXTRATOR GRAMPO METAL GALVANIZ 93050 UN
 Código: 46519 Fábrica: JOCAROFFICE Unidade: UN/1
 F1 F4



EXTRATOR GRAMPO PIRANHA
 Código: 41715 Fábrica: WIN PAPER Unidade: UN/1
 F1 F4



EXTRATOR GRAMPO PIRANHA 24/6 26/6 7138
 Código: 42812 Fábrica: YIN'S PAPER Unidade: UN/1
 F1 F4



EXTRATOR GRAMPO ZINCADO 176 12X1
 Código: 10459 Fábrica: CARBRINK Unidade: DZ/12
 F1 F4



FELTRO EST 140CMX2,5MX200G COMPOSE MAGAL
 Código: 41987 Fábrica: SANTA FE Unidade: RL/1
 F1 F4

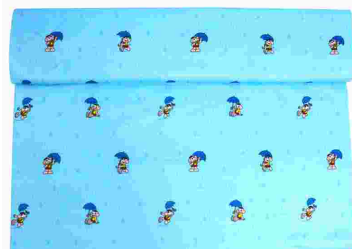

FELTRO EST 140CMX2,5MX200GR CASCAO CHUVA
 Código: 41992 Fábrica: SANTA FE Unidade: RL/2,5
 F1 F4

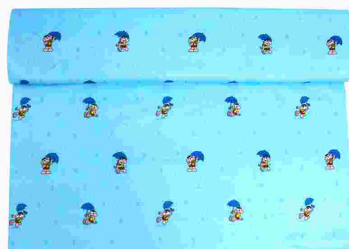

FELTRO EST 140CMX2,5MX200GR CASCAO GUARD
 Código: 41993 Fábrica: SANTA FE Unidade: RL/2,5
 F1 F4



FELTRO EST 140CMX2,5MX200GR CHIC/ ROSINH
 Código: 42007 Fábrica: SANTA FE Unidade: RL/2,5
 F1 F4

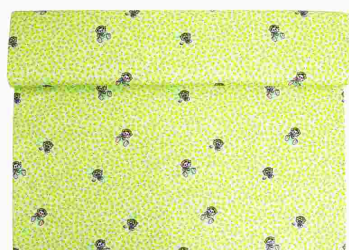

FELTRO EST 140CMX2,5MX200GR CHICO B GOIA
 Código: 41989 Fábrica: SANTA FE Unidade: RL/2,5
 F1 F4



FELTRO EST 140CMX2,5MX200GR MAGALI
 Código: 41986 Fábrica: SANTA FE Unidade: RL/2,5
 F1 F4



FELTRO EST 140CMX2,5MX200GR MONICA CORAC
 Código: 41990 Fábrica: SANTA FE Unidade: RL/2,5
 F1 F4

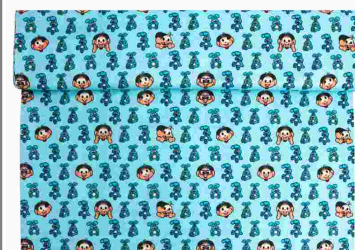

FELTRO EST 140CMX2,5MX200GR MONICA SANSAL
 Código: 41997 Fábrica: SANTA FE Unidade: RL/2,5
 F1 F4



FELTRO EST 140CMX2,5MX200GR QUADRINHOS
 Código: 41991 Fábrica: SANTA FE Unidade: RL/2,5
 F1 F4



FELTRO EST 140CMX2,5MX200GR SANSAL
 Código: 41995 Fábrica: SANTA FE Unidade: RL/2,5
 F1 F4

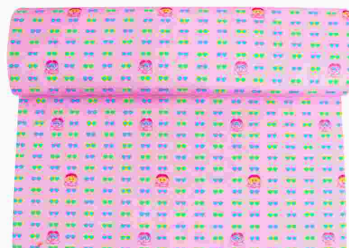

FELTRO EST 140CMX4 CORES 10 T MONICA
 Código: 41988 Fábrica: SANTA FE Unidade: RL/1
 F1 F4

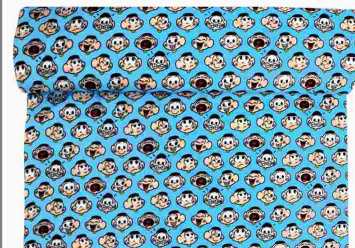

FELTRO EST 140CMX5MX200GR CASCAO
 Código: 41996 Fábrica: SANTA FE Unidade: RL/1
 F1 F4



FELTRO EST 140CMX5MX200GR MAGALI LISTRAS
 Código: 41994 Fábrica: SANTA FE Unidade: RL/1
 F1 F4



FELTRO LISO 140CMX10MX200GR AMARELO CITR
 Código: 42006 Fábrica: SANTA FE Unidade: RL/1
 F1 F4



FELTRO LISO 140CMX10MX200GR AZUL CLARO
 Código: 41998 Fábrica: SANTA FE Unidade: RL/1
 F1 F4

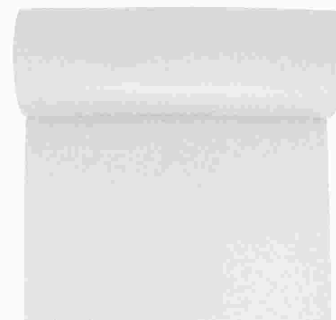

FELTRO LISO 140CMX10MX200GR BRANCO
 Código: 42002 Fábrica: SANTA FE Unidade: RL/1
 F1 F4



FELTRO LISO 140CMX10MX200GR LARANJA
 Código: 42000 Fábrica: SANTA FE Unidade: RL/1
 F1 F4



FELTRO LISO 140CMX10MX200GR MARROM
 Código: 42001 Fábrica: SANTA FE Unidade: RL/1
 F1 F4

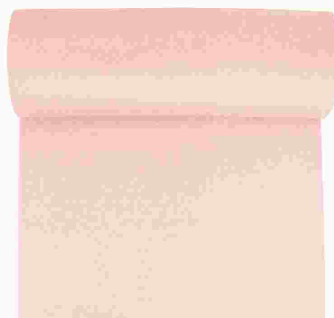

FELTRO LISO 140CMX10MX200GR NUDE
 Código: 42003 Fábrica: SANTA FE Unidade: RL/1
 F1 F4



FELTRO LISO 140CMX10MX200GR ROSA NASCENT
 Código: 42004 Fábrica: SANTA FE Unidade: RL/1
 F1 F4



FELTRO LISO 140CMX10MX200GR VERDE BILHAR
 Código: 47836 Fábrica: SANTA FE Unidade: RL/1
 F1 F4



FICHA CONTAS CORRENTES 5X8 6127-5 100X1
 Código: 28593 Fábrica: SAO DOMINGOS Unidade: CE/100
 F1 F4

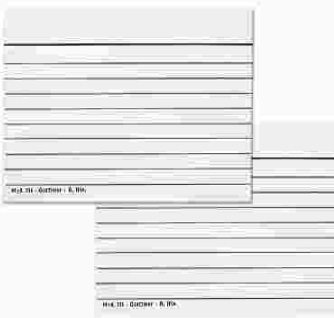

FICHA PAUTADA 3"X5" 100X1
 Código: 17973 Fábrica: PARKKE Unidade: PT/100
 F1 F4



FICHA PAUTADA 4"X6" 100X1
 Código: 17974 Fábrica: PARRKE Unidade: PT/100
 F1 F4

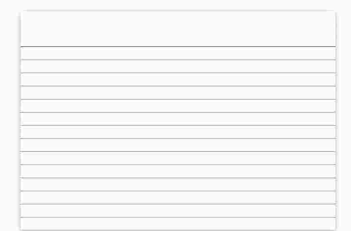

FICHA PAUTADA 5"X8" 100X1
 Código: 17975 Fábrica: PARKKE Unidade: PT/100
 F1 F4



FICHA PAUTADA 6"X9" 100X1
 Código: 14426 Fábrica: GRIFFE Unidade: PT/100
 F1 F4



FICHARIO COMPLETO MICKEY/MINNIE
 Código: 13395 Fábrica: TILIBRA Unidade: UN/1
 F1 F4



FICHARIO P/FICHAS 4"X6" C/INDICE 922
 Código: 31474 Fábrica: ACRIMET Unidade: UN/1
 F1 F4



FICHARIO P/FICHAS 6''X9'' C/ÍNDICE M74
 Código: 43534 Fábrica: MENNO Unidade: UN/1
 F1 F4



FICHARIO TRANSPARENTE
 Código: 12566 Fábrica: ACP Unidade: UN/1
 F1 F4

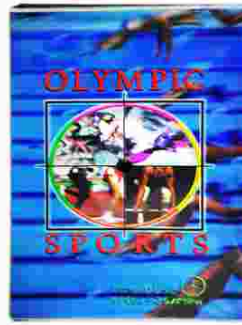

FICHARIO UNIVERS OLYMPIC-SCRAPBOOK 316/A
 Código: 3756 Fábrica: ACP Unidade: UN/1
 F1 F4

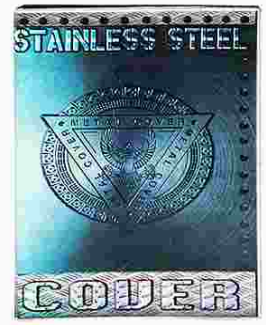

FICHARIO UNIVERS RUSTY STE TEXTURE 316 D
 Código: 10071 Fábrica: ACP Unidade: UN/1
 F1 F4

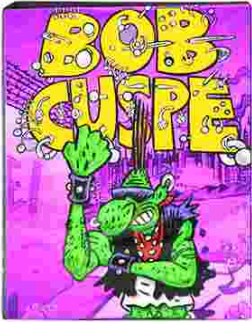

FICHARIO UNIVERSITARIO ANGELI 4089 SKRO
 Código: 19338 Fábrica: FORONI Unidade: UN/1
 F1 F4

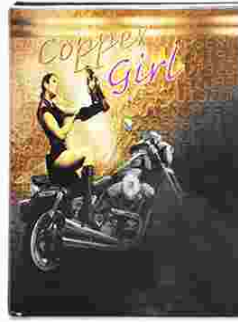

FICHARIO UNIVERSITARIO GIRL 316C
 Código: 19335 Fábrica: ACP Unidade: UN/1
 F1 F4



FICHARIO UNIVERSITARIO JEANS FASHION316B
 Código: 19334 Fábrica: ACP Unidade: UN/1
 F1 F4



FICHARIO UNIVERSITARIO 4 ARGOL PRETO 316
 Código: 19337 Fábrica: ACP Unidade: UN/1
 F1 F4



FICHARIO 2 ARGOLAS
 Código: 45965 Fábrica: ACP Unidade: UN/1
 F1 F4



FICHARIO 4 ARGOLAS
 Código: 6424 Fábrica: LOMY Unidade: UN/1
 F1 F4

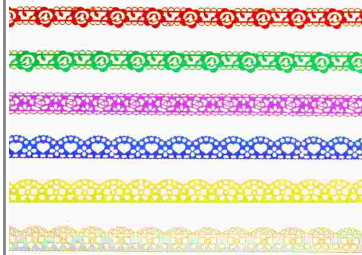

FITA ADES DECORATIVA 1,8CMX100MM 20135
 Código: 45944 Fábrica: WIN PAPER Unidade: RL/1
 F1 F4



FITA ADES MINI DEC BRILHANTE C/SUP 9X1
 Código: 34793 Fábrica: AGUIA BRANCA Unidade: CR/1
 F1 F4



FITA ADES PEQ DECORAD 15MMX2,6MTS 5X1
 Código: 42803 Fábrica: INTERPOTENTE Unidade: PT/5
 F1 F4



FITA ADES WASHI 15MMX3M GOLD 234 6X1
 Código: 40276 Fábrica: LYKE Unidade: CR/6
 F1 F4



FITA ADES 12MMX10 MTS AZUL 10X1
 Código: 6202 Fábrica: FITPEL/ADELB Unidade: PT/10
 F1 F4



FITA ADES 12MMX10 MTS BRANCO 10X1
 Código: 6204 Fábrica: FIT-PEL Unidade: PT/10
 F1 F4



FITA ADES 12MMX10MTS LARANJA 10X1
 Código: 15564 Fábrica: FIT-PEL Unidade: PT/10
 F1 F4



FITA ADES 12MMX10MTS LILAS 10X1
 Código: 35944 Fábrica: FIT-PEL Unidade: PT/10
 F1 F4



FITA ADES 12MMX10MTS PRATA 10X1
 Código: 6544 Fábrica: FIT-PEL Unidade: PT/10
 F1 F4



FITA ADES 12MMX10MTS ROSA 10X1
 Código: 15565 Fábrica: FITPEL/ADELB Unidade: PT/10
 F1 F4



FITA ADES 12MMX10MTS SORT POTE 72X1
 Código: 46830 Fábrica: BRW Unidade: CJ/72
 F1 F4



FITA ADES 12MMX10MTS TRANSPARENT 10X1
 Código: 356 Fábrica: FIT-PEL Unidade: PT/10
 F1 F4



FITA ADES 12MMX10MTS VERDE 10X1
 Código: 6203 Fábrica: FIT-PEL Unidade: PT/10
 F1 F4



FITA ADES 12MMX10MTS VERMELHO 10X1
 Código: 358 Fábrica: FITPEL/ADELB Unidade: PT/10
 F1 F4



FITA ADES 12MMX18MTS METALI SORT 12X1
 Código: 34679 Fábrica: HAI BRASIL Unidade: PT/4
 F1 F4



FITA ADES 12MMX20MTS TRANSPARENT 10X1
 Código: 2984 Fábrica: FIT-PEL Unidade: PT/10
 F1 F4



FITA ADES 12MMX30MTS TRANSP 7495 10X1
 Código: 5827 Fábrica: YINS/KORETCH Unidade: PT/10
 F1 F4



FITA ADES 12MMX33MTS AMARELO FLU 10X1
 Código: 31539 Fábrica: FIT-PEL Unidade: PT/10
 F1 F4



FITA ADES 12MMX33MTS AMARELO 10X1
 Código: 31537 Fábrica: FIT-PEL Unidade: PT/10
 F1 F4



FITA ADES 12MMX33MTS AZUL 10X1
 Código: 43710 Fábrica: FIT-PEL Unidade: PT/10
 F1 F4



FITA ADES 12MMX33MTS BRANCO 10X1
 Código: 31543 Fábrica: FIT-PEL Unidade: PT/10
 F1 F4



FITA ADES 12MMX33MTS INVISI C/SUP PTO
 Código: 33630 Fábrica: KORES Unidade: UN/1
 F1 F4

106 cm



FITA ADES 12MMX33MTS LILAS 10X1

Código: **31536** Fábrica: **FIT-PEL** Unidade: **PT/10**
F1 F4



FITA ADES 12MMX33MTS PRETO 10X1

Código: **31542** Fábrica: **FIT-PEL** Unidade: **PT/10**
F1 F4



FITA ADES 12MMX33MTS ROSA FLUOR 10X1

Código: **31544** Fábrica: **FIT-PEL** Unidade: **PT/10**
F1 F4



FITA ADES 12MMX33MTS TRANSP C/SUP VERMEL

Código: **33255** Fábrica: **KORES** Unidade: **UN/1**
F1 F4



FITA ADES 12MMX33MTS VERDE FLUOR 10X1

Código: **31541** Fábrica: **FIT-PEL** Unidade: **PT/10**
F1 F4



FITA ADES 12MMX33MTS VERDE 10X1

Código: **31540** Fábrica: **FIT-PEL** Unidade: **PT/10**
F1 F4



FITA ADES 12MMX33MTS VERMELHO 10X1

Código: **43711** Fábrica: **FIT-PEL** Unidade: **PT/10**
F1 F4



FITA ADES 12MMX40MTS TRANSPARENTE UN

Código: **33914** Fábrica: **KORES** Unidade: **UN/1**
F1 F4



FITA ADES 12MMX40MTS TRANSPARENTE 10X1

Código: **19321** Fábrica: **KORETECH** Unidade: **PT/10**
F1 F4



FITA ADES 12MMX65MTS TRANSPARENT 10X1

Código: **32699** Fábrica: **KORETECH** Unidade: **PT/10**
F1 F4



FITA ADES 15MMX3MTS C/GLITER 2011 6X1

Código: **44808** Fábrica: **WIN PAPER** Unidade: **CX/6**
F1 F4



FITA ADES 18MMX50MTS TRANSP 43 7X1

Código: **49895** Fábrica: **ALLTAPE** Unidade: **PT/7**
F1 F4



FITA ADES 19MMX33MTS INVISIVEL 20018

Código: **48387** Fábrica: **WIN PAPER** Unidade: **CR/1**
F1 F4



FITA ADES 24MMX50MTS TRANSP 44 5X1

Código: **49893** Fábrica: **ALLTAPE** Unidade: **PT/5**
F1 F4



FITA ADES 45MMX1200MTS TRANSPARENTE

Código: **42204** Fábrica: **HAI BRASIL** Unidade: **UN/1**
F1 F4



FITA ADES 45MMX150MTS TRANSPARENTE

Código: **42203** Fábrica: **HAI BRASIL** Unidade: **UN/1**
F1 F4



FITA ADES 45MMX200MTS TRANSPARENTE

Código: 42202 Fábrica: HAI BRASIL Unidade: UN/1 F1 F4



FITA ADES 45MMX30MTS MARROM 5X1

Código: 43332 Fábrica: KORETECH Unidade: PT/5 F1 F4



FITA ADES 45MMX30MTS TRANSPARENTE 5X1

Código: 43331 Fábrica: KORETECH Unidade: PT/5 F1 F4



FITA ADES 45MMX300MTS TRANSPARENTE

Código: 38431 Fábrica: HAI BRASIL Unidade: UN/1 F1 F4



FITA ADES 45MMX35MTS COR SORT 468 6X1

Código: 27729 Fábrica: HAI BRASIL Unidade: PT/6 F1 F4



FITA ADES 45MMX40MTS AMARELO 5X1

Código: 43347 Fábrica: KORETECH Unidade: PT/5 F1 F4



FITA ADES 45MMX40MTS AZUL 5X1

Código: 43344 Fábrica: KORETECH Unidade: PT/5 F1 F4



FITA ADES 45MMX40MTS BRANCA 5X1

Código: 43342 Fábrica: KORETECH Unidade: PT/5 F1 F4



FITA ADES 45MMX40MTS MARROM 5X1

Código: 43349 Fábrica: KORETECH Unidade: PT/5 F1 F4



FITA ADES 45MMX40MTS PRETA 5X1

Código: 43343 Fábrica: KORETECH Unidade: PT/5 F1 F4



FITA ADES 45MMX40MTS TRANSP 710 4X1

Código: 42206 Fábrica: ADERE Unidade: PT/4 F1 F4



FITA ADES 45MMX40MTS TRANSPARENTE 5X1

Código: 43348 Fábrica: KORETECH Unidade: PT/5 F1 F4



FITA ADES 45MMX40MTS VERDE 5X1

Código: 43345 Fábrica: KORETECH Unidade: PT/5 F1 F4



FITA ADES 45MMX40MTS VERMELHO 5X1

Código: 43346 Fábrica: KORETECH Unidade: PT/5 F1 F4



FITA ADES 45MMX45MTS MARROM 5X1

Código: 4161 Fábrica: FIT-PEL/KORE Unidade: PT/5 F1 F4



FITA ADES 45MMX45MTS MARROM 5X1

Código: 40211 Fábrica: TIGHT TAPE Unidade: PT/5 F1 F4



FITA ADES 45MMX45MTS TRANSPARENTE UN

Código: **42434** Fábrica: **FIT PEL** Unidade: **UN/1**
F1 F4

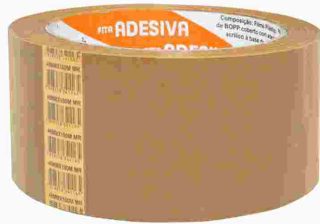

FITA ADES 48MMX100MTS MARROM 5X1

Código: **43337** Fábrica: **KORETECH** Unidade: **PT/5**
F1 F4



FITA ADES 48MMX30M DEMARC SOLO AMA/PT 80

Código: **44320** Fábrica: **ALLTAPE** Unidade: **RL/1**
F1 F4



FITA ADES 48MMX30M DEMARC SOLO AMAREL 71

Código: **44318** Fábrica: **ALLTAPE** Unidade: **RL/1**
F1 F4



FITA ADES 48MMX30M DEMARC SOLO AZUL 83

Código: **44315** Fábrica: **ALLTAPE** Unidade: **RL/1**
F1 F4



FITA ADES 48MMX30M DEMARC SOLO BRANCA 81

Código: **44316** Fábrica: **ALLTAPE** Unidade: **RL/1**
F1 F4



FITA ADES 48MMX30M DEMARC SOLO VERDE 82

Código: **44317** Fábrica: **ALLTAPE** Unidade: **RL/1**
F1 F4



FITA ADES 48MMX30M DEMARC SOLO VERM 72

Código: **44319** Fábrica: **ALLTAPE** Unidade: **RL/1**
F1 F4



FITA ADES 48MMX40MTS METALIZADA 5X1

Código: **43334** Fábrica: **KORETECH** Unidade: **PT/5**
F1 F4



FITA ADES 48MMX40MTS TRANSPARENTE 4X1

Código: **31612** Fábrica: **ADELBRAS** Unidade: **PT/4**
F1 F4



FITA ADES 48MMX45MTS MARROM 5X1

Código: **43336** Fábrica: **KORETECH** Unidade: **PT/5**
F1 F4



FITA ADES 48MMX45MTS TRANSPARENTE 5X1

Código: **43335** Fábrica: **KORETECH** Unidade: **PT/5**
F1 F4



FITA ADES 48MMX5MTS PRATA UN

Código: **49397** Fábrica: **TEK BOND** Unidade: **UN/1**
F1 F4



FITA ADES 48MMX50MTS TRANSP 4X1

Código: **44314** Fábrica: **ALLTAPE** Unidade: **PT/4**
F1 F4



FITA CORRETIVA 5MMX10MTS CTL 242201

Código: **44108** Fábrica: **FUTURO** Unidade: **CR/1**
F1 F4



FITA CORRETIVA 5MMX10MTS 91416

Código: **50648** Fábrica: **JOCAROFFICE** Unidade: **CR/1**
F1 F4



FITA CORRETIVA 5MMX12MTS PRIME 1003

Código: 44986
 Fábrica: BRW
 Unidade: CR/1
 F1 F4



FITA CORRETIVA 5MMX12MTS 437

Código: 46545
 Fábrica: MASTERPRINT
 Unidade: UN/1
 F1 F4



FITA CORRETIVA 5MMX6MTS CTL 1002

Código: 34108
 Fábrica: BRW
 Unidade: CR/1
 F1 F4



FITA CORRETIVA 5MMX6MTS 436

Código: 40786
 Fábrica: MASTERPRINT
 Unidade: CR/1
 F1 F4



FITA CREPE 18MMX40MTS USO GERAL 5X1

Código: 48113
 Fábrica: JUSSARA
 Unidade: PT/5
 F1 F4



FITA CREPE 18MMX50MTS USO GERAL 5X1

Código: 48114
 Fábrica: JUSSARA
 Unidade: PT/5
 F1 F4



FITA CREPE 18MMX50MTS USO GERAL 5X1

Código: 48649
 Fábrica: TEK BOND
 Unidade: PT/5
 F1 F4



FITA CREPE 18MMX50MTS USO GERAL 81 8X1

Código: 49891
 Fábrica: ALLTAPE
 Unidade: PT/8
 F1 F4



FITA CREPE 24MMX50MTS USO GERAL 5X1

Código: 48650
 Fábrica: TEK BOND
 Unidade: PT/5
 F1 F4

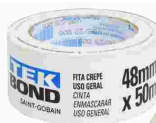

FITA CREPE 48MMX50MTS USO GERAL 1X1

Código: 48651
 Fábrica: TEK BOND
 Unidade: UN/1
 F1 F4



FITA CREPE 48MMX50MTS USO GERAL 83 3X1

Código: 44313
 Fábrica: ALLTAPE
 Unidade: PT/3
 F1 F4



FITA DEC 25MMX10MTS ROSA BRILHO

Código: 43387
 Fábrica: VMP
 Unidade: RL/1
 F1 F4



FITA DEC 38MMX10MTS AZUL ESTAMP BOLINHAS

Código: 43385
 Fábrica: VMP
 Unidade: RL/1
 F1 F4



FITA DEC 38MMX10MTS AZUL ESTAMP PRATA

Código: 43382
 Fábrica: VMP
 Unidade: RL/1
 F1 F4



FITA DEC 38MMX10MTS BRANCO C/ GLITER

Código: 43383
 Fábrica: VMP
 Unidade: RL/1
 F1 F4



FITA DEC 38MMX10MTS ESTAMP NATAL

Código: 43381
 Fábrica: VMP
 Unidade: RL/1
 F1 F4



FITA DEC 38MMX10MTS LILAS ESTAMP OURO

Código: 43380 Fábrica: VMP Unidade: RL/1
F1 F4



FITA DEC 38MMX10MTS OURO ESTAMP

Código: 43378 Fábrica: VMP Unidade: RL/1
F1 F4



FITA DEC 63MMX10MTS BRANCO C/ GLITER

Código: 43388 Fábrica: VMP Unidade: RL/1
F1 F4



FITA DEC 63MMX10MTS OURO ESTAMP

Código: 43377 Fábrica: VMP Unidade: RL/1
F1 F4



FITA DECORATIVA 15MMX50MTS 01 BRANCO

Código: 31522 Fábrica: NIZURI Unidade: RL/1
F1 F4



FITA DECORATIVA 15MMX50MTS 11 DOURADO

Código: 31524 Fábrica: NIZURI Unidade: RL/1
F1 F4



FITA DECORATIVA 15MMX50MTS 12 ROSA PINK

Código: 31526 Fábrica: NIZURI Unidade: RL/1
F1 F4



FITA DECORATIVA 15MMX50MTS 15 LILAS

Código: 32982 Fábrica: NIZURI Unidade: RL/1
F1 F4



FITA DECORATIVA 15MMX50MTS 19 PRETO

Código: 31528 Fábrica: NIZURI Unidade: RL/1
F1 F4



FITA DECORATIVA 15MMX50MTS 20 VERDE LIMA

Código: 32981 Fábrica: NIZURI Unidade: RL/1
F1 F4



FITA DECORATIVA 15MMX50MTS 22 ROSA

Código: 31529 Fábrica: NIZURI Unidade: RL/1
F1 F4



FITA DECORATIVA 21MMX50MTS 01 BRANCO

Código: 32984 Fábrica: NIZURI Unidade: RL/1
F1 F4



FITA DECORATIVA 30MMX50MTS 01 BRANCO

Código: 47175 Fábrica: NIZURI/RAIO Unidade: RL/1
F1 F4



FITA DECORATIVA 30MMX50MTS 11 DOURADO

Código: 47180 Fábrica: NIZURI/RAIO Unidade: RL/1
F1 F4



FITA DECORATIVA 30MMX50MTS 12 PINK

Código: 47181 Fábrica: NIZURI/RAIO Unidade: RL/1
F1 F4



FITA DECORATIVA 30MMX50MTS 17 LILAS

Código: 47182 Fábrica: NIZURI/RAIO Unidade: RL/1
F1 F4



FITA DECORATIVA 32MMX50MTS 07 VERDE MILI
 Código: 47183 Fábrica: NIZURI Unidade: RL/1
 F1 F4



FITA DECORATIVA 32MMX50MTS 10 PRATA
 Código: 47178 Fábrica: NIZURI Unidade: RL/1
 F1 F4



FITA DECORATIVA 32MMX50MTS 19 PRETO
 Código: 47177 Fábrica: NIZURI Unidade: RL/1
 F1 F4



FITA DUPLA FACE 5MMX20MT SOLAPA 520
 Código: 47421 Fábrica: HAI BRASIL Unidade: UN/1
 F1 F4



FITA DUPLA FACE ACR INT 19MMX20MTS
 Código: 50753 Fábrica: TEK BOND Unidade: UN/1
 F1 F4



FITA DUPLA FACE ESPUMA 18MMX2M CTL D2
 Código: 38224 Fábrica: HAI BRASIL Unidade: CR/1
 F1 F4



FITA DUPLA FACE ESPUMA 18MMX5M CTL 53007
 Código: 50127 Fábrica: ALFACELL Unidade: CR/1
 F1 F4



FITA DUPLA FACE EXTRA FORTE VERD 24MMX2M
 Código: 47935 Fábrica: YIN'S PAPER Unidade: RL/1
 F1 F4



FITA DUPLA FACE 12MMX30MTS 581 10X1
 Código: 49889 Fábrica: ALLTAPE Unidade: PT/10
 F1 F4



FITA DUPLA FACE 18MMX2MTS SILICONE CTL
 Código: 45539 Fábrica: WINMAX Unidade: UN/1
 F1 F4



FITA DUPLA FACE 18MMX30MTS 581 6X1
 Código: 50306 Fábrica: ALLTAPE Unidade: PT/6
 F1 F4



FITA MAQUINA ESCRIVER OLIVETTI 13X8MM
 Código: 45123 Fábrica: MASTERPRINT Unidade: UN/1
 F1 F4



FITA METALOIDE 15MMX50MTS HOLOGRAFI 10X1
 Código: 36610 Fábrica: BRW Unidade: RL/10
 F1 F4



FITA METALOIDE 15MMX50MTS VERDE 6X1
 Código: 35349 Fábrica: BRW Unidade: RL/10
 F1 F4



FITA NYLON P/IMPRESSORA MATRICIAL LX350
 Código: 44332 Fábrica: MASTERPRINT Unidade: UN/1
 F1 F4



FITA P/CALCULADORA SHARP PRETA/VERMELHO
 Código: 47221 Fábrica: MASTERPRINT Unidade: UN/1
 F1 F4



FITA P/IMPRESSORA EPSON FX2190 13MMX14MT
 Código: 41956 Fábrica: MASTERPRINT Unidade: UN/1
 F1 F4



FITA P/IMPRESSORA EPSON MX80 MATRICIAL
 Código: 14350 Fábrica: MASTERPRINT Unidade: UN/1
 F1 F4



FITILHO DECORAT 5MMX50MTS AMARELO 10X1
 Código: 18286 Fábrica: SAO VITOR Unidade: PT/10
 F1 F4



FITILHO DECORAT 5MMX50MTS AZUL BB 10X1
 Código: 34561 Fábrica: SAO VITOR Unidade: PT/10
 F1 F4



FITILHO DECORAT 5MMX50MTS AZUL 10X1
 Código: 18284 Fábrica: SAO VITOR Unidade: PT/10
 F1 F4



FITILHO DECORAT 5MMX50MTS BRANCO 10X1
 Código: 18279 Fábrica: SAO VITOR Unidade: PT/10
 F1 F4



FITILHO DECORAT 5MMX50MTS CHAMPAGNE 10X1
 Código: 41922 Fábrica: SAO VITOR Unidade: PT/10
 F1 F4



FITILHO DECORAT 5MMX50MTS DOURADO 10X1
 Código: 18278 Fábrica: SAO VITOR Unidade: PT/10
 F1 F4



FITILHO DECORAT 5MMX50MTS GEMA 10X1
 Código: 41877 Fábrica: SAO VITOR Unidade: PT/10
 F1 F4



FITILHO DECORAT 5MMX50MTS GOIABA 10X1
 Código: 41924 Fábrica: SAO VITOR Unidade: PT/10
 F1 F4



FITILHO DECORAT 5MMX50MTS LARANJA 10X1
 Código: 18303 Fábrica: SAO VITOR Unidade: PT/10
 F1 F4



FITILHO DECORAT 5MMX50MTS LILAS 10X1
 Código: 18276 Fábrica: SAO VITOR Unidade: PT/10
 F1 F4



FITILHO DECORAT 5MMX50MTS MARRON 10X1
 Código: 19783 Fábrica: SAO VITOR Unidade: PT/10
 F1 F4



FITILHO DECORAT 5MMX50MTS PRETO 10X1
 Código: 18282 Fábrica: SAO VITOR Unidade: PT/10
 F1 F4



FITILHO DECORAT 5MMX50MTS ROSA PINK 10X1
 Código: 18277 Fábrica: SAO VITOR Unidade: PT/10
 F1 F4



FITILHO DECORAT 5MMX50MTS ROSA 10X1
 Código: 18304 Fábrica: SAO VITOR Unidade: PT/10
 F1 F4



FITILHO DECORAT 5MMX50MTS ROXO 10X1

Código: 41921 Fábrica: SAO VITOR Unidade: PT/10 F1 F4



FITILHO DECORAT 5MMX50MTS RUBRO 10X1

Código: 41913 Fábrica: SAO VITOR Unidade: PT/10 F1 F4



FITILHO DECORAT 5MMX50MTS SORTIDO 10X1

Código: 18305 Fábrica: SAO VITOR Unidade: PT/10 F1 F4



FITILHO DECORAT 5MMX50MTS VERDE LM 10X1

Código: 41911 Fábrica: SAO VITOR Unidade: PT/10 F1 F4



FITILHO DECORAT 5MMX50MTS VERDE MIL 10X1

Código: 18287 Fábrica: SAO VITOR Unidade: PT/10 F1 F4



FITILHO DECORAT 5MMX50MTS VERDE OLI 10X1

Código: 18288 Fábrica: SAO VITOR Unidade: PT/10 F1 F4



FITILHO DECORAT 5MMX50MTS VERDE 10X1

Código: 18274 Fábrica: SAO VITOR Unidade: PT/10 F1 F4



FITILHO DECORAT 5MMX50MTS VERMELHO 10X1

Código: 18281 Fábrica: SAO VITOR Unidade: PT/10 F1 F4



FITILHO DECORAT 5MMX50MTS VINHO 10X1

Código: 41923 Fábrica: SAO VITOR Unidade: PT/10 F1 F4



FORMA PLAST GELO 12 CUBOS FDO SILIC 0215

Código: 40316 Fábrica: WINCY Unidade: UN/1 F1 F4



FOSFORO DE SEGURANCA 10X40

Código: 49698 Fábrica: SABIA Unidade: PT/10 F1 F4

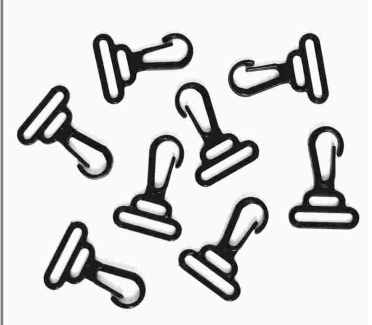

GANCHO PLAST P/CARTAO PRETO 100X1

Código: 47735 Fábrica: ITALY'S Unidade: PT/100 F1 F4



GIZ CERA 6 CORES 24 GRS FINO 1018 12X1

Código: 42618 Fábrica: SERELEPE Unidade: PT/12 F1 F4



GIZ CERA 6 CORES 185 GRS MEU 1º GIZ 3X1

Código: 42135 Fábrica: ACRILEX Unidade: PT/3 F1 F4



GIZ CERA 6 CORES 56 GRS BIG 12X1

Código: 42133 Fábrica: ACRILEX Unidade: PT/12 F1 F4



GIZ CERA 12 CORES

Código: 34442 Fábrica: SERELEPE Unidade: UN/1 F1 F4



GIZ CERA 12 CORES 48 GRS FINO 1019 12X1
 Código: 42619 Fábrica: SERELEPE Unidade: PT/12 F1 F4



GIZ CERA 12 CORES 48 GRS 12X1
 Código: 42137 Fábrica: ACRILEX Unidade: PT/12 F1 F4



GIZ CERA 12 CORES GROSSO GDE 062203
 Código: 44072 Fábrica: FUTURO Unidade: CX/1 F1 F4



GIZ CERA 12 CORES 118 GRS BIG 4462 UN
 Código: 46349 Fábrica: LEO&LEO Unidade: UN/1 F1 F4



GIZ CERA 12 CORES 370 GRS JUMBO UN
 Código: 47437 Fábrica: ACRILEX Unidade: UN/1 F1 F4



GIZ CERA 12 CORES 370 GRS MEU 1º GIZ 3X1
 Código: 42136 Fábrica: ACRILEX Unidade: PT/3 F1 F4



GIZ CERA 12 CORES 510 GRS BIG 752612
 Código: 49267 Fábrica: COLORARE Unidade: CX/1 F1 F4



GIZ CERA 12 CORES 95 GRS BIG TRIANG 12X1
 Código: 42139 Fábrica: ACRILEX Unidade: PT/12 F1 F4



GIZ ESCOLAR BRANCO ANTIALÉRGICO 50X1
 Código: 24040 Fábrica: DELTA/ZIGGIZ Unidade: CX/50 F1 F4



GIZ ESCOLAR BRANCO ANTIALÉRGICO 64X1
 Código: 7312 Fábrica: DELTA2 Unidade: CX/64 F1 F4



GIZ ESCOLAR COLORIDO ANTIALÉRGICO 50X1
 Código: 24041 Fábrica: DELTA Unidade: CX/50 F1 F4



GIZ ESCOLAR COLORIDO 64X1
 Código: 7395 Fábrica: DELTA Unidade: CX/64 F1 F4



GIZ PASTEL OLEO 12 CORES
 Código: 46341 Fábrica: CIS Unidade: UN/1 F1 F4



GIZ PASTEL OLEO 24 CORES
 Código: 47779 Fábrica: CIS Unidade: UN/1 F1 F4



GIZ PASTEL OLEO 36 CORES
 Código: 47780 Fábrica: CIS Unidade: UN/1 F1 F4



GIZ P/TACO SINUCA BILHAR 144X1
 Código: 50275 Fábrica: 7BELO Unidade: CX/1 F1 F4



GIZAO CERA 6 CORES 230 GRS 1 INFAN 4318
 Código: Fábrica: Unidade:
47392 LEO&LEO CX/1
 F1 F4



GLITER 3 GRS AZUL CLARO 12X1
 Código: Fábrica: Unidade:
45060 CITY BRILHO CX/12
 F1 F4



GLITER 3 GRS AZUL 12X1
 Código: Fábrica: Unidade:
7465 CITY BRILHO CX/12
 F1 F4

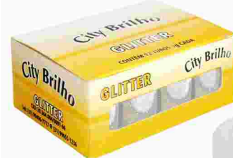

GLITER 3 GRS BRANCO PEROLADO 12X1
 Código: Fábrica: Unidade:
7468 CITY BRILHO CX/12
 F1 F4



GLITER 3 GRS DOURADO 12X1
 Código: Fábrica: Unidade:
7463 CITY BRILHO CX/12
 F1 F4



GLITER 3 GRS LARANJA 12X1
 Código: Fábrica: Unidade:
26418 CITY BRILHO CX/12
 F1 F4



GLITER 3 GRS LILAS 12X1
 Código: Fábrica: Unidade:
15677 CITY BRILHO CX/12
 F1 F4



GLITER 3 GRS PINK 12X1
 Código: Fábrica: Unidade:
15675 CITY BRILHO CX/12
 F1 F4



GLITER 3 GRS PRATA 12X1
 Código: Fábrica: Unidade:
7464 CITY BRILHO CX/12
 F1 F4



GLITER 3 GRS PRETO 12X1
 Código: Fábrica: Unidade:
12770 CITY BRILHO CX/12
 F1 F4



GLITER 3 GRS ROSA 12X1
 Código: Fábrica: Unidade:
7467 CITY BRILHO CX/12
 F1 F4



GLITER 3 GRS ROXO 12X1
 Código: Fábrica: Unidade:
15676 CITY BRILHO CX/12
 F1 F4



GLITER 3 GRS SORTIDO 12X1
 Código: Fábrica: Unidade:
47723 CITY BRILHO CX/12
 F1 F4



GLITER 3 GRS VERDE 12X1
 Código: Fábrica: Unidade:
7466 CITY BRILHO CX/12
 F1 F4



GLITER 3 GRS VERMELHO 12X1
 Código: Fábrica: Unidade:
26 CITY BRILHO CX/12
 F1 F4



GLITER 100 GRS AZUL
 Código: Fábrica: Unidade:
15534 CITY BRILHO PT/1
 F1 F4



GLITER 100 GRS LILAS

Código: **9805** Fábrica: **CITY BRILHO** Unidade: **PT/1 F1 F4**



GLITER 100 GRS PEROLADO

Código: **26345** Fábrica: **CITY BRILHO** Unidade: **PT/1 F1 F4**



GLITER 100 GRS PINK

Código: **15533** Fábrica: **CITY BRILHO** Unidade: **PT/1 F1 F4**



GLITER 100 GRS PRATA

Código: **15531** Fábrica: **CITY BRILHO** Unidade: **PT/1 F1 F4**



GLITER 100 GRS VERMELHO

Código: **15532** Fábrica: **CITY BRILHO** Unidade: **PT/1 F1 F4**



GLITER 500 GRS AZUL

Código: **42453** Fábrica: **CITY BRILHO** Unidade: **PT/1 F1 F4**



GLITER 500 GRS AZUL CLARO

Código: **50012** Fábrica: **CITY BRILHO** Unidade: **PT/1 F1 F4**



GLITER 500 GRS BRONZE

Código: **50010** Fábrica: **CITY BRILHO** Unidade: **PT/1 F1 F4**



GLITER 500 GRS CHUMBO

Código: **50015** Fábrica: **CITY BRILHO** Unidade: **PT/1 F1 F4**



GLITER 500 GRS LARANJA

Código: **50014** Fábrica: **CITY BRILHO** Unidade: **PT/1 F1 F4**



GLITER 500 GRS LILAS

Código: **44168** Fábrica: **CITY BRILHO** Unidade: **PT/1 F1 F4**



GLITER 500 GRS MARROM

Código: **50011** Fábrica: **CITY BRILHO** Unidade: **PT/1 F1 F4**



GLITER 500 GRS OURO/AMARELO

Código: **41879** Fábrica: **CITY BRILHO** Unidade: **PT/1 F1 F4**



GLITER 500 GRS PEROLADO

Código: **41881** Fábrica: **CITY BRILHO** Unidade: **PT/1 F1 F4**



GLITER 500 GRS PINK

Código: **50009** Fábrica: **CITY BRILHO** Unidade: **PT/1 F1 F4**



GLITER 500 GRS PRATA

Código: **41880** Fábrica: **CITY BRILHO** Unidade: **PT/1 F1 F4**



GLITER 500 GRS PRETO

Código: 44167
Fábrica: CITY BRILHO
Unidade: PT/1
F1 F4



GLITER 500 GRS ROSA

Código: 44133
Fábrica: CITY BRILHO
Unidade: PT/1
F1 F4



GLITER 500 GRS ROXO

Código: 50008
Fábrica: CITY BRILHO
Unidade: PT/1
F1 F4



GLITER 500 GRS VERDE

Código: 42454
Fábrica: CITY BRILHO
Unidade: PT/1
F1 F4



GLITER 500 GRS VERDE CLARO

Código: 50013
Fábrica: CITY BRILHO
Unidade: PT/1
F1 F4



GLITER 500 GRS VERMELHO

Código: 44169
Fábrica: CITY BRILHO
Unidade: PT/1
F1 F4



GOLA HIGIENICA BRANCA 6,6CM 5X100

Código: 48138
Fábrica: SEKICH
Unidade: PT/5
F1 F4



GRAFITE 0.5MM EST 20 MINAS BETTY B 24X1

Código: 38556
Fábrica: TRIS
Unidade: CX/24
F1 F4



GRAFITE 0.5MM HB COLOR EST 12 MINA 24X1

Código: 47994
Fábrica: MECHANICAL
Unidade: CX/24
F1 F4



GRAFITE 0.5MM HB EST 12 MINAS 12X1

Código: 43811
Fábrica: WIN PAPER
Unidade: PT/12
F1 F4



GRAFITE 0.5MM HB EST 12 MINAS 12X1

Código: 18932
Fábrica: GOLLER
Unidade: DZ/12
F1 F4



GRAFITE 0.5MM HB EST 12 MINAS 12X1

Código: 19716
Fábrica: CONCEPT
Unidade: DZ/12
F1 F4



GRAFITE 0.5MM HB EST 12 MINAS 12X1

Código: 7157
Fábrica: STYLO
Unidade: PT/12
F1 F4



GRAFITE 0.5MM HB EST 12 MINAS 12X1

Código: 6772
Fábrica: LEO&LEO
Unidade: CX/12
F1 F4



GRAFITE 0.5MM HB EST 12 MINAS 24X1

Código: 19561
Fábrica: CLASSE
Unidade: CX/24
F1 F4



GRAFITE 0.5MM HB EST 20 MINAS 24X1

Código: 47996
Fábrica: HANSA
Unidade: CX/24
F1 F4



GRAFITE 0.5MM HB EST 24 MINAS 12X1
 Código: 47995 Fábrica: CLASSE Unidade: CX/12 F1 F4



GRAFITE 0.5MM HB EST 30 MINAS 24X1
 Código: 19560 Fábrica: CLASSE Unidade: CX/24 F1 F4



GRAFITE 0.5MM 2B EST 12 MINAS 12X1
 Código: 7160 Fábrica: ADECK Unidade: CX/12 F1 F4



GRAFITE 0.5MM 2B EST 12 MINAS 24X1
 Código: 13072 Fábrica: CLASSE Unidade: CX/24 F1 F4



GRAFITE 0.5MM 2B EST 24 MINAS 12X1
 Código: 22178 Fábrica: CLASSE Unidade: CX/12 F1 F4



GRAFITE 0.7MM HB EST 12 MINAS 12X1
 Código: 2537 Fábrica: LEO&LEO Unidade: PT/12 F1 F4



GRAFITE 0.9MM HB EST 12 MINAS 12X1
 Código: 46791 Fábrica: UFFIZI Unidade: CX/12 F1 F4



GRAFITE 0.9MM HB EST 12 MINAS 12X1
 Código: 18699 Fábrica: GOLLER Unidade: PT/12 F1 F4



GRAFITE 0.9MM HB EST 12 MINAS 12X1
 Código: 47997 Fábrica: LEO&LEO Unidade: PT/12 F1 F4



GRAMPEADOR ALICATE METAL 25F 2153
 Código: 48849 Fábrica: FIRST Unidade: UN/1 F1 F4



GRAMPEADOR ALICATE METAL 15F+2000GRAM 10
 Código: 47889 Fábrica: SOON Unidade: UN/1 F1 F4



GRAMPEADOR ALICATE METAL 17CM 26/6 45F
 Código: 50679 Fábrica: WINPAPER Unidade: UN/1 F1 F4



GRAMPEADOR ALICATE METAL 24/6 20FLS 131
 Código: 43395 Fábrica: YIZHIWANG Unidade: UN/1 F1 F4



GRAMPEADOR ALICATE METAL 25FLS 93048
 Código: 39906 Fábrica: JOCAROFFICE Unidade: UN/1 F1 F4



GRAMPEADOR ALICATE METAL 26/6 20FLS 6014
 Código: 50680 Fábrica: WINPAPER Unidade: UN/1 F1 F4



GRAMPEADOR ALICATE METAL 26/6 25FLS 5227
 Código: 50208 Fábrica: BAZZE Unidade: UN/1 F1 F4



GRAMPEADOR ALICATE METAL 26/6 25FLS 887
 Código: 39780 Fábrica: MASTERPRINT Unidade: UN/1
 F1 F4



GRAMPEADOR ALICATE METAL 45F 24/26/6 158
 Código: 47924 Fábrica: YIN'S PAPER Unidade: UN/1
 F1 F4



GRAMPEADOR METAL EXTRA G 30CM 100FL 1069
 Código: 41762 Fábrica: GRAMP LINE Unidade: UN/1
 F1 F4



GRAMPEADOR METAL EXTRA GDE 100FLS 29CM
 Código: 41736 Fábrica: MASTERPRINT Unidade: UN/1
 F1 F4



GRAMPEADOR METAL MINI C/EXTRAT 16FLS 305
 Código: 39785 Fábrica: MASTERPRINT Unidade: UN/1
 F1 F4



GRAMPEADOR METAL PISTOL 106/6/8 14CM 600
 Código: 43195 Fábrica: BRW Unidade: UN/1
 F1 F4



GRAMPEADOR METAL PISTOL 13/4-8 15CM 6017
 Código: 50678 Fábrica: WIN PAPER Unidade: UN/1
 F1 F4



GRAMPEADOR METAL PROFIS 240FL BM2144
 Código: 48848 Fábrica: FIRST Unidade: UN/1
 F1 F4



GRAMPEADOR METAL 19,5CM 25FLS 400
 Código: 43394 Fábrica: MASTERPRINT Unidade: UN/1
 F1 F4



GRAMPEADOR METAL 20CM 30FLS 93016
 Código: 45229 Fábrica: JOCAROFFICE Unidade: UN/1
 F1 F4



GRAMPEADOR METAL 50FL 613031
 Código: 48811 Fábrica: BAZZE Unidade: PT/1
 F1 F4



GRAMPEADOR PISTOLA TAPECEIRO 15CM 98931
 Código: 46426 Fábrica: KAZ Unidade: UN/1
 F1 F4



GRAMPEADOR PISTOLA 23/4 13/4 24/6 15CM
 Código: 50331 Fábrica: FIRST Unidade: UN/1
 F1 F4



GRAMPEADOR PROF METAL 13/4-6-8 45FL 6028
 Código: 50681 Fábrica: WINPAPER Unidade: UN/1
 F1 F4



GRAMPEADOR PROF METAL 23/6-8 100FL 6015
 Código: 50685 Fábrica: WINPAPER Unidade: UN/1
 F1 F4



GRAMPEADOR TAPECEIRO 106/6 108/6 16CM 51
 Código: 50330 Fábrica: FIRST Unidade: UN/1
 F1 F4



GRAMPEADOR 106 METAL PROF TAPECARIA 16CM
 Código: 46382 Fábrica: FUTURO Unidade: UN/1
 F1 F4



GRAMPEADOR 23/06 A 23/24 METAL 30CM 240F
 Código: 46429 Fábrica: KAZ Unidade: UN/1
 F1 F4



GRAMPEADOR 23/24 METAL 29CM 240FL 262214
 Código: 46333 Fábrica: FUTURO Unidade: UN/1
 F1 F4



GRAMPEADOR 23/6 23/13 METAL 28,5CM 100FL
 Código: 44497 Fábrica: DOTAD Unidade: UN/1
 F1 F4



GRAMPEADOR 23/6/20/24 METAL 28CM 240FLS
 Código: 42582 Fábrica: BRW Unidade: UN/1
 F1 F4



GRAMPEADOR 23/6/8/10/ METAL 29CM 200FLS
 Código: 44238 Fábrica: MAXPRINT Unidade: UN/1
 F1 F4



GRAMPEADOR 24/6 METAL 27CM 100FL
 Código: 48435 Fábrica: BAZZE Unidade: PT/1
 F1 F4



GRAMPEADOR 24/6 24/8 26/8 METAL 19CM 40F
 Código: 48355 Fábrica: JOCAROFFICE Unidade: UN/1
 F1 F4



GRAMPEADOR 24/6 26/6 METAL MED 15FL V300
 Código: 39924 Fábrica: VMP Unidade: UN/1
 F1 F4



GRAMPEADOR 24/6 26/6 METAL MED 2000
 Código: 18706 Fábrica: BRW Unidade: UN/1
 F1 F4



GRAMPEADOR 24/6 26/6 METAL MED 301
 Código: 39782 Fábrica: MASTERPRINT Unidade: UN/1
 F1 F4



GRAMPEADOR 24/6 26/6 METAL PEQ 20FLS 300
 Código: 39781 Fábrica: MASTERPRINT Unidade: UN/1
 F1 F4



GRAMPEADOR 24/6 26/6 METAL 10CM 25FL
 Código: 50028 Fábrica: BAZZE Unidade: UN/1
 F1 F4



GRAMPEADOR 24/6 26/6 METAL 16CM 40FL
 Código: 48321 Fábrica: BAZZE Unidade: UN/1
 F1 F4



GRAMPEADOR 24/6 26/6 METAL 20CM 30FLS
 Código: 46381 Fábrica: FUTURO Unidade: UN/1
 F1 F4



GRAMPEADOR 24/6 26/6 METAL 20FLS 1000
 Código: 41084 Fábrica: BRW Unidade: UN/1
 F1 F4



GRAMPEADOR 24/6 26/6 METAL 30 FLS GDE
 Código: 42457 Fábrica: GATTE Unidade: UN/1
 F1 F4



GRAMPEADOR 24/6 26/6 METAL 50F 16CM 2137
 Código: 48842 Fábrica: FIRST Unidade: UN/1
 F1 F4



GRAMPEADOR 24/6/26/6 METAL 15CM 20F 2001
 Código: 44994 Fábrica: BRW Unidade: UN/1
 F1 F4



GRAMPEADOR 24/6/26/6 METAL 20CM 30F 1110
 Código: 43854 Fábrica: LYKE Unidade: UN/1
 F1 F4



GRAMPEADOR 24/6/26/6 METAL 20CM 30F 3001
 Código: 43194 Fábrica: BRW Unidade: UN/1
 F1 F4



GRAMPEADOR 24/6/26/6 METAL 20CM 30F 6012
 Código: 50682 Fábrica: WINPAPER Unidade: UN/1
 F1 F4



GRAMPEADOR 24/6-8 26/6 METAL 16CM 50FL
 Código: 46428 Fábrica: KAZ Unidade: UN/1
 F1 F4



GRAMPEADOR 24/6/8 26/6/8 METAL 50FL 3002
 Código: 43187 Fábrica: BRW Unidade: UN/1
 F1 F4



GRAMPEADOR 26/6 METAL 20CM 40FL 7317
 Código: 46427 Fábrica: KAZ Unidade: UN/1
 F1 F4



GRAMPO GRAMPEADOR COBREADO 26/6 5000X1
 Código: 24962 Fábrica: JOCAROFFICE Unidade: CX/1
 F1 F4

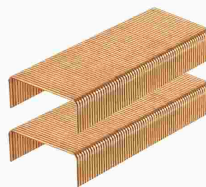

GRAMPO GRAMPEADOR COBREADO 26/6 5000X1
 Código: 48322 Fábrica: BAZZE Unidade: CX/1
 F1 F4

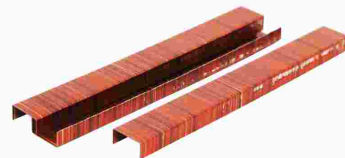

GRAMPO GRAMPEADOR COBREADO 26/6 5000X1
 Código: 46518 Fábrica: LVC Unidade: CX/1
 F1 F4

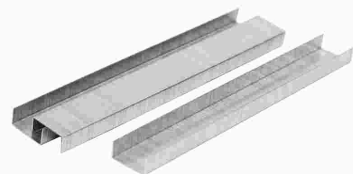

GRAMPO GRAMPEADOR GALV 26/6 5000X1
 Código: 19708 Fábrica: CIS Unidade: CX/1
 F1 F4

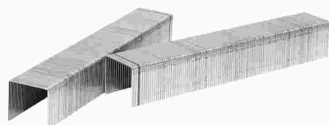

GRAMPO GRAMPEADOR GALV 9/12 1000X1
 Código: 44191 Fábrica: BACCHI Unidade: CX/1000
 F1 F4

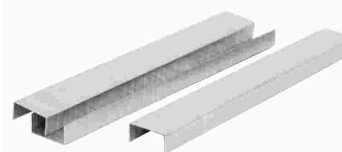

GRAMPO GRAMPEADOR GALV 160/6 1124 3500X1
 Código: 49134 Fábrica: JOCAROFFICE Unidade: CX/1
 F1 F4

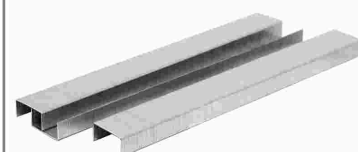

GRAMPO GRAMPEADOR GALV 26/6 5000 5000X1
 Código: 49154 Fábrica: BRW Unidade: CX/1
 F1 F4

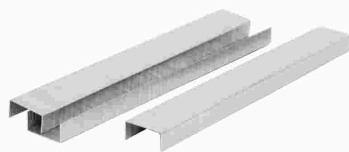

GRAMPO GRAMPEADOR GALV 26/6 93010 5000X1
 Código: 48351 Fábrica: JOCAROFFICE Unidade: CX/1
 F1 F4

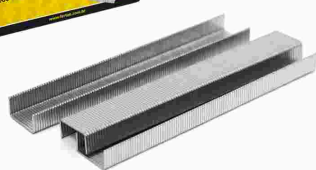

GRAMPO GRAMPEADOR GALV 6MM TAPECE 1000X1
 Código: 48061 Fábrica: FERTAK Unidade: CX/1000
 F1 F4

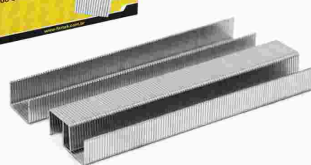

GRAMPO GRAMPEADOR GALV 8MM TAPECE 1000X1
 Código: 48062 Fábrica: FERTAK Unidade: CX/1000
 F1 F4

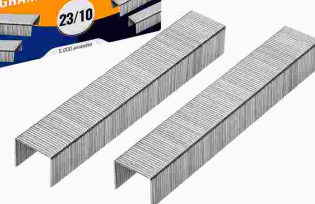

GRAMPO GRAMPEADOR GALVAN 23/10 5000X1
 Código: 42150 Fábrica: BRW Unidade: CX/1
 F1 F4



GRAMPO GRAMPEADOR GALVAN 23/13 5000X1
 Código: 41759 Fábrica: BRW Unidade: CX/1
 F1 F4

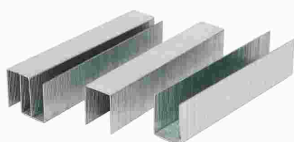

GRAMPO GRAMPEADOR GALVAN 23/17 1000X1
 Código: 44987 Fábrica: BRW Unidade: CX/1
 F1 F4

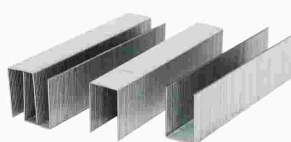

GRAMPO GRAMPEADOR GALVAN 23/20 1000X1
 Código: 44988 Fábrica: BRW Unidade: CX/1
 F1 F4

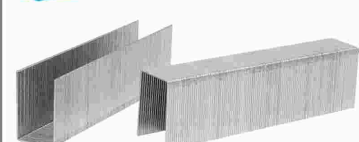

GRAMPO GRAMPEADOR GALVAN 23/20 1000X1
 Código: 44190 Fábrica: BACCHI Unidade: CX/1000
 F1 F4

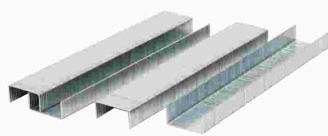

GRAMPO GRAMPEADOR GALVAN 23/6 5000X1
 Código: 44989 Fábrica: BRW Unidade: CX/1
 F1 F4



GRAMPO GRAMPEADOR GALVAN 23/8 5000X1
 Código: 43247 Fábrica: BACCHI Unidade: CX/5000
 F1 F4



GRAMPO GRAMPEADOR GALVAN 24/6 1000X1
 Código: 44192 Fábrica: BACCHI Unidade: CX/1000
 F1 F4

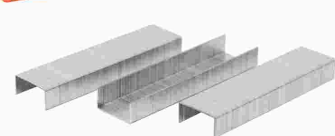

GRAMPO GRAMPEADOR GALVAN 26/6 1000X1
 Código: 47388 Fábrica: JOCAROFFICE Unidade: CX/1
 F1 F4



GRAMPO GRAMPEADOR GALVAN 26/6 1000X1
 Código: 50033 Fábrica: BAZZE Unidade: CX/1
 F1 F4

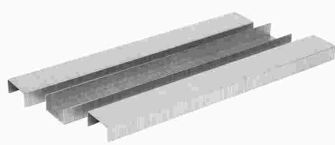

GRAMPO GRAMPEADOR GALVAN 26/6 5000X1
 Código: 18293 Fábrica: MASTER/NINES Unidade: CX/1
 F1 F4

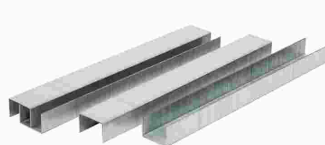

GRAMPO GRAMPEADOR GALVAN 26/8 5000X1
 Código: 44990 Fábrica: BRW Unidade: CX/1
 F1 F4



GRAMPO GRAMPEADOR GALVAN 106/6 3500X1
 Código: 43190 Fábrica: BRW Unidade: CX/1
 F1 F4

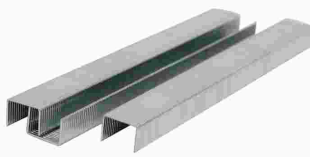

GRAMPO GRAMPEADOR GALVAN 106/8 2500X1
 Código: 46835 Fábrica: WIN PAPER Unidade: CX/1
 F1 F4



GRAMPO GRAMPEADOR GALVAN 106/8 3000X1
 Código: 43192 Fábrica: BRW Unidade: CX/1
 F1 F4

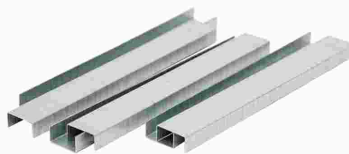

GRAMPO GRAMPEADOR GALVAN 26/6 5000X1
 Código: 45391 Fábrica: NOX Unidade: CX/1
 F1 F4

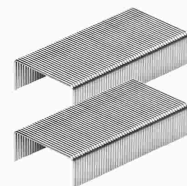

GRAMPO GRAMPEADOR GALVAN 26/6 5000X1
 Código: 49961 Fábrica: BAZZE Unidade: CX/5000
 F1 F4

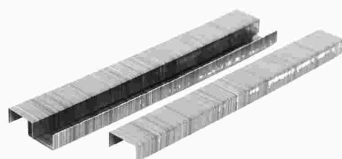

GRAMPO GRAMPEADOR GALVAN 26/6 5000X1
 Código: 46517 Fábrica: LVC Unidade: CX/1
 F1 F4

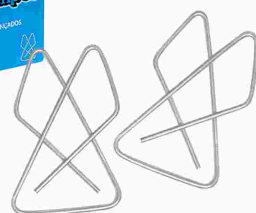

GRAMPO TRANCADO GALVAN 1 METAL 12X1
 Código: 44184 Fábrica: BACCHI Unidade: CX/12
 F1 F4

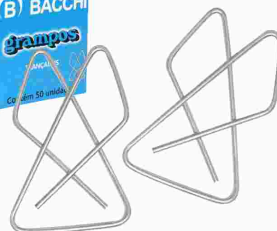

GRAMPO TRANCADO GALVAN 2 METAL 50X1
 Código: 44185 Fábrica: BACCHI Unidade: CX/50
 F1 F4



GRAMPO TRILHO GALVAN 80MM P/PASTA 50X1
 Código: 11063 Fábrica: JOCAROFFICE Unidade: CX/50
 F1 F4

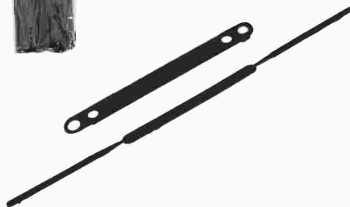

GRAMPO TRILHO PLAST 20CM P/PASTA PT 50X1
 Código: 44446 Fábrica: POLYCART Unidade: PT/50
 F1 F4



GRAMPO TRILHO PLAST 20CM P/PASTA 50X1
 Código: 42020 Fábrica: WALEU Unidade: PT/50
 F1 F4



GRAMPO TRILHO PLAST 30CM BC P/PASTA 50X1
 Código: 47243 Fábrica: FIX PAPER Unidade: PT/50
 F1 F4



GRIP P/LAPIS OU CANETA CANDY 8583 2X1
 Código: 48143 Fábrica: YIN'S PAPER Unidade: CR/2
 F1 F4



GUARDANAPO PAPEL 33CM P/DECOUP 1304 20X1
 Código: 44741 Fábrica: ROCIE Unidade: PT/20
 F1 F4



GUARDANAPO PAPEL 33X33CM P/DECOUP 20X1
 Código: 50079 Fábrica: BOMPACK Unidade: PT/20
 F1 F4



GUILHOTINA PAPEL A4/A5 10 FLS 7891
 Código: 46922 Fábrica: YIN'S PAPER Unidade: UN/1
 F1 F4



GUILHOTINA PAPEL 10FLS GPM200 BEGE
 Código: 44285 Fábrica: MENNO Unidade: UN/1
 F1 F4



GUILHOTINA REFLADORA PAPEL 10FLS
 Código: **46387** Fábrica: **KAZ** Unidade: **UN/1**
F1 F4

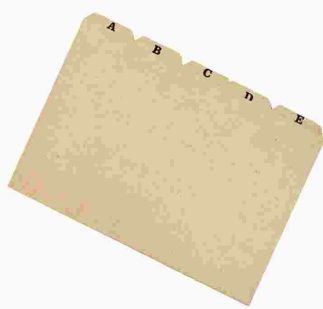

ÍNDICE PAPEL CARTOLINA 3X5 A/Z 3039
 Código: **44286** Fábrica: **MENNO** Unidade: **PT/22**
F1 F4



ÍNDICE PAPEL CARTOLINA 4X6 A/Z 3072
 Código: **44287** Fábrica: **MENNO** Unidade: **PT/22**
F1 F4

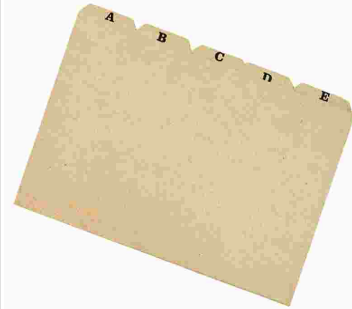

ÍNDICE PAPEL CARTOLINA 5X8 A/Z 3074
 Código: **44288** Fábrica: **MENNO** Unidade: **PT/22**
F1 F4

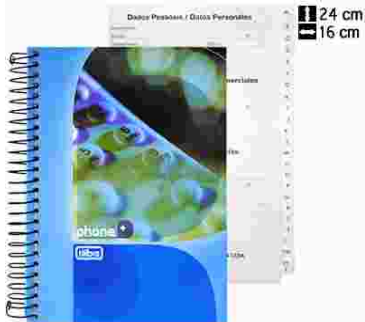

ÍNDICE TELEFONICO CD PHONE 64 FLS 1236
 Código: **14634** Fábrica: **TILIBRA** Unidade: **UN/1**
F1 F4



ÍNDICE TELEFONICO MED ACRILICO
 Código: **2541** Fábrica: **IMPORTADO** Unidade: **UN/1**
F1 F4



KIT DESENHO MALETA PINTURA 24 PCS 23728
 Código: **49148** Fábrica: **IMPBRINK** Unidade: **CJ/1**
F1 F4



KIT DESENHO MALETA PINTURA 42 PCS 23729
 Código: **49149** Fábrica: **IMPBRINK** Unidade: **CJ/1**
F1 F4



KIT DESENHO MALETA PINTURA 42 PCS 23730
 Código: **49150** Fábrica: **IMPBRINK** Unidade: **CJ/1**
F1 F4



KIT DESENHO MALETA PINTURA 68 PCS 23731
 Código: **49151** Fábrica: **IMPBRINK** Unidade: **CJ/1**
F1 F4



KIT DESENHO MALETA PINTURA 86 PCS 23732
 Código: **49152** Fábrica: **IMPBRINK** Unidade: **CJ/1**
F1 F4

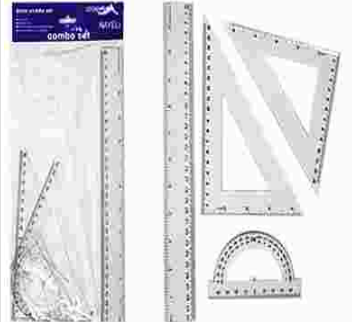

KIT ESCOLAR 1.º GRAU 4 PCS 10130001
 Código: **24887** Fábrica: **WALEU** Unidade: **PT/1**
F1 F4

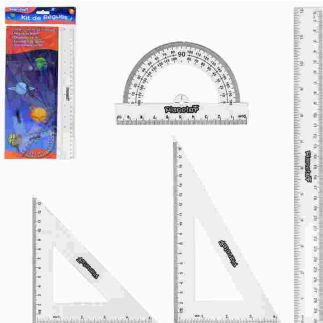

KIT ESCOLAR 1.º GRAU 4 PCS 2918
 Código: **40787** Fábrica: **PLANETA** Unidade: **PT/1**
F1 F4



KIT ESCOLAR 2.º GRAU 4 PCS 10130002
 Código: **22765** Fábrica: **WALEU** Unidade: **PT/1**
F1 F4



KIT ESCRITORIO (APON/TES/BORR/GRAM) 8861
 Código: **44751** Fábrica: **WIN PAPER** Unidade: **UN/1**
F1 F4



KIT NORMOGRAFO CRISTAL 19MM 14006
 Código: **44059** Fábrica: **MAXCRIL** Unidade: **PT/1**
F1 F4



LACO FACIL 12MMX21CM COLOR 12A 10X1

Código: 35988
 Fábrica: PULLFLOWER
 Unidade: PT/10
 F1 F4



LACO FACIL 12MMX24CM COLOR 64 10X1

Código: 45956
 Fábrica: WINMAX
 Unidade: PT/10
 F1 F4



LACO FACIL 15MMX27CM COLOR 15A 10X1

Código: 35989
 Fábrica: PULLFLOWER
 Unidade: PT/10
 F1 F4



LACO FACIL 18MMX34CM COLOR 65 10X1

Código: 45957
 Fábrica: WINMAX
 Unidade: PT/10
 F1 F4



LAMINA P/ESTILETE 09MM ESTREITO 10X1

Código: 41608
 Fábrica: BRW
 Unidade: CR/10
 F1 F4



LAMINA P/ESTILETE 09MM ESTREITO 10X10

Código: 45125
 Fábrica: MASTERPRINT
 Unidade: CX/100
 F1 F4



LAMINA P/ESTILETE 18MM LARGO 10X10

Código: 45126
 Fábrica: MASTERPRINT
 Unidade: CX/10
 F1 F4



LAMINA P/ESTILETE 18MM LARGO 1801 10X1

Código: 22804
 Fábrica: BRW/MASTER
 Unidade: CR/10
 F1 F4



LANCHEIRA BATTLE LA4658

Código: 48989
 Fábrica: PONTO VERDE
 Unidade: UN/1
 F1 F4



LANCHEIRA BRANCA DE NEVE LA4628

Código: 49031
 Fábrica: PONTO VERDE
 Unidade: UN/1
 F1 F4



LANCHEIRA FEM AMANDA&FRIENDS RELEVLA2190

Código: 29618
 Fábrica: SBC
 Unidade: UN/1
 F1 F4



LANCHEIRA FEM ANGOLITA E PINTINHOS LA253

Código: 28927
 Fábrica: SBC
 Unidade: UN/1
 F1 F4



LANCHEIRA FEM BEAUTY FREAKY LA225

Código: 28925
 Fábrica: SBC
 Unidade: UN/1
 F1 F4



LANCHEIRA FEM BELLA LA3539

Código: 34241
 Fábrica: SBC
 Unidade: UN/1
 F1 F4



LANCHEIRA FEM CALIFORNIA GIRL LA2948

Código: 32143
 Fábrica: SBC
 Unidade: UN/1
 F1 F4



LANCHEIRA FEM CALIFORNIA GIRL REL 3026

Código: 32144
 Fábrica: SBC
 Unidade: UN/1
 F1 F4



LANCHEIRA FEM CALIFORNIA GIRL REL 3150
 Código: 32329 Fábrica: SBC Unidade: UN/1
 F1 F4



LANCHEIRA FEM CRYSTAL PRINCESS REL LA2634
 Código: 31325 Fábrica: SBC Unidade: UN/1
 F1 F4



LANCHEIRA FEM DOLL LA3922
 Código: 36218 Fábrica: SBC Unidade: UN/1
 F1 F4



LANCHEIRA FEM EMOJI LA3254
 Código: 32303 Fábrica: SBC Unidade: UN/1
 F1 F4



LANCHEIRA FEM LITTLE PRINCESS LA3644
 Código: 34245 Fábrica: SBC Unidade: UN/1
 F1 F4



LANCHEIRA FEM LOVE FASHION LA3517
 Código: 34246 Fábrica: SBC Unidade: UN/1
 F1 F4



LANCHEIRA FEM MAGICAL FAIRIES LA165
 Código: 27856 Fábrica: SBC Unidade: UN/1
 F1 F4



LANCHEIRA FEM MAGICAL 2920
 Código: 32333 Fábrica: SBC Unidade: UN/1
 F1 F4



LANCHEIRA FEM MELODY LA985
 Código: 26658 Fábrica: SBC Unidade: UN/1
 F1 F4



LANCHEIRA FEM MY PRINCESS LA183
 Código: 27798 Fábrica: SBC Unidade: UN/1
 F1 F4



LANCHEIRA FEM PEQUENA PRINCESA REL 3038
 Código: 32332 Fábrica: SBC Unidade: UN/1
 F1 F4



LANCHEIRA FEM PEQUENA PRINCESA REL 3144
 Código: 32330 Fábrica: SBC Unidade: UN/1
 F1 F4



LANCHEIRA FEM PET PRINCESS LA 3088
 Código: 32148 Fábrica: SBC Unidade: UN/1
 F1 F4



LANCHEIRA FEM PET PRINCESSS 2934
 Código: 32331 Fábrica: SBC Unidade: UN/1
 F1 F4



LANCHEIRA FEM PIGGY LA2004
 Código: 29631 Fábrica: SBC Unidade: UN/1
 F1 F4



LANCHEIRA FEM PIGGY RELEVÔ LA2402
 Código: 29700 Fábrica: SBC Unidade: UN/1
 F1 F4



LANCHEIRA FEM PINK BALLERINA LA269
 Código: 27969 Fábrica: SBC Unidade: UN/1
 F1 F4



LANCHEIRA FEM PRINCESS ON ICE LA3006
 Código: 32211 Fábrica: SBC Unidade: UN/1
 F1 F4



LANCHEIRA FEM PRINCESS ON ICE LA3106
 Código: 32105 Fábrica: SBC Unidade: UN/1
 F1 F4



LANCHEIRA FEM PRINCESS ON ICE REL LA3044
 Código: 32106 Fábrica: SBC Unidade: UN/1
 F1 F4



LANCHEIRA FEM PRINCESS REL LA3032
 Código: 32104 Fábrica: SBC Unidade: UN/1
 F1 F4



LANCHEIRA FEM PRINCESS REL LA3074
 Código: 32146 Fábrica: SBC Unidade: UN/1
 F1 F4



LANCHEIRA FEM RAPUNZEL LA189
 Código: 27873 Fábrica: VOZZ Unidade: UN/1
 F1 F4



LANCHEIRA FEM REBEL PRINCESS LA2940
 Código: 32151 Fábrica: SBC Unidade: UN/1
 F1 F4



LANCHEIRA FEM SOPHIA REL LA2628
 Código: 31310 Fábrica: SBC Unidade: UN/1
 F1 F4



LANCHEIRA FEM STAR SHOW LA3884
 Código: 35969 Fábrica: SBC Unidade: UN/1
 F1 F4



LANCHEIRA FEM SUPER CATHIE LA3551
 Código: 38053 Fábrica: SBC Unidade: UN/1
 F1 F4



LANCHEIRA FEM UNILOVERS LA3722
 Código: 34248 Fábrica: SBC Unidade: UN/1
 F1 F4



LANCHEIRA FEM VALENTINA LA3168
 Código: 31783 Fábrica: SBC Unidade: UN/1
 F1 F4



LANCHEIRA FEM WORDER GIRL LA3904
 Código: 35970 Fábrica: SBC Unidade: UN/1
 F1 F4



LANCHEIRA FEM WORLD OF PRINCESS LA277
 Código: 28939 Fábrica: SBC Unidade: UN/1
 F1 F4



LANCHEIRA INF LINHA BABY GATINHA LA715
 Código: 49183 Fábrica: PONTO VERDE Unidade: UN/1
 F1 F4



LANCHEIRA INF MASC GUARDIAN NIGHT LA4178
 Código: 44405 Fábrica: PONTO VERDE Unidade: UN/1
 F1 F4



LANCHEIRA INF MASC SPEED WEB LA4142
 Código: 44404 Fábrica: PONTO VERDE Unidade: UN/1
 F1 F4



LANCHEIRA JUVENIL FEM VKG LA4288
 Código: 48960 Fábrica: PONTO VERDE Unidade: UN/1
 F1 F4



LANCHEIRA JUVENIL FEM VKG LA4294
 Código: 48961 Fábrica: PONTO VERDE Unidade: UN/1
 F1 F4



LANCHEIRA JUVENIL FEM VKG LA4298
 Código: 49181 Fábrica: PONTO VERDE Unidade: UN/1
 F1 F4



LANCHEIRA KARS KIDS LA4668
 Código: 48990 Fábrica: PONTO VERDE Unidade: UN/1
 F1 F4



LANCHEIRA MASC AIR JUMP LA3746
 Código: 38052 Fábrica: SBC Unidade: UN/1
 F1 F4



LANCHEIRA MASC BLOCK GAME LA3628
 Código: 34242 Fábrica: SBC Unidade: UN/1
 F1 F4



LANCHEIRA MASC BROKEBONES LA3020
 Código: 32142 Fábrica: SBC Unidade: UN/1
 F1 F4



LANCHEIRA MASC BROKEBONES REL LA3050
 Código: 32316 Fábrica: SBC Unidade: UN/1
 F1 F4



LANCHEIRA MASC BROKEBONES REL LA3124
 Código: 32101 Fábrica: SBC Unidade: UN/1
 F1 F4



LANCHEIRA MASC BROKEBONES REL LA3162
 Código: 32102 Fábrica: SBC Unidade: UN/1
 F1 F4



LANCHEIRA MASC BROKEBONES RELEVO LA2174
 Código: 29511 Fábrica: SBC Unidade: UN/1
 F1 F4



LANCHEIRA MASC DINOSSAURO LA4034
 Código: 36102 Fábrica: SBC Unidade: UN/1
 F1 F4



LANCHEIRA MASC GALERA RADICAL LA3576
 Código: 34373 Fábrica: SBC Unidade: UN/1
 F1 F4



LANCHEIRA MASC HEROES VOZZ LA3056
 Código: 31833 Fábrica: SBC Unidade: UN/1
 F1 F4



LANCHEIRA MASC HEROES VOZZ LA2956
 Código: 38047 Fábrica: SBC Unidade: UN/1
 F1 F4



LANCHEIRA MASC HEROES VOZZ REL LA2658
 Código: 31303 Fábrica: SBC Unidade: UN/1
 F1 F4



LANCHEIRA MASC HEROES VOZZ REL LA3112
 Código: 32103 Fábrica: SBC Unidade: UN/1
 F1 F4



LANCHEIRA MASC HOOZ LA3637
 Código: 34244 Fábrica: SBC Unidade: UN/1
 F1 F4



LANCHEIRA MASC PIGGY BOY LA2052
 Código: 29521 Fábrica: SBC Unidade: UN/1
 F1 F4



LANCHEIRA MASC PIGGY BOY RELEVO LA2434
 Código: 29609 Fábrica: SBC Unidade: UN/1
 F1 F4



LANCHEIRA MASC REINO LEAO LA4015
 Código: 35968 Fábrica: SBC Unidade: UN/1
 F1 F4



LANCHEIRA MASC ROBOT POWER LA3658
 Código: 34247 Fábrica: SBC Unidade: UN/1
 F1 F4



LANCHEIRA MASC SPEED BOY LA 2964
 Código: 32152 Fábrica: SBC Unidade: UN/1
 F1 F4



LANCHEIRA MASC SPEED BOY LA2154
 Código: 29610 Fábrica: SBC Unidade: UN/1
 F1 F4



LANCHEIRA MASC SPEED BOY LA3613
 Código: 38048 Fábrica: SBC Unidade: UN/1
 F1 F4



LANCHEIRA MASC SPEED BOY REL LA3156
 Código: 32315 Fábrica: SBC Unidade: UN/1
 F1 F4



LANCHEIRA PRINCESA LA4638
 Código: 48991 Fábrica: PONTO VERDE Unidade: UN/1
 F1 F4



LANCHEIRA SEREIA LA4618
 Código: 49032 Fábrica: PONTO VERDE Unidade: UN/1
 F1 F4



LANCHEIRA TERM FEM PROMOCAO
 Código: 21180 Fábrica: YINS/YANGZI Unidade: UN/1
 F4



LANCHEIRA TERM JUVENIL FEM VIKING LA4256
 Código: 49182 Fábrica: PONTO VERDE Unidade: UN/1
 F1 F4



LANCHEIRA TERM JUVENIL FEM VKG LA4266

Código: 49221
Fábrica: PONTO VERDE
Unidade: UN/1
F1 F4



LANCHEIRA UNISSEX FRIENDS AVENTURE LA153

Código: 29018
Fábrica: SBC
Unidade: UN/1
F1 F4



LANCHEIRA UNISSEX TURMA DO RISO LA111

Código: 28923
Fábrica: SBC
Unidade: UN/1
F1 F4



LANTEJOULA 2 GRS AZUL12X1

Código: 9808
Fábrica: CITY BRILHO
Unidade: DZ/12
F1 F4



LANTEJOULA 2 GRS BRANCO 12X1

Código: 9806
Fábrica: CITY BRILHO
Unidade: DZ/12
F1 F4



LANTEJOULA 2 GRS DOURADO 12X1

Código: 9807
Fábrica: CITY BRILHO
Unidade: DZ/12
F1 F4



LANTEJOULA 2 GRS PRATA 12X1

Código: 15072
Fábrica: CITY BRILHO
Unidade: DZ/12
F1 F4



LANTEJOULA 2 GRS PRETA 12X1

Código: 15073
Fábrica: CITY BRILHO
Unidade: DZ/12
F1 F4



LANTEJOULA 2 GRS ROSA 12X1

Código: 15074
Fábrica: CITY BRILHO
Unidade: DZ/12
F1 F4



LANTEJOULA 2 GRS VERDE 12X1

Código: 9809
Fábrica: CITY BRILHO
Unidade: DZ/12
F1 F4



LANTEJOULA 2 GRS VERMELHA 12X1

Código: 9810
Fábrica: CITY BRILHO
Unidade: DZ/12
F1 F4



LAPIS COR RED 24 CORES 3X1

Código: 7365
Fábrica: INJEX PEN
Unidade: PT/3
F1 F4



LAPIS COR SUPERACAO 12 CORES RED 6X1

Código: 44030
Fábrica: INJEX PEN
Unidade: PT/6
F1 F4



LAPIS COR 10 CORES METALICO SOFT COLOR

Código: 49502
Fábrica: TRIS
Unidade: UN/1
F1 F4



LAPIS COR 12 CORES AQUAREL C/PINCEL9652

Código: 48429
Fábrica: ACRILEX
Unidade: UN/1
F1 F4



LAPIS COR 12 CORES AQUARELAV SEXT C/APON

Código: 46931
Fábrica: YIN'S PAPER
Unidade: UN/1
F1 F4



LAPIS COR 12 CORES C/APONT/BORR/2LAP 4X1
 Código: **27954** Fábrica: **LEO&LEO** Unidade: **PT/4 F1 F4**



LAPIS COR 12 CORES HEXAG MEGA SOFT 6X1
 Código: **48812** Fábrica: **TRIS** Unidade: **PT/6 F1 F4**



LAPIS COR 12 CORES JUMBO C/APONTADOR 3X1
 Código: **43754** Fábrica: **TRIS** Unidade: **UN/1 F1 F4**



LAPIS COR 12 CORES JUMBO C/APONTADOR 6X1
 Código: **50329** Fábrica: **FIRST** Unidade: **PT/6 F1 F4**



LAPIS COR 12 CORES MAD RED ECO 4692 6X1
 Código: **50618** Fábrica: **LEO&LEO** Unidade: **PT/6 F1 F4**



LAPIS COR 12 CORES MAD SEXT ECO 4220 6X1
 Código: **50617** Fábrica: **LEO&LEO** Unidade: **PT/6 F1 F4**



LAPIS COR 12 CORES MAD SEXTAV 4130 6X1
 Código: **48356** Fábrica: **LEO&LEO** Unidade: **PT/6 F1 F4**



LAPIS COR 12 CORES MADEIRA 120636 6X1
 Código: **42034** Fábrica: **SERELEPE** Unidade: **PT/6 F1 F4**



LAPIS COR 12 CORES RED PIRILAMPO REC 6X1
 Código: **47461** Fábrica: **ECOLE** Unidade: **PT/6 F1 F4**



LAPIS COR 12 CORES SEXT MAD FSC UN
 Código: **49271** Fábrica: **COLORARE** Unidade: **UN/1 F1 F4**



LAPIS COR 12 CORES SEXTAV MADEIRA 0012
 Código: **49153** Fábrica: **BRW** Unidade: **UN/1 F1 F4**



LAPIS COR 12 CORES SEXTAV WAVE REC 12X1
 Código: **48330** Fábrica: **BAZZE** Unidade: **PT/12 F1 F4**



LAPIS COR 12 CORES SEXTAVAD ECO 1204 6X1
 Código: **25503** Fábrica: **BRW** Unidade: **PT/6 F1 F4**



LAPIS COR 12 CORES SUPER MINA 3MM 9692
 Código: **48432** Fábrica: **ACRILEX** Unidade: **UN/1 F1 F4**



LAPIS COR 12 CORES TRIAN BIG C/APON 4194
 Código: **42591** Fábrica: **LEO&LEO** Unidade: **UN/1 F1 F4**



LAPIS COR 12 CORES TRIANG AQUARELAV 6X1
 Código: **46847** Fábrica: **ONDA** Unidade: **PT/6 F1 F4**



LÁPIS COR 12 CORES TRIANG BIG 1206 6X1
 Código: 44293 Fábrica: BRW Unidade: PT/6
 F1 F4



LÁPIS COR 12 CORES TRIANG MEGA SOFT 6X1
 Código: 48329 Fábrica: TRIS Unidade: PT/6
 F1 F4



LÁPIS COR 12 CORES UN
 Código: 38508 Fábrica: SERELEPE Unidade: UN/1
 F1 F4



LÁPIS COR 12 CORES UN
 Código: 42826 Fábrica: INJEX Unidade: UN/1
 F1 F4



LÁPIS COR 1/2 12 CORES WK 09235 UN
 Código: 38509 Fábrica: KLUB Unidade: UN/1
 F1 F4



LÁPIS COR 1/2 12 CORES WK 09235 12X1
 Código: 4257 Fábrica: KLUB Unidade: CX/12
 F1 F4



LÁPIS COR 24 CORES AQUAREL C/PINCEL 9654
 Código: 48431 Fábrica: ACRILEX Unidade: UN/1
 F1 F4



LÁPIS COR 24 CORES RED WOW 4678
 Código: 46348 Fábrica: LEO&LEO Unidade: UN/1
 F1 F4



LÁPIS COR 24 CORES SEXT MAD FSC UN
 Código: 49272 Fábrica: COLORARE Unidade: PT/1
 F1 F4



LÁPIS COR 24 CORES SUPER MINA 3MM 9694
 Código: 41605 Fábrica: ACRILEX Unidade: UN/1
 F1 F4



LÁPIS COR 24 CORES UN
 Código: 19811 Fábrica: INJEX Unidade: PT/6
 F1 F4



LÁPIS COR 36 CORES SEXTAV FLEX 4482
 Código: 46343 Fábrica: LEO&LEO Unidade: UN/1
 F1 F4



LÁPIS COR 36 CORES SEXTAVADO 3X1
 Código: 41844 Fábrica: ONDA Unidade: PT/3
 F1 F4



LÁPIS COR 36 CORES SUPER MINA 3MM 9626
 Código: 48430 Fábrica: ACRILEX Unidade: UN/1
 F1 F4



LÁPIS COR 48 CORES SEXTAV 72105
 Código: 46344 Fábrica: LEO&LEO Unidade: UN/1
 F1 F4



LÁPIS (GIZ) CERA ESTACA AMARELO 100G 12X1
 Código: 28917 Fábrica: FABERCASTELL Unidade: DZ/12
 F1 F4



LAPIS (GIZ) CERA ESTACA VERDE CL 10012X1
 Código: 28918 Fábrica: FABER CASTEL Unidade: DZ/12 F1 F4



LAPIS (GIZ) CERA ESTACA VERDE 100G 12X1
 Código: 3828 Fábrica: FABER/ACRILE Unidade: DZ/12 F1 F4



LAPIS HB BLACK PEPS JUMBO C/BORR 12X1
 Código: 44294 Fábrica: MAPED Unidade: CX/12 F1 F4



LAPIS HB INFINITO COLOR AZUL 13084 12X1
 Código: 48554 Fábrica: NEWPEN Unidade: CX/12 F1 F4



LAPIS HB INFINITO COLOR ROSA 13085 12X1
 Código: 48555 Fábrica: NEWPEN Unidade: CX/12 F1 F4



LAPIS MARCENEIRO/CARPINTEIRO 19460 6X1
 Código: 46587 Fábrica: ALIANCA Unidade: PT/6 F1 F4



LAPIS PRETO C/BORRACHA HB N2 JUMBO 36X1
 Código: 41925 Fábrica: TRIS Unidade: CX/1 F1 F4



LAPIS PRETO HB C/BOR RED DEC 907721 72X1
 Código: 49949 Fábrica: BAZZE WAVE Unidade: PT/72 F1 F4



LAPIS PRETO HB C/BORR PANDA 72191 72X1
 Código: 44245 Fábrica: LEO&LEO Unidade: CX/72 F1 F4



LAPIS PRETO HB C/BORR RED FUNDO MAR 72X1
 Código: 46330 Fábrica: LEO&LEO Unidade: PT/72 F1 F4



LAPIS PRETO HB N.2 OFFICE PREMUIIM 48X1
 Código: 46279 Fábrica: MOLIN Unidade: CX/48 F1 F4



LAPIS PRETO HB N.2 OFFICE STRIPES 48X1
 Código: 46280 Fábrica: MOLIN Unidade: CX/48 F1 F4



LAPIS PRETO HB N.2 PINK AND BLUE 48X1
 Código: 46281 Fábrica: MOLIN Unidade: CX/48 F1 F4



LAPIS PRETO HB N.2 SEXT C/DIPPING 144X1
 Código: 48425 Fábrica: ACRILEX Unidade: CX/144 F1 F4



LAPIS PRETO HB RED C/BORR TABUADA 72X1
 Código: 41701 Fábrica: LEO&LEO Unidade: CX/72 F1 F4



LAPIS PRETO HB RED DEC 901767 72X1
 Código: 49947 Fábrica: BAZZE WAVE Unidade: PT/72 F1 F4



LAPIS PRETO HB RED EMOTION 901743 72X1
 Código: 49948 Fábrica: BAZZE Unidade: PT/72 F1 F4



LAPIS PRETO HB RED TABUADA 611914 72X1
 Código: 49950 Fábrica: BAZZE Unidade: PT/72 F1 F4



LAPIS PRETO HB SEXTAV VERDE 4389 72X1
 Código: 46345 Fábrica: LEO%LEO Unidade: PT/72 F1 F4



LAPIS PRETO HB SEXTAVADO 7834 12X1
 Código: 47936 Fábrica: YIN'S PAPER Unidade: CX/12 F1 F4



LAPIS PRETO HB SEXTAVADO 902894 72X1
 Código: 49493 Fábrica: BAZZE Unidade: PT/72 F1 F4



LAPIS PRETO HB TRIAG BIG 4197 36X1
 Código: 46332 Fábrica: LEO&LEO Unidade: PT/36 F1 F4



LAPIS PRETO N.2 SEXTAVADO RESINA 144X1
 Código: 47219 Fábrica: MASTERPRINT Unidade: CX/144 F1 F4



LAPIS PRETO 2B TECNICO MADEIRA 5546 12X1
 Código: 44246 Fábrica: LEO&LEO Unidade: DZ/12 F1 F4



LAPIS PRETO 8B TECNICO MADEIR 72155 12X1
 Código: 44249 Fábrica: LEO&LEO Unidade: DZ/12 F1 F4



LAPIS PRETO 8202 12X12
 Código: 20518 Fábrica: YINS Unidade: CX/144 F1 F4



LAPIS RESINA HB RED GRAF 144X1 BM2024
 Código: 48843 Fábrica: FIRST Unidade: CX/144 F1 F4



LAPISEIRA 0.5MM HIT 4CORES 102208 24X1
 Código: 43809 Fábrica: FUTURO Unidade: PT/24 F1 F4



LAPISEIRA 0.5MM POP C/BORRACH 98078 24X1
 Código: 50646 Fábrica: LEO&LEO Unidade: PT/24 F1 F4



LAPISEIRA 0.5MM TECNICA C/BORRACH 12X1
 Código: 44996 Fábrica: BRW Unidade: CX/12 F1 F4



LAPISEIRA 0.5MM TECNICA TRIAN 98027 12X1
 Código: 29751 Fábrica: JOCAR OFFICE Unidade: DZ/12 F1 F4



LAPISEIRA 0.7MM C/BORRACHA 1101 12X1
 Código: 51060 Fábrica: MASTERPRINT Unidade: CX/12 F1 F4



LAPISEIRA 0.7MM POP C/BORRACH 98079 24X1
 Código: 46369 Fábrica: LEO&LEO Unidade: PT/24 F1 F4



LAPISEIRA 0.7MM SHAKE 4137 24X1
 Código: 41212 Fábrica: LEO&LEO Unidade: CX/24 F1 F4



LAPISEIRA 2.0MM COLOR C/APONTADOR 24X1
 Código: 44646 Fábrica: LEO&LEO Unidade: CX/24 F1 F4



LAPISEIRA 2.0MM 4 COR PASTEL 2024 24X1
 Código: 42581 Fábrica: BRW Unidade: CX/24 F1 F4



LEMBRANCINHAS ANIVERSARIO 12X50X1
 Código: 11265 Fábrica: KID-ART Unidade: PT/600 F1 F4



LIMPA QUADRO 1 L
 Código: 48094 Fábrica: STOP CLEAN Unidade: UN/1 F1 F4



LIMPADOR INST 60ML P/TELETA MONITOR
 Código: 42806 Fábrica: CARBRINK Unidade: UN/1 F1 F4



LIQUIDO DE LIMPEZA P/QUADRO BRANCO 110ML
 Código: 45629 Fábrica: CRTIARTE Unidade: UN/1 F1 F4



LIVRAO C/QUEBRA CABECA PRINCESAS
 Código: 30913 Fábrica: TODOLIVRO Unidade: PT/10 F1 F4



LIVRO C/FANTOCHE ANIMAIS DA FAZENDA
 Código: 48504 Fábrica: TODOLIVRO Unidade: UN/1 F1 F4



LIVRO C/FANTOCHE ANIMAIS DA SELVA
 Código: 48511 Fábrica: TODOLIVRO Unidade: UN/1 F1 F4



LIVRO C/FANTOCHE ANIMAIS DE ESTIMACAO
 Código: 48512 Fábrica: TODOLIVRO Unidade: UN/1 F1 F4



LIVRO C/FANTOCHE ARCA DE NOE
 Código: 48513 Fábrica: TODOLIVRO Unidade: UN/1 F1 F4



LIVRO C/FANTOCHE CHAPEUZINHO VERMELHO
 Código: 48514 Fábrica: TODOLIVRO Unidade: UN/1 F1 F4



LIVRO C/FANTOCHE CINDERELA
 Código: 48515 Fábrica: TODOLIVRO Unidade: UN/1 F1 F4



LIVRO C/FANTOCHE DINOSSAUROS
 Código: 48517 Fábrica: TODOLIVRO Unidade: UN/1 F1 F4



LIVRO C/FANTOCHE OS TRES PORQUINHOS

Código: 48516 Fábrica: TODOLIVRO Unidade: UN/1 F1 F4

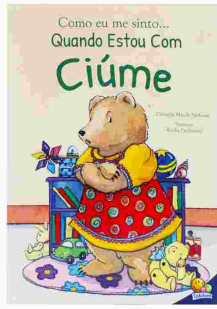

LIVRO COMO EU ME SINTO QDO ESTOU C/CIUME

Código: 48456 Fábrica: TODOLIVRO Unidade: UN/1 F1 F4



LIVRO COMO EU ME SINTO QDO ESTOU TRISTE

Código: 48457 Fábrica: TODOLIVRO Unidade: UN/1 F1 F4



LIVRO COMO EU ME SINTO QDO ESTOU ZANGADO

Código: 48458 Fábrica: TODOLIVRO Unidade: UN/1 F1 F4



LIVRO COMO EU ME SINTO QDO ME IMPORTO C/

Código: 48459 Fábrica: TODOLIVRO Unidade: UN/1 F1 F4



LIVRO COMO EU ME SINTO QDO ME SINTO BEM

Código: 48460 Fábrica: TODOLIVRO Unidade: UN/1 F1 F4



LIVRO COMO EU ME SINTO QDO SINTO SUA FAL

Código: 48461 Fábrica: TODOLIVRO Unidade: UN/1 F1 F4



LIVRO COMO EU ME SINTO QDO TENHO MEDO

Código: 48462 Fábrica: TODOLIVRO Unidade: UN/1 F1 F4



LIVRO CUTE & COMFY CANETINHA P DUPLA 914

Código: 49873 Fábrica: IBC Unidade: UN/1 F1 F4

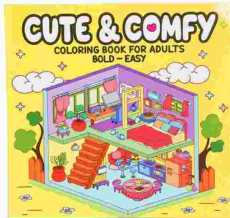

LIVRO CUTE & COMFY COLORING BOOK AD 1600

Código: 49708 Fábrica: IBC Unidade: UN/1 F1 F4



LIVRO CUTE & COMFY DES SIMPLES LAPIS COR

Código: 49718 Fábrica: IBC Unidade: UN/1 F1 F4



LIVRO CUTE & COMFY FRIENDS COLORING 2096

Código: 49711 Fábrica: IBC Unidade: UN/1 F1 F4



LIVRO CUTE & COMFY MENINAS C/LAPIS COR

Código: 49715 Fábrica: IBC Unidade: UN/1 F1 F4

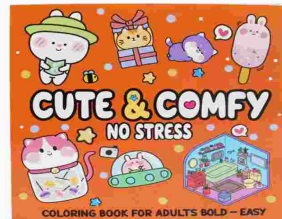

LIVRO CUTE & COMFY NO STRESS COLORING 72

Código: 49710 Fábrica: IBC Unidade: UN/1 F1 F4



LIVRO CUTE & COMFY RELAXAR C/LAPIS COR

Código: 49717 Fábrica: IBC Unidade: UN/1 F1 F4



LIVRO CUTE & COMFY SEM ESTRESS LAPIS COR

Código: 49716 Fábrica: IBC Unidade: UN/1 F1 F4



LIVRO DE BANHO A FAZENDA SOM DOS ANIMAIS
Código: 46637 Fábrica: CIRANDACULT Unidade: UN/1 F1 F4



LIVRO DE BANHO ANIMAIS CRIACOES DEUS
Código: 46636 Fábrica: CIRANDACULT Unidade: UN/1 F1 F4



LIVRO DE BANHO ANIMAIS DA SELVA
Código: 46635 Fábrica: CIRANDACULT Unidade: UN/1 F1 F4



LIVRO DE BANHO FISHER PRICE ELEFANTE
Código: 46639 Fábrica: CIRANDACULT Unidade: UN/1 F1 F4



LIVRO DE BANHO FISHER PRICE GIRAFA
Código: 46638 Fábrica: CIRANDACULT Unidade: UN/1 F1 F4



LIVRO DE BANHO NUMEROS
Código: 46641 Fábrica: CIRANDACULT Unidade: UN/1 F1 F4

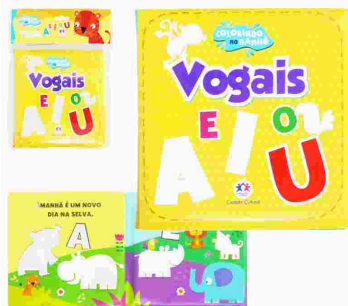

LIVRO DE BANHO VOGAIS
Código: 46640 Fábrica: CIRANDACULT Unidade: UN/1 F1 F4



LIVRO ECOG CLASSICOS INESQUECIVEIS 10X1
Código: 48463 Fábrica: TODOLIVRO Unidade: PT/10 F1 F4



LIVRO ECOG COLORINDO HIST CLASSICAS 10X1
Código: 48464 Fábrica: TODOLIVRO Unidade: PT/10 F1 F4



LIVRO ECOG COLORINDO HIST DA BIBLIA 10X1
Código: 48465 Fábrica: TODOLIVRO Unidade: UN/1 F1 F4



LIVRO ECOG FESTA DAS CORES 10X1
Código: 48466 Fábrica: TODOLIVRO Unidade: PT/10 F1 F4



LIVRO ECOG HIST BIBLICAS FAVORITAS 8X1
Código: 48467 Fábrica: TODOLIVRO Unidade: PT/8 F1 F4



LIVRO ECOM AVENTURA SERES DO MAR 10X1
Código: 48468 Fábrica: TODOLIVRO Unidade: PT/10 F1 F4



LIVRO ECOM BRINCANDO C/AS CORES 10X1
Código: 48469 Fábrica: TODOLIVRO Unidade: PT/10 F1 F4



LIVRO ECOM BRINCANDO DE COLORIR 10X1
Código: 48470 Fábrica: TODOLIVRO Unidade: PT/10 F1 F4



LIVRO ECOM CLASSICOS ADORAVEIS III 10X1
Código: 48471 Fábrica: TODOLIVRO Unidade: PT/10 F1 F4



LIVRO ECOM CLASSICOS DA BIBLIA 10X1
 Código: 48472 Fábrica: TODOLIVRO Unidade: PT/10
 F1 F4



LIVRO ECOM COLORIR BRINCAR ANIMAIS 10X1
 Código: 48473 Fábrica: TODOLIVRO Unidade: PT/10
 F1 F4



LIVRO ECOM DINOSSAUROS OS GIGANTES 10X1
 Código: 48474 Fábrica: TODOLIVRO Unidade: PT/10
 F1 F4



LIVRO ECOM FESTA DAS CORES 10X1
 Código: 48475 Fábrica: TODOLIVRO Unidade: PT/10
 F1 F4



LIVRO ECOM FOLCLORE CONTOS E CANTOS 10X1
 Código: 48478 Fábrica: TODOLIVRO Unidade: PT/10
 F1 F4



LIVRO ECOM HISTORIAS ENCANTADAS 10X1
 Código: 48479 Fábrica: TODOLIVRO Unidade: PT/10
 F1 F4



LIVRO ECOM MUNDO ENCANTADO PRINCESAS 10X1
 Código: 48476 Fábrica: TODOLIVRO Unidade: PT/10
 F1 F4



LIVRO ECOM UM MUNDO DE AVENTURAS 10X1
 Código: 48477 Fábrica: TODOLIVRO Unidade: PT/10
 F1 F4



LIVRO ESCOLINHA C/BLOCO A4 CRIATIVO
 Código: 48480 Fábrica: TODOLIVRO Unidade: UN/1
 F1 F4



LIVRO ESCOLINHA TABUADA COMPLETA
 Código: 48481 Fábrica: TODOLIVRO Unidade: UN/1
 F1 F4



LIVRO GIBI CLASSIC A BELA ADORMECIDA
 Código: 48489 Fábrica: TODOLIVRO Unidade: UN/1
 F1 F4



LIVRO GIBI CLASSIC A BELA E A FERA
 Código: 48485 Fábrica: TODOLIVRO Unidade: UN/1
 F1 F4

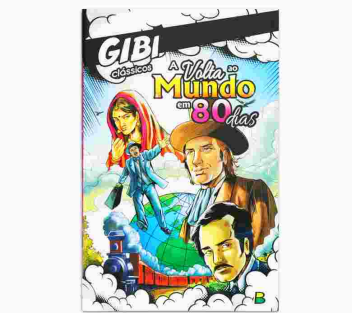

LIVRO GIBI CLASSIC A VOLTA AO MUNDO 80 D
 Código: 48496 Fábrica: TODOLIVRO Unidade: UN/1
 F1 F4



LIVRO GIBI CLASSIC ALICE PARAISO MARAVIL
 Código: 48488 Fábrica: TODOLIVRO Unidade: UN/1
 F1 F4

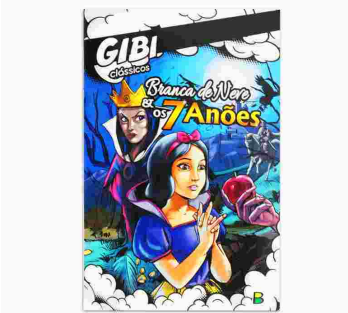

LIVRO GIBI CLASSIC BRANCA DE NEVE 7 ANOS
 Código: 48490 Fábrica: TODOLIVRO Unidade: UN/1
 F1 F4



LIVRO GIBI CLASSIC DA SELVA
 Código: 48492 Fábrica: TODOLIVRO Unidade: UN/1
 F1 F4



LIVRO GIBI CLASSIC O GATO DE BOTAS
 Código: 48491 Fábrica: TODOLIVRO Unidade: UN/1
 F1 F4



LIVRO GIBI CLASSIC OS TRES MOSQUETEIROS
 Código: 48494 Fábrica: TODOLIVRO Unidade: UN/1
 F1 F4

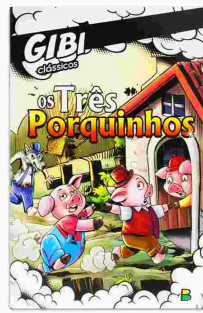

LIVRO GIBI CLASSIC OS TRES PORQUINHOS
 Código: 48495 Fábrica: TODOLIVRO Unidade: UN/1
 F1 F4



LIVRO GIBI CLASSIC PETER PAN
 Código: 48493 Fábrica: TODOLIVRO Unidade: UN/1
 F1 F4



LIVRO HIST/ATIV/COLOR PEPPA PIG 8X1
 Código: 46634 Fábrica: CIRANDACULT Unidade: PT/8
 F1 F4



LIVRO HIST/ATIV/COLORIR HIST BIBLICA 8X1
 Código: 38108 Fábrica: CIRANDACULT Unidade: PT/8
 F1 F4



LIVRO HIST/ATIV/COLORIR TURMA MONICA 8X1
 Código: 46633 Fábrica: CIRANDACULT Unidade: PT/8
 F1 F4



LIVRO HIST/ATIV/COLORIR TURMA MONICA 8X1
 Código: 46628 Fábrica: CIRANDACULT Unidade: PT/8
 F1 F4



LIVRO PAW PATROL NEON COLORIND C/CANETA
 Código: 49714 Fábrica: IBC Unidade: UN/1
 F1 F4



LIVRO PLAY QUEBRA CAB 18PCS FAZENDA
 Código: 48498 Fábrica: TODOLIVRO Unidade: UN/1
 F1 F4



LIVRO PLAY QUEBRA CAB 18PCS MAMAES FILHO
 Código: 48500 Fábrica: TODOLIVRO Unidade: UN/1
 F1 F4



LIVRO PLAY QUEBRA CAB 18PCS OPOSTOS
 Código: 48501 Fábrica: TODOLIVRO Unidade: UN/1
 F1 F4



LIVRO PLAY QUEBRA CAB 35PCS ALFABETO
 Código: 48497 Fábrica: TODOLIVRO Unidade: UN/1
 F1 F4



LIVRO PLAY QUEBRA CAB 35PCS CORPO HUMANO
 Código: 48499 Fábrica: TODOLIVRO Unidade: UN/1
 F1 F4



LIVRO PLAY QUEBRA CAB 36PCS EMOCoes
 Código: 48502 Fábrica: TODOLIVRO Unidade: UN/1
 F1 F4



LIVRO PLAY QUEBRA CAB 60PCS SILABAS
 Código: 48503 Fábrica: TODOLIVRO Unidade: UN/1
 F1 F4

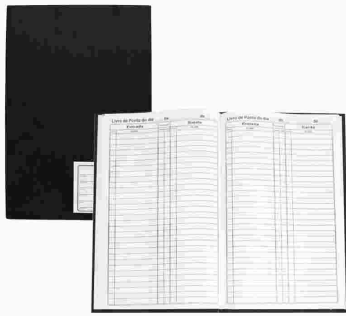

LIVRO PONTO 50 FLS 2 ASSINATURAS GDE UN
 Código: 48872 Fábrica: GRIFFE Unidade: UN/1
 F1 F4

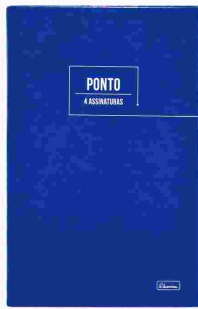

LIVRO PONTO 50 FLS 4 ASSINATURAS NUM UN
 Código: 48344 Fábrica: PAGINABRASIL Unidade: UN/1
 F1 F4



LIVRO POP-UPS BARBIE UMA AVENTURA MAGICA
 Código: 38092 Fábrica: CIRANDACULT Unidade: UN/1
 F1 F4



LIVRO POP-UPS TURMA DA MONICA
 Código: 38093 Fábrica: CIRANDACULT Unidade: UN/1
 F1 F4

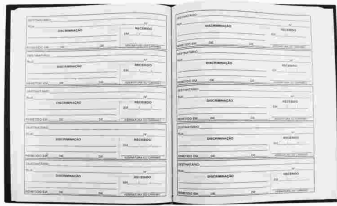

LIVRO PROTOCOLO CORRESP CD 100FL UN
 Código: 42786 Fábrica: GRIFFE Unidade: UN/1
 F1 F4

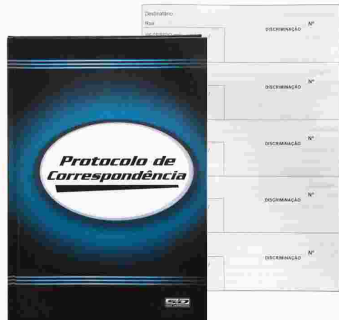

LIVRO PROTOCOLO CORRESP CD 104 FL 5X1
 Código: 36820 Fábrica: SAO DOMINGOS Unidade: PT/5
 F1 F4



LIVRO PROTOCOLO CORRESP 1/4 CD 100F 5X1
 Código: 42384 Fábrica: PAGINA BRASI Unidade: PT/5
 F1 F4



LIVRO SONIC HORA ALEGRIA C/LAPIS COR 084
 Código: 49713 Fábrica: IBC Unidade: UN/1
 F1 F4



MALETA POLIONDA 4 CM AZUL PASTEL
 Código: 9793 Fábrica: ALAPLAST Unidade: UN/1
 F1 F4



MALETA POLIONDA 4 CM PRETO
 Código: 44330 Fábrica: ALAPLAST Unidade: UN/1
 F1 F4



MALETA POLIONDA 4 CM ROSA PASTEL
 Código: 9867 Fábrica: ALAPLAST Unidade: UN/1
 F1 F4



MALETA POLIONDA 4 CM VERDE PASTEL
 Código: 9791 Fábrica: ALAPLAST Unidade: UN/1
 F1 F4



MALETA PP OFICIO C/ALCA MARIO 2281
 Código: 41274 Fábrica: DAC Unidade: UN/1
 F1 F4



MALETA PP OFICIO C/ALCA BATMAN 2826
 Código: 41271 Fábrica: DAC Unidade: UN/1
 F1 F4



MALETA PP OFICIO C/ALCA CARROS 2545
 Código: 41272 Fábrica: DAC Unidade: UN/1
 F1 F4



MALETA PP OFICIO C/ALCA MIRACULOUS CAT
 Código: 41277 Fábrica: DAC Unidade: UN/1
 F1 F4



MALETA PP OFICIO C/ALCA MIRACULOUS 2607

Código: 41276
 Fábrica: DAC
 Unidade: UN/1
 F1 F4



MALETA PP OFICIO C/ALCA PAW PATROL FEM

Código: 41278
 Fábrica: DAC
 Unidade: UN/1
 F1 F4



MAQUINA ETIQUETADORA 8 DIG MX5500

Código: 17620
 Fábrica: HAI BRASIL
 Unidade: UN/1
 F1 F4



MAQUINA ETIQUETADORA 8 DIG MX5500 6505

Código: 45943
 Fábrica: WIN PAPER
 Unidade: UN/1
 F1 F4



MAQUINA ETIQUETADORA 8 DIG 10326

Código: 48723
 Fábrica: LETRON
 Unidade: UN/1
 F1 F4



MAQUINA PLASTIFICADORA BIVOLT OFICIO 280

Código: 17077
 Fábrica: MAROGER
 Unidade: UN/1
 F1 F4



MARCA TEXTO DASHLIGHT AMARELO 2201 12X1

Código: 47850
 Fábrica: BRW
 Unidade: DZ/12
 F1 F4



MARCA TEXTO DASHLIGHT LARANJA 2204 12X1

Código: 47853
 Fábrica: BRW
 Unidade: DZ/12
 F1 F4



MARCA TEXTO DASHLIGHT ROSA 2202 12X1

Código: 47851
 Fábrica: BRW
 Unidade: DZ/12
 F1 F4



MARCA TEXTO DASHLIGHT VERDE 2203 12X1

Código: 47852
 Fábrica: BRW
 Unidade: DZ/12
 F1 F4



MARCA TEXTO FLUOR AMARELO 6X1

Código: 44271
 Fábrica: M COMERCIO
 Unidade: CT/6
 F1 F4



MARCA TEXTO FLUOR AMARELO 612 12X1

Código: 41734
 Fábrica: MASTERPRINT
 Unidade: DZ/12
 F1 F4



MARCA TEXTO FLUOR AMARELO 617947 12X1

Código: 48315
 Fábrica: BAZZE
 Unidade: DZ/12
 F1 F4



MARCA TEXTO FLUOR AMAR/VERDE/LARANJA 24X1

Código: 48317
 Fábrica: BAZZE
 Unidade: CX/24
 F1 F4



MARCA TEXTO FLUOR AZUL 612 12X1

Código: 42887
 Fábrica: MASTERPRINT
 Unidade: DZ/12
 F1 F4



MARCA TEXTO FLUOR GEL AMARELO UN

Código: 35733
 Fábrica: MASTERPRINT
 Unidade: CR/1
 F1 F4



MARCA TEXTO FLUOR GEL AMARELO 613 6X1
 Código: 42585 Fábrica: MASTERPRINT Unidade: CX/6
 F1 F4



MARCA TEXTO FLUOR GEL AMARELO 9001 12X1
 Código: 20361 Fábrica: BRW Unidade: DZ/12
 F1 F4



MARCA TEXTO FLUOR GEL LARANJA 613 6X1
 Código: 48906 Fábrica: MASTERPRINT Unidade: CX/6
 F1 F4



MARCA TEXTO FLUOR GEL LARANJA 9004 12X1
 Código: 50667 Fábrica: BRW Unidade: DZ/12
 F1 F4



MARCA TEXTO FLUOR GEL ROSA 613 6X1
 Código: 48905 Fábrica: MASTERPRINT Unidade: CX/6
 F1 F4



MARCA TEXTO FLUOR GEL ROSA 9002 12X1
 Código: 50668 Fábrica: BRW Unidade: DZ/12
 F1 F4



MARCA TEXTO FLUOR LARANJA 612 12X1
 Código: 42886 Fábrica: MASTERPRINT Unidade: DZ/12
 F1 F4



MARCA TEXTO FLUOR LARANJA 900074 12X1
 Código: 48316 Fábrica: BAZZE Unidade: DZ/12
 F1 F4



MARCA TEXTO FLUOR ROSA 612 12X1
 Código: 42889 Fábrica: MASTERPRINT Unidade: DZ/12
 F1 F4



MARCA TEXTO FLUOR ROSA 904645 12X1
 Código: 48444 Fábrica: BAZZE Unidade: DZ/12
 F1 F4



MARCA TEXTO FLUOR VERDE 2003 12X1
 Código: 41085 Fábrica: BRW Unidade: DZ/12
 F1 F4



MARCA TEXTO FLUOR VERDE 612 12X1
 Código: 42885 Fábrica: MASTERPRINT Unidade: DZ/12
 F1 F4



MARCA TEXTO FLUOR VERDE 617961 12X1
 Código: 48810 Fábrica: BAZZE Unidade: DZ/12
 F1 F4



MARCA TEXTO FLUOR VERMELHO 2007 12X1
 Código: 19731 Fábrica: BRW Unidade: DZ/12
 F1 F4



MARCA TEXTO FLUOR VERMELHO 612 12X1
 Código: 42888 Fábrica: MASTERPRINT Unidade: DZ/12
 F1 F4



MARCA TEXTO METALICO SORT 612 6X1
 Código: 50007 Fábrica: MASTERPRINT Unidade: CX/6
 F1 F4



MARCA TEXTO NEON SLIM AMARELO 614 12X1
 Código: 51053 Fábrica: MASTERPRINT Unidade: DZ/12 F1 F4



MARCA TEXTO NEON SLIM AZUL 614 12X1
 Código: 51055 Fábrica: MASTERPRINT Unidade: PT/6 F1 F4



MARCA TEXTO NEON SLIM LARANJA 614 12X1
 Código: 51057 Fábrica: MASTERPRINT Unidade: DZ/12 F1 F4



MARCA TEXTO NEON SLIM ROSA 614 12X1
 Código: 51056 Fábrica: MASTERPRINT Unidade: DZ/12 F1 F4



MARCA TEXTO NEON SLIM SORT 610 6X1
 Código: 51051 Fábrica: MASTERPRINT Unidade: PT/6 F1 F4



MARCA TEXTO NEON SLIM VERDE 614 12X1
 Código: 51054 Fábrica: MASTERPRINT Unidade: DZ/12 F1 F4



MARCA TEXTO PASTEL AMARELO 612 6X1
 Código: 47215 Fábrica: MASTERPRINT Unidade: CX/6 F1 F4



MARCA TEXTO PASTEL AZUL 612 6X1
 Código: 47216 Fábrica: MASTERPRINT Unidade: CX/6 F1 F4



MARCA TEXTO PASTEL ROSE 612 6X1
 Código: 47217 Fábrica: MASTERPRINT Unidade: CX/6 F1 F4



MARCA TEXTO PASTEL SLIM SORT 611 6X1
 Código: 51052 Fábrica: MASTERPRINT Unidade: PT/6 F1 F4



MARCA TEXTO PASTEL VERDE 612 6X1
 Código: 47218 Fábrica: MASTERPRINT Unidade: CX/6 F1 F4



MARCADOR DETECTA DH FALSO 4915014
 Código: 46775 Fábrica: ONDA Unidade: CT/1 F1 F4



MASSA MODELAR 6 CORES 65 GRS 216
 Código: 33833 Fábrica: MAGIX Unidade: UN/1 F1 F4



MASSA MODELAR 6 CORES 60 GRS PLASTI UN
 Código: 45018 Fábrica: ACRILEX Unidade: UN/1 F1 F4



MASSA MODELAR 6 CORES 90 GRS PLASTI UN
 Código: 45017 Fábrica: ACRILEX Unidade: UN/1 F1 F4



MASSA MODELAR 6 CORES 90 GRS SOFT UN
 Código: 36061 Fábrica: ACRILEX Unidade: UN/1 F1 F4



MASSA MODELAR BALDE C/36UN 2,100KG

Código: 47394 Fábrica: APLICOR Unidade: UN/1 F1 F4



MASSA MODELAR POTE 500 GRS AMARELO 241

Código: 50997 Fábrica: MAGIX Unidade: UN/1 F1 F4



MASSA MODELAR POTE 500 GRS AZUL 248

Código: 50999 Fábrica: MAGIX Unidade: UN/1 F1 F4



MASSA MODELAR POTE 500 GRS BRANCO 247

Código: 50996 Fábrica: MAGIX Unidade: UN/1 F1 F4



MASSA MODELAR POTE 500 GRS ROSA 245

Código: 51001 Fábrica: MAGIX Unidade: UN/1 F1 F4



MASSA MODELAR POTE 500 GRS VERDE CLA 243

Código: 50998 Fábrica: MAGIX Unidade: UN/1 F1 F4



MASSA MODELAR 12 CORES 130 GRS 215

Código: 41010 Fábrica: MAGIX Unidade: UN/1 F1 F4



MASSA MODELAR 12 CORES 180 GRS PLASTI UN

Código: 45016 Fábrica: ACRILEX Unidade: UN/1 F1 F4



MASSA MODELAR 12 CORES 180 GRS 210

Código: 36062 Fábrica: MAGIX Unidade: UN/1 F1 F4



MOCHILA CARR MH (CAPRICHOS) MC3446

Código: 34324 Fábrica: WOKEY Unidade: UN/1 F1 F4



MOCHILA CARR MH (CAPRICHOS) MC3448

Código: 34288 Fábrica: WOKEY Unidade: UN/1 F1 F4



MOCHILA CARR MH (CAPRICHOS) 3765

Código: 34250 Fábrica: VOZZ Unidade: UN/1 F1 F4



MOCHILA CARR MH (CAPRICHOS) 3766

Código: 34310 Fábrica: VOZZ Unidade: UN/1 F1 F4



MOCHILA CARR SUPER HOT MC3437

Código: 34252 Fábrica: VOZZ Unidade: UN/1 F1 F4



MOCHILA CARR WOKEY MC3406

Código: 34287 Fábrica: WOKEY Unidade: UN/1 F1 F4



MOCHILA CARR WOKEY MC3442

Código: 34325 Fábrica: WOKEY Unidade: UN/1 F1 F4



MOCHILA CARR WOOKEY MC3465

Código: **34292** Fábrica: **WOOKEY** Unidade: **UN/1**
F1 F4



MOCHILA CARR WOOKEY MC3690

Código: **34293** Fábrica: **WOOKEY** Unidade: **UN/1**
F1 F4



MOCHILA CARR WOOKEY MC3691

Código: **34294** Fábrica: **WOOKEY** Unidade: **UN/1**
F1 F4



MOCHILA CARR WOOKEY MC3713

Código: **34298** Fábrica: **WOOKEY** Unidade: **UN/1**
F1 F4



MOCHILA CARR WOOKEY MC3714

Código: **34299** Fábrica: **WOOKEY** Unidade: **UN/1**
F1 F4



MOCHILA CARR WOOKEY 3458

Código: **34289** Fábrica: **WOOKEY** Unidade: **UN/1**
F1 F4



MOCHILA C/CARR WOOKEY MC3693

Código: **38060** Fábrica: **WOOKEY** Unidade: **UN/1**
F1 F4



MOCHILA CONVOY CASUAL POLIESTER CO70000

Código: **23649** Fábrica: **CONVOY** Unidade: **UN/1**
F1 F4



MOCHILA CONVOY CASUAL POLIESTER YS29068

Código: **34099** Fábrica: **YIN'S** Unidade: **UN/1**
F1 F4



MOCHILA CONVOY CASUAL POLIESTER YS29071

Código: **34046** Fábrica: **YIN'S** Unidade: **UN/1**
F1 F4



MOCHILA CONVOY CASUAL POLIESTER YS29073

Código: **34100** Fábrica: **YIN'S** Unidade: **UN/1**
F1 F4



MOCHILA CONVOY CASUAL POLIESTER YS29082

Código: **35874** Fábrica: **YIN'S** Unidade: **UN/1**
F1 F4



MOCHILA CONVOY JUVENIL FLORES YS29272

Código: **42940** Fábrica: **YINS** Unidade: **UN/1**
F1 F4



MOCHILA ESPORTIVA BARCELONA B01 9150

Código: **39839** Fábrica: **XERYUS** Unidade: **UN/1**
F1 F4



MOCHILA ESPORTIVA BARCELONA B06 9155

Código: **39840** Fábrica: **XERYUS** Unidade: **UN/1**
F1 F4



MOCHILA ESPORTIVA BARCELONA B07 9156

Código: **39841** Fábrica: **XERYUS** Unidade: **UN/1**
F1 F4



MOCHILA ESPORTIVA BARCELONA TEEN B1 9157
 Código: 39842 Fábrica: XERYUS Unidade: UN/1
 F1 F4



MOCHILA ESPORTIVA CORINTHIANS B01 9890
 Código: 39838 Fábrica: XERYUS Unidade: UN/1
 F1 F4



MOCHILA ESPORTIVA CORINTHIANS I01 9893
 Código: 39837 Fábrica: XERYUS Unidade: UN/1
 F1 F4



MOCHILA ESPORTIVA FLAMENGO B03 9904
 Código: 39836 Fábrica: XERYUS Unidade: UN/1
 F1 F4



MOCHILA FEM NICOBOCO NB49
 Código: 29291 Fábrica: NICOBOCO Unidade: UN/1
 F1 F4



MOCHILA INF BATTLE M M4651
 Código: 49021 Fábrica: PONTO VERDE Unidade: UN/1
 F1 F4



MOCHILA INF BATTLE PRE M4650
 Código: 49020 Fábrica: PONTO VERDE Unidade: UN/1
 F1 F4



MOCHILA INF BRANCA DE NEVE PRE M4620
 Código: 49042 Fábrica: PONTO VERDE Unidade: UN/1
 F1 F4



MOCHILA INF CALIFORNIA GIRLS REL M 3023
 Código: 32249 Fábrica: SBC Unidade: UN/1
 F1 F4



MOCHILA INF CALIFORNIA GIRLS REL P 2943
 Código: 32256 Fábrica: SBC Unidade: UN/1
 F1 F4



MOCHILA INF CALIFORNIA GIRLS REL P 3022
 Código: 32251 Fábrica: SBC Unidade: UN/1
 F1 F4



MOCHILA INF CALIFORNIA GIRLS REL P 3193
 Código: 32252 Fábrica: SBC Unidade: UN/1
 F1 F4



MOCHILA INF CARR BATTLE KIT 3PC MCK4656
 Código: 48996 Fábrica: PONTO VERDE Unidade: UN/1
 F1 F4



MOCHILA INF CARR BATTLE MC4654
 Código: 48994 Fábrica: PONTO VERDE Unidade: UN/1
 F1 F4



MOCHILA INF CARR BATTLE PRE MC4653
 Código: 48993 Fábrica: PONTO VERDE Unidade: UN/1
 F1 F4



MOCHILA INF CARR BEE FRIENDES KIT K4802
 Código: 49079 Fábrica: PONTO VERDE Unidade: UN/1
 F1 F4



MOCHILA INF CARR BELIEVE G MCK4741
 Código: 49033 Fábrica: PONTO VERDE Unidade: UN/1
 F1 F4



MOCHILA INF CARR BELLA KIT 3PC MCK3717
 Código: 34256 Fábrica: SBC Unidade: UN/1
 F1 F4



MOCHILA INF CARR BRANCA DE NEVE P MC4624
 Código: 49038 Fábrica: PONTO VERDE Unidade: UN/1
 F1 F4



MOCHILA INF CARR CRYSTAL PRINCE G 2633
 Código: 31341 Fábrica: SBC Unidade: UN/1
 F1 F4



MOCHILA INF CARR EVA ARANHA 3D KIT 4893
 Código: 49034 Fábrica: PONTO VERDE Unidade: UN/1
 F1 F4



MOCHILA INF CARR EVA PRINCESS 3D KIT 5039
 Código: 49035 Fábrica: PONTO VERDE Unidade: UN/1
 F1 F4



MOCHILA INF CARR FUNNY KIT 3PC MCK4334
 Código: 44024 Fábrica: PONTO VERDE Unidade: UN/1
 F1 F4



MOCHILA INF CARR GAME WORLD KIT 3PC 4831
 Código: 49081 Fábrica: PONTO VERDE Unidade: UN/1
 F1 F4



MOCHILA INF CARR GAMER BOY P MC4729
 Código: 49187 Fábrica: PONTO VERDE Unidade: UN/1
 F1 F4



MOCHILA INF CARR GUARDIAN KIT 3PC MK4180
 Código: 44394 Fábrica: PONTO VERDE Unidade: UN/1
 F1 F4



MOCHILA INF CARR KARS KID KIT 3PC K4666
 Código: 50517 Fábrica: PONTO VERDE Unidade: UN/1
 F1 F4



MOCHILA INF CARR KARS KIDS KIT 3PC K4667
 Código: 48997 Fábrica: PONTO VERDE Unidade: UN/1
 F1 F4



MOCHILA INF CARR KARS KIDS M4660
 Código: 32175 Fábrica: PONTO VERDE Unidade: UN/1
 F1 F4



MOCHILA INF CARR KARS KIDS PRE MC4663
 Código: 49184 Fábrica: PONTO VERDE Unidade: UN/1
 F1 F4



MOCHILA INF CARR LINHA BABY POA MC4720
 Código: 49186 Fábrica: PONTO VERDE Unidade: UN/1
 F1 F4



MOCHILA INF CARR LINHA BABY SPIDE MC4726
 Código: 46704 Fábrica: PONTO VERDE Unidade: UN/1
 F1 F4



MOCHILA INF CARR NINJA MC4685

Código: 48999 Fábrica: PONTO VERDE Unidade: UN/1 F1 F4



MOCHILA INF CARR PEQ

Código: 15520 Fábrica: HAI BRASIL Unidade: UN/1 F1 F4



MOCHILA INF CARR PIGGY G 2003

Código: 29629 Fábrica: SBC Unidade: UN/1 F1 F4



MOCHILA INF CARR PRINCE ON ICE R G3105

Código: 32171 Fábrica: SBC Unidade: UN/1 F1 F4



MOCHILA INF CARR PRINCES ON ICE G 3069

Código: 32188 Fábrica: SBC Unidade: UN/1 F1 F4



MOCHILA INF CARR PRINCES ON ICE M 3004

Código: 31844 Fábrica: SBC Unidade: UN/1 F1 F4



MOCHILA INF CARR PRINCES ON ICE M 3042

Código: 31842 Fábrica: SBC Unidade: UN/1 F1 F4



MOCHILA INF CARR PRINCES ON ICE M 3104

Código: 31843 Fábrica: SBC Unidade: UN/1 F1 F4



MOCHILA INF CARR PRINCES ON ICE P 3003

Código: 32187 Fábrica: SBC Unidade: UN/1 F1 F4



MOCHILA INF CARR PRINCESA KIT 3PC K4636

Código: 49000 Fábrica: PONTO VERDE Unidade: UN/1 F1 F4



MOCHILA INF CARR PRINCESA KIT 3PC K4637

Código: 49002 Fábrica: PONTO VERDE Unidade: UN/1 F1 F4



MOCHILA INF CARR PRINCESA M MC4634

Código: 49001 Fábrica: PONTO VERDE Unidade: UN/1 F1 F4



MOCHILA INF CARR PRINCESA M MC4635

Código: 49188 Fábrica: PONTO VERDE Unidade: UN/1 F1 F4



MOCHILA INF CARR PRINCESA PRE MC4633

Código: 49039 Fábrica: PONTO VERDE Unidade: UN/1 F1 F4



MOCHILA INF CARR PRINCESS P 2904

Código: 32186 Fábrica: SBC Unidade: UN/1 F1 F4



MOCHILA INF CARR PRINCESS PRE 2903

Código: 32325 Fábrica: SBC Unidade: UN/1 F1 F4



MOCHILA INF CARR PRINCESS R M 3092
 Código: 32184 Fábrica: SBC Unidade: UN/1
 F1 F4



MOCHILA INF CARR PRINCESS REL G 2905
 Código: 32182 Fábrica: SBC Unidade: UN/1
 F1 F4



MOCHILA INF CARR PRINCESS REL G 3073
 Código: 32183 Fábrica: SBC Unidade: UN/1
 F1 F4



MOCHILA INF CARR PRINCESS REL M 3030
 Código: 32215 Fábrica: SBC Unidade: UN/1
 F1 F4



MOCHILA INF CARR REBEL PRINCES R M2938
 Código: 32192 Fábrica: SBC Unidade: UN/1
 F1 F4



MOCHILA INF CARR REBEL PRINCESS M 2939
 Código: 32193 Fábrica: SBC Unidade: UN/1
 F1 F4



MOCHILA INF CARR SEREIA KIT 3PC MCK4616
 Código: 49036 Fábrica: PONTO VERDE Unidade: UN/1
 F1 F4



MOCHILA INF CARR SPACE BOARD+LANCHE 4702
 Código: 46703 Fábrica: PONTO VERDE Unidade: UN/1
 F1 F4



MOCHILA INF CARR SPACE KIT 3PC MCK4705
 Código: 50518 Fábrica: PONTO VERDE Unidade: UN/1
 F1 F4



MOCHILA INF CARR SPEED BOY M 3010
 Código: 32197 Fábrica: SBC Unidade: UN/1
 F1 F4



MOCHILA INF CARR SPEED BOY PRE 2961
 Código: 32196 Fábrica: SBC Unidade: UN/1
 F1 F4



MOCHILA INF CARR SPEED BOY REL G 3081
 Código: 32109 Fábrica: SBC Unidade: UN/1
 F1 F4



MOCHILA INF CARR SPEED BOY REL G3011
 Código: 32200 Fábrica: SBC Unidade: UN/1
 F1 F4



MOCHILA INF CARR SPEED WEB KIT 3PC K4646
 Código: 49003 Fábrica: PONTO VERDE Unidade: UN/1
 F1 F4



MOCHILA INF CARR SPEED WEB KIT 3PC K4647
 Código: 49004 Fábrica: PONTO VERDE Unidade: UN/1
 F1 F4



MOCHILA INF CARR SPEED WEB KIT 3PC M4144
 Código: 44393 Fábrica: PONTO VERDE Unidade: UN/1
 F1 F4



MOCHILA INF CARR SPEED WEB M MC4140

Código: **49190** Fábrica: **PONTO VERDE** Unidade: **UN/1**
F1 F4



MOCHILA INF CARR SPEED WEB MC4645

Código: **49006** Fábrica: **PONTO VERDE** Unidade: **UN/1**
F1 F4



MOCHILA INF CARR SPEED WEB PRE MC4644

Código: **49189** Fábrica: **PONTO VERDE** Unidade: **UN/1**
F1 F4



MOCHILA INF CARR SPEED WEB PRE 4643

Código: **49005** Fábrica: **PONTO VERDE** Unidade: **UN/1**
F1 F4



MOCHILA INF CARR STAR SHOW M 3882

Código: **36040** Fábrica: **SBC** Unidade: **UN/1**
F1 F4



MOCHILA INF CARR SUPER SHIELD P MC3591

Código: **38045** Fábrica: **VOZZ** Unidade: **UN/1**
F1 F4



MOCHILA INF CARR SUPER SQUARE 22454

Código: **44749** Fábrica: **WINTH** Unidade: **UN/1**
F1 F4



MOCHILA INF CARR UNILOVERS G MC3721

Código: **38041** Fábrica: **SBC** Unidade: **UN/1**
F1 F4



MOCHILA INF CARR UNILOVERS KIT 3PC 3682

Código: **34282** Fábrica: **SBC** Unidade: **UN/1**
F1 F4



MOCHILA INF CARR UNILOVERS P 3494

Código: **34280** Fábrica: **SBC** Unidade: **UN/1**
F1 F4



MOCHILA INF CARR VALENTINA M 3167

Código: **32202** Fábrica: **SBC** Unidade: **UN/1**
F1 F4



MOCHILA INF CARR VALENTINA P 3166

Código: **31845** Fábrica: **SBC** Unidade: **UN/1**
F1 F4



MOCHILA INF CARR WONDER GIRL KIT 3PC 3170

Código: **32214** Fábrica: **VOZZ** Unidade: **UN/1**
F1 F4



MOCHILA INF CARR WONDER GIRL KIT 3PC3683

Código: **34283** Fábrica: **SBC** Unidade: **UN/1**
F1 F4



MOCHILA INF CARR X-FORCE REL M 2983

Código: **32204** Fábrica: **SBC** Unidade: **UN/1**
F1 F4



MOCHILA INF CARR 3 PRINCESA KIT 3PC 4824

Código: **49078** Fábrica: **PONTO VERDE** Unidade: **UN/1**
F1 F4



MOCHILA INF CARR 3 PRINCESA KIT 3PC 4825
 Código: 49077 Fábrica: PONTO VERDE Unidade: UN/1
 F1 F4



MOCHILA INF C/CARR AIR JUMPER R G MC3745
 Código: 38037 Fábrica: SBC Unidade: UN/1
 F1 F4



MOCHILA INF C/CARR AMANDA REL G 2189
 Código: 29627 Fábrica: SBC Unidade: UN/1
 F1 F4



MOCHILA INF C/CARR BEAUTY FREAKY 194
 Código: 27800 Fábrica: SBC Unidade: UN/1
 F1 F4



MOCHILA INF C/CARR BEST FRIEND G MC3668
 Código: 38058 Fábrica: SBC Unidade: UN/1
 F1 F4



MOCHILA INF C/CARR BLOCK GAME P 3626
 Código: 34258 Fábrica: SBC Unidade: UN/1
 F1 F4



MOCHILA INF C/CARR BROKEBONES R PRE 3017
 Código: 32157 Fábrica: SBC Unidade: UN/1
 F1 F4



MOCHILA INF C/CARR BROKEBONES REL P 3122
 Código: 32107 Fábrica: SBC Unidade: UN/1
 F1 F4



MOCHILA INF C/CARR CALIFORNIA GIRL 2947
 Código: 32164 Fábrica: SBC Unidade: UN/1
 F1 F4



MOCHILA INF C/CARR CALIFORNIA GIRL G3025
 Código: 32161 Fábrica: SBC Unidade: UN/1
 F1 F4



MOCHILA INF C/CARR CALIFORNIA GIRL G3196
 Código: 32162 Fábrica: SBC Unidade: UN/1
 F1 F4



MOCHILA INF C/CARR CALIFORNIA GIRL M2946
 Código: 32160 Fábrica: SBC Unidade: UN/1
 F1 F4



MOCHILA INF C/CARR CALIFORNIA GIRL M3024
 Código: 32165 Fábrica: SBC Unidade: UN/1
 F1 F4



MOCHILA INF C/CARR CALIFORNIA GIRL M3195
 Código: 32163 Fábrica: SBC Unidade: UN/1
 F1 F4



MOCHILA INF C/CARR DOLL M MC3919
 Código: 36214 Fábrica: SBC Unidade: UN/1
 F1 F4



MOCHILA INF C/CARR HOOZ P 3634
 Código: 34271 Fábrica: SBC Unidade: UN/1
 F1 F4



MOCHILA INF C/CARR LITTLE PRINCESS P3641
 Código: 34274 Fábrica: SBC Unidade: UN/1
 F1 F4



MOCHILA INF C/CARR LOVE FASHION P 3514
 Código: 34276 Fábrica: SBC Unidade: UN/1
 F1 F4



MOCHILA INF C/CARR MAGICAL P MC2918
 Código: 32176 Fábrica: SBC Unidade: UN/1
 F1 F4



MOCHILA INF C/CARR MY PRINCES P MC3522
 Código: 40059 Fábrica: VOZZ Unidade: UN/1
 F1 F4



MOCHILA INF C/CARR MY PRINCESS P MC3543
 Código: 40055 Fábrica: SBC Unidade: UN/1
 F1 F4



MOCHILA INF C/CARR PEQUEN PRINCE R G3143
 Código: 32154 Fábrica: SBC Unidade: UN/1
 F1 F4



MOCHILA INF C/CARR PEQUENA PRINCE M 2913
 Código: 32338 Fábrica: SBC Unidade: UN/1
 F1 F4



MOCHILA INF C/CARR PEQUENA PRINCE P 2912
 Código: 32326 Fábrica: SBC Unidade: UN/1
 F1 F4



MOCHILA INF C/CARR PEQUENA PRINCE P 3036
 Código: 32305 Fábrica: SBC Unidade: UN/1
 F1 F4



MOCHILA INF C/CARR PEQUENA PRINCE P 3142
 Código: 31836 Fábrica: SBC Unidade: UN/1
 F1 F4



MOCHILA INF C/CARR PEQUENA PRINCESA 3523
 Código: 34255 Fábrica: SBC Unidade: UN/1
 F1 F4



MOCHILA INF C/CARR PET PRINCE R P 3086
 Código: 32181 Fábrica: SBC Unidade: UN/1
 F1 F4



MOCHILA INF C/CARR PET PRINCESS P 2932
 Código: 32168 Fábrica: SBC Unidade: UN/1
 F1 F4



MOCHILA INF C/CARR PET PRINCESS M MC2933
 Código: 32169 Fábrica: SBC Unidade: UN/1
 F1 F4



MOCHILA INF C/CARR PET PRINCESS R M 3087
 Código: 32178 Fábrica: SBC Unidade: UN/1
 F1 F4



MOCHILA INF C/CARR PIGGY BOY G 2051
 Código: 29686 Fábrica: SBC Unidade: UN/1
 F1 F4



MOCHILA INF C/CARR PIGGY BOY M 2432
 Código: 29654 Fábrica: SBC Unidade: UN/1
 F1 F4



MOCHILA INF C/CARR PIGGY BOY P 2050
 Código: 29685 Fábrica: SBC Unidade: UN/1
 F1 F4



MOCHILA INF CRYSTAL PRINCESS REL M 2720
 Código: 30552 Fábrica: SBC Unidade: UN/1
 F1 F4



MOCHILA INF CRYSTAL PRINCESS REL M 2768
 Código: 31312 Fábrica: SBC Unidade: UN/1
 F1 F4



MOCHILA INF DOLL P 3915
 Código: 36038 Fábrica: SBC Unidade: UN/1
 F1 F4



MOCHILA INF DOLL PRE 3914
 Código: 35975 Fábrica: SBC Unidade: UN/1
 F1 F4



MOCHILA INF FEM BEE FRIENDES PRE M4800
 Código: 49087 Fábrica: PONTO VERDE Unidade: UN/1
 F1 F4



MOCHILA INF FEM BEE FRINDEES G M4801
 Código: 49088 Fábrica: PONTO VERDE Unidade: UN/1
 F1 F4



MOCHILA INF FEM BRANCA DE NEVE G M4622
 Código: 49044 Fábrica: PONTO VERDE Unidade: UN/1
 F1 F4



MOCHILA INF FEM BRANCA DE NEVE M M4621
 Código: 49043 Fábrica: PONTO VERDE Unidade: UN/1
 F1 F4



MOCHILA INF FEM CARR SEREIA KIT 3PC 4808
 Código: 49082 Fábrica: PONTO VERDE Unidade: UN/1
 F1 F4



MOCHILA INF FEM EVA HIHIHI 3D G M4924
 Código: 49050 Fábrica: PONTO VERDE Unidade: UN/1
 F1 F4



MOCHILA INF FEM EVA PRINCESS 3D G M5038
 Código: 49049 Fábrica: PONTO VERDE Unidade: UN/1
 F1 F4



MOCHILA INF FEM EVA 3D G M4920
 Código: 49053 Fábrica: PONTO VERDE Unidade: UN/1
 F1 F4



MOCHILA INF FEM FREAKY G M4812
 Código: 49091 Fábrica: PONTO VERDE Unidade: UN/1
 F1 F4



MOCHILA INF FEM M4324
 Código: 44057 Fábrica: PONTO VERDE Unidade: UN/1
 F1 F4



MOCHILA INF FEM RAYBOW G M4959
 Código: 49095 Fábrica: PONTO VERDE Unidade: UN/1
 F1 F4



MOCHILA INF FEM SEREIA G M4807
 Código: 49097 Fábrica: PONTO VERDE Unidade: UN/1
 F1 F4



MOCHILA INF FEM SEREIA PRE M4610
 Código: 49061 Fábrica: PONTO VERDE Unidade: UN/1
 F1 F4



MOCHILA INF FEM SEREIA PRE M4806
 Código: 49096 Fábrica: PONTO VERDE Unidade: UN/1
 F1 F4



MOCHILA INF FEM TWICE PRE M4118
 Código: 49193 Fábrica: PONTO VERDE Unidade: UN/1
 F1 F4



MOCHILA INF FEM 3 PRINCESAS M4823
 Código: 49083 Fábrica: PONTO VERDE Unidade: UN/1
 F1 F4



MOCHILA INF FEM 3 PRINCESAS PRE M4822
 Código: 49084 Fábrica: PONTO VERDE Unidade: UN/1
 F1 F4



MOCHILA INF GALAXY GIRL G M3554
 Código: 38042 Fábrica: VOZZ Unidade: UN/1
 F1 F4



MOCHILA INF KIDS PLAY G M4817
 Código: 49094 Fábrica: PONTO VERDE Unidade: UN/1
 F1 F4



MOCHILA INF LINHA BABY GATINHA M M4713
 Código: 49192 Fábrica: PONTO VERDE Unidade: UN/1
 F1 F4



MOCHILA INF LINHA BABY NARUT M4722
 Código: 46707 Fábrica: PONTO VERDE Unidade: UN/1
 F1 F4



MOCHILA INF LINHA BABY PRINCESS M4716
 Código: 46705 Fábrica: PONTO VERDE Unidade: UN/1
 F1 F4



MOCHILA INF LINHA BABY SETINADO POA 4719
 Código: 49055 Fábrica: PONTO VERDE Unidade: UN/1
 F1 F4



MOCHILA INF LINHA BABY SPEED WEB M4725
 Código: 46706 Fábrica: PONTO VERDE Unidade: UN/1
 F1 F4



MOCHILA INF LO SURPRIS REL BRILHO P 1226
 Código: 35825 Fábrica: BRASILIMPORT Unidade: UN/1
 F1 F4



MOCHILA INF MASC BATTLE PRE M4844
 Código: 49086 Fábrica: PONTO VERDE Unidade: UN/1
 F1 F4



MOCHILA INF MASC BLOOK GAME G M4850

Código: 49089 Fábrica: PONTO VERDE Unidade: UN/1 F1 F4



MOCHILA INF MASC CARR SPACE KIT 3PC 4865

Código: 49037 Fábrica: PONTO VERDE Unidade: UN/1 F1 F4



MOCHILA INF MASC EVA ARANHA 3D G M4892

Código: 49045 Fábrica: PONTO VERDE Unidade: UN/1 F1 F4



MOCHILA INF MASC EVA ARANHA 3D G M4916

Código: 49048 Fábrica: PONTO VERDE Unidade: UN/1 F1 F4



MOCHILA INF MASC EVA ESTRELA 3D G M4900

Código: 49046 Fábrica: PONTO VERDE Unidade: UN/1 F1 F4



MOCHILA INF MASC EVA KARS KIDS 3D M4514

Código: 49215 Fábrica: PONTO VERDE Unidade: UN/1 F1 F4



MOCHILA INF MASC EVA MORCEGO 3D G M4896

Código: 49047 Fábrica: PONTO VERDE Unidade: UN/1 F1 F4



MOCHILA INF MASC EVA SUPER RACE 3D M4908

Código: 49054 Fábrica: PONTO VERDE Unidade: UN/1 F1 F4



MOCHILA INF MASC EVA 3D M4904

Código: 49052 Fábrica: PONTO VERDE Unidade: UN/1 F1 F4



MOCHILA INF MASC GAME WORLD M4829

Código: 49092 Fábrica: PONTO VERDE Unidade: UN/1 F1 F4



MOCHILA INF MASC GUARDIAN NIGHT PRE 4172

Código: 44395 Fábrica: PONTO VERDE Unidade: UN/1 F1 F4



MOCHILA INF MASC JUNGLE HUNTERS G M4834

Código: 49090 Fábrica: PONTO VERDE Unidade: UN/1 F1 F4



MOCHILA INF MASC SPACE G M4864

Código: 49062 Fábrica: PONTO VERDE Unidade: UN/1 F1 F4



MOCHILA INF MASC STATION DOG M4839

Código: 49098 Fábrica: PONTO VERDE Unidade: UN/1 F1 F4



MOCHILA INF NINJA G M4682

Código: 49022 Fábrica: PONTO VERDE Unidade: UN/1 F1 F4



MOCHILA INF PET PRINCESS REL P 3084

Código: 32242 Fábrica: SBC Unidade: UN/1 F1 F4



MOCHILA INF PIGGY G 2399

Código: 29523
 Fábrica: SBC
 Unidade: UN/1
 F1 F4



MOCHILA INF PIGGY BOY RELEVO G 2431

Código: 29608
 Fábrica: SBC
 Unidade: UN/1
 F1 F4



MOCHILA INF PIGGY G 2001

Código: 29622
 Fábrica: SBC
 Unidade: UN/1
 F1 F4



MOCHILA INF PIGGY P 2000

Código: 29667
 Fábrica: VOZZ
 Unidade: UN/1
 F1 F4



MOCHILA INF PIGGY RELEVO P 2398

Código: 29606
 Fábrica: SBC
 Unidade: UN/1
 F1 F4



MOCHILA INF PRINCESA G M4632

Código: 49057
 Fábrica: PONTO VERDE
 Unidade: UN/1
 F1 F4



MOCHILA INF PRINCESS G 2666

Código: 31344
 Fábrica: SBC
 Unidade: UN/1
 F1 F4



MOCHILA INF PRINCESS ON IC REL M 3103

Código: 31859
 Fábrica: SBC
 Unidade: UN/1
 F1 F4



MOCHILA INF PRINCESS ON ICE P 2509

Código: 30735
 Fábrica: SBC
 Unidade: UN/1
 F1 F4



MOCHILA INF PRINCESS ON ICE P 2594

Código: 30761
 Fábrica: SBC
 Unidade: UN/1
 F1 F4



MOCHILA INF PRINCESS ON ICE P 3001

Código: 31860
 Fábrica: SBC
 Unidade: UN/1
 F1 F4



MOCHILA INF PRINCESS ON ICE P 3102

Código: 31857
 Fábrica: SBC
 Unidade: UN/1
 F1 F4



MOCHILA INF PRINCESS ON ICE REL G 2674

Código: 30740
 Fábrica: SBC
 Unidade: UN/1
 F1 F4



MOCHILA INF PRINCESS ON ICE REL M 2763

Código: 31313
 Fábrica: SBC
 Unidade: UN/1
 F1 F4



MOCHILA INF PRINCESS ON ICE REL M 3068

Código: 32244
 Fábrica: SBC
 Unidade: UN/1
 F1 F4



MOCHILA INF PRINCESS P 2901

Código: 32240
 Fábrica: SBC
 Unidade: UN/1
 F1 F4



MOCHILA INF PRINCESS REL BRILHO P 1226

Código: 35823
 Fábrica: BRASILIMPORT
 Unidade: UN/1
 F1 F4



MOCHILA INF PRINCESS REL G 3072

Código: 32254
 Fábrica: SBC
 Unidade: UN/1
 F1 F4



MOCHILA INF PRINCESS REL M 3029

Código: 31924
 Fábrica: SBC
 Unidade: UN/1
 F1 F4



MOCHILA INF PRINCESS REL M 3091

Código: 32255
 Fábrica: SBC
 Unidade: UN/1
 F1 F4



MOCHILA INF PRINCESS REL P 3028

Código: 31923
 Fábrica: SBC
 Unidade: UN/1
 F1 F4



MOCHILA INF REBEL PRINCES REL G 2670

Código: 31315
 Fábrica: SBC
 Unidade: UN/1
 F1 F4



MOCHILA INF SEREIA G M4612

Código: 49059
 Fábrica: PONTO VERDE
 Unidade: UN/1
 F1 F4



MOCHILA INF SEREIA P M4611

Código: 49060
 Fábrica: PONTO VERDE
 Unidade: UN/1
 F1 F4



MOCHILA INF SOFI REL BRILHO P 1226

Código: 35826
 Fábrica: BRASILIMPORT
 Unidade: UN/1
 F1 F4



MOCHILA INF SOPHIA REL P 2624

Código: 30748
 Fábrica: SBC
 Unidade: UN/1
 F1 F4



MOCHILA INF SPEED BOY 2 M3598

Código: 38055
 Fábrica: SBC
 Unidade: UN/1
 F1 F4



MOCHILA INF SPEED WEB G M4642

Código: 49025
 Fábrica: PONTO VERDE
 Unidade: UN/1
 F1 F4



MOCHILA INF SPEED WEB P M4641

Código: 49023
 Fábrica: PONTO VERDE
 Unidade: UN/1
 F1 F4



MOCHILA INF SPEED WEB PRE M4640

Código: 49024
 Fábrica: PONTO VERDE
 Unidade: UN/1
 F1 F4



MOCHILA INF STAR SHOW M 3879

Código: 36099
 Fábrica: SBC
 Unidade: UN/1
 F1 F4



MOCHILA INF STAR SHOW P M3878

Código: 36100
 Fábrica: SBC
 Unidade: UN/1
 F1 F4



MOCHILA INF STAR SHOW PP 3877

Código: **36035** Fábrica: **SBC** Unidade: **UN/1**
F1 F4



MOCHILA INF SUPER CATHIE P M3547

Código: **38011** Fábrica: **VOZZ** Unidade: **UN/1**
F1 F4



MOCHILA INF UNILOVERS M M3719

Código: **38050** Fábrica: **VOZZ** Unidade: **UN/1**
F1 F4



MOCHILA INF UNILOVERS P M3718

Código: **34174** Fábrica: **SBC** Unidade: **UN/1**
F1 F4



MOCHILA JEANS EST 3 DIV DETAL CORINO 326

Código: **31679** Fábrica: **LITA** Unidade: **UN/1**
F1 F4



MOCHILA JEANS ESTAMPADO FORRO DUPL0 320

Código: **28776** Fábrica: **LITA** Unidade: **UN/1**
F1 F4



MOCHILA JEANS S/LAVAR AZUL 321

Código: **14628** Fábrica: **LITA** Unidade: **UN/1**
F1 F4



MOCHILA JEANS S/LAVAR PRETA 332

Código: **48455** Fábrica: **LITA** Unidade: **UN/1**
F1 F4



MOCHILA JUV CARR KIT 3PCS MCK 3962

Código: **41432** Fábrica: **SBC** Unidade: **CJ/1**
F1 F4



MOCHILA JUV C/CARR FEM VIKING MC3983

Código: **41426** Fábrica: **SBC** Unidade: **UN/1**
F1 F4



MOCHILA JUV FEM POLIESTER MORMAII 0116

Código: **44032** Fábrica: **MORMAII** Unidade: **UN/1**
F1 F4



MOCHILA JUV FEM POLIESTER MORMAII 0119

Código: **44033** Fábrica: **MORMAII** Unidade: **UN/1**
F1 F4



MOCHILA JUV FEM POLIESTER MORMAII 0121

Código: **44034** Fábrica: **MORMAII** Unidade: **UN/1**
F1 F4



MOCHILA JUV FEM POLIESTER MORMAII 0122

Código: **44036** Fábrica: **MORMAII** Unidade: **UN/1**
F1 F4



MOCHILA JUV FLAMINGO M M4057

Código: **41430** Fábrica: **VOZZ** Unidade: **UN/1**
F1 F4



MOCHILA JUV POLIESTER MORMAII 0111

Código: **44037** Fábrica: **MORMAII** Unidade: **UN/1**
F1 F4



MOCHILA JUV POLIESTER MORMAII 0113
 Código: 44039 Fábrica: MORMAII Unidade: UN/1
 F1 F4



MOCHILA JUV POLIESTER MORMAII 0115
 Código: 44035 Fábrica: MORMAII Unidade: UN/1
 F1 F4



MOCHILA JUV POLIESTER MORMAII 0120
 Código: 44038 Fábrica: MORMAII Unidade: UN/1
 F1 F4



MOCHILA JUVENIL BASIC 21734
 Código: 43222 Fábrica: WINTH Unidade: UN/1
 F1 F4



MOCHILA JUVENIL CASUAL POLIESTER 32084
 Código: 44071 Fábrica: WINTH Unidade: UN/1
 F1 F4



MOCHILA JUVENIL CASUAL 32142
 Código: 43600 Fábrica: WINTH Unidade: UN/1
 F1 F4



MOCHILA JUVENIL COST HOT PINK 0800404
 Código: 35620 Fábrica: GOSUPER Unidade: UN/1
 F1 F4



MOCHILA JUVENIL FEM ESTAMPA 30063
 Código: 45938 Fábrica: WINTH TEEN Unidade: UN/1
 F1 F4



MOCHILA JUVENIL FEM FS BORBOLETAS 30511
 Código: 45939 Fábrica: WINTH Unidade: UN/1
 F1 F4



MOCHILA JUVENIL FEM FS FLAMINGOS 30461
 Código: 45940 Fábrica: WINTH Unidade: UN/1
 F1 F4



MOCHILA JUVENIL FEM LOVEKING M4736
 Código: 48982 Fábrica: PONTO VERDE Unidade: UN/1
 F1 F4



MOCHILA JUVENIL FEM LOVEKING M4737
 Código: 48967 Fábrica: PONTO VERDE Unidade: UN/1
 F1 F4



MOCHILA JUVENIL FEM LOVEKING M5033
 Código: 48975 Fábrica: PONTO VERDE Unidade: UN/1
 F1 F4



MOCHILA JUVENIL FEM LOVEKING M5034
 Código: 48972 Fábrica: PONTO VERDE Unidade: UN/1
 F1 F4



MOCHILA JUVENIL FEM LOVEKING M5035
 Código: 48978 Fábrica: PONTO VERDE Unidade: UN/1
 F1 F4



MOCHILA JUVENIL FEM LOVEKING M5036
 Código: 48970 Fábrica: PONTO VERDE Unidade: UN/1
 F1 F4



MOCHILA JUVENIL FEM MH3300

Código: 32348
 Fábrica: SBC
 Unidade: UN/1
 F1 F4



MOCHILA JUVENIL FEM MH3303

Código: 32110
 Fábrica: SBC
 Unidade: UN/1
 F1 F4



MOCHILA JUVENIL FEM POLIESTER GARDE 2331

Código: 44049
 Fábrica: RABISK
 Unidade: UN/1
 F1 F4



MOCHILA JUVENIL FEM POLIESTER STARS 2332

Código: 44050
 Fábrica: RABISK
 Unidade: UN/1
 F1 F4



MOCHILA JUVENIL FEM SBC MH MH3768

Código: 36033
 Fábrica: SBC
 Unidade: UN/1
 F1 F4



MOCHILA JUVENIL FEM SBC MH MH3971

Código: 36044
 Fábrica: SBC
 Unidade: UN/1
 F1 F4



MOCHILA JUVENIL FEM SBC MH M3767

Código: 36094
 Fábrica: SBC
 Unidade: UN/1
 F1 F4



MOCHILA JUVENIL FEM SBC MH M3769

Código: 36058
 Fábrica: SBC
 Unidade: UN/1
 F1 F4



MOCHILA JUVENIL FEM SBC MH3171

Código: 32320
 Fábrica: SBC
 Unidade: UN/1
 F1 F4



MOCHILA JUVENIL FEM SBC VKG M3987

Código: 36220
 Fábrica: SBC
 Unidade: UN/1
 F1 F4



MOCHILA JUVENIL FEM TOP MODEL TM25

Código: 48974
 Fábrica: PONTO VERDE
 Unidade: UN/1
 F1 F4



MOCHILA JUVENIL FEM TOP MODEL TM26

Código: 48979
 Fábrica: PONTO VERDE
 Unidade: UN/1
 F1 F4



MOCHILA JUVENIL FEM UNI LOVER EMOJ M3774

Código: 34304
 Fábrica: SBC
 Unidade: UN/1
 F1 F4



MOCHILA JUVENIL FEM VKG M4263

Código: 48963
 Fábrica: PONTO VERDE
 Unidade: UN/1
 F1 F4



MOCHILA JUVENIL FEM VKG M4286

Código: 48971
 Fábrica: PONTO VERDE
 Unidade: UN/1
 F1 F4



MOCHILA JUVENIL FEM VKG M4302

Código: 44396
 Fábrica: PONTO VERDE
 Unidade: UN/1
 F1 F4



MOCHILA JUVENIL FEM VKG M4305

Código: 44398
 Fábrica: PONTO VERDE
 Unidade: UN/1
 F1 F4



MOCHILA JUVENIL FEM VKG M4356

Código: 48981
 Fábrica: PONTO VERDE
 Unidade: UN/1
 F1 F4



MOCHILA JUVENIL FEM WOOKEY 3687

Código: 34206
 Fábrica: WOOKEY
 Unidade: UN/1
 F1 F4



MOCHILA JUVENIL FEM 31824

Código: 43594
 Fábrica: WINTH
 Unidade: UN/1
 F1 F4



MOCHILA JUVENIL FEM 31834

Código: 43593
 Fábrica: WINTH
 Unidade: UN/1
 F1 F4



MOCHILA JUVENIL FEM 31844

Código: 43595
 Fábrica: WINTH
 Unidade: UN/1
 F1 F4



MOCHILA JUVENIL FEM 31924

Código: 43229
 Fábrica: WINTH
 Unidade: UN/1
 F1 F4



MOCHILA JUVENIL FEM 31994

Código: 43228
 Fábrica: WINTH
 Unidade: UN/1
 F1 F4



MOCHILA JUVENIL FEM 32014

Código: 43225
 Fábrica: WINTH
 Unidade: UN/1
 F1 F4



MOCHILA JUVENIL FEM 32024

Código: 43226
 Fábrica: WINTH
 Unidade: UN/1
 F1 F4



MOCHILA JUVENIL FEM 32034

Código: 43227
 Fábrica: WINTH
 Unidade: UN/1
 F1 F4



MOCHILA JUVENIL FEM 32054

Código: 43596
 Fábrica: WINTH
 Unidade: UN/1
 F1 F4



MOCHILA JUVENIL HI PANDA 4327

Código: 44397
 Fábrica: PONTO VERDE
 Unidade: UN/1
 F1 F4



MOCHILA JUVENIL JAKARTA M5000

Código: 49012
 Fábrica: PONTO VERDE
 Unidade: UN/1
 F1 F4



MOCHILA JUVENIL JAKARTA M5006

Código: 49017
 Fábrica: PONTO VERDE
 Unidade: UN/1
 F1 F4



MOCHILA JUVENIL JAKARTA M5008

Código: 49018
 Fábrica: PONTO VERDE
 Unidade: UN/1
 F1 F4



MOCHILA JUVENIL MASC FULL COLOR 21834

Código: 45937 Fábrica: WINTH Unidade: UN/1 F1 F4



MOCHILA JUVENIL MASC PATCHES 20023

Código: 45936 Fábrica: WINTH TEEN Unidade: UN/1 F1 F4



MOCHILA JUVENIL MASC POLIESTER 21774

Código: 44070 Fábrica: WINTH Unidade: UN/1 F1 F4



MOCHILA JUVENIL MASC 21534

Código: 43597 Fábrica: WINTH Unidade: UN/1 F1 F4



MOCHILA JUVENIL MASC 21584

Código: 43598 Fábrica: WINTH Unidade: UN/1 F1 F4



MOCHILA JUVENIL MASC 21594

Código: 43599 Fábrica: WINTH Unidade: UN/1 F1 F4



MOCHILA JUVENIL MASC 21724

Código: 43223 Fábrica: WINTH Unidade: UN/1 F1 F4



MOCHILA JUVENIL MASC 21744

Código: 43224 Fábrica: WINTH Unidade: UN/1 F1 F4



MOCHILA JUVENIL MH M3445

Código: 34195 Fábrica: SBC Unidade: UN/1 F1 F4



MOCHILA JUVENIL POLIESTER FEM WILSON 531

Código: 43668 Fábrica: WILSON Unidade: UN/1 F1 F4



MOCHILA JUVENIL POLIESTER MORMAII 110/21

Código: 45404 Fábrica: MORMAII Unidade: UN/1 F1 F4



MOCHILA JUVENIL POLIESTER MORMAII 124

Código: 45405 Fábrica: MORMAII Unidade: UN/1 F1 F4



MOCHILA JUVENIL POLIESTER MORMAII 209

Código: 45403 Fábrica: MORMAII Unidade: UN/1 F1 F4



MOCHILA JUVENIL POLIESTER MORMAII 210

Código: 46793 Fábrica: MORMAII Unidade: UN/1 F1 F4



MOCHILA JUVENIL POLIESTER MORMAII 211

Código: 45408 Fábrica: MORMAII Unidade: UN/1 F1 F4



MOCHILA JUVENIL POLIESTER MORMAII 213

Código: 45406 Fábrica: MORMAII Unidade: UN/1 F1 F4



MOCHILA JUVENIL POLIESTER MORMAII 214

Código: 45409 Fábrica: MORMAII Unidade: UN/1
F1 F4



MOCHILA JUVENIL POLIESTER MORMAII 215

Código: 45407 Fábrica: MORMAII Unidade: UN/1
F1 F4



MOCHILA JUVENIL POLIESTER WILSON 514

Código: 43688 Fábrica: WILSON Unidade: UN/1
F1 F4



MOCHILA JUVENIL POLIESTER WILSON 515

Código: 43687 Fábrica: WILSON Unidade: UN/1
F1 F4



MOCHILA JUVENIL POLIESTER WILSON 520

Código: 43692 Fábrica: WILSON Unidade: UN/1
F1 F4



MOCHILA JUVENIL POLIESTER WILSON 521

Código: 43673 Fábrica: WILSON Unidade: UN/1
F1 F4



MOCHILA JUVENIL POLIESTER WILSON 524

Código: 43691 Fábrica: WILSON Unidade: UN/1
F1 F4



MOCHILA JUVENIL POLIESTER WILSON 529

Código: 43686 Fábrica: WILSON Unidade: UN/1
F1 F4



MOCHILA JUVENIL POLIESTER WILSON 530

Código: 43678 Fábrica: WILSON Unidade: UN/1
F1 F4



MOCHILA JUVENIL POLIESTER WILSON 533

Código: 43675 Fábrica: WILSON Unidade: UN/1
F1 F4



MOCHILA JUVENIL POLIESTER WILSON 536

Código: 43676 Fábrica: WILSON Unidade: UN/1
F1 F4



MOCHILA JUVENIL POLIESTER WILSON 537

Código: 43674 Fábrica: WILSON Unidade: UN/1
F1 F4



MOCHILA JUVENIL POLIESTER WILSON 544

Código: 43684 Fábrica: WILSON Unidade: UN/1
F1 F4



MOCHILA JUVENIL POLIESTER WILSON 545

Código: 43670 Fábrica: WILSON Unidade: UN/1
F1 F4



MOCHILA JUVENIL POLIESTER WILSON 546

Código: 43704 Fábrica: WILSON Unidade: UN/1
F1 F4



MOCHILA JUVENIL POLIESTER WILSON 548

Código: 43690 Fábrica: WILSON Unidade: UN/1
F1 F4



MOCHILA JUVENIL POLIESTER WILSON 550

Código: 43677 Fábrica: WILSON Unidade: UN/1 F1 F4



MOCHILA JUVENIL POLIESTER WILSON 554

Código: 43705 Fábrica: WILSON Unidade: UN/1 F1 F4



MOCHILA JUVENIL POLIESTER WILSON 558

Código: 43671 Fábrica: WILSON Unidade: UN/1 F1 F4



MOCHILA JUVENIL POLIESTER WILSON 560

Código: 43681 Fábrica: WILSON Unidade: UN/1 F1 F4



MOCHILA JUVENIL POLIESTER WILSON 563

Código: 43669 Fábrica: WILSON Unidade: UN/1 F1 F4



MOCHILA JUVENIL POLIESTER WILSON 619

Código: 43672 Fábrica: WILSON Unidade: UN/1 F1 F4



MOCHILA JUVENIL POLIESTER 2333

Código: 44041 Fábrica: RABISK Unidade: UN/1 F1 F4



MOCHILA JUVENIL POLIESTER 2334

Código: 44040 Fábrica: RABISK Unidade: UN/1 F1 F4



MOCHILA JUVENIL POLIESTER 46310

Código: 43783 Fábrica: ADV Unidade: UN/1 F1 F4



MOCHILA JUVENIL PRETA 6201

Código: 19416 Fábrica: FUSECO Unidade: UN/1 F1 F4



MOCHILA JUVENIL PRETA 6202

Código: 19417 Fábrica: FUSECO Unidade: UN/1 F1 F4



MOCHILA JUVENIL PRETA 6204

Código: 19419 Fábrica: FUSECO Unidade: UN/1 F1 F4



MOCHILA JUVENIL PRETA 6205

Código: 19420 Fábrica: FUSECO Unidade: UN/1 F1 F4



MOCHILA JUVENIL PRETA 6206

Código: 19421 Fábrica: FUSECO Unidade: UN/1 F1 F4



MOCHILA JUVENIL PRETA 6207

Código: 19422 Fábrica: FUSECO Unidade: UN/1 F1 F4



MOCHILA JUVENIL PRETA 6208

Código: 19423 Fábrica: FUSECO Unidade: UN/1 F1 F4



MOCHILA JUVENIL PRETA 7801

Código: 19424
 Fábrica: FUSECO
 Unidade: UN/1
 F1 F4



MOCHILA JUVENIL PRETA 7803

Código: 19425
 Fábrica: FUSECO
 Unidade: UN/1
 F1 F4



MOCHILA JUVENIL PRETA 7808

Código: 19426
 Fábrica: FUSECO
 Unidade: UN/1
 F1 F4



MOCHILA JUVENIL SBC VKG M4061

Código: 38044
 Fábrica: SBC
 Unidade: UN/1
 F1 F4



MOCHILA JUVENIL UNI LOVERS M3469

Código: 32936
 Fábrica: SBC
 Unidade: UN/1
 F1 F4



MOCHILA JUVENIL WOOKEY M3443

Código: 38054
 Fábrica: WOOKEY
 Unidade: UN/1
 F1 F4



MOCHILA JUVENIL WOOKEY M3447

Código: 34196
 Fábrica: WOOKEY
 Unidade: UN/1
 F1 F4



MOCHILA JUVENIL WOOKEY M3686

Código: 34205
 Fábrica: WOOKEY
 Unidade: UN/1
 F1 F4



MOCHILA JUVENIL WOOKEY M3688

Código: 34207
 Fábrica: WOOKEY
 Unidade: UN/1
 F1 F4



MOCHILA JUVENIL WOOKEY M3965

Código: 44055
 Fábrica: PONTO VERDE
 Unidade: UN/1
 F1 F4



MOCHILA JUVENIL WOOKEY M3967

Código: 46470
 Fábrica: WOOKEY
 Unidade: UN/1
 F1 F4



MOCHILA JUVENIL WOOKEY M4058

Código: 38043
 Fábrica: WOOKEY
 Unidade: UN/1
 F1 F4



MOCHILA JUVENIL WOOKEY 3441

Código: 34194
 Fábrica: WOOKEY
 Unidade: UN/1
 F1 F4



MOCHILA JUVENIL WOOKEY 3460

Código: 34201
 Fábrica: WOOKEY
 Unidade: UN/1
 F1 F4



MOCHILA JUVENIL WOOKEY 3461

Código: 34203
 Fábrica: WOOKEY
 Unidade: UN/1
 F1 F4



MOCHILA JUVENIL WOOKEY 3462

Código: 34202
 Fábrica: WOOKEY
 Unidade: UN/1
 F1 F4



MOCHILA JUVENIL WOOKEY 3463

Código: **34204** Fábrica: **WOOKEY** Unidade: **UN/1**
F1 F4



MOCHILA LAP TOP AZX CB ACO PRETA 1476

Código: **46734** Fábrica: **ROCIE** Unidade: **UN/1**
F1 F4



MOCHILA LAP TOP AZX CB ACO PRETA 1478

Código: **46146** Fábrica: **ROCIE** Unidade: **UN/1**
F1 F4



MOCHILA LAP TOP AZX PRETA 1520

Código: **46145** Fábrica: **ROCIE** Unidade: **UN/1**
F1 F4



MOCHILA LONA WOOKEY CB ACO W2021

Código: **29360** Fábrica: **WOOKEY** Unidade: **UN/1**
F1 F4



MOCHILA LOVELY GIRL TM18 LG-1880

Código: **35768** Fábrica: **SPEXPRESS** Unidade: **UN/1**
F1 F4



MOCHILA NOTEBOOK BLOONFIELD BF13

Código: **26951** Fábrica: **BLOONFIELD** Unidade: **UN/1**
F1 F4



MOCHILA NOTEBOOK BLOONFIELD BF50

Código: **30538** Fábrica: **BLOONFIELD** Unidade: **UN/1**
F1 F4



MOCHILA NOTEBOOK BLOONFIELD CB ACO BF42

Código: **29298** Fábrica: **BLOONFIELD** Unidade: **UN/1**
F1 F4



MOCHILA NOTEBOOK BLOONFIELD CB ACO BF43

Código: **29611** Fábrica: **BLOONFIELD** Unidade: **UN/1**
F1 F4



MOCHILA NOTEBOOK BLOONFIELD CB ACO BF44

Código: **29614** Fábrica: **BLOONFIELD** Unidade: **UN/1**
F1 F4



MOCHILA NOTEBOOK BLOONFIELD CB ACO BF45

Código: **29613** Fábrica: **BLOONFIELD** Unidade: **UN/1**
F1 F4



MOCHILA NOTEBOOK BLOONFIELD CB ACO BF57

Código: **49196** Fábrica: **PONTO VERDE** Unidade: **UN/1**
F1 F4



MOCHILA NOTEBOOK BLOONFIELD CB ACO BF58

Código: **49197** Fábrica: **PONTO VERDE** Unidade: **UN/1**
F1 F4



MOCHILA NOTEBOOK BLOONFIELD CB ACO M4500

Código: **46458** Fábrica: **BLOONFIELD** Unidade: **UN/1**
F1 F4



MOCHILA NOTEBOOK BLOONFIELD CB ACO M4501

Código: **44053** Fábrica: **BLOONFIELD** Unidade: **UN/1**
F1 F4



MOCHILA NOTEBOOK BLOONFIELD CB ACO M4502
 Código: 44054 Fábrica: BLOONFIELD Unidade: UN/1
 F1 F4



MOCHILA NOTEBOOK BLOONFIELD CB ACO M4505
 Código: 46455 Fábrica: BLOONFIELD Unidade: UN/1
 F1 F4



MOCHILA NOTEBOOK BLOONFIELD CB ACO M4506
 Código: 46456 Fábrica: BLOONFIELD Unidade: UN/1
 F1 F4



MOCHILA NOTEBOOK BLOONFIELD CB ACO M4507
 Código: 46457 Fábrica: BLOONFIELD Unidade: UN/1
 F1 F4



MOCHILA NOTEBOOK BLOONFIELD CB ACO M5019
 Código: 48986 Fábrica: PONTO VERDE Unidade: UN/1
 F1 F4



MOCHILA NOTEBOOK BLOONFIELD CB ACO M5022
 Código: 49069 Fábrica: BLOONFIELD Unidade: UN/1
 F1 F4



MOCHILA NOTEBOOK BLOONFIELD CB ACO M5023
 Código: 49068 Fábrica: BLOONFIELD Unidade: UN/1
 F1 F4



MOCHILA NOTEBOOK CB ACO 188-83
 Código: 45592 Fábrica: KIMTINO Unidade: UN/1
 F1 F4



MOCHILA NOTEBOOK CB ACO 188-85
 Código: 45591 Fábrica: KIMTINO Unidade: UN/1
 F1 F4



MOCHILA NOTEBOOK CB ACO 188-86
 Código: 45610 Fábrica: KIMTINO Unidade: UN/1
 F1 F4



MOCHILA NOTEBOOK C/CARR BLOONFIELD BF09
 Código: 31805 Fábrica: BLOONFIELD Unidade: UN/1
 F1 F4



MOCHILA NOTEBOOK C/CARR BLOONFIELD BF15
 Código: 31806 Fábrica: BLOONFIELD Unidade: UN/1
 F1 F4



MOCHILA NOTEBOOK C/CARR BLOONFIELD BF16
 Código: 32347 Fábrica: BLOONFIELD Unidade: UN/1
 F1 F4



MOCHILA NOTEBOOK C/CARR BLOONFIELD BF70
 Código: 33968 Fábrica: BLOONFIELD Unidade: UN/1
 F1 F4



MOCHILA NOTEBOOK C/CARR FEM MC4297
 Código: 49194 Fábrica: PONTO VERDE Unidade: UN/1
 F1 F4



MOCHILA NOTEBOOK C/CARR FEM VKG MC4290
 Código: 49195 Fábrica: PONTO VERDE Unidade: UN/1
 F1 F4



MOCHILA NOTEBOOK C/CARR MH BFC75/74

Código: **34312** Fábrica: **BLOONFIELD** Unidade: **UN/1**
F1 F4



MOCHILA NOTEBOOK C/CARRINHO TM10

Código: **31736** Fábrica: **VOZZ** Unidade: **UN/1**
F1 F4



MOCHILA NOTEBOOK C/CARRINHO TM11

Código: **31737** Fábrica: **VOZZ** Unidade: **UN/1**
F1 F4



MOCHILA NOTEBOOK C/CARRINHO TM13

Código: **31739** Fábrica: **VOZZ** Unidade: **UN/1**
F1 F4



MOCHILA NOTEBOOK C/CARRINHO TM14

Código: **31740** Fábrica: **VOZZ** Unidade: **UN/1**
F1 F4



MOCHILA NOTEBOOK C/CARRINHO TM15

Código: **31741** Fábrica: **VOZZ** Unidade: **UN/1**
F1 F4



MOCHILA NOTEBOOK C/CARRINHO TM34

Código: **34309** Fábrica: **VOZZ** Unidade: **UN/1**
F1 F4



MOCHILA NOTEBOOK INTERLAKEN CB ACO M5002

Código: **49007** Fábrica: **PONTO VERDE** Unidade: **UN/1**
F1 F4



MOCHILA NOTEBOOK INTERLAKEN CB ACO M5003

Código: **49019** Fábrica: **PONTO VERDE** Unidade: **UN/1**
F1 F4



MOCHILA NOTEBOOK INTERLAKEN CB ACO M5004

Código: **49009** Fábrica: **PONTO VERDE** Unidade: **UN/1**
F1 F4



MOCHILA NOTEBOOK WOOKEY GG W59

Código: **46460** Fábrica: **WOOKEY** Unidade: **UN/1**
F1 F4



MOCHILA PAW PATROL M M8492

Código: **37879** Fábrica: **XERYUS** Unidade: **UN/1**
F1 F4



MOCHILA POLIESTER WILSON 65010031

Código: **37839** Fábrica: **WILSON** Unidade: **UN/1**
F1 F4



MOCHILA POLIESTER WILSON 65010195

Código: **37836** Fábrica: **WILSON** Unidade: **UN/1**
F1 F4



MOCHILA POLIESTER WILSON 65010197

Código: **37835** Fábrica: **WILSON** Unidade: **UN/1**
F1 F4



MOCHILA POLIESTER WILSON 65010207

Código: **37837** Fábrica: **WILSON** Unidade: **UN/1**
F1 F4



MOCHILA POLIESTER WILSON 65010208

Código: 37838
 Fábrica: WILSON
 Unidade: UN/1
 F1 F4



MOCHILA SACO 01 BARCELONA 8317

Código: 39843
 Fábrica: XERYUS
 Unidade: UN/1
 F1 F4



MOCHILA SACO 02 BARCELONA 8318

Código: 39844
 Fábrica: XERYUS
 Unidade: UN/1
 F1 F4



MOCHILA TM17 LS-1718

Código: 35778
 Fábrica: SPEXPRESS
 Unidade: UN/1
 F1 F4



MOUSE GAMER X7

Código: 36296
 Fábrica: INOVA
 Unidade: UN/1
 F4



MOUSE OPTICO SCROLL USB 74300

Código: 26801
 Fábrica: LETRON
 Unidade: UN/1
 F1 F4



MOUSE PAD C/IMPRESSAO 210X210MM

Código: 42741
 Fábrica: DELLO
 Unidade: UN/1
 F1 F4



MOUSE PAD ERGONOMICO C/APOIO P/PUNHO

Código: 42831
 Fábrica: MBTECH
 Unidade: UN/1
 F1 F4

30 cm
 80 cm



MOUSE PAD P/JOGOS 800X300X3MM 308

Código: 41306
 Fábrica: INOVA
 Unidade: UN/1
 F1 F4



MOUSE PAD PRETO 6553 210X210MM

Código: 41807
 Fábrica: DELLO
 Unidade: UN/1
 F1 F4



MOUSE PAD SLIM 20X18CM 74412

Código: 46346
 Fábrica: LETRON
 Unidade: PT/1
 F1 F4

18cm
 20cm



MOUSE S/FIO 8608/8541/8580

Código: 27125
 Fábrica: INOVA
 Unidade: UN/1
 F1 F4



MOVIMENTO CAIXA 1/4 CD 100 F 154X216 5X1

Código: 3381
 Fábrica: SAO DOMINGOS
 Unidade: PT/5
 F1 F4

13cm



NUMEROS EVA 13CM 0 AMARELO 10X1

Código: 38866
 Fábrica: BRASILPAPERS
 Unidade: PT/10
 F1 F4

13cm

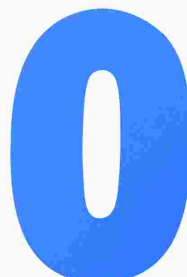

NUMEROS EVA 13CM 0 AZUL 10X1











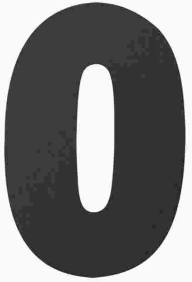

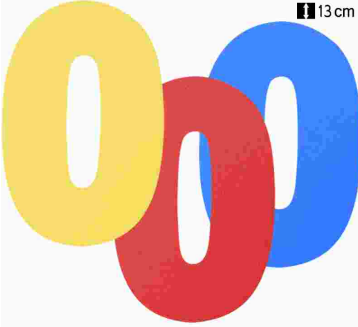

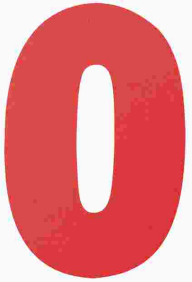

Código: 39054
 Fábrica: BRASILPAPERS
 Unidade: PT/10
 F1 F4

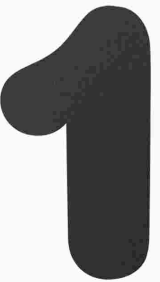













13cm



NUMEROS EVA 13CM 0 BRANCO 10X1

Código: 38856
 Fábrica: BRASILPAPERS
 Unidade: PT/10
 F1 F4

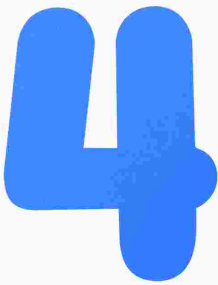
 <p>NUMEROS EVA 13CM 0 PRETO 10X1 Código: 39093 Fábrica: BRASILPAPERS Unidade: PT/10 F1 F4</p>	 <p>NUMEROS EVA 13CM 0 ROSA 10X1 Código: 39063 Fábrica: BRASILPAPERS Unidade: PT/10 F1 F4</p>	 <p>NUMEROS EVA 13CM 0 SORTIDO 10X1 Código: 39103 Fábrica: BRASILPAPERS Unidade: PT/10 F1 F4</p>	 <p>NUMEROS EVA 13CM 0 VERDE 10X1 Código: 39081 Fábrica: BRASILPAPERS Unidade: PT/10 F1 F4</p>
 <p>NUMEROS EVA 13CM 0 VERMELHO 10X1 Código: 39073 Fábrica: BRASILPAPERS Unidade: PT/10 F1 F4</p>	 <p>NUMEROS EVA 13CM 1 AMARELO 10X1 Código: 38857 Fábrica: BRASILPAPERS Unidade: PT/10 F1 F4</p>	 <p>NUMEROS EVA 13CM 1 AZUL 10X1 Código: 38868 Fábrica: BRASILPAPERS Unidade: PT/10 F1 F4</p>	 <p>NUMEROS EVA 13CM 1 BRANCO 10X1 Código: 38848 Fábrica: BRASILPAPERS Unidade: PT/10 F1 F4</p>
 <p>NUMEROS EVA 13CM 1 PRETO 10X1 Código: 39084 Fábrica: BRASILPAPERS Unidade: PT/10 F1 F4</p>	 <p>NUMEROS EVA 13CM 1 ROSA 10X1 Código: 38867 Fábrica: BRASILPAPERS Unidade: PT/10 F1 F4</p>	 <p>NUMEROS EVA 13CM 1 SORTIDO 10X1 Código: 39094 Fábrica: BRASILPAPERS Unidade: PT/10 F1 F4</p>	 <p>NUMEROS EVA 13CM 1 VERDE 10X1 Código: 39074 Fábrica: BRASILPAPERS Unidade: PT/10 F1 F4</p>
 <p>NUMEROS EVA 13CM 1 VERMELHO 10X1 Código: 39064 Fábrica: BRASILPAPERS Unidade: PT/10 F1 F4</p>	 <p>NUMEROS EVA 13CM 2 AMARELO 10X1 Código: 38858 Fábrica: BRASILPAPERS Unidade: PT/10 F1 F4</p>	 <p>NUMEROS EVA 13CM 2 AZUL 10X1 Código: 38869 Fábrica: BRASILPAPERS Unidade: PT/10 F1 F4</p>	 <p>NUMEROS EVA 13CM 2 BRANCO 10X1 Código: 38849 Fábrica: BRASILPAPERS Unidade: PT/10 F1 F4</p>

<p style="text-align: right;">13 cm</p>  <p>NUMEROS EVA 13CM 2 PRETO 10X1 Código: 39085 Fábrica: BRASILPAPERS Unidade: PT/10 F1 F4</p>	<p style="text-align: right;">13 cm</p>  <p>NUMEROS EVA 13CM 2 ROSA 10X1 Código: 39055 Fábrica: BRASILPAPERS Unidade: PT/10 F1 F4</p>	<p style="text-align: right;">13 cm</p>  <p>NUMEROS EVA 13CM 2 SORTIDO 10X1 Código: 39096 Fábrica: BRASILPAPERS Unidade: PT/10 F1 F4</p>	<p style="text-align: right;">13 cm</p>  <p>NUMEROS EVA 13CM 2 VERDE 10X1 Código: 39075 Fábrica: BRASILPAPERS Unidade: PT/10 F1 F4</p>
<p style="text-align: right;">13 cm</p>  <p>NUMEROS EVA 13CM 3 VERMELHO 10X1 Código: 39065 Fábrica: BRASILPAPERS Unidade: PT/10 F1 F4</p>	<p style="text-align: right;">13 cm</p>  <p>NUMEROS EVA 13CM 3 AMARELO 10X1 Código: 38859 Fábrica: BRASILPAPERS Unidade: PT/10 F1 F4</p>	<p style="text-align: right;">13 cm</p>  <p>NUMEROS EVA 13CM 3 AZUL 10X1 Código: 38870 Fábrica: BRASILPAPERS Unidade: PT/10 F1 F4</p>	<p style="text-align: right;">13 cm</p>  <p>NUMEROS EVA 13CM 3 BRANCO 10X1 Código: 38850 Fábrica: BRASILPAPERS Unidade: PT/10 F1 F4</p>
<p style="text-align: right;">13 cm</p>  <p>NUMEROS EVA 13CM 3 PRETO 10X1 Código: 39086 Fábrica: BRASILPAPERS Unidade: PT/10 F1 F4</p>	<p style="text-align: right;">13 cm</p>  <p>NUMEROS EVA 13CM 3 ROSA 10X1 Código: 39056 Fábrica: BRASILPAPERS Unidade: PT/10 F1 F4</p>	<p style="text-align: right;">13 cm</p>  <p>NUMEROS EVA 13CM 3 SORTIDO 10X1 Código: 39097 Fábrica: BRASILPAPERS Unidade: PT/10 F1 F4</p>	<p style="text-align: right;">13 cm</p>  <p>NUMEROS EVA 13CM 3 VERDE 10X1 Código: 39076 Fábrica: BRASILPAPERS Unidade: PT/10 F1 F4</p>
<p style="text-align: right;">13 cm</p>  <p>NUMEROS EVA 13CM 3 VERMELHO 10X1 Código: 39066 Fábrica: BRASILPAPERS Unidade: PT/10 F1 F4</p>	<p style="text-align: right;">13 cm</p>  <p>NUMEROS EVA 13CM 4 AMARELO 10X1 Código: 38860 Fábrica: BRASILPAPERS Unidade: PT/10 F1 F4</p>	<p style="text-align: right;">13 cm</p>  <p>NUMEROS EVA 13CM 4 AZUL 10X1 Código: 38871 Fábrica: BRASILPAPERS Unidade: PT/10 F1 F4</p>	<p style="text-align: right;">13 cm</p>  <p>NUMEROS EVA 13CM 4 BRANCO 10X1 Código: 38851 Fábrica: BRASILPAPERS Unidade: PT/10 F1 F4</p>

13 cm

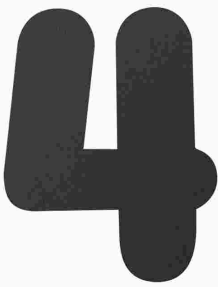

NUMEROS EVA 13CM 4 PRETO 10X1
 Código: 39087 Fábrica: BRASPAPERS Unidade: PT/10 F1 F4

13 cm



NUMEROS EVA 13CM 4 ROSA 10X1
 Código: 39057 Fábrica: BRASPAPERS Unidade: PT/10 F1 F4

13 cm



NUMEROS EVA 13CM 4 SORTIDO 10X1
 Código: 39095 Fábrica: BRASPAPERS Unidade: PT/10 F1 F4

13 cm



NUMEROS EVA 13CM 4 VERDE 10X1
 Código: 39077 Fábrica: BRASPAPERS Unidade: PT/10 F1 F4

13 cm



NUMEROS EVA 13CM 4 VERMELHO 10X1
 Código: 39067 Fábrica: BRASPAPERS Unidade: PT/10 F1 F4

13 cm



NUMEROS EVA 13CM 5 AMARELO 10X1
 Código: 38861 Fábrica: BRASPAPERS Unidade: PT/10 F1 F4

13 cm



NUMEROS EVA 13CM 5 AZUL 10X1
 Código: 38872 Fábrica: BRASPAPERS Unidade: PT/10 F1 F4

13 cm



NUMEROS EVA 13CM 5 BRANCO 10X1
 Código: 38877 Fábrica: BRASPAPERS Unidade: PT/10 F1 F4

13 cm



NUMEROS EVA 13CM 5 PRETO 10X1
 Código: 39088 Fábrica: BRASPAPERS Unidade: PT/10 F1 F4

13 cm



NUMEROS EVA 13CM 5 ROSA 10X1
 Código: 39058 Fábrica: BRASPAPERS Unidade: PT/10 F1 F4

13 cm



NUMEROS EVA 13CM 5 SORTIDO 10X1
 Código: 39098 Fábrica: BRASPAPERS Unidade: PT/10 F1 F4

13 cm



NUMEROS EVA 13CM 5 VERDE 10X1
 Código: 39078 Fábrica: BRASPAPERS Unidade: PT/10 F1 F4

13 cm



NUMEROS EVA 13CM 5 VERMELHO 10X1
 Código: 39068 Fábrica: BRASPAPERS Unidade: PT/10 F1 F4

13 cm



NUMEROS EVA 13CM 6 AMARELO 10X1
 Código: 38862 Fábrica: BRASPAPERS Unidade: PT/10 F1 F4

13 cm



















NUMEROS EVA 13CM 6 AZUL 10X1
 Código: 38873 Fábrica: BRASPAPERS Unidade: PT/10 F1 F4

13 cm



NUMEROS EVA 13CM 6 BRANCO 10X1
 Código: 38852 Fábrica: BRASPAPERS Unidade: PT/10 F1 F4

 <p>NUMEROS EVA 13CM 6 PRETO 10X1 Código: 39089 Fábrica: BRASILPAPERS Unidade: PT/10 F1 F4</p>	 <p>NUMEROS EVA 13CM 6 ROSA 10X1 Código: 39059 Fábrica: BRASILPAPERS Unidade: PT/10 F1 F4</p>	 <p>NUMEROS EVA 13CM 6 SORTIDO 10X1 Código: 39099 Fábrica: BRASILPAPERS Unidade: PT/10 F1 F4</p>	 <p>NUMEROS EVA 13CM 6 VERDE 10X1 Código: 39079 Fábrica: BRASILPAPERS Unidade: PT/10 F1 F4</p>
 <p>NUMEROS EVA 13CM 6 VERMELHO 10X1 Código: 39069 Fábrica: BRASILPAPERS Unidade: PT/10 F1 F4</p>	 <p>NUMEROS EVA 13CM 7 AMARELO 10X1 Código: 38863 Fábrica: BRASILPAPERS Unidade: PT/10 F1 F4</p>	 <p>NUMEROS EVA 13CM 7 AZUL 10X1 Código: 38874 Fábrica: BRASILPAPERS Unidade: PT/10 F1 F4</p>	 <p>NUMEROS EVA 13CM 7 BRANCO 10X1 Código: 38853 Fábrica: BRASILPAPERS Unidade: PT/10 F1 F4</p>
 <p>NUMEROS EVA 13CM 7 PRETO 10X1 Código: 39090 Fábrica: BRASILPAPERS Unidade: PT/10 F1 F4</p>	 <p>NUMEROS EVA 13CM 7 ROSA 10X1 Código: 39060 Fábrica: BRASILPAPERS Unidade: PT/10 F1 F4</p>	 <p>NUMEROS EVA 13CM 7 SORTIDO 10X1 Código: 39100 Fábrica: BRASILPAPERS Unidade: PT/10 F1 F4</p>	 <p>NUMEROS EVA 13CM 7 VERDE 10X1 Código: 39080 Fábrica: BRASILPAPERS Unidade: PT/10 F1 F4</p>
 <p>NUMEROS EVA 13CM 7 VERMELHO 10X1 Código: 39070 Fábrica: BRASILPAPERS Unidade: PT/10 F1 F4</p>	 <p>NUMEROS EVA 13CM 8 AMARELO 10X1 Código: 38864 Fábrica: BRASILPAPERS Unidade: PT/10 F1 F4</p>	 <p>NUMEROS EVA 13CM 8 AZUL 10X1 Código: 38875 Fábrica: BRASILPAPERS Unidade: PT/10 F1 F4</p>	 <p>NUMEROS EVA 13CM 8 BRANCO 10X1 Código: 38854 Fábrica: BRASILPAPERS Unidade: PT/10 F1 F4</p>

13 cm



NUMEROS EVA 13CM 8 PRETO 10X1
 Código: **39091** Fábrica: **BRASILPAPERS** Unidade: **PT/10 F1 F4**

13 cm



NUMEROS EVA 13CM 8 ROSA 10X1
 Código: **39061** Fábrica: **BRASILPAPERS** Unidade: **PT/10 F1 F4**

13 cm



NUMEROS EVA 13CM 8 SORTIDO 10X1
 Código: **39101** Fábrica: **BRASILPAPERS** Unidade: **PT/10 F1 F4**

13 cm



NUMEROS EVA 13CM 8 VERDE 10X1
 Código: **39082** Fábrica: **BRASILPAPERS** Unidade: **PT/10 F1 F4**

13 cm



NUMEROS EVA 13CM 8 VERMELHO 10X1
 Código: **39071** Fábrica: **BRASILPAPERS** Unidade: **PT/10 F1 F4**

13 cm



NUMEROS EVA 13CM 9 AMARELO 10X1
 Código: **38865** Fábrica: **BRASILPAPERS** Unidade: **PT/10 F1 F4**

13 cm



NUMEROS EVA 13CM 9 AZUL 10X1
 Código: **38876** Fábrica: **BRASILPAPERS** Unidade: **PT/10 F1 F4**

13 cm



NUMEROS EVA 13CM 9 BRANCO 10X1
 Código: **38855** Fábrica: **BRASILPAPERS** Unidade: **PT/10 F1 F4**

13 cm



NUMEROS EVA 13CM 9 PRETO 10X1
 Código: **39092** Fábrica: **BRASILPAPERS** Unidade: **PT/10 F1 F4**

13 cm



NUMEROS EVA 13CM 9 ROSA 10X1
 Código: **39062** Fábrica: **BRASILPAPERS** Unidade: **PT/10 F1 F4**

13 cm



NUMEROS EVA 13CM 9 SORTIDO 10X1
 Código: **39102** Fábrica: **BRASILPAPERS** Unidade: **PT/10 F1 F4**

13 cm



NUMEROS EVA 13CM 9 VERDE 10X1
 Código: **39083** Fábrica: **BRASILPAPERS** Unidade: **PT/10 F1 F4**

13 cm



NUMEROS EVA 13CM 9 VERMELHO 10X1
 Código: **39072** Fábrica: **BRASILPAPERS** Unidade: **PT/10 F1 F4**

13 cm



ORGANIZADOR DIAGONAL BLACK PIANO SELADO
 Código: **47594** Fábrica: **MAXCRIL** Unidade: **UN/1 F1 F4**

13 cm



ORGANIZADOR DIAGONAL CINZA SELADO
 Código: **47593** Fábrica: **MAXCRIL** Unidade: **UN/1 F1 F4**

13 cm



ORGANIZADOR DIAGONAL CRISTAL SELADO
 Código: **47173** Fábrica: **MAXCRIL** Unidade: **UN/1 F1 F4**

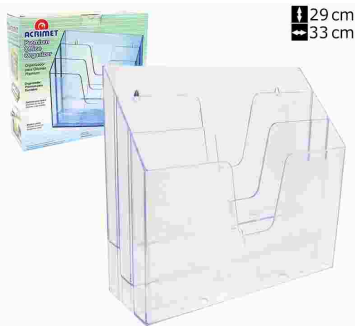

29 cm
33 cm

ORGANIZADOR ESCRITORIO CRISTAL 869CR

Código: 40806
Fábrica: ACRIMET
Unidade: CX/1
F1 F4



ORGANIZADOR MESA ACR PTO PORTA FITA 681

Código: 43220
Fábrica: ACRINIL
Unidade: UN/1
F1 F4



ORGANIZADOR MESA ARAMADO 3COMP QUAD 5122

Código: 44985
Fábrica: BRW
Unidade: UN/1
F1 F4



19,5cm
8,5cm

ORGANIZADOR OBJETO MOD 8,5X8,5CM CRISTAL

Código: 44682
Fábrica: MAXCRIL
Unidade: UN/1
F1 F4



PALITO DENTE EMB IND 25X80

Código: 49697
Fábrica: ESTILO
Unidade: PT/25
F1 F4



PALITO DENTE EMB INDIVIDUAL 2000X1

Código: 48618
Fábrica: BOMPACK
Unidade: CX/2000
F1 F4



PALITO P/PICOLE COLORIDO AMARELO 100X1

Código: 39169
Fábrica: COPLAMIX
Unidade: PT/100
F1 F4



PALITO P/PICOLE COLORIDO AZUL 100X1

Código: 39168
Fábrica: COPLAMIX
Unidade: PT/100
F1 F4



PALITO P/PICOLE COLORIDO VERDE 100X1

Código: 39170
Fábrica: COPLAMIX
Unidade: PT/100
F1 F4



PALITO P/PICOLE COLORIDO VERMELHO 100X1

Código: 39171
Fábrica: COPLAMIX
Unidade: PT/100
F1 F4



PALITO P/PICOLE QUAD 51070 100X1

Código: 27864
Fábrica: THEOTO
Unidade: PT/100
F1 F4



PALITO P/PICOLE QUAD 51070 10000X1

Código: 41176
Fábrica: THEOTO
Unidade: CX/1
F1 F4



PALITO P/PICOLE QUADRADO 100X1

Código: 49695
Fábrica: ESTILO
Unidade: PT/100
F1 F4



PALITO P/PICOLE RED COLORIDO SORT 100X1

Código: 30261
Fábrica: THEOTO
Unidade: PT/100
F1 F4



PALITO P/PICOLE RED 10000X1

Código: 49696
Fábrica: ESTILO
Unidade: CX/1
F1 F4



PALITO P/PICOLE RED 51021 100X1

Código: 41144
Fábrica: THEOTO
Unidade: PT/100
F1 F4



PALITO P/PICOLE RED 51021 10000X1
 Código: 41177 Fábrica: THEOTO Unidade: CX/1
 F1 F4



PALITO P/PICOLE 1000X1
 Código: 20231 Fábrica: PINHEIRO Unidade: PT/1000
 F1 F4



PALITO P/SORVETE 100X1
 Código: 42269 Fábrica: ESTILO Unidade: PT/100
 F1 F4



PALITO RED ABAIXADOR LINGUA 100X1
 Código: 47881 Fábrica: THEOTO Unidade: PT/100
 F1 F4



PANFLETO ALUGA-SE 50X1
 Código: 11440 Fábrica: QDAL Unidade: PT/50
 F1 F4



PANFLETO EXTINTOR DE INCENDIO 50X1
 Código: 33344 Fábrica: QDAL Unidade: PT/50
 F4



PANFLETO NAO VENDEMOS FIADO 50X1
 Código: 31063 Fábrica: QDAL Unidade: PT/50
 F4



PANFLETO USO OBRIGATORIO DE MASCARA 50X1
 Código: 38996 Fábrica: QDAL Unidade: PT/50
 F4



PANFLETO VENDE-SE 50X1
 Código: 11439 Fábrica: QDAL Unidade: PT/50
 F1 F4



PAPEL ACETATO A3 TRANSP 10UN
 Código: 50169 Fábrica: MP Unidade: PT/10
 F1 F4



PAPEL ALMACO C/ PAUTA 100X1
 Código: 36680 Fábrica: MAXIMA Unidade: PT/100
 F1 F4

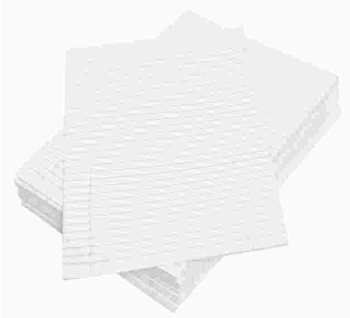

PAPEL ALMACO C/ PAUTA 400X1
 Código: 6427 Fábrica: MAXIMA/PGBRA Unidade: PT/400
 F1 F4

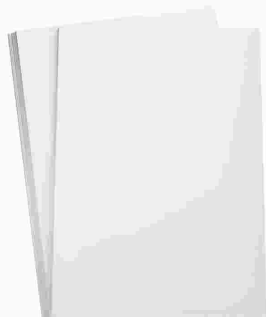

PAPEL ALMACO S/ PAUTA 100X1
 Código: 20378 Fábrica: MAXIMA Unidade: PT/100
 F1 F4

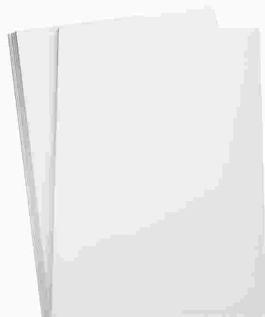

PAPEL ALMACO S/ PAUTA 400X1
 Código: 36679 Fábrica: MAXIMA/PGBRA Unidade: PT/400
 F1 F4



PAPEL ANTILOPE A4 180GR BRANCO 50X1
 Código: 45587 Fábrica: BRATA/OFFPAP Unidade: PT/50
 F1 F4

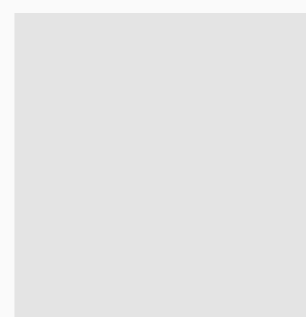

PAPEL A3 60 KG 180 GRS BRANCO 50X1
 Código: 37046 Fábrica: MINASPEL Unidade: PT/50
 F1 F4

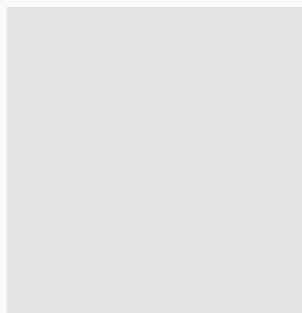

PAPÉL A3 75GRS BRANCO 100X1
 Código: 37074 Fábrica: MILPEL/MINAS Unidade: PT/100
 F1 F4

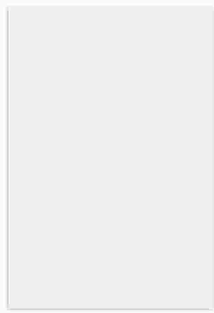

PAPÉL A3 75GRS BRANCO 500X1
 Código: 46994 Fábrica: MILPEL Unidade: PT/1
 F1 F4

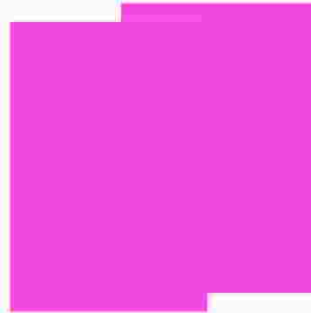

PAPÉL A4 70GR CREME 210X297MM 100X1
 Código: 42918 Fábrica: NEEDS Unidade: PT/1
 F1 F4



PAPÉL A4 75GR AMARELO 210X297MM 100X1
 Código: 9506 Fábrica: MILPEL Unidade: PT/1
 F1 F4

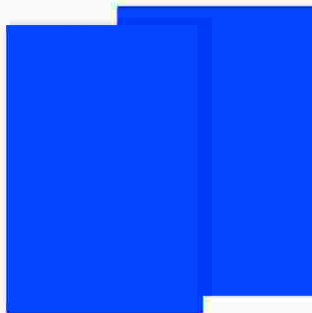

PAPÉL A4 75GR AZUL 210X297MM 100X1
 Código: 9505 Fábrica: MILPEL Unidade: PT/1
 F1 F4

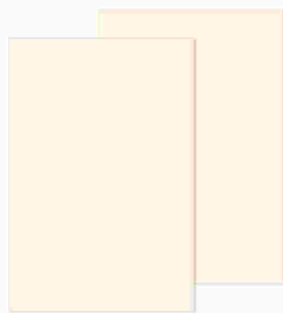

PAPÉL A4 75GR CREME 210X297MM 100X1
 Código: 46409 Fábrica: MINASPEL Unidade: PT/100
 F1 F4



PAPÉL A4 75GR LARANJA 210X297MM 100X1
 Código: 46262 Fábrica: MINASPEL Unidade: PT/100
 F1 F4

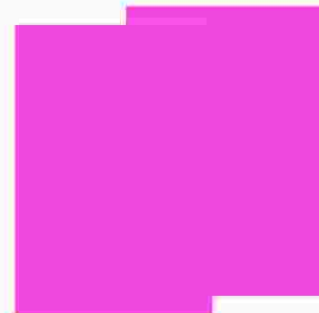

PAPÉL A4 75GR ROSA 210X297MM 100X1
 Código: 9507 Fábrica: MILPEL Unidade: PT/1
 F1 F4



PAPÉL A4 75GR VERDE 210X297MM 100X1
 Código: 9508 Fábrica: MILPEL Unidade: PT/1
 F1 F4



PAPÉL A4 BCO 210X297MM 500 FLS
 Código: 22253 Fábrica: PAPEX Unidade: PT/500
 F1 F4

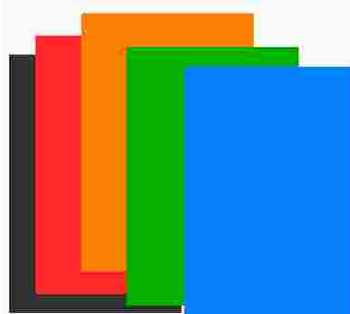

PAPÉL A4 CREATIVE PAPER 48X1
 Código: 7335 Fábrica: MINASPEL Unidade: PT/48
 F1 F4



PAPÉL A4 CRIATIVO COLOR 40X1
 Código: 47716 Fábrica: REIPEL Unidade: PT/40
 F1 F4

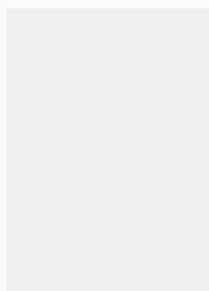

PAPÉL A4 120GR 40KG BRANCO 484 50X1
 Código: 34269 Fábrica: AGAPE Unidade: PT/50
 F1 F4



PAPÉL A4 160GR COUCHE SEMI BRILHO 50X1
 Código: 45992 Fábrica: MASTERPRINT Unidade: PT/50
 F1 F4



PAPÉL A4 180GR MADEIRA BRANCO 50X1
 Código: 45588 Fábrica: OFF PAPER Unidade: PT/50
 F1 F4



PAPÉL A4 180GR MADEIRA PALHA 50X1
 Código: 45887 Fábrica: OFF PAPER Unidade: PT/50
 F1 F4



PAPEL A4 180GR PERSICO BRANCO 50X1

Código: 46046
 Fábrica: USAPEL
 Unidade: PT/50
 F1 F4

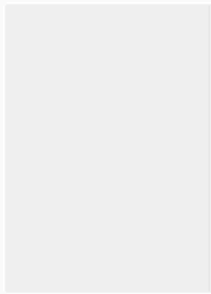

PAPEL A4 180GR 60KG BRANCO 486 50X1

Código: 30962
 Fábrica: MINAS/MILPEL
 Unidade: PT/50
 F1 F4



PAPEL A4 200GR COUCHE FOSCO 100X1

Código: 49064
 Fábrica: MASTERPRINT
 Unidade: PT/100
 F1 F4



PAPEL A4 200GR COUCHE IMP LASER 96 50X1

Código: 51061
 Fábrica: MASTERPRINT
 Unidade: PT/50
 F1 F4



PAPEL A4 75GR 8 CORES 210X297MM 45X1

Código: 49278
 Fábrica: MASTERPRINT
 Unidade: PT/1
 F1 F4



PAPEL CAMURCA AMARELO 40X60CM 25X1

Código: 6332
 Fábrica: ART FLOC
 Unidade: PT/25
 F1 F4



PAPEL CAMURCA AZUL CELESTE 40X60CM 25X1

Código: 24958
 Fábrica: ART FLOC
 Unidade: PT/25
 F1 F4



PAPEL CAMURCA AZUL CLARO 40X60CM 25X1

Código: 6327
 Fábrica: ART FLOC
 Unidade: PT/25
 F1 F4



PAPEL CAMURCA AZUL MARINHO 40X60CM 25X1

Código: 6345
 Fábrica: ART FLOC
 Unidade: PT/25
 F1 F4



PAPEL CAMURCA AZUL ROYAL 40X60CM 25X1

Código: 6331
 Fábrica: ART FLOC
 Unidade: PT/25
 F1 F4



PAPEL CAMURCA AZUL TURQUESA 40X60CM 25X1

Código: 19804
 Fábrica: ART FLOC
 Unidade: PT/25
 F1 F4



PAPEL CAMURCA BEGE 40X60CM 25X1

Código: 35865
 Fábrica: ART FLOC
 Unidade: PT/25
 F1 F4



PAPEL CAMURCA BRANCO 40X60CM 25X1

Código: 4052
 Fábrica: ART FLOC
 Unidade: PT/25
 F1 F4



PAPEL CAMURCA CINZA 40X60CM 25X1

Código: 26221
 Fábrica: ART FLOC
 Unidade: PT/25
 F1 F4



PAPEL CAMURCA GRAFITE 40X60CM 25X1

Código: 16444
 Fábrica: ART FLOC
 Unidade: PT/25
 F1 F4



PAPEL CAMURCA LARANJA 40X60CM 25X1

Código: 15594
 Fábrica: ART FLOC
 Unidade: PT/25
 F1 F4



PAPEL CAMURCA LILAS 40X60 25X1

Código: **35863** Fábrica: **ART FLOC** Unidade: **PT/25**
F1 F4



PAPEL CAMURCA MARROM 40X60CM 25X1

Código: **16445** Fábrica: **ART FLOC** Unidade: **PT/25**
F1 F4



PAPEL CAMURCA PINK 40X60CM 25X1

Código: **16446** Fábrica: **ART FLOC** Unidade: **PT/25**
F1 F4

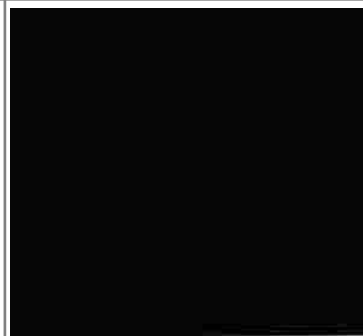

PAPEL CAMURCA PRETO 40X60CM 25X1

Código: **6333** Fábrica: **ART FLOC** Unidade: **PT/25**
F1 F4



PAPEL CAMURCA ROSA 40X60CM 25X1

Código: **15596** Fábrica: **ART FLOC** Unidade: **PT/25**
F1 F4



PAPEL CAMURCA SALMAO 40X60CM 25X1

Código: **6334** Fábrica: **ART FLOC** Unidade: **PT/25**
F1 F4

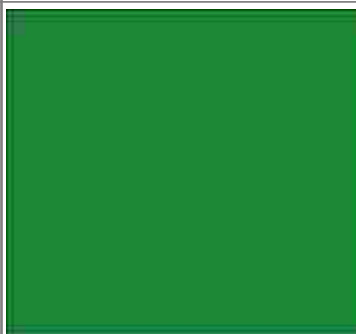

PAPEL CAMURCA VERDE BANDEIR 40X60CM 25X1

Código: **6326** Fábrica: **ART FLOC** Unidade: **PT/25**
F1 F4



PAPEL CAMURCA VERDE MUSGO 40X60CM 25X1

Código: **16447** Fábrica: **ART FLOC** Unidade: **PT/25**
F1 F4



PAPEL CAMURCA VERMELHO 40X60CM 25X1

Código: **6329** Fábrica: **ART FLOC** Unidade: **PT/25**
F1 F4



PAPEL CAMURCA VINHO 40X60CM 25X1

Código: **26224** Fábrica: **ART FLOC** Unidade: **PT/25**
F1 F4



PAPEL CAMURCA VIOLETA 40X60CM 25X1

Código: **35864** Fábrica: **ART FLOC** Unidade: **PT/25**
F1 F4

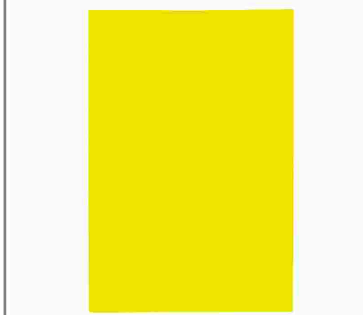

PAPEL CARTAO A4 AMARELO 50X1

Código: **48884** Fábrica: **BRASILPAPERS** Unidade: **PT/50**
F1 F4

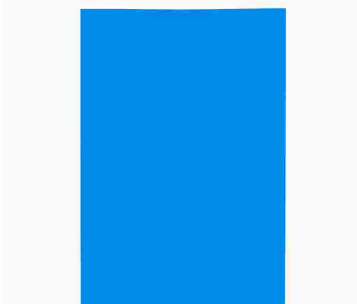

PAPEL CARTAO A4 AZUL 50X1

Código: **48885** Fábrica: **BRASILPAPERS** Unidade: **PT/50**
F1 F4

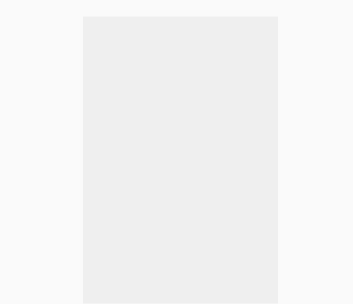

PAPEL CARTAO A4 BRANCO 50X1

Código: **50782** Fábrica: **MINASPEL** Unidade: **PT/50**
F1 F4

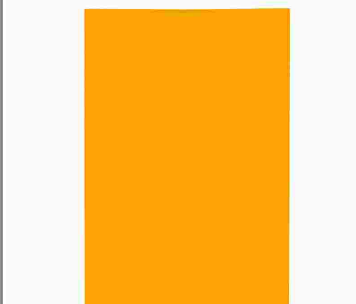

PAPEL CARTAO A4 LARANJA 50X1

Código: **48888** Fábrica: **BRASILPAPERS** Unidade: **PT/50**
F1 F4

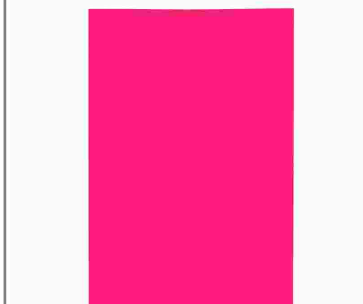

PAPEL CARTAO A4 PINK 50X1

Código: **48889** Fábrica: **BRASILPAPERS** Unidade: **PT/50**
F1 F4

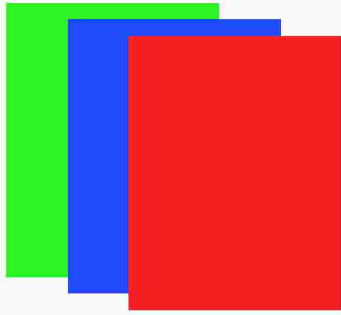

PAPEL CARTAO A4 SORT 50X1

Código: 30104
 Fábrica: MINASPEL
 Unidade: PT/50
 F1 F4



PAPEL CARTAO A4 VERDE 50X1

Código: 48887
 Fábrica: BRASILPAPERS
 Unidade: PT/50
 F1 F4



PAPEL CARTAO A4 VERMELHO 50X1

Código: 48886
 Fábrica: BRASILPAPERS
 Unidade: PT/50
 F1 F4



PAPEL CARTAO BRILHO 45X65CM AMARELO 20X1

Código: 26364
 Fábrica: MINASPEL/MIL
 Unidade: PT/20
 F1 F4

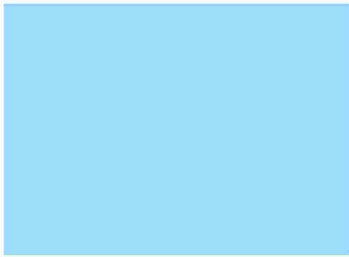

PAPEL CARTAO BRILHO 45X65CM AZUL BB 20X1

Código: 45219
 Fábrica: MINASPEL
 Unidade: PT/20
 F1 F4



PAPEL CARTAO BRILHO 45X65CM AZUL CL 20X1

Código: 26363
 Fábrica: MINASPEL
 Unidade: PT/20
 F1 F4



PAPEL CARTAO BRILHO 45X65CM AZUL ES 20X1

Código: 26365
 Fábrica: MINASPEL
 Unidade: PT/20
 F1 F4



PAPEL CARTAO BRILHO 45X65CM AZUL RO 20X1

Código: 33428
 Fábrica: MINASPEL
 Unidade: PT/20
 F1 F4

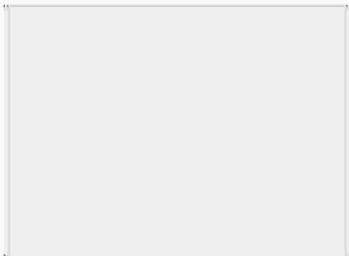

PAPEL CARTAO BRILHO 45X65CM BRANCO 20X1

Código: 26366
 Fábrica: MINASPEL
 Unidade: PT/20
 F1 F4



PAPEL CARTAO BRILHO 45X65CM LARANJA 20X1

Código: 26367
 Fábrica: MINASPEL
 Unidade: PT/20
 F1 F4



PAPEL CARTAO BRILHO 45X65CM PRATA 20X1

Código: 29043
 Fábrica: LB PAPER
 Unidade: PT/20
 F1 F4



PAPEL CARTAO BRILHO 45X65CM PRETO 20X1

Código: 26368
 Fábrica: MINASPEL
 Unidade: PT/20
 F1 F4



PAPEL CARTAO BRILHO 45X65CM ROSA 20X1

Código: 26369
 Fábrica: MINASPEL
 Unidade: PT/20
 F1 F4



PAPEL CARTAO BRILHO 45X65CM SORTIDO 20X1

Código: 29042
 Fábrica: LB PAPER
 Unidade: PT/20
 F1 F4



PAPEL CARTAO BRILHO 45X65CM VERDE B 20X1

Código: 26370
 Fábrica: MINASPEL
 Unidade: PT/20
 F1 F4



PAPEL CARTAO BRILHO 45X65CM VERDE C 20X1

Código: 26371
 Fábrica: MINASPEL
 Unidade: PT/20
 F1 F4



PAPEL CARTAO BRILHO 45X65CM VERMELH 20X1
 Código: 26362 Fábrica: MINASPEL Unidade: PT/20
 F1 F4



PAPEL CARTAO FOSCO 45X65CM AMARELO 20X1
 Código: 4051 Fábrica: MINASPEL Unidade: PT/20
 F1 F4



PAPEL CARTAO FOSCO 45X65CM AZUL CLA 20X1
 Código: 8092 Fábrica: MINASPEL Unidade: PT/20
 F1 F4



PAPEL CARTAO FOSCO 45X65CM AZUL ESC 20X1
 Código: 11242 Fábrica: MINASPEL Unidade: PT/20
 F1 F4



PAPEL CARTAO FOSCO 45X65CM AZUL ROY 20X1
 Código: 33176 Fábrica: MINASPEL Unidade: PT/20
 F1 F4



PAPEL CARTAO FOSCO 45X65CM AZUL 20X1
 Código: 47095 Fábrica: MINASPEL Unidade: PT/20
 F1 F4

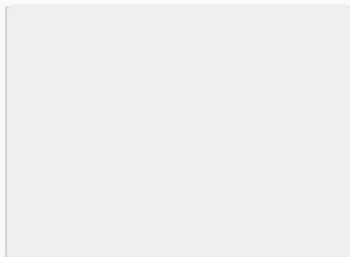

PAPEL CARTAO FOSCO 45X65CM BRANCO 20X1
 Código: 8094 Fábrica: MINASPEL Unidade: PT/20
 F1 F4



PAPEL CARTAO FOSCO 45X65CM CREME 20X1
 Código: 48261 Fábrica: MINASPEL Unidade: PT/20
 F1 F4



PAPEL CARTAO FOSCO 45X65CM LARANJA 20X1
 Código: 10180 Fábrica: MINASPEL Unidade: PT/20
 F1 F4



PAPEL CARTAO FOSCO 45X65CM LILAS 20X1
 Código: 36704 Fábrica: MINASPEL Unidade: PT/20
 F1 F4



PAPEL CARTAO FOSCO 45X65CM MARRON 20X1
 Código: 50672 Fábrica: MINASPEL Unidade: PT/20
 F1 F4

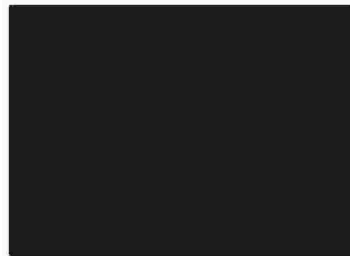

PAPEL CARTAO FOSCO 45X65CM PRETO 20X1
 Código: 8097 Fábrica: MINASPEL Unidade: PT/20
 F1 F4



PAPEL CARTAO FOSCO 45X65CM ROSA PIN 20X1
 Código: 33352 Fábrica: MINASPEL Unidade: PT/20
 F1 F4



PAPEL CARTAO FOSCO 45X65CM ROSA 20X1
 Código: 8096 Fábrica: MINASPEL Unidade: PT/20
 F1 F4



PAPEL CARTAO FOSCO 45X65CM ROXO 20X1
 Código: 42346 Fábrica: MINASPEL Unidade: PT/20
 F1 F4



PAPEL CARTAO FOSCO 45X65CM VERDE BD 20X1
 Código: 8093 Fábrica: MINASPEL Unidade: PT/20
 F1 F4



PAPEL CARTAO FOSCO 45X65CM VERDE CL 20X1
 Código: 19268 Fábrica: MINASPEL Unidade: PT/20
 F1 F4



PAPEL CARTAO FOSCO 45X65CM VERDE LI 20X1
 Código: 47246 Fábrica: MINASPEL Unidade: PT/20
 F1 F4



PAPEL CARTAO FOSCO 45X65CM VERMELHO 20X1
 Código: 8095 Fábrica: MINASPEL Unidade: PT/20
 F1 F4



PAPEL CASCA OVO A4 90GR BRANCO 100X1
 Código: 51022 Fábrica: FILIPAPER Unidade: PT/100
 F1 F4

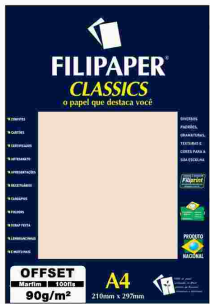

PAPEL CASCA OVO A4 90GR MARFIM 100X1
 Código: 51021 Fábrica: FILIPAPER Unidade: PT/100
 F1 F4



PAPEL CASCA OVO A4 180GR BRANCO 50X1
 Código: 48936 Fábrica: MASTERPRINT Unidade: PT/50
 F1 F4



PAPEL CELOFANE 60X90CM AMARELO 50X1
 Código: 9921 Fábrica: COPLAMIX Unidade: PT/50
 F1 F4



PAPEL CELOFANE 60X90CM AZUL 50X1
 Código: 4049 Fábrica: COPLAMIX Unidade: PT/50
 F1 F4



PAPEL CELOFANE 60X90CM INCOLOR 50X1
 Código: 2568 Fábrica: COPLAMIX Unidade: PT/50
 F1 F4



PAPEL CELOFANE 60X90CM VERMELHO 50X1
 Código: 9920 Fábrica: COPLAMIX Unidade: PT/50
 F1 F4



PAPEL CELOFANE 69X89CM PRETO 50X1
 Código: 28648 Fábrica: EMBALE Unidade: PT/50
 F1 F4



PAPEL CELOFANE 69X89CM MARROM 50X1
 Código: 28650 Fábrica: EMBALE Unidade: PT/50
 F1 F4



PAPEL CELOFANE 69X89CM ROXO 50X1
 Código: 28647 Fábrica: EMBALE Unidade: PT/50
 F1 F4

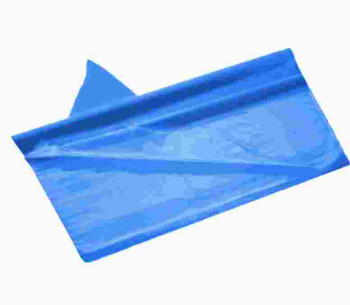

PAPEL CELOFANE 70X90CM AMARELO 50X1
 Código: 49680 Fábrica: GALA Unidade: PT/50
 F1 F4



PAPEL CELOFANE 70X90CM AZUL 50X1
 Código: 49679 Fábrica: GALA Unidade: PT/50
 F1 F4

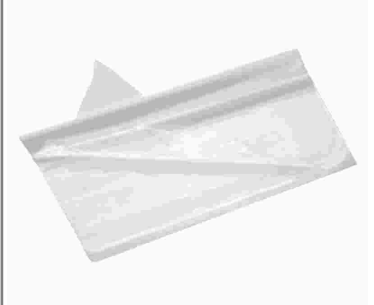

PAPEL CELOFANE 70X90CM INCOLOR 50X1
 Código: 49678 Fábrica: GALA Unidade: PT/50
 F1 F4

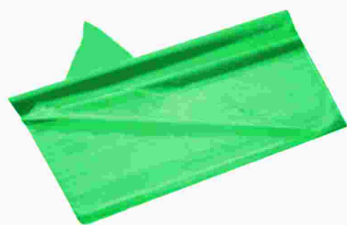

PAPEL CELOFANE 70X90CM VERDE BAND 50X1

Código: **9922** Fábrica: **GALA** Unidade: **PT/50**
F1 F4

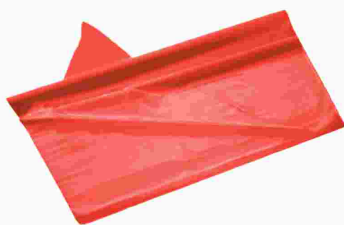

PAPEL CELOFANE 70X90CM VERMELHO 50X1

Código: **49681** Fábrica: **GALA** Unidade: **PT/50**
F1 F4



PAPEL COLORSET A4 AMARELO 50X1

Código: **15071** Fábrica: **AGAPE/MINASP** Unidade: **PT/50**
F1 F4



PAPEL COLORSET A4 AZUL CLARO 50X1

Código: **49390** Fábrica: **AGAPE** Unidade: **PT/50**
F1 F4



PAPEL COLORSET A4 AZUL ESCURO 50X1

Código: **30794** Fábrica: **AGAPE** Unidade: **PT/50**
F1 F4

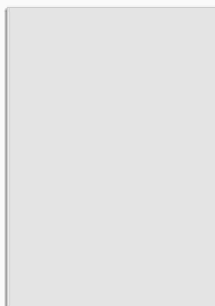

PAPEL COLORSET A4 BRANCO 50X1

Código: **30923** Fábrica: **AGAPE** Unidade: **PT/50**
F1 F4



PAPEL COLORSET A4 LARANJA 50X1

Código: **44488** Fábrica: **AGAPE** Unidade: **PT/50**
F1 F4

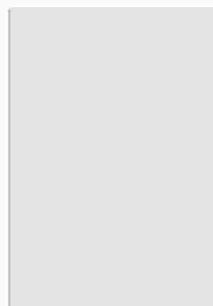

PAPEL COLORSET A4 LILAS 50X1

Código: **48087** Fábrica: **AGAPE** Unidade: **PT/50**
F1 F4



PAPEL COLORSET A4 MARROM 50X1

Código: **35574** Fábrica: **AGAPE** Unidade: **PT/1**
F1 F4

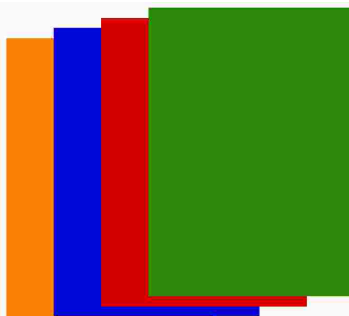

PAPEL COLORSET A4 MULTICOR 24X1

Código: **34264** Fábrica: **ASSETTE** Unidade: **PT/24**
F1 F4

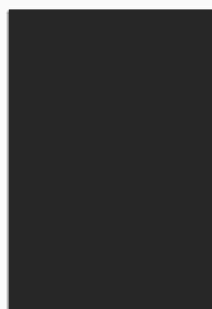

PAPEL COLORSET A4 PRETO 50X1

Código: **35575** Fábrica: **AGAPE/MINASP** Unidade: **PT/1**
F1 F4



PAPEL COLORSET A4 ROSA PINK 50X1

Código: **49391** Fábrica: **AGAPE** Unidade: **PT/50**
F1 F4



PAPEL COLORSET A4 ROSA 50X1

Código: **35896** Fábrica: **AGAPE** Unidade: **PT/50**
F1 F4



PAPEL COLORSET A4 ROXO 50X1

Código: **49392** Fábrica: **AGAPE** Unidade: **PT/50**
F1 F4

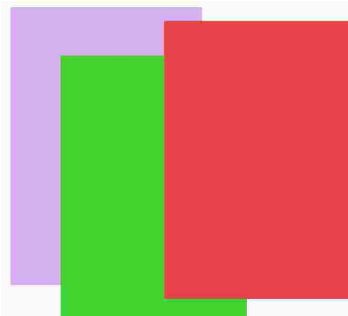

PAPEL COLORSET A4 SORT 50X1

Código: **35897** Fábrica: **AGAPE/BRASIL** Unidade: **PT/50**
F1 F4



PAPEL COLORSET A4 VERDE BAND 50X1

Código: **30793** Fábrica: **AGAPE** Unidade: **PT/50**
F1 F4

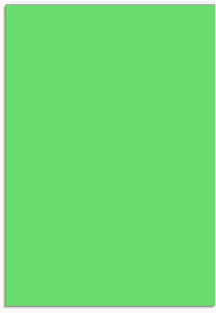

PAPEL COLORSET A4 VERDE CLA 50X1
 Código: 34592 Fábrica: MINASPEL Unidade: PT/50
 F1 F4

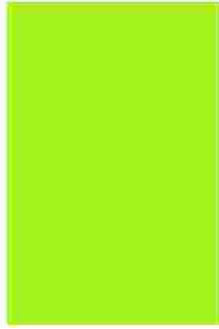

PAPEL COLORSET A4 VERDE LIMAO 50X1
 Código: 33079 Fábrica: AGAPE Unidade: PT/50
 F1 F4



PAPEL COLORSET A4 VERMELHO 50X1
 Código: 30795 Fábrica: AGAPE Unidade: PT/50
 F1 F4



PAPEL COLORSET UN
 Código: 42274 Fábrica: MINASPEL Unidade: UN/1
 F1 F4



PAPEL COLORSET 45X65CM AZUL ROYAL 20X1
 Código: 30575 Fábrica: MINASPEL Unidade: PT/20
 F1 F4



PAPEL COLORSET 45X65CM CARAMELO 20X1
 Código: 46989 Fábrica: MINASPEL Unidade: PT/20
 F1 F4



PAPEL COLORSET 45X65CM OCRE 20X1
 Código: 46988 Fábrica: MINASPEL Unidade: PT/20
 F1 F4



PAPEL COLORSET 45X65CM ROSA FLUOR 20X1
 Código: 33177 Fábrica: MINASPEL Unidade: PT/20
 F1 F4



PAPEL COLORSET 45X65CM ROXO 20X1
 Código: 21635 Fábrica: MINASPEL/MIL Unidade: PT/20
 F1 F4



PAPEL COLORSET 45X65CM SALMAO 20X1
 Código: 46990 Fábrica: MINASPEL Unidade: PT/20
 F1 F4

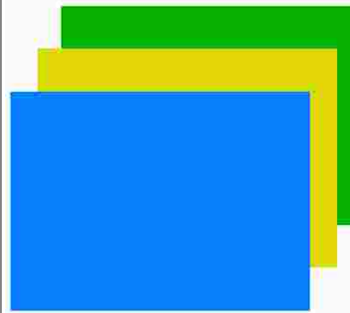

PAPEL COLORSET 45X65CM SORTIDO 20X1
 Código: 28718 Fábrica: LB PAPER Unidade: PT/20
 F1 F4



PAPEL COLORSET 45X66CM AMARELO 20X1
 Código: 10114 Fábrica: REIPEL/MINAS Unidade: PT/20
 F1 F4

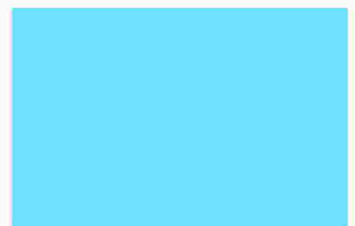

PAPEL COLORSET 45X66CM AZUL CLARO 20X1
 Código: 19792 Fábrica: REIPEL/MINAS Unidade: PT/20
 F1 F4



PAPEL COLORSET 45X66CM AZUL ESCURO 20X1
 Código: 10113 Fábrica: REIPEL/MINAS Unidade: PT/20
 F1 F4

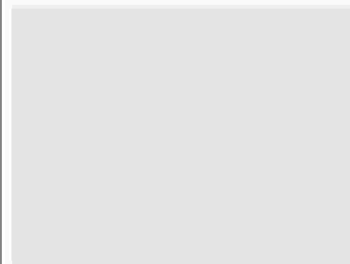

PAPEL COLORSET 45X66CM BRANCO 20X1
 Código: 10116 Fábrica: REIPEL/MINAS Unidade: PT/20
 F1 F4



PAPEL COLORSET 45X66CM CHAMPAGNE 20X1
 Código: 47721 Fábrica: REIPEL Unidade: PT/20
 F1 F4



PAPEL COLORSET 45X66CM LARANJA 20X1
 Código: 10112 Fábrica: REIPEL/MINAS Unidade: PT/20
 F1 F4



PAPEL COLORSET 45X66CM MARROM 20X1
 Código: 10111 Fábrica: REIPEL/MINAS Unidade: PT/20
 F1 F4



PAPEL COLORSET 45X66CM PRETO 20X1
 Código: 15112 Fábrica: REIPEL/MINAS Unidade: PT/20
 F1 F4



PAPEL COLORSET 45X66CM ROSA PINK 20X1
 Código: 29833 Fábrica: REIPEL/MINAS Unidade: PT/20
 F1 F4



PAPEL COLORSET 45X66CM ROSA 20X1
 Código: 15113 Fábrica: REIPEL/MINAS Unidade: PT/20
 F1 F4



PAPEL COLORSET 45X66CM VERDE BAND 20X1
 Código: 4260 Fábrica: REIPEL/MINAS Unidade: PT/20
 F1 F4



PAPEL COLORSET 45X66CM VERDE CLARO 20X1
 Código: 19549 Fábrica: REIPEL/MINAS Unidade: PT/20
 F1 F4



PAPEL COLORSET 45X66CM VERMELHO 20X1
 Código: 10115 Fábrica: REIPEL/MINAS Unidade: PT/20
 F1 F4



PAPEL COLORSET 45X66CM VIOLETA 20X1
 Código: 47722 Fábrica: REIPEL Unidade: PT/20
 F1 F4



PAPEL COLORSET 48X66CM ESTRELA VERM 20X1
 Código: 48371 Fábrica: VMP Unidade: PT/20
 F1 F4

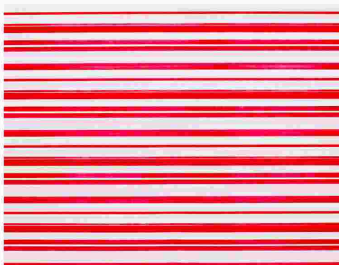

PAPEL COLORSET 48X66CM LISTRAD VERM 20X1
 Código: 48376 Fábrica: VMP Unidade: PT/20
 F1 F4

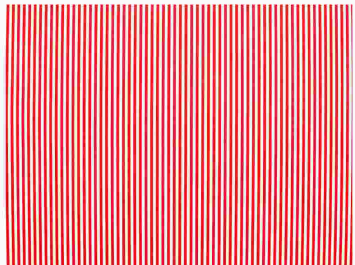

PAPEL COLORSET 48X66CM LISTRAS VERM 20X1
 Código: 48375 Fábrica: VMP Unidade: PT/20
 F1 F4

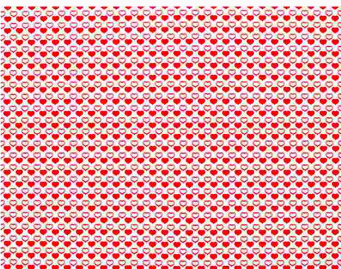

PAPEL COLORSET 48X66CM 2 CORACOES 20X1
 Código: 48372 Fábrica: VMP Unidade: PT/20
 F1 F4



PAPEL COLORSET 45X66CM LILAS 20X1
 Código: 16640 Fábrica: REIPEL/MINAS Unidade: PT/20
 F1 F4

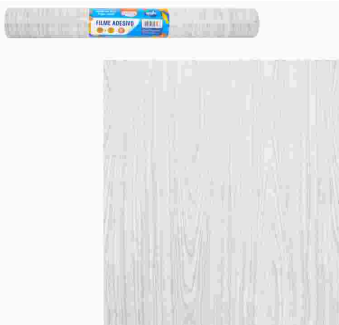

PAPEL CONTACT 45CMX10M ADES MADEIRA CINZ
 Código: 48312 Fábrica: BRW Unidade: RL/1
 F1 F4



PAPEL CONTACT 45CMX10MT ADESIVO BRANCO
 Código: 48358 Fábrica: LEOTACK Unidade: RL/10
 F1 F4



PAPEL CONTACT 45CMX10MT ADESIVO PRETO
 Código: 48359 Fábrica: LEOTACK Unidade: RL/10
 F1 F4



PAPEL CONTACT 45CMX10MT ADESIVO PRETO 17
 Código: 46147 Fábrica: WIN PAPER Unidade: RL/1
 F1 F4



PAPEL CONTACT 45CMX10MT ADESIVO VERDE 10
 Código: 45949 Fábrica: WIN PAPER Unidade: RL/1
 F1 F4

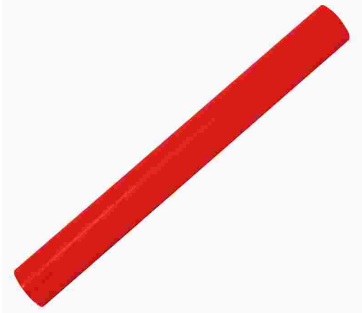

PAPEL CONTACT 45CMX10MT ADESIVO VERMEL 9
 Código: 45950 Fábrica: WIN PAPER Unidade: RL/1
 F1 F4

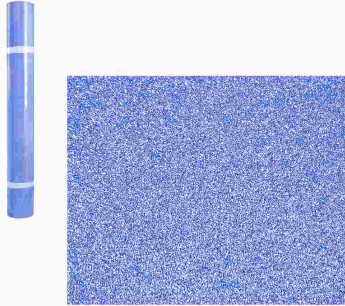

PAPEL CONTACT 45CMX10MT GLITER AZUL 1703
 Código: 42656 Fábrica: DAC Unidade: RL/1
 F1 F4

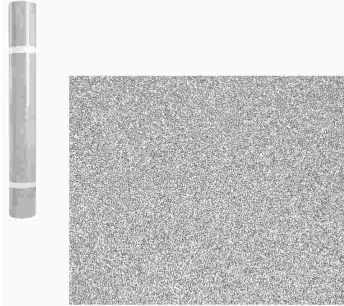

PAPEL CONTACT 45CMX10MT GLITER PRAT 1703
 Código: 37948 Fábrica: DAC Unidade: RL/1
 F1 F4

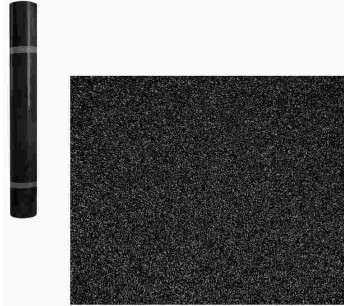

PAPEL CONTACT 45CMX10MT GLITER PRET 1703
 Código: 42658 Fábrica: DAC Unidade: RL/1
 F1 F4

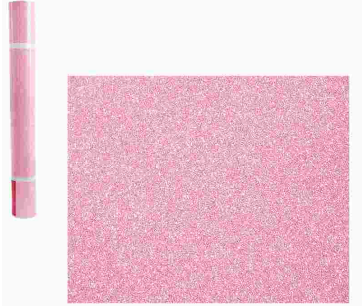

PAPEL CONTACT 45CMX10MT GLITER ROSA 1703
 Código: 38030 Fábrica: DAC Unidade: RL/1
 F1 F4



PAPEL CONTACT 45CMX10MT GLITER VERM 1703
 Código: 42657 Fábrica: DAC Unidade: RL/1
 F1 F4



PAPEL CONTACT 45CMX10MT HOL ESTRELA 7435
 Código: 46410 Fábrica: KAZ Unidade: RL/1
 F1 F4



PAPEL CONTACT 45CMX10MT IMBUIA 911
 Código: 46411 Fábrica: KAZ Unidade: RL/1
 F1 F4



PAPEL CONTACT 45CMX10MT MADEIRA TABACO
 Código: 32790 Fábrica: VMP Unidade: RL/1
 F1 F4

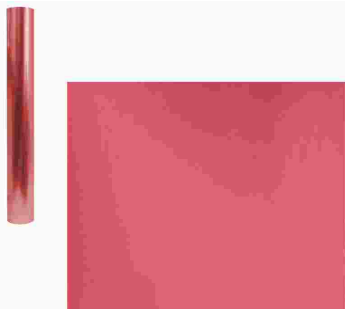

PAPEL CONTACT 45CMX10MT METAL ROSA 1751
 Código: 37944 Fábrica: DAC Unidade: RL/1
 F1 F4

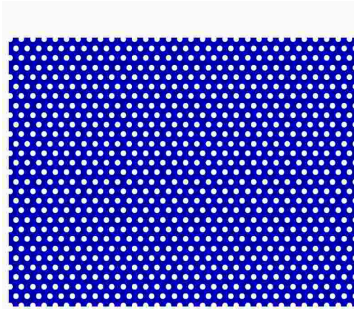

PAPEL CONTACT 45CMX10MT POA AZUL
 Código: 34388 Fábrica: VMP Unidade: RL/1
 F1 F4



PAPEL CONTACT 45CMX10MT PVC AZUL 1702
 Código: 37937 Fábrica: DAC Unidade: RL/1
 F1 F4

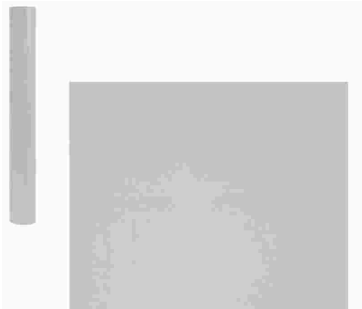

PAPEL CONTACT 45CMX10MT PVC BRANCO 1702
 Código: 37939 Fábrica: DAC Unidade: RL/1
 F1 F4



PAPEL CONTACT 45CMX10MT PVC PRETO 1702
 Código: 37942 Fábrica: DAC Unidade: RL/1 F1 F4

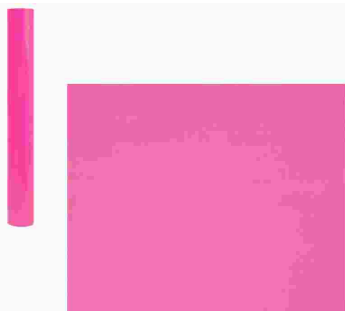

PAPEL CONTACT 45CMX10MT PVC ROSA 1702
 Código: 37941 Fábrica: DAC Unidade: RL/1 F1 F4

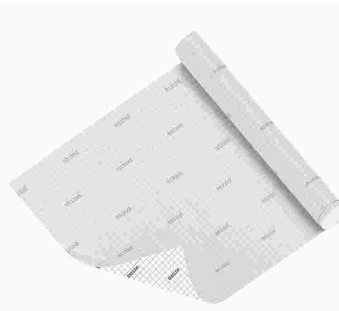

PAPEL CONTACT 45CMX10MT PVC TRANSP
 Código: 50376 Fábrica: BAZZE Unidade: RL/1 F1 F4

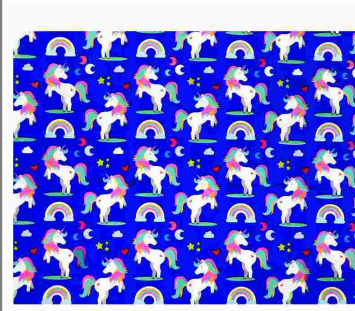

PAPEL CONTACT 45CMX10MT UNICORNIO
 Código: 34389 Fábrica: VMP Unidade: RL/1 F1 F4

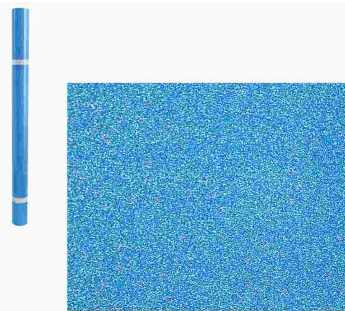

PAPEL CONTACT 45CMX2MT GLITER AZUL 1711
 Código: 37950 Fábrica: DAC Unidade: RL/1 F1 F4



PAPEL CONTACT 45CMX2MT GLITER PRAT 1711
 Código: 37954 Fábrica: DAC Unidade: RL/1 F1 F4

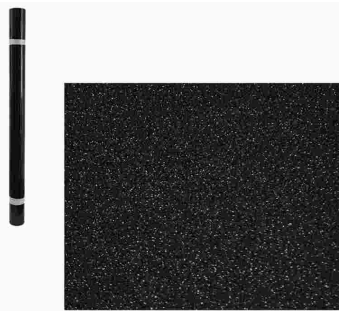

PAPEL CONTACT 45CMX2MT GLITER PRETO 1711
 Código: 37953 Fábrica: DAC Unidade: RL/1 F1 F4

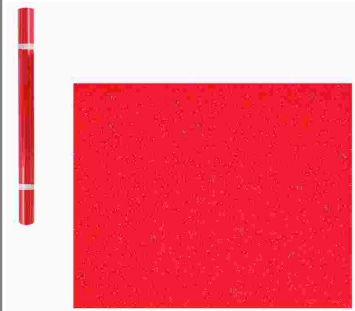

PAPEL CONTACT 45CMX2MT GLITER VERME 1711
 Código: 37955 Fábrica: DAC Unidade: RL/1 F1 F4

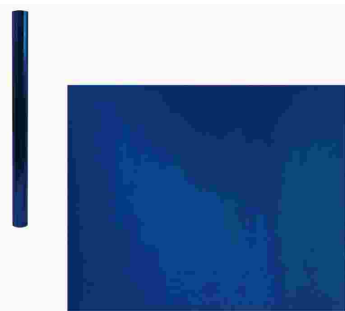

PAPEL CONTACT 45CMX2MT METAL AZUL 1750
 Código: 37963 Fábrica: DAC Unidade: RL/1 F1 F4

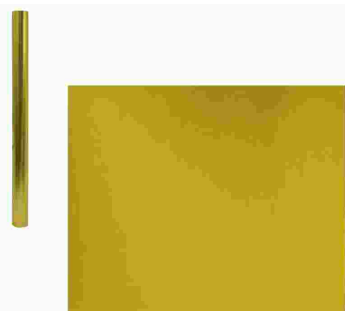

PAPEL CONTACT 45CMX2MT METAL DOURAD 1750
 Código: 37961 Fábrica: DAC Unidade: RL/1 F1 F4



PAPEL CONTACT 45CMX2MT METAL PRATA 1750
 Código: 37962 Fábrica: DAC Unidade: RL/1 F1 F4

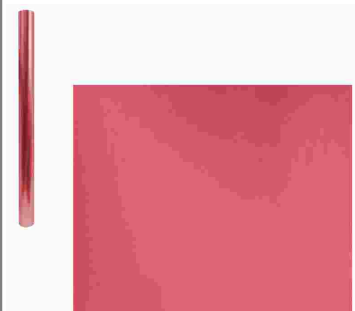

PAPEL CONTACT 45CMX2MT METAL ROSA 1750
 Código: 37958 Fábrica: DAC Unidade: RL/1 F1 F4

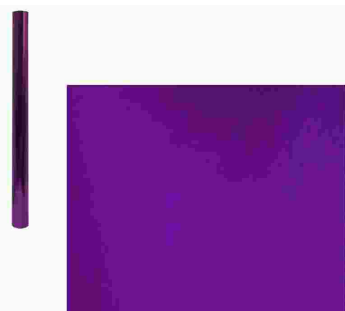

PAPEL CONTACT 45CMX2MT METAL ROXO 1750
 Código: 37959 Fábrica: DAC Unidade: RL/1 F1 F4



PAPEL CONTACT 45CMX2MT PVC AMARELO 1708
 Código: 37966 Fábrica: DAC Unidade: RL/1 F1 F4



PAPEL CONTACT 45CMX2MT PVC AZUL 1708
 Código: 37964 Fábrica: DAC Unidade: RL/1 F1 F4



PAPEL CONTACT 45CMX2MT PVC ROSA 1708
 Código: 37969 Fábrica: DAC Unidade: RL/1 F1 F4



PAPEL CONTACT 45CMX25MT ADESIVO TRANSP
 Código: 46375 Fábrica: LEOTACK Unidade: RL/25 F1 F4



PAPEL CONTACT 45CMX25MT ADESIVO TRANSP
 Código: 3065 Fábrica: DAC/POLIFIX Unidade: RL/25 F1 F4



PAPEL CONTACT 45CMX25MT CRISTAL 80MIC 80
 Código: 46412 Fábrica: KAZ Unidade: RL/1 F1 F4

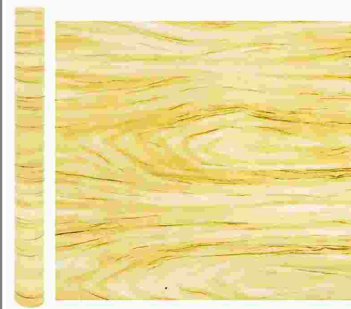

PAPEL CONTACT 45CMX5M DEC AUTOADESIV 001
 Código: 49371 Fábrica: RIOHOME Unidade: RL/1 F1 F4



PAPEL CONTACT 45CMX5M DEC AUTOADESIV 002
 Código: 49370 Fábrica: RIOHOME Unidade: RL/1 F1 F4



PAPEL CONTACT 45CMX5M DEC AUTOADESIV 003
 Código: 49374 Fábrica: RIOHOME Unidade: RL/1 F1 F4

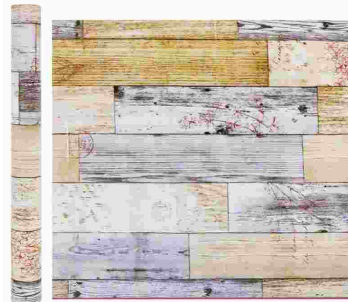

PAPEL CONTACT 45CMX5M DEC AUTOADESIV 004
 Código: 49373 Fábrica: RIOHOME Unidade: RL/1 F1 F4



PAPEL CONTACT 45CMX5M DEC AUTOADESIV 007
 Código: 49369 Fábrica: RIOHOME Unidade: RL/1 F1 F4



PAPEL CONTACT 45CMX5M DEC AUTOADESIV 011
 Código: 49372 Fábrica: RIOHOME Unidade: RL/1 F1 F4



PAPEL CONTACT 45CMX5M DEC AUTOADESIV 014
 Código: 49367 Fábrica: RIOHOME Unidade: RL/1 F1 F4

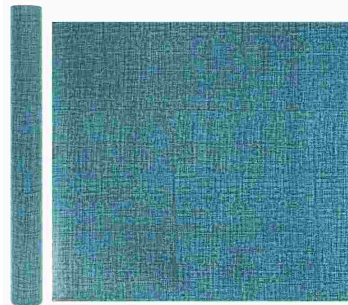

PAPEL CONTACT 45CMX5M DEC AUTOADESIV 015
 Código: 49368 Fábrica: RIOHOME Unidade: RL/1 F1 F4

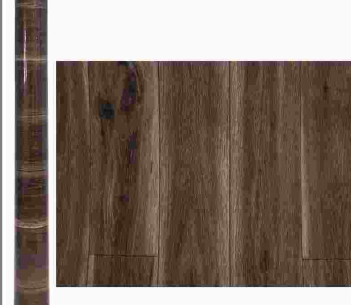

PAPEL CONTACT 45CMX5MT 50062
 Código: 38541 Fábrica: ROCIE Unidade: RL/1 F1 F4



PAPEL COUCHE A4 180GR BRILHO 50X1
 Código: 41369 Fábrica: USAPEL Unidade: PT/50 F1 F4



PAPEL COUCHE A4 180GR GRANITTO NT 50X1
 Código: 41371 Fábrica: USAPEL Unidade: PT/50 F1 F4



PAPEL COUCHE A4 180GR MATTE BRANCO 50X1
 Código: 41370 Fábrica: USAPEL Unidade: PT/50 F1 F4

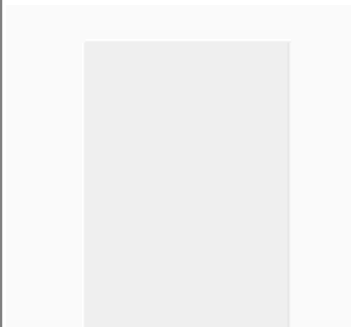

PAPEL COUCHE BRILHO A4 90GR 50X1
 Código: 34267 Fábrica: ASSETE Unidade: PT/50 F1 F4

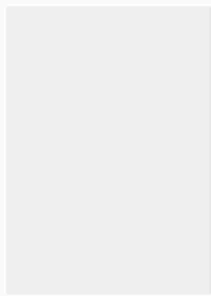

PAPEL COUCHE BRILHO A4 170GR 513 50X1

Código: 34266 Fábrica: MASTERPINT Unidade: PT/50
F1 F4



PAPEL CREPOM DEC CARROS PRETO 10X1

Código: 49597 Fábrica: VMP Unidade: PT/10
F1 F4



PAPEL CREPOM DEC FROZEN ROXO 10X1

Código: 49600 Fábrica: VMP Unidade: PT/10
F1 F4



PAPEL CREPOM DEC MARIE 10X1

Código: 49602 Fábrica: VMP Unidade: PT/10
F1 F4



PAPEL CREPOM DEC MICKEY BRANCO 10X1

Código: 49596 Fábrica: VMP Unidade: PT/10
F1 F4



PAPEL CREPOM DEC MICKEY PRETO 10X1

Código: 49594 Fábrica: VMP Unidade: PT/10
F1 F4



PAPEL CREPOM DEC MINNIE VERMELHO 10X1

Código: 49601 Fábrica: VMP Unidade: PT/10
F1 F4



PAPEL CREPOM DEC TOY STORY AZUL 10X1

Código: 49592 Fábrica: VMP Unidade: PT/10
F1 F4



PAPEL CREPOM DEC TOY STORY CINZA 10X1

Código: 49593 Fábrica: VMP Unidade: PT/10
F1 F4



PAPEL CREPOM FANT ESTRELINHAS OURO 10X1

Código: 49603 Fábrica: VMP Unidade: PT/10
F1 F4



PAPEL CREPOM FANT ESTRELINHAS PRATA 10X1

Código: 49605 Fábrica: VMP Unidade: PT/10
F1 F4



PAPEL CREPOM FANT LISTRAS PRATA 10X1

Código: 49604 Fábrica: VMP Unidade: PT/10
F1 F4



PAPEL CREPOM FANT LISTRAS ROSA 10X1

Código: 49606 Fábrica: VMP Unidade: PT/10
F1 F4



PAPEL CREPOM METAL 48CMX1M AZUL CLA 10X1

Código: 50273 Fábrica: REIPEL Unidade: PT/10
F1 F4



PAPEL CREPOM METAL 48CMX1M VERDE CL 10X1

Código: 50274 Fábrica: REIPEL Unidade: PT/10
F1 F4



PAPEL CREPOM PARAFINADO OURO 10X1

Código: 47707 Fábrica: REIPEL Unidade: PT/10
F1 F4



PAPEL CREPOM PARAFINADO PRATA 10X1

Código: **47708** Fábrica: **REIPEL** Unidade: **PT/10**
F1 F4



PAPEL CREPOM 48CMX2M AMARELO CANARI 10X1

Código: **18854** Fábrica: **REPEL/ARTFLO** Unidade: **PT/10**
F1 F4



PAPEL CREPOM 48CMX2M AMARELO OURO 10X1

Código: **18861** Fábrica: **ART FLOC** Unidade: **PT/10**
F1 F4



PAPEL CREPOM 48CMX2M AMARELO SOL 10X1

Código: **6953** Fábrica: **ART FLOC** Unidade: **PT/10**
F1 F4



PAPEL CREPOM 48CMX2M AZUL CLARO 10X1

Código: **18858** Fábrica: **ARTFLOC/NOVA** Unidade: **PT/10**
F1 F4



PAPEL CREPOM 48CMX2M AZUL ESCURO 10X1

Código: **18857** Fábrica: **NOVAPRINT** Unidade: **PT/10**
F1 F4

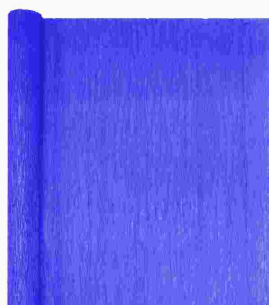

PAPEL CREPOM 48CMX2M AZUL MARINHO 10X1

Código: **33198** Fábrica: **ART FLOC** Unidade: **PT/10**
F1 F4

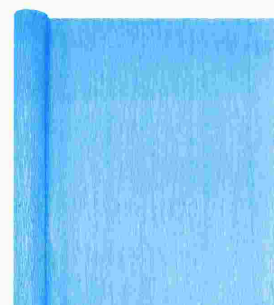

PAPEL CREPOM 48CMX2M AZUL PISCINA 10X1

Código: **18855** Fábrica: **ART FLOC** Unidade: **PT/10**
F1 F4

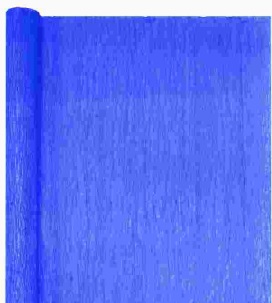

PAPEL CREPOM 48CMX2M AZUL ROYAL 10X1

Código: **18856** Fábrica: **ARTFLOC/REIP** Unidade: **PT/10**
F1 F4

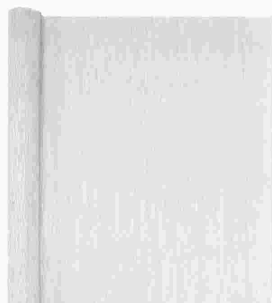

PAPEL CREPOM 48CMX2M BRANCO 10X1

Código: **18865** Fábrica: **REIPEL/ARTFL** Unidade: **PT/10**
F1 F4



PAPEL CREPOM 48CMX2M CHAMPAGNE 10X1

Código: **17902** Fábrica: **ART FLOC** Unidade: **PT/10**
F1 F4



PAPEL CREPOM 48CMX2M CHAMPAGNE 10X1

Código: **46887** Fábrica: **ART FLOC** Unidade: **PT/10**
F1 F4

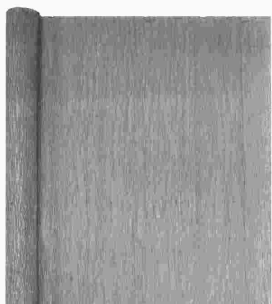

PAPEL CREPOM 48CMX2M CINZA 10X1

Código: **15611** Fábrica: **ART FLOC** Unidade: **PT/10**
F1 F4



PAPEL CREPOM 48CMX2M GELO ACINZENTA 10X1

Código: **6951** Fábrica: **VMP** Unidade: **PT/10**
F1 F4



PAPEL CREPOM 48CMX2M LARANJA 10X1

Código: **18862** Fábrica: **ARTFLOC/NOVA** Unidade: **PT/10**
F1 F4



PAPEL CREPOM 48CMX2M LILAS 10X1

Código: **18869** Fábrica: **REIPEL/ARTFL** Unidade: **PT/10**
F1 F4



PAPEL CREPOM 48CMX2M MARROM 10X1

Código: **15608** Fábrica: **ARTFLOC/NOVA** Unidade: **PT/10**
F1 F4



PAPEL CREPOM 48CMX2M PRETO 10X1

Código: **18864** Fábrica: **ARTFLOC/NOVA** Unidade: **PT/10**
F1 F4



PAPEL CREPOM 48CMX2M ROSA CLARO 10X1

Código: **18851** Fábrica: **ARTFLOC%NOVA** Unidade: **PT/10**
F1 F4



PAPEL CREPOM 48CMX2M ROSA PINK 10X1

Código: **18850** Fábrica: **REIPEL/ARTFL** Unidade: **PT/10**
F1 F4



PAPEL CREPOM 48CMX2M ROSA 10X1

Código: **18852** Fábrica: **ART FLOC** Unidade: **PT/10**
F1 F4

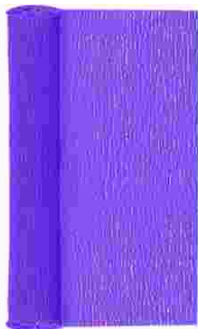

PAPEL CREPOM 48CMX2M ROXO 10X1

Código: **15612** Fábrica: **ARTFLOC/NOVA** Unidade: **PT/10**
F1 F4



PAPEL CREPOM 48CMX2M SALMAO CLARO 10X1

Código: **42595** Fábrica: **ART FLOC** Unidade: **PT/10**
F1 F4



PAPEL CREPOM 48CMX2M SALMAO 10X1

Código: **18853** Fábrica: **ART FLOC** Unidade: **PT/10**
F1 F4



PAPEL CREPOM 48CMX2M SORT 40X1

Código: **41888** Fábrica: **ART FLOC** Unidade: **PT/40**
F1 F4



PAPEL CREPOM 48CMX2M SORTIDO 10X1

Código: **42140** Fábrica: **ART FLOC** Unidade: **PT/10**
F1 F4



PAPEL CREPOM 48CMX2M VERDE BANDEIRA 10X1

Código: **18868** Fábrica: **REIPEL/ARTFL** Unidade: **PT/10**
F1 F4



PAPEL CREPOM 48CMX2M VERDE FOLHA 10X1

Código: **18867** Fábrica: **ARTFLOC/NOVA** Unidade: **PT/10**
F1 F4

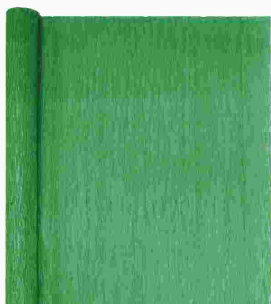

PAPEL CREPOM 48CMX2M VERDE FOSCO 10X1

Código: **42597** Fábrica: **ART FLOC** Unidade: **PT/10**
F1 F4



PAPEL CREPOM 48CMX2M VERDE LIMA 10X1

Código: **6954** Fábrica: **ART FLOC** Unidade: **PT/10**
F1 F4



PAPEL CREPOM 48CMX2M VERDE LIMAO 10X1

Código: **18866** Fábrica: **ART FLOC** Unidade: **PT/10**
F1 F4



PAPEL CREPOM 48CMX2M VERDE MUSGO 10X1

Código: **6960** Fábrica: **ART FLOC** Unidade: **PT/10**
F1 F4

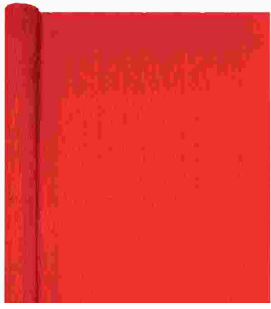

PAPEL CREPOM 48CMX2M VERMELHO 10X1

Código: **18863** Fábrica: **REIPE/ARTFLO** Unidade: **PT/10 F1 F4**



PAPEL CREPOM 48CMX2M VINHO 10X1

Código: **6947** Fábrica: **ART FLOC** Unidade: **PT/10 F1 F4**



PAPEL CREPOM 48CMX2M VIOLETA 10X1

Código: **18859** Fábrica: **ART FLOC** Unidade: **PT/10 F1 F4**

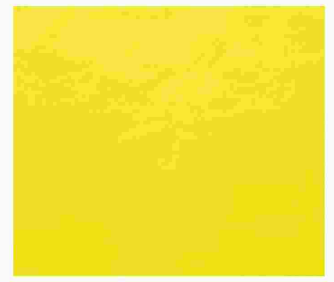

PAPEL FANTAS/DOBR 50X60CM AMARELO 100X1

Código: **15114** Fábrica: **VMP/MILPEL** Unidade: **CE/100 F1 F4**



PAPEL FANTAS/DOBR 50X60CM AZUL CLA 100X1

Código: **10107** Fábrica: **VMP/MILPEL** Unidade: **CE/100 F1 F4**



PAPEL FANTAS/DOBR 50X60CM AZUL ESC 100X1

Código: **46914** Fábrica: **VMP** Unidade: **CE/100 F1 F4**



PAPEL FANTAS/DOBR 50X60CM BRANCO 100X1

Código: **16639** Fábrica: **VMP/MILP** Unidade: **CE/100 F1 F4**



PAPEL FANTAS/DOBR 50X60CM LARANJA 100X1

Código: **10108** Fábrica: **VMP/MILPEL** Unidade: **CE/100 F1 F4**

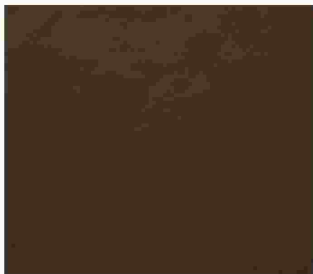

PAPEL FANTAS/DOBR 50X60CM MARROM 100X1

Código: **40755** Fábrica: **VMP/MILPEL** Unidade: **CE/100 F1 F4**



PAPEL FANTAS/DOBR 50X60CM PRETO 100X1

Código: **17058** Fábrica: **VMP** Unidade: **CE/100 F1 F4**



PAPEL FANTAS/DOBR 50X60CM ROSA PIN 100X1

Código: **10109** Fábrica: **VMP/MILPEL** Unidade: **CE/100 F1 F4**



PAPEL FANTAS/DOBR 50X60CM VERDE BD100X1

Código: **15269** Fábrica: **VMP/MILPEL** Unidade: **CE/100 F1 F4**



PAPEL FANTAS/DOBR 50X60CM VERMELHO 100X1

Código: **44193** Fábrica: **VMP/MILPEL** Unidade: **CE/100 F1 F4**

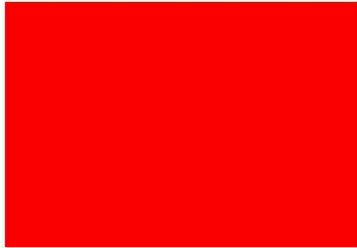

PAPEL FANTASIA 48X60CM 100X1 SORTIDO

Código: **6658** Fábrica: **MILPEL** Unidade: **CE/1 F1 F4**



PAPEL FOTO A3 130GRS ADESIVO 20X1

Código: **45265** Fábrica: **MASTERPRINT** Unidade: **PT/20 F1 F4**

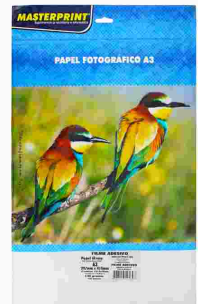

PAPEL FOTO A3 135GRS ADESIVO 10X1

Código: **48908** Fábrica: **MASTERPRINT** Unidade: **PT/20 F1 F4**



PAPEL FOTO A3 180GR 20X1
 Código: 29748 Fábrica: MASTERPRINT Unidade: PT/20 F1 F4

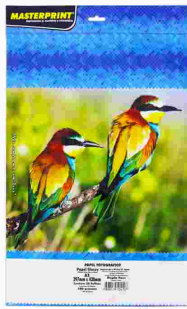

PAPEL FOTO A3 180GRS DUPLA FACE 20X1
 Código: 46068 Fábrica: MASTERPRINT Unidade: PT/20 F1 F4



PAPEL FOTO A4 90GR MATTE FOSCO 100X1
 Código: 45154 Fábrica: MASTERPRINT Unidade: PT/100 F1 F4



PAPEL FOTO A4 115GR ADESIVO 20X1
 Código: 45111 Fábrica: MASTERPRINT Unidade: PT/20 F1 F4

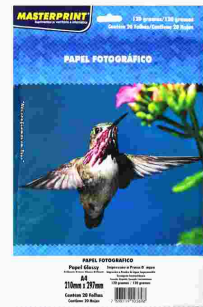

PAPEL FOTO A4 115GR 20X1
 Código: 45266 Fábrica: MASTERPRINT Unidade: PT/50 F1 F4



PAPEL FOTO A4 115GR 50X1
 Código: 45110 Fábrica: MASTERPRINT Unidade: PT/50 F1 F4



PAPEL FOTO A4 130GR ADESIVO 20X1
 Código: 29747 Fábrica: MASTERPRINT Unidade: PT/20 F1 F4



PAPEL FOTO A4 130GR ADESIVO 50X1
 Código: 38238 Fábrica: MASTERPRINT Unidade: PT/50 F1 F4



PAPEL FOTO A4 135GR 50X1
 Código: 45112 Fábrica: MASTERPRINT Unidade: PT/50 F1 F4

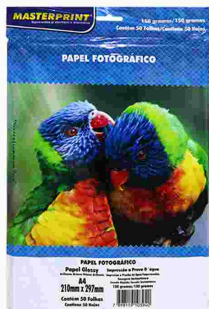

PAPEL FOTO A4 150GR 50X1
 Código: 42234 Fábrica: MASTERPRINT Unidade: PT/50 F1 F4



PAPEL FOTO A4 180GR BRILHOSO 50X1
 Código: 48347 Fábrica: YIN'S PAPER Unidade: PT/50 F1 F4



PAPEL FOTO A4 180GR 50X1
 Código: 37956 Fábrica: MASTERPRINT Unidade: PT/50 F1 F4



PAPEL FOTO 10X15CM 265GRS GLOSSY 20X1
 Código: 50006 Fábrica: MASTERPRINT Unidade: PT/20 F1 F4



PAPEL HIGIENICO 10CMX30M FOLHA DUPL 16X1
 Código: 48510 Fábrica: NOBRE Unidade: PT/1 F1 F4



PAPEL KRAFT A4 240 GRS FILIPAPER 25X1
 Código: 34263 Fábrica: FILIPAPER Unidade: PT/25 F1 F4



PAPEL KRAFT A4 180GR ARTESANATO 50X1
 Código: 45113 Fábrica: MASTERPRINT Unidade: PT/50 F1 F4

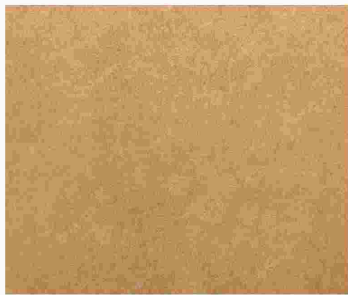

PAPEL KRAFT BIGNARD 80GX660MMX96CM 250X1
 Código: 41855 Fábrica: MGPAPEL Unidade: PT/250 F1 F4



PAPEL KRAFT BOB 80GRS 120CM 150MTS
 Código: 41850 Fábrica: MGPAPEL Unidade: RL/1 F1 F4

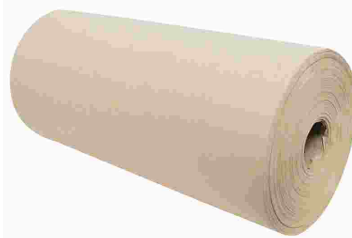

PAPEL KRAFT BOB 80GRS 40CM 140MTS 4,5KG
 Código: 45743 Fábrica: JUSSARA Unidade: RL/1 F1 F4



PAPEL KRAFT BOB 100GRS 100CM 100MTS
 Código: 44621 Fábrica: RITZ Unidade: RL/1 F1 F4



PAPEL KRAFT NAT BOB 60GRS 60CM 140MTS
 Código: 47720 Fábrica: REIPEL Unidade: RL/1 F1 F4



PAPEL LAMINADO AZUL 49X59CM 40X1
 Código: 6902 Fábrica: EMBALE Unidade: PT/40 F1 F4



PAPEL LAMINADO A4 250GR AZUL 10X1
 Código: 48909 Fábrica: MASTERPRINT Unidade: PT/10 F1 F4



PAPEL LAMINADO A4 250GR COBRE 10X1
 Código: 48910 Fábrica: MASTERPRINT Unidade: PT/10 F1 F4



PAPEL LAMINADO A4 250GR PRATA 10X1
 Código: 48912 Fábrica: MASTERPRINT Unidade: PT/10 F1 F4



PAPEL LAMINADO A4 250GR ROSA 10X1
 Código: 48915 Fábrica: MASTERPRINT Unidade: PT/10 F1 F4



PAPEL LAMINADO A4 250GR ROSE GOLD 10X1
 Código: 48914 Fábrica: MASTERPRINT Unidade: PT/10 F1 F4



PAPEL LAMINADO A4 250GR VERDE 10X1
 Código: 48911 Fábrica: MASTERPRINT Unidade: PT/10 F1 F4



PAPEL LAMINADO A4 250GR VERMELHO 10X1
 Código: 48913 Fábrica: MASTERPRINT Unidade: PT/10 F1 F4



PAPEL LAMINADO DOURADO 49X59CM 40X1
 Código: 18195 Fábrica: EMBALE Unidade: PT/40 F1 F4



PAPEL LAMINADO PRATA 49X59CM 40X1
 Código: 6151 Fábrica: EMBALE Unidade: PT/40 F1 F4



PAPEL LAMINADO PRETO 48X58CM 40X1
 Código: 21501 Fábrica: EMBALE Unidade: PT/40 F1 F4



PAPEL LAMINADO ROSA PINK 49X59CM 40X1

Código: 19601 Fábrica: EMBALE Unidade: PT/40 F1 F4



PAPEL LAMINADO VERDE 49X59CM 40X1

Código: 12203 Fábrica: EMBALE Unidade: PT/40 F1 F4



PAPEL LAMINADO VERMELHO 49X59CM 40X1

Código: 12202 Fábrica: EMBALE Unidade: PT/40 F1 F4



PAPEL LINHO A4 180GR BRANCO 50X1

Código: 41361 Fábrica: USUAL Unidade: PT/50 F1 F4



PAPEL LINHO A4 180GR CREME 50X1

Código: 45788 Fábrica: USAPEL Unidade: PT/50 F1 F4



PAPEL LINHO A4 180GR PALHA 50X1

Código: 41362 Fábrica: USAPEL Unidade: PT/50 F1 F4



PAPEL LUMINI A4 75GR SORT 50X1

Código: 35898 Fábrica: AGAPE Unidade: PT/50 F1 F4



PAPEL LUMINI A4 80GR SORT 40X1

Código: 47258 Fábrica: MINASPEL Unidade: PT/50 F1 F4



PAPEL MACHE 100 GRS S/COR

Código: 41983 Fábrica: ACRILEX Unidade: PT/1 F1 F4



PAPEL MANILHA STRONG BOB 25CM 250 MTS

Código: 43625 Fábrica: STRONG Unidade: RL/1 F1 F4



PAPEL MANILHA STRONG BOB 40CM 250 MTS

Código: 43626 Fábrica: STRONG Unidade: RL/1 F1 F4



PAPEL MANILHA STRONG BOB 60CM 250 MTS

Código: 43627 Fábrica: STRONG Unidade: RL/1 F1 F4

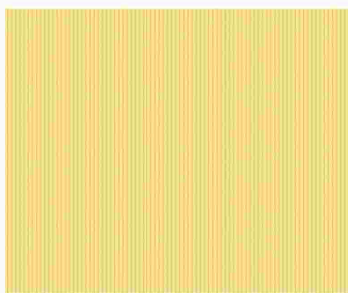

PAPEL MICROONDULADO AMARELO 48X80CM 10X1

Código: 3277 Fábrica: REIPEL/VMP Unidade: PT/10 F1 F4

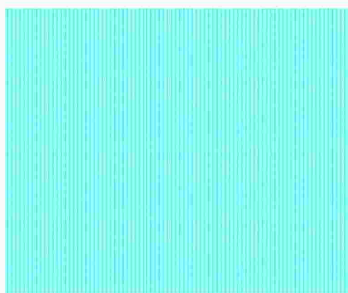

PAPEL MICROONDULADO AZUL CL 48X80CM 10X1

Código: 47712 Fábrica: REIPEL Unidade: PT/10 F1 F4

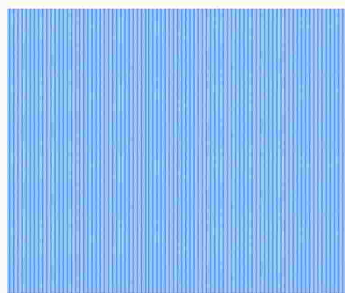

PAPEL MICROONDULADO AZUL ES 48X80CM 10X1

Código: 47710 Fábrica: REIPEL Unidade: PT/10 F1 F4

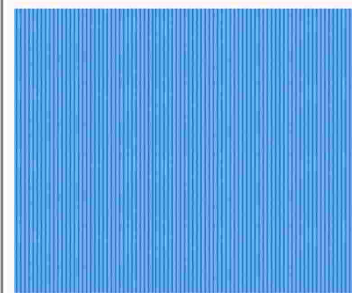

PAPEL MICROONDULADO AZUL 50X80CM 10X1

Código: 28181 Fábrica: VMP Unidade: PT/10 F1 F4

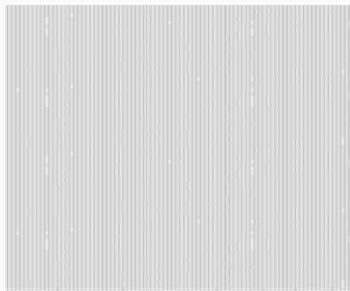

PAPEL MICROONDULADO BRANCO 48X80CM 10X1
 Código: 34394 Fábrica: VMP/REIPEL Unidade: PT/10
 F1 F4



PAPEL MICROONDULADO ESTAMP 50X80CM 10X1
 Código: 42383 Fábrica: RST Unidade: PT/10
 F1 F4

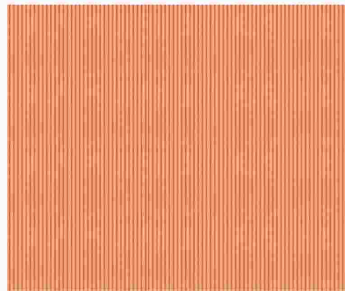

PAPEL MICROONDULADO LARANJA 50X80CM 10X1
 Código: 34395 Fábrica: REIPEL/VMP Unidade: PT/10
 F1 F4

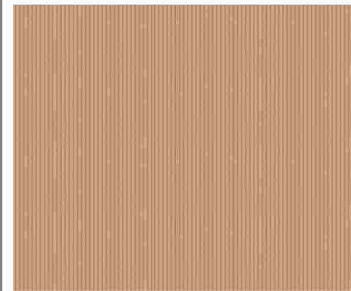

PAPEL MICROONDULADO MARROM 48X80CM 10X1
 Código: 47709 Fábrica: REIPEL Unidade: PT/10
 F1 F4

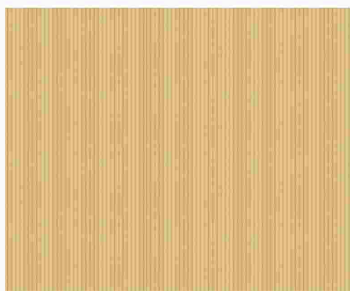

PAPEL MICROONDULADO OURO 48X80CM 10X1
 Código: 47714 Fábrica: REIPEL Unidade: PT/10
 F1 F4

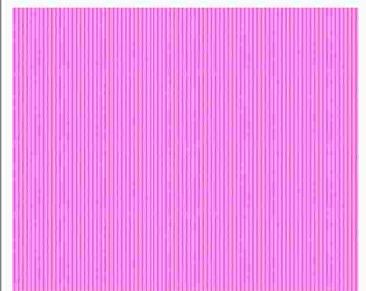

PAPEL MICROONDULADO PINK 48X80CM 10X1
 Código: 47711 Fábrica: REIPEL Unidade: PT/10
 F1 F4

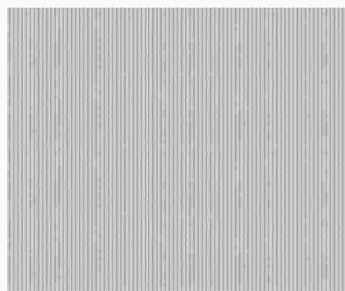

PAPEL MICROONDULADO PRATA 48X80CM 10X1
 Código: 47715 Fábrica: REIPEL Unidade: PT/10
 F1 F4

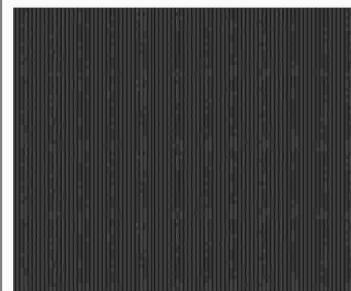

PAPEL MICROONDULADO PRETO 48X80CM 10X1
 Código: 34396 Fábrica: REIPEL/VMP Unidade: PT/10
 F1 F4

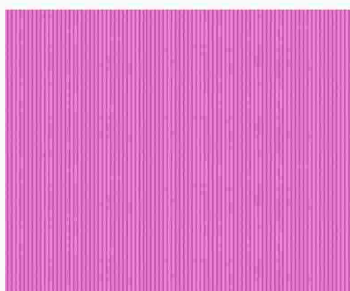

PAPEL MICROONDULADO ROSA 50X80CM 10X1
 Código: 4050 Fábrica: REIPEL/VMP Unidade: PT/10
 F1 F4



PAPEL MICROONDULADO ROXO 50X80CM 10X1
 Código: 34397 Fábrica: VMP Unidade: PT/10
 F1 F4

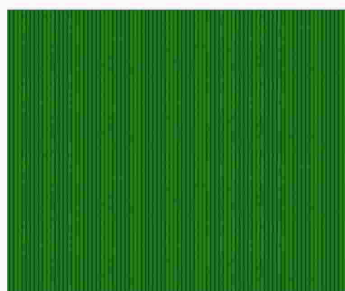

PAPEL MICROONDULADO VERDE B 48X80CM 10X1
 Código: 6901 Fábrica: REIPEL/VMP Unidade: PT/10
 F1 F4

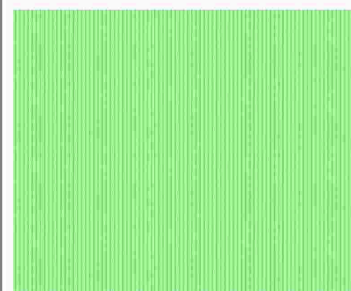

PAPEL MICROONDULADO VERDE C 48X80CM 10X1
 Código: 47713 Fábrica: REIPEL Unidade: PT/10
 F1 F4



PAPEL MICROONDULADO VERMELHO 48X80CM 10X1
 Código: 19220 Fábrica: REIPEL/VMP Unidade: PT/10
 F1 F4



PAPEL NACARADO BOB TRANSP 90CMX100MTS
 Código: 45815 Fábrica: CROMUS Unidade: UN/1
 F1 F4



PAPEL OFF PLUS A4 180GR VERDE 20X1
 Código: 45890 Fábrica: OFF PAPER Unidade: PT/20
 F1 F4



PAPEL OFF PLUS A4 180GR AMARELO 20X1
 Código: 45886 Fábrica: OFF PAPER Unidade: PT/20
 F1 F4



PAPEL OFF PLUS A4 180GR AZUL 20X1
 Código: **45607** Fábrica: **OFF PAPER** Unidade: **PT/20 F1 F4**



PAPEL OFF PLUS A4 180GR PRETO 20X1
 Código: **45889** Fábrica: **OFF PAPER** Unidade: **PT/20 F1 F4**



PAPEL OFF PLUS A4 180GR VERMELHO 20X1
 Código: **45888** Fábrica: **OFF PAPER** Unidade: **PT/20 F1 F4**



PAPEL OPALINE A4 120GR 40KG AMARELO 20X1
 Código: **48919** Fábrica: **MASTERPRINT** Unidade: **PT/20 F1 F4**



PAPEL OPALINE A4 120GR 40KG AZUL 20X1
 Código: **48930** Fábrica: **MASTERPRINT** Unidade: **PT/20 F1 F4**



PAPEL OPALINE A4 120GR 40KG BRANCO 50X1
 Código: **45127** Fábrica: **MASTERPRINT** Unidade: **PT/50 F1 F4**



PAPEL OPALINE A4 120GR 40KG CINZA 20X1
 Código: **48924** Fábrica: **MASTERPRINT** Unidade: **PT/20 F1 F4**



PAPEL OPALINE A4 120GR 40KG LARANJA 20X1
 Código: **48931** Fábrica: **MASTERPRINT** Unidade: **PT/20 F1 F4**



PAPEL OPALINE A4 120GR 40KG OURO 20X1
 Código: **48925** Fábrica: **MASTERPRINT** Unidade: **PT/20 F1 F4**



PAPEL OPALINE A4 120GR 40KG PRETO 20X1
 Código: **48926** Fábrica: **MASTERPRINT** Unidade: **PT/20 F1 F4**



PAPEL OPALINE A4 120GR 40KG ROSA 20X1
 Código: **48929** Fábrica: **MASTERPRINT** Unidade: **PT/20 F1 F4**



PAPEL OPALINE A4 120GR 40KG ROXO 20X1
 Código: **48928** Fábrica: **MASTERPRINT** Unidade: **PT/20 F1 F4**



PAPEL OPALINE A4 120GR 40KG VERDE 20X1
 Código: **48932** Fábrica: **MASTERPRINT** Unidade: **PT/20 F1 F4**



PAPEL OPALINE A4 120GR 40KG VERM 20X1
 Código: **48927** Fábrica: **MASTERPRINT** Unidade: **PT/20 F1 F4**



PAPEL OPALINE A4 120GR 40KG 10CORES 50X1
 Código: **48918** Fábrica: **MASTERPRINT** Unidade: **PT/50 F1 F4**



PAPEL OPALINE A4 180GR 60KG AMARELO 50X1
 Código: **45989** Fábrica: **MASTERPRINT** Unidade: **PT/50 F1 F4**



PAPEL OPALINE A4 180GR 60KG AZUL 50X1
 Código: 45993 Fábrica: MASTERPRINT Unidade: PT/50
 F1 F4



PAPEL OPALINE A4 180GR 60KG BRANCO 50X1
 Código: 45114 Fábrica: MASTERPRINT Unidade: PT/50
 F1 F4



PAPEL OPALINE A4 180GR 60KG PINK NEO20X1
 Código: 48916 Fábrica: MASTERPRINT Unidade: PT/20
 F1 F4



PAPEL OPALINE A4 180GR 60KG PRETO 50X1
 Código: 49065 Fábrica: MASTERPRINT Unidade: PT/50
 F1 F4



PAPEL OPALINE A4 180GR 60KG ROSA 50X1
 Código: 45990 Fábrica: MASTERPRINT Unidade: PT/50
 F1 F4



PAPEL OPALINE A4 180GR 60KG VERDE 50X1
 Código: 45991 Fábrica: MASTERPRINT Unidade: PT/50
 F1 F4



PAPEL OPALINE A4 180GR 60KG 4CORES 20X1
 Código: 48917 Fábrica: MASTERPRINT Unidade: PT/20
 F1 F4



PAPEL PARANA 80X100CM N120 10 FLS
 Código: 34399 Fábrica: VMP Unidade: PT/10
 F1 F4

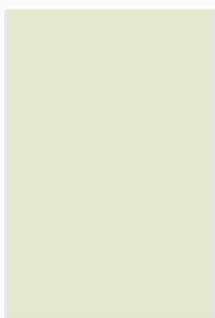

PAPEL PEROLA A4 120GR PRATA 25X1
 Código: 48263 Fábrica: AGAPE Unidade: PT/25
 F1 F4



PAPEL PEROLA A4 180GR AMARELO 30X1
 Código: 41363 Fábrica: USAPEL Unidade: PT/30
 F1 F4

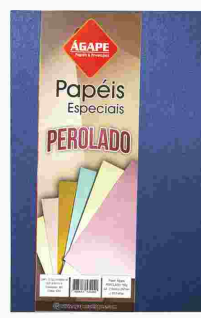

PAPEL PEROLA A4 180GR AZUL 25X1
 Código: 45642 Fábrica: AGAPE Unidade: PT/25
 F1 F4



PAPEL PEROLA A4 180GR BRANCO 20X1
 Código: 48935 Fábrica: MASTERPRINT Unidade: PT/20
 F1 F4



PAPEL PEROLA A4 180GR BRANCO 25X1
 Código: 45643 Fábrica: AGAPE Unidade: PT/25
 F1 F4



PAPEL PEROLA A4 180GR BRANCO 30X1
 Código: 41365 Fábrica: USAPEL Unidade: PT/30
 F1 F4



PAPEL PEROLA A4 180GR CHAMP ROSE 20X1
 Código: 48921 Fábrica: MASTERPRINT Unidade: PT/20
 F1 F4



PAPEL PEROLA A4 180GR DOURADO 20X1
 Código: 48920 Fábrica: MASTERPRINT Unidade: PT/20
 F1 F4



PAPEL PEROLA A4 180GR PRATA 20X1
 Código: 48923 Fábrica: MASTERPRINT Unidade: PT/20
 F1 F4



PAPEL PEROLA A4 180GR PRATA 30X1
 Código: 41364 Fábrica: USAPEL Unidade: PT/30
 F1 F4



PAPEL PEROLA A4 180GR ROSA 25X1
 Código: 45644 Fábrica: AGAPE Unidade: PT/25
 F1 F4



PAPEL PEROLA A4 180GR ROSA 30X1
 Código: 41366 Fábrica: USAPEL Unidade: PT/30
 F1 F4



PAPEL PEROLA A4 180GR 4 CORES 20X1
 Código: 48922 Fábrica: MASTERPRINT Unidade: PT/20
 F1 F4



PAPEL PLAST PRESENTE METAL 45X65CM 40X1
 Código: 32398 Fábrica: HAI BRASIL Unidade: PT/40
 F1 F4



PAPEL PRES COUC ANIVERSARIO 50X60CM 20X1
 Código: 40336 Fábrica: SAO JOAO Unidade: PT/20
 F1 F4



PAPEL PRES COUC BOB 40CM AMARELO 100M
 Código: 49168 Fábrica: SAO JOAO Unidade: RL/1
 F1 F4



PAPEL PRES COUC BOB 40CM CAS 100M
 Código: 46680 Fábrica: SAO JOAO Unidade: RL/1
 F1 F4



PAPEL PRES COUC BOB 40CM FEM 100M
 Código: 34839 Fábrica: SAO JOAO Unidade: RL/1
 F1 F4



PAPEL PRES COUC BOB 40CM INF 100M
 Código: 43743 Fábrica: SAO JOAO Unidade: RL/1
 F1 F4



PAPEL PRES COUC BOB 40CM NATAL 100M
 Código: 49173 Fábrica: SAO JOAO Unidade: RL/1
 F1 F4



PAPEL PRES COUC BOB 40CM ROMANT COR 100M
 Código: 46698 Fábrica: SAO JOAO Unidade: RL/1
 F1 F4



PAPEL PRES COUC BOB 40CM 2 TEMAS 100M
 Código: 49986 Fábrica: SAO JOAO Unidade: RL/1
 F1 F4



PAPEL PRES COUC BOB 60CM AMARELO 100M
 Código: 49169 Fábrica: SAO JOAO Unidade: RL/1
 F1 F4



PAPEL PRES COUC BOB 60CM CAS 100M
 Código: 46760 Fábrica: SAO JOAO Unidade: RL/1
 F1 F4



PAPEL PRES COUC BOB 60CM FEM 100M
 Código: 29095 Fábrica: SAO JOAO Unidade: RL/1
 F1 F4



PAPEL PRES COUC BOB 60CM INF 70M
 Código: 35309 Fábrica: SAO JOAO Unidade: RL/1
 F1 F4



PAPEL PRES COUC BOB 60CM INF 100M
 Código: 46755 Fábrica: SAO JOAO Unidade: RL/1
 F1 F4



PAPEL PRES COUC BOB 60CM NATAL 100M
 Código: 49174 Fábrica: SAO JOAO Unidade: RL/1
 F1 F4



PAPEL PRES COUC BOB 60CM 2 TEMAS 100M
 Código: 49982 Fábrica: SAO JOAO Unidade: RL/1
 F1 F4



PAPEL PRES COUC CASUAL 50X60CM 20X1
 Código: 43115 Fábrica: SAO JOAO Unidade: PT/20
 F1 F4



PAPEL PRES COUC COPA GOL 50X60CM 20X1
 Código: 39577 Fábrica: VMP Unidade: PT/20
 F1 F4

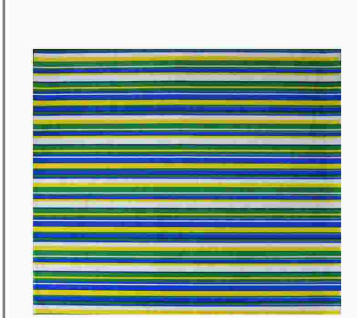

PAPEL PRES COUC COPA LISTR 50X60CM 20X1
 Código: 39576 Fábrica: VMP Unidade: PT/20
 F1 F4



PAPEL PRES COUC COPA R HEXA 50X60CM 20X1
 Código: 39578 Fábrica: VMP Unidade: PT/20
 F1 F4



PAPEL PRES COUC FEMININO 50X60CM 20X1
 Código: 33065 Fábrica: SAO JOAO Unidade: PT/20
 F1 F4



PAPEL PRES COUC INFANTIL 50X60CM 20X1
 Código: 43135 Fábrica: SAO JOAO Unidade: PT/20
 F1 F4



PAPEL PRES COUC NATAL 50X60CM 20X1
 Código: 43715 Fábrica: SAO JOAO Unidade: PT/20
 F1 F4



PAPEL PRES COUC ROMANTICO 50X60CM 20X1
 Código: 36784 Fábrica: SAO JOAO Unidade: PT/20
 F1 F4

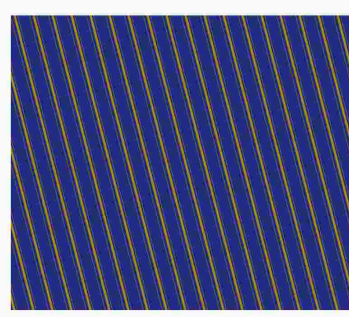

PAPEL PRES COUC 016 CAS AZUL 50X60 20X1
 Código: 40962 Fábrica: SAO JOAO Unidade: PT/20
 F1 F4



PAPEL PRES COUC 178 CAS VERDE 50X60 20X1
 Código: 34823 Fábrica: SAO JOAO Unidade: PT/20
 F1 F4

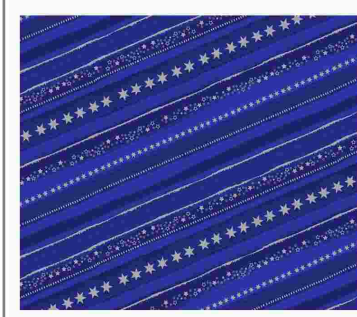

PAPEL PRES COUC 349 CAS AZUL 50X60 20X1
 Código: 15810 Fábrica: SAO JOAO Unidade: PT/20
 F1 F4



PAPEL SEDA P/BALA AZUL CLARO 48X1

Código: **39209** Fábrica: **PEL PLAST** Unidade: **PT/48 F1 F4**



PAPEL SEDA P/BALA AZUL ESC 48X1

Código: **7995** Fábrica: **PEL PLAST** Unidade: **PT/48 F1 F4**



PAPEL SEDA P/BALA BRANCO 48X1

Código: **8000** Fábrica: **PEL PLAST** Unidade: **PT/48 F1 F4**



PAPEL SEDA P/BALA LILAS 48X1

Código: **27707** Fábrica: **PEL PLAST** Unidade: **PT/48 F1 F4**



PAPEL SEDA P/BALA ROSA 48X1

Código: **7997** Fábrica: **PEL PLAST** Unidade: **PT/48 F1 F4**



PAPEL SEDA P/BALA VERDE LIMAO 48X1

Código: **25623** Fábrica: **PEL PLAST** Unidade: **PT/48 F1 F4**



PAPEL SEDA P/BALA VERMELHO 48X1

Código: **7998** Fábrica: **PEL PLAST** Unidade: **PT/48 F1 F4**

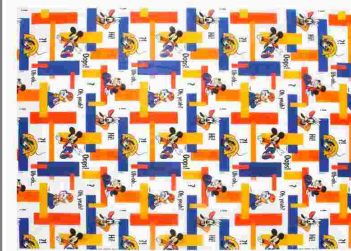

PAPEL SEDA ESTAMPADO MICKEY 40X1

Código: **19367** Fábrica: **JARAGUA** Unidade: **PT/40 F1 F4**



PAPEL SEDA IMPERM AZUL 48X59CM 40X1

Código: **33153** Fábrica: **EMBALE** Unidade: **PT/40 F1 F4**



PAPEL SEDA IMPERM BRANCO 48X59CM 40X1

Código: **27160** Fábrica: **EMBALE** Unidade: **PT/40 F1 F4**



PAPEL SEDA IMPERM PINK 48X59CM 40X1

Código: **33234** Fábrica: **EMBALE** Unidade: **PT/40 F1 F4**



PAPEL SEDA IMPERM VERDE 48X59CM 40X1

Código: **33154** Fábrica: **EMBALE** Unidade: **PT/40 F1 F4**



PAPEL SEDA IMPERM VERMELHO 48X59CM 40X1

Código: **32409** Fábrica: **EMBALE** Unidade: **PT/40 F1 F4**



PAPEL SEDA 48X60CM AMARELO CANARIO 100X1

Código: **15613** Fábrica: **ARTFLOC** Unidade: **PT/100 F1 F4**

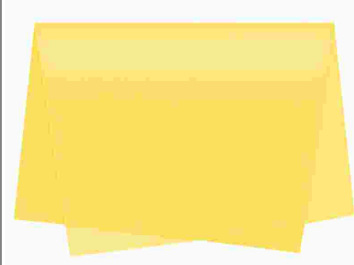

PAPEL SEDA 48X60CM AMARELO OURO 100X1

Código: **46888** Fábrica: **ART FLOC** Unidade: **PT/100 F1 F4**



PAPEL SEDA 48X60CM AMARELO 100X1

Código: **44779** Fábrica: **ARTFLOC/NOVA** Unidade: **PT/100 F1 F4**



PAPEL SEDA 48X60CM AZUL CLARO 100X1

Código: **15622** Fábrica: **ARTFLOC** Unidade: **PT/100**
F1 F4

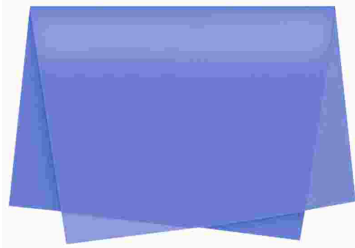

PAPEL SEDA 48X60CM AZUL ESCURO 100X1

Código: **44780** Fábrica: **ARTFLOC/NOVA** Unidade: **PT/100**
F1 F4



PAPEL SEDA 48X60CM AZUL MARINHO 100X1

Código: **15617** Fábrica: **ARTFLOC** Unidade: **PT/100**
F1 F4



PAPEL SEDA 48X60CM AZUL PISCINA 100X1

Código: **22594** Fábrica: **ARTFLOC** Unidade: **PT/100**
F1 F4



PAPEL SEDA 48X60CM AZUL ROYAL 100X1

Código: **19660** Fábrica: **ARTFLOC** Unidade: **PT/100**
F1 F4



PAPEL SEDA 48X60CM BRANCO 100X1

Código: **1602** Fábrica: **ART FLOC** Unidade: **PT/100**
F1 F4



PAPEL SEDA 48X60CM CHAMPAGNE 100X1

Código: **20638** Fábrica: **ARTFLOC** Unidade: **PT/100**
F1 F4



PAPEL SEDA 48X60CM LARANJA 100X1

Código: **15618** Fábrica: **ARTFLOC** Unidade: **PT/100**
F1 F4



PAPEL SEDA 48X60CM LILAS 100X1

Código: **15616** Fábrica: **ARTFLOC/NOVA** Unidade: **PT/100**
F1 F4



PAPEL SEDA 48X60CM MARRON 100X1

Código: **15620** Fábrica: **ARTFLOC/NOVA** Unidade: **PT/100**
F1 F4



PAPEL SEDA 48X60CM PRETO 100X1

Código: **18406** Fábrica: **ARTFLOC** Unidade: **PT/100**
F1 F4



PAPEL SEDA 48X60CM ROSA BEBE 100X1

Código: **33870** Fábrica: **EMBALE** Unidade: **PT/100**
F1 F4



PAPEL SEDA 48X60CM ROSA CLARO 100X1

Código: **38342** Fábrica: **ARTFLOC** Unidade: **PT/100**
F1 F4



PAPEL SEDA 48X60CM ROSA PINK 100X1

Código: **6299** Fábrica: **ARTFLOC** Unidade: **PT/100**
F1 F4



PAPEL SEDA 48X60CM ROSA 100X1

Código: **15614** Fábrica: **ARTFLOC** Unidade: **PT/100**
F1 F4



PAPEL SEDA 48X60CM ROXO 100X1

Código: **8052** Fábrica: **ARTFLOC** Unidade: **PT/100**
F1 F4



PAPEL SEDA 48X60CM SALMAO 100X1

Código: 19369 Fábrica: ART FLOC Unidade: PT/100 F1 F4



PAPEL SEDA 48X60CM VERDE BANDEIRA 100X1

Código: 15615 Fábrica: ARTFLOC/NOVA Unidade: PT/100 F1 F4



PAPEL SEDA 48X60CM VERDE CLARO 100X1

Código: 15621 Fábrica: EMBALE/ARTFL Unidade: PT/100 F1 F4



PAPEL SEDA 48X60CM VERDE FOLHA 100X1

Código: 44778 Fábrica: ARTFLOC/NOVA Unidade: PT/100 F1 F4



PAPEL SEDA 48X60CM VERDE LIMAO 100X1

Código: 38343 Fábrica: ART FLOC Unidade: PT/100 F1 F4



PAPEL SEDA 48X60CM VERMELHO 100X1

Código: 15619 Fábrica: ART FLOC Unidade: PT/100 F1 F4



PAPEL SEDA 48X60CM VINHO 100X1

Código: 19656 Fábrica: ARTFLOC Unidade: PT/100 F1 F4



PAPEL SEDA 48X60CM VIOLETA 100X1

Código: 38344 Fábrica: ARTFLOC Unidade: PT/100 F1 F4



PAPEL SEMI KRAFT BOB 80G 120CMX200MX20KG

Código: 47304 Fábrica: JUSSARA Unidade: RL/1 F1 F4



PAPEL SEMI KRAFT 80GRS 66X96CM 400 200X1

Código: 39981 Fábrica: SANTECK Unidade: PT/200 F1 F4



PAPEL SULFITE BCO 216X279MM 500 FLS

Código: 50698 Fábrica: CHAMEX Unidade: PT/500 F1 F4



PAPEL SULFITE BRANCO 216X279MM 100X1

Código: 7314 Fábrica: CHAMEX Unidade: PT/100 F1 F4



PAPEL TRANSFER A4 160GR TECIDO CLA 5X1

Código: 40674 Fábrica: MASTERPRINT Unidade: PT/5 F1 F4



PAPEL TRANSFER A4 235GR TECIDO ESC 5X1

Código: 40673 Fábrica: MASTERPRINT Unidade: PT/5 F1 F4



PAPEL VEGETAL A4 90/95GRS 50X1

Código: 51023 Fábrica: MARES Unidade: PT/50 F1 F4



PAPEL VERGE A4 120GR BRANCO 50X1

Código: 48765 Fábrica: USAPEL Unidade: PT/50 F1 F4



PAPEL VERGE A4 120GR BRANCO 50X1
 Código: 48934 Fábrica: MASTERPRINT Unidade: PT/50 F1 F4



PAPEL VERGE A4 120GR CREME 50X1
 Código: 48767 Fábrica: USAPEL Unidade: PT/50 F1 F4



PAPEL VERGE A4 120GR MADRE PEROLA 50X1
 Código: 48766 Fábrica: USAPEL Unidade: PT/50 F1 F4

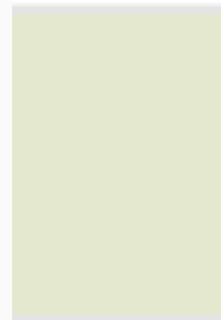

PAPEL VERGE A4 120GR MARFIM 50X1
 Código: 33695 Fábrica: USAPEL Unidade: PT/50 F1 F4



PAPEL VERGE A4 180GR AZUL CLARO 50X1
 Código: 38559 Fábrica: USAPEL Unidade: PT/50 F1 F4

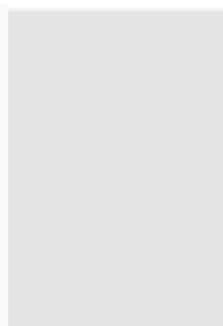

PAPEL VERGE A4 180GR BRANCO 50X1
 Código: 4259 Fábrica: USAPEL Unidade: PT/50 F1 F4



PAPEL VERGE A4 180GR CINZA 50X1
 Código: 43325 Fábrica: USAPEL Unidade: PT/50 F1 F4

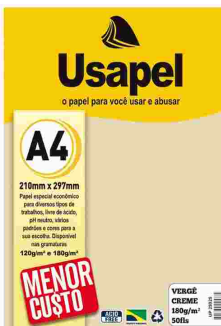

PAPEL VERGE A4 180GR CREME 50X1
 Código: 41367 Fábrica: USAPEL Unidade: PT/50 F1 F4

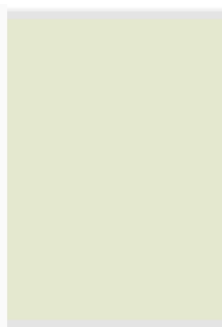

PAPEL VERGE A4 180GR MARFIM 50X1
 Código: 31684 Fábrica: USAPEL Unidade: PT/50 F1 F4



PAPEL VERGE A4 180GR PALHA 50X1
 Código: 41368 Fábrica: USAPEL Unidade: PT/50 F1 F4



PAPEL VERGE A4 180GR SALMAO 50X1
 Código: 31682 Fábrica: USAPEL Unidade: PT/50 F1 F4



PAPEL VERGE A4 180GR TEXTU BRANCO 50X1
 Código: 45115 Fábrica: MASTERPRINT Unidade: PT/50 F1 F4



PAPEL VERGE A4 180GR VERDE 50X1
 Código: 31683 Fábrica: USAPEL Unidade: PT/50 F1 F4



PASTA AZ REG ARQ OF LOMBO ESTR PRETO
 Código: 42387 Fábrica: POLYCART Unidade: UN/1 F1 F4



PASTA AZ REG ARQ OF LOMBO ESTR TEXTURA
 Código: 42606 Fábrica: POLYCART Unidade: UN/1 F1 F4



PASTA AZ REG ARQ OF LOMBO LARGO PRETO
 Código: 45237 Fábrica: ECONOMIC Unidade: UN/1 F1 F4

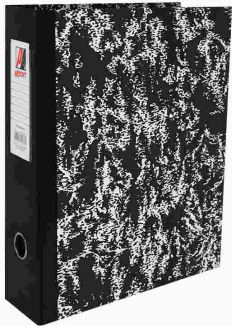

PASTA AZ REG ARQ OF LOMBO LARGO TEXTURA
 Código: 42607 Fábrica: POLYCART Unidade: UN/1
 F1 F4



PASTA AZ REG ARQ OFIC LOMBO ESTR TIGRADO
 Código: 42605 Fábrica: FRAMA Unidade: UN/1
 F1 F4

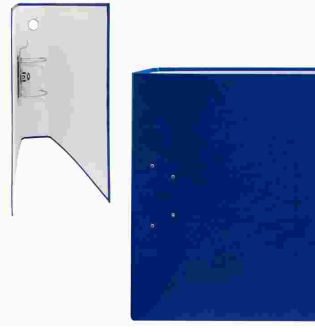

PASTA AZ REG ARQ OFIC LOMBO LARGO AZUL
 Código: 13241 Fábrica: FRAMA Unidade: UN/1
 F1 F4



PASTA AZ REG ARQ OFIC LOMBO LARGO GRAFIT
 Código: 41680 Fábrica: FRAMA Unidade: UN/1
 F1 F4

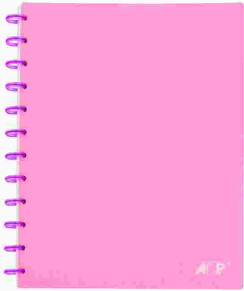

PASTA CANDY A4 C/30 ENVELOPE DESTAC AZUL
 Código: 46097 Fábrica: ACP Unidade: UN/1
 F1 F4



PASTA CANDY A4 C/30 ENVELOPE DESTAC ROSA
 Código: 46096 Fábrica: ACP Unidade: UN/1
 F1 F4



PASTA CATALOGO OFIC 10 PLAST 0,06 123
 Código: 909 Fábrica: ACP Unidade: UN/1
 F1 F4



PASTA CATALOGO OFIC 30 PLAST 0,06 123/3
 Código: 15378 Fábrica: ACP Unidade: UN/1
 F1 F4



PASTA CATALOGO OFIC 50 PLAST 0,06 122
 Código: 1703 Fábrica: ACP/DAC Unidade: UN/1
 F1 F4



PASTA CATALOGO OFIC 100 PLAST 0,06 130
 Código: 7051 Fábrica: ACP Unidade: UN/1
 F1 F4

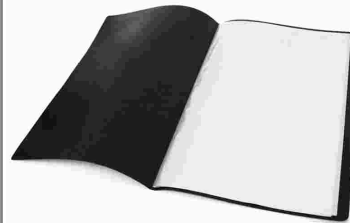

PASTA CATALOGO PP OF 10 PLAST PRETA
 Código: 27130 Fábrica: AD Unidade: UN/1
 F1 F4



PASTA CLASSIFICADORA AZUL 10X1
 Código: 11195 Fábrica: TP PASTAS Unidade: PT/10
 F1 F4



PASTA CLASSIFICADORA CINZA 10X1
 Código: 11199 Fábrica: TP PASTAS Unidade: PT/10
 F1 F4

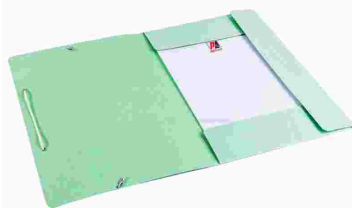

PASTA CLASSIFICADORA DUPLO PLAST 20X1
 Código: 51134 Fábrica: POLYCART Unidade: PT/20
 F1 F4

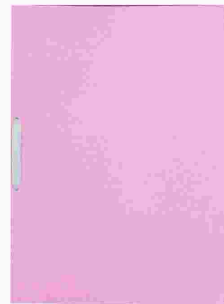

PASTA CLASSIFICADORA ROSA 10X1
 Código: 47773 Fábrica: TP PASTAS Unidade: PT/10
 F1 F4



PASTA CLASSIFICADORA VERDE UN
 Código: 43506 Fábrica: DELUCAS Unidade: UN/1
 F1 F4



PASTA CLASSIFICADORA VERDE 10X1

Código: **11196** Fábrica: **TT PASTAS** Unidade: **PT/10**
F1 F4



PASTA ENVELOP PP OF VAI VEM CRISTAL 10X1

Código: **41606** Fábrica: **DAC/ACP** Unidade: **PT/10**
F1 F4

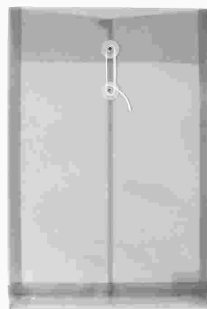

PASTA ENVELOPE PP OF VAI VEM FUME 10X1

Código: **41607** Fábrica: **DAC/ACP** Unidade: **PT/10**
F1 F4



PASTA LONA EXECUTIVA DETALH MARRON 52203

Código: **33850** Fábrica: **HOLLYCLASSIC** Unidade: **UN/1**
F1 F4



PASTA LONA EXECUTIVA PRETA 52203

Código: **34038** Fábrica: **HOLLYCLASSIC** Unidade: **UN/1**
F1 F4



PASTA LONA HELLO KITTY 001

Código: **12815** Fábrica: **LOMY** Unidade: **UN/1**
F1 F4



PASTA LONA SILKADA

Código: **15242** Fábrica: **A2WORKS** Unidade: **UN/1**
F1 F4



PASTA PAPEL ABA ELAST C/ILHOS AMARE 10X1

Código: **45393** Fábrica: **TP PASTAS** Unidade: **PT/10**
F1 F4

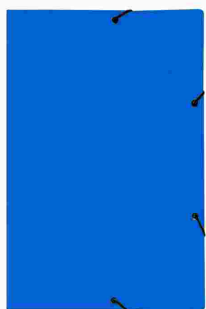

PASTA PAPEL ABA ELAST C/ILHOS AZUL 10X1

Código: **44336** Fábrica: **TP PASTAS** Unidade: **PT/10**
F1 F4



PASTA PAPEL ABA ELAST C/ILHOS PRETO 10X1

Código: **44337** Fábrica: **TP PASTAS** Unidade: **PT/10**
F1 F4



PASTA PAPEL ABA ELAST C/ILHOS ROSA 10X1

Código: **45394** Fábrica: **TP PASTAS** Unidade: **PT/10**
F1 F4

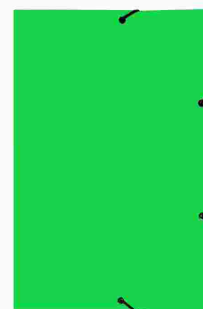

PASTA PAPEL ABA ELAST C/ILHOS VERDE 10X1

Código: **44338** Fábrica: **TP PASTAS** Unidade: **PT/10**
F1 F4

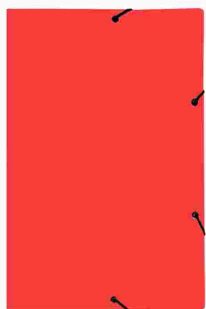

PASTA PAPEL ABA ELAST C/ILHOS VERM 10X1

Código: **44339** Fábrica: **TP PASTAS** Unidade: **PT/10**
F1 F4

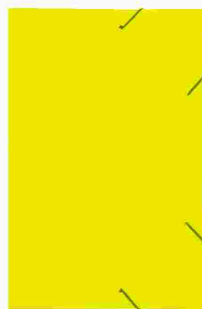

PASTA PAPEL ABA ELAST S/ILHOS AMARE 10X1

Código: **8652** Fábrica: **TP PASTAS** Unidade: **PT/10**
F1 F4



PASTA PAPEL ABA ELAST S/ILHOS AZUL 10X1

Código: **18084** Fábrica: **TP PAST/BRAS** Unidade: **PT/10**
F1 F4



PASTA PAPEL ABA ELAST S/ILHOS BRANC 10X1

Código: **47774** Fábrica: **TP PASTAS** Unidade: **PT/10**
F1 F4

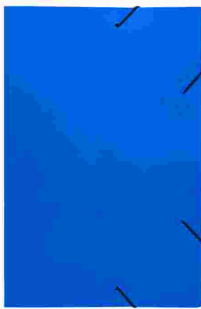

PASTA PAPEL ABA ELAST S/ILHOS LARAN 10X1

Código: 47775 Fábrica: TP PASTAS Unidade: PT/10 F1 F4



PASTA PAPEL ABA ELAST S/ILHOS PRETO 10X1

Código: 8661 Fábrica: TP PASTAS Unidade: PT/10 F1 F4

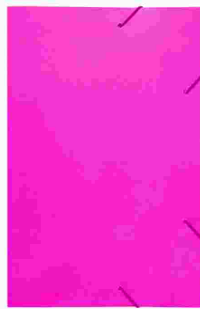

PASTA PAPEL ABA ELAST S/ILHOS ROSA 10X1

Código: 27877 Fábrica: TP PASTAS Unidade: PT/10 F1 F4



PASTA PAPEL ABA ELAST S/ILHOS VERM 10X1

Código: 8650 Fábrica: TP PASTAS Unidade: PT/10 F1 F4



PASTA PAPEL ABA ELASTICA

Código: 11201 Fábrica: ACP Unidade: UN/1 F1 F4



PASTA PAPEL C/GRAMPO METAL BRANCA 10X1

Código: 44218 Fábrica: TP PASTAS Unidade: PT/10 F1 F4



PASTA PAPEL C/GRAMPO METAL 10X1

Código: 45401 Fábrica: TP PASTAS Unidade: PT/10 F1 F4



PASTA PAPEL C/GRAMPO PLAST AMARELO 10X1

Código: 11197 Fábrica: TP PASTAS Unidade: PT/10 F1 F4

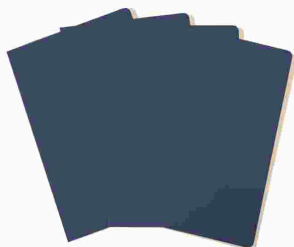

PASTA PAPEL C/GRAMPO PLAST AZUL 10X1

Código: 44216 Fábrica: TP PASTAS Unidade: PT/10 F1 F4



PASTA PAPEL C/GRAMPO PLAST BRANCA 10X1

Código: 48047 Fábrica: TP PASTAS Unidade: PT/10 F1 F4



PASTA PAPEL C/GRAMPO PLAST LARANJA 10X1

Código: 48048 Fábrica: TP PASTAS Unidade: PT/10 F1 F4

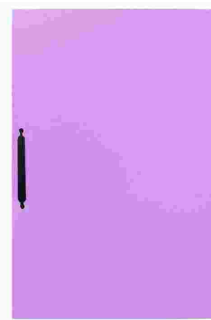

PASTA PAPEL C/GRAMPO PLAST LILAS 10X1

Código: 48049 Fábrica: TP PASTAS Unidade: PT/10 F1 F4



PASTA PAPEL C/GRAMPO PLAST ROSA 10X1

Código: 48046 Fábrica: TP PASTAS Unidade: PT/10 F1 F4



PASTA PAPEL C/GRAMPO PLAST VERDE 10X1

Código: 44215 Fábrica: TP PASTAS Unidade: PT/10 F1 F4



PASTA PAPEL C/GRAMPO PLAST VERMELHO 10X1

Código: 11198 Fábrica: TP PAS/BRAS Unidade: PT/10 F1 F4



PASTA PAPEL C/GRAMPO PRETA 10X1

Código: 43862 Fábrica: TP PASTAS Unidade: PT/10 F1 F4



PASTA PAPEL C/GRAMPO ROSA 10X1

Código: **44219** Fábrica: **TP PASTAS** Unidade: **PT/10 F1 F4**

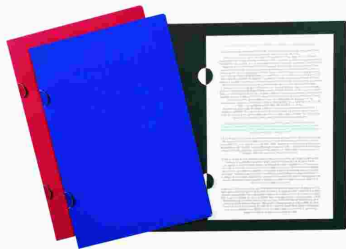

PASTA PAPEL C/ORELHA DUPLEX COLOR 20X1

Código: **51028** Fábrica: **POLYCARD** Unidade: **PT/20 F1 F4**

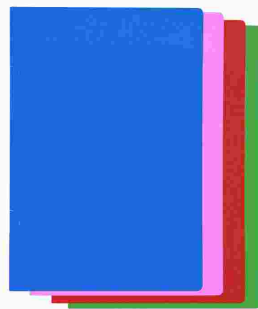

PASTA PAPEL PROCESSO 10X1

Código: **45400** Fábrica: **DELUCAS** Unidade: **PT/10 F1 F4**



PASTA PAPEL S/GRAMPO AMARELO 10X1

Código: **48050** Fábrica: **TP PASTAS** Unidade: **PT/10 F1 F4**

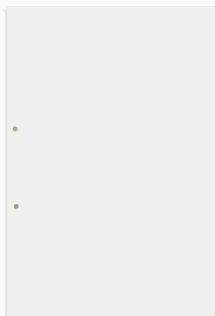

PASTA PAPEL S/GRAMPO BRANCA10X1

Código: **48051** Fábrica: **TP PASTAS** Unidade: **PT/10 F1 F4**



PASTA PAPEL S/GRAMPO CINZA 10X1

Código: **48053** Fábrica: **TP PASTAS** Unidade: **PT/10 F1 F4**



PASTA PAPEL S/GRAMPO LARANJA 10X1

Código: **48052** Fábrica: **TP PASTAS** Unidade: **PT/10 F1 F4**

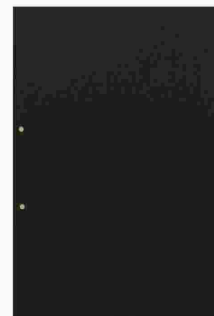

PASTA PAPEL S/GRAMPO PRETA 10X1

Código: **48054** Fábrica: **TP PASTAS** Unidade: **PT/10 F1 F4**



PASTA PAPEL S/GRAMPO ROSA 10X1

Código: **48055** Fábrica: **TP PASTAS** Unidade: **PT/10 F1 F4**



PASTA PAPEL 250G GRAMPO PLAST AZUL 10X1

Código: **49778** Fábrica: **TP PASTAS** Unidade: **PT/10 F1 F4**



PASTA PAPEL 250G GRAMPO PLAST VERM 10X1

Código: **49777** Fábrica: **TP PASTAS** Unidade: **PT/10 F1 F4**



PASTA POLIONDA OF 2 CM AMARELA 10X1

Código: **9868** Fábrica: **ALAPLAST** Unidade: **PT/10 F1 F4**



PASTA POLIONDA OF 2 CM AZUL 10X1

Código: **25628** Fábrica: **ALAPLAST** Unidade: **PT/10 F1 F4**

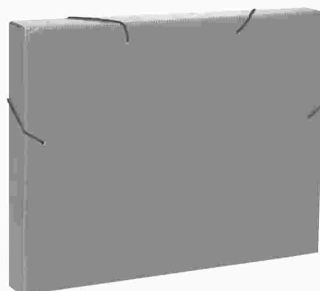

PASTA POLIONDA OF 2 CM CINZA 10X1

Código: **43863** Fábrica: **ALAPLAST** Unidade: **PT/10 F1 F4**



PASTA POLIONDA OF 2 CM PRETA 10X1

Código: **18372** Fábrica: **ALAPLAST** Unidade: **PT/10 F1 F4**



PASTA POLIONDA OF 2 CM VERDE 10X1

Código: **25627** Fábrica: **ALAPLAST** Unidade: **PT/10 F1 F4**



PASTA POLIONDA OF 2 CM VERMELHA 10X1

Código: 42427 Fábrica: ALAPLAST Unidade: PT/10 F1 F4

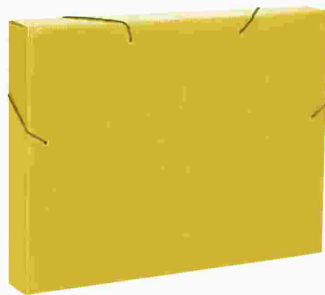

PASTA POLIONDA OF 3,5 CM AMARELA 10X1

Código: 28201 Fábrica: ALAPLAST Unidade: PT/10 F1 F4



PASTA POLIONDA OF 3,5 CM AZUL 10X1

Código: 28202 Fábrica: ALAPLAST Unidade: PT/10 F1 F4

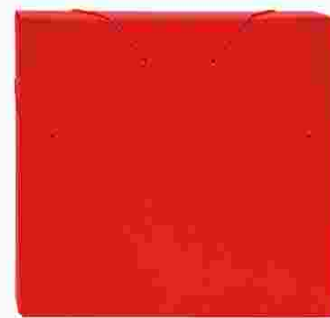

PASTA POLIONDA OF 3,5 CM PRETA 10X1

Código: 28204 Fábrica: ALAPLAST Unidade: PT/10 F1 F4

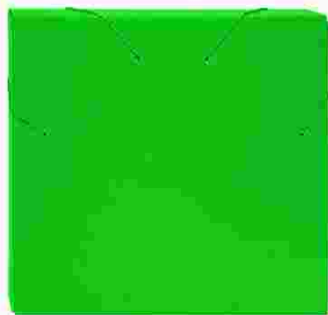

PASTA POLIONDA OF 3,5 CM VERDE 10X1

Código: 28203 Fábrica: ALAPLAST Unidade: PT/10 F1 F4



PASTA POLIONDA OF 3,5 CM VERMELHA 10X1

Código: 42428 Fábrica: ALAPLAST Unidade: PT/10 F1 F4

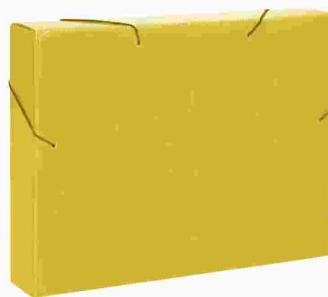

PASTA POLIONDA OF 5,5 CM AMARELA 10X1

Código: 43865 Fábrica: ALAPLAST Unidade: PT/10 F1 F4

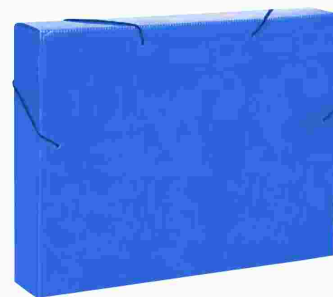

PASTA POLIONDA OF 5,5 CM AZUL 10X1

Código: 43864 Fábrica: ALAPLAST Unidade: PT/10 F1 F4



PASTA POLIONDA OF 5,5 CM CINZA 10X1

Código: 43867 Fábrica: ALAPLAST Unidade: PT/10 F1 F4

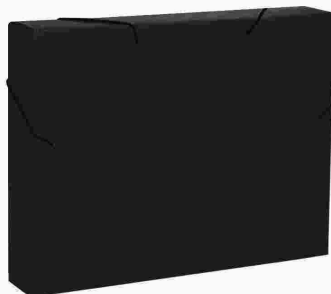

PASTA POLIONDA OF 5,5 CM PRETA 10X1

Código: 43868 Fábrica: ALAPLAST Unidade: PT/10 F1 F4

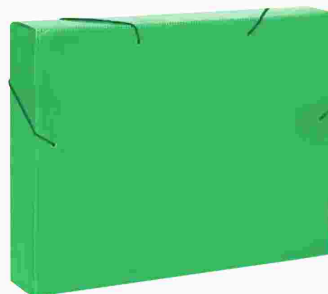

PASTA POLIONDA OF 5,5 CM VERDE 10X1

Código: 43866 Fábrica: ALAPLAST Unidade: PT/10 F1 F4



PASTA POLIONDA OF 5,5 CM VERMELHO 10X1

Código: 42429 Fábrica: ALAPLAST Unidade: PT/10 F1 F4



PASTA PP OF AMARELO TRANSP 10X1

Código: 9760 Fábrica: ALAPLAST Unidade: PT/10 F1 F4



PASTA PP OF AZUL FOSCA 20104A 10X1

Código: 43185 Fábrica: ALAPLAST Unidade: PT/10 F1 F4



PASTA PP OF AZUL TRANSP 10X1

Código: 46000 Fábrica: ALAPLAST Unidade: PT/10 F1 F4



PASTA PP OF AZUL 1021 10X1

Código: 9757 Fábrica: ACP Unidade: PT/10 F1 F4

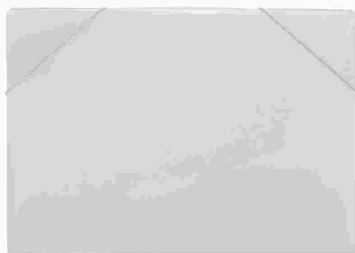

PASTA PP OF CRISTAL TRANSP 10X1

Código: **13089** Fábrica: **ALAPLAST** Unidade: **PT/10 F1 F4**



PASTA PP OF ELAST AMARELO FOSCA 10X1

Código: **44326** Fábrica: **ALAPLAST** Unidade: **PT/10 F1 F4**

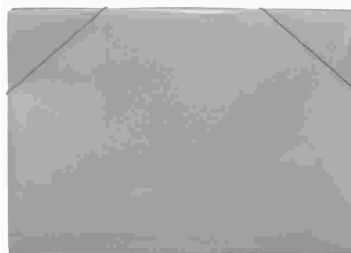

PASTA PP OF FUME TRANSP 10X1

Código: **10031** Fábrica: **ALAPLAST** Unidade: **PT/10 F1 F4**

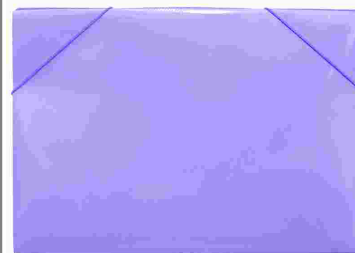

PASTA PP OF LILAS TRANSP 10X1

Código: **38317** Fábrica: **ALAPLAST** Unidade: **PT/10 F1 F4**

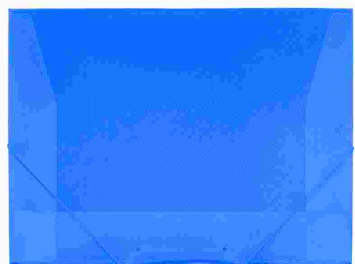

PASTA PP OF LILAS 1021 10X1

Código: **46167** Fábrica: **ACP** Unidade: **PT/10 F1 F4**



PASTA PP OF ROSA TRANSP 10X1

Código: **41286** Fábrica: **ALAPLAST** Unidade: **PT/10 F1 F4**



PASTA PP OF ROSA 1021 10X1

Código: **46166** Fábrica: **ACP** Unidade: **PT/10 F1 F4**



PASTA PP OF VERDE TRANSP 10X1

Código: **46001** Fábrica: **ALAPLAST** Unidade: **PT/10 F1 F4**



PASTA PP OF VERDE 1021 10X1

Código: **46165** Fábrica: **ACP** Unidade: **PT/10 F1 F4**



PASTA PP OF VERMELHO TRANSP 10X1

Código: **29784** Fábrica: **ALAPLAST** Unidade: **PT/10 F1 F4**



PASTA PP OF VERMELHO 1021 10X1

Código: **46169** Fábrica: **ACP** Unidade: **PT/10 F1 F4**

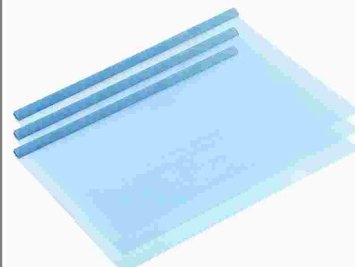

PASTA PP CANALETA A4 AZUL TRANSP 10X1

Código: **43858** Fábrica: **ALAPLAST** Unidade: **PT/10 F1 F4**



PASTA PP CANALETA A4 CRISTAL TRANSP 10X1

Código: **43857** Fábrica: **DAC** Unidade: **PT/10 F1 F4**



PASTA PP CANALETA A4 CRISTAL TRANSP 10X1

Código: **46002** Fábrica: **ALAPLAST** Unidade: **PT/10 F1 F4**



PASTA PP CANALETA A4 FUME TRANSP 10X1

Código: **43860** Fábrica: **DAC** Unidade: **PT/10 F1 F4**



PASTA PP CANALETA A4 PRETO 10X1

Código: **15373** Fábrica: **SUPER LINE** Unidade: **PT/10 F1 F4**

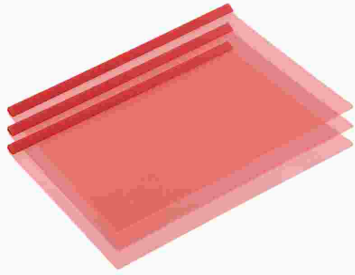

PASTA PP CANALETA A4 VERMELHO TRANS 10X1
 Código: 43861 Fábrica: ALAPLAST Unidade: PT/10 F1 F4



PASTA PP L A4 AMARELA 042-AM 10X1
 Código: 50018 Fábrica: DAC Unidade: PT/10 F1 F4



PASTA PP L A4 AZUL 042-AZ 10X1
 Código: 50019 Fábrica: DAC Unidade: PT/10 F1 F4



PASTA PP L A4 CRISTAL 371 10X1
 Código: 24136 Fábrica: LIKE Unidade: PT/10 F1 F4



PASTA PP L A4 ROSA 10X1
 Código: 50054 Fábrica: DAC Unidade: PT/10 F1 F4



PASTA PP L A4 VERDE 042-VD 10X1
 Código: 50020 Fábrica: DAC Unidade: PT/10 F1 F4

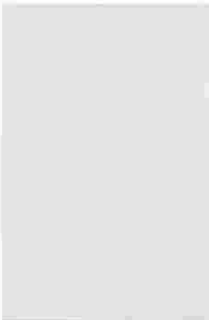

PASTA PP L OF CRISTAL 271/113 10X1
 Código: 24135 Fábrica: DELLO/LIKE Unidade: PT/10 F1 F4



PASTA PP OF GRAMPO PLAST OF 10X1
 Código: 41617 Fábrica: ALAPLAST Unidade: UN/1 F1 F4



PASTA PP OF GRAMPO TRILHO CRISTAL 10X1
 Código: 9772 Fábrica: DAC Unidade: PT/10 F1 F4



PASTA PP OF GRAMPO TRILHO CRISTAL 10X1
 Código: 46215 Fábrica: ACP Unidade: PT/10 F1 F4



PASTA PP OF GRAMPO TRILHO FUME TRAN 10X1
 Código: 29196 Fábrica: ALAPLAST Unidade: PT/10 F1 F4

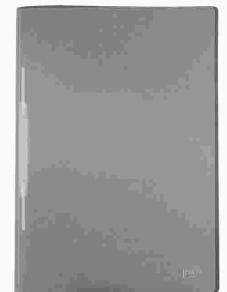

PASTA PP OF GRAMPO TRILHO FUME 10X1
 Código: 8932 Fábrica: DAC Unidade: PT/10 F1 F4



PASTA PP OF GRAMPO TRILHO FUME 10X1
 Código: 46216 Fábrica: ACP Unidade: PT/10 F1 F4



PASTA PP SANFONA A4 12 DIV AZUL 1027
 Código: 34127 Fábrica: ACP Unidade: UN/1 F1 F4



PASTA PP SANFONA A4 12 DIV CRISTAL 1027
 Código: 15847 Fábrica: ACP Unidade: UN/1 F1 F4



PASTA PP SANFONA A4 12 DIV FUME 1027
 Código: 8972 Fábrica: ACP Unidade: UN/1 F1 F4



PASTA PP SANFONA A4 12 DIV LILAS 1027

Código: 46170 Fábrica: ACP Unidade: UN/1
F1 F4



PASTA PP SANFONA A4 31 DIV FUME 1045

Código: 15856 Fábrica: ACP Unidade: UN/1
F1 F4



PASTA PP SANFONA CHEQUE 12 DIV CRISTAL

Código: 32383 Fábrica: ACP/POLIBRA Unidade: UN/1
F1 F4



PASTA PP SANFONA CHEQUE 31 DIV CRISTAL

Código: 8975 Fábrica: ACP Unidade: UN/1
F1 F4



PASTA PP SANFONA CHEQUE 31 DIV FUME

Código: 31610 Fábrica: ACP PLASCONY Unidade: UN/1
F1 F4

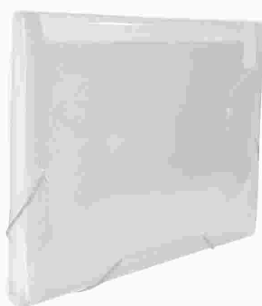

PASTA PP SANFONA DUPLIC 12 DIV CRISTAL

Código: 34122 Fábrica: ACP Unidade: UN/1
F1 F4

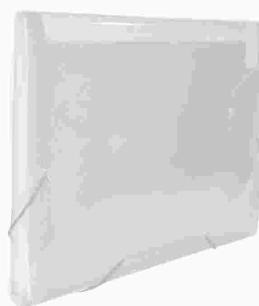

PASTA PP SANFONA DUPLIC 12 DIV FUME

Código: 46171 Fábrica: ACP Unidade: UN/1
F1 F4



PASTA PP SANFONA DUPLIC 31 DIV CRISTAL

Código: 8973 Fábrica: ACP Unidade: UN/1
F1 F4



PASTA PP SANFONA DUPLIC 31 DIV FUME

Código: 14352 Fábrica: ACP Unidade: UN/1
F1 F4



PASTA PP SANFONA OF 12 DIV CRISTAL

Código: 32395 Fábrica: ACP Unidade: UN/1
F1 F4



PASTA PP SANFONADA A4 12 DIV CRISTAL 6X1

Código: 42013 Fábrica: PLASCONY Unidade: CX/4
F1 F4

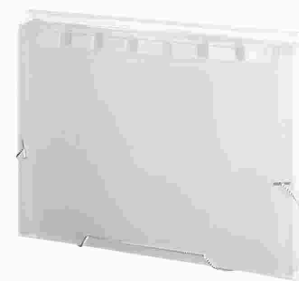

PASTA PP SANFONADA A4 31 DIV CRISTAL 4X1

Código: 42883 Fábrica: PLASCONY Unidade: CX/4
F1 F4

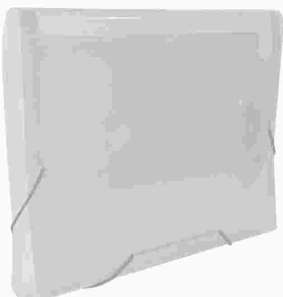

PASTA PP SANFONADA SLIM 31 DIV CRIS 4X1

Código: 42009 Fábrica: PLASCONY Unidade: CX/4
F1 F4



PASTA PP SANFONADA SLIM 31 DIV FUME 4X1

Código: 42010 Fábrica: PLASCONY Unidade: CX/4
F1 F4



PASTA PP SANFONADA 1/2 OF 12 DIV CRI 6X1

Código: 42012 Fábrica: PLASCONY Unidade: CX/6
F1 F4

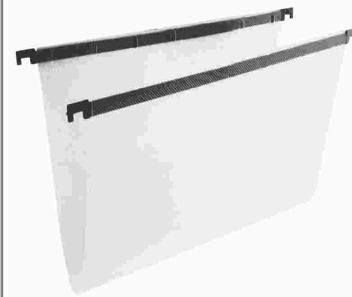

PASTA PP SUSPensa TRANSP CRISTAL 155 5X1

Código: 9017 Fábrica: ACP Unidade: PT/5
F1 F4



PASTA PP 1/2 OF AZUL OPACA 10X1

Código: **30443** Fábrica: **SUPER LINE** Unidade: **PT/10 F1 F4**

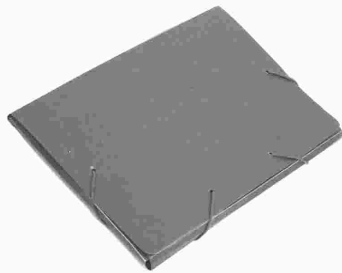

PASTA PP 1/2 OF CINZA OPACA 10X1

Código: **30441** Fábrica: **SUPER LINE** Unidade: **PT/10 F1 F4**

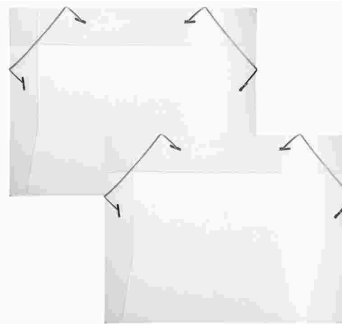

PASTA PP 1/2 OF CRISTAL 10X1

Código: **3066** Fábrica: **ALAPLAST** Unidade: **PT/10 F1 F4**

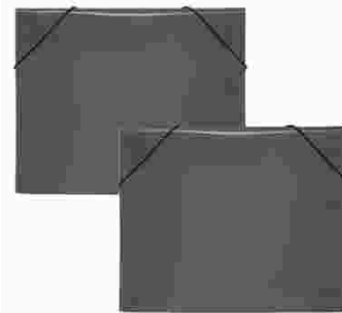

PASTA PP 1/2 OF FUME 10X1

Código: **9755** Fábrica: **ALAPLAST** Unidade: **PT/10 F1 F4**



PASTA PP 1/2 OF LARANJA OPACA 10X1

Código: **12596** Fábrica: **SUPER LINE** Unidade: **PT/10 F1 F4**



PASTA PP 1/2 OF PRETO OPACA 10X1

Código: **30442** Fábrica: **SUPER LINE** Unidade: **PT/10 F1 F4**

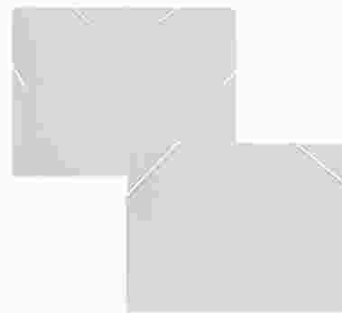

PASTA PP 1/2 OF SORTIDO 10X1

Código: **30446** Fábrica: **ALAPLAST** Unidade: **PT/10 F1 F4**



PASTA PP 1/2 OF VERDE CIT OPACA 10X1

Código: **30493** Fábrica: **SUPER LINE** Unidade: **PT/10 F1 F4**



PASTA PP 1/2 OF VERMELHO 10X1

Código: **19480** Fábrica: **SUPER LINE** Unidade: **PT/10 F1 F4**



PASTA PP 1/2 OF 2 CM AZUL OPACA 10X1

Código: **27749** Fábrica: **SUPER LINE** Unidade: **PT/10 F1 F4**

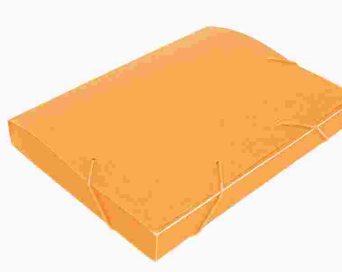

PASTA PP 1/2 OF 2 CM LARANJA OPACA 10X1

Código: **27745** Fábrica: **SUPER LINE** Unidade: **PT/10 F1 F4**



PASTA PP 1/2 OF 2 CM LILAS OPACA 10X1

Código: **27746** Fábrica: **SUPER LINE** Unidade: **PT/10 F1 F4**



PASTA PP 1/2 OF 2 CM LILAS 10X1

Código: **8936** Fábrica: **ALAPLAST** Unidade: **PT/10 F1 F4**



PASTA PP 1/2 OF 2 CM ROSA OPACA 10X1

Código: **27748** Fábrica: **SUPER LINE** Unidade: **PT/10 F1 F4**



PASTA PP 1/2 OF 2 CM ROSA 10X1

Código: **43844** Fábrica: **ALAPLAST** Unidade: **PT/10 F1 F4**

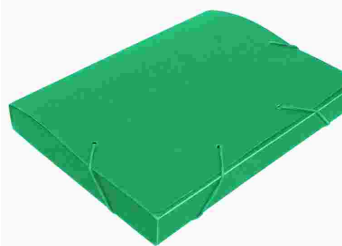

PASTA PP 1/2 OF 2 CM VERDE OPACA 10X1

Código: **30491** Fábrica: **SUPER LINE** Unidade: **PT/10 F1 F4**



PASTA PP 1/2 OF 2 CM VERDE 10X1

Código: **43845** Fábrica: **ALAPLAST** Unidade: **PT/10 F1 F4**



PASTA PP 1/2 OF 2 CM VERMELHO OPACA 10X1

Código: **27753** Fábrica: **SUPER LINE** Unidade: **PT/10 F1 F4**

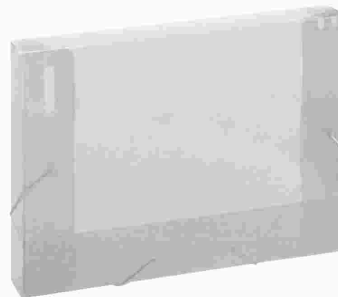

PASTA PP 1,7 CM CRISTAL TRANSP 10X1

Código: **46074** Fábrica: **ALAPLAST** Unidade: **PT/10 F1 F4**

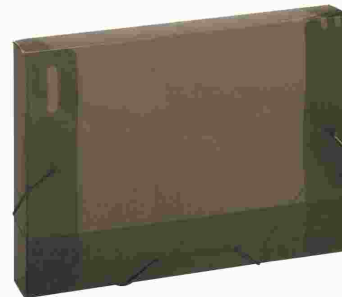

PASTA PP 1,7 CM FUME TRANSP 10X1

Código: **46075** Fábrica: **ALAPLAST** Unidade: **PT/10 F1 F4**

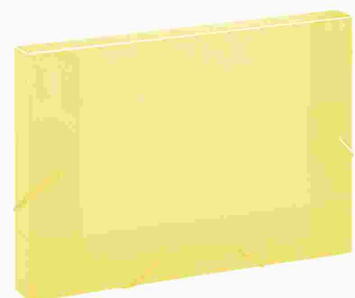

PASTA PP 2 CM AMARELA 10X1

Código: **15872** Fábrica: **ALAPLAST** Unidade: **PT/10 F1 F4**

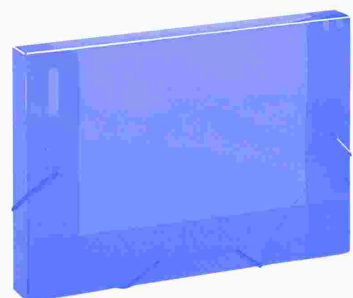

PASTA PP 2 CM AZUL 1022 10X1

Código: **15875** Fábrica: **ACP** Unidade: **PT/10 F1 F4**

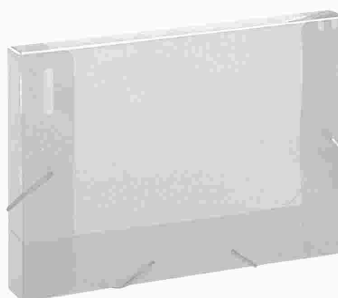

PASTA PP 2 CM CRISTAL 1022 10X1

Código: **9761** Fábrica: **ACP** Unidade: **PT/10 F1 F4**

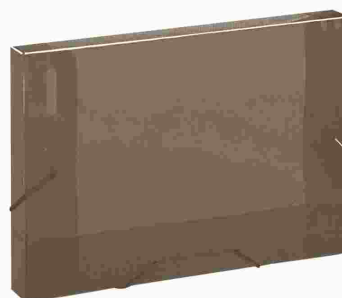

PASTA PP 2 CM FUME 1022 10X1

Código: **9763** Fábrica: **ACP/ALAPLAST** Unidade: **PT/10 F1 F4**

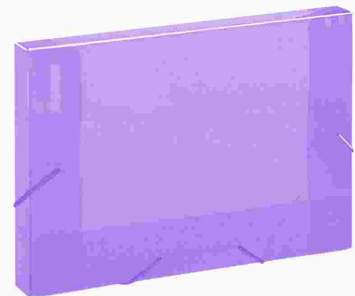

PASTA PP 2 CM LILAS 10X1

Código: **42935** Fábrica: **ALAPLAST** Unidade: **PT/10 F1 F4**

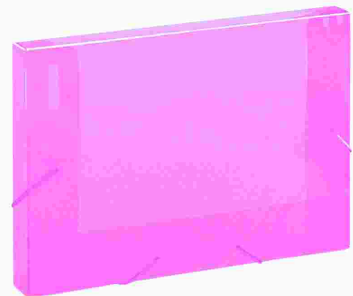

PASTA PP 2 CM ROSA 1022 10X1

Código: **19481** Fábrica: **ACP** Unidade: **PT/10 F1 F4**

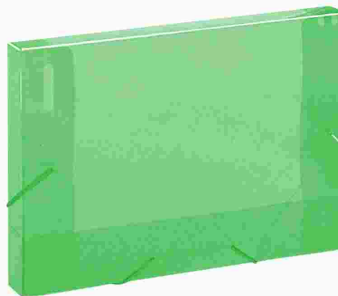

PASTA PP 2 CM VERDE 10X1

Código: **9762** Fábrica: **ALAPLAST** Unidade: **PT/10 F1 F4**

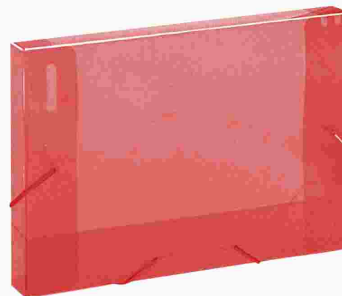

PASTA PP 2 CM VERMELHA 1022 10X1

Código: **9765** Fábrica: **ACP/ALA** Unidade: **PT/10 F1 F4**

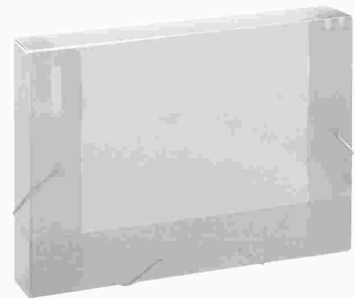

PASTA PP 3 CM CRISTAL TRANSP 10X1

Código: **14355** Fábrica: **ALAPLAST** Unidade: **PT/10 F1 F4**

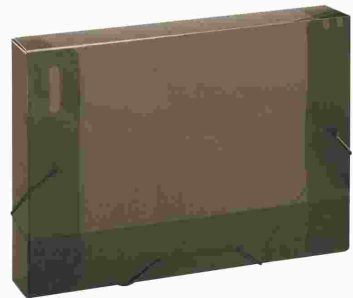

PASTA PP 3 CM FUME TRANSP 10X1

Código: **14356** Fábrica: **ALAPLAST** Unidade: **PT/10 F1 F4**



PASTA PP 4 CM PRETA 10X1

Código: **15865** Fábrica: **ALAPLAST** Unidade: **PT/10 F1 F4**



PASTA PP 4 CM AMARELO 10X1

Código: **15863** Fábrica: **ALAPLAST** Unidade: **PT/10 F1 F4**



PASTA PP 4 CM AZUL 1024 10X1

Código: **15885** Fábrica: **ACP/ALAPLAST** Unidade: **PT/10 F1 F4**

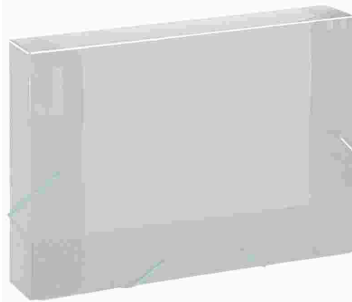

PASTA PP 4 CM CRISTAL TRANSP 10X1

Código: **9768** Fábrica: **ALAPLAST** Unidade: **PT/10 F1 F4**

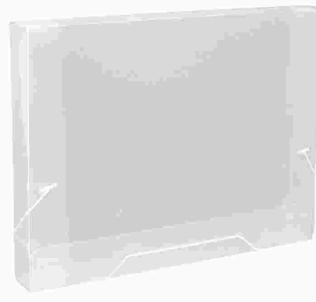

PASTA PP 4 CM CRISTAL 1024 10X1

Código: **15886** Fábrica: **ACP** Unidade: **PT/10 F1 F4**

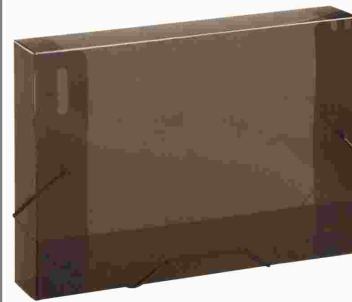

PASTA PP 4 CM FUME TRANSP 10X1

Código: **34124** Fábrica: **ALAPLAST** Unidade: **PT/10 F1 F4**

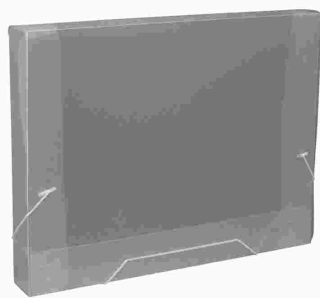

PASTA PP 4 CM FUME 1024 10X1

Código: **15889** Fábrica: **ACP** Unidade: **PT/10 F1 F4**



PASTA PP 4 CM LARANJA 10X1

Código: **42067** Fábrica: **ALAPLAST** Unidade: **PT/10 F1 F4**

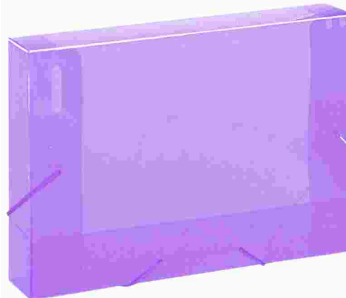

PASTA PP 4 CM LILAS 10X1

Código: **42039** Fábrica: **ALAPLAST** Unidade: **PT/10 F1 F4**

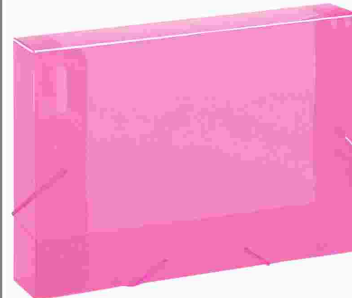

PASTA PP 4 CM ROSA 1024 10X1

Código: **41946** Fábrica: **ACP** Unidade: **PT/10 F1 F4**

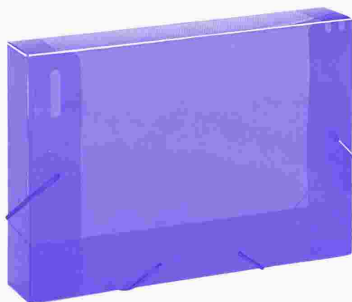

PASTA PP 4 CM ROXO 10X1

Código: **41985** Fábrica: **ALAPLAST** Unidade: **PT/10 F1 F4**

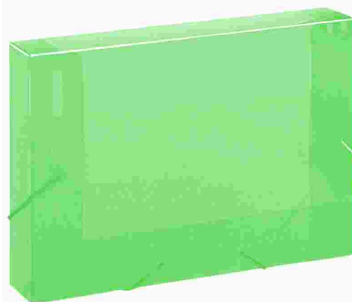

PASTA PP 4 CM VERDE 10X1

Código: **15867** Fábrica: **ALAPLAST** Unidade: **PT/10 F1 F4**

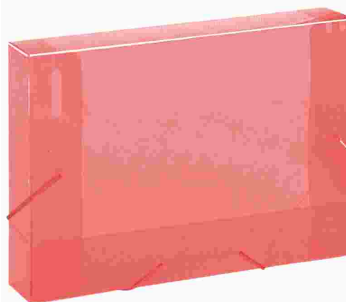

PASTA PP 4 CM VERMELHO 1024 10X1

Código: **15868** Fábrica: **ACP** Unidade: **PT/10 F1 F4**

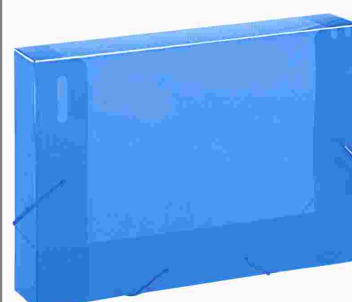

PASTA PP 5,5 CM UN

Código: **14358** Fábrica: **VMP** Unidade: **UN/1 F1 F4**

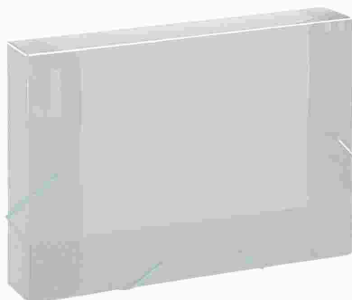

PASTA PP 5,5 CM CRISTAL TRANS 10X1

Código: **34123** Fábrica: **ALAPLAST** Unidade: **PT/10 F1 F4**

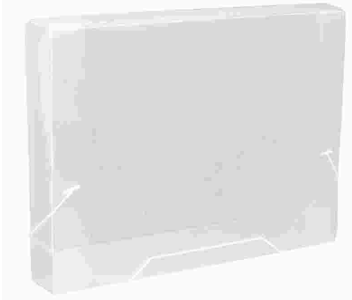

PASTA PP 5,5 CM CRISTAL 1025 10X1

Código: **46205** Fábrica: **ACP** Unidade: **PT/10 F1 F4**

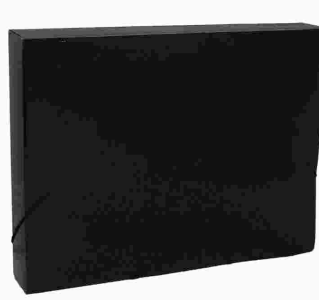

PASTA PP 5,5 CM FUME TRANSP 10X1

Código: **44331** Fábrica: **ALAPLAST** Unidade: **PT/10 F1 F4**

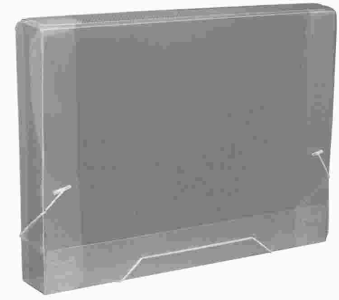

PASTA PP 5,5 CM FUME 1025 10X1

Código: **46206** Fábrica: **ACP** Unidade: **PT/10 F1 F4**



PASTA PP 6 CM CRISTAL 10X1

Código: **30434** Fábrica: **ALAPLAST** Unidade: **PT/10**
F1 F4



PASTA SANFONA PAPELAO OFIC A-Z

Código: **45963** Fábrica: **DELUCAS** Unidade: **UN/1**
F1 F4



PASTA SUSPENSA HT PVC KRAFT KC 50X1

Código: **18085** Fábrica: **TP PASTAS** Unidade: **CX/50**
F1 F4



PASTA SUSPENSA HT PVC MARM CAST MC 50X1

Código: **44636** Fábrica: **TP PASTAS** Unidade: **CX/50**
F1 F4



PASTA SUSPENSA HT PVC MARM PL CAST 50X1

Código: **42854** Fábrica: **DELLO/TPPAST** Unidade: **CX/50**
F1 F4



PASTA SUSPENSA KRAFT NATURAL 25X1

Código: **37444** Fábrica: **ACRIMET** Unidade: **PT/25**
F1 F4



PASTA SUSPENSA MARM HT PLAST 10X1

Código: **51133** Fábrica: **POLYCART** Unidade: **PT/10**
F1 F4



PASTA SUSPENSA MARM LISA HT PLAST 10X1

Código: **27075** Fábrica: **POLYCART** Unidade: **PT/10**
F1 F4



PASTA SUSPENSA MARM PLAST HT PLAST 10X1

Código: **49996** Fábrica: **POLYCART** Unidade: **PT/10**
F1 F4



PASTA SUSPENSA MARM PLAST HT PLAST 10X1

Código: **51131** Fábrica: **POLYCART** Unidade: **PT/10**
F1 F4



PASTA SUSPENSA MARM PLAST HT PLAST 10X1

Código: **51135** Fábrica: **POLYCART** Unidade: **PT/10**
F1 F4



PASTA SUSPENSA MARM PLAST HT PVC 25X1

Código: **47804** Fábrica: **POLYCART** Unidade: **PT/25**
F1 F4



PASTA SUSPENSA MARM S KRAF HT PLAST 50X1

Código: **49995** Fábrica: **POLYCART** Unidade: **PT/50**
F1 F4



PASTA SUSPENSA MARM S KRAF HT PLAST 50X1

Código: **51132** Fábrica: **POLYCART** Unidade: **PT/50**
F1 F4



PASTA SUSPENSA MARMORE GRAMPO METAL 10X1

Código: **44447** Fábrica: **POLYCART** Unidade: **PT/10**
F1 F4



PASTA SUSPENSA MARMORIZADA UN

Código: **42141** Fábrica: **TP** Unidade: **UN/1**
F1 F4



PEN DRIVE 4 GB USB 2.0
 Código: **20790** Fábrica: **MULTILASER** Unidade: **UN/1 F1 F4**



PEN DRIVE 8 GB USB 2.0
 Código: **25947** Fábrica: **INOVA** Unidade: **UN/1 F1 F4**



PEN DRIVE 16 GB USB 2.0
 Código: **35870** Fábrica: **MAKETECH** Unidade: **UN/1 F1 F4**



PEN DRIVE 32 GB USB 2.0
 Código: **35871** Fábrica: **MAKETECH** Unidade: **UN/1 F1 F4**



PEN DRIVE 64 GB USB 2.0 METAL DIAMOND
 Código: **42432** Fábrica: **MULTILASER** Unidade: **UN/1 F1 F4**



PEN DRIVE 128 GB USB 2.0
 Código: **42430** Fábrica: **MULTILASER** Unidade: **UN/1 F1 F4**



PERCEVEJO LATONADO DOURADO 96036 100X1
 Código: **40974** Fábrica: **JOCAROFFICE** Unidade: **CX/100 F1 F4**



PERCEVEJO LATONADO 100X1
 Código: **13243** Fábrica: **BRW** Unidade: **CE/100 F1 F4**



PERFURADOR METAL FURO UNICO 6MM 6FLS 804
 Código: **39779** Fábrica: **MASTERPRINT** Unidade: **CR/1 F1 F4**



PERFURADOR METAL MED 2 FUROS 20FLS 2000
 Código: **14670** Fábrica: **BRW/EASYOFFI** Unidade: **UN/1 F1 F4**



PERFURADOR METAL PQ 2 FUROS 5FLS 808
 Código: **41950** Fábrica: **YING FA** Unidade: **UN/1 F1 F4**



PERFURADOR METAL 2 FUROS 10FLS V082
 Código: **39925** Fábrica: **VMP** Unidade: **UN/1 F1 F4**



PERFURADOR METAL 2 FUROS 10FLS 7131
 Código: **46942** Fábrica: **YIN'S PAPER** Unidade: **UN/1 F1 F4**



PERFURADOR METAL 2 FUROS 100FLS GUIA 91
 Código: **46921** Fábrica: **YIN'S PAPER** Unidade: **UN/1 F1 F4**



PERFURADOR METAL 2 FUROS 20FLS 801
 Código: **39783** Fábrica: **MASTERPRINT** Unidade: **UN/1 F1 F4**



PERFURADOR METAL 2 FUROS 25FLS C/GUIA
 Código: **46431** Fábrica: **KAZ** Unidade: **UN/1 F1 F4**



PERFURADOR METAL 2 FUROS 25FLS GUIA 790
 Código: 46928 Fábrica: YIN'S PAPER Unidade: UN/1
 F1 F4



PERFURADOR METAL 2 FUROS 35FLS C/GUIA
 Código: 6565 Fábrica: BRW Unidade: UN/1
 F1 F4



PERFURADOR METAL 2 FUROS 35FLS 083
 Código: 42408 Fábrica: VMP Unidade: UN/1
 F1 F4



PERFURADOR METAL 2 FUROS 40FLS 802
 Código: 41957 Fábrica: MASTERPRINT Unidade: UN/1
 F1 F4



PERFURADOR METAL 2 FUROS 50 FLS 93022
 Código: 46368 Fábrica: JOCAROFFICE Unidade: UN/1
 F1 F4



PERFURADOR METAL 2 FUROS 60FL GDE C/GUIA
 Código: 42235 Fábrica: MASTERPRINT Unidade: UN/1
 F1 F4



PERFURADOR METAL 2 FUROS 60FLS BM2149
 Código: 48851 Fábrica: FIRST Unidade: UN/1
 F1 F4



PERFURADOR METAL 2 FUROS 70FLS 282205
 Código: 43019 Fábrica: FUTURO Unidade: UN/1
 F1 F4

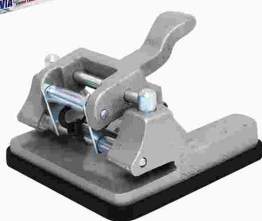

PERFURADOR PAPEL 2 FUROS 30FLS FUNDIDO
 Código: 42328 Fábrica: CAVIA Unidade: UN/1
 F1 F4



PERFURADOR PAPEL 2 FUROS 60FLS FUNDIDO
 Código: 42466 Fábrica: CAVIA Unidade: UN/1
 F1 F4



PERFURADOR PAPEL 2 FUROS 100FLS FUNDIDO
 Código: 42318 Fábrica: CAVIA Unidade: UN/1
 F1 F4



PERFURADOR PLAST P/EVA EXTRA GIGANTE
 Código: 48579 Fábrica: RENK Unidade: UN/1
 F1 F4



PERFURADOR PLAST P/EVA PEQ FIGURAS SORT
 Código: 41973 Fábrica: VMP Unidade: UN/1
 F1 F4



PERFURADOR PLAST P/EVA 16MM 8438
 Código: 48139 Fábrica: YIN'S PAPER Unidade: UN/1
 F1 F4



PERFURADOR PLAST P/EVA 25MM 8439
 Código: 46929 Fábrica: YIN'S PAPER Unidade: UN/1
 F1 F4



PERFURADOR PLAST P/EVA 38MM 12052
 Código: 51005 Fábrica: MAKE+ Unidade: UN/1
 F1 F4



PERFURADOR PLAST P/EVA 50MM 8440

Código: 46930
 Fábrica: YIN'S/MAKE
 Unidade: UN/1
 F1 F4

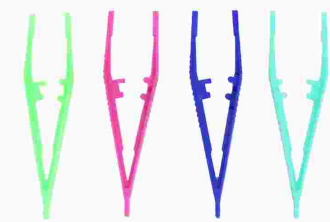

PINÇA PLAST COORDENACAO MOTORA 10,5X1X3C

Código: 44114
 Fábrica: PAPIMUNI
 Unidade: UN/1
 F1 F4



PINCEL ARTIS CHANF LONG AMA 18 C517 6X1

Código: 50970
 Fábrica: CASTELO
 Unidade: PT/6
 F1 F4



PINCEL ARTIS LEQUE LONG AMA 04 C513 6X1

Código: 50971
 Fábrica: CASTELO
 Unidade: PT/6
 F1 F4



PINCEL ARTIS LEQUE LONG AMA 06 C513 6X1

Código: 50972
 Fábrica: CASTELO
 Unidade: PT/6
 F1 F4



PINCEL ARTIS RED LONG AMA 6 87891 12X1

Código: 45480
 Fábrica: CONDOR
 Unidade: PT/12
 F1 F4



PINCEL ARTIS RED LONG AMA 8 970927 12X1

Código: 45481
 Fábrica: CONDOR
 Unidade: PT/12
 F1 F4



PINCEL ARTIS RED LONG AMA 10 970928 12X1

Código: 45482
 Fábrica: CONDOR
 Unidade: PT/12
 F1 F4



PINCEL ARTIS RED LONG AMA 12 970929 12X1

Código: 45483
 Fábrica: CONDOR
 Unidade: PT/12
 F1 F4



PINCEL ARTIS RED LONG AMA 18 970932 12X1

Código: 45484
 Fábrica: CONDOR
 Unidade: PT/12
 F1 F4



PINCEL ARTIS RED LONG AMA 24 970935 6X1

Código: 51042
 Fábrica: CONDOR
 Unidade: PT/6
 F1 F4



PINCEL ARTIST LINGUA GATO 2 88669 12X1

Código: 42901
 Fábrica: CONDOR
 Unidade: PT/12
 F1 F4



PINCEL ARTIST LINGUA GATO 6 88671 12X1

Código: 42900
 Fábrica: CONDOR
 Unidade: PT/12
 F1 F4



PINCEL ARTIST P/PINTURA 0 86836 12X1

Código: 45449
 Fábrica: CONDOR
 Unidade: PT/12
 F1 F4



PINCEL ARTIST P/PINTURA 00 86837 12X1

Código: 45450
 Fábrica: CONDOR
 Unidade: PT/12
 F1 F4



PINCEL ARTIST P/PINTURA 000 86838 12X1

Código: 45451
 Fábrica: CONDOR
 Unidade: PT/12
 F1 F4



PINCEL AT BOLD REC QUAD BCO AZU 679 12X1
 Código: 42965 Fábrica: GOLLER Unidade: DZ/12 F1 F4



PINCEL AT BOLD REC QUAD BCO PT 6080 12X1
 Código: 42964 Fábrica: GOLLER Unidade: DZ/12 F1 F4



PINCEL AT COMPACTOR AZUL 12X1
 Código: 2570 Fábrica: COMPACTOR Unidade: DZ/12 F1 F4



PINCEL AT COMPACTOR PRETO 12X1
 Código: 3275 Fábrica: COMPACTOR Unidade: DZ/12 F1 F4



PINCEL AT COMPACTOR SORTIDO 12X1
 Código: 3819 Fábrica: COMPACTOR Unidade: DZ/12 F1 F4



PINCEL AT COMPACTOR SORTIDO 24X1
 Código: 48157 Fábrica: COMPACTOR Unidade: CR/24 F1 F4



PINCEL AT COMPACTOR VERMELHO 12X1
 Código: 3276 Fábrica: COMPACTOR Unidade: DZ/12 F1 F4



PINCEL AT COMPACTOR 6 CORES SORT
 Código: 40911 Fábrica: COMPACTOR Unidade: UN/1 F1 F4



PINCEL AT MARC PERM AZUL 2116 10X1
 Código: 49774 Fábrica: FIRST Unidade: CX/10 F1 F4



PINCEL AT MARC PERM DESTAQ AMARELO 12X1
 Código: 48161 Fábrica: COMPACTOR Unidade: CX/12 F1 F4



PINCEL AT MARC PERM DESTAQ AZUL 12X1
 Código: 48158 Fábrica: COMPACTOR Unidade: CX/12 F1 F4



PINCEL AT MARC PERM DESTAQ LARANJA 12X1
 Código: 48165 Fábrica: COMPACTOR Unidade: CX/12 F1 F4



PINCEL AT MARC PERM DESTAQ MAGE 12X1
 Código: 48164 Fábrica: COMPACTOR Unidade: CX/12 F1 F4



PINCEL AT MARC PERM DESTAQ MARROM 12X1
 Código: 48163 Fábrica: COMPACTOR Unidade: CX/12 F1 F4



PINCEL AT MARC PERM DESTAQ ROSA 12X1
 Código: 48166 Fábrica: COMPACTOR Unidade: CX/12 F1 F4



PINCEL AT MARC PERM DESTAQ VERDE 12X1
 Código: 48162 Fábrica: COMPACTOR Unidade: CX/12 F1 F4



PINCEL AT MARC PERM DESTAQ VERMEL 12X1
 Código: 48160 Fábrica: COMPACTOR Unidade: CX/12 F1 F4



PINCEL AT MARC PERM PRETO 2115 10X1
 Código: 49776 Fábrica: FIRST Unidade: CX/10 F1 F4



PINCEL AT MARC PERM REC AZUL 12X1
 Código: 35996 Fábrica: COMPACTOR Unidade: CX/12 F1 F4



PINCEL AT MARC PERM REC AZUL 616 12X1
 Código: 39788 Fábrica: MASTERPRINT Unidade: DZ/12 F1 F4



PINCEL AT MARC PERM REC AZUL 7011 12X1
 Código: 40915 Fábrica: BRW Unidade: DZ/12 F1 F4



PINCEL AT MARC PERM REC PRETO 12X1
 Código: 35997 Fábrica: COMPACTOR Unidade: CX/12 F1 F4



PINCEL AT MARC PERM REC VERDE 12X1
 Código: 48153 Fábrica: COMPACTOR Unidade: DZ/12 F1 F4



PINCEL AT MARC PERM REC VERDE 616 12X1
 Código: 42892 Fábrica: MASTERPRINT Unidade: DZ/12 F1 F4



PINCEL AT MARC PERM REC VERMEL 616 12X1
 Código: 39790 Fábrica: MASTERPRINT Unidade: DZ/12 F1 F4



PINCEL AT MARC PERM SLIM AZUL 615 12X1
 Código: 51059 Fábrica: MASTERPRINT Unidade: DZ/12 F1 F4



PINCEL AT MARC PERM SLIM PRETO 615 12X1
 Código: 51058 Fábrica: MASTERPRINT Unidade: DZ/12 F1 F4



PINCEL AT MARC PERM VERMELHO 2117 10X1
 Código: 49775 Fábrica: FIRST Unidade: CX/10 F1 F4



PINCEL AT MARC PERM VERMELHO 616 12X1
 Código: 39787 Fábrica: MASTERPRINT Unidade: DZ/12 F1 F4



PINCEL AT MARC QUAD BCO AZU REC 601 12X1
 Código: 37651 Fábrica: BRW Unidade: DZ/12 F1 F4



PINCEL AT MARC QUAD BCO AZUL BM2112 12X1
 Código: 48844 Fábrica: FIRST Unidade: UN/1 F1 F4



PINCEL AT MARC QUAD BCO AZUL REC RF 10X1
 Código: 48181 Fábrica: JOCAROFFICE Unidade: CX/10 F1 F4



PINCEL AT MARC QUAD BCO AZUL REC 12X1
 Código: 51015 Fábrica: JOCAROFFICE Unidade: CX/12 F1 F4



PINCEL AT MARC QUAD BCO AZUL REC 12X1
 Código: 40913 Fábrica: COMPACTOR Unidade: DZ/12 F1 F4



PINCEL AT MARC QUAD BCO AZUL 3001 12X1
 Código: 9909 Fábrica: BRW Unidade: DZ/12 F1 F4



PINCEL AT MARC QUAD BCO AZUL 5981 12X1
 Código: 40679 Fábrica: GOLLER Unidade: DZ/12 F1 F4



PINCEL AT MARC QUAD BCO AZUL 80003 12X1
 Código: 48211 Fábrica: EXPO TANK Unidade: CX/12 F1 F4



PINCEL AT MARC QUAD BCO AZUL 96020 12X1
 Código: 48179 Fábrica: JOCAROFFICE Unidade: DZ/12 F1 F4



PINCEL AT MARC QUAD BCO COLORS 4X1
 Código: 47391 Fábrica: JOCAROFFICE Unidade: CJ/4 F1 F4



PINCEL AT MARC QUAD BCO PRET REC RF 10X1
 Código: 48182 Fábrica: JOCAROFFICE Unidade: CX/10 F1 F4



PINCEL AT MARC QUAD BCO PRETO 12X1
 Código: 9910 Fábrica: BRW Unidade: DZ/12 F1 F4



PINCEL AT MARC QUAD BCO PRETO 2113 12X1
 Código: 48845 Fábrica: FIRST Unidade: UN/1 F1 F4



PINCEL AT MARC QUAD BCO PRETO 80001 12X1
 Código: 48212 Fábrica: EXPO TANK Unidade: CX/12 F1 F4



PINCEL AT MARC QUAD BCO PRETO 96019 12X1
 Código: 48180 Fábrica: JOCAROFFICE Unidade: DZ/12 F1 F4



PINCEL AT MARC QUAD BCO ROSA 12X1
 Código: 48565 Fábrica: NEWPEN Unidade: DZ/12 F1 F4



PINCEL AT MARC QUAD BCO VERDE 12X1
 Código: 43800 Fábrica: BRW Unidade: DZ/12 F1 F4



PINCEL AT MARC QUAD BCO VERM BM2114 12X1
 Código: 48846 Fábrica: FIRST Unidade: UN/1 F1 F4



PINCEL AT MARC QUAD BCO VERM REC10X1
 Código: 48183 Fábrica: JOCAROFFICE Unidade: CX/10 F1 F4



PINCEL AT MARC QUAD BCO VERM 80002 12X1
 Código: 48213 Fábrica: EXPO TANK Unidade: CX/12 F1 F4



PINCEL AT MARC QUAD BCO VERMELHO 12X1
 Código: 48566 Fábrica: NEWPEN Unidade: DZ/12 F1 F4



PINCEL AT QUAD BCO CARTUCH REC AZUL 12X1
 Código: 45216 Fábrica: BRW Unidade: DZ/12 F1 F4



PINCEL AT QUAD BCO CARTUCH REC VERM 12X1
 Código: 45218 Fábrica: BRW Unidade: DZ/12 F1 F4



PINCEL AT QUAD BCO CARTUCHO REC PTO 12X1
 Código: 45217 Fábrica: BRW Unidade: DZ/12 F1 F4



PINCEL AT QUAD BCO REC AZUL 619 12X1
 Código: 43231 Fábrica: MASTERPRINT Unidade: DZ/12 F1 F4



PINCEL AT QUAD BCO REC PRETO 619 12X1
 Código: 43233 Fábrica: MASTERPRINT Unidade: DZ/12 F1 F4



PINCEL AT QUAD BCO REC VERDE 619 12X1
 Código: 42890 Fábrica: MASTERPRINT Unidade: DZ/12 F1 F4



PINCEL AT QUAD BCO REC VERMELHO 619 12X1
 Código: 43232 Fábrica: MASTERPRINT Unidade: DZ/12 F1 F4



PINCEL ESC CHAT AMAR 0 7164 12X1
 Código: 33840 Fábrica: GOLLER Unidade: CR/12 F1 F4



PINCEL ESC CHAT AMAR 0 98733 12X1
 Código: 42895 Fábrica: CONDOR Unidade: PT/12 F1 F4



PINCEL ESC CHAT AMAR 20 98743 12X1
 Código: 42898 Fábrica: CONDOR Unidade: PT/12 F1 F4



PINCEL ESC CHAT AMAR 22 4169 6X1
 Código: 33846 Fábrica: LEO&LEO/GOLL Unidade: CR/6 F1 F4



PINCEL ESC CHAT AMAR 24 98745 6X1
 Código: 42899 Fábrica: CONDOR Unidade: PT/6 F1 F4



PINCEL ESC CHAT CURTO AMAR 0 4263 12X1
 Código: 48943 Fábrica: LEO&LEO Unidade: CR/12 F1 F4



PINCEL ESC CHAT CURTO AMAR 2 88221 12X1
 Código: 45470 Fábrica: CONDOR Unidade: PT/12 F1 F4



PINCEL ESC CHAT CURTO AMAR 4 88222 12X1
 Código: 45471 Fábrica: CONDOR Unidade: PT/12
 F1 F4



PINCEL ESC CHAT CURTO AMAR 02 4264 12X1
 Código: 48944 Fábrica: LEO&LEO Unidade: CR/12
 F1 F4



PINCEL ESC CHAT CURTO AMAR 04 4265 12X1
 Código: 43286 Fábrica: LEO&LEO Unidade: CR/12
 F1 F4



PINCEL ESC CHAT CURTO AMAR 06 4266 12X1
 Código: 43285 Fábrica: LEO&LEO Unidade: CR/12
 F1 F4



PINCEL ESC CHAT CURTO AMAR 10 4341 12X1
 Código: 43287 Fábrica: LEO&LEO Unidade: CR/12
 F1 F4



PINCEL ESC CHAT CURTO AMAR 14 4344 12X1
 Código: 48947 Fábrica: LEO&LEO Unidade: CR/12
 F1 F4



PINCEL ESC CHAT CURTO AMAR 14 88227 12X1
 Código: 45476 Fábrica: CONDOR Unidade: PT/12
 F1 F4



PINCEL ESC CHAT CURTO AMAR 16 4267 12X1
 Código: 49135 Fábrica: LEO&LEO Unidade: CR/12
 F1 F4



PINCEL ESC CHAT CURTO AMAR 16 90695 12X1
 Código: 45477 Fábrica: CONDOR Unidade: PT/12
 F1 F4



PINCEL ESC CHAT CURTO AMAR 18 4268 12X1
 Código: 48948 Fábrica: LEO&LEO Unidade: CR/12
 F1 F4



PINCEL ESC CHAT CURTO AMAR 18 90696 12X1
 Código: 45478 Fábrica: CONDOR Unidade: PT/12
 F1 F4



PINCEL ESC CHAT CURTO AMAR 20 4269 12X1
 Código: 48949 Fábrica: LEO&LEO Unidade: CR/12
 F1 F4



PINCEL ESC CHAT LONGO AMAR 2 98734 12X1
 Código: 42894 Fábrica: CONDOR Unidade: PT/12
 F1 F4



PINCEL ESC CHAT LONGO AMAR 02 4211 12X1
 Código: 41709 Fábrica: LEO&LEO Unidade: CR/12
 F1 F4



PINCEL ESC CHAT LONGO AMAR 036 12
 Código: 37899 Fábrica: LYKE Unidade: UN/1
 F1 F4



PINCEL ESC CHAT LONGO AMAR 04 4212 12X1
 Código: 31820 Fábrica: LEO&LEO Unidade: CR/12
 F1 F4



PINCEL ESC CHAT LONGO AMAR 06 4213 12X1
 Código: 31821 Fábrica: LEO&LEO Unidade: CR/12
 F1 F4



PINCEL ESC CHAT LONGO AMAR 08 4214 12X1
 Código: 42586 Fábrica: LEO&LEO Unidade: CR/12
 F1 F4



PINCEL ESC CHAT LONGO AMAR 10 37898
 Código: 37898 Fábrica: LYKE Unidade: UN/1
 F1 F4



PINCEL ESC CHAT LONGO AMAR 10 4215 12X1
 Código: 42588 Fábrica: LEO&LEO Unidade: CR/12
 F1 F4



PINCEL ESC CHAT LONGO AMAR 10 98738 12X1
 Código: 43364 Fábrica: CONDOR Unidade: PT/12
 F1 F4



PINCEL ESC CHAT LONGO AMAR 12 4216 12X1
 Código: 41710 Fábrica: LEO&LEO Unidade: CR/12
 F1 F4



PINCEL ESC CHAT LONGO AMAR 12 98739 12X1
 Código: 43260 Fábrica: CONDOR Unidade: PT/12
 F1 F4



PINCEL ESC CHAT LONGO AMAR 14 4217 12X1
 Código: 31824 Fábrica: LEO&LEO Unidade: CR/12
 F1 F4



PINCEL ESC CHAT LONGO AMAR 14 98740 12X1
 Código: 43361 Fábrica: CONDOR Unidade: PT/12
 F1 F4



PINCEL ESC CHAT LONGO AMAR 16 4171 6X1
 Código: 42142 Fábrica: LEO&LEO Unidade: CR/6
 F1 F4



PINCEL ESC CHAT LONGO AMAR 16 98741 12X1
 Código: 43362 Fábrica: CONDOR Unidade: PT/12
 F1 F4



PINCEL ESC CHAT LONGO AMAR 18 4172 6X1
 Código: 41707 Fábrica: LEO&LEO Unidade: CR/6
 F1 F4



PINCEL ESC CHAT LONGO AMAR 20 4173 6X1
 Código: 41708 Fábrica: LEO&LEO Unidade: CR/6
 F1 F4



PINCEL ESC CHAT LONGO AMAR 24 4170 6X1
 Código: 33845 Fábrica: LEO&LEO Unidade: CR/6
 F1 F4



PINCEL ESC RED AMARELO 16 87896 12X1
 Código: 42896 Fábrica: CONDOR Unidade: PT/12
 F1 F4



PINCEL ESC RED AMARELO 20 87898 12X1
 Código: 42897 Fábrica: CONDOR Unidade: PT/12
 F1 F4



PINCEL ESC RED CURTO AMAR 0 4961 12X1
 Código: 42713 Fábrica: LEO&LEO Unidade: CR/12
 F1 F4



PINCEL ESC RED CURTO AMAR 0 88220 12X1
 Código: 45469 Fábrica: CONDOR Unidade: PT/12
 F1 F4



PINCEL ESC RED CURTO AMAR 00 4960 12X1
 Código: 20763 Fábrica: LEO&LEO Unidade: CR/12
 F1 F4



PINCEL ESC RED CURTO AMAR 02 4962 12X1
 Código: 23158 Fábrica: LEO&LEO Unidade: CR/12
 F1 F4



PINCEL ESC RED CURTO AMAR 04 4963 12X1
 Código: 42717 Fábrica: LEO&LEO Unidade: CR/12
 F1 F4



PINCEL ESC RED CURTO AMAR 06 4964 12X1
 Código: 41712 Fábrica: LEO&LEO Unidade: CR/12
 F1 F4



PINCEL ESC RED CURTO AMAR 08 4966 12X1
 Código: 24766 Fábrica: LEO&LEO Unidade: CR/12
 F1 F4



PINCEL ESC RED CURTO AMAR 10 4967 12X1
 Código: 48353 Fábrica: LEO&LEO Unidade: CR/12
 F1 F4



PINCEL ESC RED CURTO AMAR 12 4968 12X1
 Código: 48352 Fábrica: LEO&LEO Unidade: CR/12
 F1 F4



PINCEL ESC RED CURTO AMAR 16 4270 12X1
 Código: 48350 Fábrica: LEO&LEO Unidade: CR/12
 F1 F4



PINCEL ESC RED CURTO AMAR 18 4271 12X1
 Código: 46367 Fábrica: LEO&LEO Unidade: CR/12
 F1 F4



PINCEL ESC RED CURTO AMAR 20 4272 12X1
 Código: 42144 Fábrica: LEO&LEO Unidade: CR/12
 F1 F4



PINCEL ESC RED CURTO VERM 0 85275 12X1
 Código: 45452 Fábrica: CONDOR Unidade: PT/12
 F1 F4



PINCEL ESC RED CURTO VERM 2 85276 12X1
 Código: 45453 Fábrica: CONDOR Unidade: PT/12
 F1 F4



PINCEL ESC RED CURTO VERM 4 85277 12X1
 Código: 45454 Fábrica: CONDOR Unidade: PT/12
 F1 F4



PINCEL ESC RED CURTO VERM 6 85278 12X1
 Código: 45455 Fábrica: CONDOR Unidade: PT/12
 F1 F4



PINCEL ESC RED CURTO VERM 8 85279 12X1
 Código: 45456 Fábrica: CONDOR Unidade: PT/12
 F1 F4



PINCEL ESC RED CURTO VERM 10 85280 12X1
 Código: 45457 Fábrica: CONDOR Unidade: PT/12
 F1 F4



PINCEL ESC RED CURTO VERM 12 85281 12X1
 Código: 45458 Fábrica: CONDOR Unidade: PT/12
 F1 F4



PINCEL ESC RED CURTO VERM 14 85282 12X1
 Código: 45459 Fábrica: CONDOR Unidade: PT/12
 F1 F4



PINCEL ESC RED CURTO VERM 16 85283 12X1
 Código: 45460 Fábrica: CONDOR Unidade: PT/12
 F1 F4



PINCEL ESC RED CURTO VERM 18 85284 12X1
 Código: 45461 Fábrica: CONDOR Unidade: PT/12
 F1 F4



PINCEL ESC RED CURTO VERM 20 85285 12X1
 Código: 45462 Fábrica: CONDOR Unidade: PT/12
 F1 F4



PINCEL ESC RED CURTO VERM 22 85286 12X1
 Código: 45463 Fábrica: CONDOR Unidade: PT/12
 F1 F4



PINCEL ESC RED CURTO VERM 24 85287 12X1
 Código: 45464 Fábrica: CONDOR Unidade: PT/12
 F1 F4



PINCEL ESC RED LONGO AMAR 14 4969 12X1
 Código: 41711 Fábrica: LEO&LEO Unidade: CR/12
 F1 F4



PINCEL ESC RED MARROM 22 7188 12X1
 Código: 33838 Fábrica: GOLLER Unidade: CR/12
 F1 F4



PINCEL ESC RED MARROM 24 7189 12X1
 Código: 33839 Fábrica: GOLLER Unidade: CR/12
 F1 F4



PINCEL MARC PERM AZUL 3210 12X1
 Código: 48567 Fábrica: NEWPEN Unidade: DZ/12
 F1 F4



PINCEL MARC PERM MARROM 3217 12X1
 Código: 48571 Fábrica: NEWPEN Unidade: DZ/12
 F1 F4



PINCEL MARC PERM PRETO 3211 12X1
 Código: 48568 Fábrica: NEWPEN Unidade: DZ/12
 F1 F4



PINCEL MARC PERM REC AZUL 96070 12X1
 Código: 48184 Fábrica: JOCAROFFICE Unidade: DZ/12
 F1 F4



PINCEL MARC PERM REC PRETO 96071 12X1

Código: 48185
 Fábrica: JOCAROFFICE
 Unidade: DZ/12
 F1 F4



PINCEL MARC PERM REC VERMELHO 96072 12X1

Código: 48186
 Fábrica: JOCAROFFICE
 Unidade: DZ/12
 F1 F4



PINCEL MARC PERM TOP VERMELHO 4687 12X1

Código: 48195
 Fábrica: JOCAROFFICE
 Unidade: DZ/12
 F1 F4



PINCEL MARC PERM VERDE 3213 12X1

Código: 48570
 Fábrica: NEWPEN
 Unidade: DZ/12
 F1 F4



PINCEL MARC PERM VERMELHO 3212 12X1

Código: 48569
 Fábrica: NEWPEN
 Unidade: DZ/12
 F1 F4



PINCEL MARC PERM VIOLETA 3218 12X1

Código: 48572
 Fábrica: NEWPEN
 Unidade: DZ/12
 F1 F4

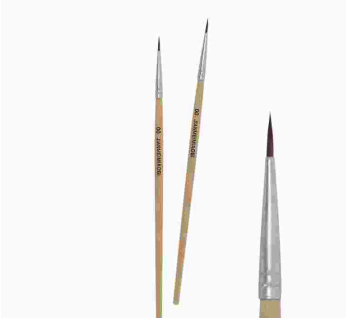

PINCEL P/PINTURA N00 UN

Código: 41943
 Fábrica: GOLLER
 Unidade: UN/1
 F1 F4



PINCEL P/PINTURA 1 1/2" 38MM 721

Código: 48686
 Fábrica: PLANETA
 Unidade: UN/1
 F1 F4



PINCEL P/PINTURA 1/2" 13MM 718

Código: 48683
 Fábrica: PLANETA
 Unidade: UN/1
 F1 F4



PINCEL P/PINTURA 2 1/2" 63MM 723

Código: 48687
 Fábrica: PLANETA
 Unidade: UN/1
 F1 F4



PINCEL P/PINTURA 3/4" 19MM 719

Código: 48684
 Fábrica: PLANETA
 Unidade: UN/1
 F1 F4



PIROGRAFO 5 PONTAS

Código: 47339
 Fábrica: WESTERN
 Unidade: UN/1
 F1 F4



PISTOLA COLA QUENTE BIV 20W PEQ 1001

Código: 23761
 Fábrica: HAIBRASI/FUT
 Unidade: UN/1
 F1 F4



PISTOLA COLA QUENTE BIV 10W PQ BOTAO OFF

Código: 42458
 Fábrica: GATTE
 Unidade: UN/1
 F1 F4



PISTOLA COLA QUENTE BIV 100W G BOTAO OFF

Código: 50223
 Fábrica: FUTURO
 Unidade: UN/1
 F1 F4



PISTOLA COLA QUENTE BIV 20W P BOTAO OFF

Código: 50224
 Fábrica: FUTURO
 Unidade: UN/1
 F1 F4



PISTOLA COLA QUENTE BIV 40W GD BOTAO OFF
 Código: Fábrica: Unidade:
46430 KAZ UN/1
F1 F4



PISTOLA COLA QUENTE BIV 40W GDE 103
 Código: Fábrica: Unidade:
18998 WIN/FU/ET/AL UN/1
F1 F4

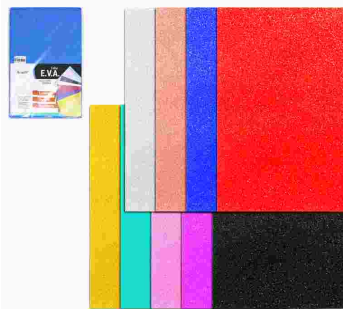

PLACA EVA A4 20X30CM GLITER CORES 10X1
 Código: Fábrica: Unidade:
46444 ITERPONTE PT/10
F1 F4

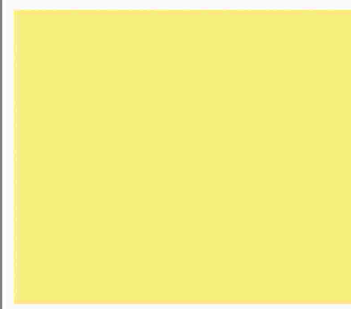

PLACA EVA 39X59CM ECON AMARELO 10X1
 Código: Fábrica: Unidade:
48394 IBEL PT/10
F1 F4



PLACA EVA 39X59CM ECON AZUL BB 10X1
 Código: Fábrica: Unidade:
44175 IBEL PT/10
F1 F4



PLACA EVA 39X59CM ECON CENOURA 10X1
 Código: Fábrica: Unidade:
44171 IBEL PT/10
F1 F4



PLACA EVA 39X59CM ECON MARRON 10X1
 Código: Fábrica: Unidade:
12579 IBEL PT/10
F1 F4



PLACA EVA 39X59CM ECON VERDE GRAMA 10X1
 Código: Fábrica: Unidade:
44178 IBEL PT/10
F1 F4



PLACA EVA 40X40CM AZUL BEBE 10X1
 Código: Fábrica: Unidade:
39990 DUBFLEX PT/10
F1 F4

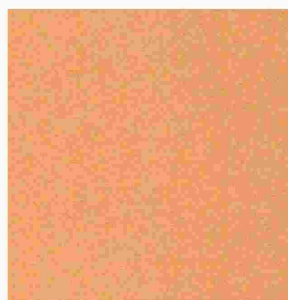

PLACA EVA 40X40CM BEGE 10X1
 Código: Fábrica: Unidade:
39991 DUBFLEX PT/10
F1 F4



PLACA EVA 40X40CM LARANJA 10X1
 Código: Fábrica: Unidade:
39992 DUBFLEX PT/10
F1 F4



PLACA EVA 40X40CM LILAS 10X1
 Código: Fábrica: Unidade:
39993 DUBFLEX PT/10
F1 F4

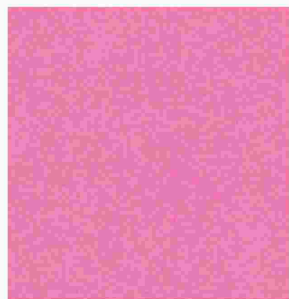

PLACA EVA 40X40CM ROSA PINK 10X1
 Código: Fábrica: Unidade:
39996 DUBFLEX PT/10
F1 F4



PLACA EVA 40X40CM ROSA 10X1
 Código: Fábrica: Unidade:
39995 DUBFLEX PT/10
F1 F4

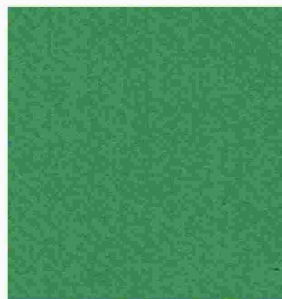

PLACA EVA 40X40CM VERDE BANDEIRA 10X1
 Código: Fábrica: Unidade:
39997 DUBFLEX PT/10
F1 F4



PLACA EVA 40X40CM VERDE CLARO 10X1
 Código: Fábrica: Unidade:
39998 DUBFLEX PT/10
F1 F4

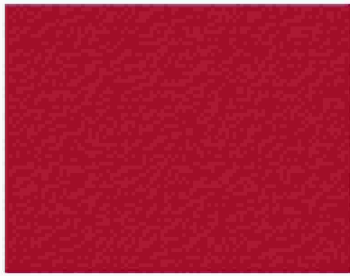

PLACA EVA 40X45CM BORDO 10X1

Código: **44323** Fábrica: **RABER** Unidade: **PT/10**
F1 F4



PLACA EVA 40X47CM AMARELO ESC 011 10X1

Código: **7113** Fábrica: **DUB FLEX** Unidade: **PT/10**
F1 F4



PLACA EVA 40X47CM AZUL ROYAL 10X1

Código: **49141** Fábrica: **EVAMAX** Unidade: **PT/10**
F1 F4



PLACA EVA 40X47CM AZUL ROYAL 10X1

Código: **22359** Fábrica: **DUB FLEX** Unidade: **PT/10**
F1 F4

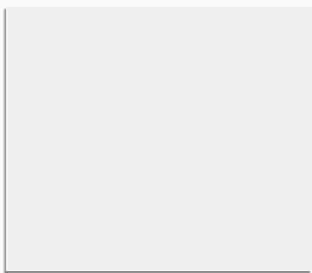

PLACA EVA 40X47CM BRANCO 10X1

Código: **4261** Fábrica: **SANTAFE/IBEL** Unidade: **PT/10**
F1 F4



PLACA EVA 40X47CM VERDE AGUA 10X1

Código: **18972** Fábrica: **MW PLUS/BRW** Unidade: **PT/10**
F1 F4



PLACA EVA 40X47CM VERDE CLARO 015 10X1

Código: **18966** Fábrica: **IB/W** Unidade: **PT/10**
F1 F4



PLACA EVA 40X47CM VERMELHO 10X1

Código: **50854** Fábrica: **DUB FLEX** Unidade: **PT/10**
F1 F4



PLACA EVA 40X48CM AMARELO 10X1

Código: **39777** Fábrica: **SANTA FE** Unidade: **PT/10**
F1 F4



PLACA EVA 40X48CM ATOALH AMARELO ESC 5X1

Código: **33717** Fábrica: **DUBFLEX** Unidade: **PT/5**
F1 F4



PLACA EVA 40X48CM ATOALH AZUL BB 5X1

Código: **33718** Fábrica: **DUBFLEX** Unidade: **PT/5**
F1 F4

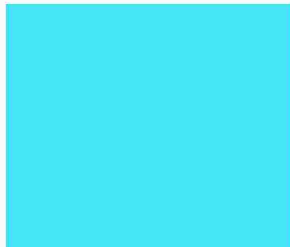

PLACA EVA 40X48CM AZUL CLARO 10X1

Código: **18954** Fábrica: **BRW** Unidade: **PT/10**
F1 F4



PLACA EVA 40X48CM AZUL ROYAL 10X1

Código: **21650** Fábrica: **BRW** Unidade: **PT/10**
F1 F4



PLACA EVA 40X48CM BEGE 10X1

Código: **18970** Fábrica: **BRW** Unidade: **PT/10**
F1 F4

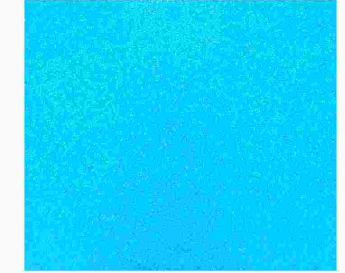

PLACA EVA 40X48CM GLITER AZUL CLARO 10X1

Código: **22354** Fábrica: **YIN'S/IBEL** Unidade: **PT/10**
F1 F4

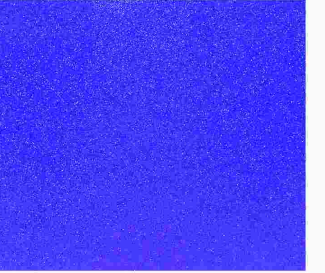

PLACA EVA 40X48CM GLITER AZUL ESC 10X1

Código: **45139** Fábrica: **YIN'S PAPER** Unidade: **PT/10**
F1 F4



PLACA EVA 40X48CM GLITER AZUL PETRO 10X1
 Código: 45428 Fábrica: IBEL Unidade: PT/10
 F1 F4



PLACA EVA 40X48CM GLITER AZUL 10X1
 Código: 48151 Fábrica: YIN'S PAPER Unidade: PT/10
 F1 F4



PLACA EVA 40X48CM GLITER BRANCO 10X1
 Código: 28908 Fábrica: YIN'S/IBEL Unidade: PT/10
 F1 F4

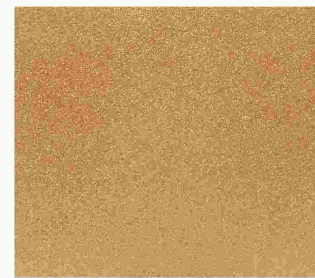

PLACA EVA 40X48CM GLITER BRONZE 10X1
 Código: 46958 Fábrica: YIN'S PAPER Unidade: PT/10
 F1 F4

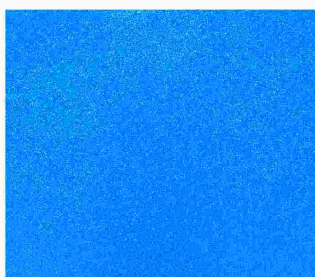

PLACA EVA 40X48CM GLITER ESP AZUL 10X1
 Código: 44163 Fábrica: YIN'S/IBEL Unidade: PT/10
 F1 F4



PLACA EVA 40X48CM GLITER ESP MARROM 10X1
 Código: 45430 Fábrica: IBEL Unidade: PT/10
 F1 F4

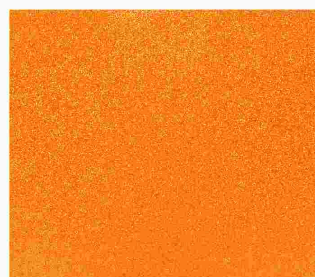

PLACA EVA 40X48CM GLITER LARANJA 10X1
 Código: 22355 Fábrica: YIN'S PAPER Unidade: PT/10
 F1 F4

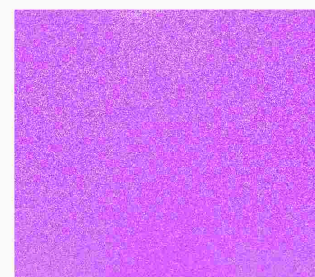

PLACA EVA 40X48CM GLITER LILAS 10X1
 Código: 32382 Fábrica: YIN'S PAPER Unidade: PT/10
 F1 F4

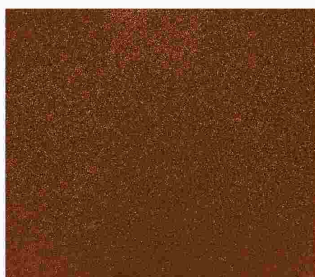

PLACA EVA 40X48CM GLITER MARROM 10X1
 Código: 28909 Fábrica: YIN'S PAPER Unidade: PT/10
 F1 F4



PLACA EVA 40X48CM GLITER NEON LARAN 10X1
 Código: 46961 Fábrica: YIN'S PAPER Unidade: PT/10
 F1 F4



PLACA EVA 40X48CM GLITER NEON VERDE 10X1
 Código: 46959 Fábrica: YIN'S PAPER Unidade: PT/10
 F1 F4



PLACA EVA 40X48CM GLITER OURO 10X1
 Código: 46240 Fábrica: IBEL Unidade: PT/10
 F1 F4



PLACA EVA 40X48CM GLITER OURO 5X1
 Código: 50318 Fábrica: SANTA FE Unidade: PT/5
 F1 F4

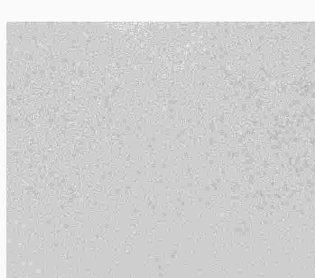

PLACA EVA 40X48CM GLITER PRATA 10X1
 Código: 32381 Fábrica: YIN'S/IBEL Unidade: PT/10
 F1 F4



PLACA EVA 40X48CM GLITER PRETO 10X1
 Código: 28913 Fábrica: IBEL Unidade: PT/10
 F1 F4



PLACA EVA 40X48CM GLITER PRETO 5X1
 Código: 50319 Fábrica: SANTA FE Unidade: PT/5
 F1 F4

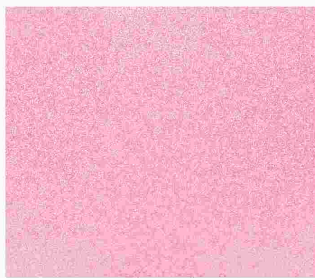

PLACA EVA 40X48CM GLITER ROSA CLARO 10X1
 Código: 22357 Fábrica: YIN'S PAPER Unidade: PT/10
 F1 F4

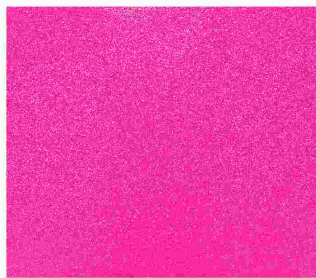

PLACA EVA 40X48CM GLITER ROSA PINK 10X1
 Código: 46957 Fábrica: YIN'S PAPER Unidade: PT/10
 F1 F4

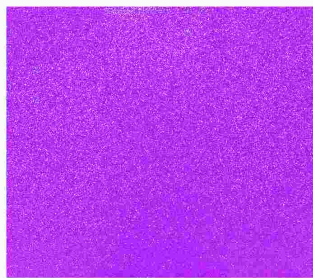

PLACA EVA 40X48CM GLITER ROXO 10X1
 Código: 32380 Fábrica: YIN'S PAPER Unidade: PT/10
 F1 F4

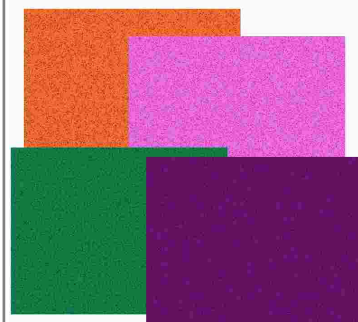

PLACA EVA 40X48CM GLITER SORT 10X1
 Código: 35987 Fábrica: MAKE Unidade: PT/10
 F1 F4



PLACA EVA 40X48CM GLITER VERDE BAND 10X1
 Código: 32379 Fábrica: YIN'S/IBEL Unidade: PT/10
 F1 F4

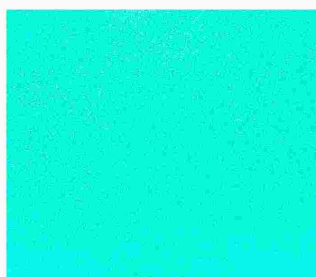

PLACA EVA 40X48CM GLITER VERDE CLAR 10X1
 Código: 45138 Fábrica: YIN'S PAPER Unidade: PT/10
 F1 F4



PLACA EVA 40X48CM GLITER VERMELHO 10X1
 Código: 7119 Fábrica: IBEL Unidade: PT/10
 F1 F4



PLACA EVA 40X48CM GLITER VERMELHO 5X1
 Código: 49137 Fábrica: SANTA FE Unidade: PT/5
 F1 F4

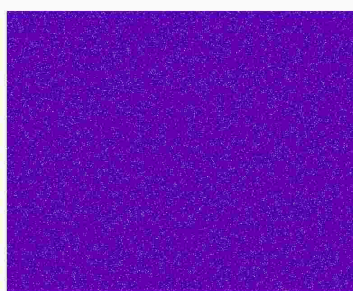

PLACA EVA 40X48CM GLITER VIOLETA 10X1
 Código: 37348 Fábrica: DUB FLEX Unidade: PT/10
 F1 F4



PLACA EVA 40X48CM LARANJA 10X1
 Código: 18959 Fábrica: SANTA FE/LEO Unidade: PT/10
 F1 F4



PLACA EVA 40X48CM LILAS 10X1
 Código: 18964 Fábrica: SANTA FE Unidade: PT/10
 F1 F4

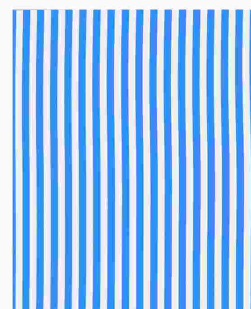

PLACA EVA 40X48CM LISTR AZUL BRANCO 10X1
 Código: 48313 Fábrica: BRW Unidade: PT/10
 F1 F4

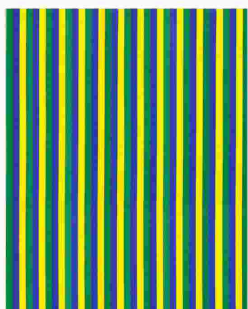

PLACA EVA 40X48CM LISTR BRASIL 10X1
 Código: 48314 Fábrica: BRW Unidade: PT/10
 F1 F4

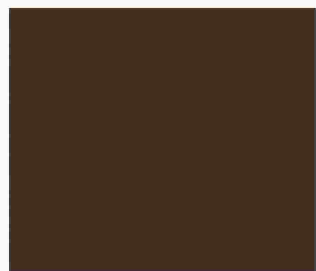

PLACA EVA 40X48CM MARROM 10X1
 Código: 18948 Fábrica: SANTA FE Unidade: PT/10
 F1 F4



PLACA EVA 40X48CM PRETO 10X1
 Código: 48952 Fábrica: SANTAFE/LEOA Unidade: PT/10
 F1 F4

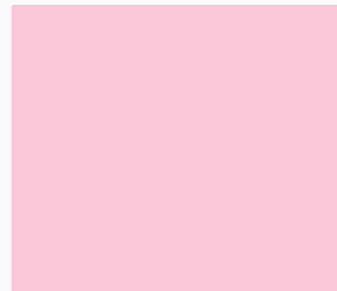

PLACA EVA 40X48CM ROSA CLARO 10X1
 Código: 7115 Fábrica: BRW/IBEL Unidade: PT/10
 F1 F4



PLACA EVA 40X48CM ROSA PINK 10X1

Código: **18961** Fábrica: **BRW** Unidade: **PT/10**
F1 F4



PLACA EVA 40X48CM ROXO 10X1

Código: **22360** Fábrica: **SANTAFE/BRW** Unidade: **PT/10**
F1 F4



PLACA EVA 40X48CM SALMAO 10X1

Código: **18957** Fábrica: **BRW** Unidade: **PT/10**
F1 F4

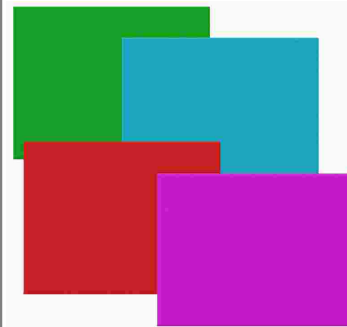

PLACA EVA 40X48CM SORTIDO 10X1

Código: **18973** Fábrica: **MAKE** Unidade: **PT/10**
F1 F4



PLACA EVA 40X48CM TERRA 022 10X1

Código: **38016** Fábrica: **BRW** Unidade: **PT/10**
F1 F4



PLACA EVA 40X48CM VERDE BANDEIRA 10X1

Código: **44164** Fábrica: **BRW** Unidade: **PT/10**
F1 F4



PLACA EVA 40X48CM VERDE CLARO 10X1

Código: **7117** Fábrica: **LEONORA** Unidade: **PT/10**
F1 F4

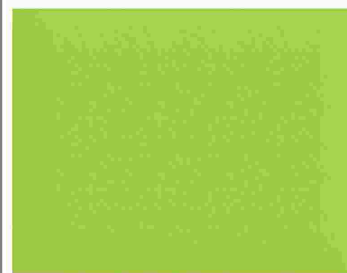

PLACA EVA 40X48CM VERDE FLUORES 017 10X1

Código: **18967** Fábrica: **BRW** Unidade: **PT/10**
F1 F4



PLACA EVA 40X48CM VERDE FOLHA 016 10X1

Código: **22362** Fábrica: **BRW** Unidade: **PT/10**
F1 F4



PLACA EVA 40X48CM VERDE MUSGO 019 10X1

Código: **18969** Fábrica: **BRW** Unidade: **PT/10**
F1 F4



PLACA EVA 40X48CM VERDE PETROLEO 10X1

Código: **48876** Fábrica: **IBEL** Unidade: **PT/10**
F1 F4



PLACA EVA 40X48CM VERMELHO 10X1

Código: **18962** Fábrica: **SANTA FE** Unidade: **PT/10**
F1 F4

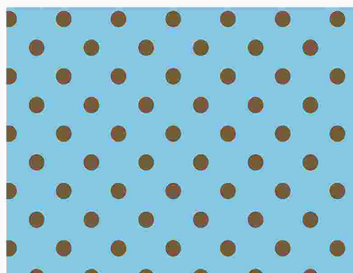

PLACA EVA 40X50CM EST POA AZUL/MARR 10X1

Código: **34139** Fábrica: **BRW** Unidade: **PT/10**
F1 F4

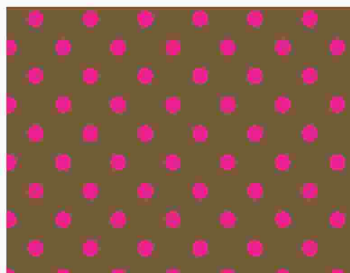

PLACA EVA 40X50CM EST POA MARR/ROSA 10X1

Código: **34136** Fábrica: **BRW** Unidade: **PT/10**
F1 F4

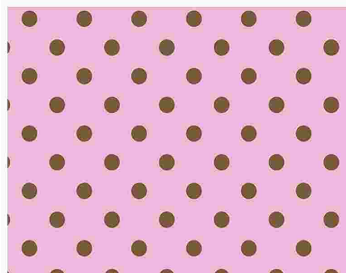

PLACA EVA 40X50CM EST POA ROSA/MARR 10X1

Código: **34135** Fábrica: **BRW** Unidade: **PT/10**
F1 F4



PLACA EVA 40X60CM AMARELO 10X1

Código: **43707** Fábrica: **BRW** Unidade: **PT/10**
F1 F4



PLACA EVA 40X60CM AZUL CLARO 4907 10X1
 Código: 48721 Fábrica: LEOARTE Unidade: PT/10
 F1 F4



PLACA EVA 40X60CM AZUL ROYAL 10X1
 Código: 49140 Fábrica: EVAMAX Unidade: PT/10
 F1 F4



PLACA EVA 40X60CM AZUL ROYAL 10X1
 Código: 45379 Fábrica: BRW Unidade: PT/10
 F1 F4



PLACA EVA 40X60CM AZUL 10X1
 Código: 43697 Fábrica: BRW Unidade: PT/10
 F1 F4

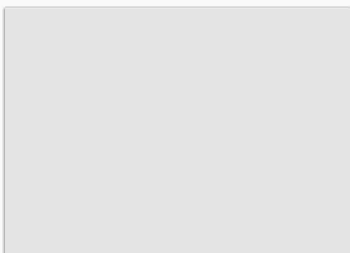

PLACA EVA 40X60CM BRANCO 4906 10X1
 Código: 43689 Fábrica: LEOARTE Unidade: PT/10
 F1 F4



PLACA EVA 40X60CM CIRCULO AZUL 3D 5X1
 Código: 38573 Fábrica: MAKE Unidade: PT/5
 F4



PLACA EVA 40X60CM ESTAMP BOLA 10X1
 Código: 43766 Fábrica: WIN PAPER Unidade: PT/10
 F1 F4



PLACA EVA 40X60CM ESTAMP FLORES ROSA 5X1
 Código: 38578 Fábrica: MAKE Unidade: PT/5
 F4



PLACA EVA 40X60CM ESTAMP FLORES VERM 5X1
 Código: 38577 Fábrica: MAKE Unidade: PT/5
 F1 F4

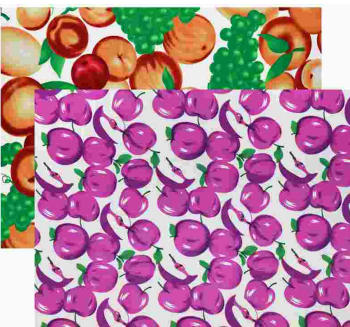

PLACA EVA 40X60CM ESTAMP FRUTAS 5X1
 Código: 38574 Fábrica: MAKE Unidade: PT/5
 F1 F4

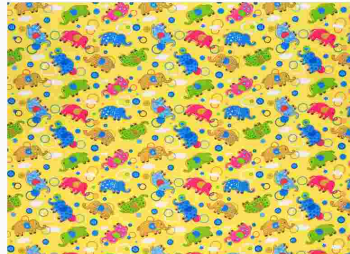

PLACA EVA 40X60CM ESTAMP INF AMARELO 5X1
 Código: 38579 Fábrica: MAKE Unidade: PT/5
 F4



PLACA EVA 40X60CM ESTAMP MESC AZUL 5X1
 Código: 38575 Fábrica: MAKE Unidade: PT/5
 F1 F4



PLACA EVA 40X60CM ESTAMP MESC VERMEL 5X1
 Código: 38576 Fábrica: MAKE Unidade: PT/5
 F4

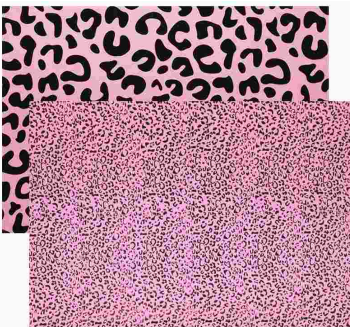

PLACA EVA 40X60CM ESTAMP ONCA ROSA 5X1
 Código: 38583 Fábrica: MAKE Unidade: PT/5
 F1 F4



PLACA EVA 40X60CM ESTAMP ONCA 10X1
 Código: 43764 Fábrica: WIN PAPER Unidade: PT/10
 F1 F4

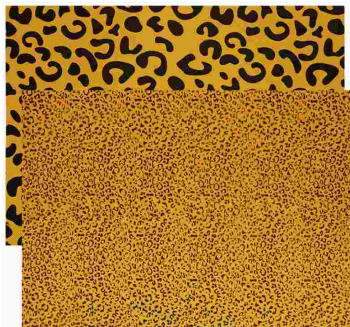

PLACA EVA 40X60CM ESTAMP ONCA 5X1
 Código: 38584 Fábrica: MAKE Unidade: PT/5
 F4

40 cm
60 cm

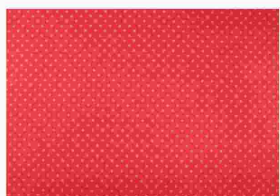

PLACA EVA 40X60CM ESTAMP POA 10X1

Código: 43769 Fábrica: WIN PAPER Unidade: PT/10
F1 F4



PLACA EVA 40X60CM ESTAMP VAQUINHA 5X1

Código: 38581 Fábrica: MAKE Unidade: PT/5
F4

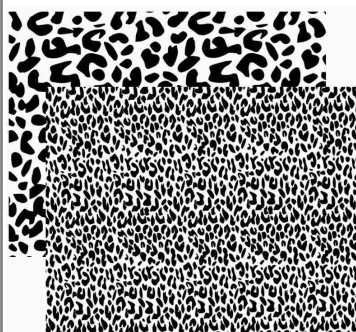

PLACA EVA 40X60CM ESTAMP VAQUINHA 5X1

Código: 38582 Fábrica: MAKE Unidade: PT/5
F4

40 cm
60 cm

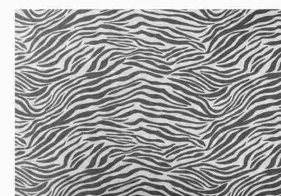

PLACA EVA 40X60CM ESTAMP ZEBRA 10X1

Código: 43765 Fábrica: WIN PAPER Unidade: PT/10
F1 F4



PLACA EVA 40X60CM GLITER AZUL CLARO 10X1

Código: 46239 Fábrica: YIN'S PAPER Unidade: PT/10
F1 F4

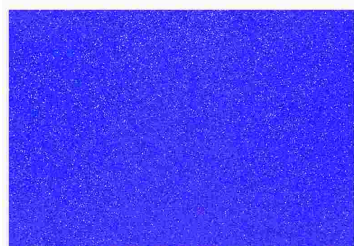

PLACA EVA 40X60CM GLITER AZUL ESCUR 10X1

Código: 46956 Fábrica: YIN'S/IBEL Unidade: PT/10
F1 F4

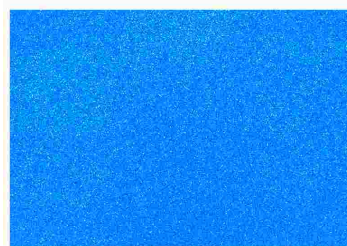

PLACA EVA 40X60CM GLITER AZUL 10X1

Código: 46222 Fábrica: YIN'S/IBEL Unidade: PT/10
F1 F4

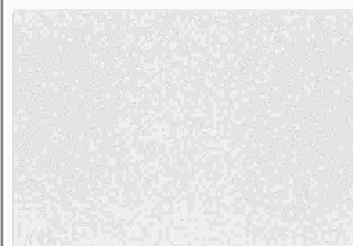

PLACA EVA 40X60CM GLITER BRANCO 10X1

Código: 46221 Fábrica: YIN'S/IBEL Unidade: PT/10
F1 F4



PLACA EVA 40X60CM GLITER BRONZE 10X1

Código: 46954 Fábrica: YIN'S PAPER Unidade: PT/10
F1 F4

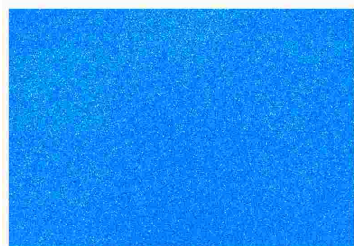

PLACA EVA 40X60CM GLITER ECON AZUL 10X1

Código: 45427 Fábrica: IBEL Unidade: PT/10
F1 F4



PLACA EVA 40X60CM GLITER ESP COBRE 10X1

Código: 46230 Fábrica: IBEL Unidade: PT/10
F1 F4



PLACA EVA 40X60CM GLITER LARANJA 5X1

Código: 41839 Fábrica: ONDA Unidade: PT/5
F1 F4

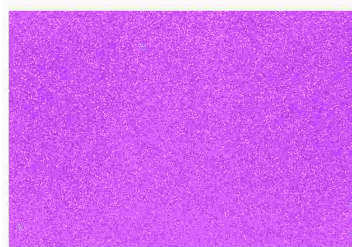

PLACA EVA 40X60CM GLITER LILAS 10X1

Código: 46223 Fábrica: YIN'S/IBEL Unidade: PT/10
F1 F4



PLACA EVA 40X60CM GLITER LILAS 5X1

Código: 41840 Fábrica: ONDA Unidade: PT/5
F1 F4



PLACA EVA 40X60CM GLITER MARROM 10X1

Código: 46232 Fábrica: YIN'S/IBEL Unidade: PT/10
F1 F4



PLACA EVA 40X60CM GLITER MARROM 5X1

Código: 41836 Fábrica: ONDA Unidade: PT/5
F1 F4

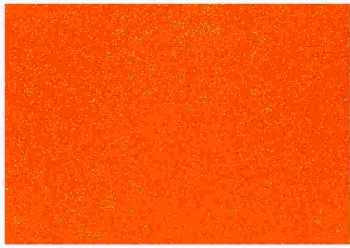

PLACA EVA 40X60CM GLITER NEON LARAN 10X1
 Código: 46953 Fábrica: YIN'S PAPER Unidade: PT/10
 F1 F4

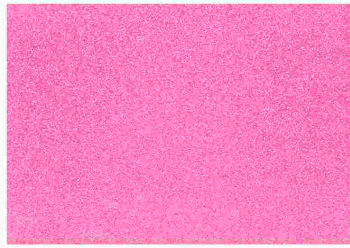

PLACA EVA 40X60CM GLITER NEON ROSA 10X1
 Código: 46952 Fábrica: YIN'S PAPER Unidade: PT/10
 F1 F4

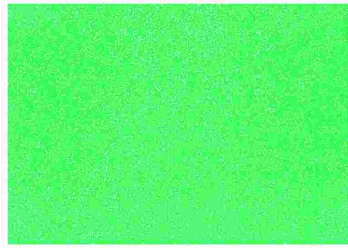

PLACA EVA 40X60CM GLITER NEON VERDE 10X1
 Código: 46951 Fábrica: YIN'S PAPER Unidade: PT/10
 F1 F4

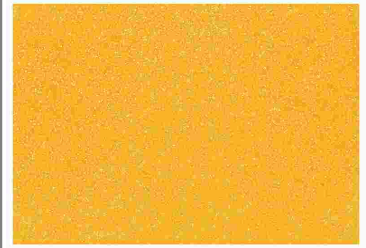

PLACA EVA 40X60CM GLITER OURO 10X1
 Código: 46233 Fábrica: YIN'S PAPER Unidade: PT/10
 F1 F4

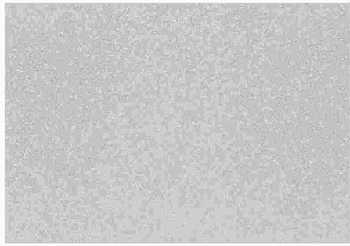

PLACA EVA 40X60CM GLITER PRATA 10X1
 Código: 46237 Fábrica: YIN'S PAPER Unidade: PT/10
 F1 F4

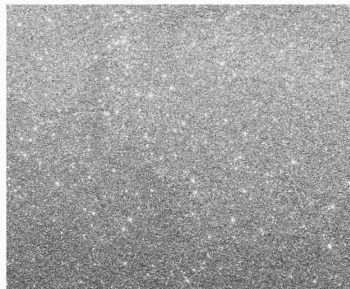

PLACA EVA 40X60CM GLITER PRATA 5X1
 Código: 41842 Fábrica: ONDA Unidade: PT/5
 F1 F4

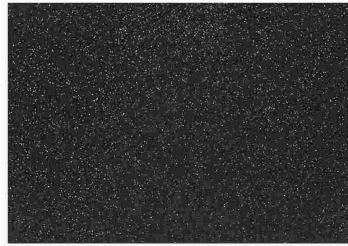

PLACA EVA 40X60CM GLITER PRETO 10X1
 Código: 46217 Fábrica: YIN'S/IBEL Unidade: PT/10
 F1 F4

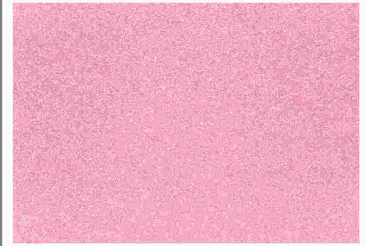

PLACA EVA 40X60CM GLITER ROSA CLARO 10X1
 Código: 46234 Fábrica: YIN'S PAPER Unidade: PT/10
 F1 F4



PLACA EVA 40X60CM GLITER ROSA PINK 5X1
 Código: 49138 Fábrica: EVAMAX Unidade: PT/5
 F1 F4



PLACA EVA 40X60CM GLITER ROSA 10X1
 Código: 46238 Fábrica: YIN'S PAPER Unidade: PT/10
 F1 F4



PLACA EVA 40X60CM GLITER ROSA 5X1
 Código: 41838 Fábrica: ONDA Unidade: PT/5
 F1 F4

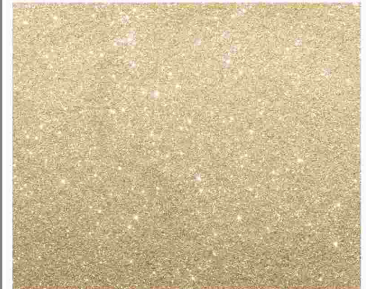

PLACA EVA 40X60CM GLITER SKIN 5X1
 Código: 41843 Fábrica: ONDA Unidade: PT/5
 F1 F4

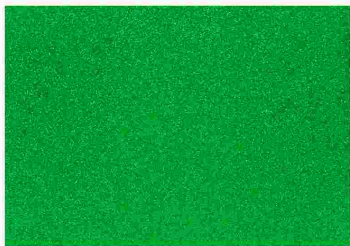

PLACA EVA 40X60CM GLITER VERDE BAND 10X1
 Código: 46236 Fábrica: YIN'S PAPER Unidade: PT/10
 F1 F4

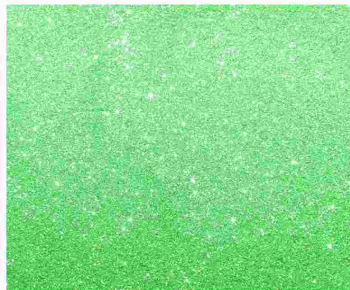

PLACA EVA 40X60CM GLITER VERDE CLARO 5X1
 Código: 41841 Fábrica: ONDA Unidade: PT/5
 F1 F4

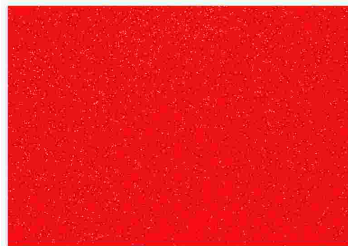

PLACA EVA 40X60CM GLITER VERM 10X1
 Código: 46220 Fábrica: YIN'S/IBEL Unidade: PT/10
 F1 F4



PLACA EVA 40X60CM LARANJA 4903 10X1
 Código: 22527 Fábrica: LEOARTE Unidade: PT/10
 F1 F4



PLACA EVA 40X60CM LILAS 10X1

Código: **43698** Fábrica: **IBEL** Unidade: **PT/10**
F1 F4



PLACA EVA 40X60CM LILAS 4908 10X1

Código: **48366** Fábrica: **LEOARTE** Unidade: **PT/10**
F1 F4

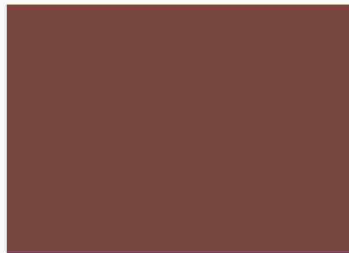

PLACA EVA 40X60CM MARROM 4909 10X1

Código: **48364** Fábrica: **LEOARTE** Unidade: **PT/10**
F1 F4

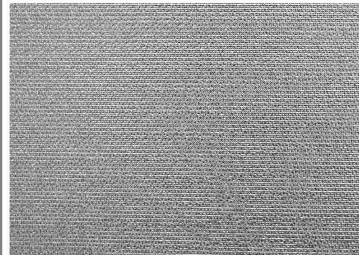

PLACA EVA 40X60CM METALICO PRATA 5X1

Código: **38570** Fábrica: **MAKE** Unidade: **PT/5**
F1 F4

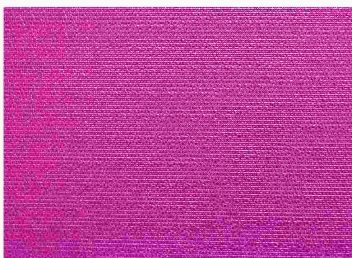

PLACA EVA 40X60CM METALICO ROSA PINK 5X1

Código: **38571** Fábrica: **MAKE** Unidade: **PT/5**
F1 F4

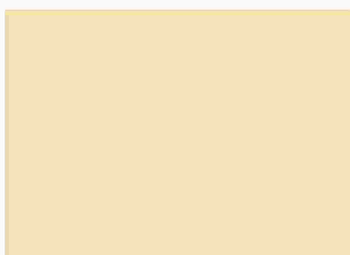

PLACA EVA 40X60CM PELE 4753 10X1

Código: **45383** Fábrica: **LEOARTE** Unidade: **PT/10**
F1 F4

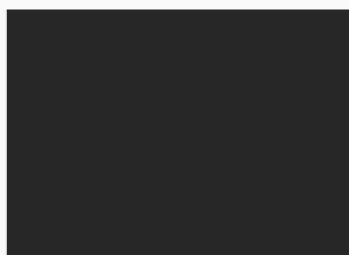

PLACA EVA 40X60CM PRETO 4905 10X1

Código: **43706** Fábrica: **LEOARTE** Unidade: **PT/10**
F1 F4



PLACA EVA 40X60CM ROSA BEBE 4707 10X1

Código: **45382** Fábrica: **LEOARTE** Unidade: **PT/10**
F1 F4



PLACA EVA 40X60CM ROSA PINK 4930 10X1

Código: **45381** Fábrica: **LEOARTE** Unidade: **PT/10**
F1 F4



PLACA EVA 40X60CM ROSA 4911 10X1

Código: **48363** Fábrica: **LEOARTE** Unidade: **PT/10**
F1 F4

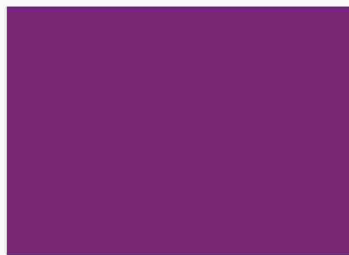

PLACA EVA 40X60CM ROXO 4914 10X1

Código: **48365** Fábrica: **LEOARTE** Unidade: **PT/10**
F1 F4



PLACA EVA 40X60CM VERDE BANDEIRA 10X1

Código: **43695** Fábrica: **BRW** Unidade: **PT/10**
F1 F4



PLACA EVA 40X60CM VERDE CLARO 10X1

Código: **49139** Fábrica: **EVAMAX** Unidade: **PT/10**
F1 F4



PLACA EVA 40X60CM VERDE GRAMA 4705 10X1

Código: **48361** Fábrica: **LEOARTE** Unidade: **PT/10**
F1 F4



PLACA EVA 40X60CM VERDE 4902 10X1

Código: **48722** Fábrica: **LEOARTE** Unidade: **PT/10**
F1 F4



PLACA EVA 40X60CM VERMELHO FOG 4710 10X1

Código: **48362** Fábrica: **LEOARTE** Unidade: **PT/10**
F1 F4

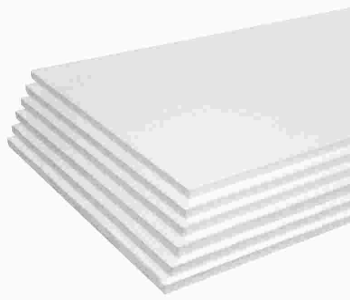

PLACA ISOPOR 1000X500X05MM 50X1

Código: **42395** Fábrica: **ISOMAX** Unidade: **PT/50**
F1 F4

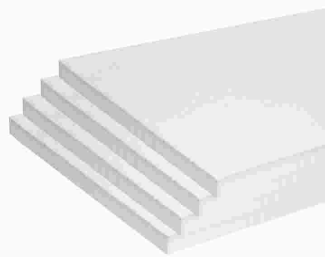

PLACA ISOPOR 1000X500X10MM 25X1

Código: **7111** Fábrica: **ISOMAX** Unidade: **PT/25**
F1 F4

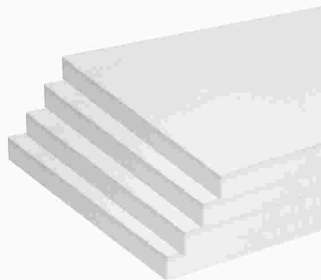

PLACA ISOPOR 1000X500X15MM 16X1

Código: **29881** Fábrica: **ISOMAX** Unidade: **PT/16**
F1 F4

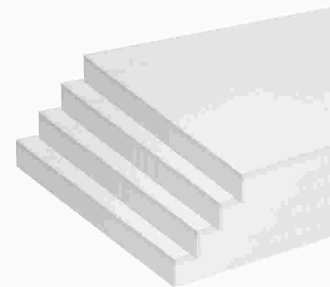

PLACA ISOPOR 1000X500X20MM 12X1

Código: **31928** Fábrica: **ISOMAX** Unidade: **PT/12**
F1 F4



PLACA ISOPOR 1000X500X25MM 10X1

Código: **12578** Fábrica: **ISOMAX** Unidade: **PT/10**
F1 F4



PLACA ISOPOR 1000X500X30MM 8X1

Código: **30091** Fábrica: **ISOMAX** Unidade: **PT/8**
F1 F4

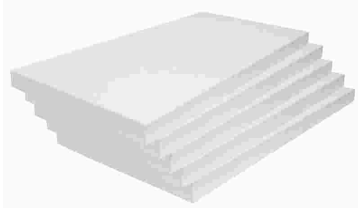

PLACA ISOPOR 1000X500X45MM 5X1

Código: **43776** Fábrica: **ISOMAX** Unidade: **PT/5**
F1 F4

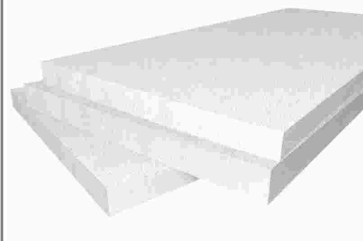

PLACA ISOPOR 1000X500X50MM 5X1

Código: **41761** Fábrica: **ISOMAX** Unidade: **PT/5**
F1 F4

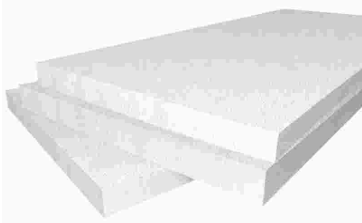

PLACA ISOPOR 1000X500X75MM 3X1

Código: **42345** Fábrica: **ISOMAX** Unidade: **PT/1**
F1 F4

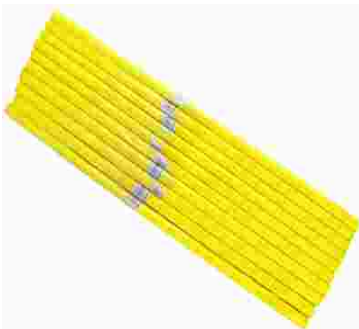

PLASTICO ENCAPAR 2MX45CM AMARELO 10X1

Código: **2533** Fábrica: **DDL** Unidade: **PT/10**
F1 F4



PLASTICO ENCAPAR 2MX45CM AZUL 10X1

Código: **2532** Fábrica: **DDL** Unidade: **PT/10**
F1 F4

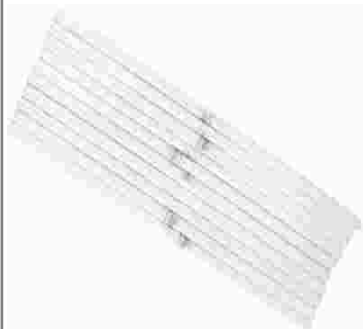

PLASTICO ENCAPAR 2MX45CM BRANCO 10X1

Código: **44377** Fábrica: **DDL** Unidade: **PT/10**
F1 F4



PLASTICO ENCAPAR 2MX45CM INCOLOR 10X1

Código: **14136** Fábrica: **DDL** Unidade: **PT/10**
F1 F4



PLASTICO ENCAPAR 2MX45CM ROSA 10X1

Código: **44371** Fábrica: **DDL** Unidade: **PT/10**
F1 F4



PLASTICO ENCAPAR 2MX45CM SORT 10X1

Código: **13136** Fábrica: **DDL** Unidade: **PT/10**
F1 F4



PLASTICO ENCAPAR 2MX45CM VERDE 10X1

Código: **3969** Fábrica: **DDL** Unidade: **PT/10**
F1 F4



PLASTICO ENCAPAR 2MX45CM VERMELH 10X1

Código: 2534
Fábrica: DDL
Unidade: PT/10
F1 F4



PLASTICO ENCAPAR 25MX45CM AZUL CORACAO

Código: 3973
Fábrica: FA
Unidade: RL/25
F1 F4



PLASTICO ENCAPAR 25MX45CM INF

Código: 42833
Fábrica: FA
Unidade: RL/25
F1 F4



PLASTICO ENCAPAR 25MX45CM INF FEMININO

Código: 42832
Fábrica: FA
Unidade: RL/25
F1 F4



PLASTICO ENCAPAR 25MX45CM LISO AZUL

Código: 27953
Fábrica: NEW MAGIC
Unidade: RL/25
F1 F4



PLASTICO ENCAPAR 25MX45CM TRANSP DEC

Código: 42837
Fábrica: FA
Unidade: RL/25
F1 F4



PLASTICO ENCAPAR 25MX45CM TRANSP 04

Código: 45604
Fábrica: DAC
Unidade: RL/25
F1 F4



PLASTICO ENCAPAR 25MX45CM VERMELHO

Código: 3966
Fábrica: FA
Unidade: RL/25
F1 F4

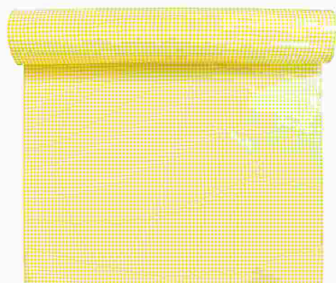

PLASTICO ENCAPAR 25MX45CM XADREZ AMARE

Código: 3965
Fábrica: FA
Unidade: RL/25
F1 F4

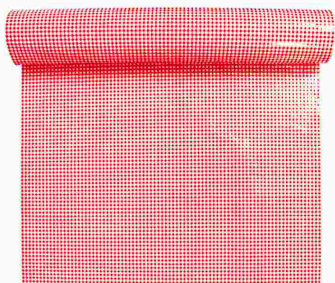

PLASTICO ENCAPAR 25MX45CM XADREZ VERME

Código: 42851
Fábrica: FA
Unidade: RL/25
F1 F4



PLASTICO ENCAPAR 35X50CM PICOT AMAR 75X1

Código: 7229
Fábrica: NEW MAGIC
Unidade: RL/1
F1 F4



PLASTICO ENCAPAR 35X50CM PICOT VERD 75X1

Código: 7231
Fábrica: APLICOLA
Unidade: RL/1
F1 F4



PLASTICO ENCAPAR 35X50CM PICOT VERM 75X1

Código: 7230
Fábrica: APLICOLA
Unidade: RL/1
F1 F4



PLASTICO ENCAPAR 35X50CMPICOT INCOL 75X1

Código: 7233
Fábrica: APLICOLA
Unidade: RL/1
F1 F4



PLASTICO ENCAPAR 50MX35CM LISO AMARELO

Código: 47445
Fábrica: PLASVIPEL
Unidade: RL/50
F1 F4



PLASTICO ENCAPAR 50MX35CM LISO VERMELHO

Código: 47447
Fábrica: PLASVIPEL
Unidade: RL/50
F1 F4



PLASTICO ENCAPAR 50MX35CM PICOT INF

Código: 48000 Fábrica: PLASVIPEL Unidade: RL/50 F1 F4

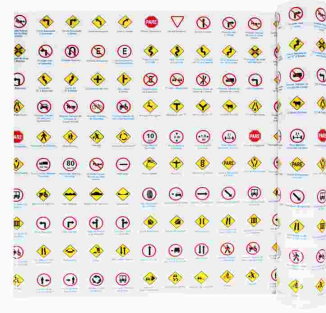

PLASTICO ENCAPAR 50MX45CM EST TRANSITO

Código: 47999 Fábrica: FA Unidade: RL/50 F1 F4

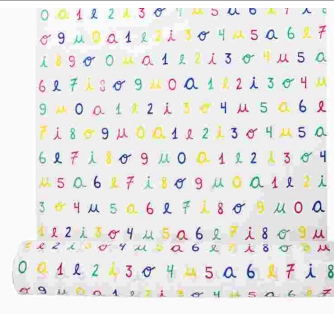

PLASTICO ENCAPAR 50MX45CM ESTAMP ABC

Código: 42849 Fábrica: FA Unidade: RL/50 F1 F4



PLASTICO ENCAPAR 50MX45CM ESTAMP NUM/LET

Código: 45626 Fábrica: FA Unidade: RL/50 F1 F4



PLASTICO ENCAPAR 50MX45CM INF MASCULIN

Código: 42838 Fábrica: FA Unidade: RL/25 F1 F4



PLASTICO ENCAPAR 50MX45CM TRANSP DEC

Código: 42846 Fábrica: FA Unidade: RL/50 F1 F4

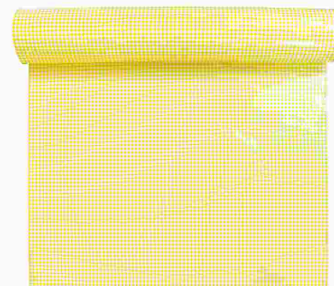

PLASTICO ENCAPAR 50MX45CM XADREZ AMARE

Código: 42850 Fábrica: DAC Unidade: RL/50 F1 F4

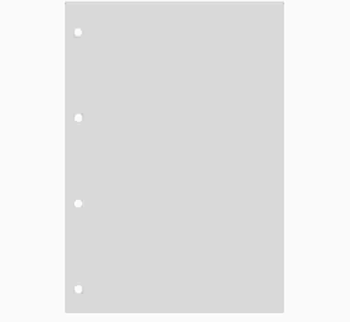

PLASTICO PASTA CATALAG OF 0,06 4F 1000X1

Código: 42414 Fábrica: ACP Unidade: MI/1000 F1 F4



PLASTICO PASTA CATALAGO A4 FINO 4F 100X1

Código: 13177 Fábrica: MAXIPLASTICO Unidade: CE/100 F1 F4



PLASTICO PASTA CATALAGO OF 0,06 4F 100X1

Código: 3603 Fábrica: ACP Unidade: CE/100 F1 F4

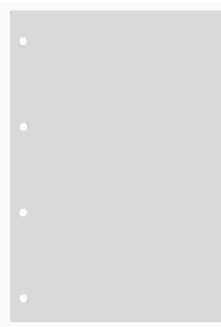

PLASTICO PASTA CATALAGO OF 0,12 4F 500X1

Código: 42417 Fábrica: ACP Unidade: CX/500 F1 F4

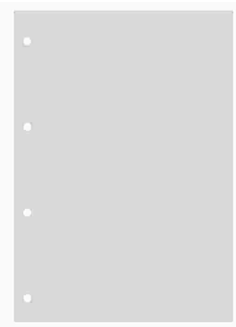

PLASTICO PASTA CATALAGO OF 0,15 4F 400X1

Código: 42416 Fábrica: ACP Unidade: CX/400 F1 F4

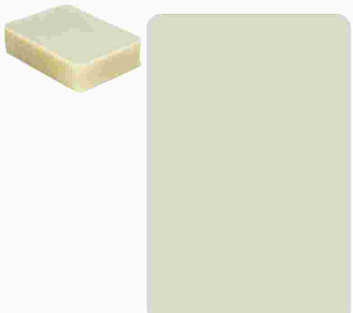

PLASTICO POLASEAL A3 303X426MM 05 100X1

Código: 37809 Fábrica: PIC10 Unidade: CE/100 F1 F4



PLASTICO POLASEAL A4 220X307MM 05 100X1

Código: 45267 Fábrica: MASTERPRINT Unidade: CE/100 F1 F4



PLASTICO POLASEAL CPF/TI 5 66X99MM 100X1

Código: 27095 Fábrica: MASTER/PLAST Unidade: CE/100 F1 F4



PLASTICO POLASEAL CRACH 05 59X86MM 100X1

Código: 45124 Fábrica: MASTERPRINT Unidade: CE/100 F1 F4

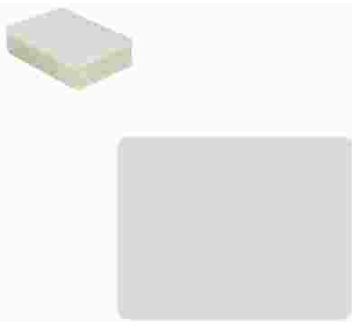

PLASTICO POLASEAL CRACH 5 73X106MM 100X1
 Código: 27169 Fábrica: LIDER Unidade: CE/100
 F1 F4



PLASTICO POLASEAL OFI 222X336MM 05 100X1
 Código: 20787 Fábrica: PLASTIFIX Unidade: CE/100
 F1 F4



PLASTICO POLASEAL OFI 226X340MM 05 100X1
 Código: 47214 Fábrica: MASTERPRINT Unidade: CE/100
 F1 F4



PLASTICO POLASEAL RG 79X108MM 05 100X1
 Código: 22613 Fábrica: MASTERPRINT Unidade: CE/100
 F1 F4

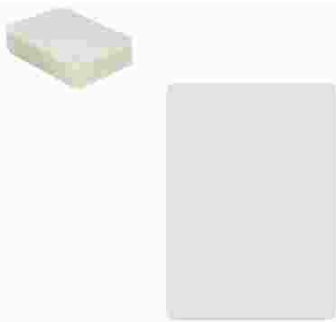

PLASTICO POLASEAL RG 80X110MM 05 100X1
 Código: 20785 Fábrica: MASTERPRINT Unidade: CE/100
 F1 F4



PLASTICO POLASEAL 1/2 OF 170X226MM 100X1
 Código: 28213 Fábrica: MASTERPRINT Unidade: CE/100
 F1 F4



PLASTICO PP CRISTAL 0,10X1380MMX50MTS
 Código: 42030 Fábrica: PLAST CO Unidade: RL/1
 F1 F4



PLASTICO PP CRISTAL 0,20X1380MMX50MTS
 Código: 42032 Fábrica: PLAST CO Unidade: RL/1
 F1 F4

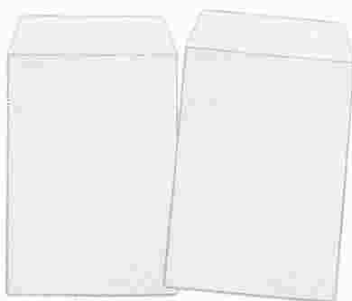

PLASTICO PROT IDENTIDADE 10X7,4CM 100X1
 Código: 26708 Fábrica: PLADL Unidade: CE/100
 F1 F4



PORTA CANETAS TRIPLO CRISTAL 240X70X80MM
 Código: 42739 Fábrica: DELLO Unidade: UN/1
 F1 F4



PORTA CANETAS TRIPLO FUME 240X70X80MM
 Código: 42740 Fábrica: DELLO Unidade: UN/1
 F1 F4



PORTA CARIMBOS ACRIL CRISTAL 6 LUG 3060
 Código: 46005 Fábrica: ACRINIL Unidade: UN/1
 F1 F4



PORTA CARIMBOS ACRIL FUME 6 LUG 3061
 Código: 46006 Fábrica: ACRINIL Unidade: UN/1
 F1 F4



PORTA CARIMBOS GIRATORIO 8LUGA METAL 165
 Código: 43748 Fábrica: CARBRINK Unidade: UN/1
 F1 F4

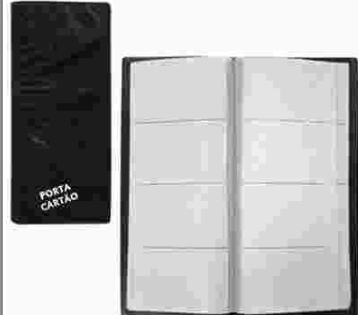

PORTA CARTOES TELEFONICO 10 PLASTICOS
 Código: 7052 Fábrica: DAC. Unidade: UN/1
 F1 F4



PORTA CLIPS ACR FUME MAGNET 42X62MM 7123
 Código: 42811 Fábrica: YIN'S PAPER Unidade: UN/1
 F1 F4



PORTA CLIPS 42MMX62MM 2041
 Código: 42064 Fábrica: MASTERPRINT Unidade: UN/1
 F1 F4

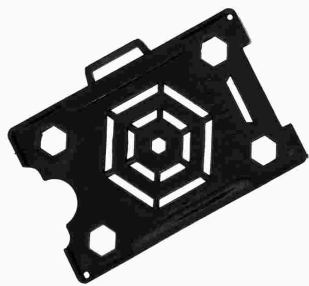

PORTA CRACHA PLAST PRETO UN
 Código: 44274 Fábrica: ITALY'S Unidade: UN/1
 F1 F4

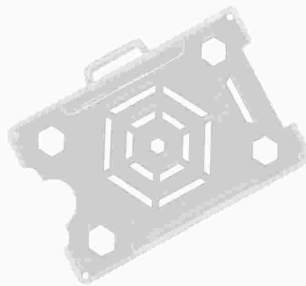

PORTA CRACHA PLAST TRANSPARENTE UN
 Código: 44273 Fábrica: ITALY'S Unidade: UN/1
 F1 F4



PORTA LAPIS ACRIL DUPLO CRISTAL 939.3
 Código: 40883 Fábrica: ACRIMET Unidade: UN/1
 F1 F4



PORTA LAPIS CARROS 00952
 Código: 48589 Fábrica: WIN PAPER Unidade: UN/1
 F1 F4

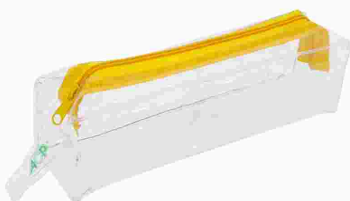

PORTA LAPIS CRISTAL JOY 22CM AMARE 21974
 Código: 46116 Fábrica: ACP Unidade: UN/1
 F1 F4



PORTA LAPIS CRISTAL JOY 22CM LARA 21974
 Código: 46118 Fábrica: ACP Unidade: UN/1
 F1 F4



PORTA LAPIS CRISTAL JOY 22CM PINK 21974
 Código: 46117 Fábrica: ACP Unidade: UN/1
 F1 F4



PORTA LAPIS GAME 00948
 Código: 48587 Fábrica: WIN PAPER Unidade: UN/1
 F1 F4



PORTA LAPIS INF BRANCA DE NEVE ES4629
 Código: 49027 Fábrica: PONTO VERDE Unidade: UN/1
 F1 F4



PORTA LAPIS INF FEM BEE FRIENDS ES4805
 Código: 49073 Fábrica: PONTO VERDE Unidade: UN/1
 F1 F4



PORTA LAPIS INF FEM CANDY GIRL ES4609
 Código: 49198 Fábrica: PONTO VERDE Unidade: UN/1
 F1 F4



PORTA LAPIS INF FEM FAMILY SHARK 4193
 Código: 44051 Fábrica: PONTO VERDE Unidade: UN/1
 F1 F4



PORTA LAPIS INF FEM RAINBOW ES4962
 Código: 49075 Fábrica: PONTO VERDE Unidade: UN/1
 F1 F4



PORTA LAPIS INF FEM SEREIA ES4811
 Código: 49076 Fábrica: PONTO VERDE Unidade: UN/1
 F1 F4



PORTA LAPIS INF FEM 3 PRINCESAS ES4827
 Código: 49071 Fábrica: PONTO VERDE Unidade: UN/1
 F1 F4



PORTA LAPIS INF KIDS PLAY ES4821

Código: 49074 Fábrica: PONTO VERDE Unidade: UN/1
F1 F4



PORTA LAPIS INF LINHA SETINADO ES4875

Código: 49029 Fábrica: PONTO VERDE Unidade: UN/1
F1 F4



PORTA LAPIS INF MASC BATTLE ES4849

Código: 49072 Fábrica: PONTO VERDE Unidade: UN/1
F1 F4



PORTA LAPIS INF MASC BLOCK GAME ES4853

Código: 49026 Fábrica: PONTO VERDE Unidade: UN/1
F1 F4



PORTA LAPIS INF MASC BLOCK GAME 4188

Código: 44052 Fábrica: PONTO VERDE Unidade: UN/1
F1 F4



PORTA LAPIS INF MASC GUARDIAN NIGHT 4179

Código: 44406 Fábrica: PONTO VERDE Unidade: UN/1
F1 F4



PORTA LAPIS INF MASC KARKS KIDS ES4669

Código: 48987 Fábrica: PONTO VERDE Unidade: UN/1
F1 F4



PORTA LAPIS INF MASC SPEED WEB ES4649

Código: 48988 Fábrica: PONTO VERDE Unidade: UN/1
F1 F4



PORTA LAPIS INF PRINCESS EVA 3D ES5041

Código: 49028 Fábrica: PONTO VERDE Unidade: UN/1
F1 F4



PORTA LAPIS INF SEREIA ES4619

Código: 49030 Fábrica: PONTO VERDE Unidade: UN/1
F1 F4



PORTA LAPIS JUVENIL FEM ES4289

Código: 48955 Fábrica: PONTO VERDE Unidade: UN/1
F1 F4



PORTA LAPIS JUVENIL FEM MH 4321

Código: 44027 Fábrica: PONTO VERDE Unidade: UN/1
F1 F4



PORTA LAPIS JUVENIL FEM TOP MODEL TM28ES

Código: 48958 Fábrica: PONTO VERDE Unidade: UN/1
F1 F4



PORTA LAPIS JUVENIL FEM VKG ES4299

Código: 49180 Fábrica: PONTO VERDE Unidade: UN/1
F1 F4



PORTA LAPIS JUVENIL FEM VKG 4261ES

Código: 48959 Fábrica: PONTO VERDE Unidade: UN/1
F1 F4



PORTA LAPIS JUVENIL FEM VKG 4262ES

Código: 48957 Fábrica: PONTO VERDE Unidade: UN/1
F1 F4



PORTA LAPIS JUVENIL FEM VKG 4310

Código: 44399 Fábrica: PONTO VERDE Unidade: UN/1
F1 F4



PORTA LAPIS JUVENIL SUPER HOT SBC ES3440

Código: 34221 Fábrica: SBC Unidade: UN/1
F1 F4



PORTA LAPIS JUVENIL WOOKEY ES3467

Código: 34233 Fábrica: SBC Unidade: UN/1
F1 F4



PORTA LAPIS JUVENIL WOOKEY ES3696

Código: 34224 Fábrica: SBC Unidade: UN/1
F1 F4

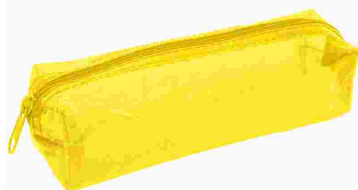

PORTA LAPIS LIGHTS TEEN 22CM AMARE 21966

Código: 46112 Fábrica: ACP Unidade: UN/1
F1 F4



PORTA LAPIS LIGHTS TEEN 22CM LARAN 21966

Código: 46113 Fábrica: ACP Unidade: UN/1
F1 F4



PORTA LAPIS LIGHTS TEEN 22CM PINK 21966

Código: 46115 Fábrica: ACP Unidade: UN/1
F1 F4



PORTA LAPIS LIGHTS TEEN 22CM VERDE 21966

Código: 46114 Fábrica: ACP Unidade: UN/1
F1 F4



PORTA LAPIS LONA C/VIVO GDE AZUL BCO

Código: 30523 Fábrica: JC Unidade: UN/1
F1 F4



PORTA LAPIS LONA C/VIVO GDE PTO BCO

Código: 30522 Fábrica: JC Unidade: UN/1
F1 F4



PORTA LAPIS LONA ESTAMP 1 DIV 146

Código: 46700 Fábrica: AC BAG Unidade: UN/1
F1 F4



PORTA LAPIS LONA ESTAMP 2 DIV 147

Código: 46701 Fábrica: AC BAG Unidade: UN/1
F1 F4



PORTA LAPIS LONA LISO 1 DIV 149/132

Código: 46702 Fábrica: AC BAG Unidade: UN/1
F1 F4



PORTA LAPIS LONA PRETO 125004

Código: 37792 Fábrica: BAD BOY Unidade: UN/1
F1 F4



PORTA LAPIS LONA PRETO 125204

Código: 37791 Fábrica: BAD BOY Unidade: UN/1
F1 F4



PORTA LAPIS LONA PRETO 125304

Código: 37790 Fábrica: BAD BOY Unidade: UN/1
F1 F4



PORTA LAPIS LONA PRETO 125504

Código: 37793
 Fábrica: BAD BOY
 Unidade: UN/1
 F1 F4



PORTA LAPIS LONA 1 DIV CAMUFLADO

Código: 21403
 Fábrica: KADU
 Unidade: UN/1
 F1 F4



PORTA LAPIS LONA 1 DIV CORES

Código: 30514
 Fábrica: KADU
 Unidade: UN/1
 F1 F4



PORTA LAPIS LONA 2 DIV ATLETICO

Código: 28051
 Fábrica: KADU
 Unidade: UN/1
 F1 F4



PORTA LAPIS LONA 2 DIV BARBIE

Código: 23373
 Fábrica: KADU
 Unidade: UN/1
 F1 F4



PORTA LAPIS LONA 2 DIV BAT MAN

Código: 21523
 Fábrica: KADU
 Unidade: UN/1
 F1 F4



PORTA LAPIS LONA 2 DIV BEN 10

Código: 23369
 Fábrica: KADU
 Unidade: UN/1
 F1 F4



PORTA LAPIS LONA 2 DIV CARROS

Código: 26644
 Fábrica: KADU
 Unidade: UN/1
 F1 F4



PORTA LAPIS LONA 2 DIV CRUZEIRO

Código: 29819
 Fábrica: KADU
 Unidade: UN/1
 F1 F4



PORTA LAPIS LONA 2 DIV FEM LILO & STITCH

Código: 49262
 Fábrica: KADU
 Unidade: UN/1
 F1 F4



PORTA LAPIS LONA 2 DIV FEM PATRULH CANIN

Código: 49257
 Fábrica: KADU
 Unidade: UN/1
 F1 F4



PORTA LAPIS LONA 2 DIV FEM UNICORNIO

Código: 49260
 Fábrica: KADU
 Unidade: UN/1
 F1 F4



PORTA LAPIS LONA 2 DIV FLAMENGO

Código: 46927
 Fábrica: KADU
 Unidade: UN/1
 F1 F4



PORTA LAPIS LONA 2 DIV FROZEN

Código: 49258
 Fábrica: KADU
 Unidade: UN/1
 F1 F4



PORTA LAPIS LONA 2 DIV HOMEM ARANHA

Código: 23370
 Fábrica: KADU
 Unidade: UN/1
 F1 F4



PORTA LAPIS LONA 2 DIV HOT WHEELS

Código: 23371
 Fábrica: KADU
 Unidade: UN/1
 F1 F4



PORTA LAPIS LONA 2 DIV LIGA DA JUSTICA

Código: **21524** Fábrica: **KADU** Unidade: **UN/1**
F1 F4



PORTA LAPIS LONA 2 DIV LOL

Código: **49259** Fábrica: **KADU** Unidade: **UN/1**
F1 F4



PORTA LAPIS LONA 2 DIV MARIE

Código: **24749** Fábrica: **KADU** Unidade: **UN/1**
F1 F4



PORTA LAPIS LONA 2 DIV MARIO

Código: **49248** Fábrica: **KADU** Unidade: **UN/1**
F1 F4



PORTA LAPIS LONA 2 DIV MASC COLOR

Código: **31801** Fábrica: **KADU** Unidade: **UN/1**
F1 F4



PORTA LAPIS LONA 2 DIV MASC DIVERTIDAMEN

Código: **49378** Fábrica: **KADU** Unidade: **UN/1**
F1 F4



PORTA LAPIS LONA 2 DIV MASC PATRULHA CAN

Código: **49252** Fábrica: **KADU** Unidade: **UN/1**
F1 F4



PORTA LAPIS LONA 2 DIV MASC STITCH

Código: **49251** Fábrica: **KADU** Unidade: **UN/1**
F1 F4



PORTA LAPIS LONA 2 DIV MASC YUGIOH

Código: **49253** Fábrica: **KADU** Unidade: **UN/1**
F1 F4



PORTA LAPIS LONA 2 DIV MINECRAFT

Código: **49246** Fábrica: **KADU** Unidade: **UN/1**
F1 F4



PORTA LAPIS LONA 2 DIV MINNIE

Código: **49256** Fábrica: **KADU** Unidade: **UN/1**
F1 F4



PORTA LAPIS LONA 2 DIV MORANGUINHO

Código: **23377** Fábrica: **KADU** Unidade: **UN/1**
F1 F4



PORTA LAPIS LONA 2 DIV NARUTO

Código: **23372** Fábrica: **KADU** Unidade: **UN/1**
F1 F4



PORTA LAPIS LONA 2 DIV PEQUENA SEREIA

Código: **49254** Fábrica: **KADU** Unidade: **UN/1**
F1 F4



PORTA LAPIS LONA 2 DIV PJ MASK

Código: **21534** Fábrica: **KADU** Unidade: **UN/1**
F1 F4



PORTA LAPIS LONA 2 DIV POKEMON

Código: **25549** Fábrica: **KADU** Unidade: **UN/1**
F1 F4



PORTA LAPIS LONA 2 DIV PRINCESAS

Código: 21525 Fábrica: KADU Unidade: UN/1
F1 F4



PORTA LAPIS LONA 2 DIV PRINCESINHA SOFIA

Código: 49261 Fábrica: KADU Unidade: UN/1
F1 F4



PORTA LAPIS LONA 2 DIV SONIC

Código: 49249 Fábrica: KADU Unidade: UN/1
F1 F4



PORTA LAPIS LONA 2 DIV SUPER MAN

Código: 21668 Fábrica: KADU Unidade: UN/1
F1 F4



PORTA LAPIS LONA 2 DIV VINGADORES

Código: 49250 Fábrica: KADU Unidade: UN/1
F1 F4



PORTA LAPIS LONA 2 DIV WANDINHA

Código: 49255 Fábrica: KADU Unidade: UN/1
F1 F4



PORTA LAPIS LONA 3 DIV CAMUFLADO

Código: 23415 Fábrica: KADU Unidade: UN/1
F1 F4



PORTA LAPIS LONA 3 DIV FEM COLOR

Código: 23413 Fábrica: KADU Unidade: UN/1
F1 F4



PORTA LAPIS LONA 3 DIV MASC

Código: 31800 Fábrica: KADU Unidade: UN/1
F1 F4



PORTA LAPIS MASC PATCHES 20021

Código: 45945 Fábrica: WINTH TEEN Unidade: UN/1
F1 F4



PORTA LAPIS MINI PU 692

Código: 44806 Fábrica: WIN PAPER Unidade: UN/1
F1 F4



PORTA LAPIS MINI PU 694

Código: 44807 Fábrica: WIN PAPER Unidade: UN/1
F1 F4



PORTA LAPIS NYLON 00953

Código: 48585 Fábrica: WIN PAPER Unidade: UN/1
F1 F4

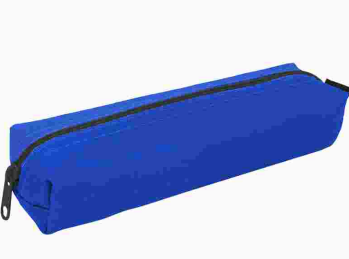

PORTA LAPIS NYLON 22CM AZUL 21975AZ

Código: 46119 Fábrica: ACP Unidade: UN/1
F1 F4



PORTA LAPIS NYLON 22CM PRETO 21975PT

Código: 46120 Fábrica: ACP Unidade: UN/1
F1 F4

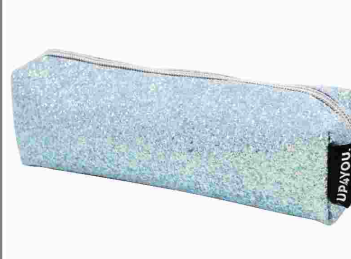

PORTA LAPIS PVC AZUL 55042UP-AZ

Código: 47702 Fábrica: LUXCEL Unidade: UN/1
F1 F4



PORTA LAPIS PVC NEON COLOR 27099

Código: 43449 Fábrica: CONVOY Unidade: UN/1 F1 F4



PORTA LAPIS PVC PRATA 55042UP-PR

Código: 47704 Fábrica: LUXCEL Unidade: UN/1 F1 F4



PORTA LAPIS PVC ROSA 55042UP-RA

Código: 47703 Fábrica: LUXCEL Unidade: UN/1 F1 F4

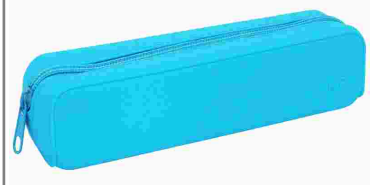

PORTA LAPIS SILICONE 20CM AZUL 21976AZ

Código: 46108 Fábrica: ACP Unidade: UN/1 F1 F4

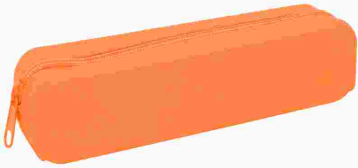

PORTA LAPIS SILICONE 20CM LARANJA 21976L

Código: 46111 Fábrica: ACP Unidade: UN/1 F1 F4

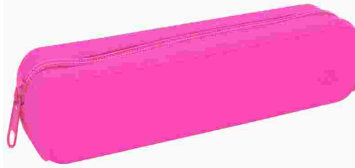

PORTA LAPIS SILICONE 20CM PINK 21976PK

Código: 46109 Fábrica: ACP Unidade: UN/1 F1 F4

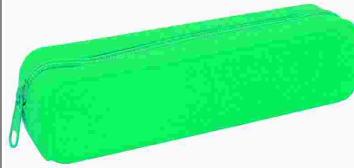

PORTA LAPIS SILICONE 20CM VERDE 21976VD

Código: 46110 Fábrica: ACP Unidade: UN/1 F1 F4



PORTA LAPIS SPORT 00955

Código: 48584 Fábrica: WIN PAPER Unidade: UN/1 F1 F4



PORTA LAPIS SPORTS 00946

Código: 48586 Fábrica: WIN PAPER Unidade: UN/1 F1 F4

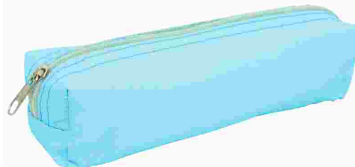

PORTA LAPIS TEEN CAIRO 20CM AZUL 21964

Código: 46122 Fábrica: ACP Unidade: UN/1 F1 F4

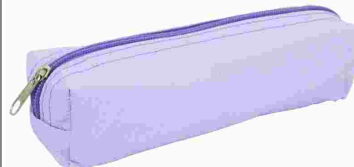

PORTA LAPIS TEEN CAIRO 20CM LILAS 21964

Código: 46123 Fábrica: ACP Unidade: UN/1 F1 F4



PORTA LAPIS TEEN CAIRO 20CM ROSA 21964

Código: 46124 Fábrica: ACP Unidade: UN/1 F1 F4

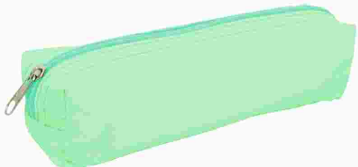

PORTA LAPIS TEEN CAIRO 20CM VERDE 21964

Código: 46125 Fábrica: ACP Unidade: UN/1 F1 F4



PORTA LAPIS TEEN SINT AZUL 19949

Código: 35695 Fábrica: ACP Unidade: UN/1 F1 F4



PORTA LAPIS TEEN SINT BEGE 19955

Código: 35690 Fábrica: ACP Unidade: UN/1 F1 F4

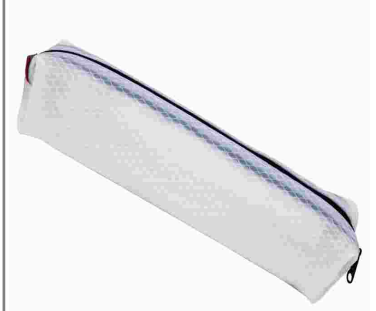

PORTA LAPIS 1Z TELA 552

Código: 44804 Fábrica: WINTH Unidade: UN/1 F1 F4



PORTA LAPIS 2 DIV JEANS FEM EST DET COR

Código: **34385** Fábrica: **LITA** Unidade: **UN/1**
F1 F4



PORTA LAPIS 2 DIV LONA COLOR LISO 801

Código: **26984** Fábrica: **LITA** Unidade: **UN/1**
F1 F4



PORTA LAPIS 2 DIV LONA C/VIVO

Código: **21402** Fábrica: **JC** Unidade: **UN/1**
F1 F4



PORTA LAPIS 2 DIV LONA C/VIVO FEM PERS

Código: **30515** Fábrica: **JC** Unidade: **UN/1**
F1 F4



PORTA LAPIS 2 DIV LONA C/VIVO MASC PERS

Código: **30516** Fábrica: **JC** Unidade: **UN/1**
F1 F4



PORTA LAPIS 9CM ARAMADO RED PRETO 8244PT

Código: **46334** Fábrica: **KAZ** Unidade: **UN/1**
F1 F4

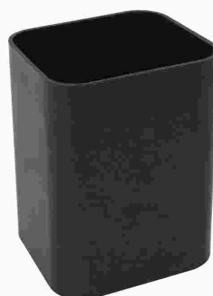

PORTA OBJETOS PLAST 10X8CM PRETO 289

Código: **50157** Fábrica: **CARBRINK** Unidade: **UN/1**
F1 F4



30cm
25cm
8,5cm

PORTA REVISTAS 25X8,5X30CM CRISTAL 046

Código: **44681** Fábrica: **MAXCRIL** Unidade: **UN/1**
F1 F4



POST-IT BL ADES 37X50MM 100FLS NEON 4X1

Código: **42799** Fábrica: **INTERPONTE** Unidade: **PT/1**
F1 F4



POST-IT BL ADES 37,5X50MM NEO 100FL 4X1

Código: **46069** Fábrica: **MASTERPRINT** Unidade: **PT/100**
F1 F4



POST-IT BL ADES 37,5X50MM 100FL AMAR 4X1

Código: **42891** Fábrica: **MASTERPRINT** Unidade: **PT/100**
F1 F4

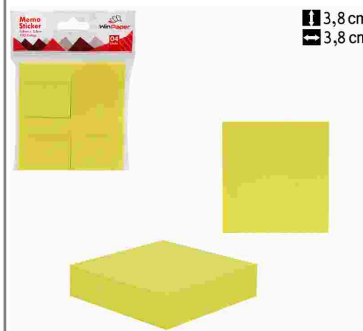

3,8 cm
3,8 cm

POST-IT BL ADES 38X38MM 100F 4X1

Código: **40320** Fábrica: **WINCY** Unidade: **PT/1**
F1 F4



POST-IT BL ADES 38X38MM 85406 4X1

Código: **42800** Fábrica: **INTERPONTE** Unidade: **PT/1**
F1 F4



POST-IT BL ADES 38X50MM 100FLS ROSA 4X1

Código: **46372** Fábrica: **JOCAROFFICE** Unidade: **PT/4**
F1 F4



POST-IT BL ADES 38X50MM 100FLS VERDE 4X1

Código: **46371** Fábrica: **JOCAROFFICE** Unidade: **PT/4**
F1 F4



POST-IT BL ADES 38X50MM 100FLS 4X1

Código: **41945** Fábrica: **OFF PAPER** Unidade: **PT/4**
F1 F4



POST-IT BL ADES 38X50MM 100FLS 4X1
 Código: 45227 Fábrica: JOCAROFFICE Unidade: PT/4
 F1 F4



POST-IT BL ADES 38X50MM 100FLS 4X1
 Código: 43090 Fábrica: PLANETA Unidade: PT/4
 F1 F4



POST-IT BL ADES 38X50MM 100FLS 4X1
 Código: 44106 Fábrica: FUTURO Unidade: PT/4
 F1 F4



POST-IT BL ADES 38X50MM 3CORES 400FLS
 Código: 48327 Fábrica: BAZZE Unidade: PT/400
 F1 F4



POST-IT BL ADES 38X51MM 100F 3801 4X1
 Código: 34129 Fábrica: BRW Unidade: PT/4
 F1 F4



POST-IT BL ADES 38X51MM 50FL 3850 4X1
 Código: 38014 Fábrica: BRW Unidade: PT/4
 F1 F4

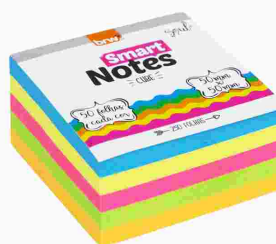

POST-IT BL ADES 50X50MM 250FL 5050 5X1
 Código: 46828 Fábrica: BRW Unidade: PT/5
 F1 F4



POST-IT BL ADES 50X50MM 400FL COSMOS 4X1
 Código: 49500 Fábrica: TRIS Unidade: PT/4
 F1 F4



POST-IT BL ADES 50X50MM 400FL KRAFT 4X1
 Código: 49499 Fábrica: TRIS Unidade: PT/4
 F1 F4



POST-IT BL ADES 75X75MM 100FL AMARE 2010
 Código: 45122 Fábrica: MASTERPRINT Unidade: UN/1
 F1 F4

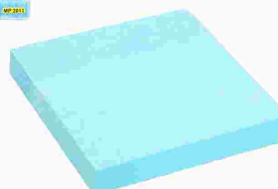

POST-IT BL ADES 75X75MM 100FL AZUL 2013
 Código: 47209 Fábrica: MASTERPRINT Unidade: UN/1
 F1 F4



POST-IT BL ADES 75X75MM 100FL ROSA 2011
 Código: 47210 Fábrica: MASTERPRINT Unidade: UN/1
 F1 F4

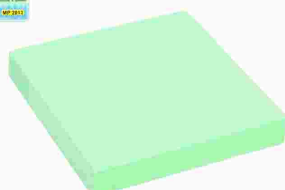

POST-IT BL ADES 75X75MM 100FL VERDE 2012
 Código: 47211 Fábrica: MASTERPRINT Unidade: UN/1
 F1 F4

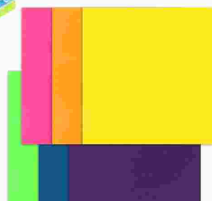

POST-IT BL ADES 75X75MM 495FLS 53105
 Código: 46445 Fábrica: INTERPONTE Unidade: PT/1
 F1 F4



POST-IT BL ADES 75X75MM 50FL TRANSP 584
 Código: 49504 Fábrica: TRIS Unidade: PT/1
 F1 F4

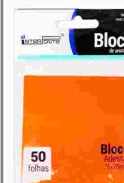

POST-IT BL ADES 75X75MM 50FLS TRANSP 415
 Código: 46443 Fábrica: INTERPONTE Unidade: PT/1
 F1 F4

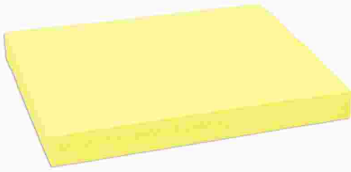

POST-IT BL ADES 76X102MM AMARELO 100FLS
 Código: 48328 Fábrica: BAZZE Unidade: PT/100
 F1 F4

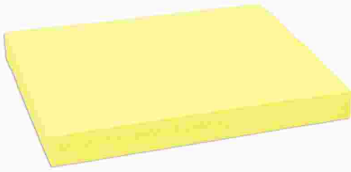

POST-IT BL ADES 76X102MM 100FLS
 Código: 46373 Fábrica: JOCAROFFICE Unidade: UN/1
 F1 F4

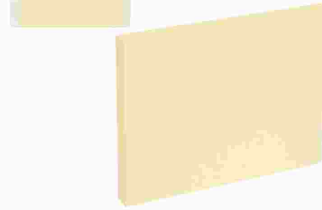

POST-IT BL ADES 76X102MM 100FLS
 Código: 41904 Fábrica: LIKE Unidade: UN/1
 F1 F4



POST-IT BL ADES 76X102MM 100FLS 2020
 Código: 45121 Fábrica: MASTERPRINT Unidade: UN/1
 F1 F4



POST-IT BL ADES 76X127MM 100FLS CORES
 Código: 46442 Fábrica: INTERPONTE Unidade: PT/1
 F1 F4



POST-IT BL ADES 76X76MM AMARELO 100FLS
 Código: 48326 Fábrica: BAZZE Unidade: PT/100
 F1 F4

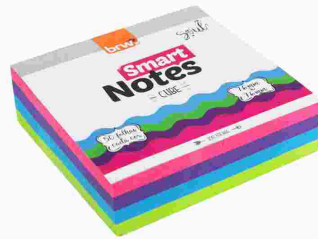

POST-IT BL ADES 76X76MM 200FLS 7601
 Código: 46829 Fábrica: BRW Unidade: PT/200
 F1 F4



POST-IT BL ADES 76X76MM 4CORES 400FLS
 Código: 48325 Fábrica: BAZZE Unidade: PT/400
 F1 F4

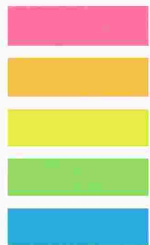

POST-IT MARCA PAG NEON RETO 25F 2030 5X1
 Código: 42245 Fábrica: MASTERPRINT Unidade: PT/125
 F1 F4



POST-IT MARCA PAG NEON SETA 25F 2031 5X1
 Código: 43615 Fábrica: MASTERPRINT Unidade: PT/5
 F1 F4



POST-IT MARCA PAG SETA NEON 125F 12X44MM
 Código: 43196 Fábrica: BRW Unidade: CR/1
 F1 F4



POST-IT MARCA PAG SETA 125F 4.4X1,2CM
 Código: 50965 Fábrica: IMPORIENTE Unidade: CR/1
 F1 F4



POST-IT MARCA PAG SETA 15F 91128 10X1
 Código: 46374 Fábrica: JOCAROFFICE Unidade: CR/1
 F1 F4



POST-IT MARCA PAG SETA 25F 49032 6X1
 Código: 46251 Fábrica: IMPORIENTE Unidade: CR/1
 F1 F4



POST-IT MARCA PAG 20FLS 5X1
 Código: 43091 Fábrica: PLANETA Unidade: PT/5
 F1 F4

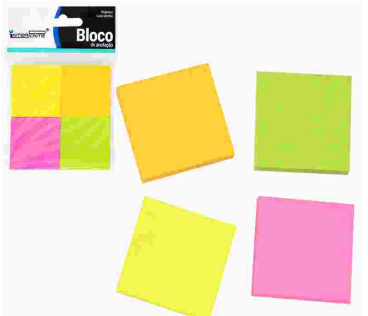

POST-IT MARCA PAG 25X76MM 100FLS 4X1
 Código: 42801 Fábrica: INTERPONTE Unidade: PT/1
 F1 F4



POST-IT MARCA PAGINAS AD 19X76MM 4X1

Código: 42409 Fábrica: BRW Unidade: PT/4
F1 F4



POST-IT MARCA PAG+REGUA 12X44MM 02 175X1

Código: 36115 Fábrica: BRW Unidade: PT/175
F1 F4



POST-IT MARCA PAG+REGUA 12X45MM 8X25

Código: 48142 Fábrica: YIN'S PAPER Unidade: PT/200
F1 F4



PRANCHETA ACR A4 CRISTAL PREND METAL 120

Código: 43211 Fábrica: ACRINIL Unidade: UN/1
F1 F4



PRANCHETA ACR A4 POP PREND PLAST 131

Código: 37441 Fábrica: ACRIMET Unidade: UN/1
F1 F4



PRANCHETA ACR A4 PREND METAL 131

Código: 21130 Fábrica: NOVACR/ACRIM Unidade: UN/1
F1 F4



PRANCHETA ACR OF CRISTAL PREND MET 930.3

Código: 40478 Fábrica: MAXCRIL Unidade: UN/1
F1 F4



PRANCHETA ACR OF CRISTAL PREND PLAST

Código: 41965 Fábrica: CARBRINK Unidade: UN/1
F1 F4



PRANCHETA ACR OF FUME PREND METAL 930.1

Código: 40479 Fábrica: MAXCRIL Unidade: UN/1
F1 F4



PRANCHETA ACR OF PRETA PREND PLAST C/RE

Código: 42411 Fábrica: CARBRINK Unidade: UN/1
F1 F4

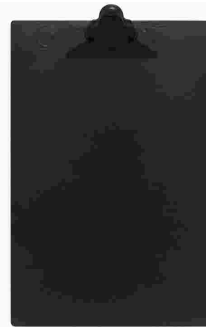

PRANCHETA ACR OF PRETA PREND PLAST 5038

Código: 41796 Fábrica: CARBRINK Unidade: UN/1
F1 F4



PRANCHETA ACR 1/2 OF CRISTAL P METAL 130

Código: 46004 Fábrica: ACRINIL Unidade: UN/1
F1 F4



PRANCHETA ACR 1/2 OF FUME P METAL 920.1

Código: 40879 Fábrica: ACRIMET Unidade: UN/1
F1 F4



PRANCHETA EUCATEX OF PREND METAL

Código: 42186 Fábrica: BACCHI Unidade: UN/1
F1 F4



PRANCHETA EUCATEX OF PREND METAL 501

Código: 49833 Fábrica: CAVIA Unidade: UN/1
F1 F4



PRANCHETA EUCATEX 1/2 OF PREND METAL 502

Código: 49832 Fábrica: CAVIA Unidade: UN/1
F1 F4



23 cm
16 cm

PRANCHETA INF CANET+PAPEL 16X23CM 603397

Código: 32579 Fábrica: MAX PING Unidade: UN/1 F1 F4



PRANCHETA MDF CRU OF PREND METAL 8289

Código: 44671 Fábrica: STALO Unidade: UN/1 F1 F4

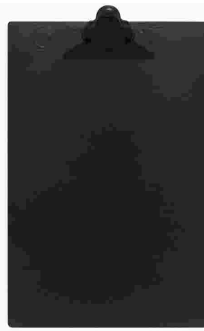

PRANCHETA PLAST A4 PRETA PREND METAL 050

Código: 50155 Fábrica: CARBRINK Unidade: UN/1 F1 F4



PRANCHETA POLIONDA CRISTAL

Código: 46076 Fábrica: ALAPLAST Unidade: UN/1 F1 F4



PRANCHETA POLIONDA FUME

Código: 46078 Fábrica: ALAPLAST Unidade: UN/1 F1 F4



PRANCHETA POLIONDA PRETA

Código: 46077 Fábrica: ALAPLAST Unidade: UN/1 F1 F4

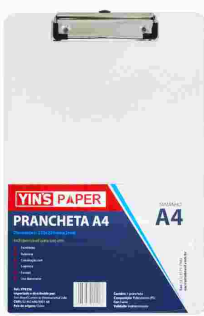

PRANCHETA PS A4 CRISTAL PREND METAL 8358

Código: 48149 Fábrica: YIN'S PAPER Unidade: UN/1 F1 F4

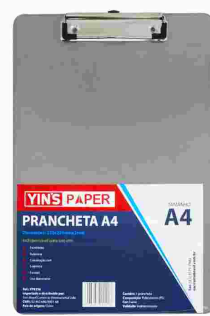

PRANCHETA PS A4 FUME PREND METAL 8356

Código: 48150 Fábrica: YIN'S PAPER Unidade: UN/1 F1 F4



PRENDEDOR ZINCADO P/PAPEL 75MM 175 12X1

Código: 49834 Fábrica: CAVIA Unidade: PT/12 F1 F4



PRENDEDOR ZINCADO P/PAPEL 75MM 192 12X1

Código: 45415 Fábrica: CARBRINK Unidade: PT/12 F1 F4



PRENDEDOR ZINCADO P/PAPEL 95MM 190 12X1

Código: 45414 Fábrica: CARBRINK Unidade: PT/12 F1 F4



PRIMER P/METAL/PET/VIDRO 100 ML 519 BCO

Código: 44113 Fábrica: ACRILEX Unidade: UN/1 F1 F4



PROTECTOR ACRILICO P/RG 0,050MM 20X1

Código: 44604 Fábrica: MAXIPLASTICO Unidade: PT/20 F1 F4



PROTECTOR ACRILICO RIGIDO CNH 10X1

Código: 30085 Fábrica: MP Unidade: PT/10 F1 F4



PROTECTOR A1 P/CRACHA CRISTAL 10X7CM 20X1

Código: 41975 Fábrica: VMP Unidade: PT/20 F1 F4



PROTECTOR PLAST P/CD 13X13CM P-17 10X1

Código: 46176 Fábrica: ACP Unidade: PT/10 F1 F4



PROTETOR PORTA DOCUMEN 70X105CM P7 100X1
 Código: 46203 Fábrica: ACP Unidade: PT/100
 F1 F4



PROTETOR PORTA DOCUMENT 65X90CM P6 100X1
 Código: 46202 Fábrica: ACP Unidade: PT/100
 F1 F4

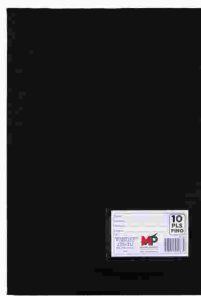

PROTETOR PORTIF A4 10 PLAST PRETO
 Código: 44595 Fábrica: MAXIPLASTICO Unidade: UN/1
 F1 F4



PROTETOR PORTIF A4 30 PLAST PRETO
 Código: 44596 Fábrica: MAXIPLASTICO Unidade: UN/1
 F1 F4



PROTETOR PORTIF A4 50 PLAST PRETO
 Código: 44597 Fábrica: MAXIPLASTICO Unidade: UN/1
 F1 F4



PROTETOR PORTIF A4 50 PLAST VERMELHO
 Código: 44601 Fábrica: MAXIPLASTICO Unidade: UN/1
 F1 F4



PROTETOR PORTIF A4 100 PLAST PRETO
 Código: 44598 Fábrica: MAXIPLASTICO Unidade: UN/1
 F1 F4



PROTOTETOR ACRILICO P/DUT 0,050MM 20X1
 Código: 44602 Fábrica: MAXIPLASTICO Unidade: PT/20
 F1 F4



PURPURINA 3 GRS DOURADO 12X1
 Código: 15075 Fábrica: CITY BRILHO Unidade: CX/12
 F1 F4



PURPURINA 3 GRS PRATA 12X1
 Código: 15076 Fábrica: CITY BRILHO Unidade: CX/12
 F1 F4



PURPURINA 500 GRS DOURADO
 Código: 44253 Fábrica: TOK BIJOUXS Unidade: PT/1
 F1 F4



PURPURINA 500 GRS PRATA
 Código: 44254 Fábrica: TOK BIJOUXS Unidade: PT/1
 F1 F4

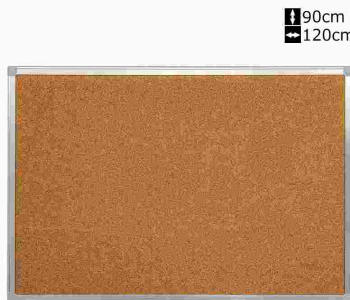

QUADRO AVISO CORTIC ALUM A 120X90CM 8213
 Código: 45817 Fábrica: STALO Unidade: UN/1
 F1 F4



QUADRO AVISO CORTIC ALUM 120X90CM
 Código: 42601 Fábrica: STALO Unidade: UN/1
 F1 F4

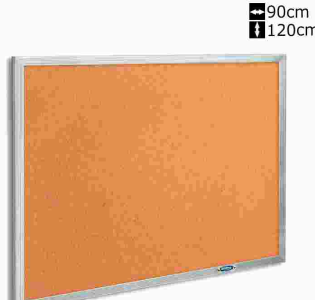

QUADRO AVISO CORTIC ALUM 120X90CM 2012
 Código: 46803 Fábrica: CORTIARTE Unidade: UN/1
 F1 F4



QUADRO AVISO CORTIC ALUM 90X60CM 9329
 Código: 42600 Fábrica: STALO Unidade: UN/1
 F1 F4



↑ 70 cm
↔ 100 cm

QUADRO AVISO CORTIC MAD 100X70CM
 Código: **42853** Fábrica: **STALO** Unidade: **UN/1**
F1 F4



↔ 200cm
↑ 120cm

QUADRO AVISO CORTIC MAD 120X200CM 1024
 Código: **49218** Fábrica: **CORTIARTE** Unidade: **UN/1**
F1 F4



↔ 90cm
↑ 120cm

QUADRO AVISO CORTIC MAD 120X90CM 1021
 Código: **45635** Fábrica: **CORTIARTE** Unidade: **UN/1**
F1 F4

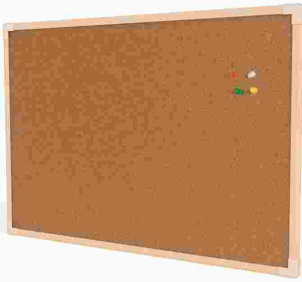

↑ 90 cm
↔ 120 cm

QUADRO AVISO CORTIC MAD 120X90CM 9341
 Código: **41954** Fábrica: **STALO** Unidade: **UN/1**
F1 F4



↑ 40 cm
↔ 60 cm

QUADRO AVISO CORTIC MAD 60X40CM 9333
 Código: **44150** Fábrica: **STALO** Unidade: **UN/1**
F1 F4



↑ 60 cm
↔ 90 cm

QUADRO AVISO CORTIC MAD 90X60CM
 Código: **42084** Fábrica: **STALO** Unidade: **UN/1**
F1 F4



↑ 40 cm
↔ 60 cm

QUADRO AVISO CORTIC MDF ALUM 060X040CM
 Código: **44146** Fábrica: **STALO** Unidade: **UN/1**
F1 F4



↑ 50 cm
↔ 70 cm

QUADRO AVISO CORTIC MDF ALUM 070X050CM
 Código: **44148** Fábrica: **STALO** Unidade: **UN/1**
F1 F4



↑ 70 cm
↔ 100 cm

QUADRO AVISO CORTIC MDF ALUM 090X060CM
 Código: **42602** Fábrica: **STALO** Unidade: **UN/1**
F1 F4



↑ 70 cm
↔ 100 cm

QUADRO AVISO CORTIC MDF ALUM 100X70CM
 Código: **44145** Fábrica: **STALO** Unidade: **UN/1**
F1 F4



↑ 90 cm
↔ 120 cm

QUADRO AVISO CORTIC MDF ALUM 120X90CM
 Código: **44153** Fábrica: **STALO** Unidade: **UN/1**
F1 F4



Unidade:
UN/1
F1 F4

QUADRO AVISO FELTRO MAD 90X60CM
 Código: **43005** Fábrica: **STALO**



↔ 120cm
↑ 90cm

QUADRO AVISO FELTRO MDF AL 120X90CM 5095
 Código: **50158** Fábrica: **STALO** Unidade: **UN/1**
F1 F4



↑ 60cm
↔ 90cm

QUADRO AVISO FELTRO STD ALUM 90X60CM
 Código: **45637** Fábrica: **CORTIARTE** Unidade: **UN/1**
F1 F4



↑ 90cm
↔ 120cm

QUADRO BCO MAGN MDF ALUM 120X90CM 4062
 Código: **44673** Fábrica: **STALO** Unidade: **UN/1**
F1 F4



↔ 150cm
↑ 120cm

QUADRO BCO MAGN MDF ALUM 150X120CM 4243
 Código: **50159** Fábrica: **STALO** Unidade: **UN/1**
F1 F4

60cm
90cm



QUADRO BCO MAGN MDF ALUM 90X60CM 4061
Código: 44672 Fábrica: STALO Unidade: UN/1
F1 F4



QUADRO BCO PLANEJ MENSAL MAD 90X60CM
Código: 50335 Fábrica: SOUZA Unidade: UN/1
F1 F4

200cm
120cm



QUADRO BRANCO MADEIRA 200X120CM 1323
Código: 49472 Fábrica: CORTIARTE Unidade: UN/1
F1 F4

60cm
90cm



QUADRO BRANCO MAG POP ALUM 120X90CM 64
Código: 49131 Fábrica: CORTIARTE Unidade: UN/1
F1 F4

90cm
120cm

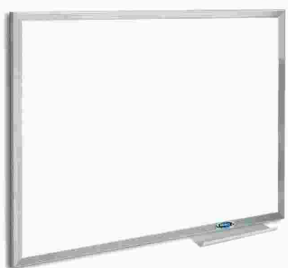

QUADRO BRANCO POP ALUM 120X90CM 2321
Código: 46802 Fábrica: CORTIARTE Unidade: UN/1
F1 F4

120cm
200cm



QUADRO BRANCO POP ALUM 200X120CM 2327
Código: 45636 Fábrica: CORTIARTE Unidade: UN/1
F1 F4

70 cm
100 cm



QUADRO BRANCO UV ALUM 100X70CM 9123
Código: 44144 Fábrica: STALO Unidade: UN/1
F1 F4

90 cm
120 cm



QUADRO BRANCO UV ALUM 120X090CM 9124
Código: 44152 Fábrica: STALO Unidade: UN/1
F1 F4

120 cm
200 cm

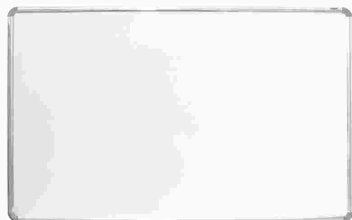

QUADRO BRANCO UV ALUM 200X120CM 8365
Código: 44143 Fábrica: STALO Unidade: UN/1
F1 F4

30 cm
40 cm



QUADRO BRANCO UV ALUM 40X30CM 9120
Código: 50193 Fábrica: STALO Unidade: UN/1
F1 F4

30 cm
40 cm



QUADRO BRANCO UV ALUM 40X30CM 9120
Código: 44142 Fábrica: STALO Unidade: UN/1
F1 F4

40 cm
60 cm



QUADRO BRANCO UV ALUM 60X40CM 9121
Código: 44147 Fábrica: STALO Unidade: UN/1
F1 F4

50 cm
70 cm



QUADRO BRANCO UV ALUM 70X50CM 9125
Código: 44151 Fábrica: STALO Unidade: UN/1
F1 F4

60 cm
90 cm



QUADRO BRANCO UV ALUM 90X60CM 9122
Código: 44149 Fábrica: STALO Unidade: UN/1
F1 F4

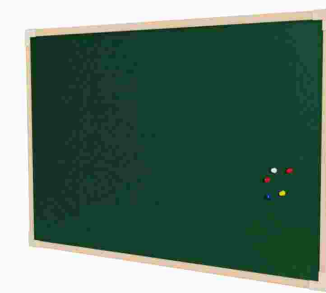

QUADRO BRANCO UV MAD 90X60CM 9329
Código: 43006 Fábrica: STALO Unidade: UN/1
F1 F4

120cm
200cm



QUADRO BRANCO UV MDF ALUM 200X120CM 4019
Código: 45622 Fábrica: STALO Unidade: UN/1
F1 F4



QUADRO FELTRO POP ALUM 120X90CM 1141
 Código: 49128 Fábrica: CORTIARTE Unidade: UN/1
 F1 F4



QUADRO PP A4 4,40MM MULTI USO CRISTAL
 Código: 34128 Fábrica: PLASCONY Unidade: UN/1
 F1 F4



QUADRO VERDE (LOUSA) 25X35CM 260
 Código: 13173 Fábrica: P A SOUZA Unidade: UN/1
 F1 F4



QUADRO VERDE (LOUSA) 35X45CM 261
 Código: 36392 Fábrica: P A SOUZA Unidade: UN/1
 F1 F4



QUADRO VERDE (LOUSA) 37X50CM 262
 Código: 6834 Fábrica: P A SOUZA Unidade: UN/1
 F1 F4



RECIBO SERVICO TAXI 105X150MM 50FLS 20X1
 Código: 39291 Fábrica: TAMOIO Unidade: PT/20
 F1 F4



REFIL APAGADOR QUADRO BCO MAGN 10X1
 Código: 45633 Fábrica: CORTIARTE Unidade: PT/10
 F1 F4



REFIL P/ MARCADOR QUADRO BCO AZUL 1001
 Código: 34131 Fábrica: BRW Unidade: UN/1
 F1 F4



REFIL P/ MARCADOR QUADRO BCO AZUL 991006
 Código: 48190 Fábrica: JOCAROFFICE Unidade: UN/1
 F1 F4



REFIL P/ MARCADOR QUADRO BCO PRET 991006
 Código: 48191 Fábrica: JOCAROFFICE Unidade: UN/1
 F1 F4



REFIL P/ MARCADOR QUADRO BCO PRETO 1002
 Código: 34130 Fábrica: BRW Unidade: UN/1
 F1 F4



REFIL P/ MARCADOR QUADRO BCO VERM 991006
 Código: 48192 Fábrica: JOCAROFFICE Unidade: UN/1
 F1 F4



REFIL P/ MARCADOR QUADRO BCO VERMEL 1003
 Código: 44161 Fábrica: BRW Unidade: UN/1
 F1 F4



REFIL P/FICHARIO 96 FLS BRANCO
 Código: 19581 Fábrica: TILIBRA Unidade: UN/1
 F1 F4

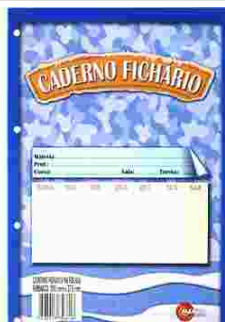

REFIL P/FICHARIO 96 FLS BRANCO 10X1
 Código: 33257 Fábrica: MAXIMA Unidade: PT/10
 F1 F4

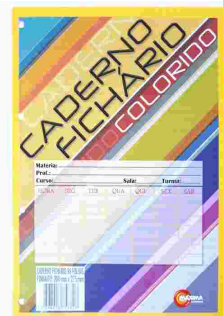

REFIL P/FICHARIO 96 FLS COLORIDO 10X1
 Código: 15285 Fábrica: MAXIMA Unidade: PT/10
 F1 F4



REFIL 1/4 P/FICHARIO 96 FLS PEQ 10X1
 Código: 9647 Fábrica: SULAMERICANA Unidade: PT/10
 F1 F4



REFILADORA DE PAPEL A4/A5 10 FLS
 Código: 44123 Fábrica: YIN'S PAPER Unidade: UN/1
 F1 F4



REGUA DE PULSO 20 CM MARIA CLARA & JP
 Código: 50328 Fábrica: FIRST Unidade: UN/1
 F1 F4

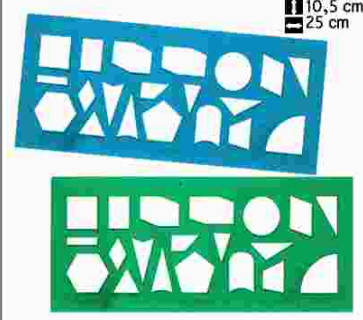

REGUA GEOMETRICA 10,5X25CM RG029
 Código: 33057 Fábrica: BUDEPLAST Unidade: UN/1
 F1 F4

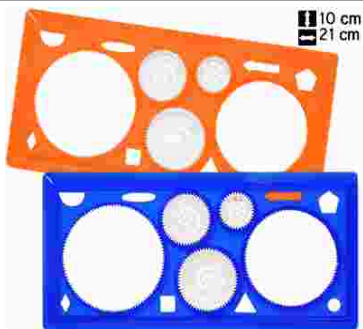

REGUA MAGICA 10X21CM RG029/032
 Código: 33058 Fábrica: BUDEPLAST Unidade: UN/1
 F1 F4



REGUA 1 METRO MADEIRA C/PEGADOR
 Código: 45184 Fábrica: STALO/SOUSA Unidade: UN/1
 F1 F4



REGUA 1 METRO METAL ACO INOX ESCALA 300
 Código: 45079 Fábrica: NYBC Unidade: UN/1
 F1 F4

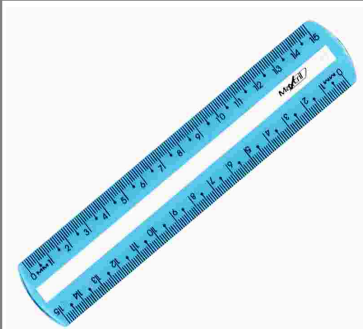

REGUA 15 CM GUIA LEITURA AZUL EMB IN10X1
 Código: 50763 Fábrica: MAXCRIL Unidade: PT/10
 F1 F4



REGUA 15 CM POWER RANGERS JUNGLE 36X1
 Código: 35684 Fábrica: TRIS Unidade: C//36
 F4

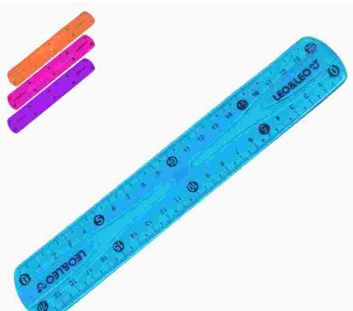

REGUA 20 CM FLEXIVEL COLOR 4567
 Código: 49114 Fábrica: LEO&LEO Unidade: UN/1
 F1 F4

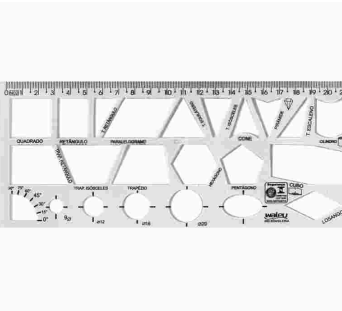

REGUA 21 CM GEOMETRICA CRISTAL 10X1
 Código: 21493 Fábrica: WALEU Unidade: PT/10
 F1 F4

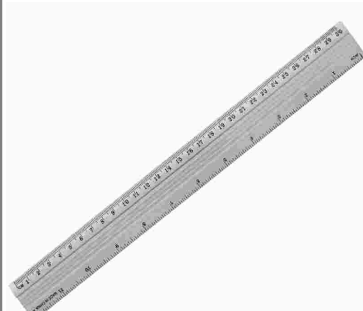

REGUA 30 CM ALUMINIO 1002810
 Código: 43088 Fábrica: PLANETA Unidade: UN/1
 F1 F4

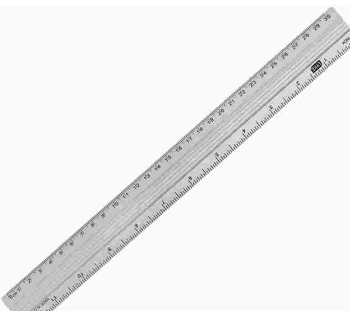

REGUA 30 CM ALUMINIO 101-014
 Código: 14678 Fábrica: LYKE Unidade: UN/1
 F1 F4

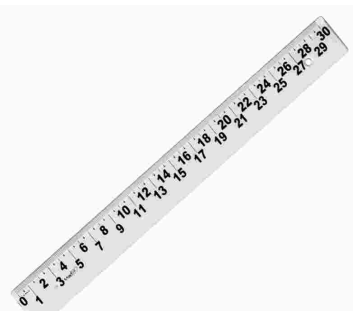

REGUA 30 CM BAIXA VISAO CRISTAL UN
 Código: 50767 Fábrica: MAXCRIL Unidade: UN/1
 F1 F4



REGUA 30 CM BAIXA VISAO CRISTAL 10X1
 Código: 50765 Fábrica: MAXCRIL Unidade: PT/10
 F1 F4

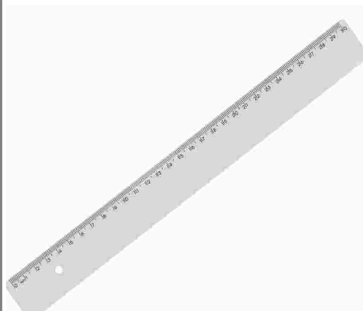

REGUA 30 CM BRANCA EMB IND 987.2 10X1
 Código: 40885 Fábrica: ACRIMET Unidade: PT/10
 F1 F4

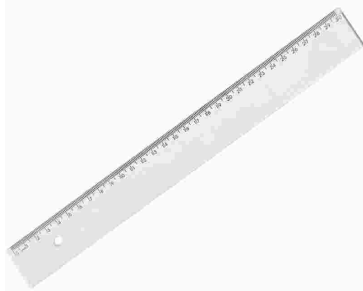

REGUA 30 CM CRISTAL EMB IND 984 10X1

Código: **37445** Fábrica: **ACRIMET** Unidade: **PT/10**
F1 F4



REGUA 30 CM CRISTAL EMBAL IND 981 24X1

Código: **32389** Fábrica: **ACRIMET** Unidade: **CX/24**
F1 F4

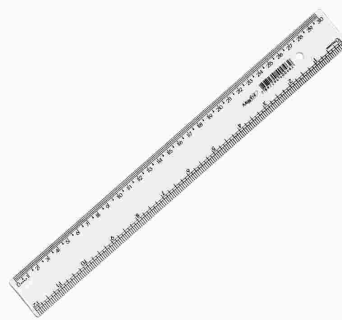

REGUA 30 CM CRISTAL SUPER 10X1

Código: **22911** Fábrica: **MAXCRIL** Unidade: **PT/10**
F1 F4

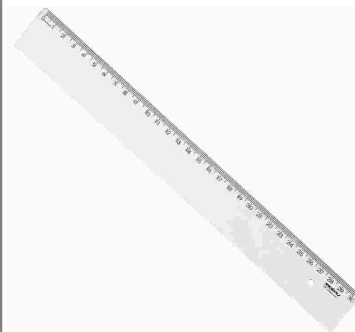

REGUA 30 CM CRISTAL 10270012 25X1

Código: **215** Fábrica: **MAXCRIL** Unidade: **PT/25**
F1 F4



REGUA 30 CM CRISTAL 10270086 100X1

Código: **35737** Fábrica: **MAXCRIL** Unidade: **CX/100**
F1 F4



REGUA 30 CM EMB IND BANG ON THE DOOR10X1

Código: **38562** Fábrica: **POLIBRAS** Unidade: **PT/10**
F1 F4



REGUA 30 CM EMB IND BARBIE 10X1

Código: **38567** Fábrica: **POLIBRAS** Unidade: **PT/10**
F1 F4



REGUA 30 CM EMB IND CHEVROLET 10X1

Código: **38564** Fábrica: **POLIBRAS** Unidade: **PT/10**
F1 F4



REGUA 30 CM EMB IND HIGH SCHHOL MUS 12X1

Código: **38568** Fábrica: **SUMMIT** Unidade: **PT/12**
F1 F4



REGUA 30 CM EMB IND HOT WHEELS 10X1

Código: **38563** Fábrica: **POLIBRAS** Unidade: **PT/10**
F1 F4



REGUA 30 CM EMB IND POLLY 10X1

Código: **38560** Fábrica: **POLIBRAS** Unidade: **PT/10**
F1 F4



REGUA 30 CM EMB IND PRINCESAS 10X1

Código: **38561** Fábrica: **POLIBRAS** Unidade: **PT/10**
F1 F4



REGUA 30 CM EMB IND RUBY GLOOM 10X1

Código: **38565** Fábrica: **POLIBRAS** Unidade: **PT/10**
F1 F4

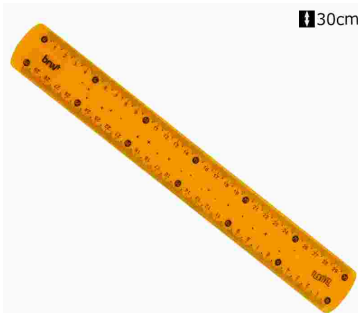

REGUA 30 CM FLEXIVEL COLOR 0001 UN

Código: **46844** Fábrica: **BRW** Unidade: **UN/1**
F1 F4



REGUA 30 CM FLEXIVEL COLOR 4365

Código: **50647** Fábrica: **LEO&LEO** Unidade: **UN/1**
F1 F4



REGUA 30 CM GUIA LEITURA AZUL EMB IN10X1

Código: **50764** Fábrica: **MAXCRIL** Unidade: **PT/10**
F1 F4



REGUA 30 CM GUIA LEITURA AZUL UN

Código: **50766** Fábrica: **MAXCRIL** Unidade: **UN/1**
F1 F4



REGUA 30 CM METAL ACO INOX ESCALA 10X1

Código: **49943** Fábrica: **BAZZE** Unidade: **CX/10**
F1 F4

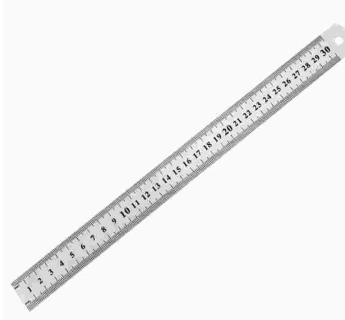

REGUA 30 CM METAL ACO INOX ESCALA 7403

Código: **46943** Fábrica: **YIN'S PAPER** Unidade: **UN/1**
F1 F4



REGUA 30 CM NEW LINE CRISTAL EMB IND10X1

Código: **35738** Fábrica: **MAXCRI/WALEU** Unidade: **PT/10**
F1 F4



REGUA 30 CM NEW LINE CRISTAL UN

Código: **18924** Fábrica: **MAXCRIL** Unidade: **UN/1**
F1 F4

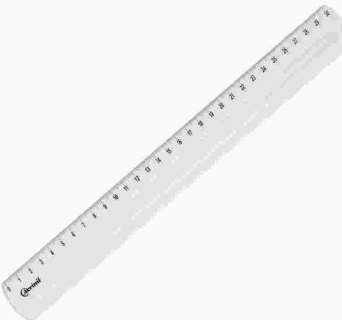

REGUA 30 CM PLAST CRISTAL 300

Código: **43219** Fábrica: **ACRINIL** Unidade: **UN/1**
F1 F4



REGUA 30 CM PLAST PRATA 305

Código: **43218** Fábrica: **ACRINIL** Unidade: **UN/1**
F1 F4



REGUA 30 CM PLAST PRETA 306

Código: **43217** Fábrica: **ACRINIL** Unidade: **UN/1**
F1 F4



REGUA 30 CM PLAST TRANSP FUME 301

Código: **43216** Fábrica: **ACRINIL** Unidade: **UN/1**
F1 F4



REGUA 30 CM PLAST TRANSP ROSA 3098

Código: **43212** Fábrica: **ACRINIL** Unidade: **UN/1**
F1 F4



REGUA 30 CM PLAST TRANSP VERDE 303

Código: **43214** Fábrica: **ACRINIL** Unidade: **UN/1**
F1 F4



REGUA 30 CM PLAST TRANSP VERMELHO 304

Código: **43213** Fábrica: **ACRINIL** Unidade: **UN/1**
F1 F4



REGUA 30 CM PRETO EMB IND 987.7 10X1

Código: **40886** Fábrica: **ACRIMET** Unidade: **PT/10**
F1 F4

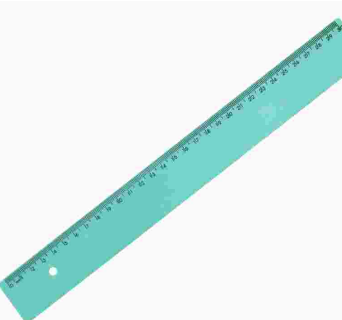

REGUA 30 CM VERDE EMB IND 987.4 10X1

Código: **40887** Fábrica: **ACRIMET** Unidade: **PT/10**
F1 F4



REGUA 40 CM CRISTAL SUPER 10X1

Código: **49200** Fábrica: **MAXCRIL** Unidade: **PT/10**
F1 F4



REGUA 50 CM ACR CRISTAL 515

Código: **43533** Fábrica: **ACRIMET** Unidade: **UN/1**
F1 F4



REGUA 50 CM ALUMINIO 10270125

Código: 50762
Fábrica: MAXCRIL
Unidade: UN/1
F1 F4



REGUA 60 CM ACR CRISTAL 516

Código: 43532
Fábrica: ACRIMET
Unidade: UN/1
F1 F4



REGUA 60 CM METAL ACO INOX 300

Código: 45077
Fábrica: NYBC
Unidade: UN/1
F1 F4



RIFA GRANDE CTL C/50 NOMES 6011 50X1

Código: 10299
Fábrica: TAMOIO
Unidade: PT/50
F1 F4



RIFA GRANDE CTL NUMEROS 1A100 6015 50X1

Código: 37042
Fábrica: TAMOIO
Unidade: PT/50
F1 F4

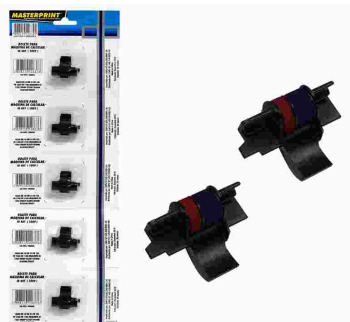

ROLETE BICOLOR P/MAQUINA CALCULAR 5X1

Código: 38247
Fábrica: MASTERPRINT
Unidade: CR/5
F1 F4



ROLINHO MINI 3,5CM C/ESPUMA+4REFI 971950

Código: 51102
Fábrica: CONDOR
Unidade: PT/1
F1 F4



SACO PAPEL KRAFT MIX 0,5 KG 500X1

Código: 41443
Fábrica: SACOPEL
Unidade: PT/1
F1 F4



SACO PAPEL KRAFT MIX 1 KG 500X1

Código: 41444
Fábrica: SACOPEL
Unidade: PT/1
F1 F4



SACO PAPEL KRAFT MIX 10 KG 500X1

Código: 48668
Fábrica: SACOPEL
Unidade: PT/500
F1 F4



SACO PAPEL KRAFT MIX 2 KG 500X1

Código: 46270
Fábrica: SACOPEL
Unidade: PT/1
F1 F4



SACO PAPEL KRAFT MIX 7,5 KG 500X1

Código: 48667
Fábrica: SACOPEL
Unidade: PT/500
F1 F4

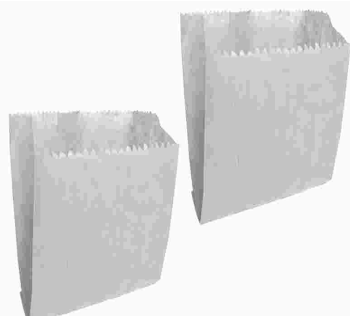

SACO PAPEL PIPOCA BRANCO 12X12CM 500X1

Código: 47261
Fábrica: STRONG
Unidade: PT/500
F1 F4



SACO PAPEL PIPOCA 2 7,5X12CM 500X1

Código: 31026
Fábrica: STRONG
Unidade: PT/1
F1 F4

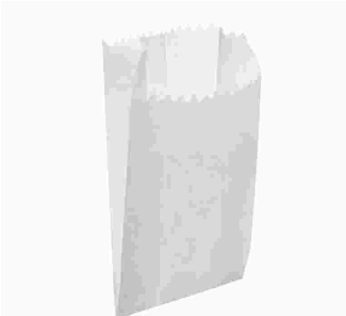

SACO PAPEL PIPOCA 3 7,5X15,5CM 500X1

Código: 31027
Fábrica: STRONG
Unidade: PT/1
F1 F4

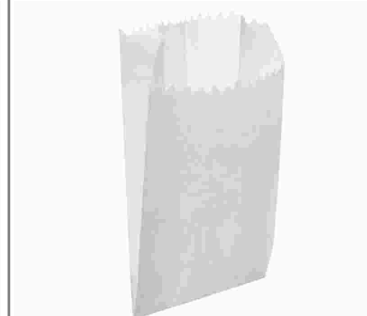

SACO PAPEL PIPOCA 4 7,5X17,5CM 500X1

Código: 31651
Fábrica: STRONG
Unidade: PT/500
F1 F4



SACO PAPEL PIPOCA 5 10,5X15CM 500X1

Código: **35938** Fábrica: **STRONG** Unidade: **PT/500 F1 F4**



SACO PLAST 5X23CM CHUP CHUP 1000X1

Código: **31028** Fábrica: **SILVANI/KROM** Unidade: **PT/1000 F1 F4**



SACO PLAST 6X24CM CHUP CHUP 1000X1

Código: **47892** Fábrica: **SILVANI** Unidade: **PT/1000 F1 F4**



SACO PLAST 8X25CM P/TALHER 1000X1

Código: **44378** Fábrica: **KROMASA** Unidade: **PT/1000 F1 F4**



SACO PLAST BOB 16X30CM PICOTADO 500X1

Código: **44295** Fábrica: **ECO ROLL** Unidade: **RL/1 F1 F4**



SACO PLAST TRANSP 25X37CM 100X1

Código: **41919** Fábrica: **COPLAMIX** Unidade: **PT/100 F1 F4**



SACO PLAST 10X15CM TRANSP 1000X1

Código: **47893** Fábrica: **SILVANI** Unidade: **PT/1000 F1 F4**



SACO PLAST 12X18CM TRANSP 1000X1

Código: **47894** Fábrica: **SILVANI** Unidade: **PT/1000 F1 F4**



SACO PLAST 15X30CM TRANSP 05 1 KG

Código: **48890** Fábrica: **DIFFATTO** Unidade: **KG/1 F1 F4**



SACO PLAST 20X10CM HOT DOG 1000X1

Código: **47896** Fábrica: **SILVANI** Unidade: **PT/1000 F1 F4**



SACO PLAST 20X14CM HAMBURGER 1000X1

Código: **47895** Fábrica: **SILVANI** Unidade: **PT/1000 F1 F4**

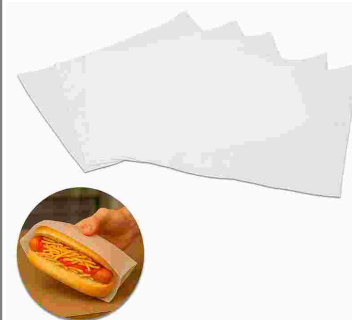

SACO PLAST 20X14CM HAMBURGUER 500X1

Código: **46995** Fábrica: **KROMASA** Unidade: **PT/500 F1 F4**



SACO PLAST 20X30CM 06 TRANSP 1KG

Código: **46980** Fábrica: **DIFFATTO** Unidade: **KG/1 F1 F4**



SACO PLAST 22X48CM 0,6 TRANSP KG

Código: **45067** Fábrica: **KROMASA** Unidade: **KG/1 F1 F4**



SACO PLAST 25X35CM TRANSP BOBINA PICOT

Código: **44297** Fábrica: **HIPERROLL** Unidade: **RL/1 F1 F4**



SACO PLAST 25X35CM TRANSP 06 1KG

Código: **48895** Fábrica: **DIFFATTO** Unidade: **KG/1 F1 F4**



SACO PLAST 30X40CM TRANSP 06 1KG

Código: **48896** Fábrica: **DIFFATTO** Unidade: **KG/1**
F1 F4

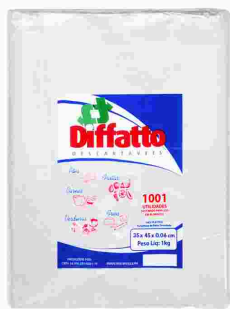

SACO PLAST 35X45CM 06 TRANSP 1 KG

Código: **48897** Fábrica: **DIFFATTO** Unidade: **KG/1**
F1 F4



SACO PLAST 40X60CM TRANSP 1 KG

Código: **48898** Fábrica: **DIFFATTO** Unidade: **KG/1**
F1 F4



SACO PLAST 40X60CM TRANSP 100X1

Código: **31029** Fábrica: **KROMASA** Unidade: **PT/100**
F1 F4



SACO PP 4X4X3CM AUTOCOLANTE 100X1

Código: **26912** Fábrica: **RDE** Unidade: **PT/100**
F1 F4



SACO PP 4X7X3CM AUTOCOLANTE 100X1

Código: **26913** Fábrica: **RDE** Unidade: **PT/100**
F1 F4



SACO PP 5X12X3CM AUTOCOLANTE 100X1

Código: **26915** Fábrica: **RDE** Unidade: **PT/100**
F1 F4



SACO PP 5X22X3CM AUTOCOLANTE 10X1

Código: **34953** Fábrica: **RDE** Unidade: **PT/100**
F1 F4



SACO PP 5X7X3CM AUTOCOLANTE 100X1

Código: **26914** Fábrica: **RDE** Unidade: **PT/100**
F1 F4



SACO PP 6X12X3CM AUTOCOLANTE 100X1

Código: **26253** Fábrica: **RDE** Unidade: **PT/100**
F1 F4



SACO PP 6,5X9X3CM AUTOCOLANTE 100X1

Código: **26328** Fábrica: **RDE** Unidade: **PT/100**
F1 F4



SACO PP 7X12X3CM AUTOCOLANTE 100X1

Código: **32559** Fábrica: **RDE** Unidade: **PT/100**
F1 F4



SACO PP 7X7X3CM AUTOCOLANTE 100X1

Código: **26916** Fábrica: **RDE** Unidade: **PT/100**
F1 F4



SACO PP 7,5X13CM AUTOCOLANTE 100X1

Código: **23058** Fábrica: **RDE** Unidade: **PT/100**
F1 F4



SACO PP 8X25X3CM AUTOCOLANTE 100X1

Código: **26918** Fábrica: **RDE** Unidade: **PT/100**
F1 F4



SACO PP 9X13X3CM AUTOCOLANTE 100X1

Código: **26919** Fábrica: **RDE** Unidade: **PT/100**
F1 F4



SACO PP N2 15X22CM TRANSP CRISTAL 50X1

Código: 41969 Fábrica: VMP Unidade: PT/50
F1 F4



SACO PP N6 25X37CM TRANSP CRISTAL 50X1

Código: 41971 Fábrica: VMP Unidade: PT/50
F1 F4



SACO PP N8 30X45CM TRANSP CRISTAL 50X1

Código: 41972 Fábrica: VMP Unidade: PT/50
F1 F4



SACO PP TRANSP 10X14CM INCOLOR 100X1

Código: 41978 Fábrica: CROMUS Unidade: PT/100
F1 F4



SACO PP TRANSP 20X29CM INCOLOR 100X1

Código: 41976 Fábrica: CROMUS Unidade: PT/100
F1 F4



SACO PP TRANSP 45X59CM INCOLOR 25X1

Código: 44380 Fábrica: CROMUS Unidade: PT/25
F1 F4



SACO PP 10X15CM AUTOCOLANTE 100X1

Código: 32553 Fábrica: RDE Unidade: PT/100
F1 F4



SACO PP 10X15CM TRANSP INCOLOR 50X1

Código: 33859 Fábrica: NOVO TEMPO Unidade: PT/50
F1 F4



SACO PP 11X20CM TRANSP INCOLOR 50X1

Código: 33860 Fábrica: NOVO TEM/EMB Unidade: PT/50
F1 F4



SACO PP 15X20X3CM AUTOCOLANTE 100X1

Código: 26921 Fábrica: RDE Unidade: PT/100
F1 F4



SACO PP 15X22CM AUTOCOLANTE 50X1

Código: 41632 Fábrica: CG PACK Unidade: PT/50
F1 F4



SACO PP 15X22CM TRANSP INCOLOR 50X1

Código: 33861 Fábrica: NOVO TEMPO Unidade: PT/50
F1 F4



SACO PP 15X30CM TRANSP INCOLOR 50X1

Código: 33862 Fábrica: NOVO TEMPO Unidade: PT/50
F1 F4



SACO PP 18X25X3CM AUTOCOLANTE 100X1

Código: 26922 Fábrica: RDE Unidade: PT/100
F1 F4



SACO PP 20X20X3CM AUTOCOLANTE 100X1

Código: 26923 Fábrica: RDE Unidade: PT/100
F1 F4



SACO PP 20X30CM AUTOCOLANTE 50X1

Código: 41627 Fábrica: CG PACK Unidade: PT/50
F1 F4



SACO PP 20X30CM TRANSP INCOLOR 100X1

Código: 48787 Fábrica: KROMASA Unidade: PT/100 F1 F4



SACO PP 20X30CM TRANSP INCOLOR 50X1

Código: 41970 Fábrica: NOVO TEMPO Unidade: PT/50 F1 F4



SACO PP 25X35X3CM AUTOCOLANTE 100X1

Código: 26924 Fábrica: CG PACK Unidade: PT/100 F1 F4



SACO PP 25X36CM TRANSP INCOLOR 50X1

Código: 31640 Fábrica: NOVO TEMPO Unidade: PT/50 F1 F4

44 cm
30 cm



SACO PP 30X44CM TRANSP INCOLOR 25X1

Código: 43582 Fábrica: CROMUS Unidade: PT/25 F1 F4



SACO PP 30X45CM TRANSP INCOLOR 50X1

Código: 33865 Fábrica: NOVO TEMPO Unidade: PT/50 F1 F4



SACO PP 35X54CM TRANSP INCOLOR 50X1

Código: 41158 Fábrica: NOVO TEMPO Unidade: PT/50 F1 F4



SACO PP 60X89CM TRANSP 25X1

Código: 33867 Fábrica: EMBALE Unidade: PT/25 F1 F4



SACO PP 60X90CM TRANSP 25X1

Código: 41159 Fábrica: CROMUS Unidade: PT/25 F1 F4



SACO PP 60X90CM TRANSP 25X1

Código: 41630 Fábrica: CG PACK Unidade: PT/25 F1 F4



SACO PP 70X89CM TRANSP 25X1

Código: 33868 Fábrica: EMBALE Unidade: PT/25 F1 F4



SACO PP 80X89CM TRANSP 25X1

Código: 33869 Fábrica: EMBALE Unidade: PT/25 F1 F4



SACO PRES 8X10CM VELUDO PRETO 10X1

Código: 36620 Fábrica: SOLIDER Unidade: PT/10 F1 F4



SACO PRES 8X10CM VELUDO VERMELHO 10X1

Código: 36595 Fábrica: SOLIDER Unidade: PT/10 F1 F4



SACO PRES 8X8CM CASUAL AUT COLAN 100X1

Código: 44046 Fábrica: CROMUS Unidade: UN/1 F1 F4



SACO PRES 10X14CM FEM METAL 50X1

Código: 37676 Fábrica: VILLA PACK Unidade: UN/1 F1 F4



SACO PRES 10X14CM INF METAL 50X1

Código: **37675** Fábrica: **VILLA PACK** Unidade: **PT/50**
F1 F4



SACO PRES 10X15CM ORGANZA OURO 10X1

Código: **36589** Fábrica: **SOLIDER** Unidade: **PT/10**
F1 F4



SACO PRES 10X15CM ORGANZA PRATA 10X1

Código: **36590** Fábrica: **SOLIDER** Unidade: **PT/10**
F1 F4



SACO PRES 11X20CM FEM METAL 50X1

Código: **33854** Fábrica: **EMBALE** Unidade: **PT/50**
F1 F4

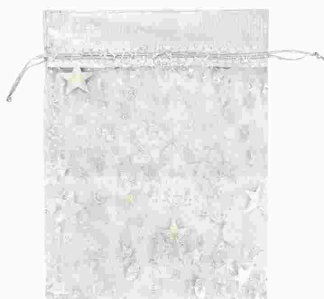

SACO PRES 15X18CM ORGANZA PRATA 10X1

Código: **36602** Fábrica: **SOLIDER** Unidade: **PT/10**
F1 F4



SACO PRES 15X18CM ORGANZA AZUL/DOUR 10X1

Código: **36605** Fábrica: **SOLIDER** Unidade: **PT/10**
F1 F4



SACO PRES 15X18CM ORGANZA DOURADO 10X1

Código: **36606** Fábrica: **SOLIDER** Unidade: **PT/10**
F1 F4

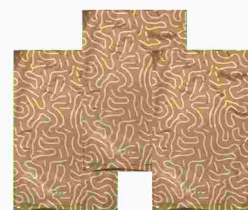

SACO PRES 15X22CM CAS VIBE SORT MET 50X1

Código: **43565** Fábrica: **CROMUS** Unidade: **PT/50**
F1 F4



SACO PRES 15X22CM CASUAL SORT 0037 50X1

Código: **43568** Fábrica: **CROMUS** Unidade: **PT/50**
F1 F4



SACO PRES 15X22CM INF METAL 50X1

Código: **23419** Fábrica: **VMP** Unidade: **PT/50**
F1 F4



SACO PRES 15X22CM LISO COLOR MET 50X1

Código: **45794** Fábrica: **CROMUS** Unidade: **PT/50**
F1 F4

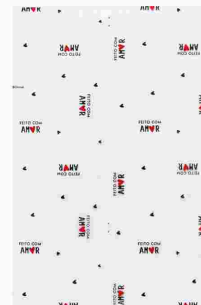

SACO PRES 15X22CM TRANSP STARS 50X1

Código: **45795** Fábrica: **GALA** Unidade: **PT/50**
F1 F4



SACO PRES 15X29CM BEBE MET/PER 50X1

Código: **45798** Fábrica: **CROMUS** Unidade: **PT/50**
F1 F4



SACO PRES 15X29CM CAS LISO COLO MET 50X1

Código: **43570** Fábrica: **CROMUS** Unidade: **PT/50**
F1 F4



SACO PRES 15X29CM CAS MET 50X1

Código: **46190** Fábrica: **GALA** Unidade: **PT/50**
F1 F4



SACO PRES 15X29CM CAS VIBE SORT MET 50X1

Código: **43569** Fábrica: **CROMUS** Unidade: **PT/50**
F1 F4



SACO PRES 15X29CM FEM MET 50X1

Código: 46189
 Fábrica: GALA
 Unidade: PT/50
 F1 F4



SACO PRES 15X29CM INF MET 50X1

Código: 46191
 Fábrica: GALA
 Unidade: PT/50
 F1 F4



SACO PRES 15X29CM JUV MET/PER 50X1

Código: 45797
 Fábrica: CROMUS
 Unidade: PT/50
 F1 F4



SACO PRES 15X30CM FEM METAL 50X1

Código: 27476
 Fábrica: EMBALE
 Unidade: PT/50
 F1 F4



SACO PRES 15X44CM LISO MET SORT 50X1

Código: 45804
 Fábrica: CROMUS
 Unidade: PT/50
 F1 F4

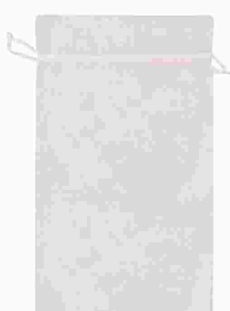

SACO PRES 17X30CM ORGANZA COLOR 10X1

Código: 36593
 Fábrica: SOLIDER
 Unidade: PT/10
 F1 F4



SACO PRES 18X25CM ORGANZA PRATA 10X1

Código: 36592
 Fábrica: SOLIDER
 Unidade: PT/10
 F1 F4



SACO PRES 20X29CM CASUAL METAL 50X1

Código: 27571
 Fábrica: NOVO TEMPO
 Unidade: PT/50
 F1 F4



SACO PRES 20X29CM FEM MET/PER 50X1

Código: 33568
 Fábrica: GALA
 Unidade: PT/50
 F1 F4



SACO PRES 20X30CM FEM METAL 50X1

Código: 30725
 Fábrica: NOVO TEMPO
 Unidade: PT/50
 F1 F4

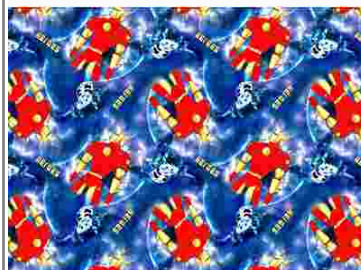

SACO PRES 20X30CM INF METAL 50X1

Código: 30722
 Fábrica: VMP/NOVOTEMP
 Unidade: PT/50
 F1 F4



SACO PRES 20X30CM LISO COLOR METAL 50X1

Código: 45803
 Fábrica: NOVO TEMPO
 Unidade: PT/50
 F1 F4

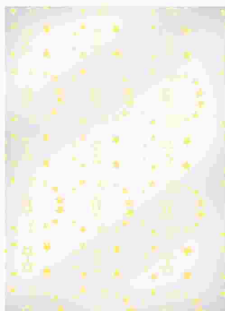

SACO PRES 20X30CM TRANSP ESTRELA AM 50X1

Código: 50021
 Fábrica: MHP
 Unidade: PT/50
 F1 F4

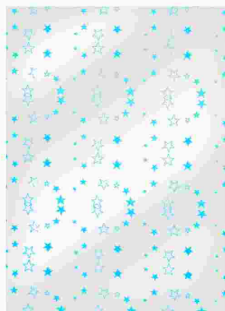

SACO PRES 20X30CM TRANSP ESTRELA AZ 50X1

Código: 50771
 Fábrica: MHP
 Unidade: PT/50
 F1 F4

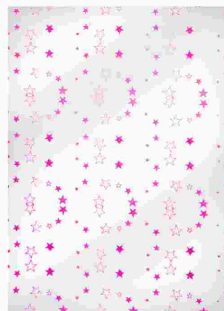

SACO PRES 20X30CM TRANSP ESTRELA RS 50X1

Código: 50025
 Fábrica: MHP
 Unidade: PT/50
 F1 F4

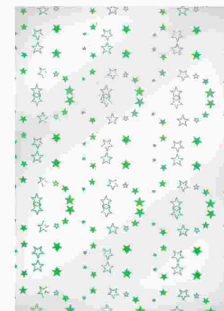

SACO PRES 20X30CM TRANSP ESTRELA VD 50X1

Código: 50026
 Fábrica: MHP
 Unidade: PT/50
 F1 F4

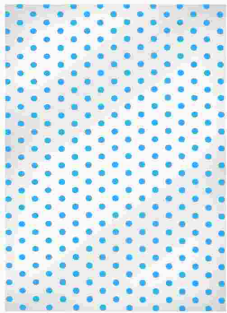

SACO PRES 20X30CM TRANSP POA AZ CL 50X1
 Código: 50022 Fábrica: MHP Unidade: PT/50
 F1 F4

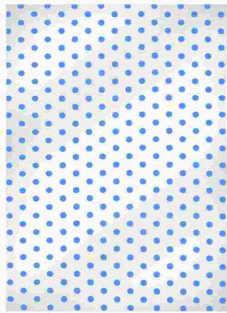

SACO PRES 20X30CM TRANSP POA AZ ES 50X1
 Código: 50023 Fábrica: MHP Unidade: PT/50
 F1 F4

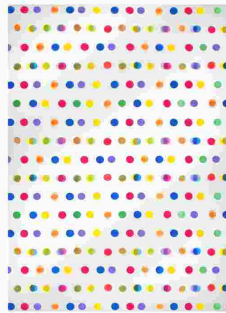

SACO PRES 20X30CM TRANSP POA COLOR 50X1
 Código: 50024 Fábrica: MHP Unidade: PT/50
 F1 F4

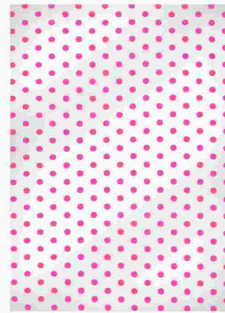

SACO PRES 20X30CM TRANSP POA ROSA 50X1
 Código: 50117 Fábrica: MHP Unidade: PT/50
 F1 F4

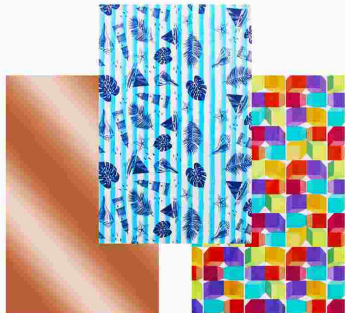

SACO PRES 25X36CM CAS METAL 50X1
 Código: 49675 Fábrica: NOVO TEMPO Unidade: PT/50
 F1 F4



SACO PRES 25X36CM FEM METAL 50X1
 Código: 27478 Fábrica: NOVO TEMPO Unidade: PT/50
 F1 F4



SACO PRES 25X36CM INF METAL 50X1
 Código: 30462 Fábrica: NOVO TEMPO Unidade: PT/50
 F1 F4



SACO PRES 25X36CM LISO COLOR METAL 50X1
 Código: 45805 Fábrica: NOVO TEMPO Unidade: PT/50
 F1 F4

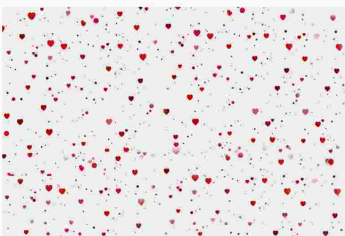

SACO PRES 25X36CM TRANSP DEC 50X1
 Código: 13129 Fábrica: NOVO TEMPO Unidade: PT/50
 F1 F4

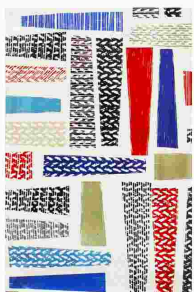

SACO PRES 25X37CM SORT MET 50X1
 Código: 45806 Fábrica: CROMUS Unidade: PT/50
 F1 F4



SACO PRES 25X40CM COPA METAL 50X1
 Código: 39573 Fábrica: VMP Unidade: PT/50
 F1 F4

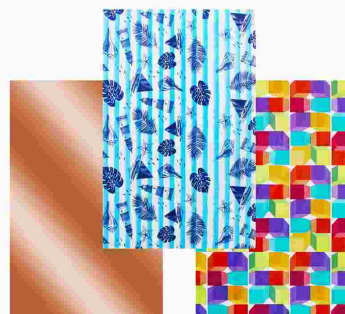

SACO PRES 30X45CM CAS METAL 50X1
 Código: 41633 Fábrica: NOVO TEMPO Unidade: PT/50
 F1 F4



SACO PRES 30X45CM FEM METAL 50X1
 Código: 22438 Fábrica: NOVO TEMPO Unidade: PT/50
 F1 F4



SACO PRES 30X45CM INF METAL 50X1
 Código: 22436 Fábrica: NOVO TEMPO Unidade: PT/50
 F1 F4

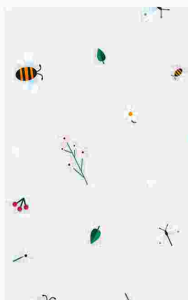

SACO PRES 35X53CM INF TRANSP 50X1
 Código: 46196 Fábrica: GALA Unidade: PT/50
 F1 F4



SACO PRES 35X53CM TRANSP STARS 50X1
 Código: 49670 Fábrica: GALA Unidade: PT/50
 F1 F4



SACO PRES 35X54CM BEBE MET/PER SORT 50X1
 Código: 45812 Fábrica: CROMUS Unidade: PT/50
 F1 F4



SACO PRES 35X54CM FEM MET 50X1
 Código: 30052 Fábrica: NOVO TEMPO Unidade: PT/50
 F1 F4



SACO PRES 35X54CM LISO COLOR METAL 50X1
 Código: 45813 Fábrica: NOVO TEMPO Unidade: PT/50
 F1 F4



SACO PRES 35X54CM NATAL METAL 50X1
 Código: 40092 Fábrica: NOVO TEMPO Unidade: PT/50
 F1 F4



SACO PRES 45X60CM FEM METAL 50X1
 Código: 22437 Fábrica: VMP Unidade: PT/50
 F1 F4



SACO PRES 50X69CM FEM MET 50X1
 Código: 46199 Fábrica: GALA Unidade: PT/50
 F1 F4



SACO PRES 50X69CM INF MET 50X1
 Código: 46198 Fábrica: GALA Unidade: PT/50
 F1 F4



SACO PRES 50X70CM DOURADO LISO MET 25X1
 Código: 43797 Fábrica: CROMUS Unidade: PT/25
 F1 F4



SACO PRES 50X70CM FEM FLORAL 25X1
 Código: 44048 Fábrica: CROMUS Unidade: PT/25
 F1 F4



SACO PRES 50X70CM FEM/ROM MET/PEROL 25X1
 Código: 40111 Fábrica: CROMUS Unidade: PT/25
 F1 F4

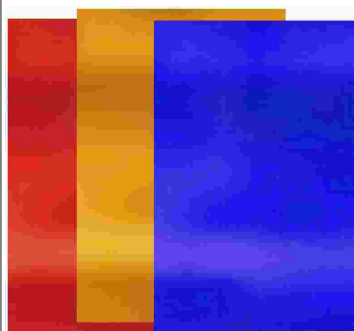

SACO PRES 50X70CM LISO SORT MET 25X1
 Código: 40090 Fábrica: CROMUS Unidade: PT/25
 F1 F4



SACO PRES 50X70CM POA MET 25X1
 Código: 44999 Fábrica: CROMUS Unidade: PT/25
 F1 F4

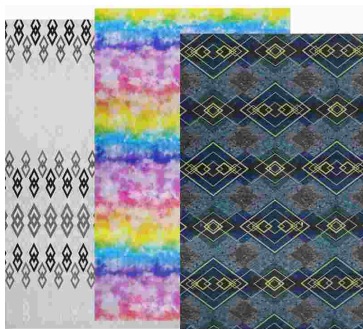

SACO PRES 50X70CM SORT MET 25X1
 Código: 40112 Fábrica: CROMUS Unidade: PT/25
 F1 F4

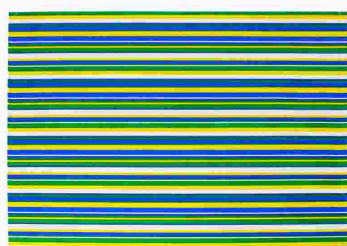

SACO PRES 50X74CM PRATA METAL 50X1
 Código: 39575 Fábrica: VMP Unidade: PT/50
 F1 F4

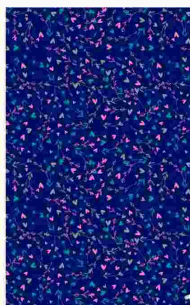

SACO PRES 58X89CM FEM MET 25X1
 Código: 46192 Fábrica: GALA Unidade: PT/25
 F1 F4



SACO PRES 58X89CM INF MET 25X1
 Código: 46194 Fábrica: GALA Unidade: PT/25
 F1 F4



SACO PRES 58X89CM INF TRANSP 25X1

Código: 46195
 Fábrica: GALA
 Unidade: PT/25
 F1 F4



90 cm
 60 cm

SACO PRES 60X90CM FEM MET 25X1

Código: 40520
 Fábrica: CROMUS
 Unidade: PT/25
 F1 F4



SACO PRES 60X90CM FEM METAL 25X1

Código: 41628
 Fábrica: CG PACK
 Unidade: PT/25
 F1 F4



SACO PRES 60X90CM FEM METAL 25X1

Código: 40097
 Fábrica: CROMUS
 Unidade: PT/25
 F1 F4



SACO PRES 60X90CM INF METAL 25X1

Código: 42736
 Fábrica: CG PACK
 Unidade: PT/25
 F1 F4

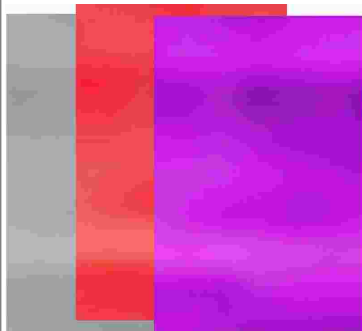

SACO PRES 60X90CM LISO SORT MET 25X1

Código: 40095
 Fábrica: CROMUS
 Unidade: PT/25
 F1 F4



90 cm
 60 cm

SACO PRES 60X90CM SORT MET 25X1

Código: 40521
 Fábrica: CROMUS
 Unidade: PT/25
 F1 F4



SACO PRES 89X1,20M BEBE/INF/JUV MET 25X1

Código: 45810
 Fábrica: CROMUS
 Unidade: PT/25
 F1 F4

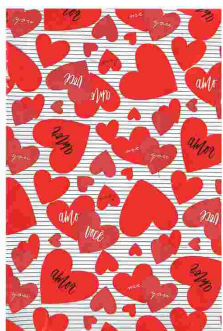

1,20 m
 89 cm

SACO PRES 89X1,20M FEM METAL 25X1

Código: 21047
 Fábrica: CROMUS
 Unidade: PT/25
 F1 F4



SACO PRES 90X1,18M CASUAL METAL 25X1

Código: 42734
 Fábrica: CG PACK
 Unidade: PT/25
 F1 F4



SACO TNT LISO 25X35CM UN

Código: 46749
 Fábrica: ALINE
 Unidade: UN/1
 F1 F4



16cm
 13,5cm
 8cm

SACOLA KRAFT 13,5X8X16CM 1116 10X1

Código: 41684
 Fábrica: SCRITY
 Unidade: PT/10
 F1 F4



18cm
 23cm

SACOLA PAP PRES 18X23CM FITA 625 12X1

Código: 45951
 Fábrica: WINMAX
 Unidade: PT/12
 F1 F4



32cm
 26cm

SACOLA PAP PRES 26X32CM FITA 626 12X1

Código: 45953
 Fábrica: WINMAX
 Unidade: PT/12
 F1 F4



41,5cm
 30cm

SACOLA PAP PRES 30X41,5CM FITA 627 12X1

Código: 45954
 Fábrica: WINMAX
 Unidade: PT/12
 F1 F4



SELADORA MESA P/PLASTICO 30CM L 110V

Código: 32225
 Fábrica: BRASQUENT
 Unidade: UN/1
 F1 F4



SENCIL ROXO 25X1

Código: 4302
 Fábrica: FRANKLIN
 Unidade: C//25
 F1 F4



SUPORTE DISPLAY DE PAREDE A4/OF 227

Código: 50156
 Fábrica: ACRINIL
 Unidade: UN/1
 F1 F4



SUPORTE FITA ADESIVA GDE PRETO 526

Código: 41802
 Fábrica: CARBRINK
 Unidade: UN/1
 F1 F4



SUPORTE FITA ADESIVA GDE 19,5CM PRETO

Código: 38255
 Fábrica: MAXCRIL
 Unidade: CX/1
 F1 F4



SUPORTE FITA ADESIVA PEQ 12CM AZUL 1011

Código: 44058
 Fábrica: MAXCRIL
 Unidade: CX/1
 F1 F4



SUPORTE FITA ADESIVA PEQ 12CM PRETO 1009

Código: 50760
 Fábrica: MAXCRIL
 Unidade: CX/1
 F1 F4



SUPORTE METAL FITA LACRADORA 901

Código: 39786
 Fábrica: MASTERPRINT
 Unidade: UN/1
 F1 F4



SUPORTE P/BOBINA 40CM

Código: 33499
 Fábrica: STALO
 Unidade: UN/1
 F1 F4



SUPORTE P/BOBINA 60CM

Código: 33500
 Fábrica: SAO JOAO
 Unidade: UN/1
 F1 F4



TABELA PERIODICA ATUALIZADA

Código: 48482
 Fábrica: BRASILEITURA
 Unidade: UN/1
 F1 F4



TABUADA COMPLETA 10X15CM 16 PAG 30X1

Código: 29636
 Fábrica: PARRKE
 Unidade: PT/30
 F1 F4



TALAO COMANDO 2 CORPOS NUM 100FLS 20X1

Código: 17966
 Fábrica: PARRKE
 Unidade: PT/20
 F1 F4



TALAO CONTRATO LOCACAO 100FLS 5X1

Código: 12553
 Fábrica: PARRKE
 Unidade: PT/5
 F1 F4



TALAO MOVIMENTO CX 100FLS PEQ 5X1

Código: 14431
 Fábrica: PARRKE
 Unidade: PT/5
 F1 F4



TALAO MOVIMENTO CX 100FLS 215X315MM 5X1

Código: 14432
 Fábrica: PARRKE
 Unidade: PT/5
 F1 F4



TALAO NOTA NEUTRA 1/36 C/COPIA 25X2 20X1

Código: 17123
 Fábrica: PARRKE
 Unidade: PT/20
 F1 F4



TALAO NOTA NEUTRA 1/36 S/COP 50FLS 20X1
 Código: 17512 Fábrica: PARRKE Unidade: PT/20
 F1 F4



TALAO NOTA PROMISSORIA MINI 50 FLS 20X1
 Código: 12551 Fábrica: PARRKE Unidade: PT/20
 F1 F4



TALAO NOTA PROMISSORIA 50FLS 20X1
 Código: 12550 Fábrica: PARRKE Unidade: PT/20
 F1 F4

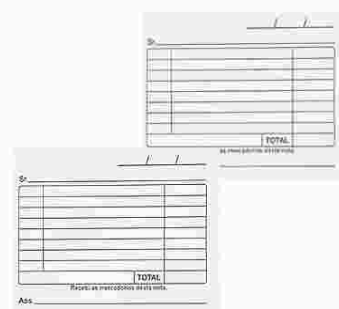

TALAO NOTINHA 1/72 100FLS 7,5X10,5 20X1
 Código: 17965 Fábrica: PARRKE Unidade: PT/20
 F1 F4



TALAO PEDIDO 1/18 25X2 FL 15X21 C/C 20X1
 Código: 12546 Fábrica: PARRKE Unidade: PT/20
 F1 F4



TALAO PEDIDO 1/18 50FLS 15X21 S/C 20X1
 Código: 19007 Fábrica: PARRKE Unidade: PT/20
 F1 F4



TALAO PEDIDO 1/9 S/COPIA 50FLS 10X1
 Código: 12549 Fábrica: PARRKE Unidade: PT/10
 F1 F4



TALAO PEDIDO 1/9 25X2 210X310MM 10X1
 Código: 12548 Fábrica: PARRKE Unidade: PT/10
 F1 F4



TALAO RECIBO ALUGUEL 50FLS C/CANHO 20X1
 Código: 14420 Fábrica: PARRKE Unidade: PT/20
 F1 F4



TALAO RECIBO COMERCIAL C/CANH 50FLS 20X1
 Código: 6136 Fábrica: PARRKE Unidade: PT/20
 F1 F4



TALAO RECIBO COMERCIAL S/CANH 50FLS 20X1
 Código: 12552 Fábrica: PARRKE Unidade: PT/20
 F1 F4



TALAO RECIBO CONDOMINIO C/CANH 50FL 50X1
 Código: 14421 Fábrica: PARRKE Unidade: PT/20
 F1 F4



TALAO RECIBO PGTO EMPREG DOMEST 50FLS
 Código: 14419 Fábrica: PARRKE Unidade: PT/20
 F1 F4



TALAO RECIBO SALARIOS OUTR PROV 50F 20X1
 Código: 14422 Fábrica: MINASPEL Unidade: PT/20
 F1 F4



TALAO TRANSF VEICULO DOC DE CADAST DET
 Código: 14430 Fábrica: PARRKE Unidade: PT/10
 F1 F4



TALAO VALE C/CANHOTO 50 FLS 20X1
 Código: 14417 Fábrica: PARRKE Unidade: PT/20
 F1 F4



TALAO VALE S/CANHOTO C/AZUREE 50FLS 10X1
 Código: 6138 Fábrica: SAO DOMINGOS Unidade: PT/10 F1 F4



TALAO VALE S/CANHOTO 50FLS 20X1
 Código: 12545 Fábrica: PARRKE Unidade: PT/20 F1 F4



TECLADO USB DESIGN A PROVA D'ÁGUA 74327
 Código: 35800 Fábrica: LETRON Unidade: UN/1 F1 F4



TELA JUTA ABERTA P9 1000MM 25MTS
 Código: 42029 Fábrica: PLAST CO Unidade: RL/1 F1 F4



TELA JUTA NATURAL P9 50MTS
 Código: 50951 Fábrica: ABL Unidade: RL/50 F1 F4



TELA PINTURA C/CHASSI MDF 16X22CM 001
 Código: 46319 Fábrica: PAPER TOYS Unidade: UN/1 F1 F4

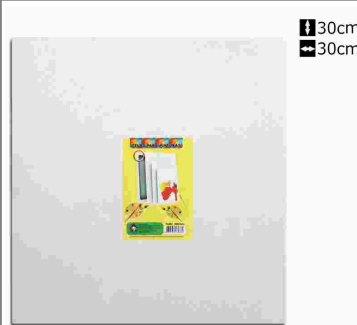

TELA PINTURA C/CHASSI MDF 30X30CM 004
 Código: 46316 Fábrica: PAPER TOYS Unidade: UN/1 F1 F4



TELA PINTURA C/CHASSI MDF 30X40CM 005
 Código: 46315 Fábrica: PAPER TOYS Unidade: UN/1 F1 F4

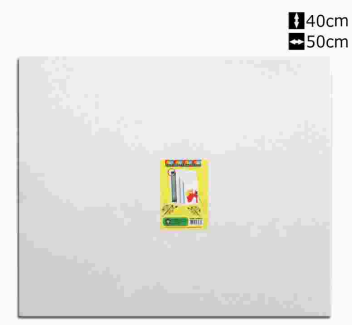

TELA PINTURA C/CHASSI MDF 40X50CM 006
 Código: 46314 Fábrica: PAPER TOYS Unidade: UN/1 F1 F4



TELA P/PINTURA 15X22CM 4758
 Código: 49326 Fábrica: STALO Unidade: UN/1 F1 F4



TELA P/PINTURA 18X24CM 4818
 Código: 50775 Fábrica: STALO Unidade: UN/1 F1 F4



TELA P/PINTURA 20X20CM 4760/8626
 Código: 49327 Fábrica: STALO Unidade: UN/1 F1 F4



TELA P/PINTURA 20X29CM PAPEL 010060
 Código: 47885 Fábrica: RIDET Unidade: UN/1 F1 F4



TELA P/PINTURA 20X30CM 8167/8604
 Código: 45634 Fábrica: STALO Unidade: UN/1 F1 F4



TELA P/PINTURA 30X30CM 8627
 Código: 49328 Fábrica: CORTIARTE Unidade: UN/1 F1 F4



TELA P/PINTURA 30X40CM 8606
 Código: 49329 Fábrica: CORTIARTE Unidade: UN/1 F1 F4

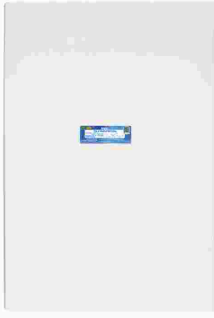

TELA P/PINTURA 50X70CM 8627/9584

Código: 50149
 Fábrica: STALO/CORTIA
 Unidade: UN/1
 F1 F4



TERMOLINA LEITOSA 100 ML 16510

Código: 44820
 Fábrica: ACRILEX
 Unidade: UN/1
 F1 F4



TERMOLINA LEITOSA 250 ML 16525

Código: 44817
 Fábrica: ACRILEX
 Unidade: UN/1
 F1 F4



TERMOLINA LEITOSA 500 ML

Código: 47876
 Fábrica: ACRILEX
 Unidade: UN/1
 F1 F4



TESOURA ESC ACO GALV 13CM 2199 CTL 12X1

Código: 44118
 Fábrica: PLANETA
 Unidade: CR/12
 F1 F4



TESOURA ESC CB PLAST PTO 13CM 4195 60X1

Código: 45228
 Fábrica: LEO&LEO
 Unidade: CX/60
 F1 F4



TESOURA ESC INOX S/PON CB PRETO CTL 4592

Código: 24963
 Fábrica: LEO&LEO
 Unidade: CR/1
 F1 F4



TESOURA ESC INOX 13CM BLACK EMB IND 24X1

Código: 40917
 Fábrica: LEO&LEO
 Unidade: CX/24
 F1 F4



TESOURA ESC INOX 13CM CLUB COLOR 24X1

Código: 48318
 Fábrica: BAZZE
 Unidade: CX/24
 F1 F4



TESOURA ESC 13CM CAB PLAST PONTA RED SOL

Código: 48594
 Fábrica: WIN PAPER
 Unidade: UN/1
 F1 F4



TESOURA ESC 13CM CB COLOR 501 24X1

Código: 42239
 Fábrica: MASTERPRINT
 Unidade: CX/24
 F1 F4



TESOURA ESC 13CM CB COLOR 503 24X1

Código: 51050
 Fábrica: MASTERPRINT
 Unidade: CX/24
 F1 F4



TESOURA ESC 13CM CB PLAST 103 60X1

Código: 42456
 Fábrica: GATTE
 Unidade: CX/60
 F1 F4



TESOURA ESC 13CM CB PRETO 502 24X1

Código: 42238
 Fábrica: MASTERPRINT
 Unidade: CX/24
 F1 F4



TESOURA ESC 13CM PIC CORTE CRIATIV 15127

Código: 33752
 Fábrica: WIN PAPER
 Unidade: UN/1
 F1 F4



TESOURA ESC 16,5CM 6,5" CB PLAST 13717

Código: 41446
 Fábrica: MABEL
 Unidade: UN/1
 F1 F4



TESOURA INOX ESC COLOR 11,5CM 167M

Código: **44099** Fábrica: **MUNDIAL** Unidade: **UN/1**
F1 F4



TESOURA INOX ESC PRETA 11,5CM 167BK

Código: **44100** Fábrica: **MUNDIAL** Unidade: **UN/1**
F1 F4

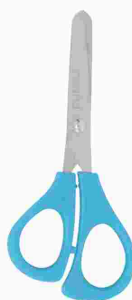

TESOURA INOX ESCOLAR PUMAX 10,5CM ' 900

Código: **41615** Fábrica: **MUNDIAL** Unidade: **UN/1**
F1 F4



TESOURA INOX MULTIUSO PROF 23,5CM 91018

Código: **48360** Fábrica: **LEO&LEO** Unidade: **CR/1**
F1 F4



TESOURA INOX 13,5CM PONTA RETA CTL 15006

Código: **48357** Fábrica: **WIN PAPER** Unidade: **CR/1**
F1 F4



TESOURA INOX 20 CM MULTIUSO SOL 2413015

Código: **41096** Fábrica: **ONDA** Unidade: **UN/1**
F1 F4



TESOURA INOX 21 CM MULTIUSO 61

Código: **45392** Fábrica: **NOX** Unidade: **CR/1**
F1 F4



TESOURA INOX 21 CM MULTIUSO 720

Código: **40888** Fábrica: **JOCAROFFICE** Unidade: **CR/1**
F1 F4



TESOURA PIC CORTE CRIATIVO CTL 141204

Código: **46383** Fábrica: **FUTURO** Unidade: **UN/1**
F1 F4



TESOURA PICO CORTE CRIATIVO ZIG ZAG 1001

Código: **9556** Fábrica: **BRW** Unidade: **UN/1**
F1 F4



TESOURA PICOTAR INOX 13CM 2299 12X1

Código: **40788** Fábrica: **PLANETA** Unidade: **CX/12**
F1 F4



TESOURA PICOTAR INOX 23CM ONDA 1418 9"

Código: **43855** Fábrica: **LIKE** Unidade: **CR/1**
F1 F4



TESOURA PICOTAR INOX 9" 23CM ONDA 513

Código: **42241** Fábrica: **MASTERPRINT** Unidade: **CR/1**
F1 F4



TESOURA PICOTAR 24CM CTL 4375

Código: **31535** Fábrica: **LEO&LEO** Unidade: **CR/1**
F1 F4



TESOURINHA DOBRAVEL 12X1

Código: **3253** Fábrica: **NYBC** Unidade: **CX/12**
F1 F4



TINTA A OLEO P/TELA 20ML SORTIDO 6X1

Código: **49307** Fábrica: **ACRILEX** Unidade: **CX/6**
F1 F4



TINTA A OLEO P/TELA 20ML 304 AMARELO 6X1
 Código: 48223 Fábrica: ACRILEX Unidade: CX/6
 F1 F4



TINTA A OLEO P/TELA 20ML 307 ALARANJ 6X1
 Código: 48224 Fábrica: ACRILEX Unidade: CX/6
 F1 F4



TINTA A OLEO P/TELA 20ML 309 AZUL CE 6X1
 Código: 48225 Fábrica: ACRILEX Unidade: CX/6
 F1 F4



TINTA A OLEO P/TELA 20ML 312 VERMELH 6X1
 Código: 48226 Fábrica: ACRILEX Unidade: CX/6
 F1 F4



TINTA A OLEO P/TELA 20ML 313 VERMELH 6X1
 Código: 48227 Fábrica: ACRILEX Unidade: CX/6
 F1 F4



TINTA A OLEO P/TELA 20ML 316 ROSA ES 6X1
 Código: 48228 Fábrica: ACRILEX Unidade: CX/6
 F1 F4



TINTA A OLEO P/TELA 20ML 319 BRANCO 6X1
 Código: 48229 Fábrica: ACRILEX Unidade: CX/6
 F1 F4



TINTA A OLEO P/TELA 20ML 320 PRETO 6X1
 Código: 48230 Fábrica: ACRILEX Unidade: CX/6
 F1 F4



TINTA A OLEO P/TELA 20ML 321 VIOLETA 6X1
 Código: 48231 Fábrica: ACRILEX Unidade: CX/6
 F1 F4



TINTA A OLEO P/TELA 20ML 322 VERDE M 6X1
 Código: 48232 Fábrica: ACRILEX Unidade: CX/6
 F1 F4



TINTA A OLEO P/TELA 20ML 323 AMARELO 6X1
 Código: 48233 Fábrica: ACRILEX Unidade: CX/6
 F1 F4



TINTA A OLEO P/TELA 20ML 363 AZUL TU 6X1
 Código: 48234 Fábrica: ACRILEX Unidade: CX/6
 F1 F4



TINTA ACRILICA 250ML BRILHANTE 513 VERDE
 Código: 50360 Fábrica: ACRILEX Unidade: UN/1
 F1 F4



TINTA ACRILICA 250ML BRILHANTE 519 BRANC
 Código: 50359 Fábrica: ACRILEX Unidade: UN/1
 F1 F4



TINTA ACRILICA 250ML FOSCA 501 AZUL TURQ
 Código: 50361 Fábrica: ACRILEX Unidade: UN/1
 F1 F4



TINTA ACRILICA 250ML FOSCA 507 VERMELHO
 Código: 50363 Fábrica: ACRILEX Unidade: UN/1
 F1 F4



TINTA ACRILICA 250ML FOSCA 516 VIOLETA

Código: 50364
 Fábrica: ACRILEX
 Unidade: UN/1
 F1 F4



TINTA ACRILICA 250ML FOSCA 517 LARANJA

Código: 50366
 Fábrica: ACRILEX
 Unidade: UN/1
 F1 F4



TINTA ACRILICA 250ML FOSCA 520 PRETO

Código: 50362
 Fábrica: ACRILEX
 Unidade: UN/1
 F1 F4



TINTA ACRILICA 250ML FOSCA 531 MARROM

Código: 50365
 Fábrica: ACRILEX
 Unidade: UN/1
 F1 F4



TINTA AQUARELA 12 CORES C/PINCEL

Código: 49273
 Fábrica: COLORARE
 Unidade: UN/1
 F1 F4



TINTA ARTES 100ML FOSCA 501 AZUL TURQUESA

Código: 40926
 Fábrica: ACRILEX
 Unidade: UN/1
 F1 F4



TINTA ARTES 100ML FOSCA 503 AZUL CELESTE

Código: 48410
 Fábrica: ACRILEX
 Unidade: UN/1
 F1 F4



TINTA ARTES 100ML FOSCA 505 AMARELO OURO

Código: 48413
 Fábrica: ACRILEX
 Unidade: UN/1
 F1 F4



TINTA ARTES 100ML FOSCA 507 VERMELHO FOGO

Código: 48412
 Fábrica: ACRILEX
 Unidade: UN/1
 F1 F4



TINTA ARTES 100ML FOSCA 510 VERDE FOLHA

Código: 48414
 Fábrica: ACRILEX
 Unidade: UN/1
 F1 F4



TINTA ARTES 100ML FOSCA 511 VERDE BANDEIRA

Código: 48415
 Fábrica: ACRILEX
 Unidade: UN/1
 F1 F4



TINTA ARTES 100ML FOSCA 516 VIOLETA

Código: 48416
 Fábrica: ACRILEX
 Unidade: UN/1
 F1 F4



TINTA ARTES 100ML FOSCA 517 LARANJA

Código: 40927
 Fábrica: ACRILEX
 Unidade: UN/1
 F1 F4



TINTA ARTES 100ML FOSCA 519 BRANCO

Código: 48411
 Fábrica: ACRILEX
 Unidade: UN/1
 F1 F4



TINTA ARTES 100ML FOSCA 520 PRETO

Código: 48418
 Fábrica: ACRILEX
 Unidade: UN/1
 F1 F4



TINTA ARTES 100ML FOSCA 531 MARROM

Código: 48417
 Fábrica: ACRILEX
 Unidade: UN/1
 F1 F4



TINTA ARTES 100ML FOSCA 537 ROSA

Código: **40928** Fábrica: **ACRILEX** Unidade: **UN/1**
F1 F4



TINTA ARTESANATO 100ML FOSCA

Código: **40930** Fábrica: **ACRILEX** Unidade: **UN/1**
F1 F4



TINTA CRAQUELEX 37ML 501 AZUL TURQUESA

Código: **44832** Fábrica: **ACRILEX** Unidade: **UN/1**
F1 F4



TINTA CRAQUELEX 37ML 505 AMARELO OURO

Código: **44835** Fábrica: **ACRILEX** Unidade: **UN/1**
F1 F4



TINTA CRAQUELEX 37ML 507 VERMELHO FOGO

Código: **44834** Fábrica: **ACRILEX** Unidade: **UN/1**
F1 F4



TINTA CRAQUELEX 37ML 513 VERDE MUSGO

Código: **44833** Fábrica: **ACRILEX** Unidade: **UN/1**
F1 F4



TINTA CRAQUELEX 37ML 519 BRANCO

Código: **44830** Fábrica: **ACRILEX** Unidade: **UN/1**
F1 F4

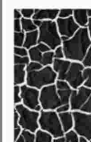

TINTA CRAQUELEX 37ML 520 PRETO

Código: **44831** Fábrica: **ACRILEX** Unidade: **UN/1**
F1 F4

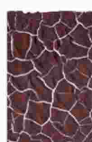

TINTA CRAQUELEX 37ML 531 MARRON

Código: **44836** Fábrica: **ACRILEX** Unidade: **UN/1**
F1 F4



TINTA DIMENSIONAL 35ML BRILLIAN 501 AZUL

Código: **44825** Fábrica: **ACRILEX** Unidade: **UN/1**
F1 F4



TINTA DIMENSIONAL 35ML BRILLIAN 505 AMAR

Código: **44828** Fábrica: **ACRILEX** Unidade: **UN/1**
F1 F4



TINTA DIMENSIONAL 35ML BRILLIAN 507 VERM

Código: **44829** Fábrica: **ACRILEX** Unidade: **UN/1**
F1 F4



TINTA DIMENSIONAL 35ML BRILLIAN 513 VERD

Código: **44827** Fábrica: **ACRILEX** Unidade: **UN/1**
F1 F4



TINTA DIMENSIONAL 35ML BRILLIAN 519 BCO

Código: **44823** Fábrica: **ACRILEX** Unidade: **UN/1**
F1 F4



TINTA DIMENSIONAL 35ML BRILLIAN 520 PTO

Código: **44824** Fábrica: **ACRILEX** Unidade: **UN/1**
F1 F4



TINTA DIMENSIONAL 35ML BRILLIAN 531 MARR

Código: **44826** Fábrica: **ACRILEX** Unidade: **UN/1**
F1 F4



TINTA FACIAL 15 ML AMARELO 1002
 Código: 46557 Fábrica: COR&ARTE Unidade: UN/1
 F1 F4



TINTA FACIAL 15 ML AZUL CLARO 1007
 Código: 46558 Fábrica: COR&ARTE Unidade: UN/1
 F1 F4



TINTA FACIAL 15 ML AZUL 1004
 Código: 46550 Fábrica: COR&ARTE Unidade: UN/1
 F1 F4



TINTA FACIAL 15 ML BRANCA 1001
 Código: 46549 Fábrica: COR&ARTE Unidade: UN/1
 F1 F4



TINTA FACIAL 15 ML LARANJA 1009
 Código: 46551 Fábrica: COR&ARTE Unidade: UN/1
 F1 F4



TINTA FACIAL 15 ML LILAS LAVANDA 1022
 Código: 46559 Fábrica: COR&ARTE Unidade: UN/1
 F1 F4



TINTA FACIAL 15 ML MARRROM 1008
 Código: 46552 Fábrica: COR&ARTE Unidade: UN/1
 F1 F4



TINTA FACIAL 15 ML PINK FLUOR 1016
 Código: 46553 Fábrica: COR&ARTE Unidade: UN/1
 F1 F4



TINTA FACIAL 15 ML PRETO 1005
 Código: 46554 Fábrica: COR&ARTE Unidade: UN/1
 F1 F4



TINTA FACIAL 15 ML VERDE 1006
 Código: 46555 Fábrica: COR&ARTE Unidade: UN/1
 F1 F4



TINTA FACIAL 15 ML VERMELHO 1003
 Código: 46556 Fábrica: COR&ARTE Unidade: UN/1
 F1 F4



TINTA FACIAL 15 ML 6 CORES+PINCEL+GLITER
 Código: 46546 Fábrica: COR&ARTE Unidade: CJ/1
 F1 F4



TINTA FACIAL 15 ML 6 CORES+PINCEL+GLITER
 Código: 44637 Fábrica: COR&ARTE Unidade: CJ/1
 F1 F4



TINTA FACIAL 4 GR GLITER CREMOS 4011 5X1
 Código: 46548 Fábrica: COR&ARTE Unidade: CJ/5
 F1 F4



TINTA GUACHE 15ML 6 CORES SORT 6X1
 Código: 19150 Fábrica: MAXCRIL Unidade: CX/6
 F1 F4



TINTA GUACHE 15ML AMARELO 12X1
 Código: 5929 Fábrica: MARIPEL Unidade: DZ/12
 F1 F4



TINTA GUACHE 15ML AZUL CLARO 12X1
 Código: 5816 Fábrica: MARIPEL Unidade: DZ/12 F1 F4



TINTA GUACHE 15ML AZUL ESCURO 12X1
 Código: 19035 Fábrica: MARIPEL Unidade: DZ/12 F1 F4



TINTA GUACHE 15ML BRANCO 12X1
 Código: 5818 Fábrica: MARIPEL Unidade: DZ/12 F1 F4



TINTA GUACHE 15ML LARANJA 12X1
 Código: 15283 Fábrica: MARIPEL Unidade: DZ/12 F1 F4



TINTA GUACHE 15ML MARRON 12X1
 Código: 10033 Fábrica: MARIPEL Unidade: DZ/12 F1 F4



TINTA GUACHE 15ML PESSEGO 12X1
 Código: 5820 Fábrica: MARIPEL Unidade: DZ/12 F1 F4



TINTA GUACHE 15ML PRETO 12X1
 Código: 19199 Fábrica: MARIPEL Unidade: DZ/12 F1 F4



TINTA GUACHE 15ML ROSA 12X1
 Código: 21879 Fábrica: MARIPEL Unidade: DZ/12 F1 F4



TINTA GUACHE 15ML VERDE BAND 12X1
 Código: 5823 Fábrica: MARIPEL Unidade: DZ/12 F1 F4



TINTA GUACHE 15ML VERDE CLARO 12X1
 Código: 5824 Fábrica: MARIPEL Unidade: DZ/12 F1 F4



TINTA GUACHE 15ML VERMELHO 12X1
 Código: 7429 Fábrica: MARIPEL Unidade: DZ/12 F1 F4



TINTA GUACHE 15ML 12 CORES SORT 12X1
 Código: 50519 Fábrica: MARIPEL Unidade: DZ/12 F1 F4



TINTA GUACHE 15ML 6 CORES SORT 6X1 K04
 Código: 45145 Fábrica: COLA MAIS Unidade: CX/6 F1 F4



TINTA GUACHE 30ML 6 CORES SORT 6X1
 Código: 14667 Fábrica: MARIPEL Unidade: CX/6 F1 F4



TINTA GUACHE PINTURA DEDO 6 CORES SORT
 Código: 14673 Fábrica: MARIPEL Unidade: CX/6 F1 F4



TINTA GUACHE 250ML AMARELO
 Código: 45149 Fábrica: COLA MAIS Unidade: UN/1 F1 F4



TINTA GUACHE 250ML AZUL

Código: **45147** Fábrica: **COLA MAIS** Unidade: **UN/1**
F1 F4



TINTA GUACHE 250ML AZUL CELESTE

Código: **33046** Fábrica: **EVIDENT** Unidade: **UN/1**
F1 F4



TINTA GUACHE 250ML AZUL CELESTE

Código: **39914** Fábrica: **VMP** Unidade: **UN/1**
F1 F4



TINTA GUACHE 250ML AZUL ESCURO

Código: **50842** Fábrica: **MARIPEL** Unidade: **UN/1**
F1 F4



TINTA GUACHE 250ML AZUL TURQUEZA

Código: **39915** Fábrica: **VMP** Unidade: **UN/1**
F1 F4



TINTA GUACHE 250ML BRANCO

Código: **45146** Fábrica: **COLA MAIS** Unidade: **UN/1**
F1 F4



TINTA GUACHE 250ML LARANJA

Código: **39917** Fábrica: **VMP** Unidade: **UN/1**
F1 F4



TINTA GUACHE 250ML MARROM

Código: **39922** Fábrica: **COLA MAIS** Unidade: **UN/1**
F1 F4



TINTA GUACHE 250ML PRETO

Código: **39921** Fábrica: **EVIDENT** Unidade: **UN/1**
F1 F4



TINTA GUACHE 250ML ROSA

Código: **39918** Fábrica: **VMP** Unidade: **UN/1**
F1 F4



TINTA GUACHE 250ML ROSA

Código: **49176** Fábrica: **COLA MAIS** Unidade: **UN/1**
F1 F4



TINTA GUACHE 250ML VERDE BANDEIRA

Código: **39919** Fábrica: **VMP** Unidade: **UN/1**
F1 F4



TINTA GUACHE 250ML VERDE BANDEIRA

Código: **33313** Fábrica: **EVIDENT** Unidade: **UN/1**
F1 F4



TINTA GUACHE 250ML VERDE ESCURO

Código: **45150** Fábrica: **MARIPEL/COLA** Unidade: **UN/1**
F1 F4



TINTA GUACHE 250ML VERMELHO

Código: **45151** Fábrica: **COLA MAIS** Unidade: **UN/1**
F1 F4



TINTA GUACHE 250ML VERMELHO ESC

Código: **49175** Fábrica: **COLA MAIS** Unidade: **UN/1**
F1 F4



TINTA GUACHE 250ML 501 AZUL TURQUESA

Código: 45038
 Fábrica: ACRILEX
 Unidade: UN/1
 F1 F4



TINTA GUACHE 250ML 503 AZUL CELESTE

Código: 45040
 Fábrica: ACRILEX
 Unidade: UN/1
 F1 F4



TINTA GUACHE 250ML 504 AMARELO LIMAÓ

Código: 45044
 Fábrica: ACRILEX
 Unidade: UN/1
 F1 F4



TINTA GUACHE 250ML 505 AMARELO OURO

Código: 45045
 Fábrica: ACRILEX
 Unidade: UN/1
 F1 F4



TINTA GUACHE 250ML 507 VERMELHO FOGO

Código: 45042
 Fábrica: ACRILEX
 Unidade: UN/1
 F1 F4



TINTA GUACHE 250ML 510 VERDE FOLHA

Código: 45051
 Fábrica: ACRILEX
 Unidade: UN/1
 F1 F4



TINTA GUACHE 250ML 511 VERDE BANDEIRA

Código: 45043
 Fábrica: ACRILEX
 Unidade: UN/1
 F1 F4



TINTA GUACHE 250ML 516 VIOLETA

Código: 45052
 Fábrica: ACRILEX
 Unidade: UN/1
 F1 F4



TINTA GUACHE 250ML 517 LARANJA

Código: 45053
 Fábrica: ACRILEX
 Unidade: UN/1
 F1 F4



TINTA GUACHE 250ML 519 BRANCO

Código: 45037
 Fábrica: ACRILEX
 Unidade: UN/1
 F1 F4



TINTA GUACHE 250ML 520 PRETO

Código: 45039
 Fábrica: ACRILEX
 Unidade: UN/1
 F1 F4



TINTA GUACHE 250ML 528 LILAS

Código: 45049
 Fábrica: ACRILEX
 Unidade: UN/1
 F1 F4



TINTA GUACHE 250ML 531 MARROM

Código: 45047
 Fábrica: ACRILEX
 Unidade: UN/1
 F1 F4



TINTA GUACHE 250ML 537 ROSA

Código: 45054
 Fábrica: ACRILEX
 Unidade: UN/1
 F1 F4



TINTA GUACHE 250ML 538 AMARELO PÊSSEGO

Código: 45046
 Fábrica: ACRILEX
 Unidade: UN/1
 F1 F4



TINTA GUACHE 250ML 549 MAGENTA

Código: 45050
 Fábrica: ACRILEX
 Unidade: UN/1
 F1 F4



TINTA GUACHE 250ML 559 AZUL

Código: 45041
 Fábrica: ACRILEX
 Unidade: UN/1
 F1 F4



TINTA GUACHE 250ML 565 VINHO

Código: 45048
 Fábrica: ACRILEX
 Unidade: UN/1
 F1 F4



TINTA GUACHE 250ML 933 CINZA

Código: 45055
 Fábrica: ACRILEX
 Unidade: UN/1
 F1 F4



TINTA IMP CANON REFIL 100ML BK

Código: 42236
 Fábrica: MASTERPRINT
 Unidade: UN/1
 F1 F4



TINTA IMP EPSON REFIL 70ML BK 544120

Código: 44196
 Fábrica: MAXPRINT
 Unidade: UN/1
 F1 F4



TINTA IMP EPSON REFIL 70ML CIANO 544220

Código: 44197
 Fábrica: MAXPRINT
 Unidade: UN/1
 F1 F4



TINTA IMP EPSON REFIL 70ML MAGEN 544320

Código: 44198
 Fábrica: MAXPRINT
 Unidade: UN/1
 F1 F4



TINTA IMP EPSON REFIL 70ML 504/544 CYAN

Código: 45116
 Fábrica: MASTERPRINT
 Unidade: UN/1
 F1 F4



TINTA IMP EPSON REFIL 70ML 504/544 MAG

Código: 45118
 Fábrica: MASTERPRINT
 Unidade: UN/1
 F1 F4



TINTA IMP EPSON REFIL 70ML 504/544 YELL

Código: 45117
 Fábrica: MASTERPRINT
 Unidade: UN/1
 F1 F4



TINTA IMP EPSON REFIL 100ML BK 664/672/6

Código: 38242
 Fábrica: MASTERPRINT
 Unidade: UN/1
 F1 F4



TINTA IMP EPSON REFIL 100ML CYA

Código: 41737
 Fábrica: MASTERPRINT
 Unidade: UN/1
 F1 F4



TINTA IMP EPSON REFIL 100ML CYA 664/673

Código: 38241
 Fábrica: MASTERPRINT
 Unidade: UN/1
 F1 F4



TINTA IMP EPSON REFIL 100ML MAG 664/673

Código: 38240
 Fábrica: MASTERPRINT
 Unidade: UN/1
 F1 F4



TINTA IMP EPSON REFIL 100ML MAG 673

Código: 45119
 Fábrica: MASTERPRINT
 Unidade: UN/1
 F1 F4



TINTA IMP EPSON REFIL 100ML YEL 664/673

Código: 38239
 Fábrica: MASTERPRINT
 Unidade: UN/1
 F1 F4



TINTA IMP EPSON REFIL 127ML 504/544 BK

Código: 45120
 Fábrica: MASTERPRINT
 Unidade: UN/1
 F1 F4



TINTA IMP EPSON 1 LT UNIVER BK

Código: 38246
 Fábrica: MASTERPRINT
 Unidade: UN/1
 F1 F4



TINTA IMP EPSON 1 LT UNIVER CYAN

Código: 38245
 Fábrica: MASTERPRINT
 Unidade: UN/1
 F1 F4



TINTA IMP EPSON 1 LT UNIVER MAGENTA

Código: 38243
 Fábrica: MASTERPRINT
 Unidade: UN/1
 F1 F4



TINTA IMP EPSON 1 LT UNIVER YELLOW

Código: 38244
 Fábrica: MASTERPRINT
 Unidade: UN/1
 F1 F4



TINTA IMP HP REFIL 100ML UNIVER BK

Código: 46177
 Fábrica: MASTERPRINT
 Unidade: UN/1
 F1 F4



TINTA IMP HP REFIL 100ML UNIVER CYAN

Código: 46178
 Fábrica: MASTERPRINT
 Unidade: UN/1
 F1 F4



TINTA IMP HP REFIL 100ML UNIVER MAGENTA

Código: 46179
 Fábrica: MASTERPRINT
 Unidade: UN/1
 F1 F4



TINTA IMP HP REFIL 100ML UNIVER YELLOW

Código: 46180
 Fábrica: MASTERPRINT
 Unidade: UN/1
 F1 F4



TINTA IMP HP 1 LT UNIVERSAL BK

Código: 40889
 Fábrica: MASTERPRINT
 Unidade: UN/1
 F1 F4



TINTA P/CARIMBO 40 ML AZUL 132 UN

Código: 41959
 Fábrica: CARBRINK
 Unidade: UN/1
 F1 F4



TINTA P/CARIMBO 40 ML PRETO 133 UN

Código: 41958
 Fábrica: CARBRINK
 Unidade: UN/1
 F1 F4



TINTA P/CARIMBO 40 ML PRETO 133 12X1

Código: 12583
 Fábrica: CARBRINK
 Unidade: DZ/12
 F1 F4



TINTA P/CARIMBO 40 ML VERMELHO 134 UN

Código: 41960
 Fábrica: CARBRI/RADEX
 Unidade: UN/1
 F1 F4



TINTA PINCEL MARC PERM 20ML AZUL UN

Código: 47139
 Fábrica: BRW
 Unidade: UN/1
 F1 F4



TINTA PINCEL MARC PERM 20ML AZUL 12X1

Código: 23188
 Fábrica: BRW
 Unidade: DZ/12
 F1 F4



TINTA PINCEL MARC PERM 20ML PRETO UN

Código: **47172** Fábrica: **BRW** Unidade: **UN/1**
F1 F4



TINTA PINCEL MARC PERM 20ML PRETO 12X1

Código: **12584** Fábrica: **BRW** Unidade: **DZ/12**
F1 F4



TINTA PINCEL MARC PERM 20ML VERDE 12X1

Código: **44997** Fábrica: **BRW** Unidade: **DZ/12**
F1 F4



TINTA PINCEL MARC PERM 20ML VERMEL 12X1

Código: **19881** Fábrica: **BRW** Unidade: **DZ/12**
F1 F4



TINTA PINCEL MARC PERM 20ML VERMELHO UN

Código: **47140** Fábrica: **BRW** Unidade: **UN/1**
F1 F4



TINTA PINCEL MARC PERM 40ML AZUL UN

Código: **45141** Fábrica: **CARBRINK** Unidade: **UN/1**
F1 F4



TINTA PINCEL MARC QDO BCO 20ML AZU 12X1

Código: **33683** Fábrica: **BRW** Unidade: **DZ/12**
F1 F4



TINTA PINCEL MARC QDO BCO 20ML PTO 12X1

Código: **33682** Fábrica: **BRW** Unidade: **DZ/12**
F1 F4



TINTA PINCEL MARC QDO BCO 20ML VD 12X1

Código: **44998** Fábrica: **BRW** Unidade: **DZ/12**
F1 F4



TINTA PINCEL MARC QDO BCO 20ML VM 12X1

Código: **38015** Fábrica: **BRW** Unidade: **DZ/12**
F1 F4



TINTA PINCEL MARC QDO BCO 500ML AZUL UN

Código: **44157** Fábrica: **BRW** Unidade: **UN/1**
F1 F4



TINTA PINCEL MARC QDO BCO 500ML PRETO UN

Código: **44158** Fábrica: **BRW** Unidade: **UN/1**
F1 F4



TINTA PINCEL MARC QDO BCO 500ML VERM UN

Código: **44159** Fábrica: **BRW** Unidade: **UN/1**
F1 F4



TINTA PINCEL MARC QDO BCO 5,5ML AZU 12X1

Código: **47479** Fábrica: **BRW** Unidade: **CX/12**
F1 F4



TINTA PINCEL MARC QDO BCO 5,5ML PTO 12X1

Código: **47785** Fábrica: **BRW** Unidade: **CX/12**
F1 F4



TINTA PINCEL MARC QDO BCO 5,5ML VM 12X1

Código: **47506** Fábrica: **BRW** Unidade: **CX/12**
F1 F4



TINTA PINTURA DEDO 15ML 6 CORES SORT

Código: 45498 Fábrica: ACRILEX Unidade: CX/6
F1 F4



TINTA PINTURA FACIAL 4GR COR CREMOSA 6X1

Código: 50761 Fábrica: MARIPEL Unidade: CR/6
F1 F4



TINTA PVA 37ML FOSCA 501 AZUL TURQUESA

Código: 48237 Fábrica: ACRILEX Unidade: UN/1
F1 F4



TINTA PVA 37ML FOSCA 503 AZUL CELESTE

Código: 48238 Fábrica: ACRILEX Unidade: UN/1
F1 F4



TINTA PVA 37ML FOSCA 504 AMARELO LIMAO

Código: 48239 Fábrica: ACRILEX Unidade: UN/1
F1 F4



TINTA PVA 37ML FOSCA 505 AMARELO OURO

Código: 48240 Fábrica: ACRILEX Unidade: UN/1
F1 F4



TINTA PVA 37ML FOSCA 507 VERMELHO FOGO

Código: 48241 Fábrica: ACRILEX Unidade: UN/1
F1 F4



TINTA PVA 37ML FOSCA 508 VERMELHO ESCAR

Código: 48242 Fábrica: ACRILEX Unidade: UN/1
F1 F4



TINTA PVA 37ML FOSCA 510 VERDE FOLHA

Código: 48243 Fábrica: ACRILEX Unidade: UN/1
F1 F4



TINTA PVA 37ML FOSCA 511 VERDE BANDEIRA

Código: 48244 Fábrica: ACRILEX Unidade: UN/1
F1 F4



TINTA PVA 37ML FOSCA 513 VERDE MUSGO

Código: 48245 Fábrica: ACRILEX Unidade: UN/1
F1 F4



TINTA PVA 37ML FOSCA 516 VIOLETA

Código: 48246 Fábrica: ACRILEX Unidade: UN/1
F1 F4



TINTA PVA 37ML FOSCA 517 LARANJA

Código: 48247 Fábrica: ACRILEX Unidade: UN/1
F1 F4



TINTA PVA 37ML FOSCA 519 BRANCO

Código: 48235 Fábrica: ACRILEX Unidade: UN/1
F1 F4



TINTA PVA 37ML FOSCA 520 PRETO

Código: 48262 Fábrica: ACRILEX Unidade: UN/1
F1 F4



TINTA PVA 37ML FOSCA 528 LILAS

Código: 48248 Fábrica: ACRILEX Unidade: UN/1
F1 F4



TINTA PVA 37ML FOSCA 531 MARROM
 Código: 48249 Fábrica: ACRILEX Unidade: UN/1
 F1 F4



TINTA PVA 37ML FOSCA 535 AZUL MAR
 Código: 48250 Fábrica: ACRILEX Unidade: UN/1
 F1 F4



TINTA PVA 37ML FOSCA 537 ROSA
 Código: 48251 Fábrica: ACRILEX Unidade: UN/1
 F1 F4



TINTA PVA 37ML FOSCA 538 AMARELO PESSEGO
 Código: 48252 Fábrica: ACRILEX Unidade: UN/1
 F1 F4



TINTA PVA 37ML FOSCA 541 VERMELHO VIVO
 Código: 48253 Fábrica: ACRILEX Unidade: UN/1
 F1 F4



TINTA PVA 37ML FOSCA 542 ROSA ESCURO
 Código: 48254 Fábrica: ACRILEX Unidade: UN/1
 F1 F4



TINTA PVA 37ML FOSCA 549 MAGENTA
 Código: 48255 Fábrica: ACRILEX Unidade: UN/1
 F1 F4



TINTA PVA 37ML FOSCA 565 VINHO
 Código: 48256 Fábrica: ACRILEX Unidade: UN/1
 F1 F4



TINTA PVA 37ML FOSCA 567 ROSA CHA
 Código: 48406 Fábrica: ACRILEX Unidade: UN/1
 F1 F4



TINTA PVA 37ML FOSCA 574 CINZA LUNAR
 Código: 48405 Fábrica: ACRILEX Unidade: UN/1
 F1 F4



TINTA PVA 37ML FOSCA 577 TURQUESA
 Código: 48257 Fábrica: ACRILEX Unidade: UN/1
 F1 F4



TINTA PVA 37ML FOSCA 813 ROSA BB
 Código: 48258 Fábrica: ACRILEX Unidade: UN/1
 F1 F4



TINTA PVA 37ML FOSCA 817 AREIA
 Código: 48259 Fábrica: ACRILEX Unidade: UN/1
 F1 F4



TINTA PVA 37ML FOSCA 829 FLAMINGO
 Código: 48260 Fábrica: ACRILEX Unidade: UN/1
 F1 F4



TINTA SPRAY 350ML 250G ALUMINIO
 Código: 42226 Fábrica: TEK BOND Unidade: UN/1
 F1 F4



TINTA SPRAY 350ML 250G AMARELO
 Código: 42220 Fábrica: TEK BOND Unidade: UN/1
 F1 F4



TINTA SPRAY 350ML 250G AZUL

Código: 42222
 Fábrica: TEK BOND
 Unidade: UN/1
 F1 F4



TINTA SPRAY 350ML 250G BRANCO BRILHANTE

Código: 42214
 Fábrica: TEK BOND
 Unidade: UN/1
 F1 F4



TINTA SPRAY 350ML 250G BRANCO FOSCO

Código: 42215
 Fábrica: TEK BOND
 Unidade: UN/1
 F1 F4



TINTA SPRAY 350ML 250G DOURADO

Código: 42218
 Fábrica: TEK BOND
 Unidade: UN/1
 F1 F4



TINTA SPRAY 350ML 250G GELO

Código: 48646
 Fábrica: TEK BOND
 Unidade: UN/1
 F1 F4



TINTA SPRAY 350ML 250G GRAFITE

Código: 48645
 Fábrica: TEK BOND
 Unidade: UN/1
 F1 F4



TINTA SPRAY 350ML 250G LARANJA

Código: 42224
 Fábrica: TEK BOND
 Unidade: UN/1
 F1 F4



TINTA SPRAY 350ML 250G PLATINA

Código: 48647
 Fábrica: TEK BOND
 Unidade: UN/1
 F1 F4



TINTA SPRAY 350ML 250G PREMIER FUNDO

Código: 42227
 Fábrica: TEK BOND
 Unidade: UN/1
 F1 F4



TINTA SPRAY 350ML 250G PRETO BRILHANTE

Código: 42216
 Fábrica: TEK BOND
 Unidade: UN/1
 F1 F4



TINTA SPRAY 350ML 250G PRETO FOSCO

Código: 42217
 Fábrica: TEK BOND
 Unidade: UN/1
 F1 F4



TINTA SPRAY 350ML 250G ROSA

Código: 42225
 Fábrica: TEK BOND
 Unidade: UN/1
 F1 F4



TINTA SPRAY 350ML 250G VERDE

Código: 42223
 Fábrica: TEK BOND
 Unidade: UN/1
 F1 F4



TINTA SPRAY 350ML 250G VERMELHO

Código: 42219
 Fábrica: TEK BOND
 Unidade: UN/1
 F1 F4



TINTA TECIDO 35ML ACRIPUFF 501 AZUL TUR

Código: 44838
 Fábrica: ACRILEX
 Unidade: UN/1
 F1 F4



TINTA TECIDO 35ML ACRIPUFF 505 AMARELO

Código: 44840
 Fábrica: ACRILEX
 Unidade: UN/1
 F1 F4



TINTA TECIDO 35ML ACRIPUFF 507 VERMELHO
 Código: 44841 Fábrica: ACRILEX Unidade: UN/1
 F1 F4



TINTA TECIDO 35ML ACRIPUFF 513 VERDE MU
 Código: 44845 Fábrica: ACRILEX Unidade: UN/1
 F1 F4



TINTA TECIDO 35ML ACRIPUFF 519 BRANCO
 Código: 44837 Fábrica: ACRILEX Unidade: UN/1
 F1 F4



TINTA TECIDO 35ML ACRIPUFF 520 PRETO
 Código: 44839 Fábrica: ACRILEX Unidade: UN/1
 F1 F4



TINTA TECIDO 35ML ACRIPUFF 531 MARROM
 Código: 44842 Fábrica: ACRILEX Unidade: UN/1
 F1 F4



TINTA TECIDO 35ML ACRIPUFF 537 ROSA
 Código: 44843 Fábrica: ACRILEX Unidade: UN/1
 F1 F4



TINTA TECIDO 35ML ACRIPUFF 540 VIOLETA
 Código: 44844 Fábrica: ACRILEX Unidade: UN/1
 F1 F4



TINTA TECIDO 37ML AMARELO SOL
 Código: 48632 Fábrica: TEK BOND Unidade: UN/1
 F1 F4



TINTA TECIDO 37ML AZUL CARIBE
 Código: 50727 Fábrica: TEK BOND Unidade: UN/1
 F1 F4



TINTA TECIDO 37ML AZUL ROYAL
 Código: 48636 Fábrica: TEK BOND Unidade: UN/1
 F1 F4



TINTA TECIDO 37ML BRANCO
 Código: 48629 Fábrica: TEK BOND Unidade: UN/1
 F1 F4



TINTA TECIDO 37ML LILAS
 Código: 48637 Fábrica: TEK BOND Unidade: UN/1
 F1 F4



TINTA TECIDO 37ML MARROM
 Código: 48635 Fábrica: TEK BOND Unidade: UN/1
 F1 F4



TINTA TECIDO 37ML PINK
 Código: 48638 Fábrica: TEK BOND Unidade: UN/1
 F1 F4



TINTA TECIDO 37ML PRETO
 Código: 48630 Fábrica: TEK BOND Unidade: UN/1
 F1 F4



TINTA TECIDO 37ML ROSA CRUSH
 Código: 50732 Fábrica: TEK BOND Unidade: UN/1
 F1 F4



TINTA TECIDO 37ML ROXO
 Código: 48633
 Fábrica: TEK BOND
 Unidade: UN/1
 F1 F4



TINTA TECIDO 37ML VERDE FLORESTA
 Código: 48634
 Fábrica: TEK BOND
 Unidade: UN/1
 F1 F4



TINTA TECIDO 37ML VERDE GRAMA
 Código: 50729
 Fábrica: TEK BOND
 Unidade: UN/1
 F1 F4



TINTA TECIDO 37ML VERMELHO
 Código: 48631
 Fábrica: TEK BOND
 Unidade: UN/1
 F1 F4



TINTA TECIDO 37ML VERMELHO AMOR
 Código: 50724
 Fábrica: TEK BOND
 Unidade: UN/1
 F1 F4



TINTA TECIDO 37ML VERMELHO CARMESIM
 Código: 50730
 Fábrica: TEK BOND
 Unidade: UN/1
 F1 F4



TINTA TECIDO 37ML VERMELHO PIMENTA
 Código: 50726
 Fábrica: TEK BOND
 Unidade: UN/1
 F1 F4



TINTA TECIDO 37ML VERMELHO SANGUE
 Código: 50725
 Fábrica: TEK BOND
 Unidade: UN/1
 F1 F4



TINTA TECIDO 37ML VERMELHO TELHA
 Código: 50731
 Fábrica: TEK BOND
 Unidade: UN/1
 F1 F4



TINTA TECIDO 37ML 500 CLAREADOR
 Código: 44854
 Fábrica: ACRILEX
 Unidade: UN/1
 F1 F4



TINTA TECIDO 37ML 501 AZUL TURQUESA
 Código: 45022
 Fábrica: ACRILEX
 Unidade: UN/1
 F1 F4



TINTA TECIDO 37ML 502 AZUL COBALTO
 Código: 44937
 Fábrica: ACRILEX
 Unidade: UN/1
 F1 F4



TINTA TECIDO 37ML 503 AZUL CELESTE
 Código: 44856
 Fábrica: ACRILEX
 Unidade: UN/1
 F1 F4



TINTA TECIDO 37ML 504 AMARELO LIMAO
 Código: 44893
 Fábrica: ACRILEX
 Unidade: UN/1
 F1 F4



TINTA TECIDO 37ML 505 AMARELO OURO
 Código: 44896
 Fábrica: ACRILEX
 Unidade: UN/1
 F1 F4



TINTA TECIDO 37ML 506 CERAMICA
 Código: 44952
 Fábrica: ACRILEX
 Unidade: UN/1
 F1 F4



TINTA TECIDO 37ML 507 VERMELHO FOGO
 Código: 44920 Fábrica: ACRILEX Unidade: UN/1
 F1 F4



TINTA TECIDO 37ML 508 VERMELHO ESCARLAT
 Código: 44912 Fábrica: ACRILEX Unidade: UN/1
 F1 F4



TINTA TECIDO 37ML 509 VERMELHO CARMIN
 Código: 44913 Fábrica: ACRILEX Unidade: UN/1
 F1 F4



TINTA TECIDO 37ML 510 VERDE FOLHA
 Código: 44933 Fábrica: ACRILEX Unidade: UN/1
 F1 F4



TINTA TECIDO 37ML 511 VERDE BANDEIRA
 Código: 44930 Fábrica: ACRILEX Unidade: UN/1
 F1 F4



TINTA TECIDO 37ML 512 VERDE VERONESE
 Código: 44961 Fábrica: ACRILEX Unidade: UN/1
 F1 F4



TINTA TECIDO 37ML 513 VERDE MUSGO
 Código: 44935 Fábrica: ACRILEX Unidade: UN/1
 F1 F4



TINTA TECIDO 37ML 514 TERRA QUEI
 Código: 44964 Fábrica: ACRILEX Unidade: UN/1
 F1 F4



TINTA TECIDO 37ML 516 VIOLETA
 Código: 44874 Fábrica: ACRILEX Unidade: UN/1
 F1 F4



TINTA TECIDO 37ML 517 LARANJA
 Código: 44942 Fábrica: ACRILEX Unidade: UN/1
 F1 F4



TINTA TECIDO 37ML 518 SALMAO
 Código: 44885 Fábrica: ACRILEX Unidade: UN/1
 F1 F4



TINTA TECIDO 37ML 519 BRANCO
 Código: 44851 Fábrica: ACRILEX Unidade: UN/1
 F1 F4



TINTA TECIDO 37ML 520 PRETO
 Código: 44852 Fábrica: ACRILEX Unidade: UN/1
 F1 F4



TINTA TECIDO 37ML 525 CAMURCA
 Código: 44870 Fábrica: ACRILEX Unidade: UN/1
 F1 F4



TINTA TECIDO 37ML 527 ROSA PINK
 Código: 44903 Fábrica: ACRILEX Unidade: UN/1
 F1 F4



TINTA TECIDO 37ML 528 LILAS
 Código: 44888 Fábrica: ACRILEX Unidade: UN/1
 F1 F4



TINTA TECIDO 37ML 529 MARFIM
 Código: 44891 Fábrica: ACRILEX Unidade: UN/1
 F1 F4



TINTA TECIDO 37ML 531 MARROM
 Código: 44882 Fábrica: ACRILEX Unidade: UN/1
 F1 F4



TINTA TECIDO 37ML 535 AZUL MAR
 Código: 45023 Fábrica: ACRILEX Unidade: UN/1
 F1 F4



TINTA TECIDO 37ML 536 AMARELO CADMIO
 Código: 44898 Fábrica: ACRILEX Unidade: UN/1
 F1 F4



TINTA TECIDO 37ML 537 ROSA
 Código: 44901 Fábrica: ACRILEX Unidade: UN/1
 F1 F4



TINTA TECIDO 37ML 538 AMARELO PESSEGO
 Código: 44895 Fábrica: ACRILEX Unidade: UN/1
 F1 F4



TINTA TECIDO 37ML 539 SIENA NATURAL
 Código: 44965 Fábrica: ACRILEX Unidade: UN/1
 F1 F4



TINTA TECIDO 37ML 540 VIOLETA COBALTO
 Código: 44958 Fábrica: ACRILEX Unidade: UN/1
 F1 F4



TINTA TECIDO 37ML 541 VERMELHO VIVO
 Código: 44915 Fábrica: ACRILEX Unidade: UN/1
 F1 F4



TINTA TECIDO 37ML 542 ROSA ESCURO
 Código: 44906 Fábrica: ACRILEX Unidade: UN/1
 F1 F4



TINTA TECIDO 37ML 543 AZUL ULTRAMAR
 Código: 44940 Fábrica: ACRILEX Unidade: UN/1
 F1 F4



TINTA TECIDO 37ML 544 AZUL MARINHO
 Código: 44865 Fábrica: ACRILEX Unidade: UN/1
 F1 F4



TINTA TECIDO 37ML 545 VERDE OLIVA
 Código: 44934 Fábrica: ACRILEX Unidade: UN/1
 F1 F4



TINTA TECIDO 37ML 546 VERDE PINHEIRO
 Código: 44947 Fábrica: ACRILEX Unidade: UN/1
 F1 F4



TINTA TECIDO 37ML 549 MAGENTA
 Código: 44910 Fábrica: ACRILEX Unidade: UN/1
 F1 F4



TINTA TECIDO 37ML 550 VERMELHO PURPURA
 Código: 44917 Fábrica: ACRILEX Unidade: UN/1
 F1 F4



TINTA TECIDO 37ML 551 SEPIA

Código: 44869 Fábrica: ACRILEX Unidade: UN/1 F1 F4



TINTA TECIDO 37ML 552 VERDE GLACIAL

Código: 44931 Fábrica: ACRILEX Unidade: UN/1 F1 F4



TINTA TECIDO 37ML 560 AZUL CARIBE

Código: 44859 Fábrica: ACRILEX Unidade: UN/1 F1 F4



TINTA TECIDO 37ML 565 VINHO

Código: 44954 Fábrica: ACRILEX Unidade: UN/1 F1 F4



TINTA TECIDO 37ML 566 PESSEGO

Código: 44957 Fábrica: ACRILEX Unidade: UN/1 F1 F4



TINTA TECIDO 37ML 567 ROSA CHA

Código: 44904 Fábrica: ACRILEX Unidade: UN/1 F1 F4



TINTA TECIDO 37ML 568 AZUL CERULEO

Código: 44858 Fábrica: ACRILEX Unidade: UN/1 F1 F4



TINTA TECIDO 37ML 569 CARAMELO

Código: 45002 Fábrica: ACRILEX Unidade: UN/1 F1 F4



TINTA TECIDO 37ML 570 VERDE PISTA

Código: 44936 Fábrica: ACRILEX Unidade: UN/1 F1 F4



TINTA TECIDO 37ML 572 VERDE ABACATE

Código: 44932 Fábrica: ACRILEX Unidade: UN/1 F1 F4



TINTA TECIDO 37ML 573 OCRE OURO

Código: 44899 Fábrica: ACRILEX Unidade: UN/1 F1 F4



TINTA TECIDO 37ML 574 CINZA LUNAR

Código: 44867 Fábrica: ACRILEX Unidade: UN/1 F1 F4



TINTA TECIDO 37ML 576 CENOURA

Código: 44949 Fábrica: ACRILEX Unidade: UN/1 F1 F4



TINTA TECIDO 37ML 577 TURQUESA

Código: 44863 Fábrica: ACRILEX Unidade: UN/1 F1 F4



TINTA TECIDO 37ML 579 AZUL HORTENSIA

Código: 44857 Fábrica: ACRILEX Unidade: UN/1 F1 F4



TINTA TECIDO 37ML 581 ROSA CICLAME

Código: 44968 Fábrica: ACRILEX Unidade: UN/1 F1 F4



TINTA TECIDO 37ML 582 VERDE GRAMA
 Código: 44929 Fábrica: ACRILEX Unidade: UN/1
 F1 F4



TINTA TECIDO 37ML 583 VERMELHO TOMATE
 Código: 44960 Fábrica: ACRILEX Unidade: UN/1
 F1 F4



TINTA TECIDO 37ML 584 AZUL INVERNO
 Código: 44855 Fábrica: ACRILEX Unidade: UN/1
 F1 F4



TINTA TECIDO 37ML 586 CORAL
 Código: 44956 Fábrica: ACRILEX Unidade: UN/1
 F1 F4



TINTA TECIDO 37ML 587 LAVANDA
 Código: 44890 Fábrica: ACRILEX Unidade: UN/1
 F1 F4



TINTA TECIDO 37ML 588 VERMELHO QU
 Código: 44969 Fábrica: ACRILEX Unidade: UN/1
 F1 F4



TINTA TECIDO 37ML 589 AMARELO CANARIO
 Código: 44894 Fábrica: ACRILEX Unidade: UN/1
 F1 F4



TINTA TECIDO 37ML 593 MOSTARDA
 Código: 44872 Fábrica: ACRILEX Unidade: UN/1
 F1 F4



TINTA TECIDO 37ML 594 VERDE SECO
 Código: 44928 Fábrica: ACRILEX Unidade: UN/1
 F1 F4



TINTA TECIDO 37ML 596 AZUL PETROLEO
 Código: 44860 Fábrica: ACRILEX Unidade: UN/1
 F1 F4



TINTA TECIDO 37ML 627 CINZA CLARO
 Código: 44950 Fábrica: ACRILEX Unidade: UN/1
 F1 F4



TINTA TECIDO 37ML 629 CINZA ONIX
 Código: 44866 Fábrica: ACRILEX Unidade: UN/1
 F1 F4



TINTA TECIDO 37ML 630 VERDE MAR
 Código: 44922 Fábrica: ACRILEX Unidade: UN/1
 F1 F4



TINTA TECIDO 37ML 631 PAPAYA
 Código: 44884 Fábrica: ACRILEX Unidade: UN/1
 F1 F4



TINTA TECIDO 37ML 632 VERMELHO PROFUNDO
 Código: 44921 Fábrica: ACRILEX Unidade: UN/1
 F1 F4



TINTA TECIDO 37ML 633 LILAS SECO
 Código: 44887 Fábrica: ACRILEX Unidade: UN/1
 F1 F4



TINTA TECIDO 37ML 634 ROSTINHO BONECA
 Código: 44908 Fábrica: ACRILEX Unidade: UN/1
 F1 F4



TINTA TECIDO 37ML 635 ROSA CANDY
 Código: 44900 Fábrica: ACRILEX Unidade: UN/1
 F1 F4



TINTA TECIDO 37ML 636 ROSA INGLES
 Código: 44902 Fábrica: ACRILEX Unidade: UN/1
 F1 F4



TINTA TECIDO 37ML 638 FLOR MALV
 Código: 44889 Fábrica: ACRILEX Unidade: UN/1
 F1 F4



TINTA TECIDO 37ML 639 MAUVE
 Código: 44879 Fábrica: ACRILEX Unidade: UN/1
 F1 F4



TINTA TECIDO 37ML 640 PITAYA
 Código: 44911 Fábrica: ACRILEX Unidade: UN/1
 F1 F4



TINTA TECIDO 37ML 643 TIJOLO
 Código: 45001 Fábrica: ACRILEX Unidade: UN/1
 F1 F4



TINTA TECIDO 37ML 800 VERMELHO BEBE
 Código: 44914 Fábrica: ACRILEX Unidade: UN/1
 F1 F4



TINTA TECIDO 37ML 801 VERMELHO TANGERIN
 Código: 44919 Fábrica: ACRILEX Unidade: UN/1
 F1 F4



TINTA TECIDO 37ML 802 VERDE MACA
 Código: 44925 Fábrica: ACRILEX Unidade: UN/1
 F1 F4



TINTA TECIDO 37ML 803 ACQUA MARINA
 Código: 44943 Fábrica: ACRILEX Unidade: UN/1
 F1 F4



TINTA TECIDO 37ML 804 FUCHSIA
 Código: 44876 Fábrica: ACRILEX Unidade: UN/1
 F1 F4



TINTA TECIDO 37ML 805 VERMELHO GOIABA Q
 Código: 44918 Fábrica: ACRILEX Unidade: UN/1
 F1 F4



TINTA TECIDO 37ML 807 JACARANDA
 Código: 44953 Fábrica: ACRILEX Unidade: UN/1
 F1 F4



TINTA TECIDO 37ML 808 AMARELO BEBE
 Código: 44892 Fábrica: ACRILEX Unidade: UN/1
 F1 F4



TINTA TECIDO 37ML 809 LILAS
 Código: 44938 Fábrica: ACRILEX Unidade: UN/1
 F1 F4



TINTA TECIDO 37ML 810 VERDE BEBE

Código: 44926
 Fábrica: ACRILEX
 Unidade: UN/1
 F1 F4



TINTA TECIDO 37ML 811 AZUL BEBE

Código: 44861
 Fábrica: ACRILEX
 Unidade: UN/1
 F1 F4



TINTA TECIDO 37ML 812 SALMAO BEBE

Código: 44945
 Fábrica: ACRILEX
 Unidade: UN/1
 F1 F4



TINTA TECIDO 37ML 813 ROSA BEBE

Código: 44966
 Fábrica: ACRILEX
 Unidade: UN/1
 F1 F4



TINTA TECIDO 37ML 814 CHOCOLATE

Código: 44941
 Fábrica: ACRILEX
 Unidade: UN/1
 F1 F4



TINTA TECIDO 37ML 815 CASTANHO

Código: 44878
 Fábrica: ACRILEX
 Unidade: UN/1
 F1 F4



TINTA TECIDO 37ML 817 AREIA

Código: 44877
 Fábrica: ACRILEX
 Unidade: UN/1
 F1 F4



TINTA TECIDO 37ML 822 VERDE COUNTRY

Código: 44923
 Fábrica: ACRILEX
 Unidade: UN/1
 F1 F4



TINTA TECIDO 37ML 825 AZUL COUNTRY

Código: 44862
 Fábrica: ACRILEX
 Unidade: UN/1
 F1 F4



TINTA TECIDO 37ML 828 ROSA ANTIGO

Código: 44905
 Fábrica: ACRILEX
 Unidade: UN/1
 F1 F4



TINTA TECIDO 37ML 829 FLAMINGO

Código: 44909
 Fábrica: ACRILEX
 Unidade: UN/1
 F1 F4



TINTA TECIDO 37ML 833 AMARELO GEMA

Código: 44897
 Fábrica: ACRILEX
 Unidade: UN/1
 F1 F4



TINTA TECIDO 37ML 834 PALHA

Código: 44951
 Fábrica: ACRILEX
 Unidade: UN/1
 F1 F4



TINTA TECIDO 37ML 860 VERDE PANTANO

Código: 44924
 Fábrica: ACRILEX
 Unidade: UN/1
 F1 F4



TINTA TECIDO 37ML 895 MELAO

Código: 44873
 Fábrica: ACRILEX
 Unidade: UN/1
 F1 F4



TINTA TECIDO 37ML 896 RUSTICO

Código: 44871
 Fábrica: ACRILEX
 Unidade: UN/1
 F1 F4



TINTA TECIDO 37ML 897 VERDE SOFT

Código: 44927
 Fábrica: ACRILEX
 Unidade: UN/1
 F1 F4



TINTA TECIDO 37ML 909 TUTTI FRUTTI

Código: 44907
 Fábrica: ACRILEX
 Unidade: UN/1
 F1 F4



TINTA TECIDO 37ML 926 VERDE MUSGO

Código: 44970
 Fábrica: ACRILEX
 Unidade: UN/1
 F1 F4



TINTA TECIDO 37ML 932 TELHA

Código: 44959
 Fábrica: ACRILEX
 Unidade: UN/1
 F1 F4



TINTA TECIDO 37ML 933 CINZA

Código: 44868
 Fábrica: ACRILEX
 Unidade: UN/1
 F1 F4



TINTA TECIDO 37ML 953 MARRON

Código: 44883
 Fábrica: ACRILEX
 Unidade: UN/1
 F1 F4



TINTA TECIDO 37ML 984 VERMELHO NATAL

Código: 44916
 Fábrica: ACRILEX
 Unidade: UN/1
 F1 F4



TINTA TECIDO 37ML 985 VERDE KIWI

Código: 44962
 Fábrica: ACRILEX
 Unidade: UN/1
 F1 F4



TINTA TECIDO 37ML 986 CAQUI

Código: 44948
 Fábrica: ACRILEX
 Unidade: UN/1
 F1 F4



TINTA TECIDO 37ML 988 ROSE

Código: 44946
 Fábrica: ACRILEX
 Unidade: UN/1
 F1 F4



TINTA TECIDO 37ML 989 ERVA DOCE

Código: 44955
 Fábrica: ACRILEX
 Unidade: UN/1
 F1 F4



TINTA TECIDO 37ML 990 MENTA

Código: 44967
 Fábrica: ACRILEX
 Unidade: UN/1
 F1 F4



TINTA TECIDO 37ML 992 AZUL SOFT

Código: 44864
 Fábrica: ACRILEX
 Unidade: UN/1
 F1 F4



TINTA TECIDO 37ML 993 AZUL ARDOSIA

Código: 44939
 Fábrica: ACRILEX
 Unidade: UN/1
 F1 F4



TINTA TECIDO 37ML 994 CINZA CHUMBO

Código: 44944
 Fábrica: ACRILEX
 Unidade: UN/1
 F1 F4



TINTA TECIDO 37ML 995 UVA

Código: 44875
 Fábrica: ACRILEX
 Unidade: UN/1
 F1 F4



TINTA TECIDO 37ML 996 BERINJELA
 Código: 44963
 Fábrica: ACRILEX
 Unidade: UN/1
 F1 F4



TINTA TECIDO 37ML 997 JATOBA
 Código: 44881
 Fábrica: ACRILEX
 Unidade: UN/1
 F1 F4



TINTA TECIDO 37ML 998 AMORA
 Código: 44886
 Fábrica: ACRILEX
 Unidade: UN/1
 F1 F4



TINTA TECIDO 250ML AMARELO SOL
 Código: 48623
 Fábrica: TEK BOND
 Unidade: UN/1
 F1 F4



TINTA TECIDO 250ML AZUL ROYAL
 Código: 48621
 Fábrica: TEK BOND
 Unidade: UN/1
 F1 F4



TINTA TECIDO 250ML BRANCO
 Código: 48619
 Fábrica: TEK BOND
 Unidade: UN/1
 F1 F4



TINTA TECIDO 250ML LILAS
 Código: 48625
 Fábrica: TEK BOND
 Unidade: UN/1
 F1 F4



TINTA TECIDO 250ML MARROM
 Código: 48624
 Fábrica: TEK BOND
 Unidade: UN/1
 F1 F4



TINTA TECIDO 250ML PINK
 Código: 48626
 Fábrica: TEK BOND
 Unidade: UN/1
 F1 F4



TINTA TECIDO 250ML PRETO
 Código: 48620
 Fábrica: TEK BOND
 Unidade: UN/1
 F1 F4



TINTA TECIDO 250ML ROXO
 Código: 48627
 Fábrica: TEK BOND
 Unidade: UN/1
 F1 F4



TINTA TECIDO 250ML VERDE FLORESTA
 Código: 48628
 Fábrica: TEK BOND
 Unidade: UN/1
 F1 F4



TINTA TECIDO 250ML VERMELHO
 Código: 48622
 Fábrica: TEK BOND
 Unidade: UN/1
 F1 F4



TINTA TECIDO 250ML 501 AZUL TURQUESA
 Código: 45004
 Fábrica: ACRILEX
 Unidade: UN/1
 F1 F4



TINTA TECIDO 250ML 503 AZUL CELESTE
 Código: 45005
 Fábrica: ACRILEX
 Unidade: UN/1
 F1 F4



TINTA TECIDO 250ML 505 AMARELO OURO
 Código: 45006
 Fábrica: ACRILEX
 Unidade: UN/1
 F1 F4



TINTA TECIDO 250ML 507 VERMELHO FOGO

Código: 45007
 Fábrica: ACRILEX
 Unidade: UN/1
 F1 F4



TINTA TECIDO 250ML 510 VERDE FOLHA

Código: 50959
 Fábrica: ACRILEX
 Unidade: UN/1
 F1 F4



TINTA TECIDO 250ML 511 VERDE BANDEIRA

Código: 45008
 Fábrica: ACRILEX
 Unidade: UN/1
 F1 F4



TINTA TECIDO 250ML 516 VIOLETA

Código: 45009
 Fábrica: ACRILEX
 Unidade: UN/1
 F1 F4



TINTA TECIDO 250ML 517 LARANJA

Código: 45010
 Fábrica: ACRILEX
 Unidade: UN/1
 F1 F4



TINTA TECIDO 250ML 519 BRANCO

Código: 45003
 Fábrica: ACRILEX
 Unidade: UN/1
 F1 F4



TINTA TECIDO 250ML 520 PRETO

Código: 45011
 Fábrica: ACRILEX
 Unidade: UN/1
 F1 F4



TINTA TECIDO 250ML 528 LILAS

Código: 47455
 Fábrica: ACRILEX
 Unidade: UN/1
 F1 F4



TINTA TECIDO 250ML 529 MARFIM

Código: 47459
 Fábrica: ACRILEX
 Unidade: UN/1
 F1 F4



TINTA TECIDO 250ML 531 MARRON

Código: 45012
 Fábrica: ACRILEX
 Unidade: UN/1
 F1 F4



TINTA TECIDO 250ML 537 ROSA

Código: 45013
 Fábrica: ACRILEX
 Unidade: UN/1
 F1 F4



TINTA TECIDO 250ML 538 AMARELO PES

Código: 45036
 Fábrica: ACRILEX
 Unidade: UN/1
 F1 F4



TINTA TECIDO 250ML 541 VERMELHO

Código: 51224
 Fábrica: ACRILEX
 Unidade: UN/1
 F1 F4



TINTA TECIDO 250ML 546 VERDE PINHEIRO

Código: 47457
 Fábrica: ACRILEX
 Unidade: UN/1
 F1 F4



TINTA TECIDO 250ML 584 AZUL INVERNO

Código: 47454
 Fábrica: ACRILEX
 Unidade: UN/1
 F1 F4



TINTA TECIDO 250ML 586 CORAL

Código: 47460
 Fábrica: ACRILEX
 Unidade: UN/1
 F1 F4

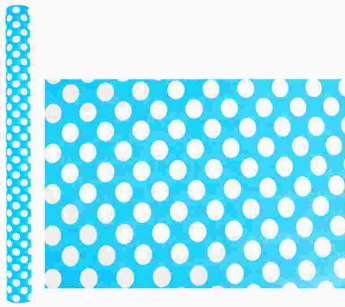

TNT 50 MTS EST 1,40 MTSX40GRS CHAPADO A
 Código: 45180 Fábrica: SUPPER Unidade: RL/1
 F1 F4



TNT 50 MTS EST 1,40 MTSX40GRS FORMATURA
 Código: 45170 Fábrica: SUPPER Unidade: RL/1
 F1 F4

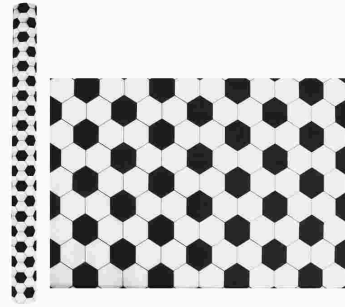

TNT 50 MTS EST 1,40 MTSX40GRS G FUTEBOL
 Código: 45171 Fábrica: SUPPER Unidade: RL/1
 F1 F4



TNT 50 MTS EST 1,40 MTSX40GRS POA VERM
 Código: 45175 Fábrica: SUPPER Unidade: RL/1
 F1 F4



TNT 50 MTS EST 1,40 MTSX40GRS TEIAS
 Código: 45177 Fábrica: SUPPER Unidade: RL/1
 F1 F4



TNT 50 MTS 1,40 MTSX40GRS AMARELO
 Código: 41620 Fábrica: SANTA FE Unidade: RL/50
 F1 F4

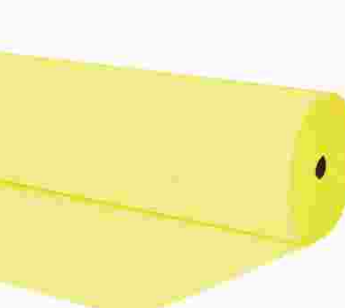

TNT 50 MTS 1,40 MTSX40GRS AMARELO CLARO
 Código: 27307 Fábrica: SANTA FE Unidade: RL/50
 F1 F4



TNT 50 MTS 1,40 MTSX40GRS AMARELO PADRA
 Código: 39810 Fábrica: SANTA FE Unidade: RL/50
 F1 F4



TNT 50 MTS 1,40 MTSX40GRS AZUL ANIL
 Código: 30056 Fábrica: SANTA FE Unidade: RL/50
 F1 F4



TNT 50 MTS 1,40 MTSX40GRS AZUL CELESTE
 Código: 30058 Fábrica: SANTA FE Unidade: RL/50
 F1 F4



TNT 50 MTS 1,40 MTSX40GRS AZUL CLARO
 Código: 41622 Fábrica: GATE 72 Unidade: RL/50
 F1 F4



TNT 50 MTS 1,40 MTSX40GRS AZUL IBIZA
 Código: 39807 Fábrica: SANTA FE Unidade: RL/50
 F1 F4



TNT 50 MTS 1,40 MTSX40GRS AZUL MARINHO
 Código: 33716 Fábrica: SANTA FE Unidade: RL/50
 F1 F4



TNT 50 MTS 1,40 MTSX40GRS AZUL OCEANO
 Código: 39819 Fábrica: SANTA FE Unidade: RL/50
 F1 F4



TNT 50 MTS 1,40 MTSX40GRS AZUL PADRAO
 Código: 39808 Fábrica: SANTA FE Unidade: RL/50
 F1 F4



TNT 50 MTS 1,40 MTSX40GRS AZUL ROYAL
 Código: 27309 Fábrica: SANTA FE Unidade: RL/50
 F1 F4



TNT 50 MTS 1,40 MTSX40GRS BEGE CLARO
 Código: 39811 Fábrica: SANTA FE Unidade: RL/50
 F1 F4



TNT 50 MTS 1,40 MTSX40GRS BEGE PADRAO
 Código: 39812 Fábrica: SANTA FE Unidade: RL/50
 F1 F4



TNT 50 MTS 1,40 MTSX40GRS BRANCO
 Código: 27306 Fábrica: SANTA FE Unidade: RL/50
 F1 F4

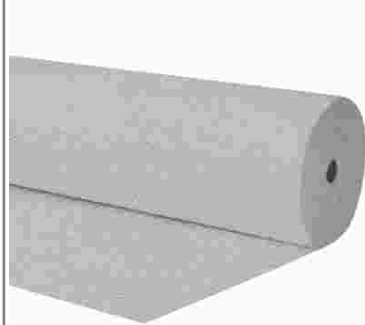

TNT 50 MTS 1,40 MTSX40GRS CINZA
 Código: 33175 Fábrica: SANTA FE Unidade: RL/50
 F1 F4



TNT 50 MTS 1,40 MTSX40GRS CINZA ESC
 Código: 39806 Fábrica: SANTA FE Unidade: RL/50
 F1 F4



TNT 50 MTS 1,40 MTSX40GRS GOIABA
 Código: 39817 Fábrica: SANTA FE Unidade: RL/50
 F1 F4



TNT 50 MTS 1,40 MTSX40GRS LARANJA
 Código: 27312 Fábrica: SANTA FE Unidade: RL/50
 F1 F4



TNT 50 MTS 1,40 MTSX40GRS LILAS
 Código: 27308 Fábrica: SANTA FE Unidade: RL/50
 F1 F4



TNT 50 MTS 1,40 MTSX40GRS MARROM
 Código: 27311 Fábrica: SANTA FE Unidade: RL/50
 F1 F4



TNT 50 MTS 1,40 MTSX40GRS PALHA PADRAO
 Código: 39813 Fábrica: SANTA FE Unidade: RL/50
 F1 F4



TNT 50 MTS 1,40 MTSX40GRS PRETO
 Código: 27304 Fábrica: SANTA FE Unidade: RL/50
 F1 F4



TNT 50 MTS 1,40 MTSX40GRS ROSA
 Código: 27314 Fábrica: SANTA FE Unidade: RL/50
 F1 F4



TNT 50 MTS 1,40 MTSX40GRS ROSA BB
 Código: 41621 Fábrica: GATE 72 Unidade: RL/50
 F1 F4



TNT 50 MTS 1,40 MTSX40GRS ROSA PADRAO
 Código: 39809 Fábrica: SANTA FE Unidade: RL/50
 F1 F4



TNT 50 MTS 1,40 MTSX40GRS ROSA PINK
 Código: 33174 Fábrica: SANTA FE Unidade: RL/50
 F1 F4



TNT 50 MTS 1,40 MTSX40GRS SALMAO
 Código: 39816 Fábrica: SANTA FE Unidade: RL/50
 F1 F4



TNT 50 MTS 1,40 MTSX40GRS VERDE
 Código: 27310 Fábrica: SANTA FE Unidade: RL/50
 F1 F4



TNT 50 MTS 1,40 MTSX40GRS VERDE BILHAR
 Código: 39815 Fábrica: SANTA FE Unidade: RL/50
 F1 F4

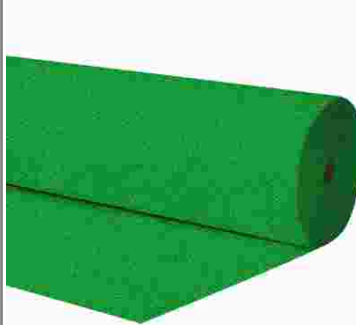

TNT 50 MTS 1,40 MTSX40GRS VERDE CLARO
 Código: 30057 Fábrica: SANTA FE Unidade: RL/50
 F1 F4



TNT 50 MTS 1,40 MTSX40GRS VERDE LIMAO
 Código: 30054 Fábrica: SANTA FE Unidade: RL/50
 F1 F4



TNT 50 MTS 1,40 MTSX40GRS VERDE MUSGO
 Código: 39814 Fábrica: SANTA FE Unidade: RL/50
 F1 F4



TNT 50 MTS 1,40 MTSX40GRS VERMELHO
 Código: 27313 Fábrica: SANTA FE Unidade: RL/50
 F1 F4



TNT 50 MTS 1,40 MTSX40GRS VINHO
 Código: 39805 Fábrica: SANTA FE Unidade: RL/50
 F1 F4



TNT 50 MTS 1,40 MTSX40GRS VIOLETA
 Código: 39818 Fábrica: SANTA FE Unidade: RL/50
 F1 F4



TNT EST LAM 50MTX1,40 MTX40GRS XADR AZUL
 Código: 42725 Fábrica: SANTA FE Unidade: RL/1
 F1 F4



TNT EST LAM 50MTX1,40 MTX40GRS XADR PTO
 Código: 42726 Fábrica: SANTA FE Unidade: RL/1
 F1 F4



TNT EST LAM 50MTX1,40 MTX40GRS XADR VERD
 Código: 42723 Fábrica: SANTA FE Unidade: RL/1
 F1 F4



TNT EST LAM 50MTX1,40 MTX40GRS XADR VERM
 Código: 42724 Fábrica: SANTA FE Unidade: RL/1
 F1 F4

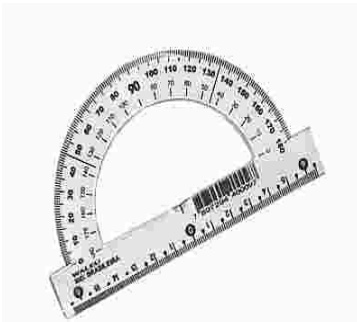

TRANSFERIDOR CHANFRADO 180 GRAUS 10X1
 Código: 14481 Fábrica: WALEU Unidade: PT/10
 F1 F4



TRANSFERIDOR CHANFRADO 360 GRAUS 10X1
 Código: 453 Fábrica: WALEU Unidade: PT/10
 F1 F4

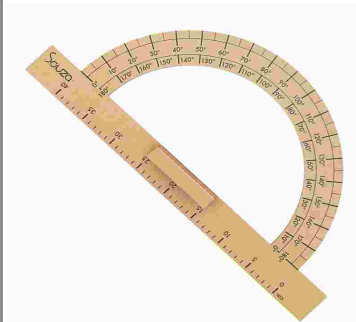

TRANSFERIDOR MDF 180 GRAUS
 Código: 49904 Fábrica: SOUZA Unidade: UN/1
 F1 F4



TRIO DE MESA ACR QUAD CRISTAL 550
 Código: 41962 Fábrica: CARBRINK Unidade: UN/1
 F1 F4



TRIO DE MESA ACR QUAD FUME 551

Código: 41961
Fábrica: CARBRINK
Unidade: UN/1
F1 F4

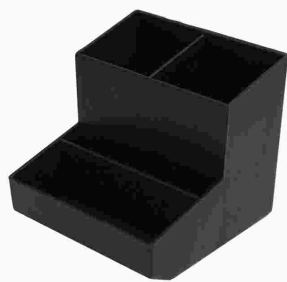

TRIO DE MESA PLAST QUAD PRETO 555

Código: 45413
Fábrica: CARBRINK
Unidade: UN/1
F1 F4



TRIO PORTA CANETAS CLIPS LEMBRETES CRIST

Código: 47592
Fábrica: MAXCRIL
Unidade: UN/1
F1 F4



TRIO PORTA CANETAS CLIPS LEMBRETES FUME

Código: 29763
Fábrica: MAXCRIL
Unidade: UN/1
F1 F4



UMEDecedor MOLHA DEDOS ESPUMA 01

Código: 43328
Fábrica: CARBRINK
Unidade: UN/1
F1 F4



UMIDIFICADOR DEDOS 12 GRS (CREME) 206

Código: 22994
Fábrica: CARBRINK
Unidade: UN/1
F1 F4



VARETA P/PASTA SUSPensa 200UN

Código: 47193
Fábrica: POLYCART
Unidade: PT/200
F1 F4



VERNIZ ACRILICO BRILHANTE 100ML 15010

Código: 41952
Fábrica: ACRILEX
Unidade: UN/1
F1 F4



VERNIZ GERAL 100ML 16010

Código: 45818
Fábrica: ACRILEX
Unidade: UN/1
F1 F4



VERNIZ SPRAY 350ML 250G BRILHANTE

Código: 42228
Fábrica: TEK BOND
Unidade: UN/1
F1 F4



VERNIZ SPRAY 350ML 250G FOSCO

Código: 48648
Fábrica: TEK BOND
Unidade: UN/1
F1 F4



VISOR E ETIQUETA P/PASTA SUSPensa 50X1

Código: 42699
Fábrica: DELUCAS
Unidade: PT/50
F1 F4



ETIQUETA ADESIVA CARTA 42,33 6093 240X1

Código: 48144
Fábrica: PIMACO
Unidade: PT/240
F1 F4