



16 cm

ABRIDOR ALUM LATA BORBOLETA 16CM 3092

Código: 44736 Fábrica: WINCY Unidade: UN/1 F1 F4



ABRIDOR COMBIN INOX LATA/GARR 1004 12X1

Código: 14382 Fábrica: JWC Unidade: DZ/12 F1 F4



ABRIDOR COMBINADO INOX LATA/GARRAFA 147

Código: 44771 Fábrica: NICOBEM Unidade: CT/1 F1 F4



ABRIDOR COMBINADO INOX LATA/GARRAFA 279

Código: 44503 Fábrica: PLANETA Unidade: CT/1 F1 F4



ABRIDOR COMBINADO LATA/GARRAFA 1001 12X1

Código: 1915 Fábrica: JWC Unidade: DZ/12 F1 F4



ABRIDOR COMBINADO+SACA ROLHA CTL 2028

Código: 33288 Fábrica: JWC Unidade: CR/1 F1 F4



ABRIDOR GARRAFA NA CX 1002 12X1

Código: 13925 Fábrica: JWC Unidade: DZ/12 F1 F4



ABRIDOR INOX GARRAFAS GARCON 280 12X1

Código: 48691 Fábrica: PLANETA Unidade: DZ/12 F1 F4



ABRIDOR INOX GARRAFAS GARCON 281 CTL

Código: 48694 Fábrica: PLANETA Unidade: CR/1 F1 F4



ABRIDOR SACA ROLHA CABO PLAST 1006 12X1

Código: 2886 Fábrica: JWC Unidade: DZ/12 F1 F4



ABRIDOR SACA ROLHA INOX MULTIUSOCTL 5385

Código: 43270 Fábrica: MEGAGIFT Unidade: UN/1 F1 F4



ABRIDOR SACA ROLHAS INOX DUPLO EST 12X1

Código: 46585 Fábrica: HERCULES Unidade: CX/12 F1 F4



ADAPTADOR PORTA FILTRO PLAST 5026 UN

Código: 49399 Fábrica: SBRISSA Unidade: UN/1 F1 F4



ADAPTADOR PORTA FILTRO PLAST 5026 20X1

Código: 31283 Fábrica: SBRISSA Unidade: PT/20 F1 F4



ADAPTADOR 1/2 TORNEI/MANG PTO AD51N 50X1

Código: 40147 Fábrica: REBOUCAS Unidade: PT/50 F1 F4



ADAPTADOR 3/4 TORNEI/MANG PTO AD52N 50X1

Código: 40148 Fábrica: REBOUCAS Unidade: PT/50 F1 F4



AFIADOR DE FACA C/VENTOSA PLAST 371

Código: 48689 Fábrica: PLANETA Unidade: UN/1 F1 F4



AGUA SANITARIA MAIS 1 LT

Código: 48940 Fábrica: MAIS Unidade: UN/1 F1 F4



AGULHA P/DESENTUPIR FOGAO CTL 2023 5X1

Código: 33290 Fábrica: JWC Unidade: CR/5 F1 F4



AGULHA P/DESENTUPIR FOGAO 12X1

Código: 7374 Fábrica: ALE Unidade: DZ/12 F1 F4



26 cm

AMASSADOR ALUM INTEIRICO BATATA 2007 UN

Código: 48030 Fábrica: COFAX Unidade: UN/1 F1 F4



AMASSADOR INOX ALHO PRIME 061

Código: 49376 Fábrica: RIOHOME Unidade: UN/1 F1 F4

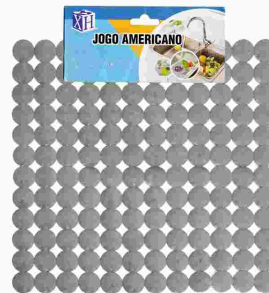

AMERICANO P/MESA 24X24CM TM-2424

Código: 39280 Fábrica: XHADAY Unidade: UN/1 F1 F4

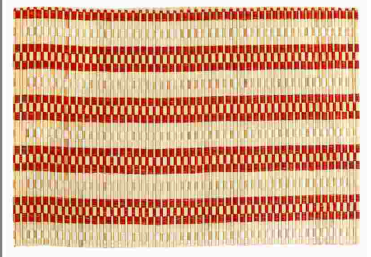

30cm
45 cm

AMERICANO P/MESA 30X45CM 10221

Código: 45882 Fábrica: ALMEGA Unidade: UN/1 F1 F4



AMERICANO P/MESA 35X48CM JOGO 4PCS

Código: 29116 Fábrica: FERREIRA Unidade: PT/4 F1 F4



9 cm

ARCO ALUMINIO N1 P/PLANTA 1011

Código: 37169 Fábrica: PAIOL Unidade: UN/1 F1 F4



10 cm

ARCO ALUMINIO N2 P/PLANTA 3000

Código: 37170 Fábrica: PAIOL Unidade: UN/1 F1 F4



14 cm

ARCO ALUMINIO N3 P/PLANTA 3001

Código: 37172 Fábrica: PAIOL Unidade: UN/1 F1 F4

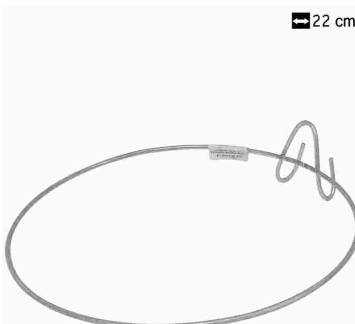

22 cm

ARCO ALUMINIO N5 P/PLANTA 3003

Código: 37173 Fábrica: PAIOL Unidade: UN/1 F1 F4



13 cm

ARRANJO BAMBU QUAD 6X6CM 8058

Código: 40590 Fábrica: PAIOL Unidade: UN/1 F1 F4



14,5 cm

ARRANJO BAMBU RED 5X5CM 8062

Código: 40591 Fábrica: PAIOL Unidade: UN/1 F1 F4



ASSADEIRA ALUM CORACAO 01 1263

Código: 37513 Fábrica: MSR Unidade: UN/1 F1 F4



ASSADEIRA ALUM CORACAO 02 1264

Código: 37254
 Fábrica: MSR
 Unidade: UN/1
 F1 F4



ASSADEIRA ALUM CORACAO 03 1265

Código: 37252
 Fábrica: MSR
 Unidade: UN/1
 F1 F4



ASSADEIRA ALUM FUNDO FALSO 01 648

Código: 35257
 Fábrica: MSR
 Unidade: UN/1
 F1 F4



ASSADEIRA ALUM FUNDO FALSO 02 649

Código: 35258
 Fábrica: MSR
 Unidade: UN/1
 F1 F4



ASSADEIRA ALUM FUNDO FALSO 03 650

Código: 37523
 Fábrica: MSR
 Unidade: UN/1
 F1 F4



ASSADEIRA ALUM OVAL 01 651

Código: 37519
 Fábrica: MSR
 Unidade: UN/1
 F1 F4



ASSADEIRA ALUM OVAL 02 652

Código: 37520
 Fábrica: MSR
 Unidade: UN/1
 F1 F4



ASSADEIRA ALUM OVAL 03 653

Código: 37521
 Fábrica: MSR
 Unidade: UN/1
 F1 F4



ASSADEIRA VIDRO RET KIT 3UN (2,2/1,6/1L)

Código: 47415
 Fábrica: DIAMONDS
 Unidade: CJ/1
 F1 F4



AVENTAL NYLON PP 1,10X63CM PEIXEIRO 32

Código: 49687
 Fábrica: MARIO BRITO
 Unidade: UN/1
 F1 F4



AVENTAL NYLON PP 45X65CM REDONDO LISO 01

Código: 49686
 Fábrica: MARIO BRITO
 Unidade: UN/1
 F1 F4



AVENTAL NYLON 50X70CM C/BOLSO 72901

Código: 49580
 Fábrica: ALMEGA
 Unidade: UN/1
 F1 F4



AVENTAL PVC GDE 56X85CM

Código: 32344
 Fábrica: FERREIRA
 Unidade: UN/1
 F1 F4



AVENTAL PVC MED 50X75CM

Código: 28178
 Fábrica: FERREIRA
 Unidade: UN/1
 F1 F4



AVENTAL PVC 50X70CM C/BOLSO (CANGURU)

Código: 44154
 Fábrica: FERREIRA
 Unidade: UN/1
 F1 F4



BACIA ALUM LEVE 25 1,300 ML

Código: 5906
 Fábrica: AVELAR
 Unidade: UN/1
 F1 F4

 <p>BACIA N23 23 LTSCANELADA PRETO 10080</p> <p>Código: 41441 Fábrica: PLASMARC Unidade: UN/1 F1 F4</p>	<p>8 Lts</p>  <p>BACIA PLAST 2,3 LTS BRANCO</p> <p>Código: 40775 Fábrica: NUTRIPLAN Unidade: UN/1 F1 F4</p>	 <p>BACIA PLAST 3 LTS PRETA 2001</p> <p>Código: 40378 Fábrica: FORMPLAST Unidade: UN/1 F1 F4</p>	<p>9cm 26cm 3,3lts</p>  <p>BACIA PLAST 3,3 LTS TRANSLUCIDA 0524</p> <p>Código: 7495 Fábrica: JAGUAR Unidade: UN/1 F1 F4</p>
 <p>BACIA PLAST 3,5 LTS CANELADA 387</p> <p>Código: 35577 Fábrica: BH PLASTIC Unidade: UN/1 F1 F4</p>	<p>10cm 33cm 6,7lts</p>  <p>BACIA PLAST 6,7 LTS TRANSLUCIDA 0526</p> <p>Código: 8265 Fábrica: JAGUAR Unidade: UN/1 F1 F4</p>	<p>8 Lts</p>  <p>BACIA PLAST 8 LTS BRANCO</p> <p>Código: 40776 Fábrica: NUTRIPLAN Unidade: UN/1 F1 F4</p>	 <p>BACIA PLAST N18 13 LTS CANELAD PRETO 119</p> <p>Código: 41442 Fábrica: PLASMARC Unidade: UN/1 F1 F4</p>
 <p>BACIA PLAST 12 LTS CANELADA 6614</p> <p>Código: 8705 Fábrica: INPLAST Unidade: UN/1 F1 F4</p>	 <p>BACIA PLAST 12,0 LTS CANELADA</p> <p>Código: 30892 Fábrica: BH PLASTIC Unidade: UN/1 F1 F4</p>	<p>13 lts</p>  <p>BACIA PLAST 13 LTS COLLOR 860</p> <p>Código: 39562 Fábrica: LUMAR Unidade: UN/1 F1 F4</p>	<p>14 Lts</p>  <p>BACIA PLAST 14 LTS BRANCO</p> <p>Código: 40777 Fábrica: NUTRIPLAN Unidade: UN/1 F1 F4</p>
 <p>BACIA PLAST 1,5 LTS COLOR</p> <p>Código: 20585 Fábrica: ECOPLASTIC Unidade: UN/1 F1 F4</p>	<p>17cm 41cm 15lts</p>  <p>BACIA PLAST 15 LTS TRANSLUCIDA 0528</p> <p>Código: 7496 Fábrica: JAGUAR Unidade: UN/1 F1 F4</p>	<p>47cm 18lts</p>  <p>BACIA PLAST 18 LTS PRETA 105</p> <p>Código: 40404 Fábrica: FORMPLAST Unidade: UN/1 F1 F4</p>	 <p>BACIA PLAST 2 LTS CANELADA PRETA 6304</p> <p>Código: 41493 Fábrica: KOZI PLAST Unidade: UN/1 F1 F4</p>



BACIA PLAST 2,4 LTS 71493

Código: **31295** Fábrica: **Y888** Unidade: **UN/1**
F1 F4



BACIA PLAST 3 LTS CANELADA PRETA 6305

Código: **41474** Fábrica: **KOZI PLAST** Unidade: **UN/1**
F1 F4



BACIA PLAST 3,0 LTS LISA

Código: **17857** Fábrica: **ECOPLASTIC** Unidade: **UN/1**
F1 F4



BACIA PLAST 7 LTS COLOR

Código: **45279** Fábrica: **MOLDE MINAS** Unidade: **UN/1**
F1 F4

15 cm
32 cm
7 lts



BACIA 1,2 LTS CANELADA RECICLADA 6001

Código: **17981** Fábrica: **SBRISSA** Unidade: **UN/1**
F1 F4



BACIA 2,5 LTS CANELADA RECICLADA 6002

Código: **17982** Fábrica: **SBRISSA** Unidade: **UN/1**
F1 F4



BACIA 2,5 LTS CANELADA TRANSPARENTE 4007

Código: **19763** Fábrica: **SBRISSA** Unidade: **UN/1**
F1 F4



BACIA 4,5 LTS CANELADA RECICLADA 6003

Código: **17983** Fábrica: **SBRISSA** Unidade: **UN/1**
F1 F4



BACIA 4,5 LTS CANELADA TRANSPARENTE 4008

Código: **18713** Fábrica: **SBRISSA** Unidade: **UN/1**
F1 F4



BACIAO PLAST 35 LTS CANELADA 719/92

Código: **36696** Fábrica: **LUMAR/PA** Unidade: **UN/1**
F1 F4



BALDE METAL 5 LTS DEC FLAMENGO 1893

Código: **41121** Fábrica: **BRASFOOT** Unidade: **UN/1**
F1 F4



BALDE PLAST 2,5 LTS P/PIPOCA 7008

Código: **31284** Fábrica: **SBRISSA** Unidade: **UN/1**
F1 F4



BALDE PLAST 7,5 LTS C/ALCA METAL 90

Código: **36698** Fábrica: **P A SOUZA** Unidade: **UN/1**
F1 F4

23cm
25cm
7,5lts

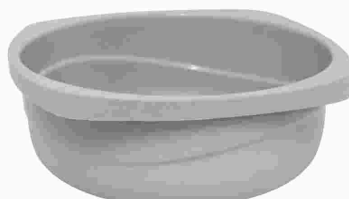

BALDE PLAST 9 LTS CINZA

Código: **40778** Fábrica: **NUTRIPLAN** Unidade: **UN/1**
F1 F4

9 Lts



BALDE PLAST LATA CONCRETO 16 LTS PRETA

Código: **20661** Fábrica: **ECOPLASTIC** Unidade: **UN/1**
F1 F4



BALDE PLAST 12 LTS ELEGANCE PRETO 413

Código: **50005** Fábrica: **PLASMARC** Unidade: **UN/1**
F1 F4



BALDE PLAST 12 LTS PRETO P/CONCRETO 105

Código: **40719** Fábrica: **ECOPLASTIC** Unidade: **UN/1**
F1 F4



BALDE PLAST 1,2LTS PIPOCA COLOR ADE 3105

Código: **50088** Fábrica: **LIDER PLUS** Unidade: **UN/1**
F1 F4



BALDE PLAST 1,2LTS PIPOCA COLOR 3104

Código: **41785** Fábrica: **LIDER PLUS** Unidade: **UN/1**
F1 F4



BALDE PLAST 13 LTS ALCA METAL 6615

Código: **14402** Fábrica: **INPLAST** Unidade: **UN/1**
F1 F4



BALDE PLAST 13 LTS OVAL ALCA PLAST 102

Código: **40717** Fábrica: **PLASMARC** Unidade: **UN/1**
F1 F4



BALDE PLAST 15 LTS PRETO ALCA METAL

Código: **17810** Fábrica: **SHANGRILA** Unidade: **UN/1**
F1 F4

28cm
32cm
15lts



BALDE PLAST 15 LTS 753

Código: **37263** Fábrica: **LUMAR** Unidade: **UN/1**
F1 F4



BALDE PLAST 20 LTS 720

Código: **37262** Fábrica: **LUMAR** Unidade: **UN/1**
F1 F4



13 cm

BALDINHO PLAST P/PIPOCA 1065

Código: **37802** Fábrica: **ENGIPLAST** Unidade: **UN/1**
F1 F4



BANDEJA 15 CELULAS BAIXA 5 F PRETO 2134

Código: **33544** Fábrica: **NUTRIPLAN** Unidade: **UN/1**
F1 F4

07 cm
21 cm
34 cm
02 lts



BANDEJA 30 CELULAS PRETO

Código: **33545** Fábrica: **NUTRIPLAN** Unidade: **UN/1**
F1 F4

09 cm
30 cm
36 cm
03 lts



BANDEJA BAMBU 39X15X1,2CM 114

Código: **47904** Fábrica: **CASITA** Unidade: **UN/1**
F1 F4

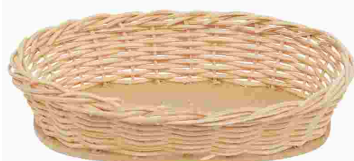

BANDEJA CIPO BRANCO OVAL GDE 8102

Código: **40599** Fábrica: **PAIOL** Unidade: **UN/1**
F1 F4

4,5 cm
30 cm



BANDEJA CIPO BRANCO OVAL PQ 8106

Código: **40595** Fábrica: **PAIOL** Unidade: **UN/1**
F1 F4

4,5 cm
23,5 cm



BANDEJA CIPO BRANCO RED GDE 8101

Código: **40602** Fábrica: **PAIOL** Unidade: **UN/1**
F1 F4

5 cm
22 cm

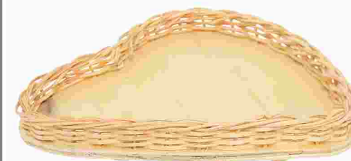

BANDEJA CORCAO CIPO BRANCO N4 8114

Código: **40606** Fábrica: **PAIOL** Unidade: **UN/1**
F1 F4

2,5 cm
21,5 cm

1 2,5 cm
2 25 cm



BANDEJA CORACAO CIPO BRANCO N5 8115

Código: 40607 Fábrica: PAIOL Unidade: UN/1
F1 F4

1 5,5 cm
2 30,5 cm
3 31,5 cm



BANDEJA CORACAO FIO GDE BANANA 6999-2

Código: 39450 Fábrica: PAIOL Unidade: UN/1
F1 F4

1 6 cm
2 29 cm



BANDEJA CORACAO FIO MED ARGILA 7000-1

Código: 37206 Fábrica: PAIOL Unidade: UN/1
F1 F4

1 5,5 cm
2 26 cm
3 26 cm



BANDEJA CORACAO FIO MED BANANA 7000-2

Código: 39451 Fábrica: PAIOL Unidade: UN/1
F1 F4

1 6 cm
2 22 cm



BANDEJA CORACAO FIO PEQ ARGILA 7001-1

Código: 37207 Fábrica: PAIOL Unidade: UN/1
F1 F4

1 5,5 cm
2 21 cm
3 21 cm



BANDEJA CORACAO FIO PEQ BANANA 7001-2

Código: 39452 Fábrica: PAIOL Unidade: UN/1
F1 F4



BANDEJA CORACAO PINUS ENVELHEC GDE 3103

Código: 41749 Fábrica: PAIOL Unidade: UN/1
F1 F4



BANDEJA CORACAO PINUS ENVELHEC MED 3104

Código: 40845 Fábrica: PAIOL Unidade: UN/1
F1 F4

1 6 cm
2 35 cm



BANDEJA CORACAO PINUS ENVELHEC PEQ 3105

Código: 41750 Fábrica: PAIOL Unidade: UN/1
F1 F4



BANDEJA FIO GDE 8013

Código: 37196 Fábrica: PAIOL Unidade: UN/1
F1 F4

1 6 cm
2 28 cm



BANDEJA FIO MED 8014

Código: 37197 Fábrica: PAIOL Unidade: UN/1
F1 F4

1 6 cm
2 24 cm

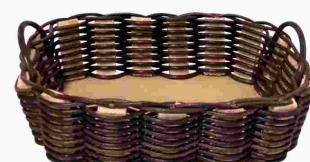

BANDEJA FIO PEQ 8015

Código: 37198 Fábrica: PAIOL Unidade: UN/1
F1 F4

1 7,5 cm
2 42 cm

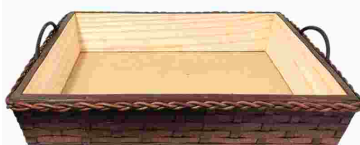

BANDEJA FITA GDE 8010

Código: 37193 Fábrica: PAIOL Unidade: UN/1
F1 F4

22 cm



BANDEJA INOX OVAL 22CM 800-17

Código: 40529 Fábrica: CASA ONZE Unidade: UN/1
F1 F4

25 cm



BANDEJA INOX OVAL 25CM 800-18

Código: 40532 Fábrica: CASA ONZE Unidade: UN/1
F1 F4

35 cm



BANDEJA INOX RED EMBORRACHAD 35CM 180205

Código: 39227 Fábrica: SATYAM Unidade: UN/1
F1 F4

40 cm



BANDEJA INOX RED EMBORRACHAD 40CM 180206
 Código: 39228 Fábrica: SATYAM Unidade: UN/1
 F1 F4

7 cm
40 cm



BANDEJA PINUS GDE 8016
 Código: 37199 Fábrica: PAIOL Unidade: UN/1
 F1 F4

10 cm
35 cm



BANDEJA PINUS MED 8017
 Código: 37200 Fábrica: PAIOL Unidade: UN/1
 F1 F4

9,5 cm
28 cm



BANDEJA PINUS PEQ 8018
 Código: 37201 Fábrica: PAIOL Unidade: UN/1
 F1 F4

5,5 cm
30 cm
18 cm



BANDEJA PLAST MULTI USO 1,5L 17X31CM 731
 Código: 44083 Fábrica: QUALYPLAS Unidade: UN/1
 F1 F4

65 cm

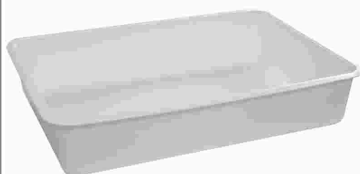

BANDEJA PLAST N5 BCA 26LTS 584
 Código: 37781 Fábrica: TRITEC Unidade: UN/1
 F1 F4

44cm
32cm

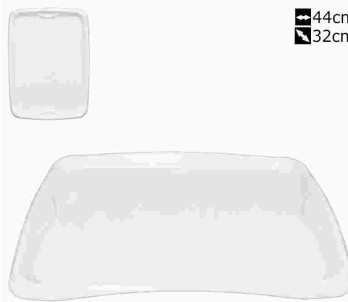

BANDEJA PLAST 32,5X43,5CM MULTI USO 1562
 Código: 47063 Fábrica: JAGUAR Unidade: UN/1
 F1 F4

9,5 cm
26 cm



BANDEJA TEXTURA PEQ 8009
 Código: 37192 Fábrica: PAIOL Unidade: UN/1
 F1 F4

104 cm
27 cm
53 cm
2,5 lts



BANDEJA 128 CELULAS FINA PRETO
 Código: 38916 Fábrica: NUTRIPLAN Unidade: UN/1
 F1 F4



BANDEJA 200 CELULAS F08 FINA PRETO
 Código: 33543 Fábrica: NUTRIPLAN Unidade: UN/1
 F1 F4

80cm
23lts



BANHEIRA INF TRANSP 23 LTS ROSA 7741
 Código: 6191 Fábrica: JAGUAR Unidade: UN/1
 F1 F4



BANQUETA ARAXA BRANCA
 Código: 21134 Fábrica: ANTARES Unidade: UN/1
 F1 F4



BANQUETA ARAXA PRETA
 Código: 25105 Fábrica: ANTARES Unidade: UN/1
 F1 F4



BANQUETA PLAST CARIBE PRETA 944
 Código: 42760 Fábrica: LUMAR Unidade: UN/1
 F1 F4



BANQUETA PLAST PRETA 8000
 Código: 40410 Fábrica: FORMPLAST Unidade: UN/1
 F1 F4

24,5 cm
40 cm
31,5 cm



BAU SINTETICO N3 40X30X24CM 8079
 Código: 40332 Fábrica: PAIOL Unidade: UN/1
 F1 F4



BEBEDOURO AMARELO P/BEIJA FLOR 280ML

Código: **27121** Fábrica: **NUTRIPLAN** Unidade: **UN/1**
F1 F4



BEBEDOURO LARANJA P/BEIJA FLOR 280ML

Código: **18504** Fábrica: **NUTRIPLAN** Unidade: **UN/1**
F1 F4



BICO ADAPTADOR AJUST P/TORNEIRA CTL 5364

Código: **43272** Fábrica: **MEGAGIFT** Unidade: **CT/1**
F1 F4



BICO AREJADOR P/TORNEIRA 1021 12X1

Código: **50826** Fábrica: **JWC** Unidade: **DZ/1**
F1 F4



BICO AREJADOR P/TORNEIRA 23453

Código: **45881** Fábrica: **ALMEGA** Unidade: **UN/1**
F1 F4



BICO CONEXAO P/TORNEIRA C/ANEL VEDA 390

Código: **49739** Fábrica: **NOVA MARCA** Unidade: **UN/1**
F1 F4



10 cm



BICO METAL MANGUEIRA 10CM CTL 37-20

Código: **44774** Fábrica: **NICOBEM** Unidade: **UN/1**
F1 F4



BICO PLAST REGADOR PRETO 9754

Código: **50963** Fábrica: **ARBRA** Unidade: **UN/1**
F1 F4



BICO P/TORNEIRA JARDIM B151N 12X1

Código: **33737** Fábrica: **REBOUCAS** Unidade: **PT/12**
F1 F4



BICO P/TORNEIRA TANQUE PIA B152N 12X1

Código: **33736** Fábrica: **REBOUCAS** Unidade: **PT/12**
F1 F4



BISNAGA PLAST 200 ML KATCHUP 394

Código: **36229** Fábrica: **TRITEC** Unidade: **UN/1**
F1 F4

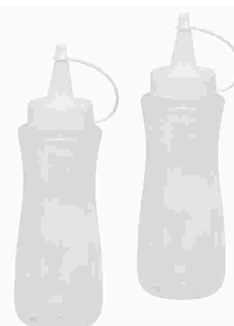

BISNAGA PLAST 200 ML MAIONESE 396

Código: **35945** Fábrica: **TRITEC** Unidade: **UN/1**
F1 F4



BISNAGA PLAST 200 ML MOSTARDA 395

Código: **36230** Fábrica: **TRITEC** Unidade: **UN/1**
F1 F4



BISNAGA PLAST 250 ML KATCHUP 106/422

Código: **44080** Fábrica: **QUALYPLAS** Unidade: **UN/1**
F1 F4



BISNAGA PLAST 250 ML MAIONESE 421/105

Código: **44079** Fábrica: **QUALYPLAS** Unidade: **UN/1**
F1 F4



BISNAGA PLAST 250 ML MOSTARDA 104/420

Código: **44081** Fábrica: **QUALYPLAS** Unidade: **UN/1**
F1 F4



BOLEIRA PLAST 26,5X25X10,5CM FACILIT 450
 Código: 45189 Fábrica: RISCHIOTO Unidade: UN/1
 F1 F4



BOLSA TERMICA POLIESTER 24X22X14CM 0066
 Código: 43685 Fábrica: MORMAII Unidade: UN/1
 F1 F4



BOLSA TERMICA POLIESTER 24X22X14CM 0069
 Código: 43680 Fábrica: MORMAII Unidade: UN/1
 F1 F4



BOLSA TERMICA RET 9 LTS
 Código: 30864 Fábrica: ANTARES Unidade: UN/1
 F1 F4



BOLSA TERMICA RET 12 LTS TIRA COLO
 Código: 30868 Fábrica: ANTARES Unidade: UN/1
 F1 F4



BOLSA TERMICA RET 15 LTS
 Código: 30865 Fábrica: ANTARES Unidade: UN/1
 F1 F4



BOMBA MANUAL P/GALAO DE AGUA 16,5CM 861
 Código: 26874 Fábrica: HAI BRASIL Unidade: UN/1
 F1 F4



BOMBONIERE PLAST 10X11CM 15082
 Código: 46247 Fábrica: CASITA Unidade: CX/1
 F1 F4



BOMBONIERE VIDRO GDE 750
 Código: 47361 Fábrica: ALTIHOME Unidade: UN/1
 F1 F4



BOMBONIERE VIDRO 290ML RED 13CM EGITO
 Código: 44781 Fábrica: CITY GLASS Unidade: CX/1
 F1 F4



BORDA P/PRATELEIRA 1M X 6CM 2 2X1 1102
 Código: 11328 Fábrica: PLAST-LEO Unidade: C//2
 F1 F4

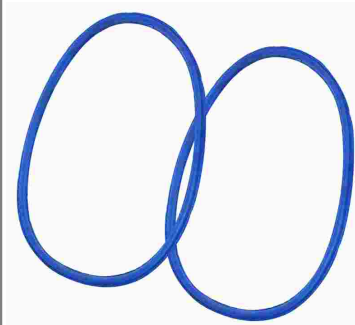

BORRACHA P PRESSAO SILIC 4,5 LTS 12X1
 Código: 28808 Fábrica: ALPHA Unidade: DZ/12
 F1 F4

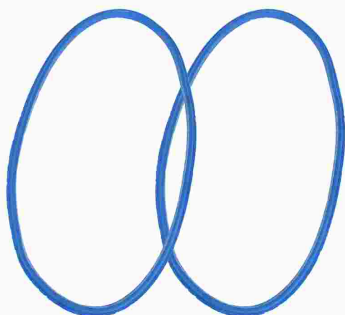

BORRACHA P PRESSAO SILIC 7,0 LTS 12X1
 Código: 29925 Fábrica: ALPHA Unidade: DZ/12
 F1 F4

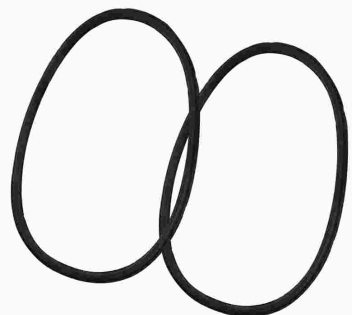

BORRACHA P PRESSAO 4,5 LTS PRETA 12X1
 Código: 37725 Fábrica: ALPHA Unidade: DZ/12
 F1 F4

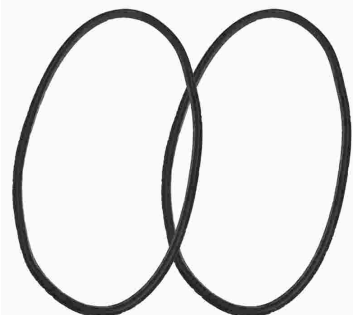

BORRACHA P PRESSAO 7,0 LTS PRETA 12X1
 Código: 37783 Fábrica: ALPHA Unidade: DZ/12
 F1 F4

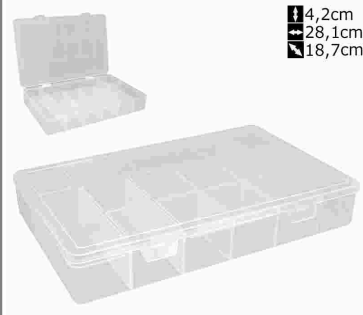

BOX ORGANIZADOR PLAST G C/13 DIV 490
 Código: 44432 Fábrica: USUAL Unidade: UN/1
 F1 F4

4,2cm
 28,1cm
 18,7cm



1 3,5cm
2 15,8cm
3 9,5cm

BOX ORGANIZADOR PLAST P C/7 DIV 488

Código: 44431 Fábrica: USUAL Unidade: UN/1
F1 F4

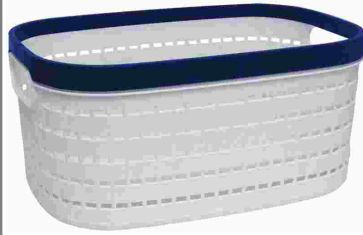

1 14,5 cm
2 37 cm

BOX PRATIC RATTAN TENDENCIAS GDE 2010

Código: 38375 Fábrica: MONTE LIBANO Unidade: UN/1
F1 F4

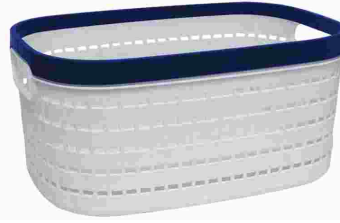

1 13 cm
2 29,5 cm

BOX PRATIC RATTAN TENDENCIAS MED 2005

Código: 38374 Fábrica: MONTE LIBANO Unidade: UN/1
F1 F4

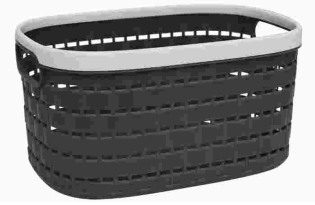

1 12 cm
2 24 cm

BOX PRATIC RATTAN TENDENCIAS PEQ 2000

Código: 38373 Fábrica: MONTE LIBANO Unidade: UN/1
F1 F4



BULE ALUM CB BAQUELITE 02 654

Código: 35270 Fábrica: MSR Unidade: UN/1
F1 F4



BULE ALUM CRAQUEADO CB BAQUELITE 655

Código: 35262 Fábrica: MSR Unidade: UN/1
F1 F4

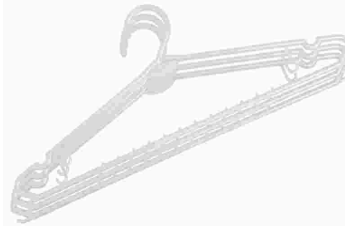

CABIDE ACRIL AD BRANCO 003 3X1

Código: 45751 Fábrica: DCASA Unidade: CJ/3
F1 F4

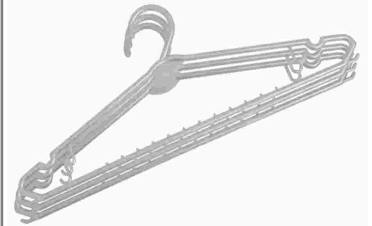

CABIDE ACRIL AD CINZA 002 3X1

Código: 45762 Fábrica: DCASA Unidade: CJ/3
F1 F4



CABIDE ACRIL AD COBRE 008 3X1

Código: 45753 Fábrica: DCASA Unidade: CJ/3
F1 F4

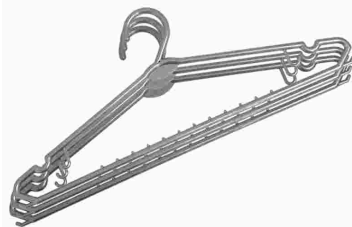

CABIDE ACRIL AD PLATINA 009 3X1

Código: 45752 Fábrica: DCASA Unidade: CJ/3
F1 F4



CABIDE ACRIL AD VINTAGE BRANCO 102 3X1

Código: 45754 Fábrica: DCASA Unidade: CJ/3
F1 F4

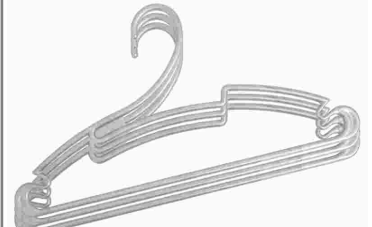

CABIDE ACRIL AD VINTAGE CINZA 110 3X1

Código: 45759 Fábrica: DCASA Unidade: CJ/3
F1 F4

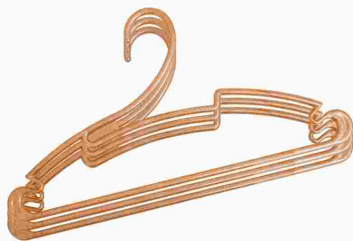

CABIDE ACRIL AD VINTAGE COBRE 103 3X1

Código: 45756 Fábrica: DCASA Unidade: CJ/3
F1 F4

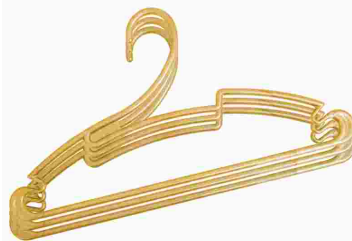

CABIDE ACRIL AD VINTAGE OURO 105 3X1

Código: 45758 Fábrica: DCASA Unidade: CJ/3
F1 F4

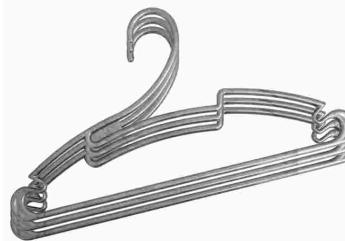

CABIDE ACRIL AD VINTAGE PLATINA 104 3X1

Código: 45757 Fábrica: DCASA Unidade: CJ/3
F1 F4

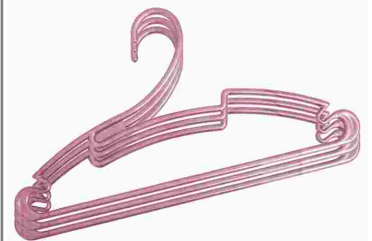

CABIDE ACRIL AD VINTAGE ROSE GOLD112 3X1

Código: 45760 Fábrica: DCASA Unidade: CJ/3
F1 F4



CABIDE ACRIL INF AZUL 200 3X1

Código: 45749 Fábrica: DCASA Unidade: CJ/3 F1 F4



CABIDE ACRIL INF BRANCO 400 3X1

Código: 45748 Fábrica: DCASA Unidade: CJ/3 F1 F4

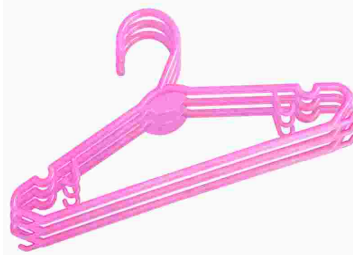

CABIDE ACRIL INF ROSA 100 3X1

Código: 45750 Fábrica: DCASA Unidade: CJ/3 F1 F4



CABIDE CROM POPULAR 792 12X1

Código: 7502 Fábrica: ARAMINAS Unidade: DZ/12 F1 F4



17 cm

CABIDE GALINHA C/1 GANCHO 5055

Código: 39230 Fábrica: PAIOL Unidade: UN/1 F1 F4



CABIDE PLAST AD PRETO 400 3X1

Código: 40952 Fábrica: P A SOUZA Unidade: CJ/3 F1 F4



CABIDE PLAST AD PRETO 401 6X1

Código: 40953 Fábrica: P A SOUZA Unidade: CJ/6 F1 F4



CABIDE PLAST AD PRETO 402 12X1

Código: 40954 Fábrica: P A SOUZA Unidade: CJ/12 F1 F4

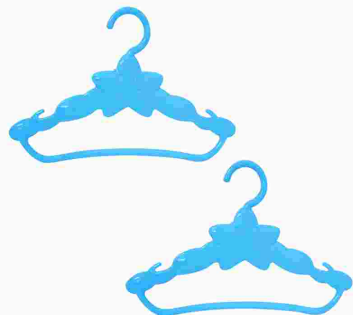

CABIDE PLAST BABY ESTRELA AZUL 3807 2X1

Código: 35489 Fábrica: TRITEC Unidade: CJ/2 F1 F4



CABIDE PLAST BABY ESTRELA ROSA 3808 2X1

Código: 35488 Fábrica: TRITEC Unidade: CJ/2 F1 F4



CABIDE PLAST PRETO 001 3X1

Código: 41490 Fábrica: KOZI PLAST Unidade: CJ/3 F1 F4



CABO MADEIRA 1,20 MTS C/ ROSCA

Código: 49869 Fábrica: HALLEY Unidade: UN/1 F1 F4



CABO MADEIRA 1,20 MTS C/ ROSCA

Código: 49896 Fábrica: HALLEY Unidade: UN/1 F1 F4



CACAROLA ALUM HOTEL 30 10LTS

Código: 50778 Fábrica: ASJ Unidade: UN/1 F1 F4



CACAROLA ALUM HOTEL 32 12LTS

Código: 50777 Fábrica: ASJ Unidade: UN/1 F1 F4



CACAROLA ALUM HOTEL 36 17LTS

Código: 50716 Fábrica: ASJ Unidade: UN/1 F1 F4



CACAROLA ALUM LEVE 14 C/TAMPA 1,0 LT
 Código: 14755 Fábrica: AVELAR Unidade: UN/1
 F1 F4



CACAROLA ALUM LEVE 16 C/TAMPA 1,3 LTS
 Código: 14756 Fábrica: AVELAR Unidade: UN/1
 F1 F4



CACHEPOT ALUM CANELADO SEM ALCA PEQ 206
 Código: 39548 Fábrica: BMC ALUMINIO Unidade: UN/1
 F1 F4



CACHEPOT ATHENAS JARDINEIRA 26 ENVELHECI
 Código: 32759 Fábrica: NUTRIPLAN Unidade: UN/1
 F1 F4



11 22 cm
 19 cm

CACHEPOT ELEGANCE CONICO CYBIDIUM BRANCO
 Código: 39645 Fábrica: NUTRIPLAN Unidade: UN/1
 F1 F4



11 22 cm
 19 cm

CACHEPOT ELEGANCE CONICO CYBIDIUM CAFE I
 Código: 38910 Fábrica: NUTRIPLAN Unidade: UN/1
 F1 F4



11 22 cm
 19 cm

CACHEPOT ELEGANCE CONICO CYBIDIUM TRAVER
 Código: 39646 Fábrica: NUTRIPLAN Unidade: UN/1
 F1 F4



11 11 cm
 34 cm
 3,1 lts

CACHEPOT ELEGANCE JARDINEIRA 01 BRANC 3L
 Código: 32763 Fábrica: NUTRIPLAN Unidade: UN/1
 F1 F4



11 11 cm
 34 cm
 3,1 lts

CACHEPOT ELEGANCE JARDINEIRA 01 CAFE 3L
 Código: 32760 Fábrica: NUTRIPLAN Unidade: UN/1
 F1 F4



11 11 cm
 34 cm
 3,1 lts

CACHEPOT ELEGANCE JARDINEIRA 01 PRETO 3L
 Código: 32764 Fábrica: NUTRIPLAN Unidade: UN/1
 F1 F4



11 11 cm
 34 cm
 3,1 lts

CACHEPOT ELEGANCE JARDINEIRA 01 TRAVE 3L
 Código: 32762 Fábrica: NUTRIPLAN Unidade: UN/1
 F1 F4



11 14 cm
 21 cm
 1 lts

CACHEPOT ELEGANCE PAREDE MINI PRETO 1,5L
 Código: 33083 Fábrica: NUTRIPLAN Unidade: UN/1
 F1 F4

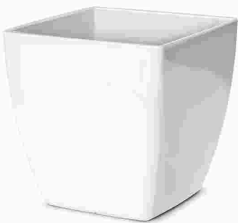

11,2cm
 11cm

CACHEPOT ELEGANCE QUAD 01 BRANCO 950ML
 Código: 48426 Fábrica: NUTRIPLAN Unidade: UN/1
 F1 F4



11,2cm
 11cm

CACHEPOT ELEGANCE QUAD 01 CAFE IMP 950ML
 Código: 48427 Fábrica: NUTRIPLAN Unidade: UN/1
 F1 F4



11 11 cm
 11,2 cm
 0,95 lts

CACHEPOT ELEGANCE QUAD 01 TRAVERTI 950ML
 Código: 32768 Fábrica: NUTRIPLAN Unidade: UN/1
 F1 F4



11 13 cm
 13 cm
 2,4 lts

CACHEPOT ELEGANCE QUAD 02 VERDE LIM 1,7L
 Código: 33087 Fábrica: NUTRIPLAN Unidade: UN/1
 F1 F4

13 cm
13 cm
2,4 lts



CACHEPOT ELEGANCE QUAD 03 AZUL BB 2,4LTS
Código: 36791 Fábrica: NUTRIPLAN Unidade: UN/1 F1 F4

14,9 cm
15,2 cm
2,4 lts

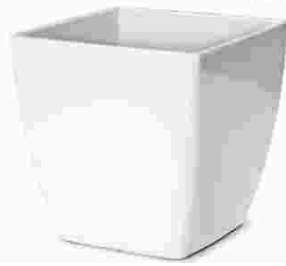

CACHEPOT ELEGANCE QUAD 03 BRANCO 2,4LTS
Código: 32766 Fábrica: NUTRIPLAN Unidade: UN/1 F1 F4

14,9 cm
15,2 cm
2,4 lts



CACHEPOT ELEGANCE QUAD 03 CAFE IMPE 2,4L
Código: 32765 Fábrica: NUTRIPLAN Unidade: UN/1 F1 F4

13 cm
13 cm
2,4 lts



CACHEPOT ELEGANCE QUAD 03 ROSE 2,4LTS
Código: 36792 Fábrica: NUTRIPLAN Unidade: UN/1 F1 F4

14 cm
15 cm
1,7 lts



CACHEPOT ELEGANCE QUAD 03 TRAVERTIN 2,4L
Código: 33908 Fábrica: NUTRIPLAN Unidade: UN/1 F1 F4

16 cm
16 cm
3 lts

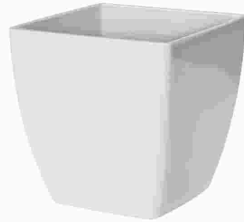

CACHEPOT ELEGANCE QUAD 04 BRANCO 3LTS
Código: 38673 Fábrica: NUTRIPLAN Unidade: UN/1 F1 F4

16,6 cm
16,1 cm
3,0 lts



CACHEPOT ELEGANCE QUAD 04 CAFE IMPE 3LTS
Código: 33550 Fábrica: NUTRIPLAN Unidade: UN/1 F1 F4

5,5 cm



CACHEPOT ELEGANCE RED MINI AZUL BB 12X1
Código: 35719 Fábrica: NUTRIPLAN Unidade: PT/12 F1 F4

5,5 cm



CACHEPOT ELEGANCE RED MINI PRETO ON 12X1
Código: 35722 Fábrica: NUTRIPLAN Unidade: PT/12 F1 F4

5,5 cm



CACHEPOT ELEGANCE RED MINI ROSE 12X1
Código: 35723 Fábrica: NUTRIPLAN Unidade: PT/12 F1 F4

5,5 cm



CACHEPOT ELEGANCE RED MINI VINHO 12X1
Código: 35725 Fábrica: NUTRIPLAN Unidade: PT/12 F1 F4

5 cm
6,5 cm
350 ml



CACHEPOT ELEGANCE RED 00 BRAN 350ML 12X1
Código: 38907 Fábrica: NUTRIPLAN Unidade: PT/12 F1 F4

5 cm
6,5 cm
350 ml



CACHEPOT ELEGANCE RED 00 CAFE 350ML 12X1
Código: 38908 Fábrica: NUTRIPLAN Unidade: UN/1 F1 F4

5 cm
6,5 cm
350 ml



CACHEPOT ELEGANCE RED 00 DOUR 350ML 12X1
Código: 38906 Fábrica: NUTRIPLAN Unidade: PT/12 F1 F4

5 cm
6,5 cm
350 ml



CACHEPOT ELEGANCE RED 00 PRET 350ML 12X1
Código: 38909 Fábrica: NUTRIPLAN Unidade: PT/12 F1 F4

5 cm
6,5 cm
350 ml



CACHEPOT ELEGANCE RED 00 TRAV 350ML 12X1
Código: 38905 Fábrica: NUTRIPLAN Unidade: PT/12 F1 F4



 5 cm
 6,5 cm
 350 ml

CACHEPOT ELEGANCE RED 00 VINH 350ML 12X1
 Código: 38911 Fábrica: NUTRIPLAN Unidade: PT/12
 F1 F4



 8,7 cm
 11,4 cm
 0,6 lts

CACHEPOT ELEGANCE RED 01 AMARELO 600ML
 Código: 32732 Fábrica: NUTRIPLAN Unidade: UN/1
 F1 F4



 8 cm
 11 cm
 0,6 lts

CACHEPOT ELEGANCE RED 01 PRETO 600ML
 Código: 33082 Fábrica: NUTRIPLAN Unidade: UN/1
 F1 F4



 10,9 cm
 13,6 cm
 1,0 lts

CACHEPOT ELEGANCE RED 03 BRANCO 1,5LT
 Código: 37750 Fábrica: NUTRIPLAN Unidade: UN/1
 F1 F4



 12 cm
 15 cm
 1,5 lts

CACHEPOT ELEGANCE RED 03 CAFE IMPER 1,5L
 Código: 33080 Fábrica: NUTRIPLAN Unidade: UN/1
 F1 F4



 12 cm
 15,4 cm
 1,5 lts

CACHEPOT ELEGANCE RED 03 TRAVERTIN 1,5LT
 Código: 32726 Fábrica: NUTRIPLAN Unidade: UN/1
 F1 F4



 23,2 cm
 25,4 cm
 8,5 lts

CACHEPOT ELEGANCE RED 04 CAFE IMPER 8,5L
 Código: 32728 Fábrica: NUTRIPLAN Unidade: UN/1
 F1 F4



 26,7 cm
 27,6 cm
 12 lts

CACHEPOT ELEGANCE RED 05 VERDE LIM 12LTS
 Código: 32729 Fábrica: NUTRIPLAN Unidade: UN/1
 F1 F4



 15,3 cm
 15,4 cm
 2,0 lts

CACHEPOT ELEGANCE RED 3,5 PRETO ONIX 2LT
 Código: 32727 Fábrica: NUTRIPLAN Unidade: UN/1
 F1 F4



 26 cm
 4 cm
 4 lts

CACHEPOT ELEGANCE TRAPEZO 01 AZUL BB 4LT
 Código: 36793 Fábrica: NUTRIPLAN Unidade: UN/1
 F1 F4



 26 cm
 4 cm
 4 lts

CACHEPOT ELEGANCE TRAPEZO 01 ROSE 4LT
 Código: 36794 Fábrica: NUTRIPLAN Unidade: UN/1
 F1 F4



 26 cm
 14 cm
 4 lts

CACHEPOT ELEGANCE TRAPEZIO 01 BRANCO 4LT
 Código: 35718 Fábrica: NUTRIPLAN Unidade: UN/1
 F1 F4



 26 cm
 14 cm
 4 lts

CACHEPOT ELEGANCE TRAPEZIO 01 TRAVER 4LT
 Código: 35460 Fábrica: NUTRIPLAN Unidade: UN/1
 F1 F4



 26 cm
 14 cm
 4 lts

CACHEPOT ELEGANCE TRAPEZIO 01 VINHO 4LTS
 Código: 35717 Fábrica: NUTRIPLAN Unidade: UN/1
 F1 F4



 23 cm
 32 cm
 2,4 L

CACHEPOT PLAST PAREDE PRETO 2,4LTS
 Código: 41655 Fábrica: INPLAST Unidade: UN/1
 F1 F4



 23 cm
 32 cm
 2,4 L

CACHEPOT PLAST PAREDE TERRACOTA 2,4LTS
 Código: 41656 Fábrica: INPLAST Unidade: UN/1
 F1 F4



CACHEPOT PLAST 11X14CM 1100
 Código: 37805 Fábrica: ENGIPLAST Unidade: UN/1
 F1 F4



CACHEPOT PLAST 220ML 6404 4X1
 Código: 41492 Fábrica: KOZI PLAST Unidade: CJ/4
 F1 F4



CACHEPOT QUADRADO CONICO 7CM 210
 Código: 30832 Fábrica: P A SOUZA Unidade: UN/1
 F1 F4



CACHEPOT QUADRADO CONICO 9CM 211
 Código: 30831 Fábrica: P A SOUZA Unidade: UN/1
 F1 F4



CACHEPOT QUADRADO CONICO 11CM 212
 Código: 29220 Fábrica: P A SOUZA Unidade: UN/1
 F1 F4



CACHEPOT QUADRADO CONICO 13CM 213
 Código: 29221 Fábrica: P A SOUZA Unidade: UN/1
 F1 F4



CACHEPOT QUADRADO CONICO 15CM 214
 Código: 29222 Fábrica: P A SOUZA Unidade: UN/1
 F1 F4



CACHEPOT QUADRADO RETO 7CM 215
 Código: 30825 Fábrica: P A SOUZA Unidade: UN/1
 F1 F4



CACHEPOT QUADRADO RETO 9CM 216
 Código: 30824 Fábrica: P A SOUZA Unidade: UN/1
 F1 F4



CACHEPOT QUADRADO RETO 11CM 217
 Código: 30823 Fábrica: P A SOUZA Unidade: UN/1
 F1 F4



CACHEPOT QUADRADO RETO 13CM 218
 Código: 30822 Fábrica: P A SOUZA Unidade: UN/1
 F1 F4

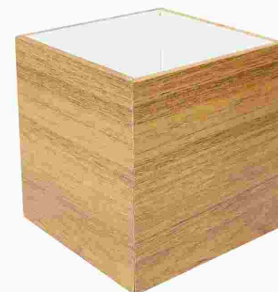

CACHEPOT QUADRADO RETO 15CM 219
 Código: 30821 Fábrica: P A SOUZA Unidade: UN/1
 F1 F4



CACHEPOT SEXTAVADO CONICO 7CM 200
 Código: 30830 Fábrica: P A SOUZA Unidade: UN/1
 F1 F4



CACHEPOT SEXTAVADO CONICO 9CM 201
 Código: 30829 Fábrica: P A SOUZA Unidade: UN/1
 F1 F4



CACHEPOT SEXTAVADO CONICO 11CM 202
 Código: 30828 Fábrica: P A SOUZA Unidade: UN/1
 F1 F4



CACHEPOT SEXTAVADO CONICO 13CM 203
 Código: 30827 Fábrica: P A SOUZA Unidade: UN/1
 F1 F4

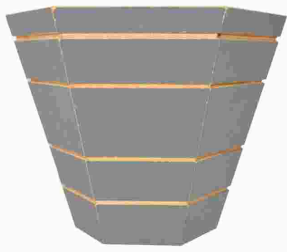

CACHEPOT SEXTAVADO CONICO 15CM 204

Código: 30826
 Fábrica: P A SOUZA
 Unidade: UN/1
 F1 F4

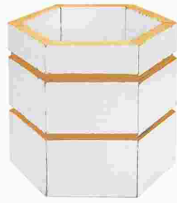

CACHEPOT SEXTAVADO RETO 7CM 205

Código: 30837
 Fábrica: P A SOUZA
 Unidade: UN/1
 F1 F4



CACHEPOT SEXTAVADO RETO 9CM 206

Código: 30836
 Fábrica: P A SOUZA
 Unidade: UN/1
 F1 F4



CACHEPOT SEXTAVADO RETO 11CM 207

Código: 30835
 Fábrica: P A SOUZA
 Unidade: UN/1
 F1 F4

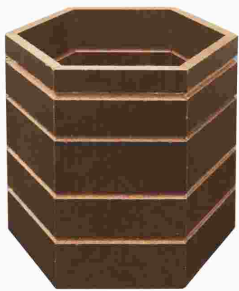

CACHEPOT SEXTAVADO RETO 13CM 208

Código: 30834
 Fábrica: P A SOUZA
 Unidade: UN/1
 F1 F4



CACHEPOT SEXTAVADO RETO 15CM 209

Código: 30833
 Fábrica: P A SOUZA
 Unidade: UN/1
 F1 F4



CADEIRA BISTRO PONTE NOVA BRANCA

Código: 21168
 Fábrica: ANTARES
 Unidade: UN/1
 F1 F4



CADEIRA BISTRO PONTE NOVA PRETA

Código: 40038
 Fábrica: ANTARES
 Unidade: UN/1
 F1 F4



88,5cm
 38cm

CADEIRA COLONIAL PLAST DESMONTAVEL

Código: 22151
 Fábrica: ANTARES
 Unidade: UN/1
 F1 F4



CADEIRA POLTRONA BOA VISTA BRANCA

Código: 21165
 Fábrica: ANTARES
 Unidade: UN/1
 F1 F4



CAFETEIRA ALUM LEVE 1,2 LTS

Código: 5905
 Fábrica: AVELAR
 Unidade: UN/1
 F1 F4



CAFETEIRA ALUM PADRAO 657

Código: 37512
 Fábrica: MSR
 Unidade: UN/1
 F1 F4



CAIXA DE FRUTA GDE ENVELHECIDO 1461-1

Código: 41754
 Fábrica: PAIOL
 Unidade: UN/1
 F1 F4



26 cm
 48 cm

CAIXA DE FRUTA GDE PINTADO 1461

Código: 37178
 Fábrica: PAIOL
 Unidade: UN/1
 F1 F4



19,5 cm
 37 cm

CAIXA DE FRUTA MED ASSADO 1562

Código: 37175
 Fábrica: PAIOL
 Unidade: UN/1
 F1 F4



19,5 cm
 37 cm

CAIXA DE FRUTA MED PINT/ENVELH 1462

Código: 37179
 Fábrica: PAIOL
 Unidade: UN/1
 F1 F4

16 cm
30 cm



CAIXA DE FRUTA PEQ ASSADO 8005

Código: 37176 Fábrica: PAIOL Unidade: UN/1 F1 F4

16 cm
30 cm



CAIXA DE FRUTA PEQ PINT/ENVELH 1463

Código: 37180 Fábrica: PAIOL Unidade: UN/1 F1 F4

12 cm
23 cm



CAIXA DE FRUTA PP ENVELHECIDO 1453-1

Código: 37177 Fábrica: PAIOL Unidade: UN/1 F1 F4

12 cm
23 cm



CAIXA DE FRUTA PP PINTADO 1453-2

Código: 37181 Fábrica: PAIOL Unidade: UN/1 F1 F4

17 cm
35 cm



CAIXA DE FRUTA 2 CRISANTEMOS ENVE 2514-2

Código: 37183 Fábrica: PAIOL Unidade: UN/1 F1 F4



CAIXA DE FRUTA 2 CRISANTEMOS PINT 2514-1

Código: 40842 Fábrica: PAIOL Unidade: UN/1 F1 F4

9 cm
25 cm



CAIXA DE FRUTA 2 VIOLETAS 2515

Código: 37182 Fábrica: PAIOL Unidade: UN/1 F1 F4

8cm
5cm
8cm

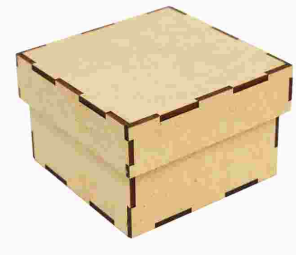

CAIXA MDF 5X5X5CM

Código: 51073 Fábrica: FEITOMAO Unidade: UN/1 F1 F4

8cm
5cm
8cm



CAIXA MDF 8X8X5CM

Código: 47264 Fábrica: FEITOMAO Unidade: UN/1 F1 F4

9cm
5cm
9cm



CAIXA MDF 9X9X5CM

Código: 47265 Fábrica: FEITOMAO Unidade: UN/1 F1 F4

10cm
5cm
10cm

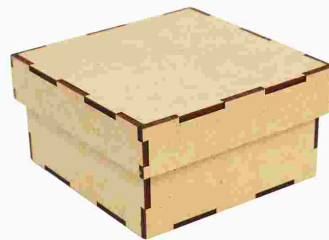

CAIXA MDF 10X10X5CM

Código: 47266 Fábrica: FEITOMAO Unidade: UN/1 F1 F4

12cm
12cm
5cm

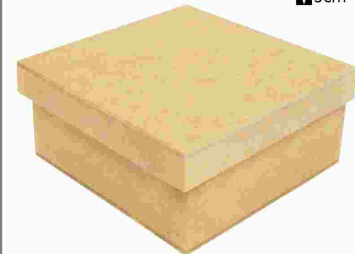

CAIXA MDF 12X12X5CM

Código: 47268 Fábrica: FEITOMAO Unidade: UN/1 F1 F4

15cm
5cm
15cm

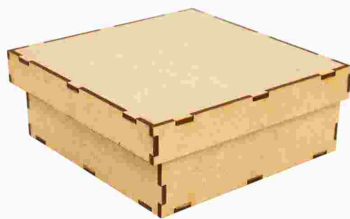

CAIXA MDF 15X15X5CM

Código: 47269 Fábrica: FEITOMAO Unidade: UN/1 F1 F4

20cm
20cm
5cm



CAIXA MDF 20X20X5CM

Código: 50758 Fábrica: FEITOMAO Unidade: UN/1 F1 F4



CAIXA MINI KIT 3 PCS ENVELHECIDO 8788-5

Código: 41056 Fábrica: PAIOL Unidade: CJ/1 F1 F4



CAIXA MINI 1 ENVELHECIDO 8022-2

Código: 41751 Fábrica: PAIOL Unidade: UN/1 F1 F4

17 cm
15 cm



CAIXA MINI 2 ENVELHECIDO 6664-2

Código: 37186 Fábrica: PAIOL Unidade: UN/1
F1 F4

17 cm
13 cm



CAIXA MINI 2 PINTADO 6664-1

Código: 41752 Fábrica: PAIOL Unidade: UN/1
F1 F4



CAIXA MULTI USO 11 LTS RET C/TPA 6649

Código: 24474 Fábrica: INPLAST Unidade: UN/1
F1 F4

16 cm
37 cm
52 cm
21 lts



CAIXA ORG GDE BAIXA 21LTS C/TRAVA 1121

Código: 33035 Fábrica: TRITEC Unidade: UN/1
F1 F4

35cm
38cm
27lts



CAIXA ORG MED ALTA 27LT C/TRAVA 1120

Código: 44256 Fábrica: TRITEC Unidade: UN/1
F1 F4

19 cm
27 cm
3,5 lts

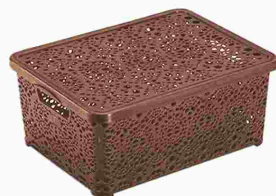

CAIXA ORG MINI MANDALA 3,5L MARROM 1892

Código: 37296 Fábrica: MONTE LIBANO Unidade: UN/1
F1 F4

19 cm
27 cm
3,5 lts



CAIXA ORG MINI MANDALA 3,5L PRETA 1891

Código: 37295 Fábrica: MONTE LIBANO Unidade: UN/1
F1 F4



CAIXA ORG MINI PORTA TUDO C/2GAV 1217

Código: 37293 Fábrica: MONTE LIBANO Unidade: UN/1
F1 F4

22 cm



CAIXA ORG PEQ PORTA TUDO C/3GAV 1170

Código: 43655 Fábrica: MONTE LIBANO Unidade: UN/1
F1 F4

31cm
13cm
22cm



CAIXA ORG PLAST RET C/TRAVA 5LTS 6845

Código: 41659 Fábrica: INPLAST Unidade: UN/1
F1 F4



CAIXA ORG PLAST RET TRANSP 2,5 LTS 6882

Código: 41657 Fábrica: INPLAST Unidade: UN/1
F1 F4



CAIXA ORG PLAST RET TRANSP 3,7 LTS 6886

Código: 41658 Fábrica: INPLAST Unidade: UN/1
F1 F4

19 cm
28 cm
38 cm
15 lts.

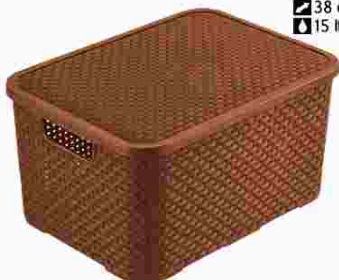

CAIXA ORG RATTAN 15LTS 1820

Código: 32667 Fábrica: GIOTTO Unidade: UN/1
F1 F4

18 cm
40 cm
28 cm
15 lts



CAIXA ORG RATTAN 16 LTS PRETO 214PT

Código: 35958 Fábrica: GIOTTO Unidade: UN/1
F1 F4

28 cm
38 cm
15 lts

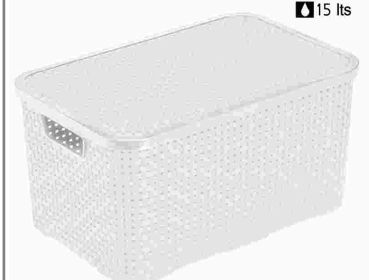

CAIXA ORG RATTAN 18LTS 38X28CM BRAN 1900

Código: 37289 Fábrica: MONTE LIBANO Unidade: UN/1
F1 F4



CAIXA ORG RATTAN 10 LTS PRETO 951895

Código: 41189 Fábrica: PLASTSU Unidade: UN/1
F1 F4



38cm
28cm
18lts

CAIXA ORG RATTAN 18LTS 38X28CM MARR 1902
Código: 37290 Fábrica: MONTE LIBANO Unidade: UN/1
F1 F4



38cm
28cm
18lts

CAIXA ORG RATTAN 18LTS 38X28CM PRET 1906
Código: 37288 Fábrica: MONTE LIBANO Unidade: UN/1
F1 F4



20cm
23cm

CAIXA ORG 10LTS ALTA PRETO C/TRAVA 138
Código: 47726 Fábrica: FORMPLAST Unidade: UN/1
F1 F4



15cm
45cm

CAIXA ORG 12LTS BAIXA PRETO C/TRAVA 8003
Código: 40358 Fábrica: FORMPLAST Unidade: UN/1
F1 F4



CAIXA ORG 18LTS BAIXA PRETO C/TRAVA 134
Código: 47727 Fábrica: FORMPLAST Unidade: UN/1
F1 F4



32cm
45cm

CAIXA ORG 30LTS ALTA PRETO C/TRAVA 132
Código: 40355 Fábrica: FORMPLAST Unidade: UN/1
F1 F4



25cm
60cm

CAIXA ORG 34LTS REFOR PRETO C/TRAVA 128
Código: 47729 Fábrica: FORMPLAST Unidade: UN/1
F1 F4



35cm
60cm

CAIXA ORG 50 LTS REFOR PRETO C/TRAVA 126
Código: 47730 Fábrica: FORMPLAST Unidade: UN/1
F1 F4



12cm
32cm

CAIXA ORG 5,5LTS BAIXA PRETO C/TRAV 3093
Código: 47731 Fábrica: FORMPLAST Unidade: UN/1
F1 F4



CAIXA ORGANI 20LTS PTO ALTA C/TRAVA 6123
Código: 50202 Fábrica: RISCHIOTO Unidade: UN/1
F1 F4



27cm
46cm
25lts

CAIXA ORGANIZADORA 25L TRAVA 0668T
Código: 19692 Fábrica: JAGUAR Unidade: UN/1
F1 F4



20cm
66cm
38lts

CAIXA ORGANIZADORA 38L TRAVA RODIN 2014T
Código: 47093 Fábrica: JAGUAR Unidade: UN/1
F1 F4

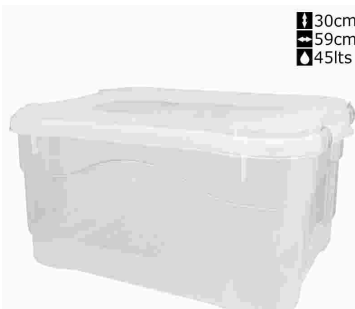

30cm
59cm
45lts

CAIXA ORGANIZADORA 45L TRAVA 0621T
Código: 13169 Fábrica: JAGUAR Unidade: UN/1
F1 F4



CAIXA ORGANIZATTA 1,6LTS C/TRAVA 118
Código: 45192 Fábrica: RISCHIOTO Unidade: UN/1
F1 F4



CAIXA ORGANIZATTA 3,2LTS C/TRAVA 119
Código: 45195 Fábrica: RISCHIOTO Unidade: UN/1
F1 F4



CAIXA ORGANIZATTA 5LTS C/TRAVA 127
Código: 45197 Fábrica: RISCHIOTO Unidade: UN/1
F1 F4



CAIXA ORGANIZATTA 6LTS C/TRAVA 122
 Código: 45199 Fábrica: RISCHIOTO Unidade: UN/1
 F1 F4



CAIXA ORGANIZATTA 10LTS C/TRAVA 121
 Código: 45194 Fábrica: RISCHI/UNIN Unidade: UN/1
 F1 F4

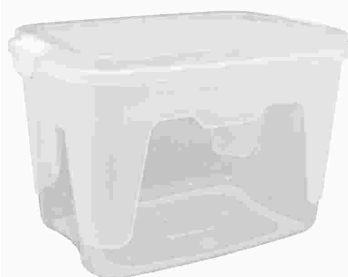

CAIXA ORGANIZATTA 12LTS C/TRAVA 124
 Código: 45193 Fábrica: RISCHIOTO Unidade: UN/1
 F1 F4



CAIXA ORGANIZATTA 20LTS ALTA C/TRAVA 123
 Código: 45200 Fábrica: RISCHIOTO Unidade: UN/1
 F1 F4



CAIXA ORGANIZATTA 20LTS C/TRAVA BAIXA 115
 Código: 45202 Fábrica: RISCHIOTO Unidade: UN/1
 F1 F4



CAIXA ORGANIZATTA 30LTS C/TRAVA ALTA 129
 Código: 45201 Fábrica: RISCHI/UNIN Unidade: UN/1
 F1 F4



CAIXA ORGANIZATTA 30LTS C/TRAVA 116
 Código: 45212 Fábrica: RISCHIOTO Unidade: UN/1
 F1 F4



CAIXA ORGANIZATTA 50LTS C/TRAVA ALTA 117
 Código: 36976 Fábrica: RISCHIOTO Unidade: UN/1
 F1 F4

138 cm
 244 cm



CAIXA ORGANIZATTA 56LTS C/TRAVA ALTA 364
 Código: 50823 Fábrica: UNINJET Unidade: UN/1
 F1 F4

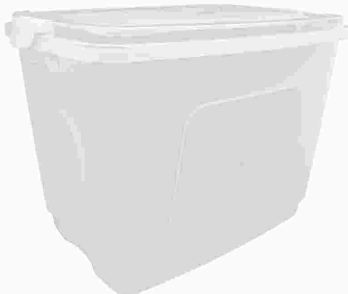

CAIXA ORGANIZATTA 80LTS C/TRAVA 128
 Código: 45198 Fábrica: RISCHIOTO Unidade: UN/1
 F1 F4



CAIXA P/CARNE 19 LTS MULTIUSO 25X41X59CM
 Código: 18386 Fábrica: ANTARES Unidade: UN/1
 F1 F4



CAIXA PLAST ORG 3LTS C/TRAVA TRANSL 417
 Código: 44422 Fábrica: USUAL Unidade: UN/1
 F1 F4

111 cm
 226 cm
 33lts



CAIXA PLAST ORG 5LTS C/TRAVA TRANSL 414
 Código: 44421 Fábrica: USUAL Unidade: UN/1
 F1 F4

14cm
 30cm
 5lts

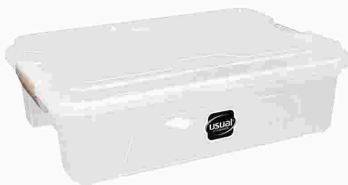

CAIXA PLAST ORG 10LTS C/TRAVA TRANSL 366
 Código: 44420 Fábrica: USUAL Unidade: UN/1
 F1 F4

13cm
 42cm
 10lts

















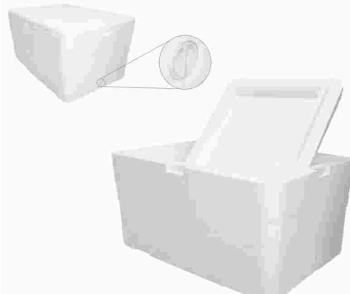

CAIXA PLAST ORG 20LTS C/TRAVA TRANSL 388
 Código: 44419 Fábrica: USUAL Unidade: UN/1
 F1 F4

25cm
 42cm
 20lts



CAIXA PLAST P/MASSA 20 LTS PRETA
 Código: 45251 Fábrica: MOLDE MINAS Unidade: UN/1
 F1 F4

14 cm
 56 cm
 20 lts

 <p>Produto • Altura: 16 cm • Comp: 57cm • Largura: 36 cm</p> <p>CAIXA PLAST P/MASSA 22 LTS BRANCA</p> <p>Código: 12905 Fábrica: ECOPLASTIC Unidade: UN/1 F1 F4</p>	 <p>CAIXA PLAST P/MASSA 22 LTS PRETA</p> <p>Código: 20662 Fábrica: ECOPLASTIC Unidade: UN/1 F1 F4</p>	 <p>CAIXA PLAST PRETA VAZADA AGRICOLA/SUPERM</p> <p>Código: 18385 Fábrica: ECOPLASTIC Unidade: UN/1 F1 F4</p>	 <p>CAIXA PLAST 19 LTS P/MASSA PRETA</p> <p>Código: 12117 Fábrica: ANTARES Unidade: UN/1 F1 F4</p> <p>13cm 57,5cm 38cm</p>
 <p>CAIXA PLAST 6,0 LTS VERSATIL TRANSP 786</p> <p>Código: 39555 Fábrica: LUMAR Unidade: UN/1 F1 F4</p> <p>6 lts</p>	 <p>CAIXA PLAST 7 LTS P/FRIOS 1637</p> <p>Código: 47068 Fábrica: JAGUAR Unidade: UN/1 F1 F4</p> <p>8cm 45cm</p>	 <p>CAIXA TERMICA ISOPOR 80 LTS COM DRENO</p> <p>Código: 47998 Fábrica: ISOMAX Unidade: UN/1 F1 F4</p>	 <p>CAIXA TERMICA 16 LTS COLOR</p> <p>Código: 31769 Fábrica: ANTARES Unidade: UN/1 F1 F4</p>
 <p>CAIXA TERMICA 34 LTS COLOR</p> <p>Código: 30863 Fábrica: ANTARES Unidade: UN/1 F1 F4</p>	 <p>CAIXA VERSATIL QUADR 3,5 LTS 951</p> <p>Código: 34582 Fábrica: PLASTBON Unidade: UN/1 F1 F4</p>	 <p>CAIXA VERSATIL RED 3,5 LTS 949</p> <p>Código: 34583 Fábrica: PLASTBON Unidade: UN/1 F1 F4</p>	 <p>CAIXA VERSATIL RET 3,5 LTS 950</p> <p>Código: 34574 Fábrica: PLASTBON Unidade: UN/1 F1 F4</p>
 <p>CAIXA VERSATIL 2,5LTS RET FACILITA 6340</p> <p>Código: 20696 Fábrica: RISCHIOTO Unidade: UN/1 F1 F4</p>	 <p>CAIXA VERSATIL 3,6LTS RET FACILITTA 0120</p> <p>Código: 20703 Fábrica: RISCHIOTO Unidade: UN/1 F1 F4</p>	 <p>CALDEIRAO ALUM HOTEL ESP 32 22LTS</p> <p>Código: 50714 Fábrica: ASJ Unidade: UN/1 F1 F4</p>	 <p>CALDEIRAO ALUM HOTEL ESP 36 32LTS</p> <p>Código: 50715 Fábrica: ASJ Unidade: UN/1 F1 F4</p>



CALDEIRAO ALUM HOTEL 30 18LTS

Código: 50713
 Fábrica: ASJ
 Unidade: UN/1
 F1 F4



CANECA ALUM CHOPP

Código: 14754
 Fábrica: AVELAR
 Unidade: UN/1
 F1 F4



CANECA ALUM ESCOLAR 02 1286

Código: 37527
 Fábrica: MSR
 Unidade: UN/1
 F1 F4



CANECA ALUM LEVE 12 FRIZADO 1,0 LT

Código: 11261
 Fábrica: AVELAR
 Unidade: UN/1
 F1 F4



11 cm
 350ml

CANECA ALUM 350ML CHOPP BOMDIMAIS 9012

Código: 40400
 Fábrica: UN-ART
 Unidade: UN/1
 F1 F4



11 cm
 350ml

CANECA ALUM 350ML CHOPP CERVEJA GEL 9009

Código: 40399
 Fábrica: UN-ART
 Unidade: UN/1
 F1 F4



11 cm
 350ml

CANECA ALUM 350ML CHOPP DRAHMA 9007

Código: 40398
 Fábrica: UN-ART
 Unidade: UN/1
 F1 F4



CANECA ESMALTADA COLOR 80ML 18151 3X1

Código: 50212
 Fábrica: WELLMIX
 Unidade: CX/3
 F1 F4



CANECA ESMALTADA COLOR 90ML 9111295 4X1

Código: 39257
 Fábrica: FRATELLI
 Unidade: PT/4
 F1 F4



CANECA ESMALTADA PRETO 350ML 18149 6X1

Código: 50210
 Fábrica: WELLMIX
 Unidade: CX/6
 F1 F4



CANECA ESMALTADA VERMELH 350ML 18150 6X1

Código: 50211
 Fábrica: WELLMIX
 Unidade: CX/6
 F1 F4



CANECA ESMALTADA 8CM 7017

Código: 43592
 Fábrica: KEY
 Unidade: UN/1
 F1 F4



CANECA INOX TERM 710ML AZUL 14043

Código: 40667
 Fábrica: INGA
 Unidade: UN/1
 F1 F4



CANECA INOX TERM 710ML BRANCO 14044

Código: 40666
 Fábrica: INGA
 Unidade: UN/1
 F1 F4



CANECA INOX TERM 710ML CINZA 14042

Código: 40669
 Fábrica: INGA
 Unidade: UN/1
 F1 F4



CANECA INOX TERM 710ML PRETO 14041

Código: 40668
 Fábrica: INGA
 Unidade: UN/1
 F1 F4



H 14 cm
L 7 cm
C 350ml

CANECA INOX 350ML LATINHA 14022

Código: 40317 Fábrica: WINCY Unidade: UN/1 F1 F4



CANECA METAL INOX 300ML CRUZEIRO 10716

Código: 41112 Fábrica: BRASFOOT Unidade: UN/1 F1 F4



CANECA PLAST C/ALCA 300 ML CORES

Código: 45926 Fábrica: ANTARES Unidade: UN/1 F1 F4



CANECA PLAST DEC 430ML INFANTIL 1403

Código: 40130 Fábrica: KOZI PLAST Unidade: UN/1 F1 F4



CANECA PLAST ESC 250 ML KIT 3 PCS 4013

Código: 7204 Fábrica: SBRISSA Unidade: CJ/3 F1 F4



CANECA PLAST ESC 270 ML DEC 8016 12X1

Código: 35222 Fábrica: SBRISSA Unidade: PT/12 F1 F4



CANECA PLAST ESCOLAR 300 ML 105

Código: 22324 Fábrica: ECOPLASTIC Unidade: UN/1 F1 F4



CANECA PLAST GEL 300ML ADORO 11641 2X1

Código: 41125 Fábrica: BRASFOOT Unidade: CJ/2 F1 F4



CANECA PLAST GEL 300ML BOMDIMAIS 3961

Código: 39126 Fábrica: BRASFOOT Unidade: UN/1 F1 F4



CANECA PLAST GEL 300ML DRAHMA 3863

Código: 39127 Fábrica: BRASFOOT Unidade: UN/1 F1 F4



CANECA PLAST GEL 300ML HARLEY DAVI 2933

Código: 39130 Fábrica: BRASFOOT Unidade: UN/1 F1 F4



CANECA PLAST GEL 300ML VC ME F 11619 2X1

Código: 41124 Fábrica: BRASFOOT Unidade: UN/1 F1 F4

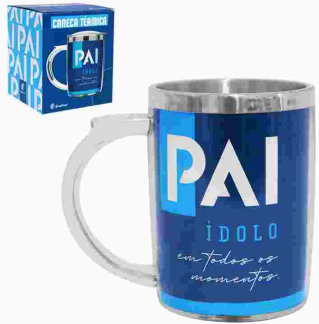

CANECA PLAST TERMICA 450ML PAI IDOLO 05

Código: 39271 Fábrica: BRASFOOT Unidade: UN/1 F1 F4



CANECA PLAST 270 ML COLOR 617

Código: 38661 Fábrica: TRITEC Unidade: UN/1 F1 F4



CORES



CANECA PLAST 310ML COLOR 623

Código: 44082 Fábrica: QUALYPLAS Unidade: UN/1 F1 F4



CANECA PLAST 400 ML C/ ALCA 7000 6X1

Código: 33895 Fábrica: SBRISSA Unidade: CJ/6 F1 F4



CANECA PLAST 400 ML C/ALCA DEC 8022 6X1
 Código: 35223 Fábrica: SBRISSA Unidade: PT/6
 F1 F4



CANECA PLAST 450ML SORT P/FREEZER/MIC 47
 Código: 40989 Fábrica: PLASTIBRASIL Unidade: UN/1
 F1 F4



CANECA PORC 220 ML CACHORRO 13
 Código: 44345 Fábrica: PORCELANASLU Unidade: UN/1
 F1 F4



CANECA PORC 220 ML CAFE/COFFEE 13
 Código: 37247 Fábrica: PORCELANASLU Unidade: UN/1
 F1 F4



CANECA PORC 220 ML CARROS 13
 Código: 37246 Fábrica: PORCELANASLU Unidade: UN/1
 F1 F4



CANECA PORC 220 ML CHOCOLATE 13
 Código: 44350 Fábrica: PORCELANASLU Unidade: UN/1
 F1 F4



CANECA PORC 220 ML GATO 13
 Código: 44344 Fábrica: PORCELANASLU Unidade: UN/1
 F1 F4



CANECA PORC 220 ML MEME BENTO 13
 Código: 44342 Fábrica: PORCELANASLU Unidade: UN/1
 F1 F4



CANECA PORC 220 ML PAI 13
 Código: 37244 Fábrica: PORCELANASLU Unidade: UN/1
 F1 F4



CANECA PORC 220 ML PERIGO 13
 Código: 44346 Fábrica: PORCELANASLU Unidade: UN/1
 F1 F4



CANECA PORC 270ML DEC 778 12X1
 Código: 41433 Fábrica: OXFORD Unidade: C3/12
 F1 F4



CANECA PORC 270ML LISA PTO/BCO 777 12X1
 Código: 41434 Fábrica: OXFORD Unidade: CX/12
 F1 F4



CANECA PORC 360 ML MEU GAME FORT 2955
 Código: 38995 Fábrica: BRASFOOT Unidade: UN/1
 F1 F4



CANECA PORC 360 ML MEU GAME MINE 2567
 Código: 39010 Fábrica: BRASFOOT Unidade: UN/1
 F1 F4



CANECA PORC 360 ML URBAN DIRIGE SEU 5836
 Código: 39110 Fábrica: BRASFOOT Unidade: UN/1
 F1 F4



CANECA PORC 360 ML URBAN O MUNDO 2790
 Código: 39104 Fábrica: BRASFOOT Unidade: UN/1
 F1 F4



CANECA PORC 360ML URBAN ADORO NOS 11494
 Código: **41134** Fábrica: **BRASFOOT** Unidade: **UN/1**
F1 F4



CANECA PORC 360ML URBAN AMIGAS 10041
 Código: **39111** Fábrica: **BRASFOOT** Unidade: **UN/1**
F1 F4



CANECA PORC 360ML URBAN ATLETICO 1627
 Código: **39113** Fábrica: **BRASFOOT** Unidade: **UN/1**
F1 F4



CANECA PORC 360ML URBAN VC ME FAZ 11325
 Código: **41135** Fábrica: **BRASFOOT** Unidade: **UN/1**
F1 F4



CANECA PORCELANA 50ML DECOR 6X1
 Código: **42804** Fábrica: **INTERPONTE** Unidade: **CX/6**
F1 F4



CANECA TERMICA INOX 340ML TRIANGLE 16015
 Código: **40319** Fábrica: **WINCY** Unidade: **UN/1**
F1 F4



CANECA TERMICA INOX 500ML C/TAMPA 1401
 Código: **40318** Fábrica: **WINCY** Unidade: **UN/1**
F1 F4



CANECA VIDRO 100ML CANADA 016 6X1
 Código: **49432** Fábrica: **RIOHOME** Unidade: **CJ/6**
F1 F4



CANECA VIDRO 255ML TRANSP LISA VD24 6X1
 Código: **40294** Fábrica: **MAXXIMUS** Unidade: **CJ/6**
F1 F4



CANECA VIDRO 268ML NOVO 1070 48X1
 Código: **39523** Fábrica: **MULTIPRESENT** Unidade: **CX/48**
F1 F4



CANECA VIDRO 370 ML CHOPP 057 2X1
 Código: **49395** Fábrica: **RIOHOME** Unidade: **CJ/1**
F1 F4



CANECAO ALUM BAT FUND 16 CB MAD 2L 1519
 Código: **37449** Fábrica: **MSR** Unidade: **UN/1**
F1 F4



CANECAO ALUM CHOPP 10 667
 Código: **22732** Fábrica: **MSR** Unidade: **UN/1**
F1 F4



CANECAO ALUM CRAQUEADO 14 CB MAD 1,9 LT
 Código: **34761** Fábrica: **AVELAR** Unidade: **UN/1**
F1 F4



CANECAO ALUM EXTRA 12 CB MAD 1,0 LT 661
 Código: **10438** Fábrica: **MSR** Unidade: **UN/1**
F1 F4



CANECAO ALUM EXTRA 14 CB MAD 1,5 LTS 662
 Código: **24370** Fábrica: **MSR** Unidade: **UN/1**
F1 F4



CANEAÇO ALUM EXTRA 16 CB MAD 2,0 LTS 658
 Código: 24369 Fábrica: MSR Unidade: UN/1
 F1 F4



CANEAÇO ALUM EXTRA 18 CB MAD 2,5 LTS 659
 Código: 24368 Fábrica: MSR Unidade: UN/1
 F1 F4



CANEAÇO ALUM EXTRA 20 CB MAD 660
 Código: 24367 Fábrica: MSR Unidade: UN/1
 F1 F4



CANEAÇO ALUM LEVE JAPONES 2,0 LTS
 Código: 27598 Fábrica: AVELAR Unidade: UN/1
 F1 F4



CANEAÇO ALUM LEVE 14 CB BAQ 1,5 LTS 672
 Código: 35255 Fábrica: MSR Unidade: UN/1
 F1 F4



CANEAÇO ALUM LEVE 16 1,9 LTS
 Código: 5891 Fábrica: AVELAR Unidade: UN/1
 F1 F4



CANEAÇO ALUM LUXO FORTE 18 CB BAQ 1130
 Código: 35037 Fábrica: MSR Unidade: UN/1
 F1 F4



CANEAÇO ALUM LUXO FORTE 20 CB BAQ 898
 Código: 35036 Fábrica: MSR Unidade: UN/1
 F1 F4



CANEAÇO ALUM LUXO 12 CB BAQ 1,0LT 664
 Código: 25305 Fábrica: MSR Unidade: UN/1
 F1 F4



CANEAÇO ALUM LUXO 14 CB BAQ 1,5LT 663
 Código: 24371 Fábrica: MSR Unidade: UN/1
 F1 F4



CANEAÇO ALUM LUXO 16 CB BAQ 2L 665
 Código: 24372 Fábrica: MSR Unidade: UN/1
 F1 F4



CANEAÇO ALUM TEFLON 14 CB BAQ 1425
 Código: 45283 Fábrica: MSR Unidade: UN/1
 F1 F4



CANECO ALUM LEVE BOJUDO 2,7 LTS
 Código: 5892 Fábrica: AVELAR Unidade: UN/1
 F1 F4



CANECO PLAST 040
 Código: 10962 Fábrica: HM UTILIDADE Unidade: UN/1
 F1 F4



CANIVETE LAMINA ESTREITA 80X14MM 6326
 Código: 41349 Fábrica: CORNETA Unidade: UN/1
 F1 F4



CANUDO PAPEL 19,7X0,6CM BRANCO 100X1
 Código: 46909 Fábrica: VMP Unidade: CX/100
 F1 F4



CANUDO PAPEL 19,7X0,6CM BRANCO 25X1
 Código: 46907 Fábrica: VMP Unidade: PT/25
 F1 F4



CANUDO PAPEL 19,7X0,6CM ROSA 25X1
 Código: 46908 Fábrica: VMP Unidade: PT/25
 F1 F4



CANUDO PAPEL 19,7X0,8CM BRANCO 5067 25X1
 Código: 47902 Fábrica: CASITA Unidade: PT/25
 F1 F4



CANUDO PLAST LISO FLEXIVEL COLOR 100X1
 Código: 50420 Fábrica: PLAZAPEL Unidade: PT/100
 F1 F4



CANUDO PLAST MILK S 8X21CM EMB IND 150X1
 Código: 47651 Fábrica: JACARE Unidade: PT/150
 F1 F4



CANUDO PLAST VITAMI 6X21CM EMB IND 100X1
 Código: 47652 Fábrica: PLASTSUL Unidade: PT/100
 F1 F4



CANUDO PLASTICO 21CM 65074 100X1
 Código: 33209 Fábrica: PLASTSU/SHOK Unidade: PT/1
 F1 F4



CAPA ALMOFADA PANO INF 34X34CM FRENT EST
 Código: 40450 Fábrica: SUN WELLS Unidade: UN/1
 F1 F4

34 cm
 34 cm



CAPA P/BOTIJA UNIVERSAL 13 KG
 Código: 7771 Fábrica: FERREIRA Unidade: UN/1
 F1 F4



CAPA P/FILTRO 15124
 Código: 35113 Fábrica: SATYAM Unidade: UN/1
 F1 F4



CAPA P/MAQUINA LAVAR NAPA REFOR ATE11 KG
 Código: 11339 Fábrica: FERREIRA Unidade: UN/1
 F1 F4



CAPA P/TAMPA DE FOGAO 4 BOCAS 52X52CM
 Código: 39277 Fábrica: FERREIRA Unidade: UN/1
 F1 F4

52cm
 52cm



CAPA P/TAMPA DE FOGAO 6 BOCAS 52X81CM
 Código: 11338 Fábrica: FERREIRA Unidade: UN/1
 F1 F4



CARRETILHA INOX 20,8CM P/MASSAS 064
 Código: 47333 Fábrica: NIX Unidade: UN/1
 F1 F4

21 cm
 40 cm



CARRIOLA PL CRISANTEMO CAFE 2390
 Código: 37143 Fábrica: PAIOL Unidade: UN/1
 F1 F4



CARRIOLA PL MADEIRA ENVELHECIDA P 5074-2
 Código: 41403 Fábrica: PAIOL Unidade: UN/1
 F1 F4

↑ 15,5 cm
↔ 44 cm



CARRIOLA PL 2 VIOLETAS CAFE 0126

Código: 37141 Fábrica: PAIOL Unidade: UN/1 F1 F4



CASCA DE PINUS PO 1 KG

Código: 22288 Fábrica: VITAPLAN Unidade: PT/1 F1 F4



CASCA DE PINUS 300 GRS

Código: 27463 Fábrica: NOVATROPICAL Unidade: PT/1 F1 F4

↑ 38 cm
↔ 16 cm



CASINHA PLANTA GDE CAFE 130

Código: 37146 Fábrica: PAIOL Unidade: UN/1 F1 F4

↑ 52 cm
↔ 23 cm



CASINHA PLANTA 2 ANDARES CAFE 0392

Código: 37145 Fábrica: PAIOL Unidade: UN/1 F1 F4

↑ 40 cm
↔ 27 cm



CASINHA PLANTA 2 VIOLETAS CAFE 2460

Código: 37147 Fábrica: PAIOL Unidade: UN/1 F1 F4

↑ 77 cm
↔ 24 cm



CASINHA PLANTA 3 ANDARES CAFE 0404

Código: 37144 Fábrica: PAIOL Unidade: UN/1 F1 F4

↔ 33cm
↑ 10,5cm
↘ 23,5cm



CESTA CAFE MANHA KRAFT 23,5X33X10,5CM UN

Código: 44233 Fábrica: PFEIFER Unidade: UN/1 F1 F4

↑ 19cm
↔ 11cm



CESTA FRALDEIRA 11CM RED PINUS 8940

Código: 50819 Fábrica: PAIOL Unidade: UN/1 F1 F4

↑ 21cm
↔ 13cm



CESTA FRALDEIRA 13CM RED PINUS 8941

Código: 50820 Fábrica: PAIOL Unidade: UN/1 F1 F4

↑ 23cm
↔ 15cm



CESTA FRALDEIRA 15CM RED PINUS 8942

Código: 50821 Fábrica: PAIOL Unidade: UN/1 F1 F4

↑ 27cm
↔ 18cm



CESTA FRALDEIRA 18CM RED PINUS 8943

Código: 41297 Fábrica: PAIOL Unidade: UN/1 F1 F4

↑ 31cm
↔ 25cm



CESTA FRALDEIRA 25CM RED PINUS 8944

Código: 41298 Fábrica: PAIOL Unidade: UN/1 F1 F4

↑ 37cm
↔ 30cm



CESTA FRALDEIRA 30CM RED PINUS 8945

Código: 41299 Fábrica: PAIOL Unidade: UN/1 F1 F4

↑ 32 cm
↔ 31 cm



CESTA VIME RED PEQ 5081

Código: 40611 Fábrica: PAIOL Unidade: UN/1 F1 F4

↑ 25cm
↔ 24cm



CESTO PAPELEIRO TELADO QUAD PTO 24X24CM

Código: 32922 Fábrica: SHANGRILA Unidade: UN/1 F1 F4



↑ 24cm
→ 30cm

CESTO PAPELEIRO TELADO RED PTO 23X30CM

Código: 32923 Fábrica: SHANGRILA Unidade: UN/1 F1 F4



⊘ 52cm
↑ 75cm
↓ 60lts

CESTO PLAST BASIC 60 LTS ECO 3081/79

Código: 49172 Fábrica: JAGUAR Unidade: UN/1 F1 F4



⊘ 55cm
↑ 63cm
↓ 95lts

CESTO PLAST FECHADO COLOR 95 LTS 6862

Código: 41663 Fábrica: INPLAST Unidade: UN/1 F1 F4



↑ 5,5cm
→ 34,4cm
↓ 11cm

CESTO PLAST GDE C/5 DIV TRANSL 760

Código: 44428 Fábrica: USUAL Unidade: UN/1 F1 F4

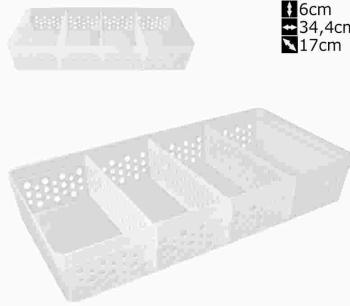

↑ 6cm
→ 34,4cm
↓ 17cm

CESTO PLAST MAXI C/3 DIV TRANSL 796

Código: 44429 Fábrica: USUAL Unidade: UN/1 F1 F4



↑ 6cm
→ 24,4cm
↓ 19cm

CESTO PLAST MED 24,2X19,6,5CM PRETO 617

Código: 44430 Fábrica: USUAL Unidade: UN/1 F1 F4

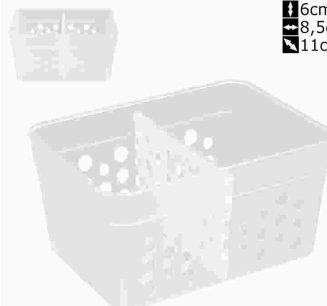

↑ 6cm
→ 8,5cm
↓ 11cm

CESTO PLAST MINI C/1 DIV TRANSL 757

Código: 44427 Fábrica: USUAL Unidade: UN/1 F1 F4



CESTO PLAST ROUPEIRO 30 LTS COLOR 828

Código: 51064 Fábrica: LUMAR Unidade: UN/1 F1 F4



CESTO PLAST ROUPEIRO 60 LTS 849

Código: 46666 Fábrica: LUMAR Unidade: UN/1 F1 F4



↑ 64cm
⊘ 58cm
↓ 100lts

CESTO PLAST ROUPEIRO 100 LTS PRETO 3100

Código: 46667 Fábrica: LUMAR Unidade: UN/1 F1 F4



⊘ 45cm
↑ 52cm

CESTO PLAST TELADO COLOR 62 LTS 6682

Código: 41665 Fábrica: INPLAST Unidade: UN/1 F1 F4

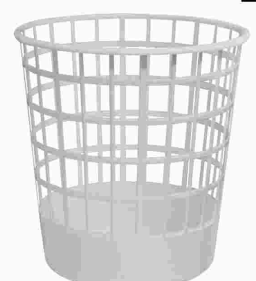

↑ 24 cm
→ 25 cm

CESTO PLAST TELADO RED BCO 24X25CM 340

Código: 33032 Fábrica: TRITEC Unidade: UN/1 F1 F4



CESTO PLAST TELADO RED 30 LTS PRETO 789

Código: 51062 Fábrica: LUMAR Unidade: UN/1 F1 F4



CESTO PLAST TELADO RED 60 LTS PRETO 937

Código: 51063 Fábrica: LUMAR Unidade: UN/1 F1 F4



CESTO PLAST TELADO RET 35 LTS PRETO 1015

Código: 51047 Fábrica: LUMAR Unidade: UN/1 F1 F4



CESTO PLAST TELADO RET 72 LTS PRETO 931

Código: 51046 Fábrica: LUMAR Unidade: UN/1 F1 F4



CESTO PLAST TELADO 10 LTS PRETO 163

Código: **38656** Fábrica: **MOLDE MINAS** Unidade: **UN/1**
F1 F4



CESTO PLAST TELADO 10 LTS 118

Código: **50003** Fábrica: **PLASMARC** Unidade: **UN/1**
F1 F4



52cm
10lts

CESTO PLAST TELADO 10 LTS 728

Código: **37264** Fábrica: **LUMAR** Unidade: **UN/1**
F1 F4



52cm
30lts

CESTO PLAST TELADO 30 LTS AZUL BABY 831

Código: **50943** Fábrica: **LUMAR** Unidade: **UN/1**
F1 F4



52cm
30lts

CESTO PLAST TELADO 30 LTS BRANCO 776

Código: **39552** Fábrica: **LUMAR** Unidade: **UN/1**
F1 F4



30 lts

CESTO PLAST TELADO 30 LTS FENDI 873

Código: **39554** Fábrica: **LUMAR** Unidade: **UN/1**
F1 F4



52cm
30lts

CESTO PLAST TELADO 30 LTS ROSA BABY 831

Código: **48998** Fábrica: **LUMAR** Unidade: **UN/1**
F1 F4

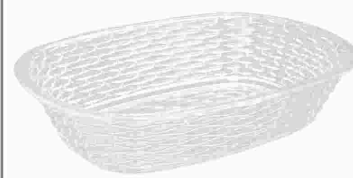

6cm
30cm

CESTO P/PAO CRISTAL NATURAL 2342

Código: **44255** Fábrica: **TRITEC** Unidade: **UN/1**
F1 F4



CESTO TELADO RET P/ROUPA 60 LTS CORES

Código: **40878** Fábrica: **ANTARES** Unidade: **UN/1**
F1 F4



CESTO TELADO ROUPAS 30LTS COLOR 951765

Código: **41199** Fábrica: **PLASTSU** Unidade: **UN/1**
F1 F4



CESTO TELADO ROUPAS 30LTS PRETO 951000

Código: **41198** Fábrica: **PLASTSU** Unidade: **UN/1**
F1 F4



CHIPS DE COCO 1 LITRO

Código: **48533** Fábrica: **NOVATROPICAL** Unidade: **PT/1**
F1 F4



CHUVEIRINHO P/TORNEIRA PIA TANQUE 1 12X1

Código: **33735** Fábrica: **REBOUCAS** Unidade: **PT/12**
F1 F4



COADOR FLANELA CAFE SEM CABO 12X1

Código: **50969** Fábrica: **BEAUTY** Unidade: **DZ/12**
F1 F4



COADOR FLANELA CAFE 102 CB MAD 12X1

Código: **27405** Fábrica: **MCPAN/BEAUTY** Unidade: **DZ/12**
F1 F4



COADOR FLANELA CAFE 103 CB MAD 12X1

Código: **27406** Fábrica: **BEAU/AMO/MAR** Unidade: **DZ/12**
F1 F4



COADOR FLANELA CAFE 104 CB ALUM 12X1

Código: 27412
 Fábrica: FERREIRA
 Unidade: DZ/12
 F1 F4



COADOR FLANELA CAFE 104 CB MAD UN

Código: 46137
 Fábrica: MC PANOS
 Unidade: UN/1
 F1 F4



COADOR FLANELA CAFE 104 CB MAD 12X1

Código: 27408
 Fábrica: MC PANOS
 Unidade: DZ/12
 F1 F4



COADOR FLANELA CAFE 105 CB MAD 12X1

Código: 23956
 Fábrica: MC PANOS
 Unidade: DZ/12
 F1 F4



COADOR FLANELA CAFE 107 CB MAD 12X1

Código: 34505
 Fábrica: MC PANOS
 Unidade: DZ/12
 F1 F4



COADOR MALHA CAFE GDE CB PLAST 12X1

Código: 24949
 Fábrica: NZA
 Unidade: DZ/12
 F1 F4



COADOR PLASTICO 07 CM 3020 UN

Código: 48015
 Fábrica: SBRISSA
 Unidade: UN/1
 F1 F4



COADOR PLASTICO 12 CM 3021 UN

Código: 16642
 Fábrica: SBRISSA
 Unidade: UN/1
 F1 F4



COADOR PLASTICO 18 CM 3023 UN

Código: 48009
 Fábrica: SBRISSA
 Unidade: UN/1
 F1 F4



COLEIRA PET FIBRA C/SINO 30 CM 12X1

Código: 45878
 Fábrica: ALMEGA
 Unidade: PT/12
 F1 F4



COLEIRA PET TIPO COURO 38 CM 15593 6X1

Código: 39244
 Fábrica: ALIANCA
 Unidade: PT/6
 F1 F4



COLHER ACO INOX REFEICAO 21CM 14736 6X1

Código: 46490
 Fábrica: NICOBEM
 Unidade: PT/6
 F1 F4



COLHER ACO INOX SOBREMESA 17CM 14771 6X1

Código: 46489
 Fábrica: NICOBEM
 Unidade: PT/6
 F1 F4



COLHER ACO INOX 34CM GDE 14785

Código: 46488
 Fábrica: NICOBEM
 Unidade: UN/1
 F1 F4



COLHER ALUM BATIDO 30CM ARROZ 2641

Código: 45293
 Fábrica: MSR
 Unidade: UN/1
 F1 F4



COLHER ALUM 27CM INTEIRICO 2018 UN

Código: 48018
 Fábrica: COFAX
 Unidade: UN/1
 F1 F4



COLHER ALUM 28CM CB MAD 2003 UN
 Código: 48035 Fábrica: COFAX Unidade: UN/1
 F1 F4



COLHER BAMBU 23 CM 050
 Código: 46252 Fábrica: CASITA Unidade: UN/1
 F1 F4



COLHER BAMBU 30 CM 052
 Código: 46253 Fábrica: CASITA Unidade: UN/1
 F1 F4



COLHER DESCARTAVEL 50X1
 Código: 42147 Fábrica: PLAZA/RIOFES Unidade: PT/50
 F1 F4

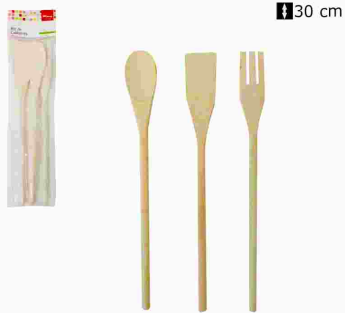

COLHER ESPATULA GARFO MADEIRA 30CM 6029
 Código: 44738 Fábrica: WINCY Unidade: C/3
 F1 F4



COLHER INOX CACIQUE 33CM 137
 Código: 39351 Fábrica: PLANETA Unidade: UN/1
 F1 F4



COLHER INOX CHA LINHA PRATA 110 12X1
 Código: 47628 Fábrica: PLANETA Unidade: PT/12
 F1 F4



COLHER INOX MESA LINHA AMERICA 2223 12X1
 Código: 50620 Fábrica: STEEL Unidade: PT/12
 F1 F4



COLHER INOX MESA UNIVERSO 2046 6X1
 Código: 50136 Fábrica: GP6 Unidade: PT/6
 F1 F4



COLHER INOX MESA 19CM VERSA PTO 954 12X1
 Código: 50163 Fábrica: PLANETA Unidade: DZ/12
 F1 F4



COLHER INOX P/PARROZ 35CM 173
 Código: 19947 Fábrica: PLANETA Unidade: UN/1
 F1 F4



COLHER INOX P/SUCO 30,5CM 8189
 Código: 41541 Fábrica: ELITE Unidade: UN/1
 F1 F4



COLHER INOX SOBREMESA BRONZE 522 12X1
 Código: 39346 Fábrica: PLANETA Unidade: PT/12
 F1 F4



COLHER INOX SOBREMESA VANGUARD 15CM 12X1
 Código: 50906 Fábrica: GP INOX Unidade: CX/12
 F1 F4



COLHER INOX SORVETE C/EXTRATOR 19CM 3025
 Código: 44728 Fábrica: WINCY Unidade: UN/1
 F1 F4



COLHER INOX SORVETE 19CM CB PLAST 3243
 Código: 44727 Fábrica: WINCY Unidade: UN/1
 F1 F4



COLHER MACARRAO NYLON PRETO 1085
 Código: 37804 Fábrica: ENGIPLAST Unidade: UN/1
 F1 F4



COLHER MADEIRA 23 CM 01
 Código: 41315 Fábrica: MAD LAR Unidade: UN/1
 F1 F4



COLHER MADEIRA 38 CM 105/05
 Código: 30807 Fábrica: CSD/MAD LAR Unidade: UN/1
 F1 F4



COLHER MEDIDORA CHA SOPA 400 4X1
 Código: 37080 Fábrica: DELTA UTIL Unidade: PT/4
 F1 F4



COLHER NYLON ARROZ 33,5CM CB CROMADO 424
 Código: 41351 Fábrica: HAUSKRAFT Unidade: UN/1
 F1 F4



COLHER NYLON BRANCA CB ACO 113-001
 Código: 41487 Fábrica: HERCULES Unidade: UN/1
 F1 F4



COLHER PLAST COLOR 24CM 1014
 Código: 36953 Fábrica: ENGIPLAST Unidade: UN/1
 F1 F4



COLHER PLAST COLOR 30CM 1015
 Código: 36954 Fábrica: ENGIPLAST Unidade: UN/1
 F1 F4



COLHER PLAST COLOR 36CM 1016
 Código: 36955 Fábrica: ENGIPLAST Unidade: UN/1
 F1 F4



COLHER PLAST COLOR 40CM 1017
 Código: 36956 Fábrica: ENGIPLAST Unidade: UN/1
 F1 F4



COLHER PLAST COLOR 5022
 Código: 31279 Fábrica: SBRISSA Unidade: UN/1
 F1 F4



COLHER PLAST P/SORVETE 19CM 290
 Código: 39241 Fábrica: DELTA UTIL Unidade: UN/1
 F1 F4



COLHER PLASTICA 17CM 12X1
 Código: 14580 Fábrica: ECOPLASTIC Unidade: DZ/12
 F1 F4



COLHER SILICONE ARROZ 27CM 110-11
 Código: 44772 Fábrica: NICOBEM Unidade: UN/1
 F1 F4



COLHER SILICONE VM CB ACO INOX 3098
 Código: 33822 Fábrica: SATYAM Unidade: UN/1
 F1 F4



COLHER SILICONE 30X8,5CM CORACAO 9701
 Código: 50220 Fábrica: CASITA Unidade: UN/1
 F1 F4



COLHER+CONCHA NYLON PTO 5003 2X1
 Código: 18708 Fábrica: SBRISSA Unidade: KT/1
 F1 F4



COLHER+PEGADOR MACARRAO NYLON 5004 2X1
 Código: 18709 Fábrica: SBRISSA Unidade: KT/2
 F1 F4



COMEDOIRO PLAST P/CAES MINI AZUL 170ML
 Código: 24166 Fábrica: NUTRIPLAN Unidade: UN/1
 F1 F4



COMEDOIRO PLAST P/CAES MINI ROSA 170ML
 Código: 24164 Fábrica: NUTRIPLAN Unidade: UN/1
 F1 F4



COMEDOIRO PLAST PET 500 ML M COLOR
 Código: 40037 Fábrica: ANTARES Unidade: UN/1
 F1 F4

0,5 lts



CONCHA ACO INOX FEIJAO 25CM 059
 Código: 47490 Fábrica: PLANETA Unidade: UN/1
 F1 F4

25cm



CONCHA ACO INOX MINI 29CM SAFIRA 160
 Código: 28768 Fábrica: PLANETA Unidade: UN/1
 F1 F4

29cm



CONCHA ALUM BATIDO 30CM 2643
 Código: 45294 Fábrica: MSR Unidade: UN/1
 F1 F4

30cm



CONCHA ALUM 27CM INTEIRICO 2020 UN
 Código: 48022 Fábrica: COFAX Unidade: UN/1
 F1 F4



CONCHA ALUM 28CM CB MAD 2000 UN
 Código: 48019 Fábrica: COFAX Unidade: UN/1
 F1 F4



CONCHA INOX CACIQUE 33CM 136
 Código: 39350 Fábrica: PLANETA Unidade: UN/1
 F1 F4



CONCHA INOX COZINHA 32CM 700-42
 Código: 40534 Fábrica: CASA ONZE Unidade: UN/1
 F1 F4

26 cm



CONCHA INOX FEIJAO 26 CM 147-48
 Código: 44770 Fábrica: NICOBEM Unidade: UN/1
 F1 F4



CONCHA INOX SAFIRA 23CM 159
 Código: 39354 Fábrica: PLANETA Unidade: UN/1
 F1 F4



CONCHA INOX VAZADA MINI 23CM SAFIRA 158
 Código: 39353 Fábrica: PLANETA Unidade: UN/1
 F1 F4



CONCHA INOX 30CM FDO CB MAD 32 12X1
 Código: 38435 Fábrica: ARTE INOX Unidade: DZ/12
 F1 F4



CONCHA INOX 32CM FDO INTEIRICO 50 6X1

Código: **38433** Fábrica: **ARTE INOX** Unidade: **PT/6**
F1 F4



CONCHA INOX 32CM RASO CB MAD 33 12X1

Código: **38436** Fábrica: **ARTE INOX** Unidade: **DZ/12**
F1 F4



CONCHA INOX 36CM RS S/SOL CB MAD 63 12X1

Código: **38442** Fábrica: **ARTE INOX** Unidade: **DZ/12**
F1 F4



CONCHA NYLON BRANCA CB ACO 1103-002

Código: **41300** Fábrica: **HERCULES** Unidade: **UN/1**
F1 F4



CONCHA NYLON 33,2M CB CROMADO 069

Código: **41352** Fábrica: **HAUSKRAFT** Unidade: **UN/1**
F1 F4



CONCHA PERFURADA INOX 27CM 72005

Código: **38429** Fábrica: **ALMEGA** Unidade: **UN/1**
F1 F4



CONCHA PLAST COLOR 5023

Código: **31280** Fábrica: **SBRISSA** Unidade: **UN/1**
F1 F4



CONCHA SILICONE 28,5CM 110-12

Código: **44773** Fábrica: **NICOBEM** Unidade: **UN/1**
F1 F4



CONCHA+COLHER+PEGADOR MACARR NYLON 5021

Código: **18711** Fábrica: **SBRISSA** Unidade: **KT/3**
F1 F4



CONCHINHA PLAST MEDIDORA 150GRS 030

Código: **37881** Fábrica: **BENEDETTI** Unidade: **UN/1**
F1 F4



CONEXAO PLAST ENGATE RAPIDO MANGUEIR 213

Código: **40240** Fábrica: **MONTEREY** Unidade: **UN/1**
F1 F4



CONJ INOX P/SERVIR ARROZ 2PCS 152

Código: **41435** Fábrica: **MADEFERINOX** Unidade: **CJ/1**
F1 F4



CONJ INOX P/SERVIR FEIJAO 2PCS 153

Código: **41436** Fábrica: **MADEFERINOX** Unidade: **CJ/1**
F1 F4



CONJ INOX P/SERVIR MASSA 2PCS 150

Código: **41438** Fábrica: **MADEFERINOX** Unidade: **CJ/1**
F1 F4



CONJ INOX P/SERVIR SALADA 2PCS 155

Código: **41437** Fábrica: **MADEFERINOX** Unidade: **CJ/1**
F1 F4



CONJ INOX P/TORTA E BOLO 7PCS 42

Código: **41440** Fábrica: **MADEFERINOX** Unidade: **CJ/1**
F1 F4



CONJ PANELA ALUM EXTR 14/16/18/20/22 720
 Código: 35256 Fábrica: MSR Unidade: CJ/1
 F1 F4



CONJ P/COZINHA ABRIDOR+DESCACADOR 7652
 Código: 34805 Fábrica: IDEA Unidade: CR/1
 F1 F4



CONJ SOBREMESA VIDRO BOWLS 150ML 3PC 014
 Código: 49431 Fábrica: RIOHOME Unidade: UN/1
 F1 F4



CONJ TALHERES CB MAD CHURRASCO 6007 12X1
 Código: 44734 Fábrica: WINCY Unidade: CJ/12
 F1 F4



CONJ UTENSILIOS INOX 4PCS 809
 Código: 41439 Fábrica: MADEFERINOX Unidade: CJ/1
 F1 F4



CONJ 6 TACA VIDRO 300ML BERLIM TRANSP
 Código: 49428 Fábrica: RIOHOME Unidade: UN/1
 F1 F4



CONJ 6 TACA VIDRO 320ML DIAMOND TRANSP
 Código: 49804 Fábrica: FUTURO CASA Unidade: CJ/6
 F1 F4



CONJ 6 TACA VIDRO 330ML BICO JACA TRANSP
 Código: 48204 Fábrica: VIVA FLOR Unidade: CJ/6
 F1 F4



CONJ 6 TACA VIDRO 335ML MADRID TRANSP
 Código: 49429 Fábrica: RIOHOME Unidade: UN/1
 F1 F4



CONJ 6 TACA VIDRO 340ML DIAMANTE TRANSP
 Código: 48203 Fábrica: VIVA FLOR Unidade: CJ/6
 F1 F4



CONJ 6 XICARAS CAFE CERAM 90 ML S/PIR 54
 Código: 49434 Fábrica: RIOHOME Unidade: CJ/1
 F1 F4



CONJ 6 XICARAS CHA VID C/PIRES ALEXA 10A
 Código: 47416 Fábrica: DIAMONDS Unidade: CJ/1
 F1 F4



CONJ 6 XICARAS CHA VID C/PIRES BELLA 753
 Código: 47400 Fábrica: NUNESTAR Unidade: CJ/1
 F1 F4



CONJ 6 XICARAS CHA VID C/PIRES STAR8983
 Código: 47405 Fábrica: NUNESTAR Unidade: CJ/1
 F1 F4



CONJ 6 XICARAS CHA VID C/PIRES STAR8984
 Código: 47404 Fábrica: NUNESTAR Unidade: CJ/1
 F1 F4



CONJ 6 XICARAS CHA VID C/PIRES STAR8986
 Código: 47406 Fábrica: NUNESTAR Unidade: CJ/1
 F1 F4



CONJ 6 XICARAS CHA VID C/PIRES TULIP 748
 Código: 47399 Fábrica: NUNESTAR Unidade: CJ/1
 F1 F4



CONJ 6 XICARAS CHA VID C/PIRES VINO 793
 Código: 47403 Fábrica: NUNESTAR Unidade: CJ/1
 F1 F4



CONJ 6 XICARAS PORC C/PIRES CAFE CUPC 29
 Código: 41332 Fábrica: HAUSKRAFT Unidade: CJ/1
 F1 F4



COOLER 10 LATAS 2674
 Código: 45378 Fábrica: MSR Unidade: UN/1
 F1 F4



COOLER 30 LATAS 2673
 Código: 45377 Fábrica: MSR Unidade: UN/1
 F1 F4



COPO ACRIL MEDIDOR GRADUADO 500ML 989
 Código: 41641 Fábrica: QUALYPLAS Unidade: UN/1
 F1 F4



COPO ALUM LEVE 300 ML LISO
 Código: 34326 Fábrica: AVELAR Unidade: UN/1
 F1 F4



COPO ALUM LISO 1285
 Código: 37525 Fábrica: MSR Unidade: UN/1
 F1 F4



COPO ALUM 200 ML 1423
 Código: 37526 Fábrica: MSR Unidade: UN/1
 F1 F4



COPO ALUM 290ML MUNICH MIX 76640
 Código: 40401 Fábrica: UN-ART Unidade: UN/1
 F1 F4

14cm
 290ml



COPO ALUM 300 ML BRASIL
 Código: 26860 Fábrica: AVELAR Unidade: UN/1
 F1 F4



COPO ALUM 300 ML 666
 Código: 35269 Fábrica: MSR Unidade: UN/1
 F1 F4



13,5cm
 410ml

COPO ALUM 410ML BERLIM MIX 76642
 Código: 40402 Fábrica: UN-ART Unidade: UN/1
 F1 F4



COPO CRISTAL PEQ TRANSP C/PISCA 70790/21
 Código: 26452 Fábrica: Y888/HAI BRA Unidade: UN/1
 F1 F4



COPO CRISTAL 550 ML GRADUADO TRANSP 1005
 Código: 35493 Fábrica: TRITEC Unidade: UN/1
 F1 F4



COPO DESCARTAVEL 50ML 100X1
 Código: 50776 Fábrica: COPOPLAST Unidade: PT/100
 F1 F4



COPO DESCARTAVEL 100ML (POTE) 100X1

Código: 50294
 Fábrica: COPOPLAST
 Unidade: PT/100
 F1 F4



COPO DESCARTAVEL 200ML 100X1

Código: 47738
 Fábrica: COPO MAIS/FL
 Unidade: PT/100
 F1 F4



COPO INOX TERM 500ML AZUL C/TPA ABRIDOR

Código: 40662
 Fábrica: INGA
 Unidade: UN/1
 F1 F4



COPO INOX TERM 500ML BRANCO C/TPA ABRIDO

Código: 40661
 Fábrica: INGA
 Unidade: UN/1
 F1 F4



COPO INOX TERM 500ML CINZA C/TPA ABRIDOR

Código: 40664
 Fábrica: INGA
 Unidade: UN/1
 F1 F4



COPO INOX TERM 500ML ROSA C/TPA ABRIDOR

Código: 40665
 Fábrica: INGA
 Unidade: UN/1
 F1 F4



COPO INOX 500ML 14X8,5X8,5CM 110021

Código: 39229
 Fábrica: SATYAM
 Unidade: UN/1
 F1 F4



COPO LONG DRINK CRISTAL 2654 UN

Código: 50677
 Fábrica: TRITEC
 Unidade: UN/1
 F1 F4



COPO LONG DRINK CRISTAL 2654 12X1

Código: 36234
 Fábrica: TRITEC
 Unidade: PT/12
 F1 F4



COPO PLAST DEC 430ML DONUTS 1405

Código: 40129
 Fábrica: KOZI PLAST
 Unidade: UN/1
 F1 F4



COPO PLAST DEC 430ML FELIZ NATAL 1406

Código: 40128
 Fábrica: KOZI PLAST
 Unidade: UN/1
 F1 F4



COPO PLAST INF C/TPA BIQUEIRA 985

Código: 20058
 Fábrica: ERCAPLAST
 Unidade: UN/1
 F1 F4



COPO PLAST INF P/SUCO PLUS 100 ML 130

Código: 14574
 Fábrica: MAMITA
 Unidade: UN/1
 F1 F4



COPO PLAST INF 245ML C/TPA 1490

Código: 47062
 Fábrica: JAGUAR
 Unidade: UN/1
 F1 F4



COPO PLAST INF 250 ML DEC 8017 12X1

Código: 35221
 Fábrica: SBRISSA
 Unidade: PT/12
 F1 F4



COPO PLAST INF 250 ML 7001 12X1

Código: 9797
 Fábrica: SBRISSA
 Unidade: PT/12
 F1 F4



COPO PLAST INF 250ML C/BIC DEC 8018 10X1
 Código: 35216 Fábrica: SBRISSA Unidade: PT/10
 F1 F4



COPO PLAST INF 250ML C/BICO 7011 10X1
 Código: 31286 Fábrica: SBRISSA Unidade: PT/10
 F1 F4



COPO PLAST INF 300 ML COLOR U020
 Código: 45740 Fábrica: APAS Unidade: UN/1
 F1 F4



COPO PLAST INF 300 ML C/TAMPA COLOR U060
 Código: 45742 Fábrica: APAS Unidade: UN/1
 F1 F4



COPO PLAST INF 300 ML C/TAMPA COLOR U061
 Código: 45741 Fábrica: APAS Unidade: UN/1
 F1 F4



COPO PLAST INOX 450ML FLAMENGO 2885
 Código: 39042 Fábrica: BRASFOOT Unidade: UN/1
 F1 F4



COPO PLAST INOX 450ML MEU GAME FORT 1154
 Código: 39038 Fábrica: BRASFOOT Unidade: UN/1
 F1 F4



COPO PLAST LONG DRINK 200ML AMARELO 2285
 Código: 40101 Fábrica: MASSARI Unidade: UN/1
 F1 F4

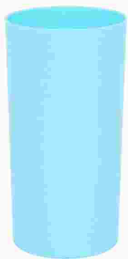

COPO PLAST LONG DRINK 200ML AZUL 2283
 Código: 40100 Fábrica: MASSARI Unidade: UN/1
 F1 F4



COPO PLAST LONG DRINK 200ML BRANCO 2281
 Código: 40098 Fábrica: MASSARI Unidade: UN/1
 F1 F4



COPO PLAST LONG DRINK 200ML CRISTAL 2280
 Código: 40104 Fábrica: MASSARI Unidade: UN/1
 F1 F4



COPO PLAST LONG DRINK 200ML ROSA 2282
 Código: 40102 Fábrica: MASSARI Unidade: UN/1
 F1 F4



COPO PLAST LONG DRINK 200ML VERMELH 2284
 Código: 40103 Fábrica: MASSARI Unidade: UN/1
 F1 F4



COPO PLAST LONG DRINK 350ML CANDY 1317
 Código: 38132 Fábrica: KRIA KOISAS Unidade: UN/1
 F1 F4



COPO PLAST MEDIDA TRANSP 5509
 Código: 41667 Fábrica: INPLAST Unidade: UN/1
 F1 F4



COPO PLAST P/CAIPIRINHA PEQ C/PILAO 403
 Código: 33036 Fábrica: TRITEC Unidade: UN/1
 F1 F4

11 08 cm



COPO PLAST RETRATIL 8734 6X1

Código: 36117 Fábrica: PLASTSANDRI Unidade: PT/6 F1 F4



COPO PLAST TERMICO 200ML ATLETICO 2419

Código: 39040 Fábrica: BRASFOOT Unidade: UN/1 F1 F4



COPO PLAST 350ML CONJ 0008 4X1

Código: 6187 Fábrica: JAGUAR Unidade: CJ/4 F1 F4



COPO PLAST 350ML 0505

Código: 47058 Fábrica: JAGUAR Unidade: UN/1 F1 F4



COPO PLAST 600ML C/TP CANUDO GUERREI 900

Código: 42757 Fábrica: LUMAR Unidade: UN/1 F1 F4



COPO PLAST 600ML C/TP CANUDO PRINCES 901

Código: 42759 Fábrica: LUMAR Unidade: UN/1 F1 F4



COPO PLAST 600ML C/TP CANUDO SPIDER 899

Código: 42756 Fábrica: LUMAR Unidade: UN/1 F1 F4



COPO PLAST 600ML C/TP CANUDO UNICORN 902

Código: 42758 Fábrica: LUMAR Unidade: UN/1 F1 F4



COPO TERM INOX 450ML 18X8CM 3696

Código: 41459 Fábrica: MABEL Unidade: UN/1 F1 F4



COPO TERM 500ML STONE ATLETICO 10675

Código: 41149 Fábrica: BRASFOOT Unidade: UN/1 F1 F4



COPO TERM 500ML STONE CRUZEIRO 10676

Código: 41148 Fábrica: BRASFOOT Unidade: UN/1 F1 F4

11 6 cm
11 50 ml



COPO VIDRO 50ML TRANSP 732 12X1

Código: 40228 Fábrica: HAI BRASIL Unidade: CJ/12 F1 F4

11 9 cm
11 4 cm
11 74 ml



COPO VIDRO 74ML SHOT LEXINGTO 1063 96X1

Código: 39521 Fábrica: MULTIPRESENT Unidade: CX/96 F1 F4



COPO VIDRO AMERICANO 190ML ATLETICO10845

Código: 41111 Fábrica: BRASFOOT Unidade: UN/1 F1 F4



COPO VIDRO AMERICANO 190ML CRUZEIRO10846

Código: 41110 Fábrica: BRASFOOT Unidade: UN/1 F1 F4



COPO VIDRO AMERICANO 190ML 24X1

Código: 47410 Fábrica: NADIR Unidade: CX/24 F1 F4



COPO VIDRO AMERICANO 300ML 24X1

Código: 50369
 Fábrica: NADIR
 Unidade: CX/24
 F1 F4



COPO VIDRO CAIPIRINHA FLAMENGO 9059

Código: 39013
 Fábrica: BRASFOOT
 Unidade: UN/1
 F1 F4



COPO VIDRO CONJ CAIPIRINHA CRUZEIRO 2426

Código: 39123
 Fábrica: BRASFOOT
 Unidade: UN/1
 F1 F4



COPO VIDRO CONJ CAIPIRINHA FLAMENGO 2429

Código: 39267
 Fábrica: BRASFOOT
 Unidade: UN/1
 F1 F4



COPO VIDRO DOSE 60ML ATLETICO 2340

Código: 39121
 Fábrica: BRASFOOT
 Unidade: UN/1
 F1 F4



COPO VIDRO DOSE 60ML FRASE DE BOTECO3916

Código: 39018
 Fábrica: BRASFOOT
 Unidade: UN/1
 F1 F4



COPO VIDRO DOSE 60ML HARLEY DAVIDSO 2935

Código: 39019
 Fábrica: BRASFOOT
 Unidade: UN/1
 F1 F4



COPO VIDRO DOSE 60ML PERAQUEFALTA 1648

Código: 39021
 Fábrica: BRASFOOT
 Unidade: UN/1
 F1 F4



COPO VIDRO WHISKY ATOL 310ML ATLET 11220

Código: 41146
 Fábrica: BRASFOOT
 Unidade: UN/1
 F1 F4



COPO VIDRO WHISKY ATOL 310ML CRUZE 11221

Código: 41147
 Fábrica: BRASFOOT
 Unidade: UN/1
 F1 F4



COPO VIDRO WHISKY ATOL 310ML POKER 4524

Código: 39016
 Fábrica: BRASFOOT
 Unidade: UN/1
 F1 F4



COPO VIDRO 145ML SCALE 017 6X1

Código: 49437
 Fábrica: RIOHOME
 Unidade: CX/1
 F1 F4



COPO VIDRO 180 ML TRANSP 18899 6X1

Código: 48719
 Fábrica: WELLMIX
 Unidade: CJ/6
 F1 F4



COPO VIDRO 180 ML TRANSP 18903 6X1

Código: 48717
 Fábrica: WELLMIX
 Unidade: CJ/6
 F1 F4



COPO VIDRO 180 ML TRANSP 18905 6X1

Código: 48718
 Fábrica: WELLMIX
 Unidade: CJ/6
 F1 F4



COPO VIDRO 200ML MUNICH DRAHMA 1255

Código: 39035
 Fábrica: BRASFOOT
 Unidade: UN/1
 F1 F4



COPO VIDRO 200ML MUNICH MIX 14269
 Código: 40397 Fábrica: UN-ART Unidade: UN/1
 F1 F4



COPO VIDRO 200ML MUNICH SO VOU 1259
 Código: 39037 Fábrica: BRASFOOT Unidade: UN/1
 F1 F4



COPO VIDRO 207 ML TRANSP 60X1
 Código: 39324 Fábrica: FUTURO Unidade: CJ/60
 F1 F4



COPO VIDRO 250ML TRENTO CUBIC 943764 6X1
 Código: 40891 Fábrica: CEDAR GLASS Unidade: CJ/4
 F1 F4



COPO VIDRO 250ML TRENTO ROMAN 943765 6X1
 Código: 40783 Fábrica: CEDAR GLASS Unidade: CJ/4
 F1 F4



COPO VIDRO 290ML TRENTO SMALL 943762 6X1
 Código: 40890 Fábrica: CEDAR GLASS Unidade: CJ/4
 F1 F4



COPO VIDRO 300ML CHOPP ROSTOCK 1035 20X1
 Código: 51078 Fábrica: MULTIPRESENT Unidade: CX/20
 F1 F4



COPO VIDRO 300ML CHOPP ROSTOCK 1035 24X1
 Código: 39531 Fábrica: MULTIPRESENT Unidade: CX/24
 F1 F4



COPO VIDRO 340ML ALTO MONTECAR 1193 72X1
 Código: 39529 Fábrica: MULTIPRESENT Unidade: CX/72
 F1 F4



COPO VIDRO 348ML ALTO ALEGRO 1053 72X1
 Código: 39525 Fábrica: MULTIPRESENT Unidade: CX/72
 F1 F4



COPO VIDRO 350ML CHOPP TRANSP VD52 24X1
 Código: 40300 Fábrica: MAXXIMUS Unidade: CX/24
 F1 F4



COQUETEIRA INOX 500 ML 924
 Código: 50068 Fábrica: PLANETA Unidade: UN/1
 F1 F4



COQUETEIRA PLAST 600ML NOW OR NERVER75
 Código: 39137 Fábrica: BRASFOOT Unidade: UN/1
 F1 F4



COQUETEIRA PLAST 600ML PUSH YOUR LIMIT
 Código: 39138 Fábrica: BRASFOOT Unidade: UN/1
 F1 F4



COQUETEIRA PLAST 600ML TODA CONQUISTA
 Código: 39139 Fábrica: BRASFOOT Unidade: UN/1
 F1 F4



COQUETEIRA PLAST 600ML TREINE COMO UMA
 Código: 39140 Fábrica: BRASFOOT Unidade: UN/1
 F1 F4

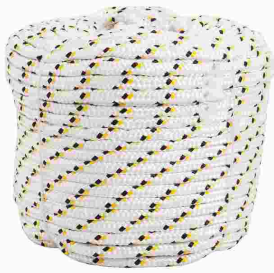

CORDA TRANCADA 14MM 50 MTS 4,5KG

Código: **46809** Fábrica: **VONDER** Unidade: **RL/1**
F1 F4



CORDA VARAL ACO ENCAPADO 10 MTS 12X1

Código: **29842** Fábrica: **DEL WAL** Unidade: **PT/12**
F1 F4



CORDA VARAL ACO ENCAPADO 15 MTS 12X1

Código: **29843** Fábrica: **DEL WAL** Unidade: **PT/12**
F1 F4



CORDA VARAL ACO ENCAPADO 20 MTS 12X1

Código: **29844** Fábrica: **DEL WAL** Unidade: **PT/12**
F1 F4



CORDA VARAL NYLON 3MM 10 MTS 1540

Código: **41539** Fábrica: **ELITE** Unidade: **UN/1**
F1 F4



CORDA VARAL NYLON 4MM 10 MTS 2938

Código: **41545** Fábrica: **ELITE** Unidade: **UN/1**
F1 F4



CORDA VARAL NYLON 5MM 20 MTS 3556

Código: **49628** Fábrica: **WINMAX** Unidade: **UN/1**
F1 F4



CORDA VARAL PLAST MULTI USO 5 MTS 93003

Código: **45877** Fábrica: **ALMEGA** Unidade: **UN/1**
F1 F4



CORDA VARAL PLAST MULTI USO 10 MTS 93002

Código: **34656** Fábrica: **ALMEGA** Unidade: **UN/1**
F1 F4



CORDA VARAL PLAST 5MM 10 MTS 93002

Código: **45529** Fábrica: **WINMAX** Unidade: **UN/1**
F1 F4



CORDA VARAL POLIESTER 15 MTS UNIVERS 614

Código: **46871** Fábrica: **PLANETA** Unidade: **UN/1**
F1 F4

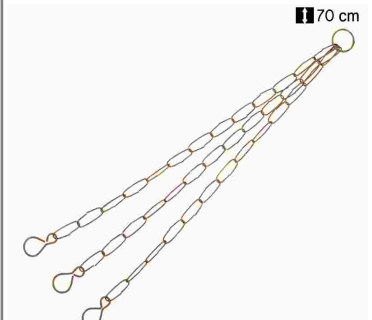

CORRENTAO METAL DOURADA XAXIM 70CM

Código: **39471** Fábrica: **WS CORRENTES** Unidade: **UN/1**
F1 F4



CORRENTAO METAL DOURADA XAXIM 70CM 12X1

Código: **39470** Fábrica: **WS CORRENTES** Unidade: **PT/12**
F1 F4



CORRENTE METAL DOURADA XAXIM 84CM 12X1

Código: **39472** Fábrica: **WS CORRENTES** Unidade: **PT/12**
F1 F4



CORTADOR INOX MELANCIA 25,5CM 3029

Código: **44730** Fábrica: **WINCY** Unidade: **UN/1**
F1 F4



CORTADOR INOX PASTEL CACIQUE 19,5CM 145

Código: **39356** Fábrica: **PLANETA** Unidade: **UN/1**
F1 F4

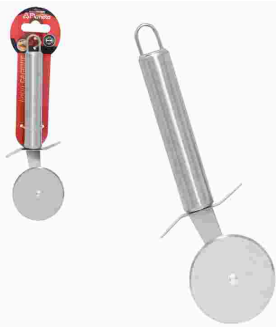

CORTADOR INOX PIZZA CACIQUE 20,5CM 146

Código: 39355 Fábrica: PLANETA Unidade: UN/1 F1 F4



CORTADOR INOX QUEIJO 22X7,5CM 147-103

Código: 47149 Fábrica: NICOBEM Unidade: UN/1 F1 F4

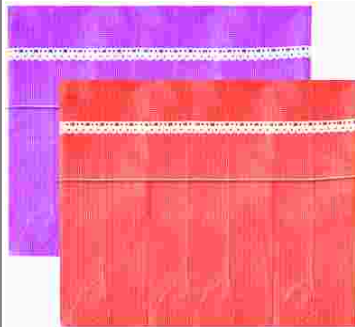

CORTINA P/PIA P 120X90CM

Código: 11294 Fábrica: FERREIRA Unidade: UN/1 F1 F4



CUMBUCA BARRO 300 ML RED

Código: 30157 Fábrica: AVELAR Unidade: UN/1 F4

06 cm
12 cm
300 ml



CUMBUCA BARRO 400 ML RED

Código: 36288 Fábrica: AVELAR Unidade: UN/1 F1 F4



CUMBUCA PLAST 500 ML OVAL 11X15CM 683

Código: 50343 Fábrica: QUALYPLAS Unidade: UN/1 F1 F4



CUMBUCA PLAST 650 ML COLOR 907

Código: 42762 Fábrica: LUMAR Unidade: UN/1 F1 F4



CUSCUZEIRO ALUM 14 1147

Código: 35271 Fábrica: MSR Unidade: UN/1 F1 F4



CUSCUZEIRO ALUM 16 668

Código: 35272 Fábrica: MSR Unidade: UN/1 F1 F4



CUSCUZEIRO ALUM 18 669

Código: 35273 Fábrica: MSR Unidade: UN/1 F1 F4



DEBULHADOR PLAST MILHO 11,5X7CM 3204

Código: 44724 Fábrica: WINCY Unidade: UN/1 F1 F4



DECORADOR PLAST P/BOLO C/8 BICOS 7139

Código: 38346 Fábrica: ALIANCA Unidade: UN/1 F1 F4

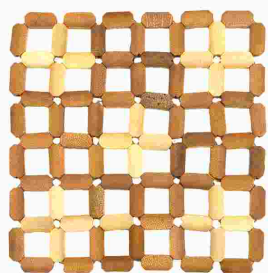

DESCANSO P/PANELAS BAMBU (ESTEIRA) 14752

Código: 44524 Fábrica: NICOBEM Unidade: UN/1 F1 F4



DESCASCADOR FATIAD INOX 25CM LEGUMES 063

Código: 47334 Fábrica: NIX Unidade: UN/1 F1 F4



DESCASCADOR MANUAL FRUTAS LEGUMES 147-57

Código: 46740 Fábrica: NICOBEM Unidade: UN/1 F1 F4



DESENTUPIDOR DE PIA SANFONADO 5033

Código: 47251 Fábrica: SHANGRILA Unidade: UN/1 F1 F4



DESENTUPIDOR SANITARIO WC 332

Código: 5544 Fábrica: N.HORIZONTE Unidade: UN/1 F1 F4



DISPENSADOR VIDRO 210ML ACUCAR 18394

Código: 40902 Fábrica: FUTURO Unidade: UN/1 F1 F4



DISPENSER INOX CILIND P/COPO AGUA 200ML

Código: 41851 Fábrica: AURIMAR Unidade: UN/1 F1 F4



28cm

DISPENSER PLAST PAPEL HIG ROLAO 300/500M

Código: 47834 Fábrica: NOBRE Unidade: UN/1 F1 F4



30cm

DISPENSER PLAST PAPEL TOALHA 1/3D 39999

Código: 47832 Fábrica: NOBRE Unidade: UN/1 F1 F4



62cm

DISPENSER PLAST POUPADOR COPO AGUA 200ML

Código: 47831 Fábrica: NOBRE Unidade: UN/1 F1 F4



25cm

DISPENSER PLAST SABONE LIQ/ALCOOL 800ML

Código: 47833 Fábrica: NOBRE Unidade: UN/1 F1 F4

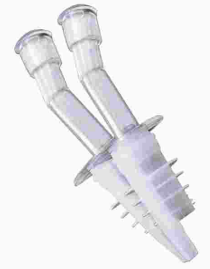

DOSADOR PLASTICO GARRAFA 707 2X1

Código: 27647 Fábrica: CLINK Unidade: PT/2 F1 F4



EBULIDOR ALUMINIO 127 V 1000W PEQ 101/WA

Código: 22827 Fábrica: IMC/RESIS Unidade: UN/1 F1 F4



EBULIDOR ALUMINIO 127 V 2000W GDE 103

Código: 27093 Fábrica: IMC/RESISWAL Unidade: UN/1 F1 F4



EBULIDOR ALUMINIO 220 V 1000W PEQ 104

Código: 26118 Fábrica: IMC/RESISWAL Unidade: UN/1 F1 F4



EBULIDOR ALUMINIO 220 V 2000W GDE GB

Código: 41653 Fábrica: IMC/RESISWAL Unidade: UN/1 F1 F4



EMBALAGEM C/ALCA P/MUDA PL 21 LTS PRETO

Código: 41374 Fábrica: NUTRIPLAN Unidade: UN/1 F1 F4



EMBALAGEM C/ALCA P/MUDA PL 33 LTS PRETO

Código: 41373 Fábrica: NUTRIPLAN Unidade: UN/1 F1 F4



EMBALAGEM C/ALCA P/MUDA PL 39 LTS PRETO

Código: 41375 Fábrica: NUTRIPLAN Unidade: UN/1 F1 F4



EMBALAGEM C/ALCA P/MUDA PL 40 LTS PRETO

Código: 41376 Fábrica: NUTRIPLAN Unidade: UN/1 F1 F4



EMBALAGEM C/ALCA P/MUDA PL 50 LTS PRETO
 Código: 41377 Fábrica: NUTRIPLAN Unidade: UN/1
 F1 F4



EMBALAGEM C/ALCA P/MUDA PL 60 LTS PRETO
 Código: 41378 Fábrica: NUTRIPLAN Unidade: UN/1
 F1 F4



EMBALAGEM C/ALCA P/MUDA PL 85 LTS PRETO
 Código: 41379 Fábrica: NUTRIPLAN Unidade: UN/1
 F1 F4



EMBALAGEM C/ALCA P/MUDA PL 110 LTS PTO
 Código: 41380 Fábrica: NUTRIPLAN Unidade: UN/1
 F1 F4

12 cm
 12 cm
 1 lts



EMBALAGEM P/MUDA PL 1 LT PRETO
 Código: 38912 Fábrica: NUTRIPLAN Unidade: UN/1
 F1 F4

Altura : 15 cm
 Larg : 18 cm



EMBALAGEM P/MUDA PL 2,8 LTS PRETO
 Código: 30320 Fábrica: NUTRIPLAN Unidade: UN/1
 F1 F4

Altura : 20 cm
 Larg : 20 cm



EMBALAGEM P/MUDA PL 5 LTS PRETO
 Código: 30318 Fábrica: NUTRIPLAN Unidade: UN/1
 F1 F4



EMBALAGEM P/MUDA PL 7 LTS PRETO
 Código: 41372 Fábrica: NUTRIPLAN Unidade: UN/1
 F1 F4

Altura : 22 cm
 Larg : 23 cm



EMBALAGEM P/MUDA PL 8 LTS PRETO
 Código: 30319 Fábrica: NUTRIPLAN Unidade: UN/1
 F1 F4

25cm
 25 cm
 10 lts



EMBALAGEM P/MUDA PL 10 LTS PRETO
 Código: 38915 Fábrica: NUTRIPLAN Unidade: UN/1
 F1 F4

24 cm
 27,5 cm



EMBALAGEM P/MUDA PL 11 LTS PRETO
 Código: 31389 Fábrica: NUTRIPLAN Unidade: UN/1
 F1 F4

28cm
 28 cm
 14.3 lts



EMBALAGEM P/MUDA PL 14,3 LTS PRETO
 Código: 38913 Fábrica: NUTRIPLAN Unidade: UN/1
 F1 F4

30 cm
 30 cm
 18 lts



EMBALAGEM P/MUDA PL 18 LTS PRETO
 Código: 33531 Fábrica: NUTRIPLAN Unidade: UN/1
 F1 F4

35cm
 34 cm
 25 lts



EMBALAGEM P/MUDA PL 25 LTS PRETO
 Código: 38914 Fábrica: NUTRIPLAN Unidade: UN/1
 F1 F4



EMBALAGEM P/MUDA PL 35 LTS PRETO
 Código: 41401 Fábrica: NUTRIPLAN Unidade: UN/1
 F1 F4



EMENDA PLAST MANGUEIRA SMART 212
 Código: 40239 Fábrica: MONTEREY Unidade: UN/1
 F1 F4



ENGATE RAPIDO PLAST MANGUEIRA 4X1 4092

Código: 50145 Fábrica: GP6 Unidade: CR/1 F1 F4



ESCORREDOR ACO INOX 18X10CM 9375

Código: 50219 Fábrica: CASITA Unidade: UN/1 F1 F4



ESCORREDOR ACO INOX 28X35X14CM 9376

Código: 50218 Fábrica: CASITA Unidade: UN/1 F1 F4



ESCORREDOR ALUM ARROZ 670

Código: 6733 Fábrica: MSR Unidade: UN/1 F1 F4



ESCORREDOR ALUM MACARRAO HOTEL 45

Código: 50168 Fábrica: MSR Unidade: UN/1 F1 F4



ESCORREDOR CROM PRAT/COP MEIA LUA 806

Código: 33913 Fábrica: ARAMINAS Unidade: UN/1 F1 F4



ESCORREDOR CROM PRAT/COP MINI 947

Código: 49960 Fábrica: ARAMINAS Unidade: UN/1 F1 F4



ESCORREDOR CROM PRAT/COP 2AND 39X25CM 31

Código: 24607 Fábrica: ARAMINAS Unidade: UN/1 F1 F4

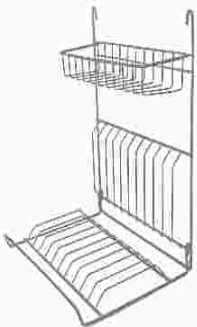

ESCORREDOR CROM PRATO PAREDE 563

Código: 28955 Fábrica: ARAMINAS Unidade: UN/1 F1 F4

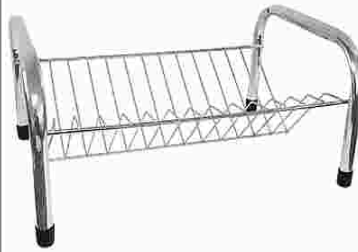

ESCORREDOR CROM PRATO SIMPLES 697

Código: 20174 Fábrica: ARAMINAS Unidade: UN/1 F1 F4



ESCORREDOR CROM PRATO/COPO 32 BAIXO41X32

Código: 24608 Fábrica: ARAMINAS Unidade: UN/1 F1 F4



ESCORREDOR CROM 2AND TUBULAR 30

Código: 40248 Fábrica: ARAMINAS Unidade: UN/1 F1 F4



ESCORREDOR PLAST ARROZ CORES 467

Código: 46642 Fábrica: QUALYPLAS Unidade: UN/1 F1 F4



ESCORREDOR PLAST ARROZ 5589

Código: 35485 Fábrica: TRITEC Unidade: UN/1 F1 F4

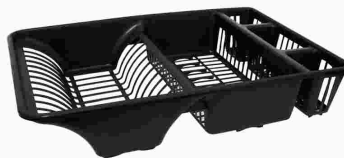

ESCORREDOR PLAST LOUCA PRETO 410

Código: 48378 Fábrica: PLASMARC Unidade: UN/1 F1 F4

46cm
19cm
32cm



ESCORREDOR PLAST MASSAS 0013

Código: 2675 Fábrica: JAGUAR Unidade: UN/1 F1 F4

11cm
30cm



ESCORREDOR PLAST MULTI USO C/ALCAS 987

Código: 46673 Fábrica: LUMAR Unidade: UN/1
F1 F4

10cm
48cm

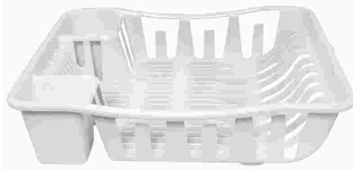

ESCORREDOR PLAST PRATO 503

Código: 35487 Fábrica: TRITEC Unidade: UN/1
F1 F4



ESCORREDOR PLAST PRATOS 16

Código: 2076 Fábrica: JAGUAR Unidade: UN/1
F1 F4

3 cm
39 cm
12,5cm



ESCORREDOR PLAST P/TINTA DE PINTURA

Código: 40076 Fábrica: MOLDE MINAS Unidade: UN/1
F1 F4



ESCOVA LAVAR ROUPA MAD OVAL MAX 4 12X1

Código: 28872 Fábrica: N.HORIZONTE Unidade: PT/12
F1 F4



ESCOVA LAVAR ROUPA MAD OVAL MED 3 12X1

Código: 7122 Fábrica: N.HORIZONTE Unidade: PT/12
F1 F4



ESCOVA LAVAR ROUPA MAD OVAL PEQ 5 12X1

Código: 34403 Fábrica: N.HORIZONTE Unidade: PT/12
F1 F4



ESCOVA LAVAR ROUPA MAD RET MED 26 12X1

Código: 28135 Fábrica: N.HORIZONTE Unidade: PT/12
F1 F4



ESCOVA LAVAR ROUPA MAD RET PEQ 12X1

Código: 36310 Fábrica: N.HORIZONTE Unidade: PT/12
F1 F4



ESCOVA LAVAR ROUPA MAD 16 MED 85175 12X1

Código: 6290 Fábrica: CONDOR Unidade: DZ/12
F1 F4



ESCOVA LAVAR ROUPA PLAST ANTIDERRAP UN

Código: 20137 Fábrica: N.HORIZONTE Unidade: UN/1
F1 F4



ESCOVA LAVAR ROUPA PLAST OVAL 25 12X1

Código: 22595 Fábrica: N.HORIZONTE Unidade: PT/12
F1 F4



ESCOVA LAVAR ROUPA UN

Código: 47255 Fábrica: SHANG/NHORIZ Unidade: UN/1
F1 F4



ESCOVA MAD P/SAPATO 6/287

Código: 28136 Fábrica: N.HORIZONTE Unidade: UN/1
F1 F4



ESCOVA PLAST LIMPEZA 15,5CM 1467

Código: 41542 Fábrica: ELITE Unidade: UN/1
F1 F4



ESCOVA P/ROUPA MAD RET MULTI USO 29/316

Código: 28873 Fábrica: N.HORIZONTE Unidade: UN/1
F1 F4



ESCOVA SANIT LAVATINA NYLON 12X1

Código: **29313** Fábrica: **N.HORIZONTE** Unidade: **DZ/12**
F1 F4



ESCOVA SANITARIA CB PLAST C/SUP AZUL 151

Código: **46865** Fábrica: **PLANETA** Unidade: **UN/1**
F1 F4



ESCOVA SANITARIA CB PLAST C/SUP BCO 150

Código: **41564** Fábrica: **PLANETA** Unidade: **UN/1**
F1 F4



ESCOVA SANITARIA CB PLAST C/SUP ROSA 152

Código: **46866** Fábrica: **PLANETA** Unidade: **UN/1**
F1 F4



ESCOVA SANITARIA CB PLAST C/SUORTE 2355

Código: **38001** Fábrica: **DALCIN** Unidade: **UN/1**
F1 F4



ESCUMADEIRA ACO INOX 25,5CM LAR 060

Código: **50101** Fábrica: **PLANETA** Unidade: **UN/1**
F1 F4



ESCUMADEIRA ALUM BATIDO 30CM 2644

Código: **45295** Fábrica: **MSR** Unidade: **UN/1**
F1 F4



ESCUMADEIRA ALUM FUNDIDO 30CM

Código: **29648** Fábrica: **AVELAR** Unidade: **UN/1**
F1 F4



ESCUMADEIRA ALUM 27CM INTEIRIC 2019 UN

Código: **48020** Fábrica: **COFAX** Unidade: **UN/1**
F1 F4



ESCUMADEIRA ALUM 28CM CB MAD 2001 UN

Código: **48036** Fábrica: **COFAX** Unidade: **UN/1**
F1 F4



ESCUMADEIRA CROM 01 CB MADEIRA 01 33

Código: **28964** Fábrica: **ARAMINAS** Unidade: **UN/1**
F1 F4

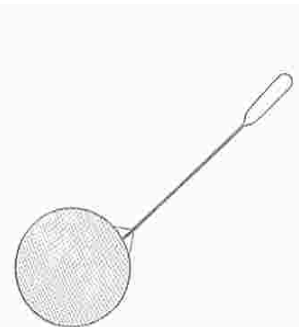

ESCUMADEIRA CROM 02 CB INTEIRICO 277

Código: **20177** Fábrica: **ARAMINAS** Unidade: **UN/1**
F1 F4



ESCUMADEIRA CROM 02 CB MADEIRA 34

Código: **28965** Fábrica: **ARAMINAS** Unidade: **UN/1**
F1 F4

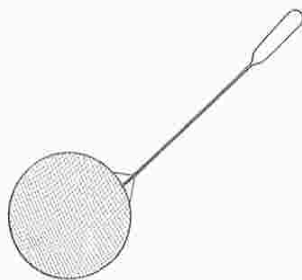

ESCUMADEIRA CROM 03 CB INTEIRICO 278

Código: **20178** Fábrica: **ARAMINAS** Unidade: **UN/1**
F1 F4



ESCUMADEIRA CROM 03 CB MADEIRA 35

Código: **28966** Fábrica: **ARAMINAS** Unidade: **UN/1**
F1 F4



ESCUMADEIRA CROM 04 CB INTEIRICO 279

Código: **29831** Fábrica: **ARAMINAS** Unidade: **UN/1**
F1 F4



ESCUMADEIRA CROM 04 CB MADEIRA 36
 Código: 28967 Fábrica: ARAMINAS Unidade: UN/1
 F1 F4



ESCUMADEIRA CROM 05 CB INTEIR INDST 189
 Código: 29832 Fábrica: ARAMINAS Unidade: UN/1
 F1 F4



ESCUMADEIRA CROM 05 CB MAD INDUST 05
 Código: 28968 Fábrica: ARAMINAS Unidade: UN/1
 F1 F4

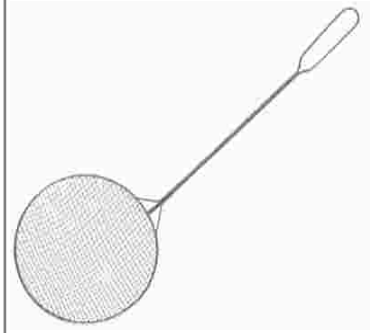

ESCUMADEIRA CROM 06 CB INTEI INDST 114
 Código: 12165 Fábrica: ARAMINAS Unidade: UN/1
 F1 F4



ESCUMADEIRA CROM 06 CB MAD INDST 38
 Código: 28969 Fábrica: ARAMINAS Unidade: UN/1
 F1 F4



ESCUMADEIRA INOX CACIQUE 33CM 138
 Código: 39352 Fábrica: PLANETA Unidade: UN/1
 F1 F4



ESCUMADEIRA NYLON BRANCA CB ACO 113-005
 Código: 41599 Fábrica: HERCULES Unidade: UN/1
 F1 F4



ESCUMADEIRA NYLON PRETO 28CM 1084
 Código: 37803 Fábrica: ENGIPLAST Unidade: UN/1
 F1 F4



ESCUMADEIRA NYLON 35CM CB CROMADO 66
 Código: 41350 Fábrica: HAUSKRAFT Unidade: UN/1
 F1 F4



ESCUMADEIRA PLAST 33CM COLOR 823
 Código: 41644 Fábrica: QUALYPLAS Unidade: UN/1
 F1 F4



ESCUMADEIRA SILICONE COLOR 29CM 17071
 Código: 33951 Fábrica: PRATIBELLA Unidade: UN/1
 F1 F4



ESGUICHO ADAP/CONEC/PISTOL MANGUEIR 1/2"
 Código: 50968 Fábrica: FBG Unidade: CR/1
 F1 F4



ESGUICHO PIST PLAST ADAPT MANGUEIR 1/2"
 Código: 49642 Fábrica: WINMAX Unidade: UN/1
 F1 F4



ESGUICHO PLAST ADAP/CONEC MANGUEIR 1/2"
 Código: 50966 Fábrica: IMPORIENTE Unidade: CR/1
 F1 F4



ESGUICHO PLAST ADAP/CONEC MANGUEIR 1/2"
 Código: 49643 Fábrica: WINMAX Unidade: UN/1
 F1 F4



ESPANADOR PENA 20 NOMO COLOR 100
 Código: 48401 Fábrica: SHANGRILA Unidade: UN/1
 F1 F4



ESPANADOR PENA 20 NOMO 86
 Código: 48399 Fábrica: SHANGRILA Unidade: UN/1
 F1 F4



ESPANADOR PENA 25 NOMO CLEAN 5844
 Código: 50196 Fábrica: SHANGRILA Unidade: UN/1
 F1 F4



ESPANADOR PENA 30 NOMO COLOR 101
 Código: 48402 Fábrica: SHANGRILA Unidade: UN/1
 F1 F4



ESPANADOR PENA 35 NOMO CLEAN 5718
 Código: 50195 Fábrica: SHANGRILA Unidade: UN/1
 F1 F4



ESPANADOR PENA 45 NOMO CLEAN 5719
 Código: 50194 Fábrica: SHANGRILA Unidade: UN/1
 F1 F4



ESPATULA ALUM FUNDIDO 30CM
 Código: 32524 Fábrica: AVELAR Unidade: UN/1
 F1 F4



ESPATULA BAMBU VAZADA 30CM CB COLOR 6025
 Código: 44737 Fábrica: WINCY Unidade: UN/1
 F1 F4



ESPATULA INOX P/BOLO 24CM CTL 1736
 Código: 15922 Fábrica: SIMONAGGIO Unidade: UN/1
 F1 F4



ESPATULA INOX P/BOLO 26CM 062
 Código: 46841 Fábrica: PLANETA Unidade: UN/1
 F1 F4



ESPATULA INOX RETA 24X12CM CB PLAST -25
 Código: 45292 Fábrica: NICOBEM Unidade: UN/1
 F1 F4



ESPATULA INOX 26,5CM P/BOLO 061
 Código: 47326 Fábrica: NIX Unidade: UN/1
 F1 F4



ESPATULA SILICONE CURVA VERMELH 24CM 328
 Código: 46870 Fábrica: PLANETA Unidade: UN/1
 F1 F4



ESPATULA SILICONE VAZADA 27CM PRETO 653
 Código: 50099 Fábrica: PLANETA Unidade: UN/1
 F1 F4



ESPATULA SILICONE VAZADA 27CM VERMEL 993
 Código: 50098 Fábrica: PLANETA Unidade: UN/1
 F1 F4



ESPATULA SILICONE VM CB ACO INOX 3094
 Código: 33820 Fábrica: GEDEX Unidade: UN/1
 F1 F4



ESPETO BAMBU CHURRASCO 25CM 24260 50X1
 Código: 47880 Fábrica: BOMPACK Unidade: PT/50
 F1 F4



ESPETO BAMBU CHURRASCO 30CM 24672 50X1
 Código: 44763 Fábrica: BOMPACK Unidade: PT/50
 F1 F4



ESPETO DUPLO 55 CM 02
 Código: 24059 Fábrica: ARAMINAS Unidade: UN/1
 F1 F4



ESPETO DUPLO 65 CM 03
 Código: 24060 Fábrica: ARAMINAS Unidade: UN/1
 F1 F4



ESPETO DUPLO 75 CM 04
 Código: 24061 Fábrica: ARAMINAS Unidade: UN/1
 F1 F4



ESPETO MAD CHURRASCO 18CM 64008 100X1
 Código: 41178 Fábrica: THEOTO Unidade: PT/100
 F1 F4

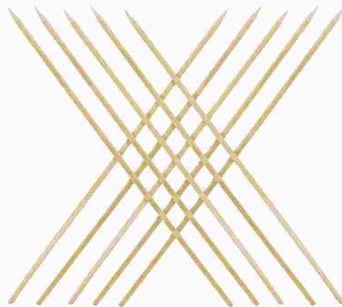

ESPETO MAD CHURRASCO 25CM 5000X1
 Código: 49693 Fábrica: ESTILO Unidade: CX/5000
 F1 F4



ESPETO MAD CHURRASCO 25CM 64021 100X1
 Código: 1938 Fábrica: THEOTO Unidade: PT/100
 F1 F4



ESPETO MAD CHURRASCO 25CM 80X1
 Código: 49694 Fábrica: ESTILO Unidade: CX/80
 F1 F4



ESPETO SIMPLES ACO ESTANHADO 55 CM 05
 Código: 12947 Fábrica: ARAMINAS Unidade: UN/1
 F1 F4



ESPETO SIMPLES ACO ESTANHADO 65 CM 06
 Código: 12948 Fábrica: ARAMINAS Unidade: UN/1
 F1 F4



ESPETO SIMPLES ACO ESTANHADO 75 CM 07
 Código: 12949 Fábrica: ARAMINAS Unidade: UN/1
 F1 F4



ESPETO SIMPLES ACO ESTANHADO 85 CM 0215
 Código: 40264 Fábrica: ARAMIG Unidade: UN/1
 F1 F4



ESPETO SIMPLES ACO ESTANHADO 85 CM 26
 Código: 44718 Fábrica: ARAMINAS Unidade: UN/1
 F1 F4

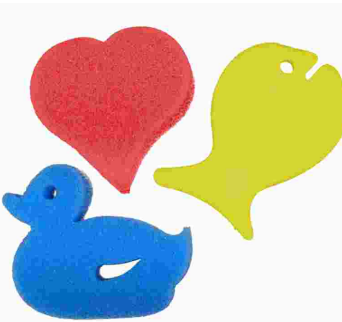

ESPUNJA BANHO INFANTIL UN
 Código: 44333 Fábrica: MC PANOS Unidade: UN/1
 F1 F4



ESPUNJA BANHO MASSAGADORA
 Código: 50150 Fábrica: MC PANOS Unidade: UN/1
 F1 F4



ESPUNJA LIMPEZA DUPLA FACE UN
 Código: 46436 Fábrica: NOBRE Unidade: UN/1
 F1 F4



ESPONJA LIMPEZA DUPLA FACE 3X1

Código: 50125
Fábrica: ESPONFLORA
Unidade: PT/3
F1 F4



ESPONJA MODELO LUVA P/LAVAR CARRO

Código: 11331
Fábrica: FERREIRA
Unidade: UN/1
F1 F4



ESPONJA P/LAVAR CARRO

Código: 11333
Fábrica: FERREIRA
Unidade: UN/1
F1 F4



Produto
* Altura: 90 cm
* Comp: 187 cm
* Largura: 70 cm

ESPREGUICADEIRA PITANGUI BRANCA

Código: 7749
Fábrica: ANTARES
Unidade: UN/1
F1 F4



18 cm

ESPREDADOR ALUM INTEIR ALHO BIG 2008 UN

Código: 48034
Fábrica: COFAX
Unidade: UN/1
F1 F4

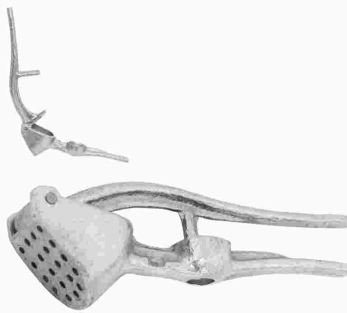

ESPREDADOR ALUM INTEIR ALHO 2F 2030 UN

Código: 48032
Fábrica: COFAX
Unidade: UN/1
F1 F4



7 cm
9 cm

ESPREDADOR PLAST LARANJA 13X09CM 3174

Código: 40311
Fábrica: WINCY
Unidade: UN/1
F1 F4



ESTACA P/PLANTA FIBRA DE COCO 60X5X5CM

Código: 30295
Fábrica: NUTRIPLAN
Unidade: UN/1
F1 F4



80cm

ESTACA P/PLANTA FIBRA DE COCO 80X5X5CM

Código: 30296
Fábrica: NUTRIPLAN
Unidade: UN/1
F1 F4



Produto
* Altura: 128 cm
* Largura: 75 cm

ESTANTE MODULAR 4 PRATELEIRAS PRETA

Código: 12899
Fábrica: ANTARES
Unidade: UN/1
F1 F4



ESTEIRA MADEIRA FIXA 25 CM IND 162

Código: 41323
Fábrica: MAD LAR
Unidade: UN/1
F1 F4



ESTEIRA MADEIRA G 25 CM 156

Código: 41321
Fábrica: MAD LAR
Unidade: UN/1
F1 F4

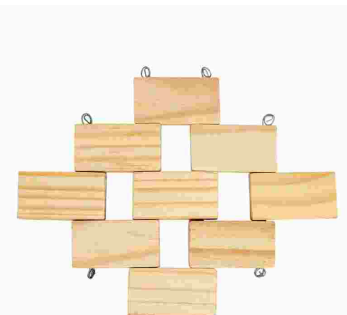

ESTEIRA MADEIRA M 20 CM 157

Código: 41322
Fábrica: MAD LAR
Unidade: UN/1
F1 F4



ESTERCO DE GALINHA 1 LITRO

Código: 48536
Fábrica: NOVATROPICAL
Unidade: PT/1
F1 F4



FACA INOX MESA LINHA AMERICA 2224 12X1

Código: 50621
Fábrica: STEEL
Unidade: PT/12
F1 F4

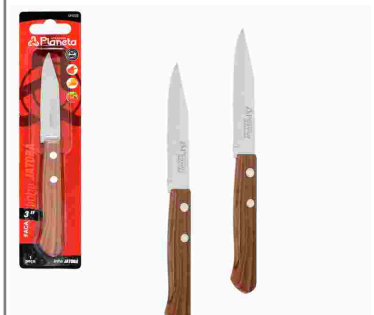

FACA ACO CARBONO 3" CB MAD LEGUMES 222

Código: 39348
Fábrica: PLANETA
Unidade: CR/1
F1 F4



23 cm

FACA ACO CARBONO 5" CB MAD 22950/5 12X1
 Código: 34848 Fábrica: TRAMONTINA Unidade: DZ/12 F1 F4



23 cm

FACA ACO CARBONO 5" CB MAD 22953/5 12X1
 Código: 34847 Fábrica: TRAMONTINA Unidade: DZ/12 F1 F4



29 cm

FACA ACO CARBONO 6" CB MAD 22953/6 12X1
 Código: 34850 Fábrica: TRAMONTINA Unidade: DZ/12 F1 F4



FACA ACO CARBONO 6" CB MAD 252
 Código: 39349 Fábrica: PLANETA Unidade: CR/1 F1 F4



26 cm

FACA ACO CARBONO 7" CB MAD 22953/7 12X1
 Código: 34849 Fábrica: TRAMONTINA Unidade: DZ/12 F1 F4



FACA ACO INOX 3" CB PLAST COZINHA 12X1
 Código: 36919 Fábrica: MABEL Unidade: CX/12 F1 F4



18 cm

FACA ACO INOX 3 1/4" CB PLAST LEGUMES
 Código: 36573 Fábrica: MUNDIAL Unidade: UN/1 F1 F4



FACA ACO INOX 5" CB MAD CHURRSACO 6X1
 Código: 46583 Fábrica: MUNDIAL Unidade: CX/6 F1 F4



FACA ACO INOX 5" CB PLAST BCO MAX 53
 Código: 50100 Fábrica: PLANETA Unidade: CR/1 F1 F4



FACA ACO INOX 5" CB PLAST BCO TOMATE
 Código: 46578 Fábrica: MUNDIAL Unidade: UN/1 F1 F4



FACA ACO INOX 5" CB PLAST PTO TOMATE
 Código: 47376 Fábrica: SIMONAGGIO Unidade: UN/1 F1 F4



30 cm

FACA ACO INOX 6" CB PLAST BCO CARNE 815
 Código: 36575 Fábrica: MUNDIAL Unidade: UN/1 F1 F4



FACA ACO INOX 6" CB PLAST BCO COZINHA
 Código: 37807 Fábrica: NICOBEM Unidade: UN/1 F1 F4



27 cm

FACA ACO INOX 6" CB PLAST BCO COZINHA31
 Código: 36576 Fábrica: MUNDIAL Unidade: UN/1 F1 F4



FACA ACO INOX 7" CB PLAST BCO COZINHA
 Código: 50953 Fábrica: HAI BRASIL Unidade: UN/1 F1 F4



FACA ACO INOX 7" CB PLAST BCO MAX 55
 Código: 47988 Fábrica: PLANETA Unidade: CR/1 F1 F4



FACA ACO INOX 7" CB PLAST PTO CARNE 107
 Código: **46577** Fábrica: **MUNDIAL** Unidade: **UN/1**
F1 F4

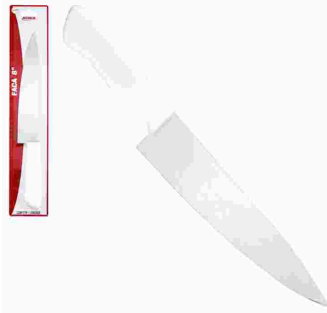

FACA ACO INOX 8" CB PLAST BCO COZINHA
 Código: **46492** Fábrica: **NICOBEM** Unidade: **UN/1**
F1 F4



FACA ACO INOX 8" CB PLAST BCO COZINHA
 Código: **50945** Fábrica: **HAI BRASIL** Unidade: **UN/1**
F1 F4



FACA ACO INOX 8" CB PLAST BCO COZINHA31
 Código: **36579** Fábrica: **MUNDIAL** Unidade: **UN/1**
F1 F4



FACA ACO INOX 8" PAO CB PLAST BCO MAX57
 Código: **47989** Fábrica: **PLANETA** Unidade: **CR/1**
F1 F4



FACA ACO INOX 9" CB PLAST BCO COZINHA
 Código: **50952** Fábrica: **HAI BRASIL** Unidade: **UN/1**
F1 F4



FACA ACO INOX 10" CB PLAST BCO CARNE 781
 Código: **36581** Fábrica: **MUNDIAL** Unidade: **UN/1**
F1 F4



FACA ACO INOX 10" CB PLAST BCO CARNE 820
 Código: **36582** Fábrica: **MUNDIAL** Unidade: **UN/1**
F1 F4



FACA ACO 7" PAO CB PLAST PRETO 6013
 Código: **44645** Fábrica: **MART/SIMONAG** Unidade: **UN/1**
F1 F4



FACA INOX 5" CB PLAST BCO COZINHA 3186
 Código: **49646** Fábrica: **WINMAX** Unidade: **UN/1**
F1 F4



FACA INOX 6" CB PLAST BCO COZINHA 3187
 Código: **49647** Fábrica: **WINMAX** Unidade: **UN/1**
F1 F4



FACA INOX 7" CB PLAST BCO COZINHA 3188
 Código: **49648** Fábrica: **WINMAX** Unidade: **UN/1**
F1 F4



FACA INOX CHURR 20CM VERSA AZ 731 12X1
 Código: **50162** Fábrica: **PLANETA** Unidade: **DZ/12**
F1 F4



FACA INOX KIT C/3 PLENUS CB PLAS BCO 312
 Código: **40391** Fábrica: **TRAMONTINA** Unidade: **CR/1**
F1 F4



FACA INOX KIT C/3 PLENUS CB PLAS PTO 612
 Código: **40390** Fábrica: **TRAMONTINA** Unidade: **CR/1**
F1 F4

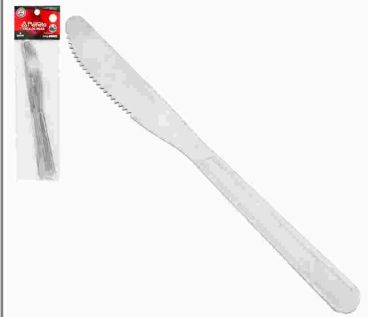

FACA INOX MESA LINHA BRONZE 517 3X1
 Código: **48008** Fábrica: **PLANETA** Unidade: **PT/3**
F1 F4



FAÇA INOX 3PCS CB PLAST GOLDEN DARK 106
 Código: 41348 Fábrica: HAUSKRAFT Unidade: CJ/1 F1 F4



FAÇA INOX 3,5" LINH MAX LEGUMES CB BC52
 Código: 47629 Fábrica: PLANETA Unidade: CR/1 F1 F4



FAÇA INOX 3,5" LINH MERCOSU LEGUMES 234
 Código: 46868 Fábrica: PLANETA Unidade: CR/1 F1 F4



FAÇA INOX 6" CB PLAST P/DEOSSAR 5421
 Código: 43277 Fábrica: MAGAGIFT Unidade: CR/1 F1 F4



FAÇA INOX 7" CB MAD JATOBA CTL 225
 Código: 48692 Fábrica: PLANETA Unidade: CR/1 F1 F4



FAÇA INOX 7" CB PLAST PROFISSIONAL 5423
 Código: 43278 Fábrica: MAGAGIFT Unidade: CR/1 F1 F4



FAÇA INOX 8" CB MAD JATOBA CTL 226
 Código: 48693 Fábrica: PLANETA Unidade: CR/1 F1 F4



FAÇA PEIXEIRA ACO CARBONO 5" CB MAD 319
 Código: 44641 Fábrica: SIMONAGGIO Unidade: UN/1 F1 F4



FAÇA PEIXEIRA ACO CARBONO 7" CB MAD 321
 Código: 47375 Fábrica: SIMONAGGIO Unidade: UN/1 F1 F4



FAÇA PEIXEIRA ACO CARBONO 8" CB MAD 322
 Código: 44642 Fábrica: SIMONAGGIO Unidade: UN/1 F1 F4



FAÇA PEIXEIRA ACO 7" CB PLAST VM 321007
 Código: 44644 Fábrica: SIMONAGGIO Unidade: UN/1 F1 F4



FAÇA ACO INOX 10" CB MAD 117
 Código: 45531 Fábrica: WINMAX Unidade: UN/1 F1 F4



FAQUEIRO 12 PCS CB PLAST COLOR 80
 Código: 41064 Fábrica: TAGLIATORI Unidade: CJ/12 F1 F4



FAQUEIRO 16 PCS CB PLAST COLOR 318
 Código: 41065 Fábrica: TAGLIATORI Unidade: CJ/16 F1 F4



FAQUEIRO 20 PCS CB PLAST COLOR 313
 Código: 41063 Fábrica: TAGLIATORI Unidade: CJ/20 F1 F4

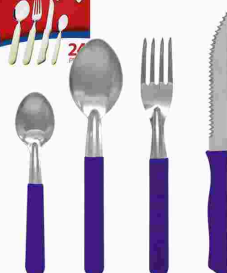

FAQUEIRO 24 PCS CB PLAST COLOR 115
 Código: 41062 Fábrica: TAGLIATORI Unidade: CJ/24 F1 F4



FAQUEIRO 24 PCS INOX 4829

Código: 49759
Fábrica: SQ
Unidade: CJ/24
F1 F4



FAQUEIRO 25 PCS CB PLAST BCO PORTA TALHE

Código: 41337
Fábrica: HAUSKRAFT
Unidade: CJ/16
F1 F4



FAQUEIRO 25 PCS CB PLAST PTO PORTA TALHE

Código: 41338
Fábrica: HAUSKRAFT
Unidade: CJ/16
F1 F4



FAQUEIRO 25 PCS CB PLAST VM PORTA TALHE

Código: 41339
Fábrica: HAUSKRAFT
Unidade: CJ/16
F1 F4



FARINHEIRO PLAST 800 ML LEITOSO 21

Código: 40374
Fábrica: FORMPLAST
Unidade: UN/1
F1 F4



FATIADOR INOX PIZZA 18,9CM 8178

Código: 44729
Fábrica: WINCY
Unidade: UN/1
F1 F4



FERRAMENTA ACO CB PLAST JARDIM 2X1 74307

Código: 49599
Fábrica: ALMEGA
Unidade: CJ/1
F1 F4



FERRAMENTA ESPATULA METAL CB PLAST 3080

Código: 38453
Fábrica: FENIMA
Unidade: UN/1
F1 F4



FERRAMENTA PLAST ARRANCADOR 28,6CM VERDE

Código: 47609
Fábrica: NUTRIPLAN
Unidade: UN/1
F1 F4



FERRAMENTA PLAST KIT RAST/PA/ARRAN VERDE

Código: 47610
Fábrica: NUTRIPLAN
Unidade: CJ/4
F1 F4



FERRAMENTA PLAST PAZINHA ESTR 28CM VERDE

Código: 47608
Fábrica: NUTRIPLAN
Unidade: UN/1
F1 F4



FERRAMENTA PLAST PAZINHA 27,5CM VERDE

Código: 47607
Fábrica: NUTRIPLAN
Unidade: UN/1
F1 F4



FERRAMENTA PLAST RATEIO 24CM VERDE

Código: 47606
Fábrica: NUTRIPLAN
Unidade: UN/1
F1 F4



FERRAMENTA TESOURA P/PODA 46CM AIH1239

Código: 42465
Fábrica: AIH
Unidade: UN/1
F1 F4



FERRAMENTA TESOURA P/PODA 8" CTL 9165T

Código: 40077
Fábrica: IDEA
Unidade: UN/1
F1 F4



FERTILIZANTE CACTOS SUCULENTAS 150GRS CX

Código: 33547
Fábrica: VITAPLAN
Unidade: CX/1
F1 F4



FERTILIZANTE COMP ORGANICO JAPONES 800G
 Código: 39213 Fábrica: VITAPLAN Unidade: CX/1
 F1 F4



FERTILIZANTE FARINHA DE OSSO 1KG C/CX
 Código: 30303 Fábrica: VITAPLAN Unidade: CX/1
 F1 F4



FERTILIZANTE NUTRIFLORES 250 GRS POTE
 Código: 39653 Fábrica: VITAPLAN Unidade: CX/1
 F1 F4



FERTILIZANTE NUTRIFLORES 500 GRS POTE
 Código: 39212 Fábrica: VITAPLAN Unidade: CX/1
 F1 F4



FERTILIZANTE NUTRIFRUTAS 600 GRS POTE
 Código: 49345 Fábrica: VITAPLAN Unidade: CX/1
 F1 F4



FERTILIZANTE NUTRIPLANTAS 250 GRS POTE
 Código: 44136 Fábrica: VITAPLAN Unidade: CX/1
 F1 F4



FERTILIZANTE NUTRIPLANTAS 500 GRS POTE
 Código: 44132 Fábrica: VITAPLAN Unidade: UN/1
 F1 F4



FERTILIZANTE NUTRIVERDE 250 GRS POTE
 Código: 39654 Fábrica: VITAPLAN Unidade: CX/1
 F1 F4



FERTILIZANTE NUTRIVERDE 500 GRS POTE
 Código: 23212 Fábrica: VITAPLAN Unidade: CX/1
 F1 F4



FERTILIZANTE NUTRIVERDE 600 GRS POTE
 Código: 49344 Fábrica: VITAPLAN Unidade: CX/1
 F1 F4



FERTILIZANTE ORQUIDEAS 150 GRS C/CX
 Código: 22292 Fábrica: VITAPLAN Unidade: UN/1
 F1 F4



FERTILIZANTE SAMAMBAIAS 150 GRS
 Código: 22291 Fábrica: VITAPLAN Unidade: CX/1
 F1 F4



FERTILIZANTE TORTA MAMONA +FARIN OSSO 1K
 Código: 30301 Fábrica: VITAPLAN Unidade: CX/1
 F1 F4



FERTILIZANTE VIOLETA 150 GR
 Código: 22290 Fábrica: VITAPLAN Unidade: CX/1
 F1 F4

11,5 cm
8,5 cm



FERTILIZANTE 04-14-08 1 KG C/CX
 Código: 22294 Fábrica: VITAPLAN Unidade: UN/1
 F1 F4



FERTILIZANTE 04-14-08 1 KG SACO
 Código: 30800 Fábrica: FAZENDEIRO Unidade: KG/1
 F1 F4



FERTILIZANTE 04-14-08 1 KG SACO
 Código: 30297 Fábrica: VITAPLAN Unidade: UN/1
 F1 F4

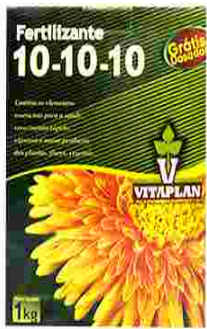

FERTILIZANTE 10-10-10 1 KG C/CX
 Código: 22293 Fábrica: VITAPLAN Unidade: UN/1
 F1 F4



FERTILIZANTE 10-10-10 1 KG SACO
 Código: 30298 Fábrica: VITAPLAN Unidade: UN/1
 F1 F4



FERVEDOR ALUM LEVE 14 C/ TAMP 1,7 LTS
 Código: 5895 Fábrica: AVELAR Unidade: UN/1
 F1 F4



FILME PVC TRANSP 25CMX15M 21752
 Código: 50077 Fábrica: BOMPACK Unidade: RL/1
 F1 F4



FILME PVC TRANSP 28CMX100M 23263
 Código: 50078 Fábrica: BOMPACK Unidade: RL/1
 F1 F4



FILTRA OLEO ALUM LEVE 1 1,0 LT
 Código: 36286 Fábrica: AVELAR Unidade: UN/1
 F1 F4



FILTRA OLEO ALUMINIO 12 673
 Código: 24782 Fábrica: MSR Unidade: UN/1
 F1 F4



FILTRO COADOR INOX P/CAFE 103 4380
 Código: 49758 Fábrica: SQ Unidade: UN/1
 F1 F4



FILTRO PERMANENTE P/ COAR CAFE 102 12X1
 Código: 27442 Fábrica: FERREIRA Unidade: DZ/12
 F1 F4



FILTRO PERMANENTE P/ COAR CAFE 103 12X1
 Código: 27443 Fábrica: FERREIRA Unidade: DZ/12
 F1 F4



FLANELA BRANCA 28X38 CM 12X1
 Código: 34897 Fábrica: MC PANOS Unidade: PT/12
 F1 F4



FLANELA BRANCA 36X56CM 12X1
 Código: 34501 Fábrica: P & F Unidade: PT/12
 F1 F4



FLANELA COLOR 38X58 CM 12X1
 Código: 42841 Fábrica: MC PANOS Unidade: PT/12
 F1 F4



FLANELA MICROFIBRA 50X70 CM COLOR
 Código: 44155 Fábrica: MC PANOS Unidade: UN/1
 F1 F4



FORMA ALUM BOLO ALTA 01 1966
 Código: 37514 Fábrica: MSR Unidade: UN/1
 F1 F4



FORMA ALUM BOLO ALTA 02 1967

Código: **37515** Fábrica: **MSR** Unidade: **UN/1**
F1 F4



FORMA ALUM BOLO ALTA 03 1968

Código: **37516** Fábrica: **MSR** Unidade: **UN/1**
F1 F4



FORMA ALUM CB MAD BAURUTEX OVAL 2014 UN

Código: **48073** Fábrica: **COFAX** Unidade: **UN/1**
F1 F4



FORMA ALUM EMPADA CRESPA 2 009 CTL 12X1

Código: **41356** Fábrica: **WESTERN** Unidade: **CR/12**
F1 F4



FORMA ALUM EMPADA LISA 0 12X1

Código: **36896** Fábrica: **MABEL** Unidade: **DZ/12**
F1 F4



FORMA ALUM EMPADA LISA 00 12X1

Código: **44386** Fábrica: **DAMIAO** Unidade: **DZ/12**
F1 F4



FORMA ALUM EMPADA LISA 1 CTL 011 12X1

Código: **41357** Fábrica: **WESTERN** Unidade: **CR/12**
F1 F4



FORMA ALUM EMPADA LISA 1 12X1

Código: **44388** Fábrica: **DAMIAO** Unidade: **DZ/12**
F1 F4



FORMA ALUM EMPADA LISA 2 CTL 012 12X1

Código: **41355** Fábrica: **WESTERN** Unidade: **CR/12**
F1 F4



FORMA ALUM EMPADA LISA 2 12X1

Código: **44389** Fábrica: **DAMIAO** Unidade: **DZ/12**
F1 F4



FORMA ALUM EMPADA LISA 3 12X1

Código: **44390** Fábrica: **DAMIAO** Unidade: **DZ/12**
F1 F4



FORMA ALUM EMPADA LISA 3 6X1

Código: **41448** Fábrica: **MABEL** Unidade: **PT/6**
F1 F4



FORMA ALUM EMPADA LISA 4 12X1

Código: **44391** Fábrica: **DAMIAO** Unidade: **DZ/12**
F1 F4



FORMA ALUM EMPADA LISA 5 12X1

Código: **44392** Fábrica: **DAMIAO** Unidade: **DZ/12**
F1 F4



FORMA ALUM EMPADA LISA 6 12X1

Código: **25554** Fábrica: **DAMIAO** Unidade: **DZ/12**
F1 F4



FORMA ALUM EMPADA LISA 7 12X1

Código: **38505** Fábrica: **DAMIAO** Unidade: **DZ/12**
F1 F4



FORMA ALUM FDO REMOV 23/26/28CM 710 3X1
 Código: 41250 Fábrica: 123UTIL Unidade: CX/3
 F1 F4



FORMA ALUM LEVE PIZZA 30
 Código: 5900 Fábrica: AVELAR Unidade: UN/1
 F1 F4



FORMA ALUM LEVE PUDIM 18
 Código: 27867 Fábrica: AVELAR Unidade: UN/1
 F1 F4



FORMA ALUM LEVE TORTA 24
 Código: 5901 Fábrica: AVELAR Unidade: UN/1
 F1 F4



FORMA ALUM PAO 01 1253
 Código: 37256 Fábrica: MSR Unidade: UN/1
 F1 F4



FORMA ALUM PAO 02 1254
 Código: 37255 Fábrica: MSR Unidade: UN/1
 F1 F4



FORMA ALUM PAO 03 1255
 Código: 37448 Fábrica: MSR Unidade: UN/1
 F1 F4



FORMA ALUM PIZZA MINI 12 CM 696
 Código: 37528 Fábrica: MSR Unidade: UN/1
 F1 F4



FORMA ALUM PIZZA 25 1229
 Código: 35274 Fábrica: MSR Unidade: UN/1
 F1 F4



FORMA ALUM PIZZA 30 675
 Código: 25308 Fábrica: MSR Unidade: UN/1
 F1 F4



FORMA ALUM PIZZA 35 674
 Código: 20736 Fábrica: MSR Unidade: UN/1
 F1 F4



FORMA ALUM POLIDO 22 BOLO VITORIA
 Código: 48127 Fábrica: ALEGRETE Unidade: UN/1
 F1 F4



FORMA ALUM PUDIM 12 MINI 1955
 Código: 37524 Fábrica: MSR Unidade: UN/1
 F1 F4



FORMA ALUM PUDIM 16 679
 Código: 24364 Fábrica: MSR Unidade: UN/1
 F1 F4



FORMA ALUM PUDIM 18 680
 Código: 24363 Fábrica: MSR Unidade: UN/1
 F1 F4



FORMA ALUM PUDIM 20 681
 Código: 24362 Fábrica: MSR Unidade: UN/1
 F1 F4



FORMA ALUM PUDIM 22 682

Código: **24361** Fábrica: **MSR** Unidade: **UN/1**
F1 F4



FORMA ALUM PUDIM 26 1969

Código: **37522** Fábrica: **MSR** Unidade: **UN/1**
F1 F4



FORMA ALUM TORTA 25 676

Código: **8236** Fábrica: **MSR** Unidade: **UN/1**
F1 F4



FORMA ALUM TORTA 30 677

Código: **22730** Fábrica: **MSR** Unidade: **UN/1**
F1 F4



FORMA ALUM TORTA 35 678

Código: **8238** Fábrica: **MSR** Unidade: **UN/1**
F1 F4

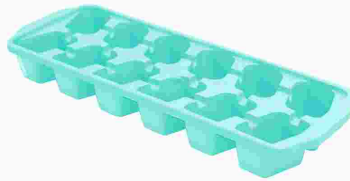

FORMA PLAST GELO COLOR 151

Código: **12666** Fábrica: **FORMPLAST** Unidade: **UN/1**
F1 F4

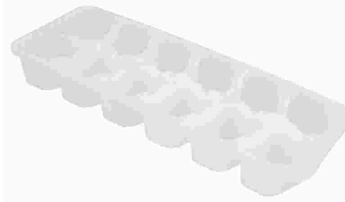

FORMA PLAST GELO TRANSP FAFILLITA 6211

Código: **20713** Fábrica: **RISCHIOTO** Unidade: **UN/1**
F1 F4

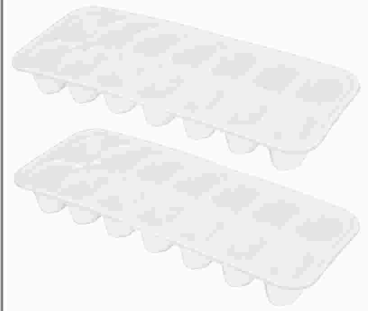

FORMA PLAST GELO 3105 2X1

Código: **47056** Fábrica: **JAGUAR** Unidade: **CJ/2**
F1 F4

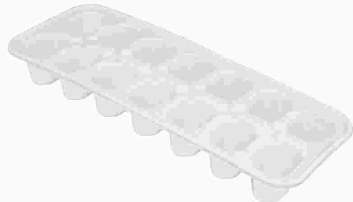

FORMA PLAST GELO 615

Código: **9986** Fábrica: **JAGUAR** Unidade: **UN/1**
F1 F4



FORMA PLAST GELO 6626 2X1

Código: **22501** Fábrica: **INPLAST** Unidade: **CJ/2**
F1 F4

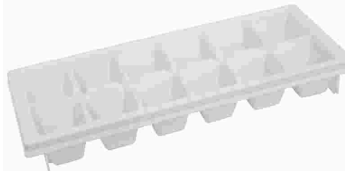

FORMA PLAST P/GELO 502

Código: **35497** Fábrica: **TRITEC** Unidade: **UN/1**
F1 F4



FORMINHA INOX CORTADOR COOKIE 12X1

Código: **40525** Fábrica: **MINGJIAN** Unidade: **DZ/12**
F1 F4



FORRO MESA LAMINADO 50M 614 0,10MM CRIST

Código: **39358** Fábrica: **PERFETTO** Unidade: **RL/1**
F1 F4



FORRO MESA LAMINADO 50M 617 CRISTAL OUTO

Código: **39359** Fábrica: **PERFETTO** Unidade: **RL/1**
F1 F4

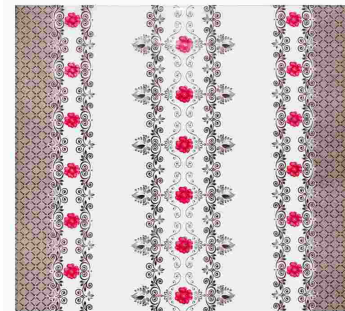

FORRO MESA LAMINADO 50M 619 CRISTAL HIBI

Código: **39360** Fábrica: **PERFETTO** Unidade: **RL/1**
F1 F4

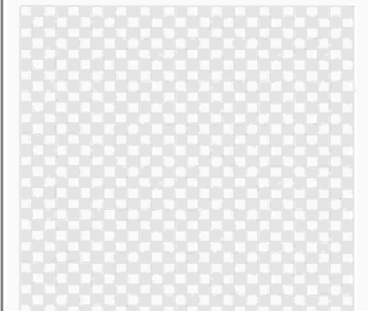

FORRO MESA LAMINADO 50M 623 CRISTAL XADR

Código: **39964** Fábrica: **PERFETTO** Unidade: **RL/1**
F1 F4

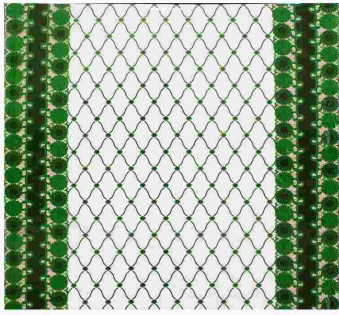

FORRO MESA LAMINADO 50M 626 CRISTAL FLOX
 Código: 39963 Fábrica: PERFETTO Unidade: RL/1
 F1 F4

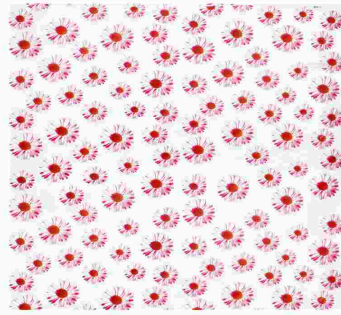

FORRO MESA LAMINADO 50M 659 CRISTAL MARG
 Código: 39361 Fábrica: PERFETTO Unidade: RL/1
 F1 F4

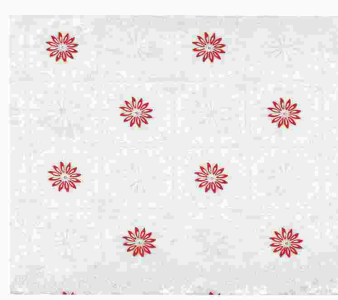

FORRO MESA LAMINADO 50M 663 CRISTAL FLOR
 Código: 39362 Fábrica: PERFETTO Unidade: RL/1
 F1 F4

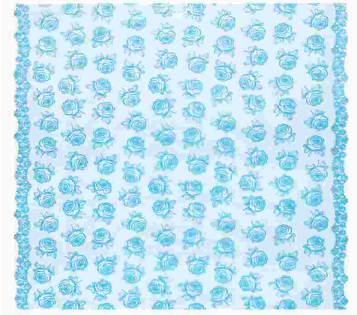

FORRO MESA LAMINADO 50M 665 CRISTAL ROSA
 Código: 44661 Fábrica: PERFETTO Unidade: RL/1
 F1 F4

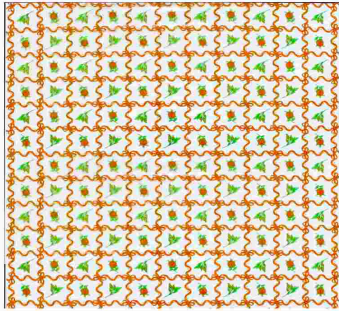

FORRO MESA LAMINADO 50M 669 CRISTAL FLOR
 Código: 44659 Fábrica: PERFETTO Unidade: RL/1
 F1 F4

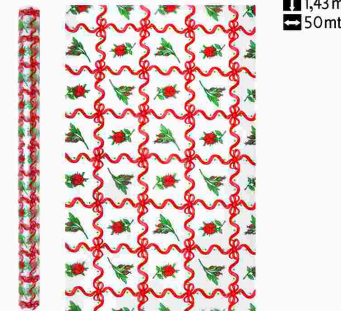

FORRO MESA LAMINADO 50M 670 CRISTAL LACO
 Código: 39363 Fábrica: PERFETTO Unidade: RL/1
 F1 F4

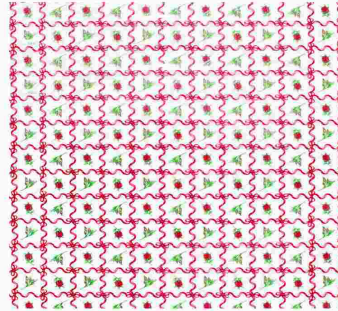

FORRO MESA LAMINADO 50M 670/1 XAD VERMEL
 Código: 48662 Fábrica: PERFETTO Unidade: RL/1
 F1 F4



FORRO MESA LAMINADO 50M 694 0,15MM CRIST
 Código: 42507 Fábrica: PERFETTO Unidade: RL/1
 F1 F4



FORRO MESA PEQ TERMICO 1,40X1,40CM T
 Código: 14558 Fábrica: FERREIRA Unidade: UN/1
 F1 F4



FORRO MESA TERMICO 30M 902 FLORAL ROSAS
 Código: 39365 Fábrica: PERFETTO Unidade: RL/30
 F1 F4



FORRO MESA TERMICO 30M 912 FLORAL MARIA
 Código: 39366 Fábrica: PERFETTO Unidade: RL/30
 F1 F4



FORRO MESA TERMICO 30M 1024 PONTO CRUZ M
 Código: 40814 Fábrica: PERFETTO Unidade: RL/30
 F1 F4



FORRO MESA TERMICO 30M 1107 VASO CORACAO
 Código: 40815 Fábrica: PERFETTO Unidade: RL/30
 F1 F4



FORRO MESA TERMICO 30M 1113 CAFE JADE
 Código: 40816 Fábrica: PERFETTO Unidade: RL/30
 F1 F4



FORRO MESA TERMICO 30M 1114 CAFE HOTENSI
 Código: 42504 Fábrica: PERFETTO Unidade: RL/30
 F1 F4



FORRO MESA TERMICO 30M 1115 GIRASSOL MAR
 Código: 40817 Fábrica: PERFETTO Unidade: RL/30
 F1 F4



FORRO MESA TERMICO 30M 1121 BANANEIRA PI
 Código: 42498 Fábrica: PERFETTO Unidade: RL/30
 F1 F4



FORRO MESA TERMICO 30M 1125 3 ESTACOES
 Código: 42494 Fábrica: PERFETTO Unidade: RL/30
 F1 F4



FORRO MESA TERMICO 30M 1128 LISTR HORTEN
 Código: 44658 Fábrica: PERFETTO Unidade: RL/30
 F1 F4



FORRO MESA TERMICO 30M 1133 BARRAD RENDA
 Código: 47098 Fábrica: PERFETTO Unidade: RL/30
 F1 F4



FORRO MESA TERMICO 30M 1137 RENDA AZULEJ
 Código: 47096 Fábrica: PERFETTO Unidade: RL/30
 F1 F4

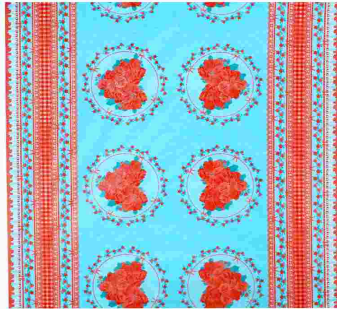

FORRO MESA TERMICO 30M 1172 BUQUE FLORAL
 Código: 47100 Fábrica: PERFETTO Unidade: RL/30
 F1 F4

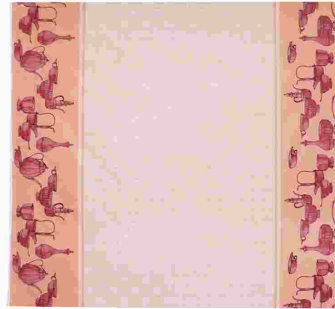

FORRO MESA TERMICO 30M 1176 JARRO TERRAC
 Código: 39966 Fábrica: PERFETTO Unidade: RL/30
 F1 F4



FORRO PAPEL P/AIR FRYER QUAD 130G 50X1
 Código: 45908 Fábrica: WINMAX Unidade: PT/50
 F1 F4



FORRO PAPEL P/AIR FRYER RED 111G 50X1
 Código: 45907 Fábrica: WINMAX Unidade: PT/50
 F1 F4



FRASCO PLAST 200 ML C/TAMPA (GARRAFA)
 Código: 51074 Fábrica: DECOPLAST Unidade: UN/1
 F1 F4



FRASCO PLAST 300 ML C/TAMPA (GARRAFA)
 Código: 40505 Fábrica: ARBRA Unidade: UN/1
 F1 F4



FRIGIDEIRA ALUM EXTRA FORTE 20 683
 Código: 8490 Fábrica: MSR Unidade: UN/1
 F1 F4



FRIGIDEIRA ALUM EXTRA FORTE 22 684
 Código: 8241 Fábrica: MSR Unidade: UN/1
 F1 F4



FRIGIDEIRA ALUM FRANCESA 18 PRIME 1557
 Código: 45291 Fábrica: MSR Unidade: UN/1
 F1 F4



FRIGIDEIRA ALUM FRANCESA 20 PRIME 1560
 Código: 45287 Fábrica: MSR Unidade: UN/1
 F1 F4



FRIGIDEIRA ALUM FRANCESA 22 ANTI IN 2547
 Código: 45286 Fábrica: MSR Unidade: UN/1
 F1 F4



FRIGIDEIRA ALUM FRANCESA 22 PRIME 1563
 Código: 45290 Fábrica: MSR Unidade: UN/1
 F1 F4



FRIGIDEIRA ALUM FRANCESA 24 ANTI IN 2548
 Código: 45285 Fábrica: MSR Unidade: UN/1
 F1 F4



FRIGIDEIRA ALUM FRANCESA 24 PRIME 1566
 Código: 45289 Fábrica: MSR Unidade: UN/1
 F1 F4



FRIGIDEIRA ALUM LEVE 16 685
 Código: 35268 Fábrica: MSR Unidade: UN/1
 F1 F4



FRIGIDEIRA ALUM LEVE 20 S/TAMPA 1,3LTS
 Código: 5898 Fábrica: AVELAR Unidade: UN/1
 F1 F4



FRIGIDEIRA ALUM 34 TOP QUALI FRANC CINZA
 Código: 48121 Fábrica: ALEGRETE Unidade: UN/1
 F1 F4



FRITURAMA CROM P/FRIGIDEIRA 116
 Código: 28963 Fábrica: ARAMINAS Unidade: UN/1
 F1 F4



FRITURAMA CROM REDONDA 15 42
 Código: 28970 Fábrica: ARAMINAS Unidade: UN/1
 F1 F4



FRITURAMA CROM REDONDA 20 43
 Código: 28971 Fábrica: ARAMINAS Unidade: UN/1
 F1 F4

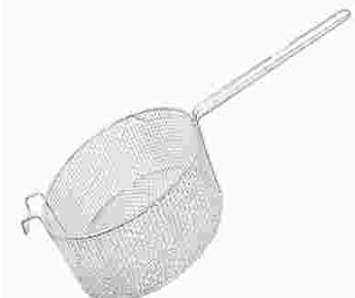

FRITURAMA CROM REDONDA 25 44
 Código: 28972 Fábrica: ARAMINAS Unidade: UN/1
 F1 F4



FRITURAMA CROM REDONDA 30 45
 Código: 28973 Fábrica: ARAMINAS Unidade: UN/1
 F1 F4



FRUTEIRA CROM DE MESA 367
 Código: 28956 Fábrica: ARAMINAS Unidade: UN/1
 F1 F4



FRUTEIRA CROM RED 1 ANDAR 2378
 Código: 40250 Fábrica: ARAMIG Unidade: UN/1
 F1 F4



FRUTEIRA CROM RED 2 ANDARES 2377
 Código: 40245 Fábrica: ARAMIG Unidade: UN/1
 F1 F4



FRUTEIRA REF 119 32 CM
 Código: 12128 Fábrica: PARAMOUNT Unidade: UN/1
 F1 F4



FUMO P/PLANTA LIQUIDO 500 ML
 Código: 30300 Fábrica: VITAPLAN Unidade: UN/1
 F1 F4



FUMO P/PLANTA PO 400 GRS
 Código: **30299** Fábrica: **VITAPLAN** Unidade: **CX/1**
F1 F4



FUNIL PLAST 10 CM DIAM 5016 12X1
 Código: **15315** Fábrica: **SBRISSA** Unidade: **DZ/12**
F1 F4



FUNIL PLAST 12,5X25CM C/PENEIRA 0621
 Código: **44505** Fábrica: **PLANETA** Unidade: **UN/1**
F1 F4



FUNIL PLAST 15 CM DIAM C/PENEIRA 0622
 Código: **44504** Fábrica: **PLANETA** Unidade: **UN/1**
F1 F4



FUNIL PLAST 4" C/PENEIRA BICO FLEX 1473
 Código: **51039** Fábrica: **BESTFER** Unidade: **UN/1**
F1 F4



FUNIL PLASTICO 10 CM DIAM 32020
 Código: **38425** Fábrica: **ALMEGA** Unidade: **UN/1**
F1 F4



FUNIL PLASTICO 3PCS 9,5X8X6,5CM 13784
 Código: **34443** Fábrica: **ALIANCA** Unidade: **CJ/1**
F1 F4



FURA COCO INOX 10CM 1009 12X1
 Código: **33291** Fábrica: **JWC** Unidade: **DZ/12**
F1 F4



GANCHEIRA P/VASSOURAS 1521
 Código: **12908** Fábrica: **CONDOR** Unidade: **UN/1**
F1 F4



GANCHO CROM ACOUGUE 01 141
 Código: **49013** Fábrica: **ARAMINAS** Unidade: **UN/1**
F1 F4



GANCHO CROM ACOUGUE 02 140
 Código: **49014** Fábrica: **ARAMINAS** Unidade: **UN/1**
F1 F4



GANCHO CROM ACOUGUE 03 181
 Código: **49015** Fábrica: **ARAMINAS** Unidade: **UN/1**
F1 F4



GANCHO CROM ACOUGUE 04 182
 Código: **48403** Fábrica: **ARAMINAS** Unidade: **UN/1**
F1 F4



















GANCHO DECORATIVO MDF 13X9,5CM 804
 Código: **40906** Fábrica: **FUTURO** Unidade: **UN/1**
F1 F4



GANCHO PLAST C/VENTOSA 8 PCS 56045
 Código: **40809** Fábrica: **BLESSED** Unidade: **CJ/1**
F1 F4



GARFO ALUM BATIDO 30CM 2642
 Código: **45296** Fábrica: **MSR** Unidade: **UN/1**
F1 F4

 <p>GARFO ALUM FUNDIDO 30CM Código: 32525 Fábrica: AVELAR Unidade: UN/1 F1 F4</p>	 <p>GARFO ALUM INTERICO 28CM 12X1 Código: 41834 Fábrica: COFAX Unidade: PT/6 F1 F4</p>	 <p>GARFO ALUM 28CM CB MAD 2004 UN Código: 48074 Fábrica: COFAX Unidade: UN/1 F1 F4</p>	 <p>GARFO CROM CABO MADEIRA 35 0050 Código: 40256 Fábrica: ARAMINAS Unidade: UN/1 F1 F4 1 35 cm</p>
 <p>GARFO CROM CABO MADEIRA 45 0051 Código: 40257 Fábrica: ARAMINAS Unidade: UN/1 F1 F4 1 45 cm</p>	 <p>GARFO CROM CABO MADEIRA 55 0052 Código: 40258 Fábrica: ARAMINAS Unidade: UN/1 F1 F4 1 55 cm</p>	 <p>GARFO INOX MESA LINHA AMERICA 2221 12X1 Código: 50622 Fábrica: STEEL Unidade: PT/12 F1 F4</p>	 <p>GARFO INOX MESA UNIVERSO 2047 6X1 Código: 50137 Fábrica: GP6 Unidade: PT/6 F1 F4</p>
 <p>GARFO INOX MESA 19CM VERS PTO 952 12X1 Código: 50161 Fábrica: PLANETA Unidade: DZ/12 F1 F4</p>	 <p>GARFO PLASTICO 402 12X1 Código: 10957 Fábrica: ECOPLASTIC Unidade: DZ/12 F1 F4</p>	 <p>GARRAFA INOX TERM 500ML DIGITAL LED 2117 Código: 41450 Fábrica: EXCALIBUR Unidade: UN/1 F1 F4</p>	 <p>GARRAFA INOX TERM 650ML 803-16 Código: 40670 Fábrica: CASA ONZE Unidade: UN/1 F1 F4</p>
 <p>GARRAFA PLAST 1,0 LT COLOR RED 840 Código: 35838 Fábrica: LUMAR Unidade: UN/1 F1 F4</p>	 <p>GARRAFA PLAST 1,0 LT COLOR RET 841 Código: 35839 Fábrica: LUMAR Unidade: UN/1 F1 F4</p>	 <p>GARRAFA PLAST 1,1 LTS AGUA 1092 Código: 33025 Fábrica: TRITEC Unidade: UN/1 F1 F4</p>	 <p>GARRAFA PLAST 1,5 LTS AGUA 1470 Código: 47061 Fábrica: JAGUAR Unidade: UN/1 F1 F4 1,5lts</p>



GARRAFA PLAST 1,5 LTS COLOR 812

Código: **35833** Fábrica: **LUMAR** Unidade: **UN/1**
F1 F4



GARRAFA PLAST 1,5 LTS TRANSP 810

Código: **35834** Fábrica: **LUMAR** Unidade: **UN/1**
F1 F4

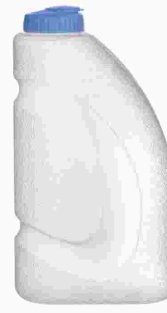

GARRAFA PLAST 2,0 LTS AGUA 697

Código: **33030** Fábrica: **TRITEC** Unidade: **UN/1**
F1 F4



GARRAFA PLAST 2,0 LTS COLOR 813

Código: **35837** Fábrica: **LUMAR** Unidade: **UN/1**
F1 F4



GARRAFA PLAST 2,0 LTS TRANSP 809

Código: **35836** Fábrica: **LUMAR** Unidade: **UN/1**
F1 F4



3,2lts

GARRAFA PLAST 3,2 LTS RET C/TPA 3003

Código: **47064** Fábrica: **JAGUAR** Unidade: **UN/1**
F1 F4



750ml

GARRAFA PLAST 750ML AGUA 1469

Código: **47060** Fábrica: **JAGUAR** Unidade: **UN/1**
F1 F4



GARRAFA TERM 1LT BCA C/TAMPA COLOR 41458

Código: **41458** Fábrica: **MABEL** Unidade: **UN/1**
F1 F4



GARRAFA TERM 500ML EMB CRUZEIRO 2913

Código: **39043** Fábrica: **BRASFOOT** Unidade: **UN/1**
F1 F4



GARRAFA TERMICA 1 LT COLOR C/4 CANECAS

Código: **49733** Fábrica: **FUTURO CASA** Unidade: **UN/1**
F1 F4



GARRAFA TERMICA 1 LT LOTUS COLOR

Código: **44784** Fábrica: **SOPRANO** Unidade: **UN/1**
F1 F4



CORES



GARRAFA TERMICA 1 LT PRETO 6X1

Código: **36732** Fábrica: **INVICTA** Unidade: **CX/6**
F1 F4

CORES



GARRAFA TERMICA 1 LT SONETO FEN SORT 6X1

Código: **45638** Fábrica: **SOPRANO** Unidade: **CX/6**
F1 F4



GARRAFA TERMICA 1L INOX 965

Código: **50229** Fábrica: **FUTURO** Unidade: **UN/1**
F1 F4



GARRAFA TERMICA 1L SAMOA AZUL 9397

Código: **51139** Fábrica: **GP6** Unidade: **UN/1**
F1 F4



GARRAFA TERMICA 1,9L ACO 12418

Código: **46248** Fábrica: **CASITA** Unidade: **UN/1**
F1 F4



GARRAFA TERMICA 1,9L INOX 12482

Código: 47313
 Fábrica: CASITA
 Unidade: UN/1
 F1 F4



GARRAFA TERMICA 1,9L INOX 14X25CM 12489

Código: 50214
 Fábrica: CASITA
 Unidade: UN/1
 F1 F4



GARRAFA TERMICA 500ML NEO EMB ATLETICO

Código: 39044
 Fábrica: BRASFOOT
 Unidade: UN/1
 F1 F4



GARRAFA VIDRO 460ML C/CANUDO PLAST 16015

Código: 47899
 Fábrica: CASITA
 Unidade: UN/1
 F1 F4



GARRAFA 1L SPORT PLAST COLOR 4101

Código: 42767
 Fábrica: DITTOY
 Unidade: UN/1
 F1 F4



GARRAFA 500 ML GALAO PLAST COLOR 4014

Código: 42770
 Fábrica: DITTOY
 Unidade: UN/1
 F1 F4



GARRAFA 500 ML SPORT PLAST COLOR 4103

Código: 42776
 Fábrica: DITTOY
 Unidade: UN/1
 F1 F4



3 lts

GARRAFAO TERMICO 3 LTS AZUL

Código: 40035
 Fábrica: ANTARES
 Unidade: UN/1
 F1 F4



GARRAFAO TERMICO 3 LTS VERMELHO

Código: 49919
 Fábrica: ANTARES
 Unidade: UN/1
 F1 F4



5 lts

GARRAFAO TERMICO 5 LTS VERMELHO

Código: 40170
 Fábrica: ANTARES
 Unidade: UN/1
 F1 F4



GRELHA DOBRAVEL ABAULADA 01 PQ 58X17CM

Código: 24062
 Fábrica: ARAMINAS
 Unidade: UN/1
 F1 F4



GRELHA DOBRAVEL ABAULADA 02 MED 65X21CM

Código: 24063
 Fábrica: ARAMINAS
 Unidade: UN/1
 F1 F4



GRELHA DOBRAVEL ABAULADA 03 GDE 74X26CM

Código: 24064
 Fábrica: ARAMINAS
 Unidade: UN/1
 F1 F4



GRELHA DOBRAVEL RETA 01 PQ 58X17CM

Código: 24065
 Fábrica: ARAMINAS
 Unidade: UN/1
 F1 F4



GRELHA DOBRAVEL RETA 02 MED 65X21CM

Código: 24066
 Fábrica: ARAMINAS
 Unidade: UN/1
 F1 F4



GRELHA DOBRAVEL RETA 03 GDE 74X26CM

Código: 24067
 Fábrica: ARAMINAS
 Unidade: UN/1
 F1 F4



GUARDA SOL 1,80X2,0 MTS

Código: **32361** Fábrica: **ANTARES** Unidade: **UN/1**
F1 F4

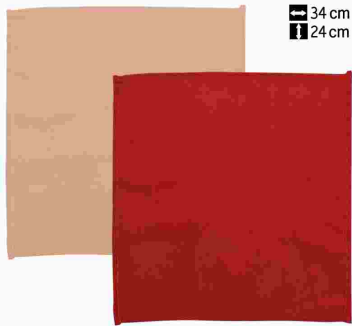

GUARDANAPO PANO LISO 34X24CM 1150 9X1

Código: **40449** Fábrica: **SUN WELLS** Unidade: **PT/9**
F1 F4



GUARDANAPO PAPEL 14X13CM C/500 4X1

Código: **40581** Fábrica: **PANTANAL** Unidade: **PT/2000**
F1 F4



GUARDANAPO PAPEL 22,5X20CM 50X1

Código: **47275** Fábrica: **DOURADAO** Unidade: **PT/50**
F1 F4



GUARDANAPO PAPEL 32,5X30CM 50X1

Código: **47263** Fábrica: **DOURADAO** Unidade: **PT/50**
F1 F4



GUIA PET 3 MTS 13345

Código: **39245** Fábrica: **ALIANCA** Unidade: **UN/1**
F1 F4



HASTE PLAST P/VASO 40 CM MARRON

Código: **39215** Fábrica: **NUTRIPLAN** Unidade: **UN/1**
F1 F4



HASTE PLAST P/VASO 40 CM PRETA

Código: **39214** Fábrica: **NUTRIPLAN** Unidade: **UN/1**
F1 F4



HUMUS DE MINHOCA 10 KG

Código: **30088** Fábrica: **NOVATROPICAL** Unidade: **PT/1**
F1 F4



JARDINEIRA ELEGANCE AUTOIRR 01 VERDE NEON

Código: **42167** Fábrica: **NUTRIPLAN** Unidade: **UN/1**
F1 F4



JARDINEIRA ELEGANCE AUTOIRR 01 CAFE IMP

Código: **36202** Fábrica: **NUTRIPLAN** Unidade: **UN/1**
F1 F4



JARDINEIRA ELEGANCE AUTOIRR 01 VINHO IMP

Código: **42166** Fábrica: **NUTRIPLAN** Unidade: **UN/1**
F1 F4



JARRA PLAST 1,0 LT C/ ESPREM COLOR 4032

Código: **17401** Fábrica: **SBRISSA** Unidade: **UN/1**
F1 F4



JARRA PLAST 1,0 LT GRAD C/ESP TRANSP4031

Código: **44234** Fábrica: **SBRISSA** Unidade: **UN/1**
F1 F4



JARRA PLAST 1,0 LT GRADUADA CORES 4010

Código: **17980** Fábrica: **SBRISSA** Unidade: **UN/1**
F1 F4



JARRA PLAST 1,0 LT GRADUADA TRANSP 4004

Código: **18714** Fábrica: **SBRISSA** Unidade: **UN/1**
F1 F4



JARRA PLAST 1,0 LT GRADUADA 866 UN
 Código: 49483 Fábrica: TRITEC Unidade: UN/1
 F1 F4



JARRA PLAST 1,5 LT RED C/TPA 6606
 Código: 11211 Fábrica: INPLAST Unidade: UN/1
 F1 F4



JARRA PLAST 1,5 LTS TRANSP 814
 Código: 35841 Fábrica: LUMAR Unidade: UN/1
 F1 F4



JARRA PLAST 2,1 LT QUAD C/TPA 6652
 Código: 20146 Fábrica: INPLAST Unidade: UN/1
 F1 F4



JARRA PLAST 2,0 LT QD C/TPA 0078
 Código: 4462 Fábrica: JAGUAR Unidade: UN/1
 F1 F4

2lts



JARRA PLAST 2,5 LTS TRANSP TPA COLOR 863
 Código: 46674 Fábrica: LUMAR Unidade: UN/1
 F1 F4

23cm
 2,5lts



JARRA PLAST 2,5LTS RED NOVELLE 6071
 Código: 46798 Fábrica: RISCHIOTO Unidade: UN/1
 F1 F4

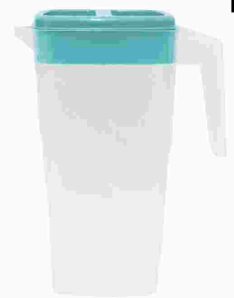

JARRA PLAST 3,3 LTS QUAD C/TPA 0002
 Código: 18920 Fábrica: JAGUAR Unidade: UN/1
 F1 F4

3,3lts



JARRA PLAST 3,7 LTS RED C/TPA 1565
 Código: 4723 Fábrica: JAGUAR Unidade: UN/1
 F1 F4

3,7lts



JARRA PLAST 3,8 LTS AQUARELA C/TPA 6814
 Código: 41670 Fábrica: INPLAST Unidade: UN/1
 F1 F4

JARRA PLAST 3,8 LTS TRANSP C/TPA 6813
 Código: 41666 Fábrica: INPLAST Unidade: UN/1
 F1 F4



JARRA PLAST 4,0 LT TRANSP C/TAMPA 398
 Código: 33026 Fábrica: TRITEC Unidade: UN/1
 F1 F4



JARRA VIDRO 1L P/CANTO GELADEIRA 234
 Código: 47325 Fábrica: NIX Unidade: UN/1
 F1 F4



JARRA VIDRO 1,1 LTS TPA PLAST C/CX 7694
 Código: 47354 Fábrica: ALTIHOME Unidade: UN/1
 F1 F4



JARRA VIDRO 1,1 LTS TPA PLAST C/CX 7695
 Código: 47356 Fábrica: ALTIHOME Unidade: UN/1
 F1 F4



JARRA VIDRO 1,1 LTS TPA PLAST FC019
 Código: 49439 Fábrica: SATYAM Unidade: UN/1
 F1 F4



JARRA VIDRO 1,1 LTS TPA PLAST FC020
 Código: 49440 Fábrica: SATYAM Unidade: UN/1
 F1 F4



JARRA VIDRO 1,1 LTS TRANSP TPA PLAST 016
 Código: 50805 Fábrica: SATYAM Unidade: UN/1
 F1 F4



JARRA VIDRO 1,1 LTS TRANSP TPA PLAST 017
 Código: 50804 Fábrica: SATYAM Unidade: UN/1
 F1 F4



JARRA VIDRO 1,6 LTS C/TPA PLAST 1090
 Código: 49481 Fábrica: LEHAVI Unidade: UN/1
 F1 F4



JARRA VIDRO 1,8 LTS C/TPA PLAST 1091
 Código: 49482 Fábrica: LEHAVI Unidade: UN/1
 F1 F4



JARRA VIDRO 1,8 LTS TRANSP C/TPA ACR 026
 Código: 50803 Fábrica: PRATIBELLA Unidade: UN/1
 F1 F4



JARRA VIDRO 1,8 LTS TRANSP C/TPA ACR 156
 Código: 49801 Fábrica: FUTURO Unidade: UN/1
 F1 F4



JARRA VIDRO 1,8 LTS TRANSP C/TPA ACR 157
 Código: 49799 Fábrica: FUTURO Unidade: UN/1
 F1 F4



JARRA 1,8 LT TRANSP C/TPA 4000
 Código: 17979 Fábrica: SBRISSA Unidade: UN/1
 F1 F4



JARRA 1,8 LT TRANSP DEC C/TPA 8013
 Código: 35219 Fábrica: SBRISSA Unidade: UN/1
 F1 F4



JARRA 1,8 LT TRANSP KIT C/4 COPOS 4041
 Código: 31277 Fábrica: SBRISSA Unidade: UN/1
 F1 F4



JOELHO 1/2 PRETO JO51N 50X1
 Código: 40153 Fábrica: REBOUCAS Unidade: PT/50
 F1 F4



JOELHO 3/4 PRETO JO52N 50X1
 Código: 40154 Fábrica: REBOUCAS Unidade: PT/50
 F1 F4



JOGO CHURRASCO FACA GARFO CB MAD 0091
 Código: 41748 Fábrica: Q.P.BEST FER Unidade: CJ/1
 F1 F4



JOGO CHURRASCO FACA GARFO CB MAD 204
 Código: 41346 Fábrica: HAUSKRAFT Unidade: CJ/1
 F1 F4



JOGO CHURRASCO FACA/CHAIRÁ CB MAD 0071
 Código: 41221 Fábrica: TALBERG Unidade: CJ/1
 F1 F4



JOGO CHURRASCO FACA/GARF/PEGAD CB MAD 75
 Código: 40458 Fábrica: TRAMONTINA Unidade: CJ/1
 F1 F4



KIT CAIPIRINHA 3CS(COPO/TABUA/AMASSA 681
 Código: 40392 Fábrica: TRAMONTINA Unidade: CJ/1
 F1 F4



KIT COZINHA 3PCS(CAP BOT/CAP LIQ/FOR FOG
 Código: 38506 Fábrica: FERREIRA Unidade: UN/1
 F1 F4



KIT COZINHA 3PCS(CAP BOT/FOGAO/PUX SACO)
 Código: 11332 Fábrica: FERREIRA Unidade: UN/1
 F1 F4



KIT CUIA GDE NUTRICOCO (CORRENT/SUPORTE)
 Código: 31903 Fábrica: NUTRIPLAN Unidade: UN/1
 F1 F4



KIT CUIA GIG NUTRICOCO (CORRENT/SUPORTE)
 Código: 31904 Fábrica: NUTRIPLAN Unidade: UN/1
 F1 F4



KIT CUIA 1 MARROM (PRATO/CORREN/VASO)
 Código: 18496 Fábrica: NUTRIPLAN Unidade: UN/1
 F1 F4



KIT CUIA 1 PRETO (PRATO /CORREN/VASO)
 Código: 18494 Fábrica: NUTRIPLAN Unidade: UN/1
 F1 F4



KIT CUIA 1,5 MARROM (PRATO/CORREN/VASO)
 Código: 27334 Fábrica: NUTRIPLAN Unidade: UN/1
 F1 F4



KIT CUIA 2 MARROM (PRATO/CORREN/VASO)
 Código: 22283 Fábrica: NUTRIPLAN Unidade: UN/1
 F1 F4



KIT CUIA 2 PRETO (PRATO /CORREN/VASO)
 Código: 22285 Fábrica: NUTRIPLAN Unidade: UN/1
 F1 F4



KIT CUIA 3 MARROM (PRATO/CORREN/VASO)
 Código: 31390 Fábrica: NUTRIPLAN Unidade: UN/1
 F1 F4



KIT CUIA 3 PRETO (PRATO/CORREN/VASO)
 Código: 30307 Fábrica: NUTRIPLAN Unidade: UN/1
 F1 F4



KIT INF ESCOLAR PRATO+COLHER+CANECA 5013
 Código: 41896 Fábrica: SBRISSA Unidade: CJ/1
 F1 F4



KIT INOX 3 FACAS HERCULES MUNDIAL
 Código: 41170 Fábrica: HERCULES Unidade: CJ/3
 F1 F4



KIT MERENDA PLAST(PRATO/CUMB/CANECA/COLH
 Código: 44235 Fábrica: SBRISSA Unidade: CJ/1
 F1 F4



KIT MERENDA PLAST (PRATO/CUMB/CANECA/COLH)
 Código: 44236 Fábrica: SBRISSA Unidade: CJ/1
 F1 F4



KIT P/BANHEIRO 4 PCS PLAST CORUJA 4054
 Código: 47314 Fábrica: CASITA Unidade: CJ/1
 F1 F4



KIT PIA (LIXEIRA/PA/PORTA DETE) DEC 8020
 Código: 35224 Fábrica: SBRISSA Unidade: UN/1
 F1 F4



KIT PIA (LIXEIRA/PA/PORTA DETE) 8002
 Código: 34563 Fábrica: SBRISSA Unidade: UN/1
 F1 F4

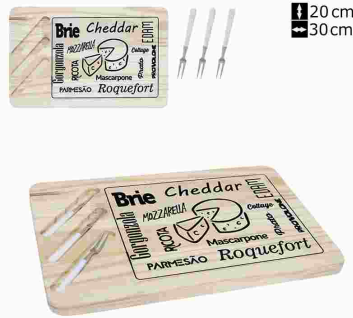

KIT STANDART/TABU MAD C/GARF 20X33CM 57H
 Código: 41739 Fábrica: DEBIASI Unidade: UN/1
 F1 F4



KIT 10 POTES RET 3500/1500/750/350/200ML
 Código: 34573 Fábrica: PLASTBON Unidade: CJ/1
 F1 F4



KIT 2 POTES ORGANIZA QUAD 3L 6332
 Código: 47050 Fábrica: JAGUAR Unidade: CJ/1
 F1 F4



KIT 2 POTES ORGANIZA RED 3L 6331
 Código: 47049 Fábrica: JAGUAR Unidade: CJ/1
 F1 F4



KIT 2 POTES ORGANIZA RET 3,6L 6333
 Código: 47051 Fábrica: JAGUAR Unidade: CJ/1
 F1 F4



KIT 2 POTES RED 4003/02
 Código: 22916 Fábrica: SBRISSA Unidade: CJ/1
 F1 F4



KIT 3 POTES ORGANIZA QUAD 1,2L 6328
 Código: 47046 Fábrica: JAGUAR Unidade: CJ/1
 F1 F4



KIT 3 POTES ORGANIZA RED 1,22L 6330
 Código: 47048 Fábrica: JAGUAR Unidade: CJ/1
 F1 F4



KIT 3 POTES ORGANIZA RET 1,270ML 6329
 Código: 47047 Fábrica: JAGUAR Unidade: CJ/1
 F1 F4



KIT 3 POTES QUAD MED 1200ML 5513
 Código: 41478 Fábrica: KOZI PLAST Unidade: UN/1
 F1 F4



KIT 3 POTES QUAD PMG 380/770/1400ML 7415
 Código: 22917 Fábrica: RISCHIOTO Unidade: CJ/1
 F1 F4



KIT 3 POTES QUAD 230/390/390ML 4128
 Código: 8270 Fábrica: JAGUAR Unidade: CJ/1
 F1 F4



KIT 3 POTES QUAD 230/390/690ML 4129
 Código: 9836 Fábrica: JAGUAR Unidade: CJ/1
 F1 F4



KIT 3 POTES RED 210/370/740ML 4054
 Código: 8267 Fábrica: JAGUAR Unidade: CJ/1
 F1 F4



KIT 3 POTES RED 4003
 Código: 30698 Fábrica: SBRISSA Unidade: CJ/1
 F1 F4



KIT 3 POTES RET PMG 380/740/1200ML 215
 Código: 22918 Fábrica: RISCHIOTO Unidade: CJ/1
 F1 F4



KIT 3 POTES RET 220/420/750ML 4021
 Código: 9838 Fábrica: JAGUAR Unidade: CJ/1
 F1 F4



KIT 4 POTES QUAD 230/390/690/1200ML 4126
 Código: 9076 Fábrica: JAGUAR Unidade: CJ/1
 F1 F4



KIT 4 POTES QUAD 230/390/690/1200ML 4127
 Código: 9077 Fábrica: JAGUAR Unidade: CJ/1
 F1 F4



KIT 4 POTES RED 210/370/740/1220ML 4063
 Código: 9835 Fábrica: JAGUAR Unidade: CJ/1
 F1 F4



KIT 4 POTES RED 210/370/740/1220ML 4064
 Código: 9078 Fábrica: JAGUAR Unidade: CJ/1
 F1 F4

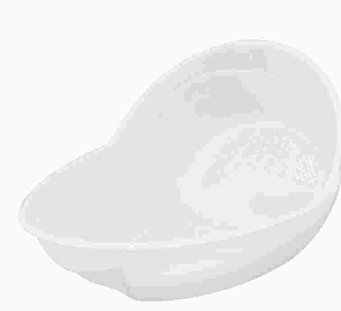

LAVA ARROZ PLAST 0795
 Código: 47059 Fábrica: JAGUAR Unidade: UN/1
 F1 F4



LAVA ARROZ PLAST 5015
 Código: 14573 Fábrica: SBRISSA Unidade: UN/1
 F1 F4



LAVA TUDO PLAST COLOR 5027
 Código: 30262 Fábrica: SBRISSA Unidade: UN/1
 F1 F4



LAVA TUDO PLAST COLOR 674
 Código: 18306 Fábrica: ECOPLASTIC Unidade: UN/1
 F1 F4



LEITEIRA ALUM EXTRA 14 C/TAMPA 1,7LTS
 Código: 40290 Fábrica: AVELAR Unidade: UN/1
 F1 F4



LICOREIRA VIDRO 250ML 19,3CM 22169
 Código: 36770 Fábrica: MABEL Unidade: CX/1
 F1 F4



LIMPA ALUMINIO DULAR 500 ML
 Código: 48941 Fábrica: DULAR Unidade: UN/1
 F1 F4



LIMPA TETO NYLON UN

Código: **50868** Fábrica: **HALLEY** Unidade: **UN/1**
F1 F4



LIMPADOR MULT 500ML 8X3 AZULIM

Código: **48834** Fábrica: **AZULIM** Unidade: **PT/1**
F1 F4

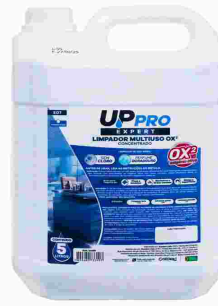

LIMPADOR MULTIUSO 5 LTS CONCENTRADO OX2

Código: **49516** Fábrica: **UP PRO** Unidade: **PT/1**
F1 F4



37cm
28cm
15Lts

LIXEIRA C/ PEDAL 15 L ECO 3065

Código: **19089** Fábrica: **JAGUAR** Unidade: **UN/1**
F1 F4



LIXEIRA CANELADA N 60 56 LTS FECH C/TPA

Código: **18340** Fábrica: **ANTARES** Unidade: **UN/1**
F1 F4



LIXEIRA CANELADA N100 86 LTS FECH C/TP

Código: **22734** Fábrica: **ANTARES** Unidade: **UN/1**
F1 F4



43cm

LIXEIRA INOX C/PEDAL 20 LTS 7022

Código: **47312** Fábrica: **CASITA** Unidade: **UN/1**
F1 F4



39cm
12Lts

LIXEIRA INOX 12 LTS 99-004

Código: **46893** Fábrica: **SATYAM** Unidade: **UN/1**
F1 F4



LIXEIRA PLAST BASC 3 LTS 938

Código: **34576** Fábrica: **PLASTBON** Unidade: **UN/1**
F1 F4



LIXEIRA PLAST BASC 3LTS DEC BIRDS 1741

Código: **37315** Fábrica: **MONTE LIBANO** Unidade: **UN/1**
F1 F4



LIXEIRA PLAST BASC 3LTS DEC BLACK B 1743

Código: **37317** Fábrica: **MONTE LIBANO** Unidade: **UN/1**
F1 F4



LIXEIRA PLAST BASC 3LTS DEC FENDI 1742

Código: **37316** Fábrica: **MONTE LIBANO** Unidade: **UN/1**
F1 F4



LIXEIRA PLAST BASC 4,8 LTS PRETA

Código: **45447** Fábrica: **PLASMARC** Unidade: **UN/1**
F1 F4



LIXEIRA PLAST BASC 6,2 LTS 6672

Código: **26199** Fábrica: **INPLAST** Unidade: **UN/1**
F1 F4



40cm
7,5Lts

LIXEIRA PLAST BASC 7,5 LTS ECO 3065

Código: **3077** Fábrica: **JAGUAR** Unidade: **UN/1**
F1 F4



33cm
29cm
12Lts

LIXEIRA PLAST C/ PEDAL 12 LTS PRETA

Código: **34092** Fábrica: **SHANGRILA** Unidade: **UN/1**
F1 F4



↑ 42cm
↘ 32cm
↔ 20lts

LIXEIRA PLAST C/ PEDAL 20 LTS ECO 3073

Código: 49170 Fábrica: JAGUAR Unidade: UN/1
F1 F4



↑ 53cm
↘ 40cm
↔ 40lts

LIXEIRA PLAST C/ PEDAL 40 LTS ECO 3074

Código: 49171 Fábrica: JAGUAR Unidade: UN/1
F1 F4



↑ 90cm
↘ 50cm

LIXEIRA PLAST C/PEDAL E RODINHA 120 LTS

Código: 45930 Fábrica: ANTARES Unidade: UN/1
F1 F4



LIXEIRA PLAST C/PEDAL LTS DEC COLOR 1557

Código: 41465 Fábrica: MABEL Unidade: UN/1
F1 F4



LIXEIRA PLAST C/PEDAL 12 LTS BRANCA 300

Código: 39343 Fábrica: GUARANY Unidade: UN/1
F1 F4



LIXEIRA PLAST C/PEDAL 13 LTS 6313

Código: 40984 Fábrica: PLASTIBRASIL Unidade: UN/1
F1 F4

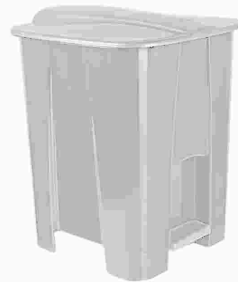

LIXEIRA PLAST C/PEDAL 15 LTS BRANCA 805

Código: 51048 Fábrica: LUMAR Unidade: UN/1
F1 F4



↑ 38cm
↘ 15lts

LIXEIRA PLAST C/PEDAL 15 LTS PRETO 383

Código: 44424 Fábrica: USUAL Unidade: UN/1
F1 F4



LIXEIRA PLAST C/PEDAL 15 LTS PRETO 808

Código: 51049 Fábrica: LUMAR Unidade: UN/1
F1 F4



↑ 67cm
↘ 39cm

LIXEIRA PLAST C/PEDAL 60 LTS BRANCA

Código: 45929 Fábrica: ANTARES Unidade: UN/1
F1 F4



↑ 67cm
↘ 39cm

LIXEIRA PLAST C/PEDAL 60 LTS PRETA

Código: 48663 Fábrica: ANTARES Unidade: UN/1
F1 F4



↑ 28cm
↘ 7lts

LIXEIRA PLAST C/PEDAL 7,0 LTS 281

Código: 45443 Fábrica: TRITEC Unidade: UN/1
F1 F4



↑ 25 cm
↘ 25 cm

LIXEIRA PLAST C/PEDAL 7,5 LTS RED PRETA

Código: 45446 Fábrica: PLASMARC Unidade: UN/1
F1 F4



LIXEIRA PLAST C/TAMPA LTS 921

Código: 34577 Fábrica: PLASTBON Unidade: UN/1
F1 F4



LIXEIRA PLAST C/TAMPA 6 LTS PRETO 112

Código: 50004 Fábrica: PLASMARC Unidade: UN/1
F1 F4



↑ 36cm
↘ 5,5lts

LIXEIRA PLAST C/TPA 5,5 LTS 3067

Código: 492 Fábrica: JAGUAR Unidade: UN/1
F1 F4

13,5 cm



LIXEIRA PLAST DE MESA 13.5CM 57010

Código: **38423** Fábrica: **ALMEGA** Unidade: **UN/1**
F1 F4



LIXEIRA PLAST PEDAL 7LT RATTAN PRET 1987

Código: **38377** Fábrica: **MONTE LIBANO** Unidade: **UN/1**
F1 F4



LIXEIRA PLAST 13 LTS PRETA

Código: **28677** Fábrica: **ECOPLASTIC** Unidade: **UN/1**
F1 F4



LIXEIRA PLAST 2 LTS BASIC P/PIA 4001

Código: **13891** Fábrica: **SBRISSA** Unidade: **UN/1**
F1 F4



LIXEIRA PLAST 2,5 LTS P/PIA 7010

Código: **31285** Fábrica: **SBRISSA** Unidade: **UN/1**
F1 F4



LIXEIRA PLAST 3,2 LTS BASIC 6650

Código: **20157** Fábrica: **INPLAST** Unidade: **UN/1**
F1 F4

26cm
8cm
3,2lts



MACARICO PORTATIL PROF 17X6CM 1853

Código: **50956** Fábrica: **HAI BRASIL** Unidade: **UN/1**
F1 F4



MANGUEIRA GAS 1,00M MANTAC 100

Código: **47883** Fábrica: **MANTAC** Unidade: **UN/1**
F1 F4



MANGUEIRA GAS 1,25M C/2 ABRACADEIRAS 500

Código: **47884** Fábrica: **VINIGAS** Unidade: **UN/1**
F1 F4



MANGUEIRA JD 10M ESG REG CAM DUPLA AZUL

Código: **18512** Fábrica: **NUTRIPLAN** Unidade: **UN/1**
F1 F4



MANGUEIRA JD 10MTS TRANC CRISTAL 14017

Código: **48828** Fábrica: **ARQUA** Unidade: **UN/1**
F1 F4



MANGUEIRA JD 10MTS TRANC FLEX VERD 14007

Código: **48830** Fábrica: **ARQUA** Unidade: **UN/1**
F1 F4

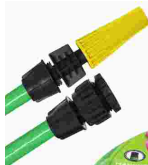

MANGUEIRA JD 15MTS POP VERDE 14002

Código: **48826** Fábrica: **ARQUA** Unidade: **UN/1**
F1 F4



MANGUEIRA JD 15MTS TRANC CRISTAL 14018

Código: **48831** Fábrica: **ARQUA** Unidade: **UN/1**
F1 F4



MANGUEIRA JD 15MTS TRANC FLEX VERD 14008

Código: **48827** Fábrica: **ARQUA** Unidade: **UN/1**
F1 F4



MANGUEIRA JD 20MTS POP VERDE 14003

Código: **48825** Fábrica: **ARQUA** Unidade: **UN/1**
F1 F4



MANGUEIRA JD 20MTS TRANC CRISTAL 14019
 Código: 48832 Fábrica: ARQUA Unidade: UN/1
 F1 F4



MANGUEIRA JD 20MTS TRANC FLEX COLOR 158
 Código: 40231 Fábrica: MONTEREY Unidade: UN/1
 F1 F4



MANGUEIRA JD 20MTS TRANC FLEX VERD 14009
 Código: 48833 Fábrica: ARQUA Unidade: UN/1
 F1 F4



MANGUEIRA JD 30M ESG REG CAM DUPLA AZUL
 Código: 27119 Fábrica: NUTRIPLAN Unidade: UN/1
 F1 F4



MANGUEIRA JD 30MTS POP VERDE 14030
 Código: 48824 Fábrica: ARQUA Unidade: UN/1
 F1 F4



MANGUEIRA JD 30MTS TRANC FLEX COLOR 160
 Código: 34405 Fábrica: MONTEREY Unidade: UN/1
 F1 F4



MANGUEIRA JD 30MTS TRANC FLEX VERD 14011
 Código: 48823 Fábrica: ARQUA Unidade: UN/1
 F1 F4



MARMITA ALUM REDONDA 10 686
 Código: 12305 Fábrica: MSR Unidade: UN/1
 F1 F4



MARMITA ALUM REDONDA 12 687
 Código: 10431 Fábrica: MSR Unidade: UN/1
 F1 F4



MARMITA ALUM REDONDA 14 688
 Código: 24365 Fábrica: MSR Unidade: UN/1
 F1 F4



MARMITA ALUM REDONDA 16 689
 Código: 22729 Fábrica: MSR Unidade: UN/1
 F1 F4



MARMITA ALUM REDONDA 18 690
 Código: 14610 Fábrica: MSR Unidade: UN/1
 F1 F4



MARMITA PLAST INF 2 DIV C/COLHER 8345
 Código: 26086 Fábrica: SATYAM Unidade: UN/1
 F1 F4



MARMITA PLAST 1 LT C/TRAVA VALVULA 256
 Código: 44436 Fábrica: USUAL Unidade: UN/1
 F1 F4

8,5cm
 11cm
 17cm



MARMITA TERMICA ALUM RED 14 692
 Código: 19605 Fábrica: MSR Unidade: UN/1
 F1 F4



MARMITA TERMICA ALUM RED 16 C/BOLSA 694
 Código: 26822 Fábrica: MSR Unidade: UN/1
 F1 F4



MARMITA TERMICA ALUM RED 16 693

Código: 2218
Fábrica: MSR
Unidade: UN/1
F1 F4



MARMITA TERMICA ALUM RET 16

Código: 2219
Fábrica: MSR/DF
Unidade: UN/1
F1 F4



MARMITEIX ISOPOR C/TAMPA 500 ML 100X1

Código: 50421
Fábrica: ULTRA
Unidade: PT/100
F1 F4



MARTELO ALUM INTEIRICO 2006 UN

Código: 48023
Fábrica: COFAX
Unidade: UN/1
F1 F4



MARTELO ALUM 19CM CB MAD 2021 UN

Código: 48021
Fábrica: COFAX
Unidade: UN/1
F1 F4



MASSAGEADOR ROSTO E LIMPEZA FACIAL RECAR

Código: 35624
Fábrica: FOREVER
Unidade: CX/1
F1 F4



48cm

MATA MOSCA PLAST 48CM CB MADEIRA 264 UN

Código: 45440
Fábrica: TRITEC
Unidade: PT/2
F1 F4



MESA INFANTIL AZUL

Código: 22789
Fábrica: ANTARES
Unidade: UN/1
F1 F4



MESA INFANTIL DOBRAVEL AZUL

Código: 28513
Fábrica: ANTARES
Unidade: UN/1
F1 F4



MESA INFANTIL DOBRAVEL ROSA

Código: 28512
Fábrica: ANTARES
Unidade: UN/1
F1 F4



MESA INFANTIL ROSA

Código: 23042
Fábrica: ANTARES
Unidade: UN/1
F1 F4



81 cm
52 cm

MESA MADEIRA C/ 2 BANQUETAS STELL

Código: 35641
Fábrica: AMOF
Unidade: UN/1
F1 F4

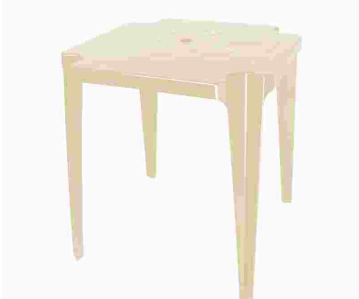

MESA MONOBLOCO BEGE

Código: 23044
Fábrica: ANTARES
Unidade: UN/1
F1 F4



MESA MONOBLOCO BRANCA

Código: 22589
Fábrica: ANTARES
Unidade: UN/1
F1 F4



MESA MONOBLOCO OURO PRETO PRETA

Código: 44669
Fábrica: ANTARES
Unidade: UN/1
F1 F4



MESA MONOBLOCO VINHO

Código: 22591
Fábrica: ANTARES
Unidade: UN/1
F1 F4



MESA PLASTICA RED BEGE DESMONTAVEL

Código: 20001
 Fábrica: ANTARES
 Unidade: UN/1
 F1 F4



MESA PLASTICA RED BRANCA DESMONTAVEL

Código: 20002
 Fábrica: ANTARES
 Unidade: UN/1
 F1 F4



MIX PERLITA CARVAO CASCA DE ARROZ 1 LITR

Código: 48529
 Fábrica: NOVATROPICAL
 Unidade: PT/1
 F1 F4



MOP FLAT C/1 REFIL 474

Código: 41263
 Fábrica: 123UTIL
 Unidade: UN/1
 F1 F4



26cm
 1,2lts

MORINGA PLAST 1,2 LTS COLOR 817

Código: 35842
 Fábrica: LUMAR
 Unidade: UN/1
 F1 F4



MUSGO SPHAGNUM 1 LITRO

Código: 48535
 Fábrica: NOVATROPICAL
 Unidade: PT/1
 F1 F4



MUSGO VERDE 50 GRS 1 LITRO

Código: 34750
 Fábrica: NOVATROPICAL
 Unidade: PT/1
 F1 F4

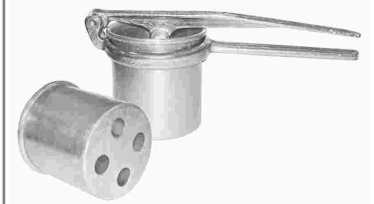

NHOQUEIRA ALUM INTERICO 22CM 2015 UN

Código: 48025
 Fábrica: COFAX
 Unidade: UN/1
 F1 F4



ORGANIZADOR MOD RATTAN 10X7X11CM BABY942

Código: 38393
 Fábrica: MONTE LIBANO
 Unidade: UN/1
 F1 F4



ORGANIZADOR MOD RATTAN 10X7X11CM BCO 940

Código: 38391
 Fábrica: MONTE LIBANO
 Unidade: UN/1
 F1 F4



ORGANIZADOR MOD RATTAN 10X7X11CM TEND943

Código: 38394
 Fábrica: MONTE LIBANO
 Unidade: UN/1
 F1 F4



ORGANIZADOR MOD RATTAN 15X10X11CM BAB932

Código: 38397
 Fábrica: MONTE LIBANO
 Unidade: UN/1
 F1 F4



ORGANIZADOR MOD RATTAN 15X10X11CM BCO960

Código: 38395
 Fábrica: MONTE LIBANO
 Unidade: UN/1
 F1 F4



ORGANIZADOR MOD RATTAN 15X10X11CM PTO961

Código: 38396
 Fábrica: MONTE LIBANO
 Unidade: UN/1
 F1 F4

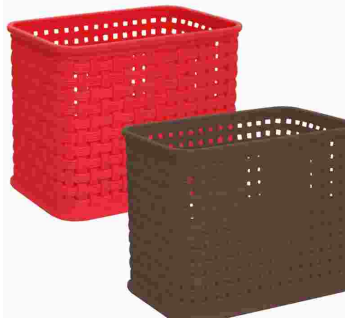

ORGANIZADOR MOD RATTAN 15X10X11CM TEN963

Código: 38398
 Fábrica: MONTE LIBANO
 Unidade: UN/1
 F1 F4



ORGANIZADOR MOD RATTAN 15X10X6CM BABY932

Código: 38402
 Fábrica: MONTE LIBANO
 Unidade: UN/1
 F1 F4



ORGANIZADOR MOD RATTAN 15X10X6CM BCO 930
 Código: 38388 Fábrica: MONTE LIBANO Unidade: UN/1
 F1 F4

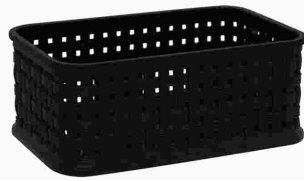

ORGANIZADOR MOD RATTAN 15X10X6CM PTO 931
 Código: 38389 Fábrica: MONTE LIBANO Unidade: UN/1
 F1 F4



ORGANIZADOR MOD RATTAN 15X10X6CM TEND933
 Código: 38390 Fábrica: MONTE LIBANO Unidade: UN/1
 F1 F4



ORGANIZADOR MOD RATTAN 20X15X6CM 970
 Código: 38384 Fábrica: MONTE LIBANO Unidade: UN/1
 F1 F4



ORGANIZADOR MOD RATTAN 20X15X6CM PTO 971
 Código: 38386 Fábrica: MONTE LIBANO Unidade: UN/1
 F1 F4



ORGANIZADOR MOD RATTAN 30X10X6CM BABY952
 Código: 38382 Fábrica: MONTE LIBANO Unidade: UN/1
 F1 F4

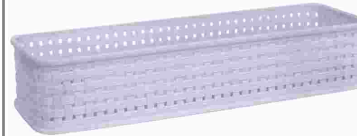

ORGANIZADOR MOD RATTAN 30X10X6CM BCO 950
 Código: 38380 Fábrica: MONTE LIBANO Unidade: UN/1
 F1 F4



ORGANIZADOR MOD RATTAN 30X10X6CM TEND953
 Código: 38381 Fábrica: MONTE LIBANO Unidade: UN/1
 F1 F4



ORGANIZADOR PLAST C/DIV 23X14,8X4CM 2015
 Código: 37313 Fábrica: MONTE LIBANO Unidade: UN/1
 F1 F4



ORGANIZADOR PLAST C/DIV 28X18X4,5CM 2020
 Código: 37312 Fábrica: MONTE LIBANO Unidade: UN/1
 F1 F4



ORGANIZADOR PLAST C/DIV 37X28,5X7CM 2025
 Código: 38376 Fábrica: MONTE LIBANO Unidade: UN/1
 F1 F4

17 cm
 37 cm



ORGANIZADORA PLAST RED 5,5 LTS BCA 952
 Código: 34581 Fábrica: PLASTBON Unidade: UN/1
 F1 F4



ORGANIZADORA PLAST RED 5,5 LTS COLOR1088
 Código: 34584 Fábrica: PLASTBON Unidade: UN/1
 F1 F4



PA LIXO METAL CB MADEIRA 60CM
 Código: 17510 Fábrica: HALLE Unidade: UN/1
 F1 F4



PA LIXO PLAST C/CABO MAD LONGO 033
 Código: 33514 Fábrica: BENEDETTI Unidade: UN/1
 F1 F4



PA LIXO PLAST C/CABO PEQ COLOR PLUS 3051
 Código: 49812 Fábrica: HALLEY Unidade: UN/1
 F1 F4



PA LIXO PLAST C/CABO PEQ PRETA 2497
 Código: 49813 Fábrica: EDS Unidade: UN/1
 F1 F4



PA LIXO PLAST COLOR 28CM 09
 Código: 44084 Fábrica: QUALYPLAS Unidade: UN/1
 F1 F4



28cm
 PA LIXO PLAST CORES
 Código: 12902 Fábrica: ANTARES Unidade: UN/1
 F1 F4



28cm
 PA LIXO PLAST PRETA
 Código: 34093 Fábrica: SHANGRILA Unidade: UN/1
 F1 F4



PA LIXO PLAST TABACO
 Código: 40779 Fábrica: NUTRIPLAN Unidade: UN/1
 F1 F4



PA LIXO PLAST 032
 Código: 23995 Fábrica: BENEDETTI Unidade: UN/1
 F1 F4



28cm
 PA LIXO PLAST 0698
 Código: 47067 Fábrica: JAGUAR Unidade: UN/1
 F1 F4



PA LIXO PLAST 2466
 Código: 49809 Fábrica: EDS Unidade: UN/1
 F1 F4



PA LIXO PLAST 7003
 Código: 14585 Fábrica: SBRISSA Unidade: UN/1
 F1 F4



PA MADEIRA 30 CM (ESPATULA) 012
 Código: 41318 Fábrica: MAD LAR Unidade: UN/1
 F1 F4



PA MADEIRA 38 CM (ESPATULA) 014
 Código: 41317 Fábrica: MAD LAR Unidade: UN/1
 F1 F4



PA MADEIRA 38 CM 110
 Código: 35827 Fábrica: CSD Unidade: UN/1
 F1 F4



PANELA ALUM BATIDO 16 CB MADEIRA 1511
 Código: 45371 Fábrica: MSR Unidade: UN/1
 F1 F4



PANELA ALUM BATIDO 18 CB INTEIRICO 1551
 Código: 45376 Fábrica: MSR Unidade: UN/1
 F1 F4



PANELA ALUM BATIDO 18 CB MADEIRA 1512
 Código: 45370 Fábrica: MSR Unidade: UN/1
 F1 F4



PANELA ALUM BATIDO 20 CB INTEIRICO 1554
 Código: 45375 Fábrica: MSR Unidade: UN/1
 F1 F4



PANELA ALUM BATIDO 20 CB MADEIRA 1513

Código: 45369 Fábrica: MSR Unidade: UN/1
F1 F4



PANELA ALUM BATIDO 22 CB INTEIRICO 1552

Código: 45374 Fábrica: MSR Unidade: UN/1
F1 F4



PANELA ALUM BATIDO 24 CB INTEIRICO 1553

Código: 45373 Fábrica: MSR Unidade: UN/1
F1 F4



PANELA ALUM BATIDO 28 CB MADEIRA 1517

Código: 45368 Fábrica: MSR Unidade: UN/1
F1 F4



PANELA ALUM BATIDO 30 CB INTEIRICO 1576

Código: 45372 Fábrica: MSR Unidade: UN/1
F1 F4



PANELA ALUM EXTRA 14 CB MADEIRA 697

Código: 24373 Fábrica: MSR Unidade: UN/1
F1 F4



PANELA ALUM EXTRA 16 CB MADEIRA 698

Código: 24374 Fábrica: MSR Unidade: UN/1
F1 F4



PANELA ALUM EXTRA 18 CB MADEIRA 699

Código: 24375 Fábrica: MSR Unidade: UN/1
F1 F4



PANELA ALUM EXTRA 20 CB MADEIRA 700/701

Código: 24376 Fábrica: MSR Unidade: UN/1
F1 F4



PANELA ALUM EXTRA 22 CB MADEIRA 701

Código: 24377 Fábrica: MSR Unidade: UN/1
F1 F4



PANELA ALUM EXTRA 24 CB MADEIRA 702

Código: 24378 Fábrica: MSR Unidade: UN/1
F1 F4



PANELA ALUM LEVE 14 C/TAMPA

Código: 5884 Fábrica: AVELAR Unidade: UN/1
F1 F4



PANELA ALUM LEVE 16 C/TAMPA

Código: 5885 Fábrica: AVELAR Unidade: UN/1
F1 F4



PANELA ALUM LEVE 18 S/TAMPA

Código: 5886 Fábrica: AVELAR Unidade: UN/1
F1 F4



PANELA ALUM LEVE 20 S/TAMPA

Código: 5887 Fábrica: AVELAR Unidade: UN/1
F1 F4



PANELA ALUM LUXO 14 CB BAQUELITE 703

Código: 25302 Fábrica: MSR Unidade: UN/1
F1 F4



PANELA ALUM LUXO 16 CB BAQUELITE 704

Código: 25306
Fábrica: MSR
Unidade: UN/1
F1 F4



PANELA ALUM LUXO 18 CB BAQUELITE 705

Código: 25307
Fábrica: MSR
Unidade: UN/1
F1 F4



PANELA ALUM LUXO 20 CB BAQUELITE 706

Código: 25303
Fábrica: MSR
Unidade: UN/1
F1 F4



PANELA ALUM LUXO 22 CB BAQUELITE 707

Código: 25304
Fábrica: MSR
Unidade: UN/1
F1 F4



PANELA PRESSAO 7,0 LTS POLIDA ALUMINE

Código: 48116
Fábrica: ALEGRETE
Unidade: UN/1
F1 F4



PANELA PRESSAO 10,0 LTS POLIDA ALUMINE

Código: 48120
Fábrica: ALEGRETE
Unidade: UN/1
F1 F4

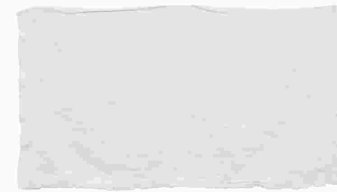

PANO CHAO SACO ALG ALVEJ COMBATE 38X58CM

Código: 49840
Fábrica: TEXTIL
Unidade: UN/1
F1 F4



PANO CHAO SACO ALG ALVEJ M 43X63CM

Código: 49831
Fábrica: TEXTIL
Unidade: UN/1
F1 F4



PANO CHAO SACO ALG ALVEJ PP 30X55CM

Código: 50090
Fábrica: TEXTIL
Unidade: UN/1
F1 F4



PANO CHAO SACO ALG ALVEJ TRAD 43X68CM

Código: 49839
Fábrica: TEXTIL
Unidade: UN/1
F1 F4



PANO CHAO SACO ALG XADREZ M 43X68CM

Código: 48794
Fábrica: TEXTIL
Unidade: UN/1
F1 F4



PANO CHAO SACO ALG XADREZ SG 78X53CM

Código: 20249
Fábrica: TEXTIL
Unidade: UN/1
F1 F4



PANO CHAO SACO CRU ECOPLUS 48X85CM

Código: 47137
Fábrica: TEXTIL/ENCOP
Unidade: UN/1
F1 F4



PANO MULTIUSO MICROFIBRA 30X30CM 010 3X1

Código: 49394
Fábrica: RIOHOME
Unidade: PT/3
F1 F4



PANO MULTIUSO 30X50CM AZUL 5X1

Código: 48716
Fábrica: NOBRE
Unidade: PT/5
F1 F4

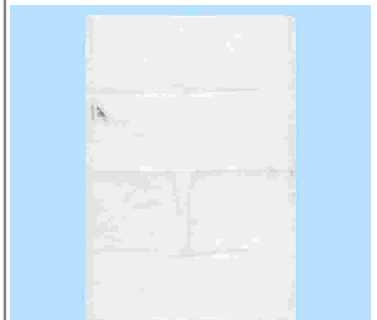

PANO PRATO ALGODAO LISO RUBI 65X40CM

Código: 49795
Fábrica: ENGOMATEXIL
Unidade: UN/1
F1 F4



PANO PRATO LISO EXTRA 100% ALGO 72X45CM
 Código: 48813 Fábrica: ENGOMATEX Unidade: UN/1
 F1 F4



PANO PRATO LISO RUBI 65X40CM 114 10X1
 Código: 39380 Fábrica: ENGOMATEXIL Unidade: PT/10
 F1 F4



PAPEIRO ALUM LEVE 16 708
 Código: 20734 Fábrica: MSR Unidade: UN/1
 F1 F4



PAPEL ALUMINIO 7,5MTSX30CM 19935
 Código: 47844 Fábrica: THEOTO/MELLO Unidade: RL/1
 F1 F4



PAPEL MANTEIGA 28CMX4M 21754
 Código: 50076 Fábrica: BOMPACK Unidade: RL/1
 F1 F4



PAPEL MANTEIGA 28CMX7,5M
 Código: 48695 Fábrica: BOMPACK Unidade: RL/1
 F1 F4



PAPEL TOALHA 20X22CM BCO FOLHA DUPLA 2X1
 Código: 47980 Fábrica: NOBRE SENSE Unidade: PT/2
 F1 F4



PEDRA DOLOMITA BRANCO 3 1 KG
 Código: 22888 Fábrica: NOVATROPICAL Unidade: PT/1
 F1 F4

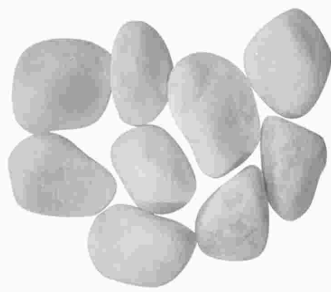

PEDRA SEIXO MARMORE 15 KG N0
 Código: 34647 Fábrica: NOVATROPICAL Unidade: PT/1
 F1 F4

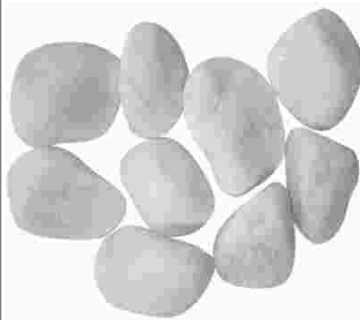

PEDRA SEIXO MARMORE 15 KG N1
 Código: 33905 Fábrica: NOVATROPICAL Unidade: PT/1
 F1 F4

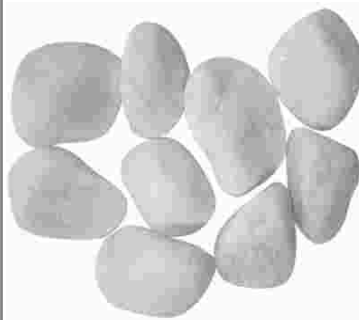

PEDRA SEIXO MARMORE 15 KG N2
 Código: 33430 Fábrica: NOVATROPICAL Unidade: PT/1
 F1 F4

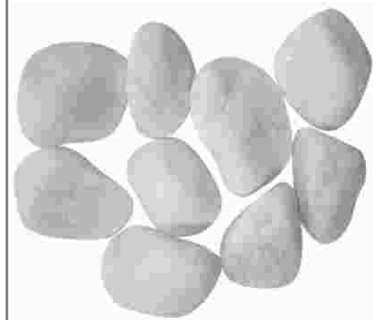

PEDRA SEIXO MARMORE 15 KG N3
 Código: 33235 Fábrica: NOVATROPICAL Unidade: PT/1
 F1 F4



PEGADOR INOX CHURRASCO 38CM CAB MAD 2038
 Código: 41347 Fábrica: HAUSKRAFT Unidade: UN/1
 F1 F4



PEGADOR INOX MASSAS 29CM ITALIA CTL 800
 Código: 47990 Fábrica: PLANETA Unidade: CR/1
 F1 F4



PEGADOR INOX MULTUSO 28CM PE60
 Código: 46582 Fábrica: HERCULES Unidade: UN/1
 F1 F4



PEGADOR MACARRAO NYLON REF 503
 Código: 10988 Fábrica: PLASUTIL Unidade: UN/1
 F1 F4

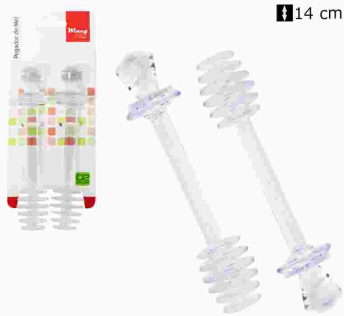

14 cm

PEGADOR MEL ACRILICO 14CM 2X1 CTL 3170

Código: 44725
Fábrica: WINCY
Unidade: CJ/2
F1 F4



15 cm

PEGADOR MEL MADEIRA 15CM 6027 4X1

Código: 44726
Fábrica: WINCY
Unidade: CJ/4
F1 F4



PEGADOR PLAST MACARRAO COLOR 5024

Código: 31281
Fábrica: SBRISSA
Unidade: UN/1
F1 F4



14 cm

PENEIRA ACO INOX 14CM 003

Código: 41353
Fábrica: HAUSKRAFT
Unidade: UN/1
F1 F4



PENEIRA ACO INOX 16 CM DUPLA CAMADA 345

Código: 44507
Fábrica: PLANETA
Unidade: UN/1
F1 F4



PENEIRA ACO INOX 18 CM DUPLA CAMADA 346

Código: 44506
Fábrica: PLANETA
Unidade: UN/1
F1 F4



PENEIRA PLAST C/CABO 07 CM 661

Código: 35494
Fábrica: TRITEC
Unidade: UN/1
F1 F4



PENEIRA PLAST C/CABO 10 CM 660

Código: 35495
Fábrica: TRITEC
Unidade: UN/1
F1 F4



PENEIRA PLAST C/CABO 18 CM 3182 6X1

Código: 37691
Fábrica: MAMITA
Unidade: PT/6
F1 F4



PENEIRA PLAST C/CABO 28 CM 659

Código: 35496
Fábrica: TRITEC
Unidade: UN/1
F1 F4



PENEIRA PLAST C/FUNIL COLOR 3024 6X1

Código: 41894
Fábrica: SBRISSA
Unidade: PT/1
F1 F4



PENEIRA PLAST DE NYLON 8 CM 677

Código: 48664
Fábrica: PLANETA
Unidade: UN/1
F1 F4



PENEIRA PLASTICA 16 CM 3011 12X1

Código: 11022
Fábrica: SBRISSA
Unidade: PT/12
F1 F4



PENEIRA PLASTICA 20 CM 3012 12X1

Código: 2940
Fábrica: SBRISSA
Unidade: PT/12
F1 F4



PERLITA EXPANDIDA 1 LITRO

Código: 48530
Fábrica: NOVATROPICAL
Unidade: PT/1
F1 F4



PESO UNIV PANELA PRESS CROMADO 3002 10X1

Código: 19368
Fábrica: PINOLAR
Unidade: PT/10
F1 F4



PESO UNIV PANELA PRESS ENCAPAD 4001 10X1

Código: 40032
 Fábrica: PINOLAR
 Unidade: PT/10
 F1 F4



PESO UNIV PANELA PRESS ENCAPAD 4001 5X1

Código: 34633
 Fábrica: PINOLAR
 Unidade: PT/5
 F1 F4



PILAO ALUM INTEIRICO ALHO GDE 2032 UN

Código: 46852
 Fábrica: COFAX
 Unidade: UN/1
 F1 F4



PILAO ALUM INTEIRICO ALHO PEQ 2012 UN

Código: 48076
 Fábrica: COFAX
 Unidade: UN/1
 F1 F4



PILAO MAD 08 CM C/SOCADOR 101

Código: 41324
 Fábrica: MAD LAR
 Unidade: UN/1
 F1 F4



PILAO PLASTICO 8,5X17CM 1059/1070

Código: 20927
 Fábrica: ENGIPLAST
 Unidade: UN/1
 F1 F4



PINCEL COZINHA COLOR SILICONE 24CM 16058

Código: 26125
 Fábrica: ALIANCA
 Unidade: UN/1
 F1 F4



PIPOQUEIRA ALUM 20 709

Código: 22731
 Fábrica: MSR
 Unidade: UN/1
 F1 F4



PLAFON PLAST C/SOQUETE PORCELANA BCO E27

Código: 48603
 Fábrica: REBOUCAS
 Unidade: UN/1
 F1 F4



PLAINA INOX 25CM P/QUEIJOS 065

Código: 47332
 Fábrica: NIX
 Unidade: UN/1
 F1 F4



PO DE CARVAO VEGETAL 1 LITRO

Código: 48528
 Fábrica: NOVATROPICAL
 Unidade: PT/1
 F1 F4



PO DE COCO 1 LITRO

Código: 48532
 Fábrica: NOVATROPICAL
 Unidade: PT/1
 F1 F4



PO DE PINUS 1 LITRO

Código: 48531
 Fábrica: NOVATROPICAL
 Unidade: PT/1
 F1 F4



POLVILHADEIRA MATA FORMIGA CAP 1KG

Código: 38650
 Fábrica: GUARANY
 Unidade: UN/1
 F1 F4



PORTA CHA MDF 10X10CM 470

Código: 45985
 Fábrica: R A ARTESANA
 Unidade: UN/1
 F1 F4

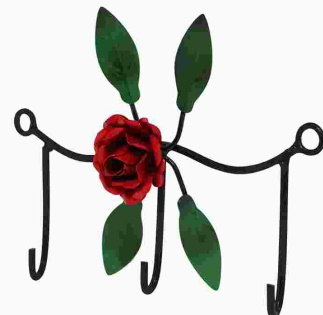

PORTA CHAVE DE FERRO 5062

Código: 42171
 Fábrica: PAIOL
 Unidade: UN/1
 F1 F4



PORTA COND PLAST COLORAU 499

Código: 46644 Fábrica: QUALYPLAS Unidade: UN/1
F1 F4



PORTA COND PLAST OREGANO 416

Código: 46645 Fábrica: QUALYPLAS Unidade: UN/1
F1 F4



PORTA COND PLAST PIMENTA DO REINO 418

Código: 46648 Fábrica: QUALYPLAS Unidade: UN/1
F1 F4



PORTA COND PLAST PIMENTA 417

Código: 46647 Fábrica: QUALYPLAS Unidade: UN/1
F1 F4



PORTA COND PLAST SAL419

Código: 46646 Fábrica: QUALYPLAS Unidade: UN/1
F1 F4



PORTA CONDIMENTO VIDRO 100ML 008 2X1

Código: 49375 Fábrica: RIOHOME Unidade: UN/1
F1 F4



PORTA COPOS MDF PEQ FLAMENGO 10688 6X1

Código: 41151 Fábrica: BRASFOOT Unidade: UN/1
F1 F4



PORTA COTONETE/ALGODAO PLAST 10CM 2638

Código: 41554 Fábrica: PLASUTIL Unidade: UN/1
F1 F4



PORTA DETERGENTE BUCHA 550 ML DISPEN 976

Código: 46671 Fábrica: LUMAR Unidade: UN/1
F1 F4



PORTA DETERGENTE E BUCHA RATTAN BCO 1970

Código: 37292 Fábrica: MONTE LIBANO Unidade: UN/1
F1 F4



PORTA DETERGENTE E BUCHA RATTAN BCO 920

Código: 38399 Fábrica: MONTE LIBANO Unidade: UN/1
F1 F4



PORTA DETERGENTE E BUCHA RATTAN PTO 1971

Código: 37291 Fábrica: MONTE LIBANO Unidade: UN/1
F1 F4



PORTA DETERGENTE E BUCHA RATTAN PTO 921

Código: 38400 Fábrica: MONTE LIBANO Unidade: UN/1
F1 F4



PORTA DETERGENTE E BUCHA RATTAN TEND 923

Código: 38401 Fábrica: MONTE LIBANO Unidade: UN/1
F1 F4



PORTA DETERGENTE SABAO ESPONJA 5028

Código: 10403 Fábrica: SBRISSA Unidade: UN/1
F1 F4



PORTA DETERGENTE SABAO PLAST 180CM 84

Código: 44087 Fábrica: QUALYPLAS Unidade: UN/1
F1 F4



21cm

PORTA ESCOVA DENTES PLAST 1616

Código: 47065 Fábrica: JAGUAR Unidade: UN/1 F1 F4



PORTA ESCOVA PLAST 20CM COLOR 669

Código: 44086 Fábrica: QUALYPLAS Unidade: UN/1 F1 F4



PORTA ESCOVAS DENTE C/TAMPA 980

Código: 46672 Fábrica: LUMAR Unidade: UN/1 F1 F4



PORTA FILTRO PLAST UN 5025

Código: 31282 Fábrica: SBRISSA Unidade: UN/1 F1 F4



8,5cm
17,5cm
23,5cm

PORTA FRIO PLAST 2 LTS C/TRAV TRANSL 393

Código: 44437 Fábrica: USUAL Unidade: UN/1 F1 F4

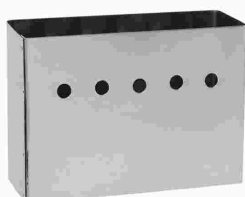

PORTA GUARDANAPO INOX 13X5,5X9CM 180225

Código: 39222 Fábrica: SATYAM Unidade: UN/1 F1 F4



PORTA GUARDANAPO INOX 15X3X6,5CM 110060

Código: 39221 Fábrica: SATYAM Unidade: UN/1 F1 F4



PORTA LEITE PLAST SAQUIN 16,5X7,5X16,5CM

Código: 20013 Fábrica: DELTA UTIL Unidade: UN/1 F1 F4



PORTA SABAO 335

Código: 28886 Fábrica: JOREAL Unidade: UN/1 F1 F4



PORTA SABAO/DET/BUCHA PLAST 6611

Código: 41671 Fábrica: INPLAST Unidade: UN/1 F1 F4



PORTA SABONETE LIQ PLAST 500 ML 981

Código: 46670 Fábrica: LUMAR Unidade: UN/1 F1 F4



PORTA SABONETE LIQUIDO PLAST 250ML 2636

Código: 41556 Fábrica: PLASUTIL Unidade: UN/1 F1 F4

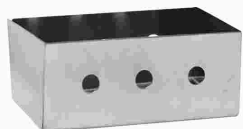

PORTA SACHES INOX 10X4,5X6,5CM 180224

Código: 39220 Fábrica: SATYAM Unidade: UN/1 F1 F4



PORTA TALHER CROM 561

Código: 20176 Fábrica: ARAMINAS Unidade: UN/1 F1 F4

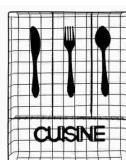

PORTA TALHER INOX ARAMADO 32X26X3,5CM

Código: 38529 Fábrica: WINCY Unidade: UN/1 F1 F4



PORTA TALHER PLAST COLOR 6699

Código: 41672 Fábrica: INPLAST Unidade: UN/1 F1 F4



PORTA TALHER PLASTICO C/TAMPA 517

Código: 35484
 Fábrica: TRITEC
 Unidade: UN/1
 F1 F4



11 cm
 35 cm

PORTA VINHO DEITADO ENVELHEC 3424-1

Código: 37189
 Fábrica: PAIOL
 Unidade: UN/1
 F1 F4



22 cm
 37 cm

PORTA VINHO E TACAS VIOLETA 4546

Código: 37188
 Fábrica: PAIOL
 Unidade: UN/1
 F1 F4



POTE CAFE ACUCAR PORTA FILT/ADAPTAD 8001

Código: 34564
 Fábrica: SBRISSA
 Unidade: CJ/1
 F1 F4



POTE CAFE ACUCAR PREMIUM 8005

Código: 34565
 Fábrica: SBRISSA
 Unidade: CJ/1
 F1 F4



POTE HERMETICO 4,5LTS RET C/TRAVA 952

Código: 48669
 Fábrica: LIG BRIN
 Unidade: UN/1
 F1 F4



POTE MANTIMENTO ALUM LEVE 14

Código: 11260
 Fábrica: AVELAR
 Unidade: UN/1
 F1 F4



POTE PLAST C/TAMPA MULTIUSO G COLOR

Código: 41209
 Fábrica: PLASTSU
 Unidade: UN/1
 F1 F4



POTE PLAST C/TRAVA GG COLOR 2,5LT 331030

Código: 41207
 Fábrica: PLASTSU
 Unidade: UN/1
 F1 F4



POTE PLAST DESC 250 ML 50X1

Código: 47739
 Fábrica: COPOZAN
 Unidade: PT/50
 F1 F4



POTE PLAST HERM 2,2 LTS ALTO TRANSP 183T

Código: 34068
 Fábrica: GIOTTO
 Unidade: UN/1
 F1 F4



POTE PLAST MANT 2,5LTS QUAD ACUCAR 244

Código: 40367
 Fábrica: FORMPLAST
 Unidade: UN/1
 F1 F4



POTE PLAST MANT 2,5LTS QUAD ARROZ 241

Código: 40370
 Fábrica: FORMPLAST
 Unidade: UN/1
 F1 F4



POTE PLAST MANT 2,5LTS QUAD CAFE 245

Código: 40368
 Fábrica: FORMPLAST
 Unidade: UN/1
 F1 F4



POTE PLAST MANT 2,5LTS QUAD FARINHA 243

Código: 40366
 Fábrica: FORMPLAST
 Unidade: UN/1
 F1 F4



POTE PLAST MANT 2,5LTS QUAD FEIJAO 242

Código: 40365
 Fábrica: FORMPLAST
 Unidade: UN/1
 F1 F4



POTE PLAST RED 5LTS PREMIUM FACILITT 155
 Código: 45190 Fábrica: RISCHIOTO Unidade: UN/1
 F1 F4



POTE PLAST RET ALTO 4,2LTS 342
 Código: 45196 Fábrica: RISCHIOTO Unidade: UN/1
 F1 F4



POTE PLAST RET FACILITTA ALTO 2,5LTS 341
 Código: 45191 Fábrica: RISCHIOTO Unidade: UN/1
 F1 F4



POTE PLAST RET 2,75L C/TRAVA 3312
 Código: 47055 Fábrica: JAGUAR Unidade: UN/1
 F1 F4

28cm
 10cm
 19cm



POTE PLAST RET 3,6LTS 1666
 Código: 6195 Fábrica: JAGUAR Unidade: UN/1
 F1 F4

30cm
 10cm
 20cm



POTE PLAST RET 5LTS C/TRAVA 3313
 Código: 47057 Fábrica: JAGUAR Unidade: UN/1
 F1 F4

28cm
 17cm
 19cm



POTE PLAST RET 850 ML C/TRAVA 3306
 Código: 47044 Fábrica: JAGUAR Unidade: UN/1
 F1 F4

17cm
 8cm
 19cm



POTE PLAST SUPERCLICK 800ML 1545 UN
 Código: 45442 Fábrica: TRITEC Unidade: UN/1
 F1 F4

6,5 cm
 22 cm
 1250ml



POTE PLAST 1250 ML RET CLICK G 75832
 Código: 40396 Fábrica: UN-ART Unidade: UN/1
 F1 F4

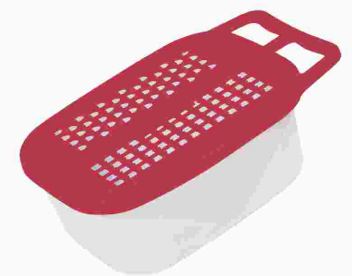

POTE PLAST 1,4 LTS C/RALADOR COLOR 4035
 Código: 40376 Fábrica: FORMPLAST Unidade: UN/1
 F1 F4



POTE PLAST 1,5 LTS COLOR 819
 Código: 45843 Fábrica: LUMAR Unidade: UN/1
 F1 F4



POTE PLAST 1,7 LTS DUPLO COLOR 14
 Código: 40372 Fábrica: FORMPLAST Unidade: UN/1
 F1 F4



POTE PLAST 2 LTS ALTO FRUTAS 002
 Código: 36530 Fábrica: MAXIMAPLASTI Unidade: UN/1
 F1 F4













POTE PLAST 2,5 LT RED P/ ALIMENT 4009
 Código: 13912 Fábrica: SBRISSA Unidade: UN/1
 F1 F4



POTE PLAST 2,5 LT RED P/ALIMENT DEC 8015
 Código: 35220 Fábrica: SBRISSA Unidade: UN/1
 F1 F4



POTE PLAST 3 LTS ALTO FRUTAS 003
 Código: 36529 Fábrica: MAXIMAPLASTI Unidade: UN/1
 F1 F4

 <p>4,5 cm 15,5 cm 380 ml</p> <p>POTE PLAST 380 ML RET CLICK P 75820</p> <p>Código: 40394 Fábrica: UN-ART Unidade: UN/1 F1 F4</p>	 <p>POTE PLAST 4,5LTS C/ROSCA SPINLOCK 7704</p> <p>Código: 50230 Fábrica: RISCHIOTO Unidade: UN/1 F1 F4</p>	 <p>POTE PLAST 5 LTS ALTO FRUTAS 004</p> <p>Código: 36528 Fábrica: MAXIMAPLASTI Unidade: UN/1 F1 F4</p>	 <p>5,5 cm 18,5 cm 740 ml</p> <p>POTE PLAST 740 ML RET CLICK M 75826</p> <p>Código: 40395 Fábrica: UN-ART Unidade: UN/1 F1 F4</p>
 <p>POTE PLAST 800ML QUAD TRANSP TP AZUL PER</p> <p>Código: 40134 Fábrica: KOZI PLAST Unidade: UN/1 F1 F4</p>	 <p>POTE PLAST 800ML QUAD TRANSP TP BRANCA</p> <p>Código: 40133 Fábrica: KOZI PLAST Unidade: UN/1 F1 F4</p>	 <p>POTE PLAST 800ML RED TRANSP TP AZUL PER</p> <p>Código: 40139 Fábrica: KOZI PLAST Unidade: UN/1 F1 F4</p>	 <p>POTE PLAST 800ML RED TRANSP TP AZUL ROY</p> <p>Código: 40140 Fábrica: KOZI PLAST Unidade: UN/1 F1 F4</p>
 <p>POTE PLAST 800ML RED TRANSP TP BRANCA</p> <p>Código: 40138 Fábrica: KOZI PLAST Unidade: UN/1 F1 F4</p>	 <p>POTE PLAST 800ML RED TRANSP TP ROSA PER</p> <p>Código: 40141 Fábrica: KOZI PLAST Unidade: UN/1 F1 F4</p>	 <p>POTE VIDRO 1 LT C/TPA PLAST 22011</p> <p>Código: 46889 Fábrica: SATYAM Unidade: UN/1 F1 F4</p>	 <p>POTE VIDRO 1,0 L C/TPA PLAST 0017</p> <p>Código: 35096 Fábrica: SATYAM Unidade: UN/1 F1 F4</p>
 <p>POTE VIDRO 1,0 L C/TPA PLAST 0022</p> <p>Código: 35097 Fábrica: SATYAM Unidade: UN/1 F1 F4</p>	 <p>POTE VIDRO 1,0 L C/TPA PLAST 9426</p> <p>Código: 47316 Fábrica: CASITA Unidade: UN/1 F1 F4</p>	 <p>POTE VIDRO 720 ML C/TPA PLAST 0016</p> <p>Código: 35098 Fábrica: SATYAM Unidade: UN/1 F1 F4</p>	 <p>PRATO ALUM FUNDO 1290</p> <p>Código: 37253 Fábrica: MSR/YANG Unidade: UN/1 F1 F4</p>



PRATO ALUM LEVE ESCOLAR

Código: 27596
 Fábrica: AVELAR
 Unidade: UN/1
 F1 F4



PRATO CERAMICA BCO RASO LISO 10.5 12X1

Código: 41460
 Fábrica: MABEL
 Unidade: CX/12
 F1 F4



PRATO DESCARTAVEL FUNDO N20 10UN

Código: 48319
 Fábrica: COPOPLAST
 Unidade: PT/1
 F1 F4



PRATO INF FUNDO DECORADO 1648

Código: 7964
 Fábrica: PLASUTIL
 Unidade: UN/1
 F1 F4



PRATO MELAMINE FUNDO 20 CM 528P

Código: 10059
 Fábrica: IDEA
 Unidade: UN/1
 F1 F4



PRATO PL 09 PRETO 9X25CM 222

Código: 37709
 Fábrica: BIG PLAST
 Unidade: UN/1
 F1 F4



PRATO PL 1 RED PRETO

Código: 18462
 Fábrica: NUTRIPLAN
 Unidade: UN/1
 F1 F4



PRATO PL 11 PRETO 11X2,5CM 224

Código: 37708
 Fábrica: BIG PLAST
 Unidade: UN/1
 F1 F4



PRATO PL 1,2 RED PEQ AMARELO CLARO

Código: 34596
 Fábrica: NUTRIPLAN
 Unidade: UN/1
 F1 F4



PRATO PL 1,2 RED PEQ LILAS CLARO

Código: 34597
 Fábrica: NUTRIPLAN
 Unidade: UN/1
 F1 F4



PRATO PL 1,2 RED PEQ ROSA BEBE

Código: 34599
 Fábrica: NUTRIPLAN
 Unidade: UN/1
 F1 F4



PRATO PL 1,2 RED PEQ VERDE CLARO

Código: 34598
 Fábrica: NUTRIPLAN
 Unidade: UN/1
 F1 F4



PRATO PL 1,5 RED PEQ MARROM

Código: 22296
 Fábrica: NUTRIPLAN
 Unidade: UN/1
 F1 F4



PRATO PL 1,5 RED PEQ PRETO

Código: 18463
 Fábrica: NUTRIPLAN
 Unidade: UN/1
 F1 F4



PRATO PL 2 RED MARROM

Código: 30286
 Fábrica: NUTRIPLAN
 Unidade: UN/1
 F1 F4



PRATO PL 2 RED PRETO

Código: 18464
 Fábrica: NUTRIPLAN
 Unidade: UN/1
 F1 F4

3 cm
21 cm



PRATO PL 3 RED MARROM

Código: **30288** Fábrica: **NUTRIPLAN** Unidade: **UN/1**
F1 F4

3 cm
21 cm



PRATO PL 3 RED PRETO

Código: **18465** Fábrica: **NUTRIPLAN** Unidade: **UN/1**
F1 F4

3,5 cm
23 cm



PRATO PL 4 RED MARROM

Código: **18484** Fábrica: **NUTRIPLAN** Unidade: **UN/1**
F1 F4

3,5 cm
23 cm



PRATO PL 4 RED PRETO

Código: **18466** Fábrica: **NUTRIPLAN** Unidade: **UN/1**
F1 F4

4 cm
26 cm



PRATO PL 5 MARROM

Código: **30289** Fábrica: **NUTRIPLAN** Unidade: **UN/1**
F1 F4

4 cm
26 cm



PRATO PL 5 PRETO

Código: **30290** Fábrica: **NUTRIPLAN** Unidade: **UN/1**
F1 F4

4 cm
28 cm



PRATO PL 6 RED PRETO

Código: **18467** Fábrica: **NUTRIPLAN** Unidade: **UN/1**
F1 F4

4,5 cm
29 cm



PRATO PL 7 MARROM

Código: **18485** Fábrica: **NUTRIPLAN** Unidade: **UN/1**
F1 F4

4,5 cm
29 cm



PRATO PL 7 RED PRETO

Código: **18468** Fábrica: **NUTRIPLAN** Unidade: **UN/1**
F1 F4



PRATO PL 8 RED PRETO

Código: **18469** Fábrica: **NUTRIPLAN** Unidade: **UN/1**
F1 F4

5,5 cm
36 cm



PRATO PL 9 PRETO

Código: **30291** Fábrica: **NUTRIPLAN** Unidade: **UN/1**
F1 F4

3,4 cm
17 cm



PRATO PL FLOREIRA 1 MARROM

Código: **18511** Fábrica: **NUTRIPLAN** Unidade: **UN/1**
F1 F4

3,4 cm
17 cm



PRATO PL FLOREIRA 1 17CM MARMORE

Código: **22299** Fábrica: **NUTRIPLAN** Unidade: **UN/1**
F1 F4

11 cm
35 cm

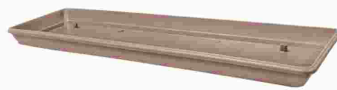

PRATO PL JARDINEIRA 35CM CAPUCCINO

Código: **35206** Fábrica: **NUTRIPLAN** Unidade: **UN/1**
F1 F4

11 cm
35 cm



PRATO PL JARDINEIRA 35CM CINZA

Código: **35207** Fábrica: **NUTRIPLAN** Unidade: **UN/1**
F1 F4

35 cm

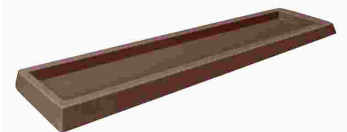

PRATO PL JARDINEIRA 35CM TABACO

Código: **33907** Fábrica: **NUTRIPLAN** Unidade: **UN/1**
F1 F4

11cm
50cm



PRATO PL JARDINEIRA 50 CM CAPUCCINO

Código: 35208 Fábrica: NUTRIPLAN Unidade: UN/1
F1 F4

11cm
50cm

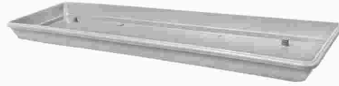

PRATO PL JARDINEIRA 50 CM CINZA

Código: 35209 Fábrica: NUTRIPLAN Unidade: UN/1
F1 F4

11 cm
35cm



PRATO PL JARDINEIRA 80 CM CAPUCCINO

Código: 35461 Fábrica: NUTRIPLAN Unidade: UN/1
F1 F4

11 cm
35cm

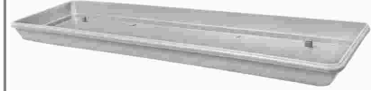

PRATO PL JARDINEIRA 80 CM CINZA

Código: 35462 Fábrica: NUTRIPLAN Unidade: UN/1
F1 F4

1,5 cm
8,5 cm



PRATO PL MINI FLOREIRA QUAD MARMORE

Código: 22298 Fábrica: NUTRIPLAN Unidade: UN/1
F1 F4

1,5 cm
8,5 cm



PRATO PL MINI FLOREIRA QUAD MARROM

Código: 22297 Fábrica: NUTRIPLAN Unidade: UN/1
F1 F4

1,5 cm
8,5 cm



PRATO PL MINI FLOREIRA QUAD PRETO

Código: 30208 Fábrica: NUTRIPLAN Unidade: UN/1
F1 F4



PRATO PL 0,5 RED PEQ AMARELO CLARO

Código: 35713 Fábrica: NUTRIPLAN Unidade: UN/1
F1 F4



PRATO PL 0,5 RED PEQ LILAS CLARO

Código: 35714 Fábrica: NUTRIPLAN Unidade: UN/1
F1 F4



PRATO PL 0,5 RED PEQ ROSA BEBE

Código: 35715 Fábrica: NUTRIPLAN Unidade: UN/1
F1 F4



PRATO PL 0,5 RED PEQ VERDE CLARO

Código: 35716 Fábrica: NUTRIPLAN Unidade: UN/1
F1 F4



PRATO PL 10 MARROM

Código: 30292 Fábrica: NUTRIPLAN Unidade: UN/1
F1 F4

6 cm
41 cm

3cm
14cm



PRATO PL 14 PRETO 14X3CM 226

Código: 47291 Fábrica: BIG PLAST Unidade: UN/1
F1 F4



PRATO PL 14 RED 14CM PRETO 344

Código: 40847 Fábrica: JOREAL Unidade: UN/1
F1 F4

3,5 cm
17 cm



PRATO PL 17 PRETO 17X3,5CM 228

Código: 37707 Fábrica: BIG PLAST Unidade: UN/1
F1 F4

3,5cm
20cm



PRATO PL 20 PRETO 20X3,5CM 230

Código: 47290 Fábrica: BIG PLAST Unidade: UN/1
F1 F4

5 3,5cm
22cm



PRATO PL 22 PRETO 22X3,5CM 232

Código: 37706 Fábrica: BIG PLAST Unidade: UN/1 F1 F4

5 5 cm
30 cm



PRATO PL 29 QUAD TEXTUR AREIA

Código: 30342 Fábrica: NUTRIPLAN Unidade: UN/1 F1 F4

5 5 cm
30 cm



PRATO PL 29 QUAD TEXTUR FERRUGEM

Código: 30343 Fábrica: NUTRIPLAN Unidade: UN/1 F1 F4

5 5 cm
34 cm



PRATO PL 33 QUAD TEXTUR FERRUGEM

Código: 30344 Fábrica: NUTRIPLAN Unidade: UN/1 F1 F4

5 05 cm
43 cm



PRATO PL 41 RED TEXTUR AREIA

Código: 36795 Fábrica: NUTRIPLAN Unidade: UN/1 F1 F4

5 5 cm
43 cm



PRATO PL 41 RED TEXTUR FERRUGEM

Código: 30345 Fábrica: NUTRIPLAN Unidade: UN/1 F1 F4

5 5 cm
46 cm



PRATO PL 44 QUAD LISO AREIA

Código: 30346 Fábrica: NUTRIPLAN Unidade: UN/1 F1 F4

5 5 cm
47 cm



PRATO PL 46 RED LISO FERRUGEM

Código: 30341 Fábrica: NUTRIPLAN Unidade: UN/1 F1 F4

5 5 cm
50 cm



PRATO PL 47 RED TEXTUR FERRUGEM

Código: 30347 Fábrica: NUTRIPLAN Unidade: UN/1 F1 F4

5 5 cm
56 cm



PRATO PL 50 RED TEXTUR AREIA

Código: 36283 Fábrica: NUTRIPLAN Unidade: UN/1 F1 F4



PRATO PLAST FUNDO KIDS CORES 21X30CM 756

Código: 46643 Fábrica: QUALYPLAS Unidade: UN/1 F1 F4



PRATO PLAST FUNDO 3000

Código: 20712 Fábrica: SBRISSA Unidade: UN/1 F1 F4

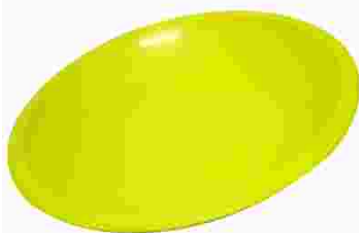

PRATO PLAST INF FUNDO 22 CM C/ABA 1276

Código: 18213 Fábrica: ECOPLASTIC Unidade: UN/1 F1 F4



PRATO PLAST INF RASO 20 CM S/ABA 1278

Código: 22322 Fábrica: ECOPLASTIC Unidade: UN/1 F1 F4



PRATO PLAST RASO 3007

Código: 14576 Fábrica: SBRISSA Unidade: UN/1 F1 F4



PRATO PORC FUNDO FEST BCO 23CM 7507 6X1

Código: 35059 Fábrica: CHEF LINE Unidade: PT/6 F1 F4



PRATO PORC FUNDO QUAD BCO 24CM 7500 6X1
 Código: 35060 Fábrica: CHEF LINE Unidade: PT/6 F1 F4



PRATO PORC FUNDO RED BCO 24CM 7504 6X1
 Código: 35058 Fábrica: CHEF LINE Unidade: PT/6 F1 F4

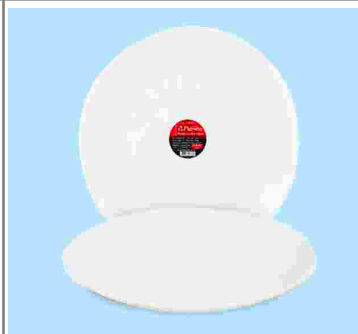

PRATO VIDRO RASO RED BCO 26,67CM 631 6X1
 Código: 48680 Fábrica: PLANETA Unidade: CX/6 F1 F4



PRATO VIDRO TRANSP FUNDO 22CM MILLY 4X1
 Código: 50167 Fábrica: WELLMIX Unidade: CJ/4 F1 F4



PRENDEDOR ROUPAS MADEIRA 7CM 12X1
 Código: 23765 Fábrica: AGUIA BRANCA Unidade: DZ/12 F1 F4



PRENDEDOR ROUPAS MADEIRA 7,2CM 36X1
 Código: 47001 Fábrica: PRENDE MAIS Unidade: PT/36 F1 F4



PRENDEDOR ROUPAS MADEIRA 9CM 12X1
 Código: 47000 Fábrica: PRENDE MAIS Unidade: DZ/12 F1 F4



PRENDEDOR ROUPAS PLAST GDE 25X12
 Código: 41238 Fábrica: POLICORDA Unidade: PT/300 F1 F4



PRENDEDOR ROUPAS PLAST 7CM 12X1 49 A
 Código: 27432 Fábrica: DEBIASI Unidade: DZ/12 F1 F4



PRENDEDOR ROUPAS PLAST 8,5CM 12X1
 Código: 24652 Fábrica: PRENDE MAIS Unidade: DZ/12 F1 F4



PREPARO P/ORQUIDEAS 1KG
 Código: 32771 Fábrica: VITAPLAN Unidade: UN/1 F1 F4



PROCESSADOR PLAST ALIMENTOS MANUAL 200ML
 Código: 44518 Fábrica: NICOBEM Unidade: UN/1 F1 F4



PROCESSADOR PLAST ALIMENTOS MANUAL 450ML
 Código: 39793 Fábrica: HAI BRASIL Unidade: UN/1 F1 F4



PROCESSADOR PLAST ALIMENTOS MANUAL 500ML
 Código: 40342 Fábrica: PLANETA Unidade: UN/1 F1 F4



PROCESSADOR PLAST ALIMENTOS MANUAL 500ML
 Código: 50138 Fábrica: GP6 Unidade: UN/1 F1 F4



PROCESSADOR PLAST ALIMENTOS MANUAL 500ML
 Código: 49651 Fábrica: WINCY Unidade: UN/1 F1 F4



18 cm

PROCESSADOR PLAST ALIMENTOS USB 220ML779
 Código: 41598 Fábrica: EMILAR Unidade: UN/1
 F1 F4



PULVERIZADOR BOMBA FLITZ 3267
 Código: 50967 Fábrica: FGB Unidade: UN/1
 F1 F4



29 cm

PULVERIZADOR DE COMPRESSAO PREVIA 1,2 LT
 Código: 38649 Fábrica: GUARANY Unidade: UN/1
 F1 F4



PULVERIZADOR PET PLAST 500ML TRANSP 7631
 Código: 47358 Fábrica: ALTIHOME Unidade: UN/1
 F1 F4



PULVERIZADOR PLAST P/GARRAFA PET 4017
 Código: 50146 Fábrica: GP6 Unidade: UN/1
 F1 F4



PULVERIZADOR PLAST 300 ML DISPENSER 001
 Código: 49377 Fábrica: RIOHOME Unidade: UN/1
 F1 F4



PULVERIZADOR PLAST 350 ML QUALITY 843
 Código: 35831 Fábrica: LUMAR Unidade: UN/1
 F1 F4



PULVERIZADOR PLAST 450 ML QUALITY 842
 Código: 35832 Fábrica: LUMAR Unidade: UN/1
 F1 F4



20 cm
 500 ml

PULVERIZADOR PLAST 500 ML TRANSP 5028
 Código: 39375 Fábrica: ARBRA Unidade: UN/1
 F1 F4



PULVERIZADOR PLAST 500 ML VERDE
 Código: 37222 Fábrica: NUTRIPLAN Unidade: UN/1
 F1 F4



PULVERIZADOR PLAST 500ML TRANSP 35654
 Código: 44098 Fábrica: NOBRE Unidade: UN/1
 F1 F4



PULVERIZADOR PLAST 550 ML GIRAFÁ 430150
 Código: 38894 Fábrica: PLASDURAN Unidade: UN/1
 F1 F4



PULVERIZADOR PLAST 580 ML AZUL
 Código: 18503 Fábrica: NUTRIPLAN Unidade: UN/1
 F1 F4



PULVERIZADOR PLAST 750 ML QUALITY 847
 Código: 35835 Fábrica: LUMAR Unidade: UN/1
 F1 F4



PUXA SACO
 Código: 11337 Fábrica: MC PANOS Unidade: UN/1
 F1 F4

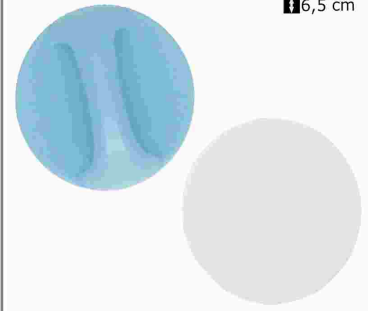

6,5 cm

PUXADOR PLAST AUTO COLANTE 6,5CM 106-9
 Código: 44520 Fábrica: NICOBEM Unidade: UN/1
 F1 F4



PUXADOR P/TAMPA DE PAINEL 105753113 2X1

Código: 33444 Fábrica: MAXPING Unidade: UN/1
F1 F4



11 46 cm
22 38 cm

QUADRO PL PAINEL 1 PINUS 3004

Código: 37163 Fábrica: PAIOL Unidade: UN/1
F1 F4



11 57 cm
22 46 cm

QUADRO PL PAINEL 2 PINUS 3005

Código: 37164 Fábrica: PAIOL Unidade: UN/1
F1 F4



11 63 cm
22 57 cm

QUADRO PL PAINEL 3 PINUS 3006

Código: 37165 Fábrica: PAIOL Unidade: UN/1
F1 F4



11 93 cm
22 39 cm

QUADRO PL PAINEL 4 PINUS 3007

Código: 37166 Fábrica: PAIOL Unidade: UN/1
F1 F4



11 115 cm
22 46 cm

QUADRO PL PAINEL 5 PINUS 3008

Código: 37167 Fábrica: PAIOL Unidade: UN/1
F1 F4

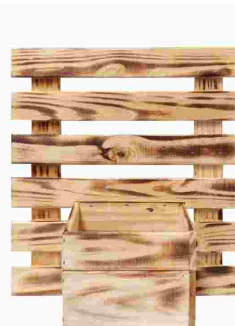

11 38 cm
22 40 cm

QUADRO PL 1 CRISANTEMO PINUS ENV 3201-2

Código: 37162 Fábrica: PAIOL Unidade: UN/1
F1 F4



11 40 cm
22 37,5 cm

QUADRO PL 1 CRISANTEMO PINUS PINT 3201-1

Código: 39469 Fábrica: PAIOL Unidade: UN/1
F1 F4



11 33 cm
22 28 cm

QUADRO PL 1 VIOLETA PINOS PINTADO 0024-1

Código: 37156 Fábrica: PAIOL Unidade: UN/1
F1 F4

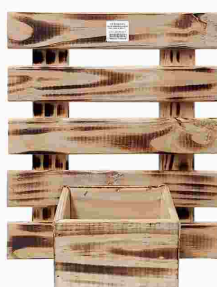

11 33 cm
22 28 cm

QUADRO PL 1 VIOLETA PINUS ENVELHE 0024-2

Código: 37155 Fábrica: PAIOL Unidade: UN/1
F1 F4



11 47 cm
22 43 cm

QUADRO PL 2 CRISANTEMO PINUS ENV 3200-2

Código: 37161 Fábrica: PAIOL Unidade: UN/1
F1 F4



11 47 cm
22 43 cm

QUADRO PL 2 CRISANTEMO PINUS PINT 3200-1

Código: 37957 Fábrica: PAIOL Unidade: UN/1
F1 F4

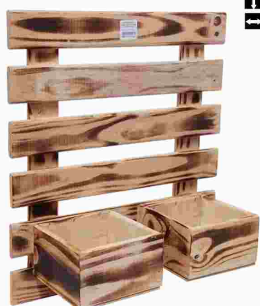

11 40 cm
22 38 cm

QUADRO PL 2 VIOLETAS PINUS ENVEHECI 26-1

Código: 37158 Fábrica: PAIOL Unidade: UN/1
F1 F4



11 40 cm
22 38 cm

QUADRO PL 2 VIOLETAS PINUS PINTADO 26-2

Código: 37157 Fábrica: PAIOL Unidade: UN/1
F1 F4



11 40 cm
22 47 cm

QUADRO PL 3 VIOLETAS PINUS ENVELHEC 23-2

Código: 37159 Fábrica: PAIOL Unidade: UN/1
F1 F4

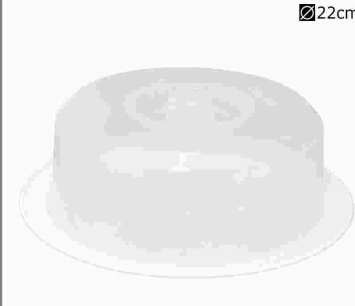

22 22cm

QUEIJEIRA PLAST 0027

Código: 4269 Fábrica: JAGUAR Unidade: UN/1
F1 F4

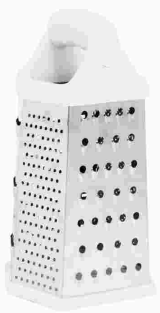

RALADOR INOX 6 FACES CB PLAST BRANCO 59
 Código: 46584 Fábrica: HERCULES Unidade: UN/1
 F1 F4



RALADOR 1 FACE INOX 25CM 062
 Código: 47327 Fábrica: NIX Unidade: UN/1
 F1 F4



RALADOR 4 FACES FLANDRES CB PLAST 3201
 Código: 38331 Fábrica: VIEL Unidade: UN/1
 F1 F4

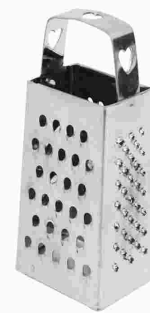

RALADOR 4 FACES INOX MINI 14713
 Código: 46493 Fábrica: NICOBEM Unidade: UN/1
 F1 F4

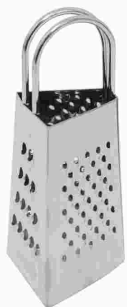

RALADOR 4 FACES INOX MINI 8CM 272
 Código: 48681 Fábrica: PLANETA Unidade: UN/1
 F1 F4



RALADOR 4 FACES PLAST 732
 Código: 35845 Fábrica: LUMAR Unidade: UN/1
 F1 F4



RALADOR 6 FACES INOX 22CM CB METAL 12946
 Código: 41290 Fábrica: GP6 Unidade: UN/1
 F1 F4



RALINHO INOX P/PIA 5,2CM CTL 348
 Código: 44502 Fábrica: PLANETA Unidade: CR/1
 F1 F4



RALINHO INOX P/PIA 5,5CM CTL 4472
 Código: 49630 Fábrica: WINMAX Unidade: CR/1
 F1 F4

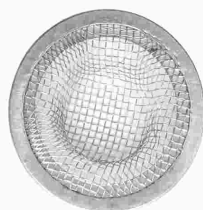

RALINHO TELA GALV P/PIA 4,5 CM 1011 12X1
 Código: 13446 Fábrica: JWC Unidade: DZ/12
 F1 F4



RALINHO TELA GALV P/PIA 7 CM G 1010 12X1
 Código: 25222 Fábrica: JWC Unidade: DZ/12
 F1 F4



RALO INOX P/PIA 7CM CTL MG-2984
 Código: 40303 Fábrica: MEGAGIFT Unidade: CR/1
 F1 F4



RALO OCULTO SIFONADO 150X150MM BEGE
 Código: 48608 Fábrica: REBOUCAS Unidade: UN/1
 F1 F4



RALO OCULTO SIFONADO 150X150MM BRANCO
 Código: 48604 Fábrica: REBOUCAS Unidade: UN/1
 F1 F4

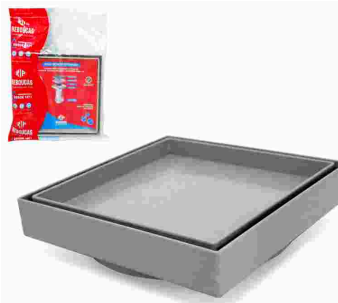

RALO OCULTO SIFONADO 150X150MM CINZA
 Código: 48606 Fábrica: REBOUCAS Unidade: UN/1
 F1 F4



RALO OCULTO SIFONADO 150X150MM MARROM
 Código: 48607 Fábrica: REBOUCAS Unidade: UN/1
 F1 F4



RALO OCULTO SIFONADO 150X150MM PRETO

Código: **48605** Fábrica: **REBOUCAS** Unidade: **UN/1**
F1 F4



REFRESQUEIRA ALUM LEVE 14 1,2 LTS

Código: **5894** Fábrica: **AVELAR** Unidade: **UN/1**
F1 F4



REGADOR ALUM MEDIO 600 ML 648

Código: **39542** Fábrica: **BMC ALUMINIO** Unidade: **UN/1**
F1 F4



REGADOR PLAST 5 LTS RECICL VERDE 7006

Código: **49519** Fábrica: **ARBRA** Unidade: **UN/1**
F1 F4



REGADOR PLAST 8 LTS RECICL PRETO 7004

Código: **9513** Fábrica: **ARBRA** Unidade: **UN/1**
F1 F4



REGADOR PLAST 8 LTS RECICL VERDE 7005

Código: **39373** Fábrica: **ARBRA** Unidade: **UN/1**
F1 F4



REGADOR PLAST PEQ 1,5LT C/CHUVEIRO LILAS

Código: **46044** Fábrica: **NUTRIPLAN** Unidade: **UN/1**
F1 F4



REGADOR PLAST PEQ 1,5LT C/CHUVEIRO ROSA

Código: **46043** Fábrica: **NUTRIPLAN** Unidade: **UN/1**
F1 F4



REGADOR PLAST 10 LTS RECICL PRETO 7001

Código: **49518** Fábrica: **ARBRA** Unidade: **UN/1**
F1 F4



REGADOR PLAST 10 LTS RECICL VERDE 7002

Código: **44981** Fábrica: **ARBRA** Unidade: **UN/1**
F1 F4



REGISTRO PRESSAO PVC BCO C/VOL 51N 12X1

Código: **40159** Fábrica: **REBOUCAS** Unidade: **PT/12**
F1 F4



REGISTRO PRESSAO PVC BCO C/VOL 52N 12X1

Código: **40158** Fábrica: **REBOUCAS** Unidade: **PT/12**
F1 F4



REGISTRO PRESSAO PVC BCO C/VOL 53N 12X1

Código: **40157** Fábrica: **REBOUCAS** Unidade: **PT/12**
F1 F4



REGISTRO PRESSAO PVC BCO C/VOL 54N 12X1

Código: **40162** Fábrica: **REBOUCAS** Unidade: **PT/12**
F1 F4



REGISTRO PRESSAO PVC MARR C/VOL 55N 12X1

Código: **40160** Fábrica: **REBOUCAS** Unidade: **PT/12**
F1 F4



REGISTRO PRESSAO PVC MARR C/VOL 56N 12X1

Código: **40161** Fábrica: **REBOUCAS** Unidade: **PT/12**
F1 F4



REGULADOR GAS 1KG COMPLETO 14400 163
 Código: 47760 Fábrica: VINIGAS Unidade: UN/1
 F1 F4



REGULADOR GAS 1KG C/REGISTRO 14300 162
 Código: 47882 Fábrica: VINIGAS Unidade: UN/1
 F1 F4

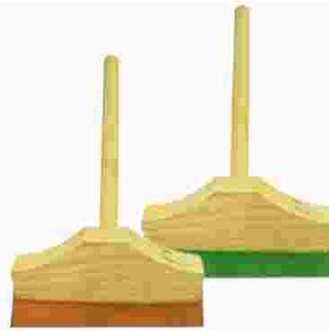

RODINHO DE PIA CABO MADEIRA 37
 Código: 6293 Fábrica: N.HORIZONTE Unidade: UN/1
 F1 F4



RODINHO DE PIA CABO PLAST 83
 Código: 48937 Fábrica: N.HORIZONTE Unidade: UN/1
 F1 F4



RODINHO PLAST PIA COLOR 744
 Código: 44085 Fábrica: QUALYPLAS Unidade: UN/1
 F1 F4



RODIZIO METAL E PLAST GIRATORIO C/FREIO
 Código: 50834 Fábrica: GP6 Unidade: UN/1
 F1 F4



RODO ALUM 40 CM C/CABO ALUM
 Código: 50913 Fábrica: SANCHES Unidade: UN/1
 F1 F4



RODO ALUM 60 CM C/CABO ALUM
 Código: 50631 Fábrica: SANCHES Unidade: UN/1
 F1 F4



RODO FIORY 30CM CM C/CABO MADEIRA UN
 Código: 47252 Fábrica: SHANGRILA Unidade: UN/1
 F1 F4



RODO FIORY 40CM CM C/CABO MADEIRA UN
 Código: 47253 Fábrica: SHANGRILA Unidade: UN/1
 F1 F4



RODO FIORY 60CM CM C/CABO MADEIRA UN
 Código: 47254 Fábrica: SHANGRILA Unidade: UN/1
 F1 F4



RODO MADEIRA 30CM 2700 12X1
 Código: 37977 Fábrica: DALCIN Unidade: PT/12
 F1 F4



RODO PLAST P/LIMPAR VIDRO 30X26CM 110-19
 Código: 40659 Fábrica: CASA ONZE Unidade: UN/1
 F1 F4



RODO PLAST PUXA SECA 30CM C/CB 5109 12X1
 Código: 49814 Fábrica: EDS Unidade: PT/12
 F1 F4



RODO PLAST PUXA SECA 60 CM C/CABO 5123
 Código: 49808 Fábrica: EDS Unidade: UN/1
 F1 F4

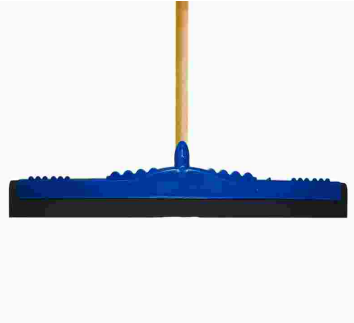

RODO PLAST 60 CM C/CABO MAD 85
 Código: 50234 Fábrica: HALLEY Unidade: UN/1
 F1 F4

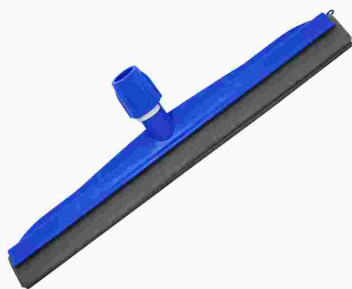

RODO 45CM DRY BRALIMPIA AZUL S/CABO

Código: 46721
 Fábrica: BRALIMPIA
 Unidade: UN/1
 F1 F4



ROLETE PLAST P/PAPEL HIGIENICO 1053 12X1

Código: 33289
 Fábrica: JWC
 Unidade: PT/1
 F1 F4

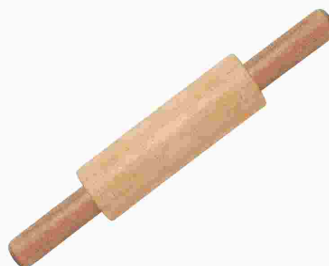

ROLO MADEIRA P/MASSA 107

Código: 41319
 Fábrica: MAD LAR
 Unidade: UN/1
 F1 F4



40cm

ROLO MADEIRA P/MASSA 4,5X40CM 083

Código: 47900
 Fábrica: CASITA
 Unidade: UN/1
 F1 F4



SABONETEIRA PET PLAST 500ML TRANSP 7632

Código: 47359
 Fábrica: ALTHOME
 Unidade: UN/1
 F1 F4



10cm

SABONETEIRA PLAST C/TELA 605

Código: 12167
 Fábrica: JAGUAR
 Unidade: UN/1
 F1 F4



SACO P/LAVAR ROUPA 30X40CM 19006/15885

Código: 36951
 Fábrica: ALIANCA
 Unidade: UN/1
 F1 F4



SACOLA NYLON 20X38CM MARIA C/BOTAO

Código: 27404
 Fábrica: FERREIRA
 Unidade: UN/1
 F1 F4



SACOLA NYLON 24X36CM P UTIL C/ZIPER

Código: 27401
 Fábrica: FERREIRA
 Unidade: UN/1
 F1 F4



SACOLA NYLON 32X29CM TULIPA

Código: 29114
 Fábrica: FERREIRA
 Unidade: UN/1
 F1 F4



SACOLA NYLON 37X36CM ECONOMICA TRAD

Código: 27402
 Fábrica: FERREIRA
 Unidade: UN/1
 F1 F4



SACOLA NYLON 39X41CM M TRAD

Código: 27400
 Fábrica: FERREIRA
 Unidade: UN/1
 F1 F4



SACOLA NYLON 40X39CM FERREIRA

Código: 27403
 Fábrica: FERREIRA
 Unidade: UN/1
 F1 F4



SACOLA PLAST PRES 20X30CM ESTAMP 100X1

Código: 49637
 Fábrica: WINMAX
 Unidade: PT/100
 F1 F4



SACOLA PLAST PRES 25X35CM ESTAMP 100X1

Código: 49638
 Fábrica: WINMAX
 Unidade: PT/100
 F1 F4



SACOLA PLAST PRES 30X40CM ESTAMP 100X1

Código: 49639
 Fábrica: WINMAX
 Unidade: PT/100
 F1 F4



SACOLA PLAST PRES 35X45CM ESTAMP 100X1
 Código: 49640 Fábrica: WINMAX Unidade: PT/100
 F1 F4

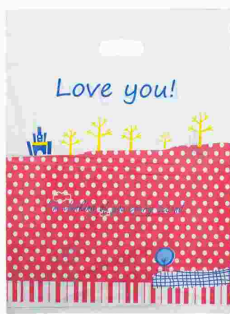

SACOLA PLAST PRES 40X50CM ESTAMP 100X1
 Código: 49641 Fábrica: WINMAX Unidade: PT/100
 F1 F4



SACOLA PLAST 45X50X20CM ESTAMP 150-11
 Código: 42402 Fábrica: NICOBEM Unidade: UN/1
 F1 F4



SACOLA PLAST 60X45X20CM ESTAMP 756
 Código: 45911 Fábrica: WINMAX Unidade: UN/1
 F1 F4

45cm
 60cm
 20cm



SACOLA PLAST 800X60X25CM ESTAMP 758
 Código: 45912 Fábrica: WINMAX Unidade: UN/1
 F1 F4

60cm
 80cm
 25cm



SALADEIRA PLAST C/TAMPA GDE 10,0LTS 825
 Código: 39560 Fábrica: LUMAR Unidade: UN/1
 F1 F4

10 lts



SALADEIRA PLAST C/TAMPA GDE 3,0LTS 854
 Código: 39558 Fábrica: LUMAR Unidade: UN/1
 F1 F4

3 lts



SALADEIRA PLAST C/TAMPA GDE 6,0LTS 820
 Código: 39559 Fábrica: LUMAR Unidade: UN/1
 F1 F4

6 lts



SALADEIRA PLAST C/TAMPA MED 1,5LTS 853
 Código: 39557 Fábrica: LUMAR Unidade: UN/1
 F1 F4

1 lts



SALADEIRA PLAST C/TAMPA PEQ 800ML 852
 Código: 39556 Fábrica: LUMAR Unidade: UN/1
 F1 F4

0,8 lts



SALADEIRA PLAST C/TPA ONDUL 2,6 LTS 42
 Código: 49705 Fábrica: NOVA ERA Unidade: UN/1
 F1 F4

2,6 LTS

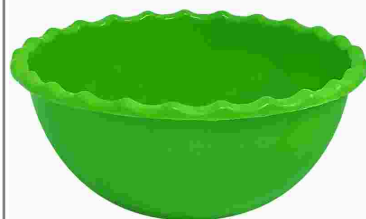

SALADEIRA PLAST GDE S/TAMPA 25X10CM 1053
 Código: 36962 Fábrica: ENGIPLAST Unidade: UN/1
 F1 F4



SALADEIRA PLAST MED S/TAMPA 20X8CM 1052
 Código: 36961 Fábrica: ENGIPLAST Unidade: UN/1
 F1 F4



SALADEIRA PLAST PEQ C/TAMPA 15X6CM 1055
 Código: 36957 Fábrica: ENGIPLAST Unidade: UN/1
 F1 F4



SALADEIRA PLAST PEQ S/TAMPA 15X6CM 1051
 Código: 36960 Fábrica: ENGIPLAST Unidade: UN/1
 F1 F4



SALEIRO CRISTAL P/MESA 700
 Código: 37260 Fábrica: LUMAR Unidade: UN/1
 F1 F4



SALEIRO PLAST GRANDE 366
 Código: 10174 Fábrica: TRITEC Unidade: UN/1
 F1 F4



SANDUICHEIRA REF 1315
 Código: 11029 Fábrica: PLASUTIL Unidade: UN/1
 F1 F4

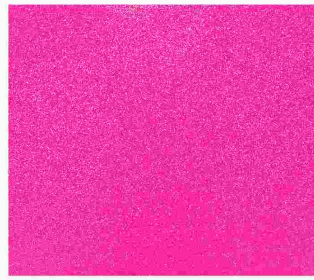

SELADORA PLAST 10X4CM PILHA AA 37-26
 Código: 46967 Fábrica: NICOBEM Unidade: UN/1
 F1 F4

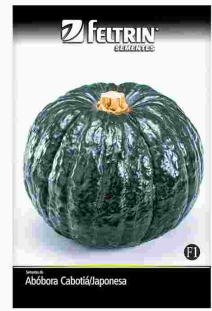

SEMENTE ABOBORA HIROKO 550MG 25X1
 Código: 33984 Fábrica: FELTRIN Unidade: PT/25
 F1 F4



SEMENTE ABOBRINHA CASERT ITAL 1,50G 25X1
 Código: 31427 Fábrica: FELTRIN Unidade: PT/25
 F1 F4



SEMENTE ALFACE AMERICANA 700MG 25X1
 Código: 31435 Fábrica: FELTRIN Unidade: PT/25
 F1 F4



SEMENTE ALFACE MONICA 700MG 25X1
 Código: 31423 Fábrica: FELTRIN Unidade: PT/25
 F1 F4



SEMENTE ALMEIRAO PAO D ACUCAR 700MG 25X1
 Código: 31410 Fábrica: FELTRIN Unidade: PT/25
 F1 F4



SEMENTE BERINGELA EMBU 400MG 25X1
 Código: 32288 Fábrica: FELTRIN Unidade: PT/25
 F1 F4



SEMENTE BETERRABA KATRINA 1,20G 25X1
 Código: 31419 Fábrica: FELTRIN Unidade: PT/25
 F1 F4



SEMENTE CEBOLINHA NEBUKA 400MG 25X1
 Código: 31440 Fábrica: FELTRIN Unidade: PT/25
 F1 F4



SEMENTE CENOURA BRASILIA IRECE 700G 25X1
 Código: 31413 Fábrica: FELTRIN Unidade: PT/25
 F1 F4



SEMENTE COENTRO PACIFICO 1,60G 25X1
 Código: 32283 Fábrica: FELTRIN Unidade: PT/25
 F1 F4



SEMENTE COENTRO VERDAO 1,6G 25X1
 Código: 31418 Fábrica: FELTRIN Unidade: PT/25
 F1 F4



SEMENTE COUVE MANTEIGA 1,00G 25X1
 Código: 31431 Fábrica: FELTRIN Unidade: PT/25
 F1 F4

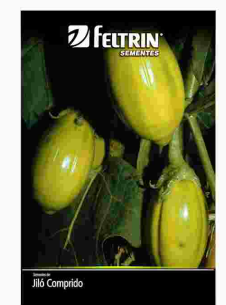

SEMENTE JILO COMPRIDO GDE RIO 400MG 25X1
 Código: 32302 Fábrica: FELTRIN Unidade: PT/25
 F1 F4



SEMENTE MAMAO FORMOSA 120MG 25X1

Código: **31422** Fábrica: **FELTRIN** Unidade: **PT/25 F1 F4**



SEMENTE MELAO GAUCHO 100MG 20X1

Código: **32291** Fábrica: **FELTRIN/HORT** Unidade: **PT/20 F1 F4**



SEMENTE MORANGA EXPOSITAO 2,00G 25X1

Código: **31439** Fábrica: **FELTRIN** Unidade: **PT/25 F1 F4**



SEMENTE PIMENTA BICO 400MG 25X1

Código: **31429** Fábrica: **FELTRIN** Unidade: **PT/25 F1 F4**



SEMENTE PIMENTA CAYENNE LONG 400MG 25X1

Código: **32290** Fábrica: **FELTRIN** Unidade: **PT/25 F1 F4**

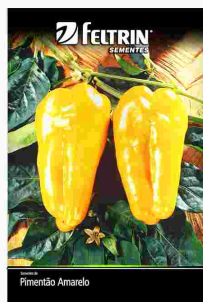

SEMENTE PIMENTA DEDO DE MOCA 400MG 25X1

Código: **49387** Fábrica: **FELTRIN** Unidade: **PT/25 F1 F4**



SEMENTE PIMENTAO AMARELO 400MG 25X1

Código: **49386** Fábrica: **FELTRIN** Unidade: **PT/25 F1 F4**



SEMENTE PIMENTAO RUBI GIGANTE 400MG 25X1

Código: **31412** Fábrica: **FELTRIN** Unidade: **PT/25 F1 F4**



SEMENTE QUIABO SANTA CRUZ 2,00G 25X1

Código: **31411** Fábrica: **FELTRIN** Unidade: **PT/25 F1 F4**



SEMENTE RABANETE CRIMSON GIG 1,40G 25X1

Código: **31432** Fábrica: **FELTRIN** Unidade: **PT/25 F1 F4**



SEMENTE RUCULA CULTIVADA 1G 25X1

Código: **31424** Fábrica: **FELTRIN** Unidade: **PT/25 F1 F4**



SEMENTE RUCULA FOLHA LARGA 700MG 25X1

Código: **32293** Fábrica: **FELTRIN** Unidade: **PT/25 F1 F4**



SEMENTE SALSA GRAUDA PORT NOV 900MG 25X1

Código: **31420** Fábrica: **FELTRIN** Unidade: **PT/25 F1 F4**



SEMENTE SALSA LISA 900MG 25X1

Código: **31434** Fábrica: **FELTRIN** Unidade: **PT/25 F1 F4**



SEMENTE TOMATE CAROLINA 100MG 25X1

Código: **31416** Fábrica: **FELTRIN** Unidade: **PT/25 F1 F4**



SEMENTE TOMATE YASHI 100MG 25X1

Código: **35086** Fábrica: **FELTRIN** Unidade: **PT/25 F1 F4**



SOCADOR FEIJAO 28 CM MADEIRA 115

Código: 1485
 Fábrica: MAD LAR
 Unidade: UN/1
 F1 F4



SOLO (SUBSTRATO) 2 KG

Código: 31469
 Fábrica: NOVATROPICAL
 Unidade: PT/1
 F1 F4



SOLO (SUBSTRATO) 5 KG

Código: 31470
 Fábrica: NOVATROPICAL
 Unidade: PT/1
 F1 F4



SOLO (SUBSTRATO) 20 KG

Código: 31472
 Fábrica: NOVATROPICAL
 Unidade: PT/1
 F1 F4



30cm

SOUPLA MDF 30CM 174

Código: 45986
 Fábrica: R A ARTESANA
 Unidade: UN/1
 F1 F4



SQUEEZE PLAST 300 ML (GALAOZINHO) 982

Código: 49707
 Fábrica: NOVA ERA
 Unidade: UN/1
 F1 F4



SQUEEZE PLAST 300 ML (GARRAFA) COLOR 972

Código: 49719
 Fábrica: NOVA ERA
 Unidade: UN/1
 F1 F4



SQUEEZE PLAST 350 ML 846

Código: 35843
 Fábrica: LUMAR
 Unidade: UN/1
 F1 F4



SQUEEZE PLAST 360ML REFIL FLAMENGO 10625

Código: 41106
 Fábrica: BRASFOOT
 Unidade: UN/1
 F1 F4



SQUEEZE PLAST 500 ML (GARRAFA) COLOR 962

Código: 49712
 Fábrica: NOVA ERA
 Unidade: UN/1
 F1 F4



SQUEEZE PLAST 600 ML (GARRAFA) QUAD 1199

Código: 49706
 Fábrica: NOVA ERA
 Unidade: UN/1
 F1 F4



SQUEEZE PLAST 750 ML (GARRAFA) COLOR 952

Código: 49709
 Fábrica: NOVA ERA
 Unidade: UN/1
 F1 F4



SQUEEZE 250 ML PLAST ARANHA 479

Código: 41636
 Fábrica: QUALYPLAS
 Unidade: UN/1
 F1 F4



SQUEEZE 250 ML PLAST COELHO 584

Código: 41637
 Fábrica: QUALYPLAS
 Unidade: UN/1
 F1 F4



SQUEEZE 250 ML PLAST DINOSSAURO 135/480

Código: 41635
 Fábrica: QUALYPLAS
 Unidade: UN/1
 F1 F4



SQUEEZE 250 ML PLAST DRAGAO 1202

Código: 50341
 Fábrica: QUALYPLAS
 Unidade: UN/1
 F1 F4



SQUEEZE 250 ML PLAST FROOZER 130/136

Código: 41645
 Fábrica: QALYPLAS
 Unidade: UN/1
 F1 F4



SQUEEZE 250 ML PLAST PRINCESA 1142

Código: 50340
 Fábrica: QALYPLAS
 Unidade: UN/1
 F1 F4



SQUEEZE 250 ML PLAST SEREIA 482

Código: 41638
 Fábrica: QALYPLAS
 Unidade: UN/1
 F1 F4



SQUEEZE 250 ML PLAST TUBARAO 138/485

Código: 41640
 Fábrica: QALYPLAS
 Unidade: UN/1
 F1 F4



SQUEEZE 250 ML PLAST UNICORNIO 483

Código: 41639
 Fábrica: QALYPLAS
 Unidade: UN/1
 F1 F4



SQUEEZE 250 ML PLAST VIDEO GAME 1141

Código: 50342
 Fábrica: QALYPLAS
 Unidade: UN/1
 F1 F4



SQUEEZE 600 ML PLAST NEON AZUL TPA CLICK

Código: 49827
 Fábrica: CREATIVE
 Unidade: UN/1
 F1 F4



SQUEEZE 600 ML PLAST NEON ROSA TPA CLICK

Código: 49828
 Fábrica: CREATIVE
 Unidade: UN/1
 F1 F4



SQUEEZE 700 ML PLAST DIAMANT FUME 22390

Código: 49822
 Fábrica: CREATIVE
 Unidade: UN/1
 F1 F4



SQUEEZE 700 ML PLAST DIAMANT TIFFAN 2391

Código: 49823
 Fábrica: CREATIVE
 Unidade: UN/1
 F1 F4



SQUEEZE 700 ML PLAST TOP TRANS FUME 2393

Código: 49824
 Fábrica: CREATIVE
 Unidade: UN/1
 F1 F4



SQUEEZE 700 ML PLAST TOP TRANS TIFFA 384

Código: 49825
 Fábrica: CREATIVE
 Unidade: UN/1
 F1 F4



SQUEEZE 700 ML PLAST TOP TRANS TPA COLOR

Código: 49826
 Fábrica: CREATIVE
 Unidade: UN/1
 F1 F4

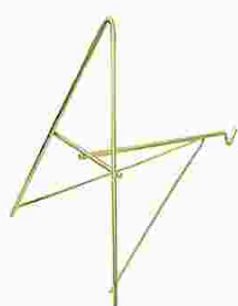

SUPORTE A MED METAL DOURADO P/PLANTAS

Código: 18493
 Fábrica: NUTRIPLAN
 Unidade: UN/1
 F1 F4

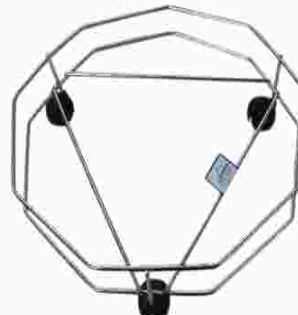

SUPORTE CROM BOTTILAO REFOR C/RODINHAS 21

Código: 24069
 Fábrica: ARAMINAS
 Unidade: UN/1
 F1 F4



SUPORTE CROM BOTTILAO TUBULAR C/ROD 799

Código: 33634
 Fábrica: ARAMINAS
 Unidade: UN/1
 F1 F4

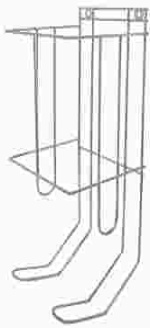

SUPORTE CROM P/PAPEL HIGIENICO 87

Código: 28961
 Fábrica: ARAMINAS
 Unidade: UN/1
 F1 F4

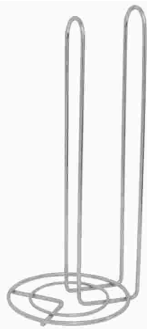

SUPORTE CROM P/PAPEL TOALHA DE MESA 89

Código: 38982
 Fábrica: ARAMINAS
 Unidade: UN/1
 F1 F4

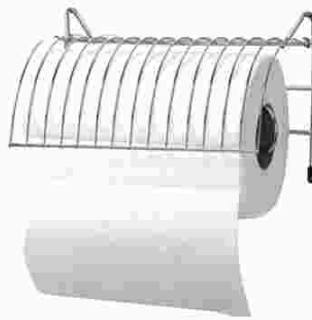

SUPORTE CROM P/PAPEL TOALHA PAREDE 22

Código: 18739
 Fábrica: ARAMINAS
 Unidade: UN/1
 F1 F4



SUPORTE CROM 20 COPOS PAREDE 52X30CM 28

Código: 24068
 Fábrica: ARAMINAS
 Unidade: UN/1
 F1 F4

Produto
 * Altura: 52 cm
 * Largura: 30 cm

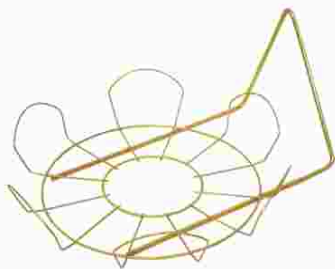

SUPORTE MARGARIDA MED DOURADO P/PLANTAS

Código: 33397
 Fábrica: NUTRIPLAN
 Unidade: UN/1
 F1 F4



SUPORTE METAL RODIZIO PRATO 25CM PRETO

Código: 42182
 Fábrica: NUTRIPLAN
 Unidade: UN/1
 F1 F4

30 cm



SUPORTE METAL RODIZIO PRATO 28CM PRETO

Código: 42179
 Fábrica: NUTRIPLAN
 Unidade: UN/1
 F1 F4

30 cm



SUPORTE METAL RODIZIO PRATO 30CM PRETO

Código: 42180
 Fábrica: NUTRIPLAN
 Unidade: UN/1
 F1 F4

30 cm



SUPORTE METAL RODIZIO PRATO 36CM PRETO

Código: 42181
 Fábrica: NUTRIPLAN
 Unidade: UN/1
 F1 F4

36 cm



SUPORTE OLEO PET 773

Código: 44719
 Fábrica: ARAMINAS
 Unidade: UN/1
 F1 F4



SUPORTE PLAST BOTIJA0 SB054

Código: 45109
 Fábrica: BUDEPLAST
 Unidade: UN/1
 F1 F4



SUPORTE PLAST BOTIJA0 760

Código: 46631
 Fábrica: LUMAR
 Unidade: UN/1
 F1 F4



SUPORTE PLAST FILTRO CAFE 103 6920

Código: 47145
 Fábrica: INPLAST
 Unidade: UN/1
 F1 F4



SUPORTE PLAST P/BOTIJA0 PRETO 91

Código: 22450
 Fábrica: MOLDE MINAS
 Unidade: UN/1
 F1 F4













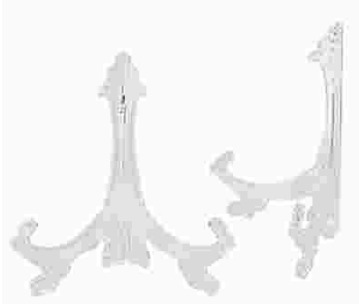



SUPORTE PLAST P/CAIXA SABAO EM PO 4418

Código: 10396
 Fábrica: NITRON
 Unidade: UN/1
 F1 F4



SUPORTE PLAST P/GARRAFAO AGUA

Código: 50368
 Fábrica: HERC
 Unidade: UN/1
 F1 F4

 <p>SUPORTE PLASTICO P/QUADRO CRISTAL 19 CM Código: 31482 Fábrica: YING FA Unidade: UN/1 F1 F4</p>	 <p>SUPORTE PLASTICO P/QUADRO CRISTAL 21 CM Código: 31483 Fábrica: YING FA Unidade: UN/1 F1 F4</p>	 <p>SUQUEIRA VIDRO 3,0 LTS 3182 Código: 34816 Fábrica: BATIKI Unidade: UN/1 F1 F4</p>	 <p>TABUA MAD HAMBURGUER NATURAL 20X19CM 48B Código: 41740 Fábrica: DEBIASI Unidade: UN/1 F1 F4</p>
 <p>TABUA MAD RED PETISCO NATURAL 20CM Código: 41741 Fábrica: DEBIASI Unidade: UN/1 F1 F4</p>	 <p>TABUA MAD RED P/FRIOS 25CM 57B Código: 41742 Fábrica: DEBIASI Unidade: UN/1 F1 F4</p>	 <p>TABUA MAD RED P/FRIOS C/GARF 25CM 57E Código: 41743 Fábrica: DEBIASI Unidade: UN/1 F1 F4</p>	 <p>TABUA PETISQUEIRA ACRI PTO 25CM Código: 41744 Fábrica: DEBIASI Unidade: UN/1 F1 F4</p>
 <p>TABUA PLAST COLOR 31X18CM 611 Código: 41634 Fábrica: QUALYPLAS Unidade: UN/1 F1 F4</p>	 <p>TABUA PLAST DE CORTE 320X220X4MM P 3050 Código: 46243 Fábrica: JAGUAR Unidade: UN/1 F1 F4</p>	 <p>TABUA PLAST DE CORTE 35X24X07CM CA08104 Código: 50644 Fábrica: CASITA Unidade: UN/1 F1 F4</p>	 <p>TABUA PLAST DE CORTE 360X260X6MM G 3051 Código: 49219 Fábrica: JAGUAR Unidade: UN/1 F1 F4</p>
 <p>TABUA PLAST DE CORTE 37X23CM 001 Código: 11000 Fábrica: RIOHOME Unidade: UN/1 F1 F4</p>	 <p>TABUA PLAST MEGA 969 Código: 46669 Fábrica: LUMAR Unidade: UN/1 F1 F4</p>	 <p>TABUA PLAST P/CARNE 36X21X0,5CM 514 Código: 33034 Fábrica: TRITEC Unidade: UN/1 F1 F4</p>	 <p>TABUA PLASTICA 33X20CM Código: 28706 Fábrica: PLASTBRASIL Unidade: UN/1 F1 F4</p>



TABULEIRO ALUM 1 ALTO 710

Código: 8256
 Fábrica: MSR
 Unidade: UN/1
 F1 F4



TABULEIRO ALUM 1 PADRAO 30X21X3,0CM 715

Código: 22790
 Fábrica: MSR
 Unidade: UN/1
 F1 F4



TABULEIRO ALUM 1 RET EXTRA 30X20X4,0CM

Código: 27599
 Fábrica: AVELAR
 Unidade: UN/1
 F1 F4



TABULEIRO ALUM 2 ALTO 711

Código: 7908
 Fábrica: MSR
 Unidade: UN/1
 F1 F4



TABULEIRO ALUM 2 PADRAO 33X23X3,0CM 716

Código: 8257
 Fábrica: MSR
 Unidade: UN/1
 F1 F4



TABULEIRO ALUM 2 RET EXTRA 33X23X4,0CM

Código: 22791
 Fábrica: AVELAR
 Unidade: UN/1
 F1 F4



TABULEIRO ALUM 3 ALTO 712

Código: 7909
 Fábrica: MSR
 Unidade: UN/1
 F1 F4



TABULEIRO ALUM 3 PADRAO 40X30X3,5CM 717

Código: 22792
 Fábrica: MSR
 Unidade: UN/1
 F1 F4



TABULEIRO ALUM 3 RET EXTRA 37X26X4,0CM

Código: 27601
 Fábrica: AVELAR
 Unidade: UN/1
 F1 F4



TABULEIRO ALUM 4 ALTO 713 ASSAD 42X29X6

Código: 7911
 Fábrica: MSR
 Unidade: UN/1
 F1 F4



TABULEIRO ALUM 4 PADRAO 45X33X4,0CM 718

Código: 22793
 Fábrica: MSR
 Unidade: UN/1
 F1 F4



TABULEIRO ALUM 4 RET EXTRA 42X30X4,0CM

Código: 27602
 Fábrica: AVELAR
 Unidade: UN/1
 F1 F4



TABULEIRO ALUM 5 ALTO 714

Código: 11262
 Fábrica: MSR
 Unidade: UN/1
 F1 F4



TABULEIRO ALUM 5 PADRAO 48X35X4,5CM 719

Código: 22794
 Fábrica: MSR
 Unidade: UN/1
 F1 F4



TABULEIRO ALUM 5 RET EXTRA 46X33X4,0CM

Código: 27603
 Fábrica: AVELAR
 Unidade: UN/1
 F1 F4



TACA ACRILICO 190ML CHAMPANHE CRISTAL 14

Código: 50344
 Fábrica: QUALYPLAS
 Unidade: UN/1
 F1 F4



TACA PLAST 360ML GIN BICOLOR VC11327 2X1
 Código: 41130 Fábrica: BRASFOOT Unidade: CJ/2
 F1 F4



TACA PLAST 580ML DEGRADE GIN 10565 2X1
 Código: 39133 Fábrica: BRASFOOT Unidade: CJ/2
 F1 F4



TACA PLAST 580ML DEGRADE GIN 10570 2X1
 Código: 39134 Fábrica: BRASFOOT Unidade: CJ/2
 F1 F4



TACA PLAST 580ML GIN ATLETICO 10800 2X1
 Código: 41128 Fábrica: BRASFOOT Unidade: UN/1
 F1 F4



TACA PLAST 580ML GIN FLAMENGO 10801 2X1
 Código: 41129 Fábrica: BRASFOOT Unidade: CJ/2
 F1 F4



TACA PLASTICO COPACABANA GDE 073
 Código: 27699 Fábrica: HEMITOYS Unidade: UN/1
 F1 F4



TACA VIDRO 300ML CERVEJA COLECCION 524093
 Código: 39258 Fábrica: FRATELLI Unidade: UN/1
 F1 F4



TACA VIDRO 300ML WINDSOR AGRADEÇA 2611
 Código: 39034 Fábrica: BRASFOOT Unidade: UN/1
 F1 F4



TACA VIDRO 300ML WINDSOR BEBO PRA E 2612
 Código: 39031 Fábrica: BRASFOOT Unidade: UN/1
 F1 F4



TACA VIDRO 300ML WINDSOR E MELHOR U 2613
 Código: 39033 Fábrica: BRASFOOT Unidade: UN/1
 F1 F4



TACA VIDRO 300ML WINDSOR FLAMENGO 1551
 Código: 39026 Fábrica: BRASFOOT Unidade: UN/1
 F1 F4



TACA VIDRO 300ML WINDSOR FLAMENGO 2661
 Código: 39030 Fábrica: BRASFOOT Unidade: UN/1
 F1 F4



TACA VIDRO 300ML WINDSOR QUEM BEBE 2610
 Código: 39032 Fábrica: BRASFOOT Unidade: UN/1
 F1 F4



TACA VIDRO 330ML WINDSOR ADORO 11597 2X1
 Código: 41115 Fábrica: BRASFOOT Unidade: CJ/2
 F1 F4

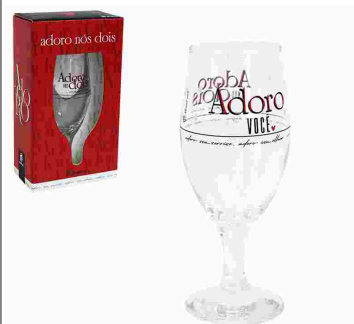

TACA VIDRO 330ML WINDSOR ADORO 11600
 Código: 41117 Fábrica: BRASFOOT Unidade: UN/1
 F1 F4



TACA VIDRO 330ML+AVENTAL ATLETICO 10000
 Código: 41114 Fábrica: BRASFOOT Unidade: UN/1
 F1 F4



TACA VIDRO 330ML+AVENTAL CRUZEIRO 10001
 Código: 41113 Fábrica: BRASFOOT Unidade: UN/1
 F1 F4



TACA VIDRO 385ML VINHO ADORO 11609
 Código: 41118 Fábrica: BRASFOOT Unidade: UN/1
 F1 F4



TACA VIDRO 40ML TRANSP 23353 6X1
 Código: 36756 Fábrica: MABEL Unidade: CX/6
 F1 F4



TACA VIDRO 40ML TRANSP 23354 6X1
 Código: 36757 Fábrica: MABEL Unidade: CX/6
 F1 F4



TACA VIDRO 400ML DUBLIN ATLETICO 10451
 Código: 39109 Fábrica: BRASFOOT Unidade: UN/1
 F1 F4



TACA VIDRO 400ML DUBLIN FLAMENGO 10453
 Código: 39023 Fábrica: BRASFOOT Unidade: UN/1
 F1 F4



TAMPA PLAST P/LAVATORIO PIA TV51N 100X1
 Código: 33734 Fábrica: REBOUCAS Unidade: PT/100
 F1 F4



TAMPA PLAST P/TANQUE TV52N 100X1
 Código: 33733 Fábrica: REBOUCAS Unidade: PT/100
 F1 F4



TAPETE ANTID BANHEIRO BCO 66X36CM 619
 Código: 44508 Fábrica: PLANETA Unidade: UN/1
 F1 F4



TAPETE ANTID BANHEIRO TRANSP 66X36CM 625
 Código: 44509 Fábrica: PLANETA Unidade: UN/1
 F1 F4



TAPETE ANTID BOX TRANSP 65X35CM 7692
 Código: 47360 Fábrica: ALTIHOME Unidade: UN/1
 F1 F4

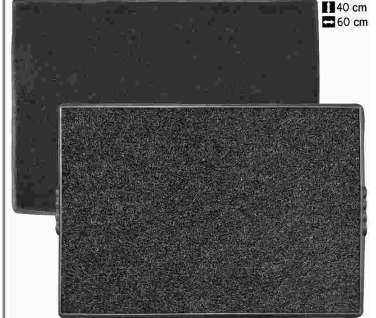

TAPETE BALME 40X60CM CORES 091
 Código: 36935 Fábrica: RIOHOME Unidade: UN/1
 F1 F4



TAPETE FIBRA COCO BORRACHA 40X60CM 088
 Código: 49365 Fábrica: RIOHOME Unidade: UN/1
 F1 F4



TAPETE MICROFIBRA ANTIDER 38X58CM 064
 Código: 49363 Fábrica: RIOHOME Unidade: UN/1
 F1 F4



TAPETE MICROFIBRA 38X58CM SOFT BALL 027
 Código: 49364 Fábrica: RIOHOME Unidade: UN/1
 F1 F4



TAPETE POLIESTER BEM VINDO 37X57CM 11611
 Código: 44515 Fábrica: NICOBEM Unidade: UN/1
 F1 F4

37cm
57cm



TAPETE POLIESTER BEM VINDO 37X57CM 2167
Código: 47094 Fábrica: GP6 Unidade: UN/1
F1 F4

39 cm
59 cm



TAPETE POP POLIESTER ANTIDERRAP 59X39CM
Código: 39967 Fábrica: PERFETTO Unidade: RL/1
F1 F4



TAPETE PVC ANTID BOX CORUJA 67X35CM 4048
Código: 47897 Fábrica: CASITA Unidade: UN/1
F1 F4



TAPETE PVC/FLAN BANH CORUJA 40X60CM 4046
Código: 47898 Fábrica: CASITA Unidade: UN/1
F1 F4

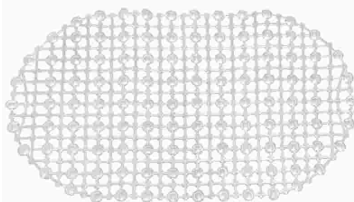

TAPETE SILIC ANTID BANHEIRO 62X35CM 7040
Código: 41536 Fábrica: ELITE Unidade: UN/1
F1 F4



TEE 1/2 ACOPLAR MANGUEIRA PTO TE51N 50X1
Código: 40149 Fábrica: REBOUCAS Unidade: PT/50
F1 F4



TEE 3/4 ACOPLAR MANGUEIRA PTO TE52N 50X1
Código: 40150 Fábrica: REBOUCAS Unidade: PT/50
F1 F4



TERRA ESP P/CACTOS E SUCULENTAS 1,5 KG
Código: 35708 Fábrica: NUTRIPLAN Unidade: PT/1
F1 F4



TERRA ORQUÍDEA 1 LITRO
Código: 48526 Fábrica: NOVATROPICAL Unidade: PT/1
F1 F4



TERRA SAMAMBAIA 1 LITRO
Código: 48527 Fábrica: NOVATROPICAL Unidade: PT/1
F1 F4



TERRA SAMAMBAIA 1,5 KG
Código: 22287 Fábrica: VITAPLAN Unidade: PT/1
F1 F4



TERRA SAMAMBAIA 2 KG
Código: 47464 Fábrica: VITAPLAN Unidade: KG/1
F1 F4



TERRA VEGETAL 2 KG
Código: 19888 Fábrica: NOVATROPICAL Unidade: PT/1
F1 F4



TERRA VEGETAL 5 KG
Código: 19889 Fábrica: NOVATROPICAL Unidade: PT/1
F1 F4



TERRA VEGETAL 10 KG
Código: 30504 Fábrica: NOVATROPICAL Unidade: PT/1
F1 F4



TERRA VEGETAL 20 KG
Código: 30765 Fábrica: NOVATROPICAL Unidade: PT/1
F1 F4



TERRA VEGETAL 25 KG

Código: 47378
 Fábrica: NOVATROPICAL
 Unidade: PT/1
 F1 F4



TIGELA ACRILIC BOWL C/TAMPA COLOR 33127

Código: 41214
 Fábrica: PLASTSU
 Unidade: UN/1
 F1 F4



TIGELA ALUM 20 1197

Código: 45284
 Fábrica: MSR
 Unidade: UN/1
 F1 F4



TIGELA PLASTICA BOWL 350 ML 115

Código: 14583
 Fábrica: ECOPLASTIC
 Unidade: UN/1
 F1 F4



TIGELA VIDRO 620ML PREMIERE 1067 24X1

Código: 39522
 Fábrica: MULTIPRESENT
 Unidade: CX/24
 F1 F4

12,5 cm
 10,5 cm
 620 ml



TOALHA BANHO PROF 1,30X70XM BRANCA

Código: 47342
 Fábrica: MARCOTEX
 Unidade: UN/1
 F1 F4



TOALHA LAVABO SLIM 45X29CM AMARELO 12X1

Código: 47661
 Fábrica: MARCOTEX
 Unidade: PT/12
 F1 F4

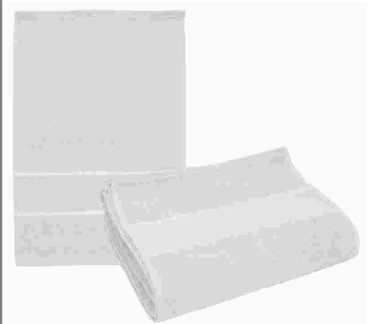

TOALHA LAVABO SLIM 45X29CM BRANCO 6X1

Código: 47654
 Fábrica: MARCOTEX
 Unidade: PT/6
 F1 F4



TOALHA LAVABO SLIM 45X29CM LARANJA 6X1

Código: 47660
 Fábrica: MARCOTEX
 Unidade: PT/12
 F1 F4



TOALHA LAVABO SLIM 45X29CM ROSA FLOR12X1

Código: 47657
 Fábrica: MARCOTEX
 Unidade: PT/12
 F1 F4

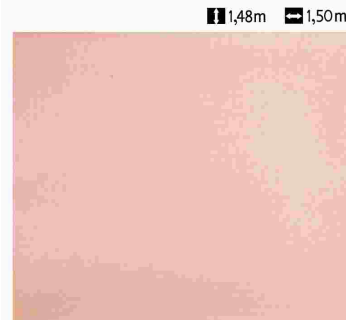

TOALHA MESA PANO 1,48X1,50M LISA 1101

Código: 40444
 Fábrica: SUN WELLS
 Unidade: UN/1
 F1 F4

1,48m 1,50m

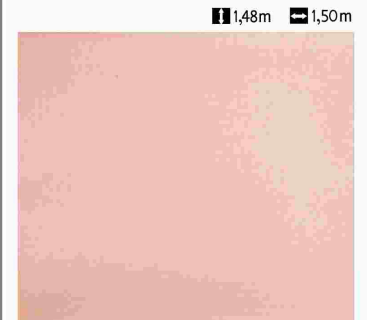

TOALHA MESA PANO 1,48X1,50M NATAL

Código: 40446
 Fábrica: SUN WELLS
 Unidade: UN/1
 F1 F4

1,48m 1,50m



TOALHA MESA PANO 2,20X1,50M ESTAMP

Código: 40447
 Fábrica: SUN WELLS
 Unidade: UN/1
 F1 F4

1,50m 2,20m



TOALHA MULTIUSO MICROFIBRA 30X30CM 163

Código: 50790
 Fábrica: HOME&MORE
 Unidade: UN/1
 F1 F4



TOALHA SOCIAL LISA 36X23CM BRANCO 12X1

Código: 47668
 Fábrica: MARCOTEX
 Unidade: PT/12
 F1 F4



TOALHA SOCIAL LISA 36X23CM PRETO 12X1

Código: 47669
 Fábrica: MARCOTEX
 Unidade: PT/12
 F1 F4

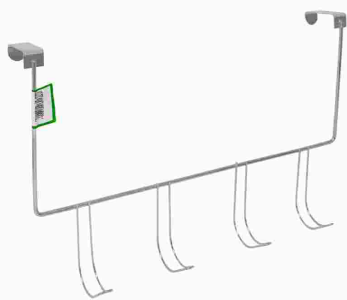

TOALHEIRO CROM DE PORTA 67

Código: **28958** Fábrica: **ARAMINAS** Unidade: **UN/1**
F1 F4



TOALHEIRO CROM PAREDE N1 1 GANCHO 64

Código: **44242** Fábrica: **ARAMINAS** Unidade: **UN/1**
F1 F4



TOALHEIRO CROM PAREDE N4 4 GANCHOS 66

Código: **40516** Fábrica: **ARAMINAS** Unidade: **UN/1**
F1 F4



TORNEIRA JARDIM 1/2 C/BIC COL TVC1N 12X1

Código: **33726** Fábrica: **REBOUCAS** Unidade: **PT/12**
F1 F4



TORNEIRA JARDIM 1/2 C/BICO PT TTV1N 12X1

Código: **30743** Fábrica: **REBOUCAS** Unidade: **PT/12**
F1 F4



TORNEIRA JARDIM 3/4 1/2 10CM C/B B1N12X1

Código: **51130** Fábrica: **REBOUCAS** Unidade: **PT/12**
F1 F4



TORNEIRA JARDIM 3/4 1/2 10CM C/B R1N12X1

Código: **35660** Fábrica: **REBOUCAS** Unidade: **PT/12**
F1 F4



TORNEIRA P/FILTRO AUTOM MARROM 342 12X1

Código: **8042** Fábrica: **MINERAL** Unidade: **PT/12**
F1 F4



TORNEIRA P/FILTRO CROMO AUTOMAT 31 12X1

Código: **27209** Fábrica: **MINERAL** Unidade: **PT/12**
F1 F4



TORNEIRA P/FILTRO MANUAL MARROM 341 12X1

Código: **8043** Fábrica: **MINERAL** Unidade: **PT/12**
F1 F4



TORNEIRA P/FILTRO TOC BRANCA 86 12X1

Código: **28807** Fábrica: **MINERAL** Unidade: **PT/12**
F1 F4

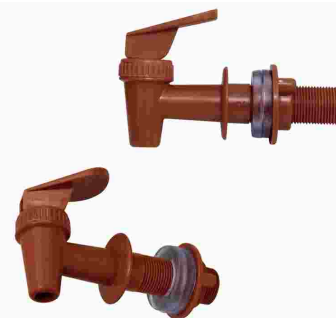

TORNEIRA P/FILTRO TOC MARROM 34 12X1

Código: **38332** Fábrica: **MINERAL** Unidade: **PT/12**
F1 F4



TORNEIRA PIA LG 3/4 1/2 15CM C/B18N 12X1

Código: **47223** Fábrica: **REBOUCAS** Unidade: **PT/12**
F1 F4



TORNEIRA PIA LONG 3/4 1/2 15CM TR5N 12X1

Código: **35659** Fábrica: **REBOUCAS** Unidade: **PT/12**
F1 F4



TORNEIRA PIA LONGA 1/2 15CM C/B 18N 12X1

Código: **33722** Fábrica: **REBOUCAS** Unidade: **PT/12**
F1 F4



TORNEIRA PIA LONGA 1/2 15CM TTV5N 12X1

Código: **30742** Fábrica: **REBOUCAS** Unidade: **PT/12**
F1 F4

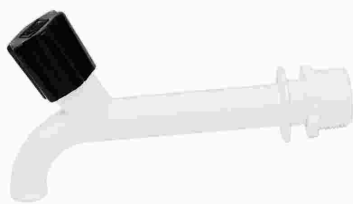

TORNEIRA PIA LONGA 3/4X1/2 15CM TV5N UN

Código: **39370** Fábrica: **REBOUCAS** Unidade: **UN/1**
F1 F4



TORNEIRA PIA 3/4X1/2 15CM UNIV TV5N 12X1

Código: **33729** Fábrica: **REBOUCAS** Unidade: **PT/12**
F1 F4

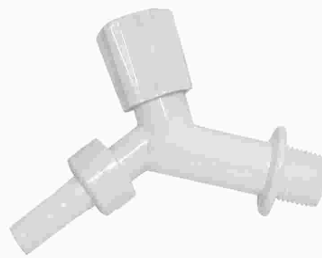

TORNEIRA PIA/TANQUE 1/2 15CM TVC5N 12X1

Código: **34844** Fábrica: **REBOUCAS** Unidade: **PT/12**
F1 F4

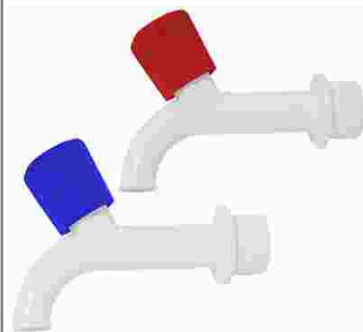

TORNEIRA PIA/TANQUE 3/4 10CM CL C4N 12X1

Código: **33727** Fábrica: **REBOUCAS** Unidade: **PT/12**
F1 F4

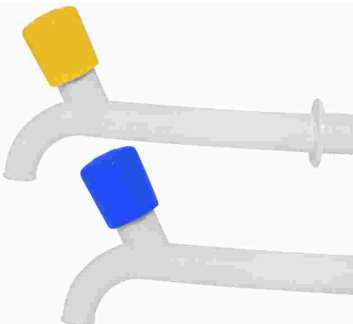

TORNEIRA P/JARDIM 1/2 10CM C/B VB1N 12X1

Código: **34846** Fábrica: **REBOUCAS** Unidade: **PT/12**
F1 F4



TORNEIRA PLAST ESFERA 1/2 10CM UN

Código: **46804** Fábrica: **CAERUS** Unidade: **UN/1**
F1 F4



TORNEIRA P/LAVATORIO 1/2 TTV7N 12X1

Código: **33217** Fábrica: **REBOUCAS** Unidade: **PT/12**
F1 F4



TORNEIRA TANQ/MAQ 1/2 10CM C/A TV20N12X1

Código: **34845** Fábrica: **REBOUCAS** Unidade: **PT/12**
F1 F4



TORNEIRA TANQUE CURT 1/2 10CM TTV3N 12X1

Código: **32565** Fábrica: **REBOUCAS** Unidade: **PT/12**
F1 F4



TORNEIRA TANQUE 1/2 10CM C/B16N 12X1

Código: **33723** Fábrica: **REBOUCAS** Unidade: **PT/12**
F1 F4



TORNEIRA TANQUE 3/4X1/2 10CM U TR3N 12X1

Código: **48609** Fábrica: **REBOUCAS** Unidade: **PT/12**
F1 F4



TORNEIRA TANQUE 3/4X1/2 10CM U TV3N UN

Código: **40675** Fábrica: **REBOUCAS** Unidade: **PT/1**
F1 F4



TORNEIRA TANQUE 3/4X1/2 10CM U TV3N 12X1

Código: **33730** Fábrica: **REBOUCAS** Unidade: **PT/12**
F1 F4



TORNEIRA TANQUE/PIA 3/4 10CM TTV4N 12X1

Código: **31572** Fábrica: **REBOUCAS** Unidade: **PT/12**
F1 F4



TRAVESSA ALUM PORCAO 1

Código: **37341** Fábrica: **MSR** Unidade: **UN/1**
F1 F4



TRAVESSA ALUM PORCAO 2 1194

Código: **37342** Fábrica: **MSR** Unidade: **UN/1**
F1 F4



TRAVESSA ALUM PORCAO 3

Código: **37343** Fábrica: **MSR** Unidade: **UN/1**
F1 F4



TRAVESSA INOX 31X21CM (TABULEIRO)800-11

Código: **40530** Fábrica: **CASA ONZE** Unidade: **UN/1**
F1 F4

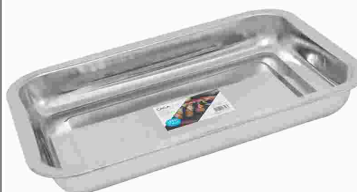

TRAVESSA INOX 39X29CM (TABULEIRO)800-13

Código: **40658** Fábrica: **CASA ONZE** Unidade: **UN/1**
F1 F4



TRAVESSA PLAST PEQ RET C/TAMPA 147

Código: **33502** Fábrica: **ARIPLAS** Unidade: **UN/1**
F1 F4



TRAVESSA PLASTICA FUNDA

Código: **14579** Fábrica: **ECOPLASTIC** Unidade: **UN/1**
F1 F4



TRAVESSA PORC 320ML PEQ BRANCA G14

Código: **40019** Fábrica: **TERRAMADA** Unidade: **UN/1**
F1 F4



TRAVESSA PORC 450ML MED BRANCA G15

Código: **40020** Fábrica: **TERRAMADA** Unidade: **UN/1**
F1 F4



TRITURADOR PLAST GIRATORIO P/ALHO 1032

Código: **50375** Fábrica: **ENGIPLAST** Unidade: **UN/1**
F1 F4



TRITURADOR PLAST GIRATORIO P/ALHO 780

Código: **36963** Fábrica: **QUALYPLAS** Unidade: **UN/1**
F1 F4



TRONINHO PLAST BABY AZUL 3638

Código: **35480** Fábrica: **TRITEC** Unidade: **UN/1**
F1 F4



TRONINHO PLAST BABY ROSA 3636

Código: **6456** Fábrica: **TRITEC** Unidade: **UN/1**
F1 F4



UNIAO PLAST MANGUEIRA STANDARD 215

Código: **40242** Fábrica: **MONTEREY** Unidade: **UN/1**
F1 F4



UNIAO 1/2 P/IRRIGACAO INTERNA 25X1

Código: **50817** Fábrica: **MC LOREN** Unidade: **PT/25**
F1 F4



UNIAO 1/2 P/MANGUEIRA PRETO UN51N 50X1

Código: **40151** Fábrica: **REBOUCAS** Unidade: **PT/50**
F1 F4



UNIAO 3/4 P/MANGUEIRA PRETO UN52N 50X1

Código: **40152** Fábrica: **REBOUCAS** Unidade: **PT/50**
F1 F4



URINOL GRANDE PLAST 5017

Código: **14026** Fábrica: **SBRISSA** Unidade: **UN/1**
F1 F4



URINOL PLAST 713

Código: 37261
 Fábrica: LUMAR
 Unidade: UN/1
 F1 F4



URINOL PLASTICO GDE 113

Código: 20915
 Fábrica: ECOPLASTIC
 Unidade: UN/1
 F1 F4



VALVULA GATILHO P/PULVERIZADOR 28

Código: 49398
 Fábrica: ARBRA
 Unidade: UN/1
 F1 F4



VALVULA P/TANQUE 1.1/4" MET VC53N 12X1

Código: 40155
 Fábrica: REBOUCAS
 Unidade: PT/12
 F1 F4



VALVULA P/TANQUE 1.1/4" PLAS VO53N 12X1

Código: 40156
 Fábrica: REBOUCAS
 Unidade: PT/12
 F1 F4



VALVULA SEG PAINELA PRESS METAL 2000 10X1

Código: 25505
 Fábrica: PINOLAR
 Unidade: PT/10
 F1 F4



VALVULA SEG PAINELA PRESS SILIC 6000 10X1

Código: 31035
 Fábrica: PINOLAR
 Unidade: PT/10
 F1 F4



VALVULA (SELO) PAINELA PRESSAO 62 2X1

Código: 49742
 Fábrica: NOVA MARCA
 Unidade: CR/2
 F1 F4



VARAL MULTIUSO N1 08 PRENDEDORES 433

Código: 38887
 Fábrica: LIG BRIN
 Unidade: UN/1
 F1 F4



VARAL MULTIUSO N2 16 PRENDEDORES 440

Código: 38888
 Fábrica: LIG BRIN
 Unidade: UN/1
 F1 F4



VARAL MULTIUSO N3 26 PRENDEDORES 471

Código: 38886
 Fábrica: LIG BRIN
 Unidade: UN/1
 F1 F4



VARAL MULTIUSO N4 36 PRENDEDORES 587

Código: 38889
 Fábrica: LIG BRIN
 Unidade: UN/1
 F1 F4

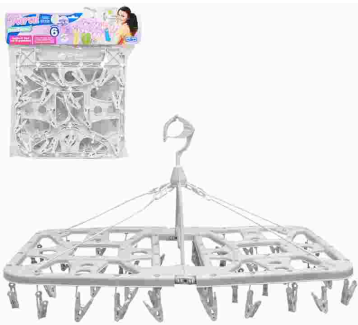

VARAL MULTIUSO N6 48 PRENDEDORES 624

Código: 38891
 Fábrica: LIG BRIN
 Unidade: UN/1
 F1 F4



VARAL PLAST MULTIUSO 12 PRENDEDORES 0219

Código: 31365
 Fábrica: TALBERG
 Unidade: UN/1
 F1 F4



2,6mts













VARAO (BASTAO) EXTENSIV METAL 1,40A2,60M

Código: 47374
 Fábrica: ALTIHOME
 Unidade: UN/1
 F1 F4



VARETA BAMBU ALGODAO DOCE 40CM 100X1

Código: 50075
 Fábrica: BOMPACK
 Unidade: PT/100
 F1 F4

 <p> 5,5 cm 06 cm </p> <p> VASO CERAMICA MINI 5,5X6CM 172116 Código: 34775 Fábrica: FREECOM Unidade: UN/1 F1 F4 </p>	 <p> 12 cm 15 cm 1,3 lts </p> <p> VASO ELEGANCE AUTOIRRIG 03 CAFE IMP 1,3L Código: 34619 Fábrica: NUTRIPLAN Unidade: UN/1 F1 F4 </p>	 <p> 16 cm 15 cm 1,8 lts </p> <p> VASO ELEGANCE AUTOIRRIG 3,5 TRAVERT 1,8L Código: 34620 Fábrica: NUTRIPLAN Unidade: UN/1 F1 F4 </p>	 <p> 415 ml </p> <p> VASO PL 1 RED PEQ MARROM 415ML Código: 39638 Fábrica: NUTRIPLAN Unidade: UN/1 F1 F4 </p>
 <p> 7,8cm 10,2cm </p> <p> VASO PL 1 RED PEQ PRETO 415ML Código: 18470 Fábrica: NUTRIPLAN Unidade: UN/1 F1 F4 </p>	 <p> 12cm 16cm 1lts </p> <p> VASO PL 1,0 L RED PEQ TERRACOTA 6715 Código: 26766 Fábrica: INPLAST Unidade: UN/1 F1 F4 </p>	 <p> 9 cm 12 cm 0,75 L </p> <p> VASO PL 1,5 RED PEQ PRETO 750ML Código: 33551 Fábrica: NUTRIPLAN Unidade: UN/1 F1 F4 </p>	 <p> 9 cm 13 cm 01 L </p> <p> VASO PL 2 RED PEQ MARROM 1LT Código: 33537 Fábrica: NUTRIPLAN Unidade: UN/1 F1 F4 </p>
 <p> 9,8cm 13cm </p> <p> VASO PL 2 RED PEQ PRETO 1LT Código: 18471 Fábrica: NUTRIPLAN Unidade: UN/1 F1 F4 </p>	 <p> 11 cm 14 cm 1,4 L </p> <p> VASO PL 2,5 RED PEQ MARROM 1,4LTS Código: 33538 Fábrica: NUTRIPLAN Unidade: UN/1 F1 F4 </p>	 <p> 10,5cm 14,5cm </p> <p> VASO PL 2,5 RED PEQ PRETO 1,4LTS Código: 18472 Fábrica: NUTRIPLAN Unidade: UN/1 F1 F4 </p>	 <p> 10,5cm 14,5cm </p> <p> VASO PL 3 LTS QUAD PRETO 7002 Código: 40417 Fábrica: FORMPLAST Unidade: UN/1 F1 F4 </p>
 <p> 12 cm 17 cm 02 L </p> <p> VASO PL 3 RED PEQ MARROM 2LTS Código: 33539 Fábrica: NUTRIPLAN Unidade: UN/1 F1 F4 </p>	 <p> 12,5cm 17cm </p> <p> VASO PL 3 RED PEQ PRETO 2LTS Código: 18473 Fábrica: NUTRIPLAN Unidade: UN/1 F1 F4 </p>	 <p> 15 cm 20 cm 03 L </p> <p> VASO PL 3,5 RED MED MARROM 3LTS Código: 33552 Fábrica: NUTRIPLAN Unidade: UN/1 F1 F4 </p>	 <p> 17 cm 21 cm 4,9 L </p> <p> VASO PL 4 RED MED MARROM 4,9LTS Código: 26911 Fábrica: NUTRIPLAN Unidade: UN/1 F1 F4 </p>

 <p>17cm 21cm</p> <p>VASO PL 4 RED MED PRETO 4,9LTS Código: 18475 Fábrica: NUTRIPLAN Unidade: UN/1 F1 F4</p>	 <p>23 cm 26 cm 8,7 L</p> <p>VASO PL 5 RED GDE MARROM 8,7LTS Código: 33553 Fábrica: NUTRIPLAN Unidade: UN/1 F1 F4</p>	 <p>23cm 26cm</p> <p>VASO PL 5 RED GDE PRETO 8,7LTS Código: 18476 Fábrica: NUTRIPLAN Unidade: UN/1 F1 F4</p>	 <p>VASO PL 5LTS MARFIM 6412 Código: 41480 Fábrica: KOZI PLAST Unidade: UN/1 F1 F4</p>
 <p>VASO PL 5LTS PRETO 6400 Código: 41494 Fábrica: KOZI PLAST Unidade: UN/1 F1 F4</p>	 <p>25 cm 20 cm 12 L</p> <p>VASO PL 6 RED GDE MARROM 12LTS Código: 33554 Fábrica: NUTRIPLAN Unidade: UN/1 F1 F4</p>	 <p>25cm 30cm</p> <p>VASO PL 6 RED GDE PRETO 12LTS Código: 18477 Fábrica: NUTRIPLAN Unidade: UN/1 F1 F4</p>	 <p>29 cm 37 cm 21,5 L</p> <p>VASO PL 7 RED GDE MARROM 21,5LTS Código: 33555 Fábrica: NUTRIPLAN Unidade: UN/1 F1 F4</p>
 <p>29cm 37cm</p> <p>VASO PL 7 RED GDE PRETO 21,2LTS Código: 18478 Fábrica: NUTRIPLAN Unidade: UN/1 F1 F4</p>	 <p>38 cm 44 cm 42,5 L</p> <p>VASO PL 8 RED GIG MARROM 42,5LTS Código: 33535 Fábrica: NUTRIPLAN Unidade: UN/1 F1 F4</p>	 <p>38 cm 44 cm 42,5 L</p> <p>VASO PL 8 RED GIG PRETO 42,5LTS Código: 33536 Fábrica: NUTRIPLAN Unidade: UN/1 F1 F4</p>	 <p>45 cm 51 cm 65Lts</p> <p>VASO PL 9 RED GIG PRETO 65LTS Código: 39639 Fábrica: NUTRIPLAN Unidade: UN/1 F1 F4</p>
 <p>21,5cm 29 cm 30 lts</p> <p>VASO PL ADRI 30 PRETO 8L 788 Código: 37712 Fábrica: BIG PLAST Unidade: UN/1 F1 F4</p>	 <p>VASO PL AQUARELA 2,5 RED AMARELO CLARO Código: 35709 Fábrica: NUTRIPLAN Unidade: UN/1 F1 F4</p>	 <p>VASO PL AQUARELA 2,5 RED LILAS CLARO Código: 35710 Fábrica: NUTRIPLAN Unidade: UN/1 F1 F4</p>	 <p>VASO PL AQUARELA 2,5 RED ROSA BEBE Código: 35711 Fábrica: NUTRIPLAN Unidade: UN/1 F1 F4</p>



VASO PL AQUARELA 2,5 RED VERDE CLARO

Código: **35712** Fábrica: **NUTRIPLAN** Unidade: **UN/1**
F1 F4



VASO PL AQUARELA 3,5 RED AMARELO CL 1,7L

Código: **34600** Fábrica: **NUTRIPLAN** Unidade: **UN/1**
F1 F4

14 cm
15 cm
1,6 lts



VASO PL AQUARELA 3,5 RED VERDE CLAR 1,7L

Código: **34603** Fábrica: **NUTRIPLAN** Unidade: **UN/1**
F1 F4

14 cm
15 cm
1,6 lts



VASO PL AZALEIA QUAD CAFE 1132

Código: **37215** Fábrica: **PAIOL** Unidade: **UN/1**
F1 F4

13 cm
19 cm



VASO PL BACIA GREGA P AZUL 29-9

Código: **40022** Fábrica: **PAIOL** Unidade: **UN/1**
F1 F4

35 cm
28,5 cm



VASO PL BACIA GREGA P BEGE 29-1

Código: **40021** Fábrica: **PAIOL** Unidade: **UN/1**
F1 F4

35 cm
28,5 cm



VASO PL BAMBU OVAL 45 CARVALHO 22LTS

Código: **34609** Fábrica: **NUTRIPLAN** Unidade: **UN/1**
F1 F4

45 cm
28 cm



VASO PL BELLA FIOR RED 35 PTO 13,5L 9201

Código: **45208** Fábrica: **RISCHIOTO** Unidade: **UN/1**
F1 F4

30 cm
35 cm
13,5 L



VASO PL BELLA FIORE RED 42 PTO 25L 9202

Código: **45209** Fábrica: **RISCHIOTO** Unidade: **UN/1**
F1 F4

36 cm
42 cm
29,6 L



VASO PL BELLA QUAD 28 PTO 9,7LTS 9250

Código: **45204** Fábrica: **RISCHIOTO** Unidade: **UN/1**
F1 F4

24 cm
28 cm
9,7 L



VASO PL BELLA RED 22 PTO 4LTS 9199

Código: **45206** Fábrica: **RISCHIOTO** Unidade: **UN/1**
F1 F4

19 cm
22 cm
4 L



VASO PL BELLA RED 50 PTO 42,5LTS 9203

Código: **45210** Fábrica: **RISCHIOTO** Unidade: **UN/1**
F1 F4

43 cm
50 cm
42,5 L



VASO PL CACHEPO GDE SISAL 1725

Código: **37217** Fábrica: **PAIOL** Unidade: **UN/1**
F1 F4

25 cm
26 cm



VASO PL CLASS CONE 70 VERDE GUATEMA 27,5L

Código: **39652** Fábrica: **NUTRIPLAN** Unidade: **UN/1**
F1 F4

70 cm
38 cm
27,5 lts



VASO PL CLASS CONICO 66 VERDE GUATEMA 50L

Código: **39647** Fábrica: **NUTRIPLAN** Unidade: **UN/1**
F1 F4

65 cm
38 cm
50 lts



VASO PL CLASS RED 33 VERDE GUATEMALA 22L

Código: **39648** Fábrica: **NUTRIPLAN** Unidade: **UN/1**
F1 F4

33 cm
35 cm
22 lts

32 cm
40 cm



VASO PL CLASSIC CILINDRICO 32 AREIA 35LT

Código: 30277 Fábrica: NUTRIPLAN Unidade: UN/1 F1 F4

32 cm
40,5cm



VASO PL CLASSIC CILINDRICO 32 AZUL COB

Código: 41390 Fábrica: NUTRIPLAN Unidade: UN/1 F1 F4

32 cm
40 cm



VASO PL CLASSIC CILINDRICO 32 FERRU 35L

Código: 30278 Fábrica: NUTRIPLAN Unidade: UN/1 F1 F4

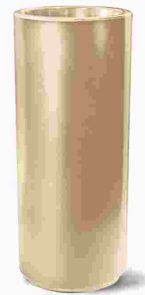

VASO PL CLASSIC CILINDRICO 75 AREIA

Código: 42173 Fábrica: NUTRIPLAN Unidade: UN/1 F1 F4



VASO PL CLASSIC CILINDRICO 75 AZUL COB

Código: 42169 Fábrica: NUTRIPLAN Unidade: UN/1 F1 F4



VASO PL CLASSIC CILINDRICO 75 FERRUGEM

Código: 42172 Fábrica: NUTRIPLAN Unidade: UN/1 F1 F4

30 cm

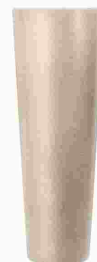

VASO PL CLASSIC CONE 30 AREIA

Código: 36801 Fábrica: NUTRIPLAN Unidade: UN/1 F1 F4

30 cm



VASO PL CLASSIC CONE 30 COBRE

Código: 36803 Fábrica: NUTRIPLAN Unidade: UN/1 F1 F4

30 cm



VASO PL CLASSIC CONE 30 FERRUGEM

Código: 36799 Fábrica: NUTRIPLAN Unidade: UN/1 F1 F4

30 cm



VASO PL CLASSIC CONE 30 RUBI

Código: 36802 Fábrica: NUTRIPLAN Unidade: UN/1 F1 F4

70 cm



VASO PL CLASSIC CONE 70 AREIA

Código: 36798 Fábrica: NUTRIPLAN Unidade: UN/1 F1 F4

70 cm
38 cm



VASO PL CLASSIC CONE 70 AZUL COB

Código: 41382 Fábrica: NUTRIPLAN Unidade: UN/1 F1 F4

70 cm



VASO PL CLASSIC CONE 70 GRAFITE

Código: 36797 Fábrica: NUTRIPLAN Unidade: UN/1 F1 F4

45 cm
26,5 cm
18 lts



VASO PL CLASSIC CONICO 46 GRAFITE 18LTS

Código: 32739 Fábrica: NUTRIPLAN Unidade: UN/1 F1 F4

65 cm
38 cm



VASO PL CLASSIC CONICO 66 AZUL COB

Código: 41400 Fábrica: NUTRIPLAN Unidade: UN/1 F1 F4



65 cm
38 cm
50 lts

VASO PL CLASSIC CONICO 66 GRAFITE 50LTS

Código: 32738 Fábrica: NUTRIPLAN Unidade: UN/1 F1 F4



65 cm
38 cm
50 lts

VASO PL CLASSIC CONICO 66 RUBI 50LTS

Código: 32737 Fábrica: NUTRIPLAN Unidade: UN/1 F1 F4



26 cm
27,5 cm
11 lts

VASO PL CLASSIC REDONDO 26 AREIA 11LTS

Código: 33398 Fábrica: NUTRIPLAN Unidade: UN/1 F1 F4



26 cm
27,5 cm
11 lts

VASO PL CLASSIC REDONDO 26 FERRUGEM 11LT

Código: 33392 Fábrica: NUTRIPLAN Unidade: UN/1 F1 F4



40 cm
42,6 cm
45 lts

VASO PL CLASSIC REDONDO 40 RUBI 45LTS

Código: 34097 Fábrica: NUTRIPLAN Unidade: UN/1 F1 F4



62 cm
67 cm

VASO PL CLASSIC REDONDO 62 FERRUG 170LTS

Código: 30331 Fábrica: NUTRIPLAN Unidade: UN/1 F1 F4



VASO PL COLOR M 951994

Código: 41203 Fábrica: PLASTSU Unidade: UN/1 F1 F4



VASO PL COLOR P 9LTS 951512

Código: 41201 Fábrica: PLASTSU Unidade: UN/1 F1 F4



28 cm
21 cm
8 lts

VASO PL COLUNA MARROM 8 LTS 2302

Código: 36994 Fábrica: ERCAPLAST Unidade: UN/1 F1 F4



34 cm
25 cm
13,5 lts

VASO PL COLUNA PRETO 13,5 LTS 2344

Código: 36992 Fábrica: ERCAPLAST Unidade: UN/1 F1 F4



VASO PL COLUNA PRETO 8 LTS 2301

Código: 36993 Fábrica: ERCAPLAST Unidade: UN/1 F1 F4



35 cm
28,5 cm

VASO PL COLUNA QUAD PEQ AZUL 79-7

Código: 39961 Fábrica: PAIOL Unidade: UN/1 F1 F4



35 cm
28,5 cm

VASO PL COLUNA QUAD PEQ BEGE 79-3

Código: 39959 Fábrica: PAIOL Unidade: UN/1 F1 F4



35 cm
28,5 cm

VASO PL COLUNA QUAD PEQ CIMENTO 79-4

Código: 39960 Fábrica: PAIOL Unidade: UN/1 F1 F4



35 cm
28,5 cm

VASO PL COLUNA QUAD PEQ MARROM 79-7

Código: 39958 Fábrica: PAIOL Unidade: UN/1 F1 F4



27 cm
22 cm

VASO PL COLUNA QUAD PP AZUL 99-7

Código: 39957 Fábrica: PAIOL Unidade: UN/1 F1 F4

 <p>27 cm 22 cm</p> <p>VASO PL COLUNA QUAD PP BEGE 99-1 Código: 39955 Fábrica: PAIOL Unidade: UN/1 F1 F4</p>	 <p>27 cm 22 cm</p> <p>VASO PL COLUNA QUAD PP CIMENTO 99-3 Código: 39956 Fábrica: PAIOL Unidade: UN/1 F1 F4</p>	 <p>27 cm 22 cm</p> <p>VASO PL COLUNA QUAD PP MARROM 99-2 Código: 39954 Fábrica: PAIOL Unidade: UN/1 F1 F4</p>	 <p>26 cm 21,5 cm</p> <p>VASO PL COLUNA RED PP BEGE 50-1 Código: 39948 Fábrica: PAIOL Unidade: UN/1 F1 F4</p>
 <p>26 cm 21,5 cm</p> <p>VASO PL COLUNA RED PP CIMENTO 50-3 Código: 39949 Fábrica: PAIOL Unidade: UN/1 F1 F4</p>	 <p>29 cm 26,5 cm</p> <p>VASO PL COLUNA RED PP LISO AZUL B50-9 Código: 40027 Fábrica: PAIOL Unidade: UN/1 F1 F4</p>	 <p>29 cm 26,5 cm</p> <p>VASO PL COLUNA RED PP LISO BEGE B50-1 Código: 40025 Fábrica: PAIOL Unidade: UN/1 F1 F4</p>	 <p>29 cm 26,5 cm</p> <p>VASO PL COLUNA RED PP LISO CIMENTO B50-5 Código: 40026 Fábrica: PAIOL Unidade: UN/1 F1 F4</p>
 <p>29 cm 26,5 cm</p> <p>VASO PL COLUNA RED PP LISO MARROM B50-2 Código: 40024 Fábrica: PAIOL Unidade: UN/1 F1 F4</p>	 <p>26 cm 21,5 cm</p> <p>VASO PL COLUNA RED PP MARROM 50-2 Código: 39947 Fábrica: PAIOL Unidade: UN/1 F1 F4</p>	 <p>18,5 cm 23 cm</p> <p>VASO PL CONE BERLIAN GOLD PP AZUL A96-9 Código: 39942 Fábrica: PAIOL Unidade: UN/1 F1 F4</p>	 <p>18,5 cm 23 cm</p> <p>VASO PL CONE BERLIAN GOLD PP BEGE A96-1 Código: 39940 Fábrica: PAIOL Unidade: UN/1 F1 F4</p>
 <p>18,5 cm 23 cm</p> <p>VASO PL CONE BERLIAN GOLD PP MARRO A96-2 Código: 39939 Fábrica: PAIOL Unidade: UN/1 F1 F4</p>	 <p>VASO PL CONIC SINT S/BORDA M BANANA5011 Código: 41756 Fábrica: PAIOL Unidade: UN/1 F1 F4</p>	 <p>21 cm 24 cm</p> <p>VASO PL CONIC SINT S/BORDA P BANANA3536 Código: 37124 Fábrica: PAIOL Unidade: UN/1 F1 F4</p>	 <p>24 cm 17 cm</p> <p>VASO PL CRETA CONICO 24 BRANCO 3LTS Código: 34605 Fábrica: NUTRIPLAN Unidade: UN/1 F1 F4</p>



11 24 cm
17 cm

VASO PL CRETA CONICO 24 TABACO 3LTS

Código: 34604 Fábrica: NUTRIPLAN Unidade: UN/1 F1 F4

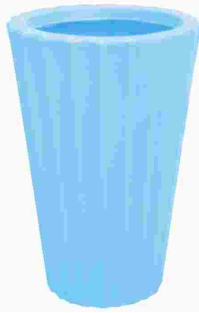

11 60 cm
42 cm

VASO PL CRETA CONICO 60 AZUL CELESTE 50L

Código: 35456 Fábrica: NUTRIPLAN Unidade: UN/1 F1 F4



11 60 cm
42 cm

VASO PL CRETA CONICO 60 ENVELHECIDO 50LT

Código: 34607 Fábrica: NUTRIPLAN Unidade: UN/1 F1 F4



11 12 cm
17 cm

VASO PL CRISANTEMO CONE CAPIM 2582

Código: 37107 Fábrica: PAIOL Unidade: UN/1 F1 F4



11 13 cm
18 cm

VASO PL CRISANTEMO CONE SINT ARGILA 2674

Código: 37105 Fábrica: PAIOL Unidade: UN/1 F1 F4



11 14 cm
18 cm

VASO PL CRISANTEMO CONE SINT BANANA 2674

Código: 40118 Fábrica: PAIOL Unidade: UN/1 F1 F4



11 14 cm
19 cm

VASO PL CRISANTEMO RED MAD C/LACO 1459

Código: 37109 Fábrica: PAIOL Unidade: UN/1 F1 F4



11 14 cm
18 cm

VASO PL CRISANTEMO RED MADEIRA PT/BC5914

Código: 37116 Fábrica: PAIOL Unidade: UN/1 F1 F4



11 14 cm
20 cm

VASO PL CRISANTEMO RED SINT ARGILA 40435

Código: 37132 Fábrica: PAIOL Unidade: UN/1 F1 F4



11 14 cm
18,5 cm

VASO PL CRISANTEMO RED TEXTURA LACO 3208

Código: 40614 Fábrica: PAIOL Unidade: UN/1 F1 F4



VASO PL CUIA CLASSIC 22 MARROM/PRETO

Código: 30348 Fábrica: NUTRIPLAN Unidade: UN/1 F1 F4



VASO PL CUIA CLASSIC 22 PRETO

Código: 30349 Fábrica: NUTRIPLAN Unidade: UN/1 F1 F4



11 12cm
22cm
2,7lts

VASO PL CUIA NOBRE 1 C/PRATO MARROM

Código: 37857 Fábrica: NUTRIPLAN Unidade: UN/1 F1 F4



11 12cm
22cm
2,7lts

VASO PL CUIA NOBRE 1 C/PRATO PRETO

Código: 38674 Fábrica: NUTRIPLAN Unidade: UN/1 F1 F4



11 13cm
27cm

VASO PL CUIA NOBRE 1,5 PRETO 4,5LTS

Código: 48428 Fábrica: NUTRIPLAN Unidade: UN/1 F1 F4



11 6,5 cm
13 cm

VASO PL CUIA SINT 13 S/BORDA BANAN 27066

Código: 37099 Fábrica: PAIOL Unidade: UN/1 F1 F4

<p>  </p> <p> 6,5 cm 13 cm </p> <p> VASO PL CUIA SINT 13 S/BORDA CAFE 27066 Código: 39454 Fábrica: PAIOL Unidade: UN/1 F1 F4 </p>	<p>  </p> <p> 9 cm 18 cm </p> <p> VASO PL CUIA SINT 13 S/BORDA CAPUC 27066 Código: 42967 Fábrica: PAIOL Unidade: UN/1 F1 F4 </p>	<p>  </p> <p> 9,5 cm 19 cm </p> <p> VASO PL CUIA SINT 17 S/BORDA BANAN 26910 Código: 39455 Fábrica: PAIOL Unidade: UN/1 F1 F4 </p>	<p>  </p> <p> 9 cm 18 cm </p> <p> VASO PL CUIA SINT 17 S/BORDA CAFE 26910 Código: 37098 Fábrica: PAIOL Unidade: UN/1 F1 F4 </p>
<p>  </p> <p> 9,5 cm 19 cm </p> <p> VASO PL CUIA SINT 17 S/BORDA CAPUC 26910 Código: 39456 Fábrica: PAIOL Unidade: UN/1 F1 F4 </p>	<p>  </p> <p> 10 cm 21 cm </p> <p> VASO PL CUIA SINT 20 S/BORDA ARGIL 26909 Código: 39457 Fábrica: PAIOL Unidade: UN/1 F1 F4 </p>	<p>  </p> <p> 10 cm 22 cm </p> <p> VASO PL CUIA SINT 20 S/BORDA BANAN 26909 Código: 37097 Fábrica: PAIOL Unidade: UN/1 F1 F4 </p>	<p>  </p> <p> 10 cm 22 cm </p> <p> VASO PL CUIA SINT 20 S/BORDA CAFE 26909 Código: 39458 Fábrica: PAIOL Unidade: UN/1 F1 F4 </p>
<p>  </p> <p> 11 cm 25 cm </p> <p> VASO PL CUIA SINT 25 S/BORDA ARGIL 40468 Código: 39461 Fábrica: PAIOL Unidade: UN/1 F1 F4 </p>	<p>  </p> <p> 11 cm 26 cm </p> <p> VASO PL CUIA SINT 25 S/BORDA BANAN 40468 Código: 37096 Fábrica: PAIOL Unidade: UN/1 F1 F4 </p>	<p>  </p> <p> 11 cm 26 cm </p> <p> VASO PL CUIA SINT 25 S/BORDA CAFE 40468 Código: 39460 Fábrica: PAIOL Unidade: UN/1 F1 F4 </p>	<p>  </p> <p> 12 cm 31 cm </p> <p> VASO PL CUIA SINT 28 S/BORDA ARG 26896-1 Código: 37095 Fábrica: PAIOL Unidade: UN/1 F1 F4 </p>
<p>  </p> <p> 13 cm 34 cm </p> <p> VASO PL CUIA SINT 32 S/BORDA ARGIL 50523 Código: 37094 Fábrica: PAIOL Unidade: UN/1 F1 F4 </p>	<p>  </p> <p> 32cm 14cm </p> <p> VASO PL CUIA SINT 32 S/BORDA BANAN 50523 Código: 41055 Fábrica: PAIOL Unidade: UN/1 F1 F4 </p>	<p>  </p> <p> 17 cm 42 cm </p> <p> VASO PL CUIA SINT 40 S/BORDA ARGIL 26944 Código: 37093 Fábrica: PAIOL Unidade: UN/1 F1 F4 </p>	<p>  </p> <p> 17 cm 13 cm 350 ml </p> <p> VASO PL CUIA 13 PRETO C/ALCA 350ML 15 Código: 38359 Fábrica: BIG PLAST Unidade: UN/1 F1 F4 </p>



VASO PL CUIA 18 PRETO C/GANCHO 121
 Código: 40795 Fábrica: NOVA BRASIL Unidade: UN/1
 F1 F4



VASO PL CUIA 21 COLOR C/ALCA BA 2,4L 815
 Código: 39854 Fábrica: BIG PLAST Unidade: UN/1
 F1 F4



VASO PL CUIA 21 PRETO C/GANCHO 125
 Código: 40796 Fábrica: NOVA BRASIL Unidade: UN/1
 F1 F4



VASO PL CUIA 22 PRETO C/GANCHO 133
 Código: 40797 Fábrica: NOVA BRASIL Unidade: UN/1
 F1 F4



↑ 38 cm
 → 26 cm

VASO PL DIAMANTE CONICO 38 AREIA 14LTS
 Código: 32744 Fábrica: NUTRIPLAN Unidade: UN/1
 F1 F4



↑ 38 cm
 → 26 cm

VASO PL DIAMANTE CONICO 38 FERRUGEM 14LT
 Código: 32743 Fábrica: NUTRIPLAN Unidade: UN/1
 F1 F4



↑ 22cm
 → 24,9cm

VASO PL ELO REDONDO 22 CARVALHO 6,5 L
 Código: 38923 Fábrica: NUTRIPLAN Unidade: UN/1
 F1 F4



↑ 22cm
 → 24,9cm

VASO PL ELO REDONDO 22 CIMENTO 6,5 L
 Código: 38922 Fábrica: NUTRIPLAN Unidade: UN/1
 F1 F4



↑ 22cm
 → 24,9cm

VASO PL ELO REDONDO 22 ENVELHECIDO 6,5 L
 Código: 38921 Fábrica: NUTRIPLAN Unidade: UN/1
 F1 F4



↑ 22cm
 → 24,9cm

VASO PL ELO REDONDO 22 PRETO 6,5 L
 Código: 38920 Fábrica: NUTRIPLAN Unidade: UN/1
 F1 F4



↑ 35cm
 → 38,5cm

VASO PL ELO REDONDO 35 CARVALHO 27 L
 Código: 38927 Fábrica: NUTRIPLAN Unidade: UN/1
 F1 F4



↑ 35cm
 → 38,5cm

VASO PL ELO REDONDO 35 CIMENTO 27 L
 Código: 38926 Fábrica: NUTRIPLAN Unidade: UN/1
 F1 F4



↑ 35cm
 → 38,5cm

VASO PL ELO REDONDO 35 PRETO 27 L
 Código: 38924 Fábrica: NUTRIPLAN Unidade: UN/1
 F1 F4



↑ 7 cm
 → 6 cm
 ▽ 160 ml

VASO PL ES 07 COLOR 160ML 386
 Código: 38362 Fábrica: BIG PLAST Unidade: UN/1
 F1 F4



↑ 16 cm
 → 14 cm
 ▽ 1,9 Lts

VASO PL ES 16 PRETO 1,9L 400
 Código: 38360 Fábrica: BIG PLAST Unidade: UN/1
 F1 F4



















↑ 24 cm
 → 14 cm

VASO PL FACE HOMEM 24 BRANCO 2,75LT
 Código: 42162 Fábrica: NUTRIPLAN Unidade: UN/1
 F1 F4

 <p>VASO PL FACE HOMEM 24 CIMENTO 2,75LT Código: 42159 Fábrica: NUTRIPLAN Unidade: UN/1 F1 F4</p>	 <p>VASO PL FACE HOMEM 24 COBRE 2,75LT Código: 42161 Fábrica: NUTRIPLAN Unidade: UN/1 F1 F4</p>	 <p>VASO PL FACE HOMEM 24 PRETO 2,75LT Código: 42163 Fábrica: NUTRIPLAN Unidade: UN/1 F1 F4</p>	 <p>VASO PL FACE MULHER 17 BRANCO 2,19LT Código: 42156 Fábrica: NUTRIPLAN Unidade: UN/1 F1 F4</p>
 <p>VASO PL FACE MULHER 17 CIMENTO 2,19LT Código: 42157 Fábrica: NUTRIPLAN Unidade: UN/1 F1 F4</p>	 <p>VASO PL FACE MULHER 17 COBRE 2,19LT Código: 42153 Fábrica: NUTRIPLAN Unidade: UN/1 F1 F4</p>	 <p>VASO PL FACE MULHER 17 PRETO 2,19LT Código: 42155 Fábrica: NUTRIPLAN Unidade: UN/1 F1 F4</p>	 <p>VASO PL FACE MULHER 34 BRANCO 14,5LT Código: 42164 Fábrica: NUTRIPLAN Unidade: UN/1 F1 F4</p>
 <p>VASO PL FACE MULHER 34 PRETO 14,5LT Código: 42165 Fábrica: NUTRIPLAN Unidade: UN/1 F1 F4</p>	 <p>VASO PL FIBRA COCO PAREDE G 19,6X26X26CM Código: 30294 Fábrica: NUTRIPLAN Unidade: UN/1 F1 F4</p>	 <p>VASO PL FIBRA COCO PAREDE M 15,5X20,5CM Código: 30293 Fábrica: NUTRIPLAN Unidade: UN/1 F1 F4</p>	 <p>VASO PL FIBRA DE COCO CONE 21,5X13X9CM Código: 34907 Fábrica: NUTRIPLAN Unidade: UN/1 F1 F4</p>
 <p>VASO PL FIBRA DE COCO 2 9,5X16X16CM Código: 18499 Fábrica: NUTRIPLAN Unidade: UN/1 F1 F4</p>	 <p>VASO PL FIBRA DE COCO 4 13X25,5X25,5CM Código: 18501 Fábrica: NUTRIPLAN Unidade: UN/1 F1 F4</p>	 <p>VASO PL FIBRA DE COCO 5 14X31X31CM Código: 18502 Fábrica: NUTRIPLAN Unidade: UN/1 F1 F4</p>	 <p>VASO PL FLOREIRA MARRON 3 LTS 1377 Código: 37009 Fábrica: ERCAPLAST Unidade: UN/1 F1 F4</p>

 <p> 22303 Código: 22303 Fábrica: NUTRIPLAN Unidade: UN/1 F1 F4 </p>	 <p> 22304 Código: 22304 Fábrica: NUTRIPLAN Unidade: UN/1 F1 F4 </p>	 <p> 41668 Código: 41668 Fábrica: INPLAST Unidade: UN/1 F1 F4 </p>	 <p> 30267 Código: 30267 Fábrica: NUTRIPLAN Unidade: UN/1 F1 F4 </p>
 <p> 30266 Código: 30266 Fábrica: NUTRIPLAN Unidade: UN/1 F1 F4 </p>	 <p> 33085 Código: 33085 Fábrica: NUTRIPLAN Unidade: UN/1 F1 F4 </p>	 <p> 36194 Código: 36194 Fábrica: NUTRIPLAN Unidade: UN/1 F1 F4 </p>	 <p> 30276 Código: 30276 Fábrica: NUTRIPLAN Unidade: UN/1 F1 F4 </p>
 <p> 30275 Código: 30275 Fábrica: NUTRIPLAN Unidade: UN/1 F1 F4 </p>	 <p> 33084 Código: 33084 Fábrica: NUTRIPLAN Unidade: UN/1 F1 F4 </p>	 <p> 32751 Código: 32751 Fábrica: NUTRIPLAN Unidade: UN/1 F1 F4 </p>	 <p> 36200 Código: 36200 Fábrica: NUTRIPLAN Unidade: UN/1 F1 F4 </p>
 <p> 28675 Código: 28675 Fábrica: NUTRIPLAN Unidade: UN/1 F1 F4 </p>	 <p> 27474 Código: 27474 Fábrica: NUTRIPLAN Unidade: UN/1 F1 F4 </p>	 <p> 36201 Código: 36201 Fábrica: NUTRIPLAN Unidade: UN/1 F1 F4 </p>	 <p> 41524 Código: 41524 Fábrica: ARIPLAS Unidade: UN/1 F1 F4 </p>

<p>2,8 L</p>  <p>VASO PL GREGO PAREDE COLOR 2,8LTS 421 Código: 41522 Fábrica: ARIPLAS Unidade: UN/1 F1 F4</p>	<p>820ml</p>  <p>VASO PL GREGO PAREDE COLOR 820ML 422 Código: 41527 Fábrica: ARIPLAS Unidade: UN/1 F1 F4</p>	<p>1,6 L</p>  <p>VASO PL GREGO PAREDE PRETO 1,6LTS 421 Código: 41526 Fábrica: ARIPLAS Unidade: UN/1 F1 F4</p>	<p>2,8 L</p>  <p>VASO PL GREGO PAREDE PRETO 2,8LTS 424 Código: 41523 Fábrica: ARIPLAS Unidade: UN/1 F1 F4</p>
<p>820 ml</p>  <p>VASO PL GREGO PAREDE PRETO 820ML 422 Código: 41528 Fábrica: ARIPLAS Unidade: UN/1 F1 F4</p>	<p>2,2 L</p>  <p>VASO PL GREGO RED COLOR 2,2LTS 345 Código: 41515 Fábrica: ARIPLAS Unidade: UN/1 F1 F4</p>	<p>9 L</p>  <p>VASO PL GREGO RED COLOR 9 LTS 341 Código: 41510 Fábrica: ARIPLAS Unidade: UN/1 F1 F4</p>	<p>2,2 L</p>  <p>VASO PL GREGO RED PRETO 2,2LTS 346 Código: 41514 Fábrica: ARIPLAS Unidade: UN/1 F1 F4</p>
<p>4,8 L</p>  <p>VASO PL GREGO RED PRETO 4,8 LTS 344 Código: 41513 Fábrica: ARIPLAS Unidade: UN/1 F1 F4</p>	<p>9 L</p>  <p>VASO PL GREGO RED PRETO 9 LTS 342 Código: 41511 Fábrica: ARIPLAS Unidade: UN/1 F1 F4</p>	<p>5cm 5,8cm</p>  <p>VASO PL HOLAMBRA POTE NP06 PRETO 80ML Código: 39210 Fábrica: NUTRIPLAN Unidade: UN/1 F1 F4</p>	 <p>VASO PL HOLAMBRA POTE NP11 PRETO 415ML Código: 38917 Fábrica: NUTRIPLAN Unidade: UN/1 F1 F4</p>
<p>9 cm 12 cm 0,7 lts</p>  <p>VASO PL HOLAMBRA POTE NP13 PRETO 725ML Código: 39211 Fábrica: NUTRIPLAN Unidade: UN/1 F1 F4</p>	<p>9.8 cm 13 cm 1 lts</p>  <p>VASO PL HOLAMBRA POTE NP14 PRETO 1LT Código: 38918 Fábrica: NUTRIPLAN Unidade: UN/1 F1 F4</p>	<p>10,5 cm 14,5 cm 1,16 lts</p>  <p>VASO PL HOLAMBRA POTE NP15 PRETO 1,16LT Código: 38919 Fábrica: NUTRIPLAN Unidade: UN/1 F1 F4</p>	 <p>VASO PL JARDINEIRA 2 LTS PRETA 3072 Código: 40412 Fábrica: FORMPLAST Unidade: UN/1 F1 F4</p>



VASO PL JARDINEIRA 5 LTS PRETA 3080

Código: **40413** Fábrica: **FORMPLAST** Unidade: **UN/1**
F1 F4

16 cm
100 cm



VASO PL JARDINEIRA CAFE 1MT 145

Código: **37149** Fábrica: **PAIOL** Unidade: **UN/1**
F1 F4

16 cm
40 cm



VASO PL JARDINEIRA CAFE 40CM 148

Código: **37221** Fábrica: **PAIOL** Unidade: **UN/1**
F1 F4

16 cm
60 cm



VASO PL JARDINEIRA CAFE 60CM 0047

Código: **37151** Fábrica: **PAIOL** Unidade: **UN/1**
F1 F4

16 cm
80 cm



VASO PL JARDINEIRA CAFE 80CM 0046

Código: **37150** Fábrica: **PAIOL** Unidade: **UN/1**
F1 F4



VASO PL JARDINEIRA 10 LTS PRETA 3087

Código: **40414** Fábrica: **FORMPLAST** Unidade: **UN/1**
F1 F4

11 cm
35 cm



VASO PL JARDINEIRA 35 CM BRANCO 3,5L

Código: **13603** Fábrica: **NUTRIPLAN** Unidade: **UN/1**
F1 F4

11 cm
35 cm



VASO PL JARDINEIRA 35 CM CAPUCCINO 3,5L

Código: **35202** Fábrica: **NUTRIPLAN** Unidade: **UN/1**
F1 F4

11 cm
35 cm

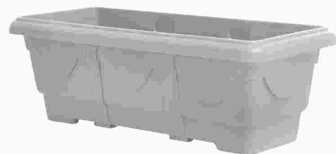

VASO PL JARDINEIRA 35 CM CINZA 3,5L

Código: **35203** Fábrica: **NUTRIPLAN** Unidade: **UN/1**
F1 F4

11 cm
35 cm

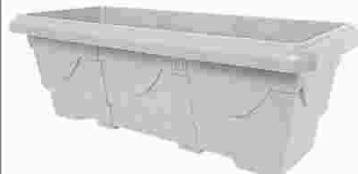

VASO PL JARDINEIRA 35 CM MARMORE 3,5L

Código: **30309** Fábrica: **NUTRIPLAN** Unidade: **UN/1**
F1 F4

11 cm
35 cm

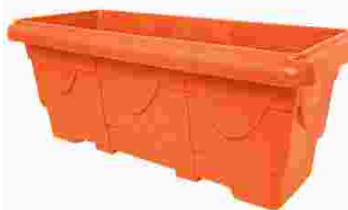

VASO PL JARDINEIRA 35 CM MARROM 3,5L

Código: **18507** Fábrica: **NUTRIPLAN** Unidade: **UN/1**
F1 F4

11 cm
35 cm



VASO PL JARDINEIRA 35 CM TABACO 3,5L

Código: **30308** Fábrica: **NUTRIPLAN** Unidade: **UN/1**
F1 F4

11 cm
80 cm



VASO PL JARDINEIRA 50 CM CAPUCCINO 11,5

Código: **35204** Fábrica: **NUTRIPLAN** Unidade: **UN/1**
F1 F4

11 cm
80 cm

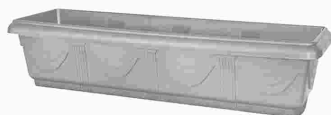

VASO PL JARDINEIRA 50 CM CINZA 11,5L

Código: **35205** Fábrica: **NUTRIPLAN** Unidade: **UN/1**
F1 F4

11 cm
80 cm



VASO PL JARDINEIRA 80 CM CAPUCCINO 24,5L

Código: **35457** Fábrica: **NUTRIPLAN** Unidade: **UN/1**
F1 F4

11 cm
80 cm

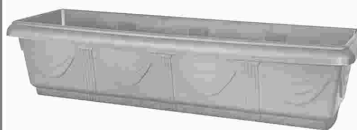

VASO PL JARDINEIRA 80 CM CINZA 34,5L

Código: **35458** Fábrica: **NUTRIPLAN** Unidade: **UN/1**
F1 F4

11 cm
35 cm

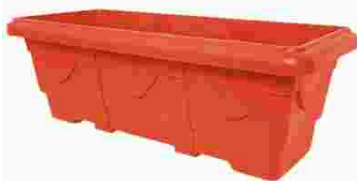

VASO PL JARDINEIRA 80 CM MARROM 24,5L

Código: 30310 Fábrica: NUTRIPLAN Unidade: UN/1 F1 F4

20 cm
14 cm
2,1 lts



VASO PL KIREY COLOR 2,1L 391

Código: 37720 Fábrica: BIG PLAST Unidade: UN/1 F1 F4

17 cm
30 cm
9 lts



VASO PL LUNA RED 17 TABACO 9LTS

Código: 37752 Fábrica: NUTRIPLAN Unidade: UN/1 F1 F4

17 cm
30 cm
9 lts



VASO PL LUNA RED 17 CIMENTO 9LTS

Código: 37754 Fábrica: NUTRIPLAN Unidade: UN/1 F1 F4

17 cm
30 cm
9 lts



VASO PL LUNA RED 17 ENVELHECIDO 9LTS

Código: 37753 Fábrica: NUTRIPLAN Unidade: UN/1 F1 F4

47 cm
31 cm
18 lts



VASO PL MING CONICO 47 AREIA 18LTS

Código: 33641 Fábrica: NUTRIPLAN Unidade: UN/1 F1 F4

23 cm
36 cm
12 lts



VASO PL MING RED BAIXO 23 AREIA 12LTS

Código: 33639 Fábrica: NUTRIPLAN Unidade: UN/1 F1 F4

23 cm
36 cm
12 lts



VASO PL MING RED BAIXO 23 CIMENTO 12LTS

Código: 33640 Fábrica: NUTRIPLAN Unidade: UN/1 F1 F4

23 cm
36 cm
12 lts



VASO PL MING RED BAIXO 23 FERRUGEM 12LTS

Código: 33644 Fábrica: NUTRIPLAN Unidade: UN/1 F1 F4

23 cm
36 cm
12 lts



VASO PL MING RED BAIXO 23 GRANITO 12LTS

Código: 33638 Fábrica: NUTRIPLAN Unidade: UN/1 F1 F4

33 cm
53 cm
44 lts



VASO PL MING RED BAIXO 33 AREIA 44LTS

Código: 33642 Fábrica: NUTRIPLAN Unidade: UN/1 F1 F4

33 cm
53 cm
44 lts



VASO PL MING RED BAIXO 33 FERRUGEM 44LTS

Código: 33643 Fábrica: NUTRIPLAN Unidade: UN/1 F1 F4

30 cm
36 cm



VASO PL N99 VIME SINTETICO ARGILA 0106

Código: 37123 Fábrica: PAIOL Unidade: UN/1 F1 F4

21,5 cm
28 cm



VASO PL ONDULADO PEQ AZUL 84-7

Código: 39953 Fábrica: PAIOL Unidade: UN/1 F1 F4

21,5 cm
28 cm



VASO PL ONDULADO PEQ BEGE 84-1

Código: 39951 Fábrica: PAIOL Unidade: UN/1 F1 F4

21,5 cm
28 cm



















VASO PL ONDULADO PEQ CIMENTO 84-5

Código: 39952 Fábrica: PAIOL Unidade: UN/1 F1 F4

 <p>VASO PL ONDULADO PEQ MARROM 84-2 Código: 39950 Fábrica: PAIOL Unidade: UN/1 F1 F4</p> <p>21,5 cm 28 cm</p>	 <p>VASO PL ORIGAMI RED 22 BRANCO 5,5LTS Código: 34615 Fábrica: NUTRIPLAN Unidade: UN/1 F1 F4</p> <p>22 cm 20 cm</p>	 <p>VASO PL ORIGAMI RED 22 CIMENTO 5,5LTS Código: 34616 Fábrica: NUTRIPLAN Unidade: UN/1 F1 F4</p> <p>22 cm 20 cm</p>	 <p>VASO PL ORIGAMI RED 22 ENVELHECIDO 5,5LTS Código: 34617 Fábrica: NUTRIPLAN Unidade: UN/1 F1 F4</p> <p>22 cm 20 cm</p>
 <p>VASO PL ORIGAMI RED 22 RUBI 5,5LTS Código: 34618 Fábrica: NUTRIPLAN Unidade: UN/1 F1 F4</p> <p>22 cm 20 cm</p>	 <p>VASO PL ORQUIDEA CONE SINT ARGILA 2673-1 Código: 37104 Fábrica: PAIOL Unidade: UN/1 F1 F4</p> <p>19 cm 20 cm</p>	 <p>VASO PL ORQUIDEA CONE SINT ARGILA 2673-1 Código: 40119 Fábrica: PAIOL Unidade: UN/1 F1 F4</p> <p>19,5 cm 21 cm</p>	 <p>VASO PL ORQUIDEA CONE SINT BANANA 2673-2 Código: 40120 Fábrica: PAIOL Unidade: UN/1 F1 F4</p> <p>19,5 cm 21 cm</p>
 <p>VASO PL ORQUIDEA RED CAFE 00138 Código: 37119 Fábrica: PAIOL Unidade: UN/1 F1 F4</p> <p>23 cm 23 cm</p>	 <p>VASO PL ORQUIDEA RED MAD C/FLOR 1458/327 Código: 37108 Fábrica: PAIOL Unidade: UN/1 F1 F4</p> <p>20 cm 23 cm</p>	 <p>VASO PL ORQUIDEA RED MADEIRA PT/BC 5912 Código: 37117 Fábrica: PAIOL Unidade: UN/1 F1 F4</p> <p>20 cm 20 cm</p>	 <p>VASO PL PAREDE BELLA 1,7LTS PTO 9500 Código: 45182 Fábrica: RISCHIOTO Unidade: UN/1 F1 F4</p> <p>13 cm 26 cm 1,7 L</p>
 <p>VASO PL PAREDE GDE BANANA 27001-2 Código: 37101 Fábrica: PAIOL Unidade: UN/1 F1 F4</p> <p>18 cm 29 cm</p>	 <p>VASO PL PAREDE GDE C/BORD ARGILA 27001-1 Código: 37100 Fábrica: PAIOL Unidade: UN/1 F1 F4</p> <p>18 cm 29 cm</p>	 <p>VASO PL PAREDE MARROM 1650 ML 2470 Código: 37013 Fábrica: ERCAPLAST Unidade: UN/1 F1 F4</p> <p>18 cm 22 cm 1,6 lts</p>	 <p>VASO PL PAREDE MARROM 3400 ML 2472 Código: 37010 Fábrica: ERCAPLAST Unidade: UN/1 F1 F4</p> <p>17,5 cm 31 cm 3,4 lts</p>

<p> 11 cm</p> <p>VASO PL PAREDE MED PRETO 11CM 287</p> <p>Código: 40715 Fábrica: PLASMARC Unidade: UN/1 F1 F4</p>	<p> 17 cm 32 cm</p> <p>VASO PL PAREDE MED VERDE</p> <p>Código: 46045 Fábrica: NUTRIPLAN Unidade: UN/1 F1 F4</p>	<p></p> <p>VASO PL PAREDE MEDIO MARROM</p> <p>Código: 30313 Fábrica: NUTRIPLAN Unidade: UN/1 F1 F4</p>	<p></p> <p>VASO PL PAREDE MEDIO PRETO</p> <p>Código: 30314 Fábrica: NUTRIPLAN Unidade: UN/1 F1 F4</p>
<p></p> <p>VASO PL PAREDE MEDIO TABACO</p> <p>Código: 30312 Fábrica: NUTRIPLAN Unidade: UN/1 F1 F4</p>	<p> 10 cm 20 cm</p> <p>VASO PL PAREDE MINI MARROM</p> <p>Código: 30316 Fábrica: NUTRIPLAN Unidade: UN/1 F1 F4</p>	<p></p> <p>VASO PL PAREDE MINI PRETO</p> <p>Código: 30315 Fábrica: NUTRIPLAN Unidade: UN/1 F1 F4</p>	<p></p> <p>VASO PL PAREDE MINI TABACO</p> <p>Código: 30317 Fábrica: NUTRIPLAN Unidade: UN/1 F1 F4</p>
<p> 10 cm 20 cm</p> <p>VASO PL PAREDE MINI VERDE</p> <p>Código: 47605 Fábrica: NUTRIPLAN Unidade: UN/1 F1 F4</p>	<p> 10,5 cm 16 cm</p> <p>VASO PL PAREDE PEQ ARGILA 27005-1</p> <p>Código: 37102 Fábrica: PAIOL Unidade: UN/1 F1 F4</p>	<p> 08 cm</p> <p>VASO PL PAREDE PEQ PRETO 8CM 255</p> <p>Código: 40714 Fábrica: PLASMARC Unidade: UN/1 F1 F4</p>	<p> 13 cm 26 cm 2 lts</p> <p>VASO PL PAREDE PEQ VERDE</p> <p>Código: 34611 Fábrica: NUTRIPLAN Unidade: UN/1 F1 F4</p>
<p> 18 cm 22 cm 1,6 lts</p> <p>VASO PL PAREDE PRETO 1650 ML 2469</p> <p>Código: 37012 Fábrica: ERCAPLAST Unidade: UN/1 F1 F4</p>	<p> 17,5 cm 31 cm 3,4 lts</p> <p>VASO PL PAREDE PRETO 3400 ML 2471</p> <p>Código: 37011 Fábrica: ERCAPLAST Unidade: UN/1 F1 F4</p>	<p> 17 cm 30 cm 3 lts</p> <p>VASO PL PAREDE 30 PRETO 3L 268</p> <p>Código: 37701 Fábrica: BIG PLAST Unidade: UN/1 F1 F4</p>	<p> 30 cm</p> <p>VASO PL PETRA CONE 30 C/PRATO AREIA</p> <p>Código: 36810 Fábrica: NUTRIPLAN Unidade: UN/1 F1 F4</p>

<p></p> <p>VASO PL PETRA CONE 30 C/PRATO FERRUGEM Código: 36809 Fábrica: NUTRIPLAN Unidade: UN/1 F1 F4</p> <p>30 cm</p>	<p></p> <p>VASO PL PF 11 PRETO 300ML 130 Código: 38361 Fábrica: BIG PLAST Unidade: UN/1 F1 F4</p> <p>8 cm 11 cm 300 ml</p>	<p></p> <p>VASO PL POTE SINT 07 S/BORDA ARGIL 60623 Código: 39437 Fábrica: PAIOL Unidade: UN/1 F1 F4</p> <p>5 cm 8 cm</p>	<p></p> <p>VASO PL POTE SINT 07 S/BORDA CAFE 60623 Código: 37087 Fábrica: PAIOL Unidade: UN/1 F1 F4</p> <p>5 cm 8 cm</p>
<p></p> <p>VASO PL POTE SINT 07 S/BORDA CAPUC 60623 Código: 39438 Fábrica: PAIOL Unidade: UN/1 F1 F4</p> <p>5 cm 8 cm</p>	<p></p> <p>VASO PL POTE SINT 09 S/BORDA CAFE 4046 Código: 39442 Fábrica: PAIOL Unidade: UN/1 F1 F4</p> <p>7 cm 9 cm</p>	<p></p> <p>VASO PL POTE SINT 09 S/BORDA CAPUCI 4046 Código: 39444 Fábrica: PAIOL Unidade: UN/1 F1 F4</p> <p>7 cm 9 cm</p>	<p></p> <p>VASO PL POTE SINT 11 S/BORDA ARGIL 40461 Código: 39439 Fábrica: PAIOL Unidade: UN/1 F1 F4</p> <p>7 cm 12 cm</p>
<p></p> <p>VASO PL POTE SINT 11 S/BORDA BANAN 40461 Código: 39440 Fábrica: PAIOL Unidade: UN/1 F1 F4</p> <p>7 cm 12 cm</p>	<p></p> <p>VASO PL POTE SINT 11 S/BORDA BRANC 40461 Código: 39441 Fábrica: PAIOL Unidade: UN/1 F1 F4</p> <p>7 cm 9 cm</p>	<p></p> <p>VASO PL POTE SINT 11 S/BORDA CAFE 40461 Código: 37084 Fábrica: PAIOL Unidade: UN/1 F1 F4</p> <p>8 cm 10 cm</p>	<p></p> <p>VASO PL POTE SINT 11 S/BORDA CAPUC 40461 Código: 39931 Fábrica: PAIOL Unidade: UN/1 F1 F4</p>
<p></p> <p>VASO PL PRETO G 24LTS 650011 Código: 41204 Fábrica: PLASTSU Unidade: UN/1 F1 F4</p>	<p></p> <p>VASO PL PRETO M 951710 Código: 41202 Fábrica: PLASTSU Unidade: UN/1 F1 F4</p>	<p></p> <p>VASO PL PRETO P 9LTS 951314 Código: 41200 Fábrica: PLASTSU Unidade: UN/1 F1 F4</p>	<p></p> <p>VASO PL PRIMAVERA 2 RED PEQ MARROM 3 L Código: 33540 Fábrica: NUTRIPLAN Unidade: UN/1 F1 F4</p> <p>13 cm 17 cm 1,9 L</p>

13 cm
17 cm
1,9 L



VASO PL PRIMAVERA 2 RED PEQ PRETO 3 L

Código: **33541** Fábrica: **NUTRIPLAN** Unidade: **UN/1**
F1 F4

14 cm
19 cm



VASO PL PRIMAVERA 3 RED PEQ MARROM 3 L

Código: **22164** Fábrica: **NUTRIPLAN** Unidade: **UN/1**
F1 F4

14 cm
19 cm



VASO PL PRIMAVERA 3 RED PEQ PRETO 3L

Código: **22168** Fábrica: **NUTRIPLAN** Unidade: **UN/1**
F1 F4

19 cm
23 cm
5,6 L



VASO PL PRIMAVERA 4 RED MED MARROM

Código: **22165** Fábrica: **NUTRIPLAN** Unidade: **UN/1**
F1 F4

19 cm
23 cm
5,6 L



VASO PL PRIMAVERA 4 RED MED PRETO

Código: **33542** Fábrica: **NUTRIPLAN** Unidade: **UN/1**
F1 F4

22 cm
25 cm
08 lts



VASO PL PRIMAVERA 5 RED MED CINZA

Código: **35215** Fábrica: **NUTRIPLAN** Unidade: **UN/1**
F1 F4

22 cm
25 cm
8lts



VASO PL PRIMAVERA 5 RED MED MARROM

Código: **22166** Fábrica: **NUTRIPLAN** Unidade: **UN/1**
F1 F4



VASO PL PRIMAVERA 5 RED MED PRETO

Código: **22170** Fábrica: **NUTRIPLAN** Unidade: **UN/1**
F1 F4



VASO PL PRIMAVERA 6 RED GDE MARROM 6 L

Código: **22167** Fábrica: **NUTRIPLAN** Unidade: **UN/1**
F1 F4



VASO PL PRIMAVERA 6 RED GDE PRETO

Código: **22171** Fábrica: **NUTRIPLAN** Unidade: **UN/1**
F1 F4

40 cm
29 cm

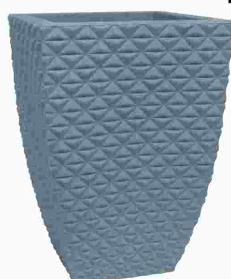

VASO PL QUAD BERLIAN GOLD P AZUL A82-9

Código: **40031** Fábrica: **PAIOL** Unidade: **UN/1**
F1 F4

40 cm
29 cm

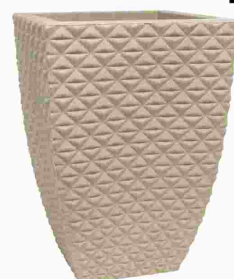

VASO PL QUAD BERLIAN GOLD P BEGE A82-1

Código: **40029** Fábrica: **PAIOL** Unidade: **UN/1**
F1 F4

40 cm
29 cm

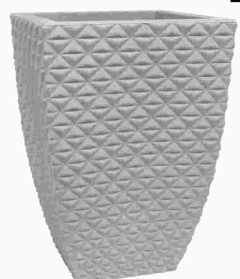

VASO PL QUAD BERLIAN GOLD P CIMENT A82-5

Código: **40030** Fábrica: **PAIOL** Unidade: **UN/1**
F1 F4

40 cm
29 cm



VASO PL QUAD BERLIAN GOLD P MAROM A82-2

Código: **40028** Fábrica: **PAIOL** Unidade: **UN/1**
F1 F4

27 cm
19,5 cm



VASO PL QUAD BOJO 0 AZUL 53-7











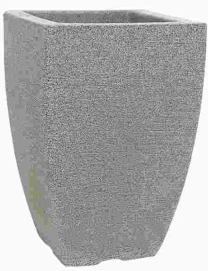
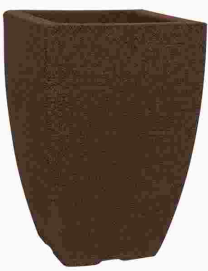



Código: **39946** Fábrica: **PAIOL** Unidade: **UN/1**
F1 F4

27 cm
19,5 cm



VASO PL QUAD BOJO 0 BEGE 53-2

Código: **39944** Fábrica: **PAIOL** Unidade: **UN/1**
F1 F4

 <p>27 cm 19,5 cm</p> <p>VASO PL QUAD BOJO 0 CIMENTO 53-4 Código: 39945 Fábrica: PAIOL Unidade: UN/1 F1 F4</p>	 <p>27 cm 19,5 cm</p> <p>VASO PL QUAD BOJO 0 MARROM 53-3 Código: 39943 Fábrica: PAIOL Unidade: UN/1 F1 F4</p>	 <p>1,7 L</p> <p>VASO PL QUAD COLOR 1,7LTS 403 Código: 41516 Fábrica: ARIPLAS Unidade: UN/1 F1 F4</p>	 <p>3,5 L</p> <p>VASO PL QUAD COLOR 3,5LTS 405 Código: 41518 Fábrica: ARIPLAS Unidade: UN/1 F1 F4</p>
 <p>6 L</p> <p>VASO PL QUAD COLOR 6,4LTS 407 Código: 41520 Fábrica: ARIPLAS Unidade: UN/1 F1 F4</p>	 <p>14 cm 16 cm 2 lts</p> <p>VASO PL QUAD MARROM 2,0 LTS 1332 Código: 36988 Fábrica: ERCAPLAST Unidade: UN/1 F1 F4</p>	 <p>19 cm 22 cm 4,6 lts</p> <p>VASO PL QUAD MARROM 4,6 LTS 1334 Código: 36987 Fábrica: ERCAPLAST Unidade: UN/1 F1 F4</p>	 <p>11 cm 18 cm 0,8 lts</p> <p>VASO PL QUAD MARROM 800 ML 1384 2X1 Código: 36990 Fábrica: ERCAPLAST Unidade: CJ/2 F1 F4</p>
 <p>1,7 L</p> <p>VASO PL QUAD PRETO 1,7LTS 404 Código: 41517 Fábrica: ARIPLAS Unidade: UN/1 F1 F4</p>	 <p>14 cm 16 cm 2 lts</p> <p>VASO PL QUAD PRETO 2,0 LTS 1331 Código: 36989 Fábrica: ERCAPLAST Unidade: UN/1 F1 F4</p>	 <p>3,5 L</p> <p>VASO PL QUAD PRETO 3,5LTS 406 Código: 41519 Fábrica: ARIPLAS Unidade: UN/1 F1 F4</p>	 <p>6 L</p> <p>VASO PL QUAD PRETO 6,4LTS 408 Código: 41521 Fábrica: ARIPLAS Unidade: UN/1 F1 F4</p>
  <p>11 cm 18 cm 0,8 lts</p> <p>VASO PL QUAD PRETO 800 ML 1383 2X1 Código: 36991 Fábrica: ERCAPLAST Unidade: CJ/2 F1 F4</p>	 <p>24 cm 28 cm 9,5 lts</p> <p>VASO PL QUAD PRETO 9,5 LTS 1349 Código: 36985 Fábrica: ERCAPLAST Unidade: UN/1 F1 F4</p>	 <p>11 cm 16 cm 0,85 lts</p> <p>VASO PL QUARTZO 11 FERRUGEM 0,85 LTS Código: 37845 Fábrica: NUTRIPLAN Unidade: UN/1 F1 F4</p>	 <p>16 cm 23 cm 4,75 lts</p> <p>VASO PL QUARTZO 16 FERRUGEM 4,75 LTS Código: 37846 Fábrica: NUTRIPLAN Unidade: UN/1 F1 F4</p>

1 22 cm
2 31 cm
3 8 lts



VASO PL QUARTZO 22 FERRUGEM 8LTS

Código: **37847** Fábrica: **NUTRIPLAN** Unidade: **UN/1**
F1 F4

1 30 cm
2 43 cm
3 25 lts



VASO PL QUARTZO 30 FERRUGEM 25LTS

Código: **37848** Fábrica: **NUTRIPLAN** Unidade: **UN/1**
F1 F4

1 18,5 cm
2 23 cm



VASO PL RED BOJO CONE 0 BEGE 96-1

Código: **39934** Fábrica: **PAIOL** Unidade: **UN/1**
F1 F4

1 18,5 cm
2 23 cm



VASO PL RED BOJO CONE 0 CIMENTO 96-5

Código: **39933** Fábrica: **PAIOL** Unidade: **UN/1**
F1 F4

1 29 cm
2 34 cm



VASO PL RED BOJO CONE 1 AZUL 73-7

Código: **39938** Fábrica: **PAIOL** Unidade: **UN/1**
F1 F4

1 29 cm
2 34 cm



VASO PL RED BOJO CONE 1 BEGE 73-2

Código: **39936** Fábrica: **PAIOL** Unidade: **UN/1**
F1 F4

1 29 cm
2 34 cm



VASO PL RED BOJO CONE 1 MARROM 73-1

Código: **39935** Fábrica: **PAIOL** Unidade: **UN/1**
F1 F4

1 16 cm
2 27 cm
3 6 lts



VASO PL RED CANELAD PRETO 6L C/ALCA 2617

Código: **37002** Fábrica: **ERCAPLAST** Unidade: **UN/1**
F1 F4

1 12,5 cm
2 25 cm
3 3 lts



VASO PL RED CUIA COLOR 3L 2598

Código: **37006** Fábrica: **ERCAPLAST** Unidade: **UN/1**
F1 F4

1 11 cm
2 12 cm
3 0,7 lts



VASO PL RED MARROM 700 ML 1382 2X1

Código: **36984** Fábrica: **ERCAPLAST** Unidade: **CJ/2**
F1 F4

1 37 cm
2 28 cm
3 7,5 lts



VASO PL RED MARROM 7,5 LTS 1323

Código: **36979** Fábrica: **ERCAPLAST** Unidade: **UN/1**
F1 F4

1 16 cm
2 27 cm
3 6 lts



VASO PL RED PRETO N22 3,7LTS 926

Código: **51043** Fábrica: **LUMAR** Unidade: **UN/1**
F1 F4

1 31 cm
2 35 cm
3 15 lts



VASO PL RED PRETO N28 8,0LTS 915

Código: **51044** Fábrica: **LUMAR** Unidade: **UN/1**
F1 F4

1 31 cm
2 35 cm
3 15 lts



VASO PL RED PRETO N36 16LTS 916

Código: **51045** Fábrica: **LUMAR** Unidade: **UN/1**
F1 F4

1 31 cm
2 35 cm
3 15 lts



VASO PL RED PRETO 15 LTS 1328

Código: **36977** Fábrica: **ERCAPLAST** Unidade: **UN/1**
F1 F4

1 14 cm
2 17 cm
3 1,75 lts



VASO PL RED PRETO 1,75 LTS 1305

Código: **36982** Fábrica: **ERCAPLAST** Unidade: **UN/1**
F1 F4

 <p>VASO PL RED PRETO 3,8 LTS 1306 Código: 36981 Fábrica: ERCAPLAST Unidade: UN/1 F1 F4</p> <p>18 cm 22 cm 3,8 lts</p>	 <p>VASO PL RED PRETO 700 ML 1381 2X1 Código: 36983 Fábrica: ERCAPLAST Unidade: CJ/2 F1 F4</p> <p>11 cm 12 cm 0,7 lts</p>	 <p>VASO PL RED PRETO 7,5 LTS 1322 Código: 36978 Fábrica: ERCAPLAST Unidade: UN/1 F1 F4</p> <p>37 cm 28 cm 7,5 lts</p>	 <p>VASO PL RED RELEVO 40 PRETO Código: 41387 Fábrica: NUTRIPLAN Unidade: UN/1 F1 F4</p> <p>48 cm 40 cm</p>
 <p>VASO PL RED RELEVO 40 TABACO Código: 41386 Fábrica: NUTRIPLAN Unidade: UN/1 F1 F4</p> <p>48 cm 40 cm</p>	 <p>VASO PL RELEVO OVAL 23 CARVALHO Código: 44137 Fábrica: NUTRIPLAN Unidade: UN/1 F1 F4</p> <p>24 cm 54 cm</p>	 <p>VASO PL RELEVO OVAL 42 CARVALHO Código: 44139 Fábrica: NUTRIPLAN Unidade: UN/1 F1 F4</p> <p>42 cm 40 cm</p>	 <p>VASO PL RELEVO OVAL 42 CIMENTO Código: 44140 Fábrica: NUTRIPLAN Unidade: UN/1 F1 F4</p> <p>42 cm 40 cm</p>
 <p>VASO PL RELEVO REDONDO 67 97LT CIMENTO Código: 42183 Fábrica: NUTRIPLAN Unidade: UN/1 F1 F4</p> <p>67 cm 48 cm</p>	 <p>VASO PL RELEVO REDONDO 67 97LT CIMENTO Q Código: 42184 Fábrica: NUTRIPLAN Unidade: UN/1 F1 F4</p> <p>67 cm 48 cm</p>	 <p>VASO PL RELEVO REDONDO 67 97LT OURO ENVE Código: 42185 Fábrica: NUTRIPLAN Unidade: UN/1 F1 F4</p> <p>67 cm 48 cm</p>	 <p>VASO PL RISCATTO CONICO 42 FERRUGEM 20LT Código: 30280 Fábrica: NUTRIPLAN Unidade: UN/1 F1 F4</p> <p>42 cm 30 cm</p>
 <p>VASO PL RISCATTO CONICO 42 GRANITO 20LTS Código: 30281 Fábrica: NUTRIPLAN Unidade: UN/1 F1 F4</p> <p>42 cm 30 cm</p>	 <p>VASO PL RISCATTO CONICO 55 FERRUGEM 44LT Código: 30282 Fábrica: NUTRIPLAN Unidade: UN/1 F1 F4</p> <p>55 cm 39 cm</p>	 <p>VASO PL RISCATTO CONICO 55 GRANITO 44LTS Código: 30283 Fábrica: NUTRIPLAN Unidade: UN/1 F1 F4</p> <p>55 cm 39 cm</p>	 <p>VASO PL RISCATTO OVAL BAIXO 22 AREIA 12L Código: 30270 Fábrica: NUTRIPLAN Unidade: UN/1 F1 F4</p> <p>22 cm 31 cm</p>

22 cm
31 cm



VASO PL RISCATTO OVAL BAIXO 22 FERRU 12L
Código: **30271** Fábrica: **NUTRIPLAN** Unidade: **UN/1**
F1 F4

22 cm
31 cm
12 lts



VASO PL RISCATTO OVAL BAIXO 22 GRANI 12L
Código: **37410** Fábrica: **NUTRIPLAN** Unidade: **UN/1**
F1 F4

30 cm
43 cm



VASO PL RISCATTO OVAL BAIXO 30 AREIA 32L
Código: **30269** Fábrica: **NUTRIPLAN** Unidade: **UN/1**
F1 F4

30 cm
43 cm



VASO PL RISCATTO OVAL BAIXO 30 FERRU 32L
Código: **30268** Fábrica: **NUTRIPLAN** Unidade: **UN/1**
F1 F4

35 cm
28 cm



VASO PL RISCATTO RED 34 AREIA 26,5LT
Código: **30272** Fábrica: **NUTRIPLAN** Unidade: **UN/1**
F1 F4

35 cm
28 cm



VASO PL RISCATTO RED 34 FERRUGEM 26,5LTS
Código: **30273** Fábrica: **NUTRIPLAN** Unidade: **UN/1**
F1 F4

35 cm
28 cm



VASO PL RISCATTO RED 34 GRANITO 26,5LTS
Código: **30274** Fábrica: **NUTRIPLAN** Unidade: **UN/1**
F1 F4

9,5 cm
12,5 cm



VASO PL ROMANO RED MINI MARROM 0,6L
Código: **22309** Fábrica: **NUTRIPLAN** Unidade: **UN/1**
F1 F4

14,5 cm
19 cm



VASO PL ROMANO 0 RED PEQ MARROM 2L
Código: **22308** Fábrica: **NUTRIPLAN** Unidade: **UN/1**
F1 F4

2 lts



VASO PL ROMANO 0 RED PEQ PRETO 2L
Código: **39641** Fábrica: **NUTRIPLAN** Unidade: **UN/1**
F1 F4

19,5 cm
25 cm



VASO PL ROMANO 1 RED MED MARROM 5L
Código: **22307** Fábrica: **NUTRIPLAN** Unidade: **UN/1**
F1 F4

5 lts



VASO PL ROMANO 1 RED MED PRETO 5L
Código: **39642** Fábrica: **NUTRIPLAN** Unidade: **UN/1**
F1 F4

23 cm
30 cm



VASO PL ROMANO 2 RED GDE MARROM 8,5L
Código: **22306** Fábrica: **NUTRIPLAN** Unidade: **UN/1**
F1 F4

8,5 lts



VASO PL ROMANO 2 RED PRETO 8,5L
Código: **39643** Fábrica: **NUTRIPLAN** Unidade: **UN/1**
F1 F4

23 cm
30 cm
8,5 lts



VASO PL ROMANO 2 RED TABACO 8,5L
Código: **39855** Fábrica: **NUTRIPLAN** Unidade: **UN/1**
F1 F4

30 cm
39 cm
19 lts



VASO PL ROMANO 3 RED CAPUCCINO 19L
Código: **36195** Fábrica: **NUTRIPLAN** Unidade: **UN/1**
F1 F4

30 cm
39 cm



VASO PL ROMANO 3 RED MARROM 19 L

Código: **22305** Fábrica: **NUTRIPLAN** Unidade: **UN/1**
F1 F4

19 lts



VASO PL ROMANO 3 RED PRETO 19 L

Código: **39644** Fábrica: **NUTRIPLAN** Unidade: **UN/1**
F1 F4

10 cm
13 cm



VASO PL SINT 13 S/BORDA ARGILA 0908-1

Código: **37083** Fábrica: **PAIOL** Unidade: **UN/1**
F1 F4

10 cm
14,5 cm



VASO PL SINT 13 S/BORDA BANANA 0908-2

Código: **39445** Fábrica: **PAIOL** Unidade: **UN/1**
F1 F4

14 cm
15 cm



VASO PL SINT 16 S/BORDA BANANA 3598-2

Código: **37082** Fábrica: **PAIOL** Unidade: **UN/1**
F1 F4



VASO PL SINT 16 S/BORDA CAPUCINO 3598

Código: **39465** Fábrica: **PAIOL** Unidade: **UN/1**
F1 F4

20 cm
15 cm



VASO PL SINT 18 S/BORDA ARGILA 909-1

Código: **37081** Fábrica: **PAIOL** Unidade: **UN/1**
F1 F4



VASO PL SINT 18 S/BORDA BANANA 909-2

Código: **40843** Fábrica: **PAIOL** Unidade: **UN/1**
F1 F4

15 cm
20 cm



VASO PL SINT 18 S/BORDA CAFE 909-4

Código: **39462** Fábrica: **PAIOL** Unidade: **UN/1**
F1 F4



VASO PL SINT 18 S/BORDA CAPUCINO 909

Código: **39463** Fábrica: **PAIOL** Unidade: **UN/1**
F1 F4

VASO PL SINT 20 S/BORDA BANANA 8006-4

Código: **40844** Fábrica: **PAIOL** Unidade: **UN/1**
F1 F4

2,5 cm
66 cm



VASO PL SINT 24 S/BORDA BANANA 3538-2

Código: **37089** Fábrica: **PAIOL** Unidade: **UN/1**
F1 F4

19 cm
25 cm



VASO PL SINT 24 S/BORDA CAPUCINO 3538-3

Código: **39929** Fábrica: **PAIOL** Unidade: **UN/1**
F1 F4



VASO PL SINT 27 S/BORDA ARGILA 3541-1

Código: **41755** Fábrica: **PAIOL** Unidade: **UN/1**
F1 F4

30 cm
24 cm



VASO PL SINT 27 S/BORDA BANANA 3541-2

Código: **37088** Fábrica: **PAIOL** Unidade: **UN/1**
F1 F4

34 cm
42 cm



VASO PL SINT 98 C/BORDA ARGILA 26958-1

Código: **37122** Fábrica: **PAIOL** Unidade: **UN/1**
F1 F4

5 cm
7 cm



VASO PL SISAL POTE MINI AVELA 8000-4

Código: 40594
Fábrica: PAIOL
Unidade: UN/1
F1 F4

5 cm
7 cm



VASO PL SISAL POTE MINI MARROM 8000-1

Código: 40592
Fábrica: PAIOL
Unidade: UN/1
F1 F4

5,5 cm
7,5 cm



VASO PL SISAL POTE MINI NATURAL 8000-2

Código: 37131
Fábrica: PAIOL
Unidade: UN/1
F1 F4



VASO PL SISAL POTE 10 AVELA 8001

Código: 39448
Fábrica: PAIOL
Unidade: UN/1
F1 F4



VASO PL SISAL POTE 10 CARAMELO 8001

Código: 39449
Fábrica: PAIOL
Unidade: UN/1
F1 F4



VASO PL SISAL POTE 10 MARROM 8001

Código: 39447
Fábrica: PAIOL
Unidade: UN/1
F1 F4

8 cm
11 cm



VASO PL SISAL POTE 10 NATURAL 8001-3

Código: 37130
Fábrica: PAIOL
Unidade: UN/1
F1 F4

9 cm
13 cm



VASO PL SISAL POTE 12 CORES 8002

Código: 37129
Fábrica: PAIOL
Unidade: UN/1
F1 F4

10 cm
15 cm



VASO PL SISAL POTE 14 CORES 8003

Código: 37128
Fábrica: PAIOL
Unidade: UN/1
F1 F4

12 cm
16 cm



VASO PL SISAL POTE 16 CORES 8004

Código: 37127
Fábrica: PAIOL
Unidade: UN/1
F1 F4

25 cm
30 cm



VASO PL TERRACOTA 2 MED MARROM

Código: 18480
Fábrica: NUTRIPLAN
Unidade: UN/1
F1 F4

31 cm
39 cm



VASO PL TERRACOTA 3 GDE MARROM 22 L

Código: 18482
Fábrica: NUTRIPLAN
Unidade: UN/1
F1 F4

22 lts



VASO PL TERRACOTA 3 GDE PTO 22 L

Código: 18483
Fábrica: NUTRIPLAN
Unidade: UN/1
F1 F4

19cm



VASO PL TEXTURIZADO OVAL 19 AREIA 5,3L

Código: 47612
Fábrica: NUTRIPLAN
Unidade: UN/1
F1 F4

19cm



VASO PL TEXTURIZADO OVAL 19 CIMENTO 5,3L

Código: 47614
Fábrica: NUTRIPLAN
Unidade: UN/1
F1 F4

19cm



VASO PL TEXTURIZADO OVAL 19 FERRUGE 5,3L

Código: 47611
Fábrica: NUTRIPLAN
Unidade: UN/1
F1 F4

 <p>VASO PL TEXTURIZADO OVAL 19 GRANITO 5,3L Código: 47613 Fábrica: NUTRIPLAN Unidade: UN/1 F1 F4</p>	 <p>VASO PL TEXTURIZADO OVAL 19 PRETO 5,3L Código: 47615 Fábrica: NUTRIPLAN Unidade: UN/1 F1 F4</p>	 <p>VASO PL TINA RED 34 CARVALHO 30LTS Código: 30311 Fábrica: NUTRIPLAN Unidade: UN/1 F1 F4</p>	 <p>VASO PL TINA RED 45 CARVALHO 80LTS Código: 30332 Fábrica: NUTRIPLAN Unidade: UN/1 F1 F4</p>
 <p>VASO PL TRECCIA CONICO 30 CARVALHO 6,5LT Código: 33388 Fábrica: NUTRIPLAN Unidade: UN/1 F1 F4</p>	 <p>VASO PL TRECCIA CONICO 30 ENVELHECI 6,5L Código: 32745 Fábrica: NUTRIPLAN Unidade: UN/1 F1 F4</p>	 <p>VASO PL TRECCIA CONICO 39 GRAFITE 33LTS Código: 36806 Fábrica: NUTRIPLAN Unidade: UN/1 F1 F4</p>	 <p>VASO PL TRECCIA CONICO 53 CARVALHO 42LTS Código: 32747 Fábrica: NUTRIPLAN Unidade: UN/1 F1 F4</p>
 <p>VASO PL TRECCIA OVAL 33 CARVALHO 19LTS Código: 32748 Fábrica: NUTRIPLAN Unidade: UN/1 F1 F4</p>	 <p>VASO PL TRECCIA RED 24 CARVALHO 8,5LTS Código: 33389 Fábrica: NUTRIPLAN Unidade: UN/1 F1 F4</p>	 <p>VASO PL TRECCIA RED 24 ENVELHECIDO 8,5LT Código: 33390 Fábrica: NUTRIPLAN Unidade: UN/1 F1 F4</p>	 <p>VASO PL TRECCIA RED 24 RUBI 8,5LTS Código: 33391 Fábrica: NUTRIPLAN Unidade: UN/1 F1 F4</p>
 <p>VASO PL TRECCIA RED 31 CARVALHO 20LTS Código: 33393 Fábrica: NUTRIPLAN Unidade: UN/1 F1 F4</p>	 <p>VASO PL TRECCIA RED 31 ENVELHECIDO 20LTS Código: 32749 Fábrica: NUTRIPLAN Unidade: UN/1 F1 F4</p>	 <p>VASO PL TRECCIA RED 31 GRAFITE 20LTS Código: 36804 Fábrica: NUTRIPLAN Unidade: UN/1 F1 F4</p>	 <p>VASO PL TRECCIA RED 31 MARINHO 20LTS Código: 36805 Fábrica: NUTRIPLAN Unidade: UN/1 F1 F4</p>

31 cm
34 cm
20 lts



VASO PL TRECCIA RED 31 RUBI 20LTS

Código: 33394 Fábrica: NUTRIPLAN Unidade: UN/1 F1 F4

109 cm



VASO PL TREVO PRETO 09CM 226

Código: 40716 Fábrica: PLASMARC Unidade: UN/1 F1 F4

22 cm
25 cm
5 lts



VASO PL VB 25 PRETO 5L 525

Código: 37716 Fábrica: BIG PLAST Unidade: UN/1 F1 F4

27 cm
30 cm



VASO PL VB 30 S/BORDA 7059

Código: 37090 Fábrica: PAIOL Unidade: UN/1 F1 F4

30 cm
34 cm
13 lts



VASO PL VB 34 PRETO 13L 534

Código: 37711 Fábrica: BIG PLAST Unidade: UN/1 F1 F4

29 cm
35 cm



VASO PL VB 35 S/BORDA ARGILA 7060-1

Código: 37091 Fábrica: PAIOL Unidade: UN/1 F1 F4

40 cm
45 cm



VASO PL VB 45 S/BORDA 7061

Código: 37092 Fábrica: PAIOL Unidade: UN/1 F1 F4

17 cm
22 cm



VASO PL VIME SINT N4 CORES 8006

Código: 37216 Fábrica: PAIOL Unidade: UN/1 F1 F4

10 cm
15 cm



VASO PL VIOLETA QUAD CAFE 00140

Código: 37148 Fábrica: PAIOL Unidade: UN/1 F1 F4



VASO PL VIOLETA RED FIO ARGILA 4569-1

Código: 41753 Fábrica: PAIOL Unidade: UN/1 F1 F4

8 cm
15 cm



VASO PL VIOLETA RED MADEIRA ENVELHE 1460

Código: 37110 Fábrica: PAIOL Unidade: UN/1 F1 F4

20 cm
25 cm
7 lts



VASO PL VQ 25 QUAD PRETO 7L 583

Código: 37703 Fábrica: BIG PLAST Unidade: UN/1 F1 F4

30 cm
35 cm
20 lts



VASO PL VQ 35 QUAD PRETO 20L 586

Código: 37702 Fábrica: BIG PLAST Unidade: UN/1 F1 F4

10 cm



VASO PL 0 RED PRETO 08CM 300

Código: 40713 Fábrica: PLASMARC Unidade: UN/1 F1 F4

11 cm



VASO PL 1 QUAD PRETO 11CM 234

Código: 40712 Fábrica: PLASMARC Unidade: UN/1 F1 F4

50 cm
58 cm
90 lts



VASO PL 10 RED GIG PRETO 90LTS

Código: 39640 Fábrica: NUTRIPLAN Unidade: UN/1 F1 F4

11 cm



VASO PL 11CM C/PRATO 11CM PRETO 346
 Código: **40851** Fábrica: **JOREAL** Unidade: **UN/1**
F1 F4



VASO PL 12LTS MARFIM 6408
 Código: **41481** Fábrica: **KOZI PLAST** Unidade: **UN/1**
F1 F4

25cm
32cm
12,5Lts



VASO PL 12,5 LTS QUAD GDE PRETO 6701
 Código: **26767** Fábrica: **INPLAST** Unidade: **UN/1**
F1 F4

15 cm
17 cm
1,8 lts



VASO PL 17 PRETO 1,8L 308
 Código: **37718** Fábrica: **BIG PLAST** Unidade: **UN/1**
F1 F4

17 cm
20 cm
3,3 lts



VASO PL 20 PRETO 3,3L 316
 Código: **37717** Fábrica: **BIG PLAST** Unidade: **UN/1**
F1 F4

20 cm
24 cm
6 lts



VASO PL 24 PRETO 6L 324
 Código: **37715** Fábrica: **BIG PLAST** Unidade: **UN/1**
F1 F4

23 cm
27 cm
8,5 L



VASO PL 27 PRETO 8,5L 332
 Código: **37714** Fábrica: **BIG PLAST** Unidade: **UN/1**
F1 F4

14 cm



VASO PL 3 QUAD PRETO 14CM 129
 Código: **40711** Fábrica: **PLASMARC** Unidade: **UN/1**
F1 F4

26 cm
30 cm
11,5 lts



VASO PL 30 PRETO 11,5L 340
 Código: **37713** Fábrica: **BIG PLAST** Unidade: **UN/1**
F1 F4

30 cm
35 cm
22 lts



VASO PL 35 PRETO 22L 348
 Código: **37710** Fábrica: **BIG PLAST** Unidade: **UN/1**
F1 F4

5,5 L



VASO PL 5,5 LTS QUAD MED PTO 6700
 Código: **26762** Fábrica: **INPLAST** Unidade: **UN/1**
F1 F4

5,5 L



VASO PL 5,5 LTS QUAD MED TERRACOTA 6718
 Código: **26765** Fábrica: **INPLAST** Unidade: **UN/1**
F1 F4

5,5 L



VASO PL 5,5 LTS RED MED TERRACOTA 6712
 Código: **26764** Fábrica: **INPLAST** Unidade: **UN/1**
F1 F4



VASSOURA PELO SINTETICO M9 522 12X1
 Código: **38416** Fábrica: **N.HORIZONTE** Unidade: **DZ/12**
F1 F4



VASSOURA PIACAVAL NYLON CECI C/CB 1293
 Código: **49806** Fábrica: **CECI JOIA** Unidade: **UN/1**
F1 F4



VASSOURA PIACAVAL NYLON JOIA C/CB UN 3241
 Código: **49805** Fábrica: **CECI JOIA** Unidade: **UN/1**
F1 F4

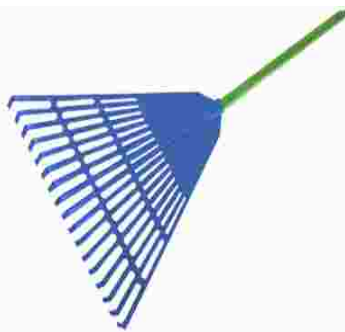

VASSOURA RASTELO PL AZUL P/GRAMA CB MAD
 Código: 32770 Fábrica: NUTRIPLAN Unidade: UN/1
 F1 F4



VASSOURA RASTELO PL P/GRAMA 46CM C/CB 80
 Código: 49807 Fábrica: EDS Unidade: UN/1
 F1 F4



VASSOURA RASTELO PL VERDE P/GRAMA CB MA
 Código: 18505 Fábrica: NUTRIPLAN Unidade: UN/1
 F1 F4



VASSOURA RASTELO PLAST P/GRAMA CB MAD
 Código: 48741 Fábrica: N.HORIZONTE Unidade: UN/1
 F1 F4

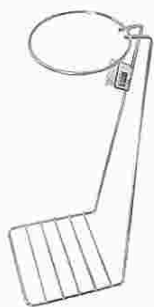

VELADOR CROM MED 18CM C/COADOR 426
 Código: 30756 Fábrica: ARAMINAS Unidade: UN/1
 F1 F4



VELADOR CROM MINI C/COADOR 15CM 722
 Código: 3490 Fábrica: ARAMINAS Unidade: UN/1
 F1 F4



VELADOR CROM 1 34CM 68
 Código: 24070 Fábrica: ARAMINAS Unidade: UN/1
 F1 F4

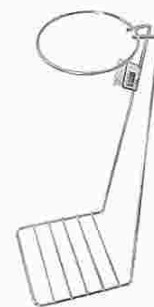

VELADOR CROM 2 GDE 48CM 69
 Código: 30922 Fábrica: ARAMINAS Unidade: UN/1
 F1 F4



VERMICULITA 1 LITRO
 Código: 48534 Fábrica: NOVATROPICAL Unidade: PT/1
 F1 F4



XICARA ACRIL CHA 180ML AZUL TIFFANY 1131
 Código: 49320 Fábrica: QUALYPLAS Unidade: UN/1
 F1 F4



XICARA VIDRO TRANSP 80ML 5CM 23339 12X1
 Código: 36748 Fábrica: MABEL Unidade: CX/12
 F1 F4



XICARAS CHA VID S/PIRES 6X1
 Código: 47420 Fábrica: BBC GLASS Unidade: CJ/1
 F1 F4