

UN: R\$ 2,73 AV: R\$ 2,73 15: R\$ 2,79
30: R\$ 2,84 45: R\$ 2,90 60: R\$ 2,96

16 cm



ABRIDOR ALUM LATA BORBOLETA 16CM 3092
Código: Fábrica: Unidade:
44736 WINCY UN/1
F1 F4

UN: R\$ 4,89 AV: R\$ 58,63 15: R\$ 59,86
30: R\$ 61,05 45: R\$ 62,27 60: R\$ 63,52



ABRIDOR COMBIN INOX LATA/GARR 1004 12X1
Código: Fábrica: Unidade:
14382 JWC DZ/12
F1 F4

UN: R\$ 3,32 AV: R\$ 3,32 15: R\$ 3,39
30: R\$ 3,46 45: R\$ 3,53 60: R\$ 3,60



ABRIDOR COMBINADO INOX LATA/GARRAFA 147
Código: Fábrica: Unidade:
44771 NICOBEM CT/1
F1 F4

UN: R\$ 2,84 AV: R\$ 2,84 15: R\$ 2,90
30: R\$ 2,96 45: R\$ 3,02 60: R\$ 3,08



ABRIDOR COMBINADO INOX LATA/GARRAFA 279
Código: Fábrica: Unidade:
44503 PLANETA CT/1
F1 F4

UN: R\$ 1,96 AV: R\$ 23,57 15: R\$ 24,06
30: R\$ 24,54 45: R\$ 25,03 60: R\$ 25,53



ABRIDOR COMBINADO LATA/GARRAFA 1001 12X1
Código: Fábrica: Unidade:
1915 JWC DZ/12
F1 F4

UN: R\$ 4,40 AV: R\$ 4,40 15: R\$ 4,49
30: R\$ 4,58 45: R\$ 4,67 60: R\$ 4,76



ABRIDOR COMBINADO+SACA ROLHA CTL 2028
Código: Fábrica: Unidade:
33288 JWC CR/1
F1 F4

UN: R\$ 2,17 AV: R\$ 26,09 15: R\$ 26,63
30: R\$ 27,16 45: R\$ 27,71 60: R\$ 28,26



ABRIDOR GARRAFA NA CX 1002 12X1
Código: Fábrica: Unidade:
13925 JWC DZ/12
F1 F4

UN: R\$ 1,46 AV: R\$ 17,51 15: R\$ 17,87
30: R\$ 18,23 45: R\$ 18,59 60: R\$ 18,97



ABRIDOR INOX GARRAFAS GARCON 280 12X1
Código: Fábrica: Unidade:
48691 PLANETA DZ/12
F1 F4

UN: R\$ 2,47 AV: R\$ 2,47 15: R\$ 2,52
30: R\$ 2,57 45: R\$ 2,62 60: R\$ 2,67



ABRIDOR INOX GARRAFAS GARCON 281 CTL
Código: Fábrica: Unidade:
48694 PLANETA CR/1
F1 F4

UN: R\$ 2,12 AV: R\$ 25,45 15: R\$ 25,98
30: R\$ 26,50 45: R\$ 27,03 60: R\$ 27,57



ABRIDOR SACA ROLHA CABO PLAST 1006 12X1
Código: Fábrica: Unidade:
2886 JWC DZ/12
F1 F4

UN: R\$ 7,24 AV: R\$ 7,24 15: R\$ 7,39
30: R\$ 7,53 45: R\$ 7,69 60: R\$ 7,84



ABRIDOR SACA ROLHA INOX MULTIUSOCTL 5385
Código: Fábrica: Unidade:
43270 MEGAGIFT UN/1
F1 F4

UN: R\$ 9,79 AV: R\$ 117,49 15: R\$ 119,94
30: R\$ 122,34 45: R\$ 124,79 60: R\$ 127,28



ABRIDOR SACA ROLHAS INOX DUPLO EST 12X1
Código: Fábrica: Unidade:
46585 HERCULES CX/12
F1 F4

UN: R\$ 1,46 AV: R\$ 1,46 15: R\$ 1,49
30: R\$ 1,52 45: R\$ 1,55 60: R\$ 1,58



ADAPTADOR PORTA FILTRO PLAST 5026 UN
Código: Fábrica: Unidade:
49399 SBRISSA UN/1
F1 F4

UN: R\$ 1,40 AV: R\$ 27,91 15: R\$ 28,49
30: R\$ 29,06 45: R\$ 29,64 60: R\$ 30,23



ADAPTADOR PORTA FILTRO PLAST 5026 20X1
Código: Fábrica: Unidade:
31283 SBRISSA PT/20
F1 F4

UN: R\$ 0,59 AV: R\$ 29,37 15: R\$ 29,98
30: R\$ 30,58 45: R\$ 31,19 60: R\$ 31,81



ADAPTADOR 1/2 TORNEI/MANG PTO AD51N 50X1
Código: Fábrica: Unidade:
40147 REBOUCAS PT/50
F1 F4

UN: R\$ 0,98 AV: R\$ 48,95 15: R\$ 49,97
30: R\$ 50,97 45: R\$ 51,99 60: R\$ 53,03



ADAPTADOR 3/4 TORNEI/MANG PTO AD52N 50X1
Código: Fábrica: Unidade:
40148 REBOUCAS PT/50
F1 F4

UN: R\$ 7,33 AV: R\$ 7,33 15: R\$ 7,49
30: R\$ 7,64 45: R\$ 7,79 60: R\$ 7,95



AFIADOR DE FACA C/VENTOSA PLAST 371

Código: Fábrica: Unidade:
48689 PLANETA UN/1
F1 F4

UN: R\$ 4,69 AV: R\$ 4,69 15: R\$ 4,79
30: R\$ 4,88 45: R\$ 4,98 60: R\$ 5,08



AGUA SANITARIA MAIS 1 LT

Código: Fábrica: Unidade:
48940 MAIS UN/1
F1 F4

UN: R\$ 0,59 AV: R\$ 2,93 15: R\$ 2,99
30: R\$ 3,05 45: R\$ 3,11 60: R\$ 3,17



AGULHA P/DESENTUPIR FOGAO CTL 2023 5X1

Código: Fábrica: Unidade:
33290 JWC CR/5
F1 F4

UN: R\$ 2,28 AV: R\$ 27,41 15: R\$ 27,98
30: R\$ 28,54 45: R\$ 29,11 60: R\$ 29,69

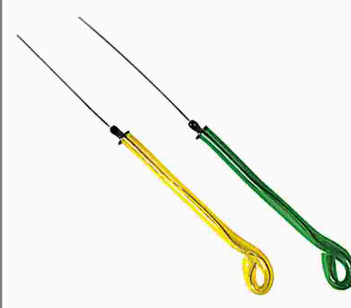

AGULHA P/DESENTUPIR FOGAO 12X1

Código: Fábrica: Unidade:
7374 ALE DZ/12
F1 F4

UN: R\$ 15,66 AV: R\$ 15,66 15: R\$ 15,98
30: R\$ 16,30 45: R\$ 16,63 60: R\$ 16,96



AMASSADOR ALUM INTEIRICO BATATA 2007 UN

Código: Fábrica: Unidade:
48030 COFAX UN/1
F1 F4

UN: R\$ 13,35 AV: R\$ 13,35 15: R\$ 13,62
30: R\$ 13,90 45: R\$ 14,18 60: R\$ 14,46



AMASSADOR INOX ALHO PRIME 061

Código: Fábrica: Unidade:
49376 RIOHOME UN/1
F1 F4

UN: R\$ 9,78 AV: R\$ 9,78 15: R\$ 9,99
30: R\$ 10,19 45: R\$ 10,39 60: R\$ 10,60

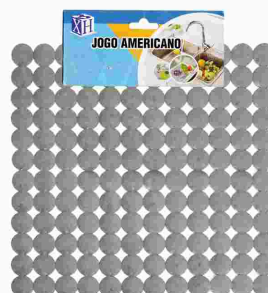

AMERICANO P/MESA 24X24CM TM-2424

Código: Fábrica: Unidade:
39280 XHADAY UN/1
F1 F4

UN: R\$ 6,12 AV: R\$ 6,12 15: R\$ 6,25
30: R\$ 6,37 45: R\$ 6,50 60: R\$ 6,63

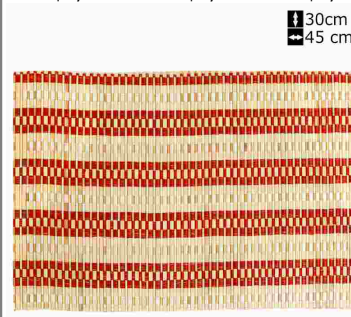

AMERICANO P/MESA 30X45CM 10221

Código: Fábrica: Unidade:
45882 ALMEGA UN/1
F1 F4

UN: R\$ 2,20 AV: R\$ 8,80 15: R\$ 8,99
30: R\$ 9,17 45: R\$ 9,35 60: R\$ 9,54



AMERICANO P/MESA 35X48CM JOGO 4PCS

Código: Fábrica: Unidade:
29116 FERREIRA PT/4
F1 F4

UN: R\$ 4,90 AV: R\$ 4,90 15: R\$ 5,00
30: R\$ 5,10 45: R\$ 5,20 60: R\$ 5,30



ARCO ALUMINIO N1 P/PLANTA 1011

Código: Fábrica: Unidade:
37169 PAIOL UN/1
F1 F4

UN: R\$ 6,46 AV: R\$ 6,46 15: R\$ 6,60
30: R\$ 6,73 45: R\$ 6,86 60: R\$ 7,00

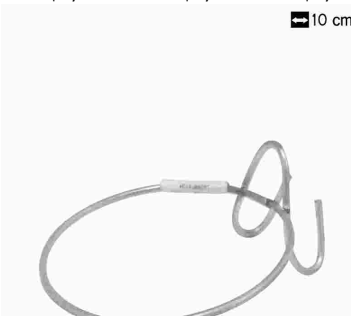

ARCO ALUMINIO N2 P/PLANTA 3000

Código: Fábrica: Unidade:
37170 PAIOL UN/1
F1 F4

UN: R\$ 8,03 AV: R\$ 8,03 15: R\$ 8,20
30: R\$ 8,36 45: R\$ 8,53 60: R\$ 8,70



ARCO ALUMINIO N3 P/PLANTA 3001

Código: Fábrica: Unidade:
37172 PAIOL UN/1
F1 F4

UN: R\$ 14,69 AV: R\$ 14,69 15: R\$ 14,99
30: R\$ 15,29 45: R\$ 15,60 60: R\$ 15,91

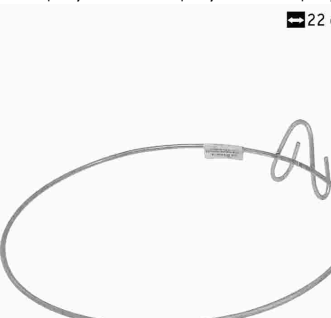

ARCO ALUMINIO N5 P/PLANTA 3003

Código: Fábrica: Unidade:
37173 PAIOL UN/1
F1 F4

UN: R\$ 5,87 AV: R\$ 5,87 15: R\$ 5,99
30: R\$ 6,11 45: R\$ 6,23 60: R\$ 6,35



ARRANJO BAMBU QUAD 6X6CM 8058

Código: Fábrica: Unidade:
40590 PAIOL UN/1
F1 F4

UN: R\$ 8,63 AV: R\$ 8,63 15: R\$ 8,81
30: R\$ 8,98 45: R\$ 9,16 60: R\$ 9,35

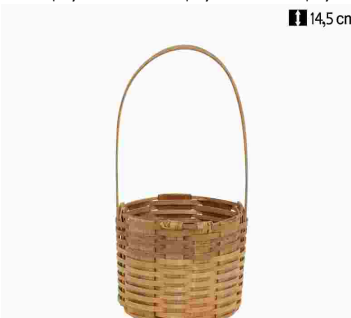

ARRANJO BAMBU RED 5X5CM 8062

Código: Fábrica: Unidade:
40591 PAIOL UN/1
F1 F4

UN: R\$ 16,64 AV: R\$ 16,64 15: R\$ 16,98
30: R\$ 17,32 45: R\$ 17,67 60: R\$ 18,02



ASSADEIRA ALUM CORACAO 01 1263

Código: Fábrica: Unidade:
37513 MSR UN/1
F1 F4

UN: R\$ 24,47 AV: R\$ 24,47 15: R\$ 24,98
30: R\$ 25,48 45: R\$ 25,99 60: R\$ 26,51



ASSADEIRA ALUM CORACAO 02 1264

Código: Fábrica: Unidade:
37254 MSR UN/1
F1 F4

UN: R\$ 40,64 AV: R\$ 40,64 15: R\$ 41,48
30: R\$ 42,31 45: R\$ 43,16 60: R\$ 44,02



ASSADEIRA ALUM CORACAO 03 1265

Código: Fábrica: Unidade:
37252 MSR UN/1
F1 F4

UN: R\$ 30,35 AV: R\$ 30,35 15: R\$ 30,98
30: R\$ 31,60 45: R\$ 32,23 60: R\$ 32,87



ASSADEIRA ALUM FUNDO FALSO 01 648

Código: Fábrica: Unidade:
35257 MSR UN/1
F1 F4

UN: R\$ 40,24 AV: R\$ 40,24 15: R\$ 41,07
30: R\$ 41,90 45: R\$ 42,73 60: R\$ 43,59



ASSADEIRA ALUM FUNDO FALSO 02 649

Código: Fábrica: Unidade:
35258 MSR UN/1
F1 F4

UN: R\$ 49,93 AV: R\$ 49,93 15: R\$ 50,97
30: R\$ 51,99 45: R\$ 53,03 60: R\$ 54,09



ASSADEIRA ALUM FUNDO FALSO 03 650

Código: Fábrica: Unidade:
37523 MSR UN/1
F1 F4

UN: R\$ 19,57 AV: R\$ 19,57 15: R\$ 19,98
30: R\$ 20,38 45: R\$ 20,79 60: R\$ 21,21



ASSADEIRA ALUM OVAL 01 651

Código: Fábrica: Unidade:
37519 MSR UN/1
F1 F4

UN: R\$ 28,59 AV: R\$ 28,59 15: R\$ 29,19
30: R\$ 29,77 45: R\$ 30,37 60: R\$ 30,97



ASSADEIRA ALUM OVAL 02 652

Código: Fábrica: Unidade:
37520 MSR UN/1
F1 F4

UN: R\$ 41,78 AV: R\$ 41,78 15: R\$ 42,65
30: R\$ 43,51 45: R\$ 44,38 60: R\$ 45,26



ASSADEIRA ALUM OVAL 03 653

Código: Fábrica: Unidade:
37521 MSR UN/1
F1 F4

UN: R\$ 107,70 AV: R\$ 107,70 15: R\$ 109,95
30: R\$ 112,14 45: R\$ 114,39 60: R\$ 116,68



ASSADEIRA VIDRO RET KIT 3UN (2,2/1,6/1L)

Código: Fábrica: Unidade:
47415 DIAMONDS CJ/1
F1 F4

UN: R\$ 24,32 AV: R\$ 24,32 15: R\$ 24,83
30: R\$ 25,33 45: R\$ 25,83 60: R\$ 26,35



AVENTAL NYLON PP 1,10X63CM PEIXEIRO 32

Código: Fábrica: Unidade:
49687 MARIO BRITO UN/1
F1 F4

UN: R\$ 6,58 AV: R\$ 6,58 15: R\$ 6,72
30: R\$ 6,85 45: R\$ 6,99 60: R\$ 7,13



AVENTAL NYLON PP 45X65CM REDONDO LISO 01

Código: Fábrica: Unidade:
49686 MARIO BRITO UN/1
F1 F4

UN: R\$ 7,96 AV: R\$ 7,96 15: R\$ 8,13
30: R\$ 8,29 45: R\$ 8,46 60: R\$ 8,62



AVENTAL NYLON 50X70CM C/BOLSO 72901

Código: Fábrica: Unidade:
49580 ALMEGA UN/1
F1 F4

UN: R\$ 15,18 AV: R\$ 15,18 15: R\$ 15,49
30: R\$ 15,80 45: R\$ 16,12 60: R\$ 16,44



AVENTAL PVC GDE 56X85CM

Código: Fábrica: Unidade:
32344 FERREIRA UN/1
F1 F4

UN: R\$ 13,70 AV: R\$ 13,70 15: R\$ 13,98
30: R\$ 14,26 45: R\$ 14,55 60: R\$ 14,84



AVENTAL PVC MED 50X75CM

Código: Fábrica: Unidade:
28178 FERREIRA UN/1
F1 F4

UN: R\$ 19,57 AV: R\$ 19,57 15: R\$ 19,98
30: R\$ 20,38 45: R\$ 20,79 60: R\$ 21,21



AVENTAL PVC 50X70CM C/BOLSO (CANGURU)

Código: Fábrica: Unidade:
44154 FERREIRA UN/1
F1 F4

UN: R\$ 24,47 AV: R\$ 24,47 15: R\$ 24,98
30: R\$ 25,48 45: R\$ 25,99 60: R\$ 26,51



BACIA ALUM LEVE 25 1,300 ML

Código: Fábrica: Unidade:
5906 AVELAR UN/1
F1 F4

UN: R\$ 14,68 AV: R\$ 14,68 15: R\$ 14,98
30: R\$ 15,28 45: R\$ 15,59 60: R\$ 15,90



BACIA N23 23 LTSCANELADA PRETO 10080
Código: Fábrica: Unidade:
41441 PLASMARC UN/1
F1 F4

UN: R\$ 6,46 AV: R\$ 6,46 15: R\$ 6,60
30: R\$ 6,73 45: R\$ 6,86 60: R\$ 7,00

8 Lts

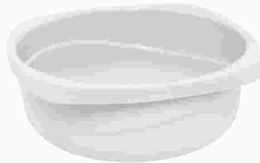

BACIA PLAST 2,3 LTS BRANCO
Código: Fábrica: Unidade:
40775 NUTRIPLAN UN/1
F1 F4

UN: R\$ 5,39 AV: R\$ 5,39 15: R\$ 5,50
30: R\$ 5,61 45: R\$ 5,72 60: R\$ 5,83



BACIA PLAST 3 LTS PRETA 2001
Código: Fábrica: Unidade:
40378 FORMPLAST UN/1
F1 F4

UN: R\$ 7,10 AV: R\$ 7,10 15: R\$ 7,25
30: R\$ 7,39 45: R\$ 7,54 60: R\$ 7,69

9cm
26cm
3,3lts



BACIA PLAST 3,3 LTS TRANSLUCIDA 0524
Código: Fábrica: Unidade:
7495 JAGUAR UN/1
F1 F4

UN: R\$ 3,99 AV: R\$ 3,99 15: R\$ 3,99
30: R\$ 3,99 45: R\$ 3,99 60: R\$ 3,99



BACIA PLAST 3,5 LTS CANELADA 387
Código: Fábrica: Unidade:
35577 BH PLASTIC UN/1
F1 F4

UN: R\$ 11,82 AV: R\$ 11,82 15: R\$ 12,07
30: R\$ 12,31 45: R\$ 12,55 60: R\$ 12,80

10cm
33cm
6,7lts



BACIA PLAST 6,7 LTS TRANSLUCIDA 0526
Código: Fábrica: Unidade:
8265 JAGUAR UN/1
F1 F4

UN: R\$ 17,38 AV: R\$ 17,38 15: R\$ 17,74
30: R\$ 18,10 45: R\$ 18,46 60: R\$ 18,83

8 Lts

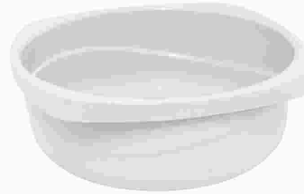

BACIA PLAST 8 LTS BRANCO
Código: Fábrica: Unidade:
40776 NUTRIPLAN UN/1
F1 F4

UN: R\$ 12,99 AV: R\$ 12,99 15: R\$ 13,26
30: R\$ 13,53 45: R\$ 13,80 60: R\$ 14,08



BACIA PLAST N18 13 LTS CANELAD PRETO 119
Código: Fábrica: Unidade:
41442 PLASMARC UN/1
F1 F4

UN: R\$ 11,53 AV: R\$ 11,53 15: R\$ 11,77
30: R\$ 12,00 45: R\$ 12,24 60: R\$ 12,49



BACIA PLAST 12 LTS CANELADA 6614
Código: Fábrica: Unidade:
8705 INPLAST UN/1
F1 F4

UN: R\$ 10,76 AV: R\$ 10,76 15: R\$ 10,99
30: R\$ 11,21 45: R\$ 11,43 60: R\$ 11,66



BACIA PLAST 12,0 LTS CANELADA
Código: Fábrica: Unidade:
30892 BH PLASTIC UN/1
F1 F4

UN: R\$ 20,16 AV: R\$ 20,16 15: R\$ 20,58
30: R\$ 20,99 45: R\$ 21,41 60: R\$ 21,84

13 lts



BACIA PLAST 13 LTS COLLOR 860
Código: Fábrica: Unidade:
39562 LUMAR UN/1
F1 F4

UN: R\$ 31,82 AV: R\$ 31,82 15: R\$ 32,49
30: R\$ 33,14 45: R\$ 33,80 60: R\$ 34,48

14 Lts

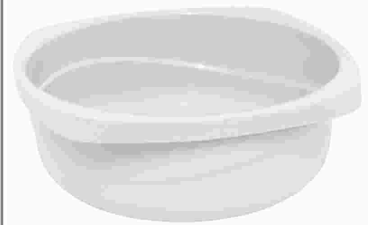

BACIA PLAST 14 LTS BRANCO
Código: Fábrica: Unidade:
40777 NUTRIPLAN UN/1
F1 F4

UN: R\$ 5,67 AV: R\$ 5,67 15: R\$ 5,79
30: R\$ 5,90 45: R\$ 6,02 60: R\$ 6,14



BACIA PLAST 1,5 LTS COLOR
Código: Fábrica: Unidade:
20585 ECOPLASTIC UN/1
F1 F4

UN: R\$ 20,55 AV: R\$ 20,55 15: R\$ 20,98
30: R\$ 21,40 45: R\$ 21,83 60: R\$ 22,27

17cm
41cm
15lts



BACIA PLAST 15 LTS TRANSLUCIDA 0528
Código: Fábrica: Unidade:
7496 JAGUAR UN/1
F1 F4

UN: R\$ 15,96 AV: R\$ 15,96 15: R\$ 16,29
30: R\$ 16,62 45: R\$ 16,95 60: R\$ 17,29

47cm
18lts



BACIA PLAST 18 LTS PRETA 105
Código: Fábrica: Unidade:
40404 FORMPLAST UN/1
F1 F4

UN: R\$ 2,39 AV: R\$ 2,39 15: R\$ 2,39
30: R\$ 2,39 45: R\$ 2,39 60: R\$ 2,39



BACIA PLAST 2 LTS CANELADA PRETA 6304
Código: Fábrica: Unidade:
41493 KOZI PLAST UN/1
F1 F4

UN: R\$ 6,81 AV: R\$ 6,81 15: R\$ 6,95
30: R\$ 7,09 45: R\$ 7,23 60: R\$ 7,37



BACIA PLAST 2,4 LTS 71493

Código: Fábrika: Unidade:
31295 Y888 UN/1
F1 F4

UN: R\$ 2,99 AV: R\$ 2,99 15: R\$ 2,99
30: R\$ 2,99 45: R\$ 2,99 60: R\$ 2,99



BACIA PLAST 3 LTS CANELADA PRETA 6305

Código: Fábrika: Unidade:
41474 KOZI PLAST UN/1
F1 F4

UN: R\$ 7,32 AV: R\$ 7,32 15: R\$ 7,48
30: R\$ 7,63 45: R\$ 7,78 60: R\$ 7,93



BACIA PLAST 3,0 LTS LISA

Código: Fábrika: Unidade:
17857 ECOPLASTIC UN/1
F1 F4

UN: R\$ 8,80 AV: R\$ 8,80 15: R\$ 8,99
30: R\$ 9,17 45: R\$ 9,35 60: R\$ 9,54

15 cm
32 cm
7 lts



BACIA PLAST 7 LTS COLOR

Código: Fábrika: Unidade:
45279 MOLDE MINAS UN/1
F1 F4

UN: R\$ 2,89 AV: R\$ 2,89 15: R\$ 2,89
30: R\$ 2,89 45: R\$ 2,89 60: R\$ 2,89



BACIA 1,2 LTS CANELADA RECICLADA 6001

Código: Fábrika: Unidade:
17981 SBRISSA UN/1
F1 F4

UN: R\$ 5,69 AV: R\$ 5,69 15: R\$ 5,81
30: R\$ 5,92 45: R\$ 6,04 60: R\$ 6,16



BACIA 2,5 LTS CANELADA RECICLADA 6002

Código: Fábrika: Unidade:
17982 SBRISSA UN/1
F1 F4

UN: R\$ 6,99 AV: R\$ 6,99 15: R\$ 6,99
30: R\$ 6,99 45: R\$ 6,99 60: R\$ 6,99



BACIA 2,5 LTS CANELADA TRANSPARENTE 4007

Código: Fábrika: Unidade:
19763 SBRISSA UN/1
F1 F4

UN: R\$ 11,00 AV: R\$ 11,00 15: R\$ 11,23
30: R\$ 11,45 45: R\$ 11,68 60: R\$ 11,91



BACIA 4,5 LTS CANELADA RECICLADA 6003

Código: Fábrika: Unidade:
17983 SBRISSA UN/1
F1 F4

UN: R\$ 11,85 AV: R\$ 11,85 15: R\$ 12,10
30: R\$ 12,34 45: R\$ 12,58 60: R\$ 12,84



BACIA 4,5 LTS CANELADA TRANSPARENTE 4008

Código: Fábrika: Unidade:
18713 SBRISSA UN/1
F1 F4

UN: R\$ 21,99 AV: R\$ 21,99 15: R\$ 21,99
30: R\$ 21,99 45: R\$ 21,99 60: R\$ 21,99



BACIAO PLAST 35 LTS CANELADA 719/92

Código: Fábrika: Unidade:
36696 LUMAR/PA UN/1
F1 F4

UN: R\$ 93,99 AV: R\$ 93,99 15: R\$ 95,95
30: R\$ 97,87 45: R\$ 99,83 60: R\$ 101,82



BALDE METAL 5 LTS DEC FLAMENGO 1893

Código: Fábrika: Unidade:
41121 BRASFOOT UN/1
F1 F4

UN: R\$ 4,99 AV: R\$ 4,99 15: R\$ 4,99
30: R\$ 4,99 45: R\$ 4,99 60: R\$ 4,99



BALDE PLAST 2,5 LTS P/PIPOCA 7008

Código: Fábrika: Unidade:
31284 SBRISSA UN/1
F1 F4

UN: R\$ 6,99 AV: R\$ 6,99 15: R\$ 6,99
30: R\$ 6,99 45: R\$ 6,99 60: R\$ 6,99



BALDE PLAST 7,5 LTS C/ALCA METAL 90

Código: Fábrika: Unidade:
36698 P A SOUZA UN/1
F1 F4

UN: R\$ 21,53 AV: R\$ 21,53 15: R\$ 21,98
30: R\$ 22,42 45: R\$ 22,87 60: R\$ 23,33



BALDE PLAST 9 LTS CINZA

Código: Fábrika: Unidade:
40778 NUTRIPLAN UN/1
F1 F4

UN: R\$ 24,47 AV: R\$ 24,47 15: R\$ 24,98
30: R\$ 25,48 45: R\$ 25,99 60: R\$ 26,51



BALDE PLAST LATA CONCRETO 16 LTS PRETA

Código: Fábrika: Unidade:
20661 ECOPLASTIC UN/1
F1 F4

UN: R\$ 11,99 AV: R\$ 11,99 15: R\$ 11,99
30: R\$ 11,99 45: R\$ 11,99 60: R\$ 11,99



BALDE PLAST 12 LTS ELEGANCE PRETO 413

Código: Fábrika: Unidade:
50005 PLASMARC UN/1
F1 F4

UN: R\$ 10,99 AV: R\$ 10,99 15: R\$ 10,99
30: R\$ 10,99 45: R\$ 10,99 60: R\$ 10,99



BALDE PLAST 12 LTS PRETO P/CONCRETO 105
Código: Fábrika: Unidade:
40719 ECOPLASTIC UN/1
F1 F4

UN: R\$ 3,91 AV: R\$ 3,91 15: R\$ 3,99
30: R\$ 4,07 45: R\$ 4,15 60: R\$ 4,23



BALDE PLAST 1,2LTS PIPOCA COLOR ADE 3105
Código: Fábrika: Unidade:
50088 LIDER PLUS UN/1
F1 F4

UN: R\$ 2,93 AV: R\$ 2,93 15: R\$ 2,99
30: R\$ 3,05 45: R\$ 3,11 60: R\$ 3,17



BALDE PLAST 1,2LTS PIPOCA COLOR 3104
Código: Fábrika: Unidade:
41785 LIDER PLUS UN/1
F1 F4

UN: R\$ 13,85 AV: R\$ 13,85 15: R\$ 14,13
30: R\$ 14,42 45: R\$ 14,71 60: R\$ 15,00



BALDE PLAST 13 LTS ALCA METAL 6615
Código: Fábrika: Unidade:
14402 INPLAST UN/1
F1 F4

UN: R\$ 13,70 AV: R\$ 13,70 15: R\$ 13,98
30: R\$ 14,26 45: R\$ 14,55 60: R\$ 14,84



BALDE PLAST 13 LTS OVAL ALCA PLAST 102
Código: Fábrika: Unidade:
40717 PLASMARC UN/1
F1 F4

UN: R\$ 11,49 AV: R\$ 11,49 15: R\$ 11,49
30: R\$ 11,49 45: R\$ 11,49 60: R\$ 11,49



BALDE PLAST 15 LTS PRETO ALCA METAL
Código: Fábrika: Unidade:
17810 SHANGRILA UN/1
F1 F4

1 28cm
2 32cm
3 15lts

UN: R\$ 15,89 AV: R\$ 15,89 15: R\$ 16,22
30: R\$ 16,55 45: R\$ 16,88 60: R\$ 17,22



BALDE PLAST 15 LTS 753
Código: Fábrika: Unidade:
37263 LUMAR UN/1
F1 F4

UN: R\$ 21,35 AV: R\$ 21,35 15: R\$ 21,79
30: R\$ 22,23 45: R\$ 22,67 60: R\$ 23,13



BALDE PLAST 20 LTS 720
Código: Fábrika: Unidade:
37262 LUMAR UN/1
F1 F4

UN: R\$ 2,83 AV: R\$ 2,83 15: R\$ 2,89
30: R\$ 2,95 45: R\$ 3,01 60: R\$ 3,07

1 13 cm



BALDINHO PLAST P/PIPOCA 1065
Código: Fábrika: Unidade:
37802 ENGIPLAST UN/1
F1 F4

UN: R\$ 3,81 AV: R\$ 3,81 15: R\$ 3,89
30: R\$ 3,97 45: R\$ 4,05 60: R\$ 4,13

1 07 cm
2 21 cm
3 34 cm
4 02 lts



BANDEJA 15 CELULAS BAIXA 5 F PRETO 2134
Código: Fábrika: Unidade:
33544 NUTRIPLAN UN/1
F1 F4

UN: R\$ 8,80 AV: R\$ 8,80 15: R\$ 8,99
30: R\$ 9,17 45: R\$ 9,35 60: R\$ 9,54

1 09 cm
2 30 cm
3 36 cm
4 03 lts



BANDEJA 30 CELULAS PRETO
Código: Fábrika: Unidade:
33545 NUTRIPLAN UN/1
F1 F4

UN: R\$ 24,47 AV: R\$ 24,47 15: R\$ 24,98
30: R\$ 25,48 45: R\$ 25,99 60: R\$ 26,51



BANDEJA BAMBU 39X15X1,2CM 114
Código: Fábrika: Unidade:
47904 CASITA UN/1
F1 F4

UN: R\$ 27,41 AV: R\$ 27,41 15: R\$ 27,98
30: R\$ 28,54 45: R\$ 29,11 60: R\$ 29,69

1 4,5 cm
2 30 cm

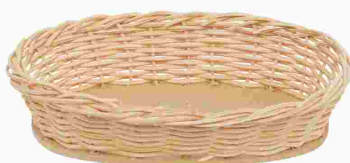

BANDEJA CIPO BRANCO OVAL GDE 8102
Código: Fábrika: Unidade:
40599 PAIOL UN/1
F1 F4

UN: R\$ 58,74 AV: R\$ 58,74 15: R\$ 59,97
30: R\$ 61,17 45: R\$ 62,39 60: R\$ 63,64

1 4,5 cm
2 23,5 cm



BANDEJA CIPO BRANCO OVAL PQ 8106
Código: Fábrika: Unidade:
40595 PAIOL UN/1
F1 F4

UN: R\$ 27,41 AV: R\$ 27,41 15: R\$ 27,98
30: R\$ 28,54 45: R\$ 29,11 60: R\$ 29,69

1 5 cm
2 22 cm



BANDEJA CIPO BRANCO RED GDE 8101
Código: Fábrika: Unidade:
40602 PAIOL UN/1
F1 F4

UN: R\$ 58,74 AV: R\$ 58,74 15: R\$ 59,97
30: R\$ 61,17 45: R\$ 62,39 60: R\$ 63,64

1 2,5 cm
2 21,5 cm

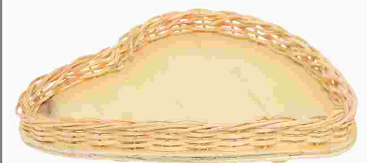

BANDEJA CORCAO CIPO BRANCO N4 8114
Código: Fábrika: Unidade:
40606 PAIOL UN/1
F1 F4

UN: R\$ 52,87 AV: R\$ 52,87 15: R\$ 53,97
 30: R\$ 55,05 45: R\$ 56,15 60: R\$ 57,27





BANDEJA CORACAO CIPO BRANCO N5 8115
 Código: Fábrica: Unidade:
40607 PAIOL UN/1
 F1 F4

UN: R\$ 29,37 AV: R\$ 29,37 15: R\$ 29,98
 30: R\$ 30,58 45: R\$ 31,19 60: R\$ 31,81





BANDEJA CORACAO FIO GDE BANANA 6999-2
 Código: Fábrica: Unidade:
39450 PAIOL UN/1
 F1 F4

UN: R\$ 32,30 AV: R\$ 32,30 15: R\$ 32,98
 30: R\$ 33,64 45: R\$ 34,31 60: R\$ 35,00





BANDEJA CORACAO FIO MED ARGILA 7000-1
 Código: Fábrica: Unidade:
37206 PAIOL UN/1
 F1 F4

UN: R\$ 32,30 AV: R\$ 32,30 15: R\$ 32,98
 30: R\$ 33,64 45: R\$ 34,31 60: R\$ 35,00





BANDEJA CORACAO FIO MED BANANA 7000-2
 Código: Fábrica: Unidade:
39451 PAIOL UN/1
 F1 F4

UN: R\$ 28,39 AV: R\$ 28,39 15: R\$ 28,98
 30: R\$ 29,56 45: R\$ 30,15 60: R\$ 30,75



BANDEJA CORACAO FIO PEQ ARGILA 7001-1
 Código: Fábrica: Unidade:
37207 PAIOL UN/1
 F1 F4

UN: R\$ 28,39 AV: R\$ 28,39 15: R\$ 28,98
 30: R\$ 29,56 45: R\$ 30,15 60: R\$ 30,75



BANDEJA CORACAO FIO PEQ BANANA 7001-2
 Código: Fábrica: Unidade:
39452 PAIOL UN/1
 F1 F4

UN: R\$ 32,30 AV: R\$ 32,30 15: R\$ 32,98
 30: R\$ 33,64 45: R\$ 34,31 60: R\$ 35,00



BANDEJA CORACAO PINUS ENVELHEC GDE 3103
 Código: Fábrica: Unidade:
41749 PAIOL UN/1
 F1 F4

UN: R\$ 26,43 AV: R\$ 26,43 15: R\$ 26,98
 30: R\$ 27,52 45: R\$ 28,07 60: R\$ 28,63



BANDEJA CORACAO PINUS ENVELHEC MED 3104
 Código: Fábrica: Unidade:
40845 PAIOL UN/1
 F1 F4

UN: R\$ 21,17 AV: R\$ 21,17 15: R\$ 21,61
 30: R\$ 22,04 45: R\$ 22,48 60: R\$ 22,93



BANDEJA CORACAO PINUS ENVELHEC PEQ 3105
 Código: Fábrica: Unidade:
41750 PAIOL UN/1
 F1 F4

UN: R\$ 38,11 AV: R\$ 38,11 15: R\$ 38,90
 30: R\$ 39,68 45: R\$ 40,48 60: R\$ 41,29





BANDEJA FIO GDE 8013
 Código: Fábrica: Unidade:
37196 PAIOL UN/1
 F1 F4

UN: R\$ 34,76 AV: R\$ 34,76 15: R\$ 35,49
 30: R\$ 36,20 45: R\$ 36,92 60: R\$ 37,66





BANDEJA FIO MED 8014
 Código: Fábrica: Unidade:
37197 PAIOL UN/1
 F1 F4

UN: R\$ 27,14 AV: R\$ 27,14 15: R\$ 27,71
 30: R\$ 28,26 45: R\$ 28,83 60: R\$ 29,40





BANDEJA FIO PEQ 8015
 Código: Fábrica: Unidade:
37198 PAIOL UN/1
 F1 F4

UN: R\$ 45,03 AV: R\$ 45,03 15: R\$ 45,97
 30: R\$ 46,89 45: R\$ 47,83 60: R\$ 48,79





BANDEJA FITA GDE 8010
 Código: Fábrica: Unidade:
37193 PAIOL UN/1
 F1 F4

UN: R\$ 11,75 AV: R\$ 11,75 15: R\$ 12,00
 30: R\$ 12,24 45: R\$ 12,48 60: R\$ 12,73





BANDEJA INOX OVAL 22CM 800-17
 Código: Fábrica: Unidade:
40529 CASA ONZE UN/1
 F1 F4

UN: R\$ 13,71 AV: R\$ 13,71 15: R\$ 13,99
 30: R\$ 14,27 45: R\$ 14,56 60: R\$ 14,85



BANDEJA INOX OVAL 25CM 800-18
 Código: Fábrica: Unidade:
40532 CASA ONZE UN/1
 F1 F4

UN: R\$ 45,63 AV: R\$ 45,63 15: R\$ 46,58
 30: R\$ 47,51 45: R\$ 48,46 60: R\$ 49,43



BANDEJA INOX RED EMBORRACHAD 35CM 180205
 Código: Fábrica: Unidade:
39227 SATYAM UN/1
 F1 F4

UN: R\$ 57,58 AV: R\$ 57,58 15: R\$ 58,78
30: R\$ 59,95 45: R\$ 61,15 60: R\$ 62,37

40 cm



BANDEJA INOX RED EMBORRACHAD 40CM 180206

Código: Fábrica: Unidade:
39228 SATYAM UN/1
F1 F4

UN: R\$ 34,26 AV: R\$ 34,26 15: R\$ 34,98
30: R\$ 35,68 45: R\$ 36,39 60: R\$ 37,12

17 cm
40 cm



BANDEJA PINUS GDE 8016

Código: Fábrica: Unidade:
37199 PAIOL UN/1
F1 F4

UN: R\$ 36,22 AV: R\$ 36,22 15: R\$ 36,98
30: R\$ 37,71 45: R\$ 38,47 60: R\$ 39,24

10 cm
35 cm



BANDEJA PINUS MED 8017

Código: Fábrica: Unidade:
37200 PAIOL UN/1
F1 F4

UN: R\$ 32,30 AV: R\$ 32,30 15: R\$ 32,98
30: R\$ 33,64 45: R\$ 34,31 60: R\$ 35,00

9,5 cm
28 cm



BANDEJA PINUS PEQ 8018

Código: Fábrica: Unidade:
37201 PAIOL UN/1
F1 F4

UN: R\$ 3,48 AV: R\$ 3,48 15: R\$ 3,55
30: R\$ 3,62 45: R\$ 3,69 60: R\$ 3,77

5,5 cm
30 cm
18 cm



BANDEJA PLAST MULTI USO 1,5L 17X31CM 731

Código: Fábrica: Unidade:
44083 QUALYPLAS UN/1
F1 F4

UN: R\$ 51,90 AV: R\$ 51,90 15: R\$ 52,98
30: R\$ 54,04 45: R\$ 55,12 60: R\$ 56,22

65 cm

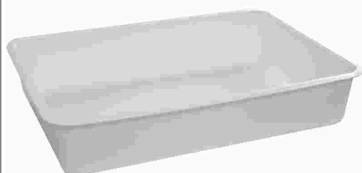

BANDEJA PLAST N5 BCA 26LTS 584

Código: Fábrica: Unidade:
37781 TRITEC UN/1
F1 F4

UN: R\$ 19,57 AV: R\$ 19,57 15: R\$ 19,98
30: R\$ 20,38 45: R\$ 20,79 60: R\$ 21,21

44cm
32cm



BANDEJA PLAST 32,5X43,5CM MULTI USO 1562

Código: Fábrica: Unidade:
47063 JAGUAR UN/1
F1 F4

UN: R\$ 35,25 AV: R\$ 35,25 15: R\$ 35,99
30: R\$ 36,71 45: R\$ 37,44 60: R\$ 38,19

9,5 cm
26 cm

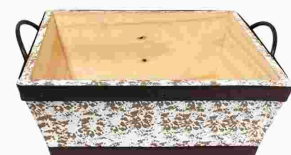

BANDEJA TEXTURA PEQ 8009

Código: Fábrica: Unidade:
37192 PAIOL UN/1
F1 F4

UN: R\$ 5,14 AV: R\$ 5,14 15: R\$ 5,25
30: R\$ 5,35 45: R\$ 5,46 60: R\$ 5,57



BANDEJA 128 CELULAS FINA PRETO

Código: Fábrica: Unidade:
38916 NUTRIPLAN UN/1
F1 F4

UN: R\$ 4,89 AV: R\$ 4,89 15: R\$ 4,99
30: R\$ 5,09 45: R\$ 5,19 60: R\$ 5,29

04 cm
27 cm
53 cm
2,5 lts



BANDEJA 200 CELULAS F08 FINA PRETO

Código: Fábrica: Unidade:
33543 NUTRIPLAN UN/1
F1 F4

UN: R\$ 58,74 AV: R\$ 58,74 15: R\$ 59,97
30: R\$ 61,17 45: R\$ 62,39 60: R\$ 63,64

80cm
23lts



BANHEIRA INF TRANSP 23 LTS ROSA 7741

Código: Fábrica: Unidade:
6191 JAGUAR UN/1
F1 F4

UN: R\$ 25,45 AV: R\$ 25,45 15: R\$ 25,98
30: R\$ 26,50 45: R\$ 27,03 60: R\$ 27,57



BANQUETA ARAXA BRANCA

Código: Fábrica: Unidade:
21134 ANTARES UN/1
F1 F4

UN: R\$ 23,49 AV: R\$ 23,49 15: R\$ 23,98
30: R\$ 24,46 45: R\$ 24,95 60: R\$ 25,45



BANQUETA ARAXA PRETA

Código: Fábrica: Unidade:
25105 ANTARES UN/1
F1 F4

UN: R\$ 20,06 AV: R\$ 20,06 15: R\$ 20,48
30: R\$ 20,89 45: R\$ 21,31 60: R\$ 21,74



BANQUETA PLAST CARIBE PRETA 944

Código: Fábrica: Unidade:
42760 LUMAR UN/1
F1 F4

UN: R\$ 20,56 AV: R\$ 20,56 15: R\$ 20,99
30: R\$ 21,41 45: R\$ 21,84 60: R\$ 22,28



BANQUETA PLAST PRETA 8000

Código: Fábrica: Unidade:
40410 FORMPLAST UN/1
F1 F4

UN: R\$ 61,68 AV: R\$ 61,68 15: R\$ 62,96
30: R\$ 64,22 45: R\$ 65,51 60: R\$ 66,82

24,5 cm
40 cm
31,5 cm



BAU SINTETICO N3 40X30X24CM 8079

Código: Fábrica: Unidade:
40332 PAIOL UN/1
F1 F4

UN: R\$ 27,41 AV: R\$ 27,41 15: R\$ 27,98
30: R\$ 28,54 45: R\$ 29,11 60: R\$ 29,69



BEBEDOIRO AMARELO P/BEIJA FLOR 280ML
Código: 27121 Fábrica: NUTRIPLAN Unidade: UN/1 F1 F4

UN: R\$ 27,41 AV: R\$ 27,41 15: R\$ 27,98
30: R\$ 28,54 45: R\$ 29,11 60: R\$ 29,69



BEBEDOIRO LARANJA P/BEIJA FLOR 280ML
Código: 18504 Fábrica: NUTRIPLAN Unidade: UN/1 F1 F4

UN: R\$ 9,99 AV: R\$ 9,99 15: R\$ 9,99
30: R\$ 9,99 45: R\$ 9,99 60: R\$ 9,99



BICO ADAPTADOR AJUST P/TORNEIRA CTL 5364
Código: 43272 Fábrica: MEGAGIFT Unidade: CT/1 F1 F4

UN: R\$ 41,12 AV: R\$ 41,12 15: R\$ 41,97
30: R\$ 42,81 45: R\$ 43,67 60: R\$ 44,54



BICO AREJADOR P/TORNEIRA 1021 12X1
Código: 50826 Fábrica: JWC Unidade: DZ/1 F1 F4

UN: R\$ 6,49 AV: R\$ 6,49 15: R\$ 6,49
30: R\$ 6,49 45: R\$ 6,49 60: R\$ 6,49



BICO AREJADOR P/TORNEIRA 23453
Código: 45881 Fábrica: ALMEGA Unidade: UN/1 F1 F4

UN: R\$ 3,26 AV: R\$ 3,26 15: R\$ 3,33
30: R\$ 3,40 45: R\$ 3,46 60: R\$ 3,53



BICO CONEXAO P/TORNEIRA C/ANEL VEDA 390
Código: 49739 Fábrica: NOVA MARCA Unidade: UN/1 F1 F4

UN: R\$ 23,49 AV: R\$ 23,49 15: R\$ 23,98
30: R\$ 24,46 45: R\$ 24,95 60: R\$ 25,45



BICO METAL MANGUEIRA 10CM CTL 37-20
Código: 44774 Fábrica: NICOBEM Unidade: UN/1 F1 F4

UN: R\$ 4,20 AV: R\$ 4,20 15: R\$ 4,29
30: R\$ 4,37 45: R\$ 4,46 60: R\$ 4,55



BICO PLAST REGADOR PRETO 9754
Código: 50963 Fábrica: ARBRA Unidade: UN/1 F1 F4

UN: R\$ 1,08 AV: R\$ 12,97 15: R\$ 13,24
30: R\$ 13,51 45: R\$ 13,78 60: R\$ 14,06



BICO P/TORNEIRA JARDIM B151N 12X1
Código: 33737 Fábrica: REBOUCAS Unidade: PT/12 F1 F4

UN: R\$ 1,25 AV: R\$ 14,98 15: R\$ 15,29
30: R\$ 15,60 45: R\$ 15,91 60: R\$ 16,23



BICO P/TORNEIRA TANQUE PIA B152N 12X1
Código: 33736 Fábrica: REBOUCAS Unidade: PT/12 F1 F4

UN: R\$ 3,81 AV: R\$ 3,81 15: R\$ 3,89
30: R\$ 3,97 45: R\$ 4,05 60: R\$ 4,13



BISNAGA PLAST 200 ML KATCHUP 394
Código: 36229 Fábrica: TRITEC Unidade: UN/1 F1 F4

UN: R\$ 3,81 AV: R\$ 3,81 15: R\$ 3,89
30: R\$ 3,97 45: R\$ 4,05 60: R\$ 4,13



BISNAGA PLAST 200 ML MAIONESE 396
Código: 35945 Fábrica: TRITEC Unidade: UN/1 F1 F4

UN: R\$ 3,81 AV: R\$ 3,81 15: R\$ 3,89
30: R\$ 3,97 45: R\$ 4,05 60: R\$ 4,13



BISNAGA PLAST 200 ML MOSTARDA 395
Código: 36230 Fábrica: TRITEC Unidade: UN/1 F1 F4

UN: R\$ 2,93 AV: R\$ 2,93 15: R\$ 2,99
30: R\$ 3,05 45: R\$ 3,11 60: R\$ 3,17



BISNAGA PLAST 250 ML KATCHUP 106/422
Código: 44080 Fábrica: QUALYPLAS Unidade: UN/1 F1 F4

UN: R\$ 2,93 AV: R\$ 2,93 15: R\$ 2,99
30: R\$ 3,05 45: R\$ 3,11 60: R\$ 3,17



BISNAGA PLAST 250 ML MAIONESE 421/105
Código: 44079 Fábrica: QUALYPLAS Unidade: UN/1 F1 F4

UN: R\$ 2,93 AV: R\$ 2,93 15: R\$ 2,99
30: R\$ 3,05 45: R\$ 3,11 60: R\$ 3,17

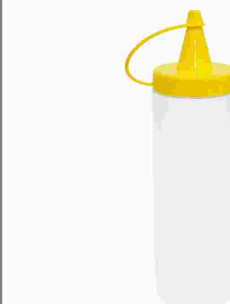

BISNAGA PLAST 250 ML MOSTARDA 104/420
Código: 44081 Fábrica: QUALYPLAS Unidade: UN/1 F1 F4

UN: R\$ 12,72 AV: R\$ 12,72 15: R\$ 12,98
30: R\$ 13,24 45: R\$ 13,51 60: R\$ 13,78



BOLEIRA PLAST 26,5X25X10,5CM FACILIT 450
Código: Fábrica: Unidade:
45189 RISCHIOTO UN/1
F1 F4

UN: R\$ 110,01 AV: R\$ 110,01 15: R\$ 112,31
30: R\$ 114,55 45: R\$ 116,84 60: R\$ 119,18



BOLSA TERMICA POLIESTER 24X22X14CM 0066
Código: Fábrica: Unidade:
43685 MORMAII UN/1
F1 F4

UN: R\$ 110,01 AV: R\$ 110,01 15: R\$ 112,31
30: R\$ 114,55 45: R\$ 116,84 60: R\$ 119,18



BOLSA TERMICA POLIESTER 24X22X14CM 0069
Código: Fábrica: Unidade:
43680 MORMAII UN/1
F1 F4

UN: R\$ 68,53 AV: R\$ 68,53 15: R\$ 69,96
30: R\$ 71,36 45: R\$ 72,79 60: R\$ 74,24



BOLSA TERMICA RET 9 LTS
Código: Fábrica: Unidade:
30864 ANTARES UN/1
F1 F4

UN: R\$ 84,20 AV: R\$ 84,20 15: R\$ 85,96
30: R\$ 87,67 45: R\$ 89,43 60: R\$ 91,22



BOLSA TERMICA RET 12 LTS TIRA COLO
Código: Fábrica: Unidade:
30868 ANTARES UN/1
F1 F4

UN: R\$ 97,91 AV: R\$ 97,91 15: R\$ 99,95
30: R\$ 101,95 45: R\$ 103,99 60: R\$ 106,07



BOLSA TERMICA RET 15 LTS
Código: Fábrica: Unidade:
30865 ANTARES UN/1
F1 F4

UN: R\$ 18,39 AV: R\$ 18,39 15: R\$ 18,77
30: R\$ 19,15 45: R\$ 19,53 60: R\$ 19,92



BOMBA MANUAL P/GALAO DE AGUA 16,5CM 861
Código: Fábrica: Unidade:
26874 HAI BRASIL UN/1
F1 F4

UN: R\$ 8,80 AV: R\$ 8,80 15: R\$ 8,99
30: R\$ 9,17 45: R\$ 9,35 60: R\$ 9,54



BOMBONIERE PLAST 10X11CM 15082
Código: Fábrica: Unidade:
46247 CASITA CX/1
F1 F4

UN: R\$ 16,64 AV: R\$ 16,64 15: R\$ 16,98
30: R\$ 17,32 45: R\$ 17,67 60: R\$ 18,02



BOMBONIERE VIDRO GDE 750
Código: Fábrica: Unidade:
47361 ALTHOME UN/1
F1 F4

UN: R\$ 22,51 AV: R\$ 22,51 15: R\$ 22,98
30: R\$ 23,44 45: R\$ 23,91 60: R\$ 24,39



BOMBONIERE VIDRO 290ML RED 13CM EGITO
Código: Fábrica: Unidade:
44781 CITY GLASS CX/1
F1 F4

UN: R\$ 0,95 AV: R\$ 1,91 15: R\$ 1,95
30: R\$ 1,99 45: R\$ 2,03 60: R\$ 2,07



BORDA P/PRATELEIRA 1M X 6CM 2 2X1 1102
Código: Fábrica: Unidade:
11328 PLAST-LEO C//2
F1 F4

UN: R\$ 3,26 AV: R\$ 39,16 15: R\$ 39,97
30: R\$ 40,77 45: R\$ 41,59 60: R\$ 42,42

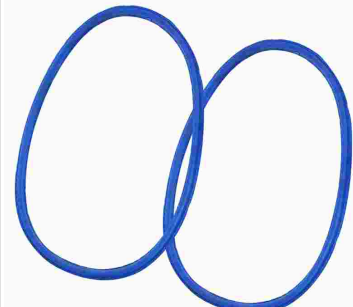

BORRACHA P PRESSAO SILIC 4,5 LTS 12X1
Código: Fábrica: Unidade:
28808 ALPHA DZ/12
F1 F4

UN: R\$ 3,67 AV: R\$ 44,05 15: R\$ 44,97
30: R\$ 45,87 45: R\$ 46,79 60: R\$ 47,72

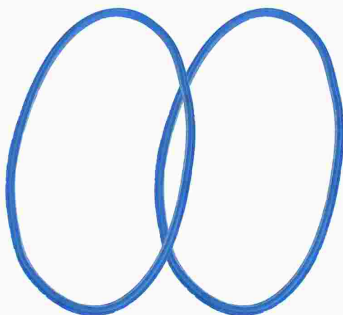

BORRACHA P PRESSAO SILIC 7,0 LTS 12X1
Código: Fábrica: Unidade:
29925 ALPHA DZ/12
F1 F4

UN: R\$ 2,03 AV: R\$ 24,32 15: R\$ 24,83
30: R\$ 25,33 45: R\$ 25,83 60: R\$ 26,35

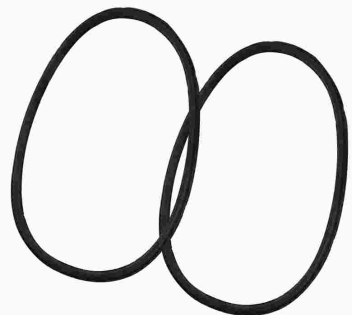

BORRACHA P PRESSAO 4,5 LTS PRETA 12X1
Código: Fábrica: Unidade:
37725 ALPHA DZ/12
F1 F4

UN: R\$ 2,45 AV: R\$ 29,38 15: R\$ 29,99
30: R\$ 30,59 45: R\$ 31,20 60: R\$ 31,82

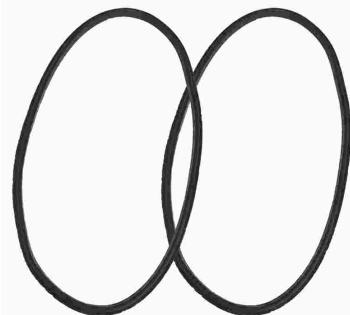

BORRACHA P PRESSAO 7,0 LTS PRETA 12X1
Código: Fábrica: Unidade:
37783 ALPHA DZ/12
F1 F4

UN: R\$ 18,26 AV: R\$ 18,26 15: R\$ 18,64
30: R\$ 19,02 45: R\$ 19,40 60: R\$ 19,78

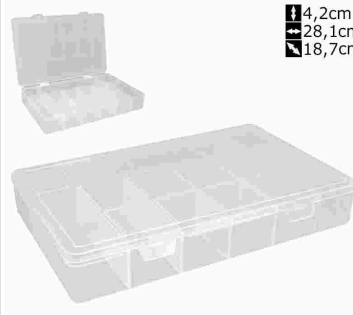

BOX ORGANIZADOR PLAST G C/13 DIV 490
Código: Fábrica: Unidade:
44432 USUAL UN/1
F1 F4

4,2cm
28,1cm
18,7cm

UN: R\$ 6,16 AV: R\$ 6,16 15: R\$ 6,29
30: R\$ 6,41 45: R\$ 6,54 60: R\$ 6,67

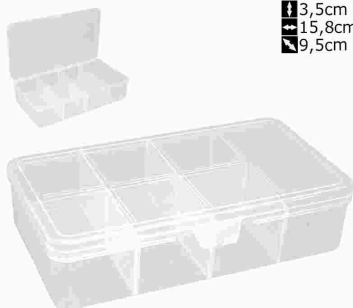

BOX ORGANIZADOR PLAST P C/7 DIV 488

Código: 44431 Fábrica: USUAL Unidade: UN/1
F1 F4

13,5cm
15,8cm
9,5cm

UN: R\$ 30,67 AV: R\$ 30,67 15: R\$ 31,31
30: R\$ 31,93 45: R\$ 32,57 60: R\$ 33,22



BOX PRATIC RATTAN TENDENCIAS GDE 2010

Código: 38375 Fábrica: MONTE LIBANO Unidade: UN/1
F1 F4

14,5 cm
37 cm

UN: R\$ 19,51 AV: R\$ 19,51 15: R\$ 19,91
30: R\$ 20,31 45: R\$ 20,72 60: R\$ 21,13



BOX PRATIC RATTAN TENDENCIAS MED 2005

Código: 38374 Fábrica: MONTE LIBANO Unidade: UN/1
F1 F4

13 cm
29,5 cm

UN: R\$ 14,35 AV: R\$ 14,35 15: R\$ 14,64
30: R\$ 14,94 45: R\$ 15,24 60: R\$ 15,54

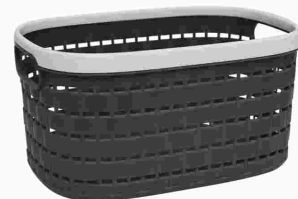

BOX PRATIC RATTAN TENDENCIAS PEQ 2000

Código: 38373 Fábrica: MONTE LIBANO Unidade: UN/1
F1 F4

12 cm
24 cm

UN: R\$ 58,74 AV: R\$ 58,74 15: R\$ 59,97
30: R\$ 61,17 45: R\$ 62,39 60: R\$ 63,64



BULE ALUM CB BAQUELITE 02 654

Código: 35270 Fábrica: MSR Unidade: UN/1
F1 F4

UN: R\$ 63,64 AV: R\$ 63,64 15: R\$ 64,96
30: R\$ 66,26 45: R\$ 67,59 60: R\$ 68,94



BULE ALUM CRAQUEADO CB BAQUELITE 655

Código: 35262 Fábrica: MSR Unidade: UN/1
F1 F4

UN: R\$ 2,60 AV: R\$ 7,81 15: R\$ 7,98
30: R\$ 8,14 45: R\$ 8,30 60: R\$ 8,47

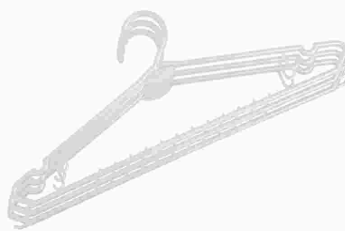

CABIDE ACRIL AD BRANCO 003 3X1

Código: 45751 Fábrica: DCASA Unidade: CJ/3
F1 F4

UN: R\$ 1,96 AV: R\$ 5,87 15: R\$ 5,99
30: R\$ 6,11 45: R\$ 6,23 60: R\$ 6,35

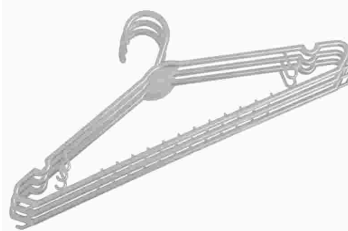

CABIDE ACRIL AD CINZA 002 3X1

Código: 45762 Fábrica: DCASA Unidade: CJ/3
F1 F4

UN: R\$ 2,60 AV: R\$ 7,81 15: R\$ 7,98
30: R\$ 8,14 45: R\$ 8,30 60: R\$ 8,47



CABIDE ACRIL AD COBRE 008 3X1

Código: 45753 Fábrica: DCASA Unidade: CJ/3
F1 F4

UN: R\$ 2,60 AV: R\$ 7,81 15: R\$ 7,98
30: R\$ 8,14 45: R\$ 8,30 60: R\$ 8,47

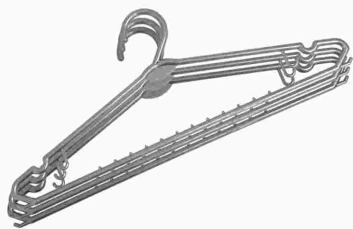

CABIDE ACRIL AD PLATINA 009 3X1

Código: 45752 Fábrica: DCASA Unidade: CJ/3
F1 F4

UN: R\$ 2,93 AV: R\$ 8,80 15: R\$ 8,99
30: R\$ 9,17 45: R\$ 9,35 60: R\$ 9,54



CABIDE ACRIL AD VINTAGE BRANCO 102 3X1

Código: 45754 Fábrica: DCASA Unidade: CJ/3
F1 F4

UN: R\$ 2,77 AV: R\$ 8,31 15: R\$ 8,49
30: R\$ 8,66 45: R\$ 8,83 60: R\$ 9,01



CABIDE ACRIL AD VINTAGE CINZA 110 3X1

Código: 45759 Fábrica: DCASA Unidade: CJ/3
F1 F4

UN: R\$ 2,93 AV: R\$ 8,80 15: R\$ 8,99
30: R\$ 9,17 45: R\$ 9,35 60: R\$ 9,54

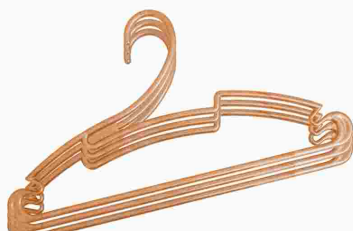

CABIDE ACRIL AD VINTAGE COBRE 103 3X1

Código: 45756 Fábrica: DCASA Unidade: CJ/3
F1 F4

UN: R\$ 2,93 AV: R\$ 8,80 15: R\$ 8,99
30: R\$ 9,17 45: R\$ 9,35 60: R\$ 9,54

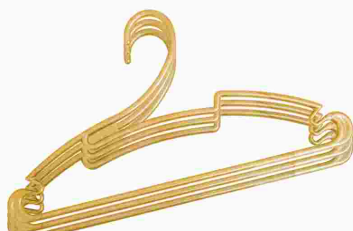

CABIDE ACRIL AD VINTAGE OURO 105 3X1

Código: 45758 Fábrica: DCASA Unidade: CJ/3
F1 F4

UN: R\$ 2,93 AV: R\$ 8,80 15: R\$ 8,99
30: R\$ 9,17 45: R\$ 9,35 60: R\$ 9,54

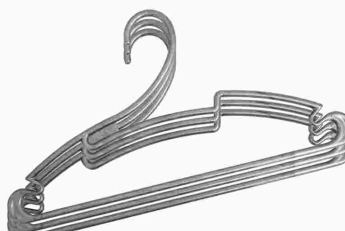

CABIDE ACRIL AD VINTAGE PLATINA 104 3X1

Código: 45757 Fábrica: DCASA Unidade: CJ/3
F1 F4

UN: R\$ 2,93 AV: R\$ 8,80 15: R\$ 8,99
30: R\$ 9,17 45: R\$ 9,35 60: R\$ 9,54

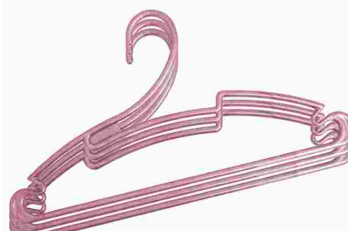

CABIDE ACRIL AD VINTAGE ROSE GOLD112 3X1

Código: 45760 Fábrica: DCASA Unidade: CJ/3
F1 F4

UN: R\$ 1,96 AV: R\$ 5,87 15: R\$ 5,99
30: R\$ 6,11 45: R\$ 6,23 60: R\$ 6,35

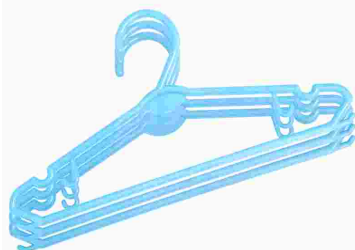

CABIDE ACRIL INF AZUL 200 3X1

Código: Fábrika: Unidade:
45749 DCASA CJ/3
F1 F4

UN: R\$ 1,96 AV: R\$ 5,87 15: R\$ 5,99
30: R\$ 6,11 45: R\$ 6,23 60: R\$ 6,35



CABIDE ACRIL INF BRANCO 400 3X1

Código: Fábrika: Unidade:
45748 DCASA CJ/3
F1 F4

UN: R\$ 1,96 AV: R\$ 5,87 15: R\$ 5,99
30: R\$ 6,11 45: R\$ 6,23 60: R\$ 6,35

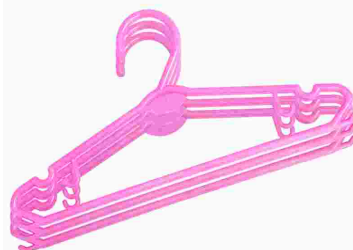

CABIDE ACRIL INF ROSA 100 3X1

Código: Fábrika: Unidade:
45750 DCASA CJ/3
F1 F4

UN: R\$ 3,91 AV: R\$ 46,88 15: R\$ 47,86
30: R\$ 48,82 45: R\$ 49,79 60: R\$ 50,79



CABIDE CROM POPULAR 792 12X1

Código: Fábrika: Unidade:
7502 ARAMINAS DZ/12
F1 F4

UN: R\$ 15,28 AV: R\$ 15,28 15: R\$ 15,59
30: R\$ 15,91 45: R\$ 16,22 60: R\$ 16,55



CABIDE GALINHA C/1 GANCHO 5055

Código: Fábrika: Unidade:
39230 PAIOL UN/1
F1 F4

UN: R\$ 1,15 AV: R\$ 3,45 15: R\$ 3,52
30: R\$ 3,59 45: R\$ 3,66 60: R\$ 3,73



CABIDE PLAST AD PRETO 400 3X1

Código: Fábrika: Unidade:
40952 P A SOUZA CJ/3
F1 F4

UN: R\$ 1,15 AV: R\$ 6,90 15: R\$ 7,05
30: R\$ 7,19 45: R\$ 7,33 60: R\$ 7,48



CABIDE PLAST AD PRETO 401 6X1

Código: Fábrika: Unidade:
40953 P A SOUZA CJ/6
F1 F4

UN: R\$ 1,14 AV: R\$ 13,70 15: R\$ 13,98
30: R\$ 14,26 45: R\$ 14,55 60: R\$ 14,84



CABIDE PLAST AD PRETO 402 12X1

Código: Fábrika: Unidade:
40954 P A SOUZA CJ/12
F1 F4

UN: R\$ 2,87 AV: R\$ 5,75 15: R\$ 5,87
30: R\$ 5,99 45: R\$ 6,10 60: R\$ 6,23

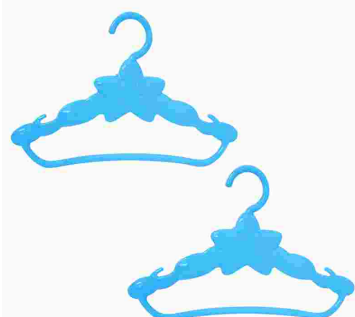

CABIDE PLAST BABY ESTRELA AZUL 3807 2X1

Código: Fábrika: Unidade:
35489 TRITEC CJ/2
F1 F4

UN: R\$ 2,77 AV: R\$ 5,54 15: R\$ 5,66
30: R\$ 5,77 45: R\$ 5,89 60: R\$ 6,00



CABIDE PLAST BABY ESTRELA ROSA 3808 2X1

Código: Fábrika: Unidade:
35488 TRITEC CJ/2
F1 F4

UN: R\$ 1,30 AV: R\$ 3,91 15: R\$ 3,99
30: R\$ 4,07 45: R\$ 4,15 60: R\$ 4,23



CABIDE PLAST PRETO 001 3X1

Código: Fábrika: Unidade:
41490 KOZI PLAST C//3
F1 F4

UN: R\$ 4,89 AV: R\$ 4,89 15: R\$ 4,99
30: R\$ 5,09 45: R\$ 5,19 60: R\$ 5,29



CABO MADEIRA PLAST 1,20 MTS C/ ROSCA

Código: Fábrika: Unidade:
49869 HALLEY UN/1
F1 F4

UN: R\$ 4,41 AV: R\$ 4,41 15: R\$ 4,50
30: R\$ 4,59 45: R\$ 4,68 60: R\$ 4,77



CABO MADEIRA 1,20 MTS C/ ROSCA

Código: Fábrika: Unidade:
49896 HALLEY UN/1
F1 F4

UN: R\$ 127,29 AV: R\$ 127,29 15: R\$ 129,94
30: R\$ 132,54 45: R\$ 135,19 60: R\$ 137,89



CACAROLA ALUM HOTEL 30 10LTS

Código: Fábrika: Unidade:
50778 ASJ UN/1
F1 F4

UN: R\$ 161,56 AV: R\$ 161,56 15: R\$ 164,92
30: R\$ 168,22 45: R\$ 171,59 60: R\$ 175,02



CACAROLA ALUM HOTEL 32 12LTS

Código: Fábrika: Unidade:
50777 ASJ UN/1
F1 F4

UN: R\$ 171,36 AV: R\$ 171,36 15: R\$ 174,93
30: R\$ 178,43 45: R\$ 182,00 60: R\$ 185,64



CACAROLA ALUM HOTEL 36 17LTS

Código: Fábrika: Unidade:
50716 ASJ UN/1
F1 F4

UN: R\$ 24,47 AV: R\$ 24,47 15: R\$ 24,98
30: R\$ 25,48 45: R\$ 25,99 60: R\$ 26,51



CACAROLA ALUM LEVE 14 C/TAMPA 1,0 LT
Código: 14755 Fábrica: AVELAR Unidade: UN/1 F1 F4

UN: R\$ 24,47 AV: R\$ 24,47 15: R\$ 24,98
30: R\$ 25,48 45: R\$ 25,99 60: R\$ 26,51



CACAROLA ALUM LEVE 16 C/TAMPA 1,3 LTS
Código: 14756 Fábrica: AVELAR Unidade: UN/1 F1 F4

UN: R\$ 9,07 AV: R\$ 9,07 15: R\$ 9,26
30: R\$ 9,44 45: R\$ 9,63 60: R\$ 9,82



CACHEPOT ALUM CANELADO SEM ALCA PEQ 206
Código: 39548 Fábrica: BMC ALUMINIO Unidade: UN/1 F1 F4

UN: R\$ 48,95 AV: R\$ 48,95 15: R\$ 49,97
30: R\$ 50,97 45: R\$ 51,99 60: R\$ 53,03

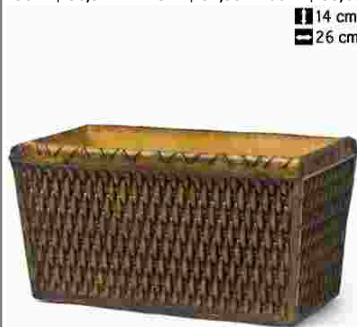

CACHEPOT ATHENAS JARDINEIRA 26 ENVELHECI
Código: 32759 Fábrica: NUTRIPLAN Unidade: UN/1 F1 F4

UN: R\$ 37,70 AV: R\$ 37,70 15: R\$ 38,48
30: R\$ 39,25 45: R\$ 40,04 60: R\$ 40,84



CACHEPOT ELEGANCE CONICO CYBIDIUM BRANCO
Código: 39645 Fábrica: NUTRIPLAN Unidade: UN/1 F1 F4

UN: R\$ 48,92 AV: R\$ 48,92 15: R\$ 49,94
30: R\$ 50,94 45: R\$ 51,96 60: R\$ 53,00



CACHEPOT ELEGANCE CONICO CYBIDIUM CAFE 1
Código: 38910 Fábrica: NUTRIPLAN Unidade: UN/1 F1 F4

UN: R\$ 48,92 AV: R\$ 48,92 15: R\$ 49,94
30: R\$ 50,94 45: R\$ 51,96 60: R\$ 53,00



CACHEPOT ELEGANCE CONICO CYBIDIUM TRAVER
Código: 39646 Fábrica: NUTRIPLAN Unidade: UN/1 F1 F4

UN: R\$ 39,16 AV: R\$ 39,16 15: R\$ 39,97
30: R\$ 40,77 45: R\$ 41,59 60: R\$ 42,42

11 cm
34 cm
3,1 lts



CACHEPOT ELEGANCE JARDINEIRA 01 BRANC 3L
Código: 32763 Fábrica: NUTRIPLAN Unidade: UN/1 F1 F4

UN: R\$ 46,02 AV: R\$ 46,02 15: R\$ 46,98
30: R\$ 47,92 45: R\$ 48,88 60: R\$ 49,86

11 cm
34 cm
3,1 lts



CACHEPOT ELEGANCE JARDINEIRA 01 CAFE 3L
Código: 32760 Fábrica: NUTRIPLAN Unidade: UN/1 F1 F4

UN: R\$ 45,92 AV: R\$ 45,92 15: R\$ 46,88
30: R\$ 47,82 45: R\$ 48,78 60: R\$ 49,75

11 cm
34 cm
3,1 lts



CACHEPOT ELEGANCE JARDINEIRA 01 PRETO 3L
Código: 32764 Fábrica: NUTRIPLAN Unidade: UN/1 F1 F4

UN: R\$ 46,02 AV: R\$ 46,02 15: R\$ 46,98
30: R\$ 47,92 45: R\$ 48,88 60: R\$ 49,86

11 cm
34 cm
3,1 lts



CACHEPOT ELEGANCE JARDINEIRA 01 TRAVE 3L
Código: 32762 Fábrica: NUTRIPLAN Unidade: UN/1 F1 F4

UN: R\$ 7,34 AV: R\$ 7,34 15: R\$ 7,50
30: R\$ 7,65 45: R\$ 7,80 60: R\$ 7,96

14 cm
21 cm
1 lts



CACHEPOT ELEGANCE PAREDE MINI PRETO 1,5L
Código: 33083 Fábrica: NUTRIPLAN Unidade: UN/1 F1 F4

UN: R\$ 18,60 AV: R\$ 18,60 15: R\$ 18,98
30: R\$ 19,36 45: R\$ 19,75 60: R\$ 20,14

11,2cm
11cm

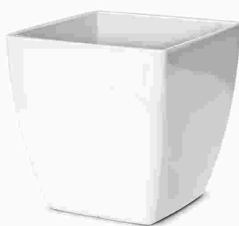

CACHEPOT ELEGANCE QUAD 01 BRANCO 950ML
Código: 48426 Fábrica: NUTRIPLAN Unidade: UN/1 F1 F4

UN: R\$ 24,37 AV: R\$ 24,37 15: R\$ 24,88
30: R\$ 25,38 45: R\$ 25,89 60: R\$ 26,40

11,2cm
11cm



CACHEPOT ELEGANCE QUAD 01 CAFE IMP 950ML
Código: 48427 Fábrica: NUTRIPLAN Unidade: UN/1 F1 F4

UN: R\$ 19,09 AV: R\$ 19,09 15: R\$ 19,49
30: R\$ 19,88 45: R\$ 20,28 60: R\$ 20,69

11 cm
11,2 cm
0,95 lts



CACHEPOT ELEGANCE QUAD 01 TRAVERTI 950ML
Código: 32768 Fábrica: NUTRIPLAN Unidade: UN/1 F1 F4

UN: R\$ 11,43 AV: R\$ 11,43 15: R\$ 11,67
30: R\$ 11,90 45: R\$ 12,14 60: R\$ 12,38

13 cm
13 cm
2,4 lts

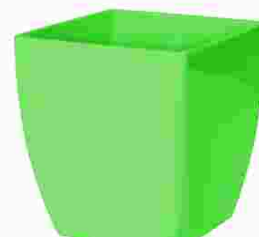

CACHEPOT ELEGANCE QUAD 02 VERDE LIM 1,7L
Código: 33087 Fábrica: NUTRIPLAN Unidade: UN/1 F1 F4

UN: R\$ 36,72 AV: R\$ 36,72 15: R\$ 37,49
 30: R\$ 38,23 45: R\$ 39,00 60: R\$ 39,78
 13 cm
 13 cm
 2,4 lts

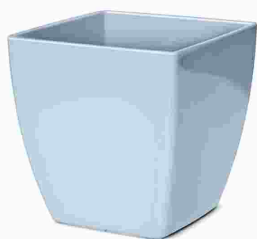

CACHEPOT ELEGANCE QUAD 03 AZUL BB 2,4LTS
 Código: 36791 Fábrica: NUTRIPLAN Unidade: UN/1
 F1 F4

UN: R\$ 36,72 AV: R\$ 36,72 15: R\$ 37,49
 30: R\$ 38,23 45: R\$ 39,00 60: R\$ 39,78
 14,9 cm
 15,2 cm
 2,4 lts



CACHEPOT ELEGANCE QUAD 03 BRANCO 2,4LTS
 Código: 32766 Fábrica: NUTRIPLAN Unidade: UN/1
 F1 F4

UN: R\$ 36,72 AV: R\$ 36,72 15: R\$ 37,49
 30: R\$ 38,23 45: R\$ 39,00 60: R\$ 39,78
 14,9 cm
 15,2 cm
 2,4 lts



CACHEPOT ELEGANCE QUAD 03 CAFE IMPE 2,4L
 Código: 32765 Fábrica: NUTRIPLAN Unidade: UN/1
 F1 F4

UN: R\$ 36,72 AV: R\$ 36,72 15: R\$ 37,49
 30: R\$ 38,23 45: R\$ 39,00 60: R\$ 39,78
 13 cm
 13 cm
 2,4 lts



CACHEPOT ELEGANCE QUAD 03 ROSE 2,4LTS
 Código: 36792 Fábrica: NUTRIPLAN Unidade: UN/1
 F1 F4

UN: R\$ 36,72 AV: R\$ 36,72 15: R\$ 37,49
 30: R\$ 38,23 45: R\$ 39,00 60: R\$ 39,78
 14 cm
 15 cm
 1,7 lts



CACHEPOT ELEGANCE QUAD 03 TRAVERTIN 2,4L
 Código: 33908 Fábrica: NUTRIPLAN Unidade: UN/1
 F1 F4

UN: R\$ 43,28 AV: R\$ 43,28 15: R\$ 44,18
 30: R\$ 45,07 45: R\$ 45,97 60: R\$ 46,89
 16 cm
 16 cm
 3 lts

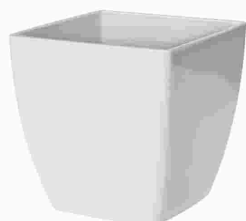

CACHEPOT ELEGANCE QUAD 04 BRANCO 3LTS
 Código: 38673 Fábrica: NUTRIPLAN Unidade: UN/1
 F1 F4

UN: R\$ 48,47 AV: R\$ 48,47 15: R\$ 49,48
 30: R\$ 50,47 45: R\$ 51,48 60: R\$ 52,51
 16,6 cm
 16,1 cm
 3,0 lts



CACHEPOT ELEGANCE QUAD 04 CAFE IMPE 3LTS
 Código: 33550 Fábrica: NUTRIPLAN Unidade: UN/1
 F1 F4

UN: R\$ 4,59 AV: R\$ 55,13 15: R\$ 56,28
 30: R\$ 57,40 45: R\$ 58,55 60: R\$ 59,72
 5,5 cm



CACHEPOT ELEGANCE RED MINI AZUL BB 12X1
 Código: 35719 Fábrica: NUTRIPLAN Unidade: PT/12
 F1 F4

UN: R\$ 4,90 AV: R\$ 58,74 15: R\$ 59,97
 30: R\$ 61,17 45: R\$ 62,39 60: R\$ 63,64
 5,5 cm



CACHEPOT ELEGANCE RED MINI PRETO ON 12X1
 Código: 35722 Fábrica: NUTRIPLAN Unidade: PT/12
 F1 F4

UN: R\$ 4,90 AV: R\$ 58,75 15: R\$ 59,98
 30: R\$ 61,18 45: R\$ 62,40 60: R\$ 63,65
 5,5 cm



CACHEPOT ELEGANCE RED MINI ROSE 12X1
 Código: 35723 Fábrica: NUTRIPLAN Unidade: PT/12
 F1 F4

UN: R\$ 4,90 AV: R\$ 58,75 15: R\$ 59,98
 30: R\$ 61,18 45: R\$ 62,40 60: R\$ 63,65
 5,5 cm



CACHEPOT ELEGANCE RED MINI VINHO 12X1
 Código: 35725 Fábrica: NUTRIPLAN Unidade: PT/12
 F1 F4

UN: R\$ 11,75 AV: R\$ 141,00 15: R\$ 143,94
 30: R\$ 146,82 45: R\$ 149,76 60: R\$ 152,75
 5 cm
 6,5 cm
 350 ml



CACHEPOT ELEGANCE RED 00 BRAN 350ML 12X1
 Código: 38907 Fábrica: NUTRIPLAN Unidade: PT/12
 F1 F4

UN: R\$ 140,27 AV: R\$ 140,27 15: R\$ 143,19
 30: R\$ 146,06 45: R\$ 148,98 60: R\$ 151,96
 5 cm
 6,5 cm
 350 ml



CACHEPOT ELEGANCE RED 00 CAFE 350ML 12X1
 Código: 38908 Fábrica: NUTRIPLAN Unidade: UN/1
 F1 F4

UN: R\$ 9,39 AV: R\$ 112,71 15: R\$ 115,05
 30: R\$ 117,36 45: R\$ 119,70 60: R\$ 122,10
 5 cm
 6,5 cm
 350 ml



CACHEPOT ELEGANCE RED 00 DOUR 350ML 12X1
 Código: 38906 Fábrica: NUTRIPLAN Unidade: PT/12
 F1 F4

UN: R\$ 11,69 AV: R\$ 140,27 15: R\$ 143,19
 30: R\$ 146,06 45: R\$ 148,98 60: R\$ 151,96
 5 cm
 6,5 cm
 350 ml



CACHEPOT ELEGANCE RED 00 PRET 350ML 12X1
 Código: 38909 Fábrica: NUTRIPLAN Unidade: PT/12
 F1 F4

UN: R\$ 11,69 AV: R\$ 140,27 15: R\$ 143,19
 30: R\$ 146,06 45: R\$ 148,98 60: R\$ 151,96
 5 cm
 6,5 cm
 350 ml



CACHEPOT ELEGANCE RED 00 TRAV 350ML 12X1
 Código: 38905 Fábrica: NUTRIPLAN Unidade: PT/12
 F1 F4

UN: R\$ 8,16 AV: R\$ 97,91 15: R\$ 99,95
 30: R\$ 101,95 45: R\$ 103,99 60: R\$ 106,07
 11 5 cm
 11 6,5 cm
 11 350 ml



CACHEPOT ELEGANCE RED 00 VINH 350ML 12X1
 Código: Fábrica: Unidade:
38911 NUTRIPLAN PT/12
 F1 F4

UN: R\$ 11,75 AV: R\$ 11,75 15: R\$ 12,00
 30: R\$ 12,24 45: R\$ 12,48 60: R\$ 12,73
 11 8,7 cm
 11 11,4 cm
 11 0,6 lts



CACHEPOT ELEGANCE RED 01 AMARELO 600ML
 Código: Fábrica: Unidade:
32732 NUTRIPLAN UN/1
 F1 F4

UN: R\$ 4,41 AV: R\$ 4,41 15: R\$ 4,50
 30: R\$ 4,59 45: R\$ 4,68 60: R\$ 4,77
 11 08 cm
 11 11 cm
 11 0,6 lts



CACHEPOT ELEGANCE RED 01 PRETO 600ML
 Código: Fábrica: Unidade:
33082 NUTRIPLAN UN/1
 F1 F4

UN: R\$ 14,69 AV: R\$ 14,69 15: R\$ 14,99
 30: R\$ 15,29 45: R\$ 15,60 60: R\$ 15,91
 11 10,9 cm
 11 13,6 cm
 11 1,0 lts



CACHEPOT ELEGANCE RED 03 BRANCO 1,5LT
 Código: Fábrica: Unidade:
37750 NUTRIPLAN UN/1
 F1 F4

UN: R\$ 19,09 AV: R\$ 19,09 15: R\$ 19,49
 30: R\$ 19,88 45: R\$ 20,28 60: R\$ 20,69
 11 12 cm
 11 15 cm
 11 1,5 lts



CACHEPOT ELEGANCE RED 03 CAFE IMPER 1,5L
 Código: Fábrica: Unidade:
33080 NUTRIPLAN UN/1
 F1 F4

UN: R\$ 19,09 AV: R\$ 19,09 15: R\$ 19,49
 30: R\$ 19,88 45: R\$ 20,28 60: R\$ 20,69
 11 12 cm
 11 15,4 cm
 11 1,5 lts



CACHEPOT ELEGANCE RED 03 TRAVERTIN 1,5LT
 Código: Fábrica: Unidade:
32726 NUTRIPLAN UN/1
 F1 F4

UN: R\$ 78,33 AV: R\$ 78,33 15: R\$ 79,96
 30: R\$ 81,56 45: R\$ 83,19 60: R\$ 84,85
 11 23,2 cm
 11 25,4 cm
 11 8,5 lts



CACHEPOT ELEGANCE RED 04 CAFE IMPER 8,5L
 Código: Fábrica: Unidade:
32728 NUTRIPLAN UN/1
 F1 F4

UN: R\$ 39,99 AV: R\$ 39,99 15: R\$ 40,82
 30: R\$ 41,64 45: R\$ 42,47 60: R\$ 43,32
 11 26,7 cm
 11 27,6 cm
 11 12 lts



CACHEPOT ELEGANCE RED 05 VERDE LIM 12LTS
 Código: Fábrica: Unidade:
32729 NUTRIPLAN UN/1
 F1 F4

UN: R\$ 30,84 AV: R\$ 30,84 15: R\$ 31,48
 30: R\$ 32,11 45: R\$ 32,75 60: R\$ 33,40
 11 15,3 cm
 11 15,4 cm
 11 2,0 lts



CACHEPOT ELEGANCE RED 3,5 PRETO ONIX 2LT
 Código: Fábrica: Unidade:
32727 NUTRIPLAN UN/1
 F1 F4

UN: R\$ 28,98 AV: R\$ 28,98 15: R\$ 29,59
 30: R\$ 30,18 45: R\$ 30,78 60: R\$ 31,40
 11 26 cm
 11 4 cm
 11 4 lts



CACHEPOT ELEGANCE TRAPEZIO 01 AZUL BB 4LT
 Código: Fábrica: Unidade:
36793 NUTRIPLAN UN/1
 F1 F4

UN: R\$ 28,98 AV: R\$ 28,98 15: R\$ 29,59
 30: R\$ 30,18 45: R\$ 30,78 60: R\$ 31,40
 11 26 cm
 11 4 cm
 11 4 lts

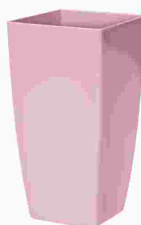

CACHEPOT ELEGANCE TRAPEZIO 01 ROSE 4LT
 Código: Fábrica: Unidade:
36794 NUTRIPLAN UN/1
 F1 F4

UN: R\$ 35,60 AV: R\$ 35,60 15: R\$ 36,35
 30: R\$ 37,07 45: R\$ 37,81 60: R\$ 38,57
 11 26 cm
 11 14 cm
 11 4 lts



CACHEPOT ELEGANCE TRAPEZIO 01 BRANCO 4LT
 Código: Fábrica: Unidade:
35718 NUTRIPLAN UN/1
 F1 F4

UN: R\$ 46,27 AV: R\$ 46,27 15: R\$ 47,23
 30: R\$ 48,18 45: R\$ 49,14 60: R\$ 50,12
 11 26 cm
 11 14 cm
 11 4 lts

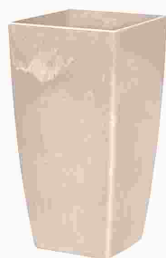

CACHEPOT ELEGANCE TRAPEZIO 01 TRAVER 4LT
 Código: Fábrica: Unidade:
35460 NUTRIPLAN UN/1
 F1 F4

UN: R\$ 33,39 AV: R\$ 33,39 15: R\$ 34,09
 30: R\$ 34,77 45: R\$ 35,46 60: R\$ 36,17
 11 26 cm
 11 14 cm
 11 4 lts



CACHEPOT ELEGANCE TRAPEZIO 01 VINHO 4LTS
 Código: Fábrica: Unidade:
35717 NUTRIPLAN UN/1
 F1 F4

UN: R\$ 3,61 AV: R\$ 3,61 15: R\$ 3,69
 30: R\$ 3,76 45: R\$ 3,84 60: R\$ 3,91
 11 23 cm
 11 32 cm
 11 2,4 L



CACHEPOT PLAST PAREDE PRETO 2,4LTS
 Código: Fábrica: Unidade:
41655 INPLAST UN/1
 F1 F4

UN: R\$ 4,40 AV: R\$ 4,40 15: R\$ 4,49
 30: R\$ 4,58 45: R\$ 4,67 60: R\$ 4,76
 11 23 cm
 11 32 cm
 11 2,4 L



CACHEPOT PLAST PAREDE TERRACOTA 2,4LTS
 Código: Fábrica: Unidade:
41656 INPLAST UN/1
 F1 F4

UN: R\$ 4,23 AV: R\$ 4,23 15: R\$ 4,32
30: R\$ 4,40 45: R\$ 4,49 60: R\$ 4,58



11 cm
14 cm

CACHEPOT PLAST 11X14CM 1100

Código: Fábrika: Unidade:
37805 ENGIPLAST UN/1
F1 F4

UN: R\$ 1,71 AV: R\$ 6,84 15: R\$ 6,99
30: R\$ 7,13 45: R\$ 7,27 60: R\$ 7,41



CACHEPOT PLAST 220ML 6404 4X1

Código: Fábrika: Unidade:
41492 KOZI PLAST CJ/4
F1 F4

UN: R\$ 3,58 AV: R\$ 3,58 15: R\$ 3,66
30: R\$ 3,73 45: R\$ 3,81 60: R\$ 3,88



CACHEPOT QUADRADO CONICO 7CM 210

Código: Fábrika: Unidade:
30832 P A SOUZA UN/1
F1 F4

UN: R\$ 4,47 AV: R\$ 4,47 15: R\$ 4,57
30: R\$ 4,66 45: R\$ 4,75 60: R\$ 4,85



CACHEPOT QUADRADO CONICO 9CM 211

Código: Fábrika: Unidade:
30831 P A SOUZA UN/1
F1 F4

UN: R\$ 6,02 AV: R\$ 6,02 15: R\$ 6,15
30: R\$ 6,27 45: R\$ 6,40 60: R\$ 6,52



CACHEPOT QUADRADO CONICO 11CM 212

Código: Fábrika: Unidade:
29220 P A SOUZA UN/1
F1 F4

UN: R\$ 7,64 AV: R\$ 7,64 15: R\$ 7,80
30: R\$ 7,95 45: R\$ 8,11 60: R\$ 8,27



CACHEPOT QUADRADO CONICO 13CM 213

Código: Fábrika: Unidade:
29221 P A SOUZA UN/1
F1 F4

UN: R\$ 9,11 AV: R\$ 9,11 15: R\$ 9,30
30: R\$ 9,48 45: R\$ 9,67 60: R\$ 9,87



CACHEPOT QUADRADO CONICO 15CM 214

Código: Fábrika: Unidade:
29222 P A SOUZA UN/1
F1 F4

UN: R\$ 3,58 AV: R\$ 3,58 15: R\$ 3,66
30: R\$ 3,73 45: R\$ 3,81 60: R\$ 3,88



CACHEPOT QUADRADO RETO 7CM 215

Código: Fábrika: Unidade:
30825 P A SOUZA UN/1
F1 F4

UN: R\$ 4,47 AV: R\$ 4,47 15: R\$ 4,57
30: R\$ 4,66 45: R\$ 4,75 60: R\$ 4,85



CACHEPOT QUADRADO RETO 9CM 216

Código: Fábrika: Unidade:
30824 P A SOUZA UN/1
F1 F4

UN: R\$ 6,02 AV: R\$ 6,02 15: R\$ 6,15
30: R\$ 6,27 45: R\$ 6,40 60: R\$ 6,52



CACHEPOT QUADRADO RETO 11CM 217

Código: Fábrika: Unidade:
30823 P A SOUZA UN/1
F1 F4

UN: R\$ 7,64 AV: R\$ 7,64 15: R\$ 7,80
30: R\$ 7,95 45: R\$ 8,11 60: R\$ 8,27



CACHEPOT QUADRADO RETO 13CM 218

Código: Fábrika: Unidade:
30822 P A SOUZA UN/1
F1 F4

UN: R\$ 9,11 AV: R\$ 9,11 15: R\$ 9,30
30: R\$ 9,48 45: R\$ 9,67 60: R\$ 9,87



CACHEPOT QUADRADO RETO 15CM 219

Código: Fábrika: Unidade:
30821 P A SOUZA UN/1
F1 F4

UN: R\$ 3,58 AV: R\$ 3,58 15: R\$ 3,66
30: R\$ 3,73 45: R\$ 3,81 60: R\$ 3,88



CACHEPOT SEXTAVADO CONICO 7CM 200

Código: Fábrika: Unidade:
30830 P A SOUZA UN/1
F1 F4

UN: R\$ 4,47 AV: R\$ 4,47 15: R\$ 4,57
30: R\$ 4,66 45: R\$ 4,75 60: R\$ 4,85



CACHEPOT SEXTAVADO CONICO 9CM 201

Código: Fábrika: Unidade:
30829 P A SOUZA UN/1
F1 F4

UN: R\$ 6,02 AV: R\$ 6,02 15: R\$ 6,15
30: R\$ 6,27 45: R\$ 6,40 60: R\$ 6,52



CACHEPOT SEXTAVADO CONICO 11CM 202

Código: Fábrika: Unidade:
30828 P A SOUZA UN/1
F1 F4

UN: R\$ 7,64 AV: R\$ 7,64 15: R\$ 7,80
30: R\$ 7,95 45: R\$ 8,11 60: R\$ 8,27



CACHEPOT SEXTAVADO CONICO 13CM 203

Código: Fábrika: Unidade:
30827 P A SOUZA UN/1
F1 F4

UN: R\$ 9,11 AV: R\$ 9,11 15: R\$ 9,30
30: R\$ 9,48 45: R\$ 9,67 60: R\$ 9,87

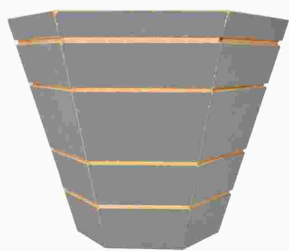

CACHEPOT SEXTAVADO CONICO 15CM 204
Código: Fábrica: Unidade:
30826 P A SOUZA UN/1
F1 F4

UN: R\$ 3,58 AV: R\$ 3,58 15: R\$ 3,66
30: R\$ 3,73 45: R\$ 3,81 60: R\$ 3,88

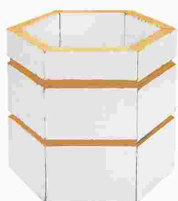

CACHEPOT SEXTAVADO RETO 7CM 205
Código: Fábrica: Unidade:
30837 P A SOUZA UN/1
F1 F4

UN: R\$ 4,40 AV: R\$ 4,40 15: R\$ 4,49
30: R\$ 4,58 45: R\$ 4,67 60: R\$ 4,76



CACHEPOT SEXTAVADO RETO 9CM 206
Código: Fábrica: Unidade:
30836 P A SOUZA UN/1
F1 F4

UN: R\$ 6,02 AV: R\$ 6,02 15: R\$ 6,15
30: R\$ 6,27 45: R\$ 6,40 60: R\$ 6,52

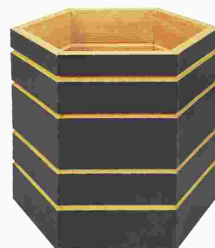

CACHEPOT SEXTAVADO RETO 11CM 207
Código: Fábrica: Unidade:
30835 P A SOUZA UN/1
F1 F4

UN: R\$ 7,64 AV: R\$ 7,64 15: R\$ 7,80
30: R\$ 7,95 45: R\$ 8,11 60: R\$ 8,27

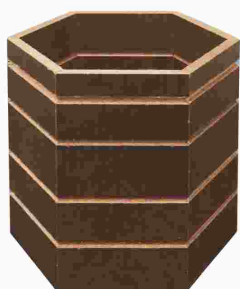

CACHEPOT SEXTAVADO RETO 13CM 208
Código: Fábrica: Unidade:
30834 P A SOUZA UN/1
F1 F4

UN: R\$ 8,96 AV: R\$ 8,96 15: R\$ 9,15
30: R\$ 9,33 45: R\$ 9,52 60: R\$ 9,71



CACHEPOT SEXTAVADO RETO 15CM 209
Código: Fábrica: Unidade:
30833 P A SOUZA UN/1
F1 F4

UN: R\$ 68,53 AV: R\$ 68,53 15: R\$ 69,96
30: R\$ 71,36 45: R\$ 72,79 60: R\$ 74,24



CADEIRA BISTRO PONTE NOVA BRANCA
Código: Fábrica: Unidade:
21168 ANTARES UN/1
F1 F4

UN: R\$ 68,53 AV: R\$ 68,53 15: R\$ 69,96
30: R\$ 71,36 45: R\$ 72,79 60: R\$ 74,24



CADEIRA BISTRO PONTE NOVA PRETA
Código: Fábrica: Unidade:
40038 ANTARES UN/1
F1 F4

UN: R\$ 146,88 AV: R\$ 146,88 15: R\$ 149,94
30: R\$ 152,94 45: R\$ 156,00 60: R\$ 159,12



CADEIRA COLONIAL PLAST DESMONTAVEL
Código: Fábrica: Unidade:
22151 ANTARES UN/1
F1 F4

UN: R\$ 78,33 AV: R\$ 78,33 15: R\$ 79,96
30: R\$ 81,56 45: R\$ 83,19 60: R\$ 84,85



CADEIRA POLTRONA BOA VISTA BRANCA
Código: Fábrica: Unidade:
21165 ANTARES UN/1
F1 F4

UN: R\$ 24,47 AV: R\$ 24,47 15: R\$ 24,98
30: R\$ 25,48 45: R\$ 25,99 60: R\$ 26,51



CAFETEIRA ALUM LEVE 1,2 LTS
Código: Fábrica: Unidade:
5905 AVELAR UN/1
F1 F4

UN: R\$ 63,64 AV: R\$ 63,64 15: R\$ 64,96
30: R\$ 66,26 45: R\$ 67,59 60: R\$ 68,94



CAFETEIRA ALUM PADRAO 657
Código: Fábrica: Unidade:
37512 MSR UN/1
F1 F4

UN: R\$ 48,95 AV: R\$ 48,95 15: R\$ 49,97
30: R\$ 50,97 45: R\$ 51,99 60: R\$ 53,03



CAIXA DE FRUTA GDE ENVELHECIDO 1461-1
Código: Fábrica: Unidade:
41754 PAIOL UN/1
F1 F4

UN: R\$ 36,38 AV: R\$ 36,38 15: R\$ 37,14
30: R\$ 37,88 45: R\$ 38,64 60: R\$ 39,41



CAIXA DE FRUTA GDE PINTADO 1461
Código: Fábrica: Unidade:
37178 PAIOL UN/1
F1 F4

UN: R\$ 30,36 AV: R\$ 30,36 15: R\$ 30,99
30: R\$ 31,61 45: R\$ 32,24 60: R\$ 32,88



CAIXA DE FRUTA MED ASSADO 1562
Código: Fábrica: Unidade:
37175 PAIOL UN/1
F1 F4

UN: R\$ 28,79 AV: R\$ 28,79 15: R\$ 29,39
30: R\$ 29,98 45: R\$ 30,58 60: R\$ 31,19



CAIXA DE FRUTA MED PINT/ENVELH 1462
Código: Fábrica: Unidade:
37179 PAIOL UN/1
F1 F4

UN: R\$ 24,24 AV: R\$ 24,24 15: R\$ 24,74
 30: R\$ 25,23 45: R\$ 25,74 60: R\$ 26,25



CAIXA DE FRUTA PEQ ASSADO 8005

Código: 37176 Fábrica: PAIOL Unidade: UN/1
 F1 F4

UN: R\$ 23,50 AV: R\$ 23,50 15: R\$ 23,99
 30: R\$ 24,47 45: R\$ 24,96 60: R\$ 25,46



CAIXA DE FRUTA PEQ PINT/ENVELH 1463

Código: 37180 Fábrica: PAIOL Unidade: UN/1
 F1 F4

UN: R\$ 20,55 AV: R\$ 20,55 15: R\$ 20,98
 30: R\$ 21,40 45: R\$ 21,83 60: R\$ 22,27



CAIXA DE FRUTA PP ENVELHECIDO 1453-1

Código: 37177 Fábrica: PAIOL Unidade: UN/1
 F1 F4

UN: R\$ 26,43 AV: R\$ 26,43 15: R\$ 26,98
 30: R\$ 27,52 45: R\$ 28,07 60: R\$ 28,63



CAIXA DE FRUTA PP PINTADO 1453-2

Código: 37181 Fábrica: PAIOL Unidade: UN/1
 F1 F4

UN: R\$ 34,26 AV: R\$ 34,26 15: R\$ 34,98
 30: R\$ 35,68 45: R\$ 36,39 60: R\$ 37,12



CAIXA DE FRUTA 2 CRISANTEMOS ENVE 2514-2

Código: 37183 Fábrica: PAIOL Unidade: UN/1
 F1 F4

UN: R\$ 28,39 AV: R\$ 28,39 15: R\$ 28,98
 30: R\$ 29,56 45: R\$ 30,15 60: R\$ 30,75



CAIXA DE FRUTA 2 CRISANTEMOS PINT 2514-1

Código: 40842 Fábrica: PAIOL Unidade: UN/1
 F1 F4

UN: R\$ 17,63 AV: R\$ 17,63 15: R\$ 17,99
 30: R\$ 18,35 45: R\$ 18,72 60: R\$ 19,09



CAIXA DE FRUTA 2 VIOLETAS 2515

Código: 37182 Fábrica: PAIOL Unidade: UN/1
 F1 F4

UN: R\$ 3,91 AV: R\$ 3,91 15: R\$ 3,99
 30: R\$ 4,07 45: R\$ 4,15 60: R\$ 4,23

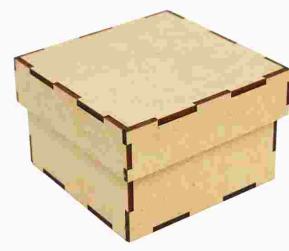

CAIXA MDF 5X5X5CM

Código: 51073 Fábrica: FEITOMAO Unidade: UN/1
 F1 F4

UN: R\$ 4,40 AV: R\$ 4,40 15: R\$ 4,49
 30: R\$ 4,58 45: R\$ 4,67 60: R\$ 4,76



CAIXA MDF 8X8X5CM

Código: 47264 Fábrica: FEITOMAO Unidade: UN/1
 F1 F4

UN: R\$ 4,89 AV: R\$ 4,89 15: R\$ 4,99
 30: R\$ 5,09 45: R\$ 5,19 60: R\$ 5,29



CAIXA MDF 9X9X5CM

Código: 47265 Fábrica: FEITOMAO Unidade: UN/1
 F1 F4

UN: R\$ 5,18 AV: R\$ 5,18 15: R\$ 5,29
 30: R\$ 5,39 45: R\$ 5,50 60: R\$ 5,61

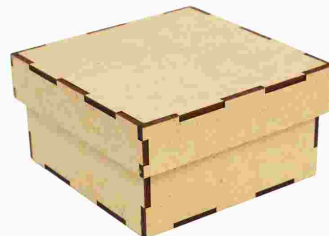

CAIXA MDF 10X10X5CM

Código: 47266 Fábrica: FEITOMAO Unidade: UN/1
 F1 F4

UN: R\$ 8,80 AV: R\$ 8,80 15: R\$ 8,99
 30: R\$ 9,17 45: R\$ 9,35 60: R\$ 9,54

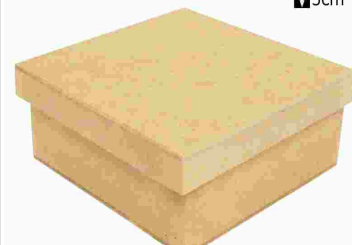
CAIXA MDF 12X12X5CM

Código: 47268 Fábrica: FEITOMAO Unidade: UN/1
 F1 F4

UN: R\$ 24,47 AV: R\$ 24,47 15: R\$ 24,98
 30: R\$ 25,48 45: R\$ 25,99 60: R\$ 26,51

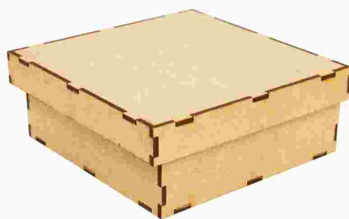

CAIXA MDF 15X15X5CM

Código: 47269 Fábrica: FEITOMAO Unidade: UN/1
 F1 F4

UN: R\$ 16,64 AV: R\$ 16,64 15: R\$ 16,98
 30: R\$ 17,32 45: R\$ 17,67 60: R\$ 18,02



CAIXA MDF 20X20X5CM

Código: 50758 Fábrica: FEITOMAO Unidade: UN/1
 F1 F4

UN: R\$ 24,47 AV: R\$ 24,47 15: R\$ 24,98
 30: R\$ 25,48 45: R\$ 25,99 60: R\$ 26,51



CAIXA MINI KIT 3 PCS ENVELHECIDO 8788-5

Código: 41056 Fábrica: PAIOL Unidade: CJ/1
 F1 F4

UN: R\$ 5,67 AV: R\$ 5,67 15: R\$ 5,79
 30: R\$ 5,90 45: R\$ 6,02 60: R\$ 6,14



CAIXA MINI 1 ENVELHECIDO 8022-2

Código: 41751 Fábrica: PAIOL Unidade: UN/1
 F1 F4

UN: R\$ 8,80 AV: R\$ 8,80 15: R\$ 8,99
30: R\$ 9,17 45: R\$ 9,35 60: R\$ 9,54

17 cm
15 cm

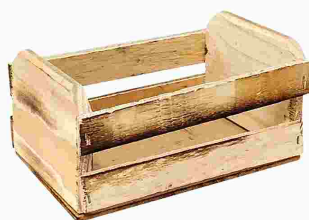

CAIXA MINI 2 ENVELHECIDO 6664-2

Código: Fábrika: Unidade:
37186 PAIOL UN/1
F1 F4

UN: R\$ 8,80 AV: R\$ 8,80 15: R\$ 8,99
30: R\$ 9,17 45: R\$ 9,35 60: R\$ 9,54

17 cm
13 cm



CAIXA MINI 2 PINTADO 6664-1

Código: Fábrika: Unidade:
41752 PAIOL UN/1
F1 F4

UN: R\$ 23,11 AV: R\$ 23,11 15: R\$ 23,59
30: R\$ 24,06 45: R\$ 24,54 60: R\$ 25,03



CAIXA MULTI USO 11 LTS RET C/TPA 6649

Código: Fábrika: Unidade:
24474 INPLAST UN/1
F1 F4

UN: R\$ 68,53 AV: R\$ 68,53 15: R\$ 69,96
30: R\$ 71,36 45: R\$ 72,79 60: R\$ 74,24

16 cm
37 cm
52 cm
21 lbs



CAIXA ORG GDE BAIXA 21LTS C/TRAVA 1121

Código: Fábrika: Unidade:
33035 TRITEC UN/1
F1 F4

UN: R\$ 68,53 AV: R\$ 68,53 15: R\$ 69,96
30: R\$ 71,36 45: R\$ 72,79 60: R\$ 74,24

35cm
38cm
27lbs



CAIXA ORG MED ALTA 27LT C/TRAVA 1120

Código: Fábrika: Unidade:
44256 TRITEC UN/1
F1 F4

UN: R\$ 14,68 AV: R\$ 14,68 15: R\$ 14,98
30: R\$ 15,28 45: R\$ 15,59 60: R\$ 15,90

19 cm
27 cm
3,5 lbs

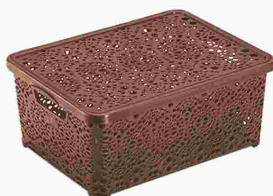

CAIXA ORG MINI MANDALA 3,5L MARROM 1892

Código: Fábrika: Unidade:
37296 MONTE LIBANO UN/1
F1 F4

UN: R\$ 14,68 AV: R\$ 14,68 15: R\$ 14,98
30: R\$ 15,28 45: R\$ 15,59 60: R\$ 15,90

19 cm
27 cm
3,5 lbs



CAIXA ORG MINI MANDALA 3,5L PRETA 1891

Código: Fábrika: Unidade:
37295 MONTE LIBANO UN/1
F1 F4

UN: R\$ 24,47 AV: R\$ 24,47 15: R\$ 24,98
30: R\$ 25,48 45: R\$ 25,99 60: R\$ 26,51



CAIXA ORG MINI PORTA TUDO C/2GAV 1217

Código: Fábrika: Unidade:
37293 MONTE LIBANO UN/1
F1 F4

UN: R\$ 62,07 AV: R\$ 62,07 15: R\$ 63,36
30: R\$ 64,63 45: R\$ 65,92 60: R\$ 67,24

22 cm



CAIXA ORG PEQ PORTA TUDO C/3GAV 1170

Código: Fábrika: Unidade:
43655 MONTE LIBANO UN/1
F1 F4

UN: R\$ 18,46 AV: R\$ 18,46 15: R\$ 18,84
30: R\$ 19,22 45: R\$ 19,60 60: R\$ 20,00

31cm
13cm
22cm



CAIXA ORG PLAST RET C/TRAVA 5LTS 6845

Código: Fábrika: Unidade:
41659 INPLAST UN/1
F1 F4

UN: R\$ 8,48 AV: R\$ 8,48 15: R\$ 8,66
30: R\$ 8,83 45: R\$ 9,01 60: R\$ 9,19



CAIXA ORG PLAST RET TRANSP 2,5 LTS 6882

Código: Fábrika: Unidade:
41657 INPLAST UN/1
F1 F4

UN: R\$ 9,18 AV: R\$ 9,18 15: R\$ 9,37
30: R\$ 9,55 45: R\$ 9,74 60: R\$ 9,94



CAIXA ORG PLAST RET TRANSP 3,7 LTS 6886

Código: Fábrika: Unidade:
41658 INPLAST UN/1
F1 F4

UN: R\$ 19,57 AV: R\$ 19,57 15: R\$ 19,98
30: R\$ 20,38 45: R\$ 20,79 60: R\$ 21,21



CAIXA ORG RATTAN 10 LTS PRETO 951895

Código: Fábrika: Unidade:
41189 PLASTSU UN/1
F1 F4

UN: R\$ 42,68 AV: R\$ 42,68 15: R\$ 43,57
30: R\$ 44,44 45: R\$ 45,33 60: R\$ 46,24

19 cm
28 cm
38 cm
15 lbs

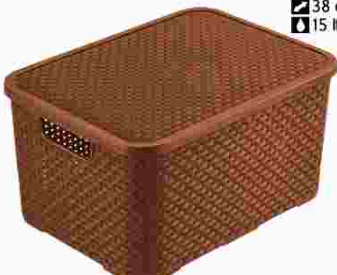

CAIXA ORG RATTAN 15LTS 1820

Código: Fábrika: Unidade:
32667 GIOTTO UN/1
F1 F4

UN: R\$ 40,15 AV: R\$ 40,15 15: R\$ 40,98
30: R\$ 41,80 45: R\$ 42,64 60: R\$ 43,49

18 cm
40 cm
28 cm
15 lbs



CAIXA ORG RATTAN 16 LTS PRETO 214PT

Código: Fábrika: Unidade:
35958 GIOTTO UN/1
F1 F4

UN: R\$ 42,68 AV: R\$ 42,68 15: R\$ 43,57
30: R\$ 44,44 45: R\$ 45,33 60: R\$ 46,24

28 cm
38 cm
15 lbs

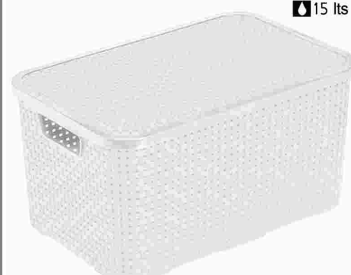

CAIXA ORG RATTAN 18LTS 38X28CM BRAN 1900

Código: Fábrika: Unidade:
37289 MONTE LIBANO UN/1
F1 F4

UN: R\$ 42,68 AV: R\$ 42,68 15: R\$ 43,57
 30: R\$ 44,44 45: R\$ 45,33 60: R\$ 46,24
 38cm
 28cm
 18lts

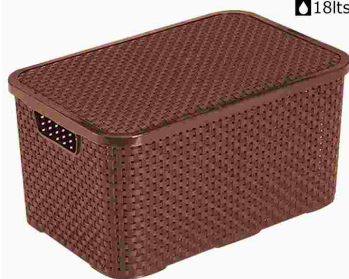

CAIXA ORG RATTAN 18LTS 38X28CM MARR 1902
 Código: Fábrica: Unidade:
37290 MONTE LIBANO UN/1
 F1 F4

UN: R\$ 42,68 AV: R\$ 42,68 15: R\$ 43,57
 30: R\$ 44,44 45: R\$ 45,33 60: R\$ 46,24
 38cm
 28cm
 18lts



CAIXA ORG RATTAN 18LTS 38X28CM PRET 1906
 Código: Fábrica: Unidade:
37288 MONTE LIBANO UN/1
 F1 F4

UN: R\$ 15,17 AV: R\$ 15,17 15: R\$ 15,48
 30: R\$ 15,79 45: R\$ 16,11 60: R\$ 16,43
 20cm
 23cm



CAIXA ORG 10LTS ALTA PRETO C/TRAVA 138
 Código: Fábrica: Unidade:
47726 FORMPLAST UN/1
 F1 F4

UN: R\$ 20,55 AV: R\$ 20,55 15: R\$ 20,98
 30: R\$ 21,40 45: R\$ 21,83 60: R\$ 22,27
 15cm
 45cm



CAIXA ORG 12LTS BAIXA PRETO C/TRAVA 8003
 Código: Fábrica: Unidade:
40358 FORMPLAST UN/1
 F1 F4

UN: R\$ 21,53 AV: R\$ 21,53 15: R\$ 21,98
 30: R\$ 22,42 45: R\$ 22,87 60: R\$ 23,33



CAIXA ORG 18LTS BAIXA PRETO C/TRAVA 134
 Código: Fábrica: Unidade:
47727 FORMPLAST UN/1
 F1 F4

UN: R\$ 25,45 AV: R\$ 25,45 15: R\$ 25,98
 30: R\$ 26,50 45: R\$ 27,03 60: R\$ 27,57
 32cm
 45cm



CAIXA ORG 30LTS ALTA PRETO C/TRAVA 132
 Código: Fábrica: Unidade:
40355 FORMPLAST UN/1
 F1 F4

UN: R\$ 39,16 AV: R\$ 39,16 15: R\$ 39,97
 30: R\$ 40,77 45: R\$ 41,59 60: R\$ 42,42
 25cm
 60cm



CAIXA ORG 34LTS REFOR PRETO C/TRAVA 128
 Código: Fábrica: Unidade:
47729 FORMPLAST UN/1
 F1 F4

UN: R\$ 60,93 AV: R\$ 60,93 15: R\$ 62,20
 30: R\$ 63,44 45: R\$ 64,71 60: R\$ 66,00
 35cm
 60cm



CAIXA ORG 50 LTS REFOR PRETO C/TRAVA 126
 Código: Fábrica: Unidade:
47730 FORMPLAST UN/1
 F1 F4

UN: R\$ 7,82 AV: R\$ 7,82 15: R\$ 7,99
 30: R\$ 8,15 45: R\$ 8,31 60: R\$ 8,48
 12cm
 32cm



CAIXA ORG 5,5LTS BAIXA PRETO C/TRAV 3093
 Código: Fábrica: Unidade:
47731 FORMPLAST UN/1
 F1 F4

UN: R\$ 32,07 AV: R\$ 32,07 15: R\$ 32,74
 30: R\$ 33,39 45: R\$ 34,06 60: R\$ 34,74



CAIXA ORGANI 20LTS PTO ALTA C/TRAVA 6123
 Código: Fábrica: Unidade:
50202 RISCHIOTO UN/1
 F1 F4

UN: R\$ 66,58 AV: R\$ 66,58 15: R\$ 67,96
 30: R\$ 69,32 45: R\$ 70,71 60: R\$ 72,12
 27cm
 46cm
 25lts



CAIXA ORGANIZADORA 25L TRAVA 0668T
 Código: Fábrica: Unidade:
19692 JAGUAR UN/1
 F1 F4

UN: R\$ 90,92 AV: R\$ 90,92 15: R\$ 92,81
 30: R\$ 94,67 45: R\$ 96,56 60: R\$ 98,49
 20cm
 66cm
 38lts



CAIXA ORGANIZADORA 38L TRAVA RODIN 2014T
 Código: Fábrica: Unidade:
47093 JAGUAR UN/1
 F1 F4

UN: R\$ 110,08 AV: R\$ 110,08 15: R\$ 112,38
 30: R\$ 114,62 45: R\$ 116,92 60: R\$ 119,25
 30cm
 59cm
 45lts

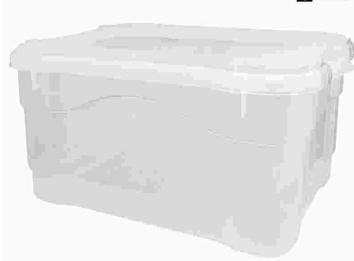

CAIXA ORGANIZADORA 45L TRAVA 0621T
 Código: Fábrica: Unidade:
13169 JAGUAR UN/1
 F1 F4

UN: R\$ 9,76 AV: R\$ 9,76 15: R\$ 9,97
 30: R\$ 10,17 45: R\$ 10,37 60: R\$ 10,58



CAIXA ORGANIZATTA 1,6LTS C/TRAVA 118
 Código: Fábrica: Unidade:
45192 RISCHIOTO UN/1
 F1 F4

UN: R\$ 12,24 AV: R\$ 12,24 15: R\$ 12,50
 30: R\$ 12,74 45: R\$ 13,00 60: R\$ 13,26



CAIXA ORGANIZATTA 3,2LTS C/TRAVA 119
 Código: Fábrica: Unidade:
45195 RISCHIOTO UN/1
 F1 F4

UN: R\$ 16,09 AV: R\$ 16,09 15: R\$ 16,42
 30: R\$ 16,75 45: R\$ 17,09 60: R\$ 17,43



CAIXA ORGANIZATTA 5LTS C/TRAVA 127
 Código: Fábrica: Unidade:
45197 RISCHIOTO UN/1
 F1 F4

UN: R\$ 20,60 AV: R\$ 20,60 15: R\$ 21,03
30: R\$ 21,45 45: R\$ 21,88 60: R\$ 22,32



CAIXA ORGANIZATTA 6LTS C/TRAVA 122
Código: Fábrica: Unidade:
45199 RISCHIOTO UN/1
F1 F4

UN: R\$ 29,65 AV: R\$ 29,65 15: R\$ 30,27
30: R\$ 30,87 45: R\$ 31,49 60: R\$ 32,12

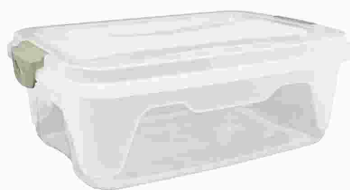

CAIXA ORGANIZATTA 10LTS C/TRAVA 121
Código: Fábrica: Unidade:
45194 RISCHI/UNIN UN/1
F1 F4

UN: R\$ 24,65 AV: R\$ 24,65 15: R\$ 25,16
30: R\$ 25,66 45: R\$ 26,18 60: R\$ 26,70

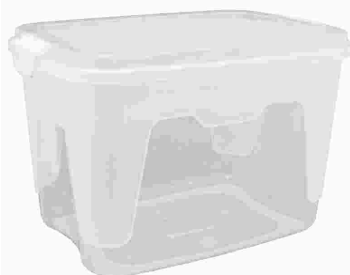

CAIXA ORGANIZATTA 12LTS C/TRAVA 124
Código: Fábrica: Unidade:
45193 RISCHIOTO UN/1
F1 F4

UN: R\$ 40,28 AV: R\$ 40,28 15: R\$ 41,12
30: R\$ 41,95 45: R\$ 42,78 60: R\$ 43,64



CAIXA ORGANIZATTA 20LTS ALTA C/TRAVA 123
Código: Fábrica: Unidade:
45200 RISCHIOTO UN/1
F1 F4

UN: R\$ 53,85 AV: R\$ 53,85 15: R\$ 54,97
30: R\$ 56,07 45: R\$ 57,19 60: R\$ 58,33

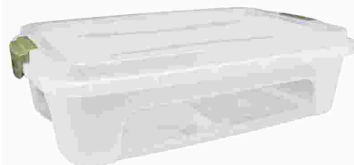

CAIXA ORGANIZATTA 20LTS C/TRAVA BAIX 115
Código: Fábrica: Unidade:
45202 RISCHIOTO UN/1
F1 F4

UN: R\$ 53,80 AV: R\$ 53,80 15: R\$ 54,92
30: R\$ 56,02 45: R\$ 57,14 60: R\$ 58,28



CAIXA ORGANIZATTA 30LTS C/TRAVA ALTA 129
Código: Fábrica: Unidade:
45201 RISCHI/UNIN UN/1
F1 F4

UN: R\$ 68,53 AV: R\$ 68,53 15: R\$ 69,96
30: R\$ 71,36 45: R\$ 72,79 60: R\$ 74,24



CAIXA ORGANIZATTA 30LTS C/TRAVA 116
Código: Fábrica: Unidade:
45212 RISCHIOTO UN/1
F1 F4

UN: R\$ 96,50 AV: R\$ 96,50 15: R\$ 98,51
30: R\$ 100,48 45: R\$ 102,49 60: R\$ 104,54
138 cm
44 cm



CAIXA ORGANIZATTA 50LTS C/TRAVA ALTA 117
Código: Fábrica: Unidade:
36976 RISCHIOTO UN/1
F1 F4

UN: R\$ 97,89 AV: R\$ 97,89 15: R\$ 99,93
30: R\$ 101,93 45: R\$ 103,97 60: R\$ 106,05



CAIXA ORGANIZATTA 56LTS C/TRAVA ALTA 364
Código: Fábrica: Unidade:
50823 UNINJET UN/1
F1 F4

UN: R\$ 141,15 AV: R\$ 141,15 15: R\$ 144,09
30: R\$ 146,97 45: R\$ 149,91 60: R\$ 152,91



CAIXA ORGANIZATTA 80LTS C/TRAVA 128
Código: Fábrica: Unidade:
45198 RISCHIOTO UN/1
F1 F4

UN: R\$ 35,24 AV: R\$ 35,24 15: R\$ 35,98
30: R\$ 36,70 45: R\$ 37,43 60: R\$ 38,18



CAIXA P/CARNE 19 LTS MULTIUSO 25X41X59CM
Código: Fábrica: Unidade:
18386 ANTARES UN/1
F1 F4

UN: R\$ 15,94 AV: R\$ 15,94 15: R\$ 16,27
30: R\$ 16,60 45: R\$ 16,93 60: R\$ 17,27
11cm
26cm
3lts



CAIXA PLAST ORG 3LTS C/TRAVA TRANSL 417
Código: Fábrica: Unidade:
44422 USUAL UN/1
F1 F4

UN: R\$ 20,16 AV: R\$ 20,16 15: R\$ 20,58
30: R\$ 20,99 45: R\$ 21,41 60: R\$ 21,84
14cm
30cm
5lts



CAIXA PLAST ORG 5LTS C/TRAVA TRANSL 414
Código: Fábrica: Unidade:
44421 USUAL UN/1
F1 F4

UN: R\$ 33,95 AV: R\$ 33,95 15: R\$ 34,66
30: R\$ 35,35 45: R\$ 36,06 60: R\$ 36,78
13cm
42cm
10lts



CAIXA PLAST ORG 10LTS C/TRAVA TRANSL 366
Código: Fábrica: Unidade:
44420 USUAL UN/1
F1 F4

UN: R\$ 47,34 AV: R\$ 47,34 15: R\$ 48,33
30: R\$ 49,30 45: R\$ 50,28 60: R\$ 51,29
25cm
42cm
20lts



CAIXA PLAST ORG 20LTS C/TRAVA TRANSL 388
Código: Fábrica: Unidade:
44419 USUAL UN/1
F1 F4

UN: R\$ 15,66 AV: R\$ 15,66 15: R\$ 15,98
30: R\$ 16,30 45: R\$ 16,63 60: R\$ 16,96
14 cm
56 cm
20 lts



CAIXA PLAST P/MASSA 20 LTS PRETA
Código: Fábrica: Unidade:
45251 MOLDE MINAS UN/1
F1 F4

UN: R\$ 23,29 AV: R\$ 23,29 15: R\$ 23,77
30: R\$ 24,25 45: R\$ 24,73 60: R\$ 25,23

Produto
* Altura: 16 cm
* Comp: 57cm
* Largura: 36 cm



CAIXA PLAST P/MASSA 22 LTS BRANCA

Código: 12905 Fábrica: ECOPLASTIC Unidade: UN/1 F1 F4

UN: R\$ 15,66 AV: R\$ 15,66 15: R\$ 15,98
30: R\$ 16,30 45: R\$ 16,63 60: R\$ 16,96



CAIXA PLAST P/MASSA 22 LTS PRETA

Código: 20662 Fábrica: ECOPLASTIC Unidade: UN/1 F1 F4

UN: R\$ 58,74 AV: R\$ 58,74 15: R\$ 59,97
30: R\$ 61,17 45: R\$ 62,39 60: R\$ 63,64



CAIXA PLAST PRETA VAZADA AGRICOLA/SUPERM

Código: 18385 Fábrica: ECOPLASTIC Unidade: UN/1 F1 F4

UN: R\$ 20,55 AV: R\$ 20,55 15: R\$ 20,98
30: R\$ 21,40 45: R\$ 21,83 60: R\$ 22,27

13cm
57,5cm
38cm



CAIXA PLAST 19 LTS P/MASSA PRETA

Código: 12117 Fábrica: ANTARES Unidade: UN/1 F1 F4

UN: R\$ 19,09 AV: R\$ 19,09 15: R\$ 19,49
30: R\$ 19,88 45: R\$ 20,28 60: R\$ 20,69

6 lts



CAIXA PLAST 6,0 LTS VERSATIL TRANSP 786

Código: 39555 Fábrica: LUMAR Unidade: UN/1 F1 F4

UN: R\$ 14,03 AV: R\$ 14,03 15: R\$ 14,32
30: R\$ 14,61 45: R\$ 14,90 60: R\$ 15,20

8cm
45cm



CAIXA PLAST 7 LTS P/FRIOS 1637

Código: 47068 Fábrica: JAGUAR Unidade: UN/1 F1 F4

UN: R\$ 137,06 AV: R\$ 137,06 15: R\$ 139,91
30: R\$ 142,71 45: R\$ 145,57 60: R\$ 148,48

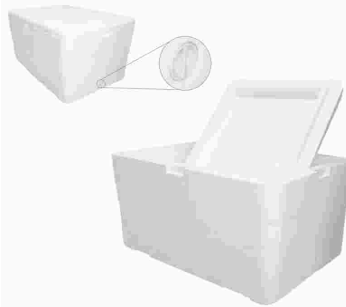

CAIXA TERMICA ISOPOR 80 LTS COM DRENO

Código: 47998 Fábrica: ISOMAX Unidade: UN/1 F1 F4

UN: R\$ 73,43 AV: R\$ 73,43 15: R\$ 74,96
30: R\$ 76,46 45: R\$ 77,99 60: R\$ 79,55



CAIXA TERMICA 16 LTS COLOR

Código: 31769 Fábrica: ANTARES Unidade: UN/1 F1 F4

UN: R\$ 117,49 AV: R\$ 117,49 15: R\$ 119,94
30: R\$ 122,34 45: R\$ 124,79 60: R\$ 127,28



CAIXA TERMICA 34 LTS COLOR

Código: 30863 Fábrica: ANTARES Unidade: UN/1 F1 F4

UN: R\$ 4,31 AV: R\$ 4,31 15: R\$ 4,40
30: R\$ 4,49 45: R\$ 4,58 60: R\$ 4,67



CAIXA VERSATIL QUADR 3,5 LTS 951

Código: 34582 Fábrica: PLASTBON Unidade: UN/1 F1 F4

UN: R\$ 4,31 AV: R\$ 4,31 15: R\$ 4,40
30: R\$ 4,49 45: R\$ 4,58 60: R\$ 4,67



CAIXA VERSATIL RED 3,5 LTS 949

Código: 34583 Fábrica: PLASTBON Unidade: UN/1 F1 F4

UN: R\$ 4,31 AV: R\$ 4,31 15: R\$ 4,40
30: R\$ 4,49 45: R\$ 4,58 60: R\$ 4,67



CAIXA VERSATIL RET 3,5 LTS 950

Código: 34574 Fábrica: PLASTBON Unidade: UN/1 F1 F4

UN: R\$ 8,07 AV: R\$ 8,07 15: R\$ 8,24
30: R\$ 8,40 45: R\$ 8,57 60: R\$ 8,74



CAIXA VERSATIL 2,5LTS RET FACILITA 6340

Código: 20696 Fábrica: RISCHIOTO Unidade: UN/1 F1 F4

UN: R\$ 9,78 AV: R\$ 9,78 15: R\$ 9,99
30: R\$ 10,19 45: R\$ 10,39 60: R\$ 10,60



CAIXA VERSATIL 3,6LTS RET FACILITTA 0120

Código: 20703 Fábrica: RISCHIOTO Unidade: UN/1 F1 F4

UN: R\$ 144,76 AV: R\$ 144,76 15: R\$ 147,77
30: R\$ 150,73 45: R\$ 153,74 60: R\$ 156,82



CALDEIRAO ALUM HOTEL ESP 32 22LTS

Código: 50714 Fábrica: ASJ Unidade: UN/1 F1 F4

UN: R\$ 195,61 AV: R\$ 195,61 15: R\$ 199,68
30: R\$ 203,67 45: R\$ 207,75 60: R\$ 211,90



CALDEIRAO ALUM HOTEL ESP 36 32LTS

Código: 50715 Fábrica: ASJ Unidade: UN/1 F1 F4

UN: R\$ 128,93 AV: R\$ 128,93 15: R\$ 131,62
30: R\$ 134,25 45: R\$ 136,93 60: R\$ 139,67



CALDEIRAO ALUM HOTEL 30 18LTS

Código: Fábrika: Unidade:
50713 ASJ UN/1
F1 F4

UN: R\$ 10,76 AV: R\$ 10,76 15: R\$ 10,99
30: R\$ 11,21 45: R\$ 11,43 60: R\$ 11,66



CANECA ALUM CHOPP

Código: Fábrika: Unidade:
14754 AVELAR UN/1
F1 F4

UN: R\$ 10,76 AV: R\$ 10,76 15: R\$ 10,99
30: R\$ 11,21 45: R\$ 11,43 60: R\$ 11,66



CANECA ALUM ESCOLAR 02 1286

Código: Fábrika: Unidade:
37527 MSR UN/1
F1 F4

UN: R\$ 24,47 AV: R\$ 24,47 15: R\$ 24,98
30: R\$ 25,48 45: R\$ 25,99 60: R\$ 26,51



CANECA ALUM LEVE 12 FRIZADO 1,0 LT

Código: Fábrika: Unidade:
11261 AVELAR UN/1
F1 F4

UN: R\$ 15,47 AV: R\$ 15,47 15: R\$ 15,79
30: R\$ 16,11 45: R\$ 16,43 60: R\$ 16,76

11 cm
350ml



CANECA ALUM 350ML CHOPP BOMDIMAIS 9012

Código: Fábrika: Unidade:
40400 UN-ART UN/1
F1 F4

UN: R\$ 15,47 AV: R\$ 15,47 15: R\$ 15,79
30: R\$ 16,11 45: R\$ 16,43 60: R\$ 16,76

11 cm
350ml



CANECA ALUM 350ML CHOPP CERVEJA GEL 9009

Código: Fábrika: Unidade:
40399 UN-ART UN/1
F1 F4

UN: R\$ 15,47 AV: R\$ 15,47 15: R\$ 15,79
30: R\$ 16,11 45: R\$ 16,43 60: R\$ 16,76

11 cm
350ml



CANECA ALUM 350ML CHOPP DRAHMA 9007

Código: Fábrika: Unidade:
40398 UN-ART UN/1
F1 F4

UN: R\$ 6,20 AV: R\$ 18,60 15: R\$ 18,98
30: R\$ 19,36 45: R\$ 19,75 60: R\$ 20,14



CANECA ESMALTADA COLOR 80ML 18151 3X1

Código: Fábrika: Unidade:
50212 WELLMIX CX/3
F1 F4

UN: R\$ 4,65 AV: R\$ 18,60 15: R\$ 18,98
30: R\$ 19,36 45: R\$ 19,75 60: R\$ 20,14



CANECA ESMALTADA COLOR 90ML 9111295 4X1

Código: Fábrika: Unidade:
39257 FRATELLI PT/4
F1 F4

UN: R\$ 11,37 AV: R\$ 68,21 15: R\$ 69,63
30: R\$ 71,02 45: R\$ 72,45 60: R\$ 73,89



CANECA ESMALTADA PRETO 350ML 18149 6X1

Código: Fábrika: Unidade:
50210 WELLMIX CX/6
F1 F4

UN: R\$ 11,37 AV: R\$ 68,21 15: R\$ 69,63
30: R\$ 71,02 45: R\$ 72,45 60: R\$ 73,89



CANECA ESMALTADA VERMELH 350ML 18150 6X1

Código: Fábrika: Unidade:
50211 WELLMIX CX/6
F1 F4

UN: R\$ 20,55 AV: R\$ 20,55 15: R\$ 20,98
30: R\$ 21,40 45: R\$ 21,83 60: R\$ 22,27



CANECA ESMALTADA 8CM 7017

Código: Fábrika: Unidade:
43592 KEY UN/1
F1 F4

UN: R\$ 156,28 AV: R\$ 156,28 15: R\$ 159,54
30: R\$ 162,73 45: R\$ 165,98 60: R\$ 169,30



CANECA INOX TERM 710ML AZUL 14043

Código: Fábrika: Unidade:
40667 INGA UN/1
F1 F4

UN: R\$ 156,28 AV: R\$ 156,28 15: R\$ 159,54
30: R\$ 162,73 45: R\$ 165,98 60: R\$ 169,30



CANECA INOX TERM 710ML BRANCO 14044

Código: Fábrika: Unidade:
40666 INGA UN/1
F1 F4

UN: R\$ 156,28 AV: R\$ 156,28 15: R\$ 159,54
30: R\$ 162,73 45: R\$ 165,98 60: R\$ 169,30



CANECA INOX TERM 710ML CINZA 14042

Código: Fábrika: Unidade:
40669 INGA UN/1
F1 F4

UN: R\$ 156,28 AV: R\$ 156,28 15: R\$ 159,54
30: R\$ 162,73 45: R\$ 165,98 60: R\$ 169,30



CANECA INOX TERM 710ML PRETO 14041

Código: Fábrika: Unidade:
40668 INGA UN/1
F1 F4

UN: R\$ 38,19 AV: R\$ 38,19 15: R\$ 38,98
30: R\$ 39,76 45: R\$ 40,56 60: R\$ 41,37



CANECA INOX 350ML LATINHA 14022
Código: Fábrika: Unidade:
40317 WINCY UN/1
F1 F4

UN: R\$ 48,95 AV: R\$ 48,95 15: R\$ 49,97
30: R\$ 50,97 45: R\$ 51,99 60: R\$ 53,03



CANECA METAL INOX 300ML CRUZEIRO 10716
Código: Fábrika: Unidade:
41112 BRASFOOT UN/1
F1 F4

UN: R\$ 2,24 AV: R\$ 2,24 15: R\$ 2,29
30: R\$ 2,33 45: R\$ 2,38 60: R\$ 2,43



CANECA PLAST C/ALCA 300 ML CORES
Código: Fábrika: Unidade:
45926 ANTARES UN/1
F1 F4

UN: R\$ 4,40 AV: R\$ 4,40 15: R\$ 4,49
30: R\$ 4,58 45: R\$ 4,67 60: R\$ 4,76



CANECA PLAST DEC 430ML INFANTIL 1403
Código: Fábrika: Unidade:
40130 KOZI PLAST UN/1
F1 F4

UN: R\$ 1,63 AV: R\$ 4,89 15: R\$ 4,99
30: R\$ 5,09 45: R\$ 5,19 60: R\$ 5,29



CANECA PLAST ESC 250 ML KIT 3 PCS 4013
Código: Fábrika: Unidade:
7204 SBRISSA CJ/3
F1 F4

UN: R\$ 2,37 AV: R\$ 28,39 15: R\$ 28,98
30: R\$ 29,56 45: R\$ 30,15 60: R\$ 30,75



CANECA PLAST ESC 270 ML DEC 8016 12X1
Código: Fábrika: Unidade:
35222 SBRISSA PT/12
F1 F4

UN: R\$ 2,59 AV: R\$ 2,59 15: R\$ 2,59
30: R\$ 2,59 45: R\$ 2,59 60: R\$ 2,59



CANECA PLAST ESCOLAR 300 ML 105
Código: Fábrika: Unidade:
22324 ECOPLASTIC UN/1
F1 F4

UN: R\$ 20,17 AV: R\$ 40,34 15: R\$ 41,18
30: R\$ 42,01 45: R\$ 42,85 60: R\$ 43,70

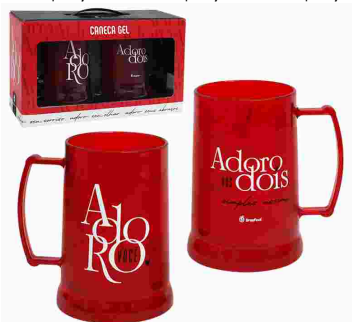

CANECA PLAST GEL 300ML ADORO 11641 2X1
Código: Fábrika: Unidade:
41125 BRASFOOT CJ/2
F1 F4

UN: R\$ 26,43 AV: R\$ 26,43 15: R\$ 26,98
30: R\$ 27,52 45: R\$ 28,07 60: R\$ 28,63



CANECA PLAST GEL 300ML BOMDIMAIS 3961
Código: Fábrika: Unidade:
39126 BRASFOOT UN/1
F1 F4

UN: R\$ 22,51 AV: R\$ 22,51 15: R\$ 22,98
30: R\$ 23,44 45: R\$ 23,91 60: R\$ 24,39



CANECA PLAST GEL 300ML DRAHMA 3863
Código: Fábrika: Unidade:
39127 BRASFOOT UN/1
F1 F4

UN: R\$ 26,43 AV: R\$ 26,43 15: R\$ 26,98
30: R\$ 27,52 45: R\$ 28,07 60: R\$ 28,63



CANECA PLAST GEL 300ML HARLEY DAVI 2933
Código: Fábrika: Unidade:
39130 BRASFOOT UN/1
F1 F4

UN: R\$ 20,17 AV: R\$ 40,34 15: R\$ 41,18
30: R\$ 42,01 45: R\$ 42,85 60: R\$ 43,70



CANECA PLAST GEL 300ML VC ME F 11619 2X1
Código: Fábrika: Unidade:
41124 BRASFOOT CJ/2
F1 F4

UN: R\$ 44,05 AV: R\$ 44,05 15: R\$ 44,97
30: R\$ 45,87 45: R\$ 46,79 60: R\$ 47,72



CANECA PLAST TERMICA 450ML PAI IDOLO 05
Código: Fábrika: Unidade:
39271 BRASFOOT UN/1
F1 F4

UN: R\$ 5,33 AV: R\$ 5,33 15: R\$ 5,44
30: R\$ 5,55 45: R\$ 5,66 60: R\$ 5,77



CANECA PLAST 270 ML COLOR 617
Código: Fábrika: Unidade:
38661 TRITEC UN/1
F1 F4

UN: R\$ 2,86 AV: R\$ 2,86 15: R\$ 2,92
30: R\$ 2,98 45: R\$ 3,04 60: R\$ 3,10



CANECA PLAST 310ML COLOR 623
Código: Fábrika: Unidade:
44082 QUALYPLAS UN/1
F1 F4

UN: R\$ 3,59 AV: R\$ 21,53 15: R\$ 21,98
30: R\$ 22,42 45: R\$ 22,87 60: R\$ 23,33



CANECA PLAST 400 ML C/ ALCA 7000 6X1
Código: Fábrika: Unidade:
33895 SBRISSA CJ/6
F1 F4

UN: R\$ 5,80 AV: R\$ 34,80 15: R\$ 35,53
30: R\$ 36,24 45: R\$ 36,96 60: R\$ 37,70



CANECA PLAST 400 ML C/ALCA DEC 8022 6X1
Código: Fábrika: Unidade:
35223 SBRISSA PT/6
F1 F4

UN: R\$ 7,82 AV: R\$ 7,82 15: R\$ 7,99
30: R\$ 8,15 45: R\$ 8,31 60: R\$ 8,48



CANECA PLAST 450ML SORT P/FREEZER/MIC 47
Código: Fábrika: Unidade:
40989 PLASTIBRASIL UN/1
F1 F4

UN: R\$ 12,72 AV: R\$ 12,72 15: R\$ 12,98
30: R\$ 13,24 45: R\$ 13,51 60: R\$ 13,78



CANECA PORC 220 ML CACHORRO 13
Código: Fábrika: Unidade:
44345 PORCELANASLU UN/1
F1 F4

UN: R\$ 12,72 AV: R\$ 12,72 15: R\$ 12,98
30: R\$ 13,24 45: R\$ 13,51 60: R\$ 13,78



CANECA PORC 220 ML CAFE/COFFEE 13
Código: Fábrika: Unidade:
37247 PORCELANASLU UN/1
F1 F4

UN: R\$ 12,72 AV: R\$ 12,72 15: R\$ 12,98
30: R\$ 13,24 45: R\$ 13,51 60: R\$ 13,78



CANECA PORC 220 ML CARROS 13
Código: Fábrika: Unidade:
37246 PORCELANASLU UN/1
F1 F4

UN: R\$ 12,72 AV: R\$ 12,72 15: R\$ 12,98
30: R\$ 13,24 45: R\$ 13,51 60: R\$ 13,78



CANECA PORC 220 ML CHOCOLATE 13
Código: Fábrika: Unidade:
44350 PORCELANASLU UN/1
F1 F4

UN: R\$ 12,72 AV: R\$ 12,72 15: R\$ 12,98
30: R\$ 13,24 45: R\$ 13,51 60: R\$ 13,78



CANECA PORC 220 ML GATO 13
Código: Fábrika: Unidade:
44344 PORCELANASLU UN/1
F1 F4

UN: R\$ 12,72 AV: R\$ 12,72 15: R\$ 12,98
30: R\$ 13,24 45: R\$ 13,51 60: R\$ 13,78



CANECA PORC 220 ML MEME BENTO 13
Código: Fábrika: Unidade:
44342 PORCELANASLU UN/1
F1 F4

UN: R\$ 14,05 AV: R\$ 14,05 15: R\$ 14,34
30: R\$ 14,63 45: R\$ 14,92 60: R\$ 15,22



CANECA PORC 220 ML PAI 13
Código: Fábrika: Unidade:
37244 PORCELANASLU UN/1
F1 F4

UN: R\$ 12,72 AV: R\$ 12,72 15: R\$ 12,98
30: R\$ 13,24 45: R\$ 13,51 60: R\$ 13,78



CANECA PORC 220 ML PERIGO 13
Código: Fábrika: Unidade:
44346 PORCELANASLU UN/1
F1 F4

UN: R\$ 13,06 AV: R\$ 156,66 15: R\$ 159,93
30: R\$ 163,12 45: R\$ 166,39 60: R\$ 169,71



CANECA PORC 270ML DEC 778 12X1
Código: Fábrika: Unidade:
41433 OXFORD CJ/12
F1 F4

UN: R\$ 13,06 AV: R\$ 156,66 15: R\$ 159,93
30: R\$ 163,12 45: R\$ 166,39 60: R\$ 169,71



CANECA PORC 270ML LISA PTO/BCO 777 12X1
Código: Fábrika: Unidade:
41434 OXFORD CX/12
F1 F4

UN: R\$ 32,30 AV: R\$ 32,30 15: R\$ 32,98
30: R\$ 33,64 45: R\$ 34,31 60: R\$ 35,00



CANECA PORC 360 ML MEU GAME FORT 2955
Código: Fábrika: Unidade:
38995 BRASFOOT UN/1
F1 F4

UN: R\$ 32,30 AV: R\$ 32,30 15: R\$ 32,98
30: R\$ 33,64 45: R\$ 34,31 60: R\$ 35,00



CANECA PORC 360 ML MEU GAME MINE 2567
Código: Fábrika: Unidade:
39010 BRASFOOT UN/1
F1 F4

UN: R\$ 32,30 AV: R\$ 32,30 15: R\$ 32,98
30: R\$ 33,64 45: R\$ 34,31 60: R\$ 35,00



CANECA PORC 360 ML URBAN DIRIGE SEU 5836
Código: Fábrika: Unidade:
39110 BRASFOOT UN/1
F1 F4

UN: R\$ 32,30 AV: R\$ 32,30 15: R\$ 32,98
30: R\$ 33,64 45: R\$ 34,31 60: R\$ 35,00



CANECA PORC 360 ML URBAN O MUNDO 2790
Código: Fábrika: Unidade:
39104 BRASFOOT UN/1
F1 F4

UN: R\$ 32,30 AV: R\$ 32,30 15: R\$ 32,98
30: R\$ 33,64 45: R\$ 34,31 60: R\$ 35,00



CANECA PORC 360ML URBAN ADORO NOS 11494
Código: Fábrika: Unidade:
41134 BRASFOOT UN/1
F1 F4

UN: R\$ 32,30 AV: R\$ 32,30 15: R\$ 32,98
30: R\$ 33,64 45: R\$ 34,31 60: R\$ 35,00



CANECA PORC 360ML URBAN AMIGAS 10041
Código: Fábrika: Unidade:
39111 BRASFOOT UN/1
F1 F4

UN: R\$ 34,26 AV: R\$ 34,26 15: R\$ 34,98
30: R\$ 35,68 45: R\$ 36,39 60: R\$ 37,12



CANECA PORC 360ML URBAN ATLETICO 1627
Código: Fábrika: Unidade:
39113 BRASFOOT UN/1
F1 F4

UN: R\$ 32,30 AV: R\$ 32,30 15: R\$ 32,98
30: R\$ 33,64 45: R\$ 34,31 60: R\$ 35,00



CANECA PORC 360ML URBAN VC ME FAZ 11325
Código: Fábrika: Unidade:
41135 BRASFOOT UN/1
F1 F4

UN: R\$ 8,16 AV: R\$ 48,95 15: R\$ 49,97
30: R\$ 50,97 45: R\$ 51,99 60: R\$ 53,03



CANECA PORCELANA 50ML DECOR 6X1
Código: Fábrika: Unidade:
42804 INTERPONTE CX/6
F1 F4

UN: R\$ 33,78 AV: R\$ 33,78 15: R\$ 34,49
30: R\$ 35,18 45: R\$ 35,88 60: R\$ 36,60



CANECA TERMICA INOX 340ML TRIANGLE 16015
Código: Fábrika: Unidade:
40319 WINCY UN/1
F1 F4

UN: R\$ 38,19 AV: R\$ 38,19 15: R\$ 38,98
30: R\$ 39,76 45: R\$ 40,56 60: R\$ 41,37



CANECA TERMICA INOX 500ML C/TAMPA 1401
Código: Fábrika: Unidade:
40318 WINCY UN/1
F1 F4

UN: R\$ 6,45 AV: R\$ 38,72 15: R\$ 39,52
30: R\$ 40,31 45: R\$ 41,12 60: R\$ 41,94



CANECA VIDRO 100ML CANADA 016 6X1
Código: Fábrika: Unidade:
49432 RIOHOME CJ/6
F1 F4

UN: R\$ 7,39 AV: R\$ 44,36 15: R\$ 45,28
30: R\$ 46,19 45: R\$ 47,11 60: R\$ 48,05



CANECA VIDRO 255ML TRANSP LISA VD24 6X1
Código: Fábrika: Unidade:
40294 MAXXIMUS CJ/6
F1 F4

UN: R\$ 6,97 AV: R\$ 334,44 15: R\$ 341,40
30: R\$ 348,23 45: R\$ 355,20 60: R\$ 362,30



CANECA VIDRO 268ML NOVO 1070 48X1
Código: Fábrika: Unidade:
39523 MULTIPRESENT CX/48
F1 F4

UN: R\$ 21,53 AV: R\$ 21,53 15: R\$ 21,98
30: R\$ 22,42 45: R\$ 22,87 60: R\$ 23,33



CANECA VIDRO 370 ML CHOPP 057 2X1
Código: Fábrika: Unidade:
49395 RIOHOME CJ/1
F1 F4

UN: R\$ 57,76 AV: R\$ 57,76 15: R\$ 58,97
30: R\$ 60,15 45: R\$ 61,35 60: R\$ 62,58



CANECAO ALUM BAT FUND 16 CB MAD 2L 1519
Código: Fábrika: Unidade:
37449 MSR UN/1
F1 F4

UN: R\$ 9,50 AV: R\$ 9,50 15: R\$ 9,70
30: R\$ 9,89 45: R\$ 10,09 60: R\$ 10,29



CANECAO ALUM CHOPP 10 667
Código: Fábrika: Unidade:
22732 MSR UN/1
F1 F4

UN: R\$ 37,20 AV: R\$ 37,20 15: R\$ 37,97
30: R\$ 38,73 45: R\$ 39,51 60: R\$ 40,30



CANECAO ALUM CRAQUEADO 14 CB MAD 1,9 LT
Código: Fábrika: Unidade:
34761 AVELAR UN/1
F1 F4

UN: R\$ 24,47 AV: R\$ 24,47 15: R\$ 24,98
30: R\$ 25,48 45: R\$ 25,99 60: R\$ 26,51



CANECAO ALUM EXTRA 12 CB MAD 1,0 LT 661
Código: Fábrika: Unidade:
10438 MSR UN/1
F1 F4

UN: R\$ 28,39 AV: R\$ 28,39 15: R\$ 28,98
30: R\$ 29,56 45: R\$ 30,15 60: R\$ 30,75



CANECAO ALUM EXTRA 14 CB MAD 1,5 LTS 662
Código: Fábrika: Unidade:
24370 MSR UN/1
F1 F4

UN: R\$ 31,32 AV: R\$ 31,32 15: R\$ 31,98
30: R\$ 32,62 45: R\$ 33,27 60: R\$ 33,93



CANEAÇO ALUM EXTRA 16 CB MAD 2,0 LTS 658
Código: Fábrica: Unidade:
24369 MSR UN/1
F1 F4

UN: R\$ 37,20 AV: R\$ 37,20 15: R\$ 37,97
30: R\$ 38,73 45: R\$ 39,51 60: R\$ 40,30



CANEAÇO ALUM EXTRA 18 CB MAD 2,5 LTS 659
Código: Fábrica: Unidade:
24368 MSR UN/1
F1 F4

UN: R\$ 35,24 AV: R\$ 35,24 15: R\$ 35,98
30: R\$ 36,70 45: R\$ 37,43 60: R\$ 38,18



CANEAÇO ALUM EXTRA 20 CB MAD 660
Código: Fábrica: Unidade:
24367 MSR UN/1
F1 F4

UN: R\$ 24,47 AV: R\$ 24,47 15: R\$ 24,98
30: R\$ 25,48 45: R\$ 25,99 60: R\$ 26,51



CANEAÇO ALUM LEVE JAPONES 2,0 LTS
Código: Fábrica: Unidade:
27598 AVELAR UN/1
F1 F4

UN: R\$ 18,60 AV: R\$ 18,60 15: R\$ 18,98
30: R\$ 19,36 45: R\$ 19,75 60: R\$ 20,14



CANEAÇO ALUM LEVE 14 CB BAQ 1,5 LTS 672
Código: Fábrica: Unidade:
35255 MSR UN/1
F1 F4

UN: R\$ 24,47 AV: R\$ 24,47 15: R\$ 24,98
30: R\$ 25,48 45: R\$ 25,99 60: R\$ 26,51



CANEAÇO ALUM LEVE 16 1,9 LTS
Código: Fábrica: Unidade:
5891 AVELAR UN/1
F1 F4

UN: R\$ 34,26 AV: R\$ 34,26 15: R\$ 34,98
30: R\$ 35,68 45: R\$ 36,39 60: R\$ 37,12



CANEAÇO ALUM LUXO FORTE 18 CB BAQ 1130
Código: Fábrica: Unidade:
35037 MSR UN/1
F1 F4

UN: R\$ 36,72 AV: R\$ 36,72 15: R\$ 37,49
30: R\$ 38,23 45: R\$ 39,00 60: R\$ 39,78



CANEAÇO ALUM LUXO FORTE 20 CB BAQ 898
Código: Fábrica: Unidade:
35036 MSR UN/1
F1 F4

UN: R\$ 22,51 AV: R\$ 22,51 15: R\$ 22,98
30: R\$ 23,44 45: R\$ 23,91 60: R\$ 24,39



CANEAÇO ALUM LUXO 12 CB BAQ 1,0LT 664
Código: Fábrica: Unidade:
25305 MSR UN/1
F1 F4

UN: R\$ 24,47 AV: R\$ 24,47 15: R\$ 24,98
30: R\$ 25,48 45: R\$ 25,99 60: R\$ 26,51



CANEAÇO ALUM LUXO 14 CB BAQ 1,5LT 663
Código: Fábrica: Unidade:
24371 MSR UN/1
F1 F4

UN: R\$ 25,45 AV: R\$ 25,45 15: R\$ 25,98
30: R\$ 26,50 45: R\$ 27,03 60: R\$ 27,57



CANEAÇO ALUM LUXO 16 CB BAQ 2L 665
Código: Fábrica: Unidade:
24372 MSR UN/1
F1 F4

UN: R\$ 50,73 AV: R\$ 50,73 15: R\$ 51,79
30: R\$ 52,83 45: R\$ 53,88 60: R\$ 54,96



CANEAÇO ALUM TEFLON 14 CB BAQ 1425
Código: Fábrica: Unidade:
45283 MSR UN/1
F1 F4

UN: R\$ 24,47 AV: R\$ 24,47 15: R\$ 24,98
30: R\$ 25,48 45: R\$ 25,99 60: R\$ 26,51



CANEAÇO ALUM LEVE BOJUDO 2,7 LTS
Código: Fábrica: Unidade:
5892 AVELAR UN/1
F1 F4

UN: R\$ 2,20 AV: R\$ 2,20 15: R\$ 2,25
30: R\$ 2,29 45: R\$ 2,34 60: R\$ 2,39



CANECO PLAST 040
Código: Fábrica: Unidade:
10962 HM UTILIDADE UN/1
F1 F4

UN: R\$ 29,37 AV: R\$ 29,37 15: R\$ 29,98
30: R\$ 30,58 45: R\$ 31,19 60: R\$ 31,81



CANIVETE LAMINA ESTREITA 80X14MM 6326
Código: Fábrica: Unidade:
41349 CORNETA UN/1
F1 F4

UN: R\$ 0,21 AV: R\$ 20,99 15: R\$ 21,43
30: R\$ 21,86 45: R\$ 22,30 60: R\$ 22,74



CANUDO PAPEL 19,7X0,6CM BRANCO 100X1
Código: Fábrica: Unidade:
46909 VMP CX/100
F1 F4

UN: R\$ 0,19 AV: R\$ 4,85 15: R\$ 4,95
30: R\$ 5,05 45: R\$ 5,15 60: R\$ 5,25

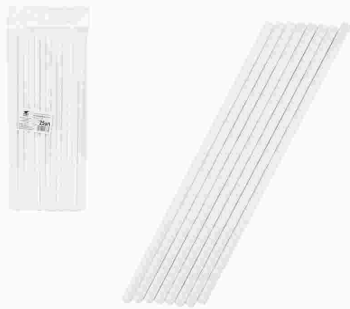

CANUDO PAPEL 19,7X0,6CM BRANCO 25X1
Código: Fábrica: Unidade:
46907 VMP PT/25
F1 F4

UN: R\$ 0,19 AV: R\$ 4,85 15: R\$ 4,95
30: R\$ 5,05 45: R\$ 5,15 60: R\$ 5,25



CANUDO PAPEL 19,7X0,6CM ROSA 25X1
Código: Fábrica: Unidade:
46908 VMP PT/25
F1 F4

UN: R\$ 0,10 AV: R\$ 2,44 15: R\$ 2,49
30: R\$ 2,54 45: R\$ 2,59 60: R\$ 2,64



CANUDO PAPEL 19,7X0,8CM BRANCO 5067 25X1
Código: Fábrica: Unidade:
47902 CASITA PT/25
F1 F4

UN: R\$ 0,12 AV: R\$ 11,74 15: R\$ 11,99
30: R\$ 12,22 45: R\$ 12,47 60: R\$ 12,72



CANUDO PLAST LISO FLEXIVEL COLOR 100X1
Código: Fábrica: Unidade:
50420 PLAZAPEL PT/100
F1 F4

UN: R\$ 0,14 AV: R\$ 21,42 15: R\$ 21,86
30: R\$ 22,30 45: R\$ 22,74 60: R\$ 23,20



CANUDO PLAST MILK S 8X21CM EMB IND 150X1
Código: Fábrica: Unidade:
47651 JACARE PT/150
F1 F4

UN: R\$ 0,10 AV: R\$ 9,69 15: R\$ 9,90
30: R\$ 10,09 45: R\$ 10,30 60: R\$ 10,50



CANUDO PLAST VITAMI 6X21CM EMB IND 100X1
Código: Fábrica: Unidade:
47652 PLASTSUL PT/100
F1 F4

UN: R\$ 6,36 AV: R\$ 6,36 15: R\$ 6,49
30: R\$ 6,62 45: R\$ 6,75 60: R\$ 6,88



CANUDO PLASTICO 21CM 65074 100X1
Código: Fábrica: Unidade:
33209 PLASTSU/SHOK PT/1
F1 F4

UN: R\$ 12,53 AV: R\$ 12,53 15: R\$ 12,79
30: R\$ 13,05 45: R\$ 13,31 60: R\$ 13,58



CAPA ALMOFADA PANO INF 34X34CM FRENT EST
Código: Fábrica: Unidade:
40450 SUN WELLS UN/1
F1 F4

UN: R\$ 12,72 AV: R\$ 12,72 15: R\$ 12,98
30: R\$ 13,24 45: R\$ 13,51 60: R\$ 13,78



CAPA P/BOTJIAO UNIVERSAL 13 KG
Código: Fábrica: Unidade:
7771 FERREIRA UN/1
F1 F4

UN: R\$ 2,94 AV: R\$ 2,94 15: R\$ 3,00
30: R\$ 3,06 45: R\$ 3,12 60: R\$ 3,18



CAPA P/FILTRO 15124
Código: Fábrica: Unidade:
35113 SATYAM UN/1
F1 F4

UN: R\$ 46,90 AV: R\$ 46,90 15: R\$ 47,88
30: R\$ 48,84 45: R\$ 49,82 60: R\$ 50,81



CAPA P/MAQUINA LAVAR NAPA REFOR ATE11 KG
Código: Fábrica: Unidade:
11339 FERREIRA UN/1
F1 F4

UN: R\$ 7,82 AV: R\$ 7,82 15: R\$ 7,99
30: R\$ 8,15 45: R\$ 8,31 60: R\$ 8,48



CAPA P/TAMPA DE FOGAO 4 BOCAS 52X52CM
Código: Fábrica: Unidade:
39277 FERREIRA UN/1
F1 F4

UN: R\$ 10,76 AV: R\$ 10,76 15: R\$ 10,99
30: R\$ 11,21 45: R\$ 11,43 60: R\$ 11,66



CAPA P/TAMPA DE FOGAO 6 BOCAS 52X81CM
Código: Fábrica: Unidade:
11338 FERREIRA UN/1
F1 F4

UN: R\$ 6,92 AV: R\$ 6,92 15: R\$ 7,07
30: R\$ 7,21 45: R\$ 7,35 60: R\$ 7,50



CARRETILHA INOX 20,8CM P/MASSAS 064
Código: Fábrica: Unidade:
47333 NIX UN/1
F1 F4

UN: R\$ 28,39 AV: R\$ 28,39 15: R\$ 28,98
30: R\$ 29,56 45: R\$ 30,15 60: R\$ 30,75



CARRIOLA PL CRISANTEMO CAFE 2390
Código: Fábrica: Unidade:
37143 PAIOL UN/1
F1 F4

UN: R\$ 28,39 AV: R\$ 28,39 15: R\$ 28,98
30: R\$ 29,56 45: R\$ 30,15 60: R\$ 30,75



CARRIOLA PL MADEIRA ENVELHECIDA P 5074-2
Código: Fábrica: Unidade:
41403 PAIOL UN/1
F1 F4

UN: R\$ 34,26 AV: R\$ 34,26 15: R\$ 34,98
30: R\$ 35,68 45: R\$ 36,39 60: R\$ 37,12
↑ 15,5 cm
↔ 44 cm



CARRIOLA PL 2 VIOLETAS CAFE 0126

Código: Fábrica: Unidade:
37141 PAIOL UN/1
F1 F4

UN: R\$ 12,72 AV: R\$ 12,72 15: R\$ 12,98
30: R\$ 13,24 45: R\$ 13,51 60: R\$ 13,78



CASCA DE PINUS PO 1 KG

Código: Fábrica: Unidade:
22288 VITAPLAN PT/1
F1 F4

UN: R\$ 6,84 AV: R\$ 6,84 15: R\$ 6,99
30: R\$ 7,13 45: R\$ 7,27 60: R\$ 7,41



CASCA DE PINUS 300 GRs

Código: Fábrica: Unidade:
27463 NOVATROPICAL PT/1
F1 F4

UN: R\$ 26,43 AV: R\$ 26,43 15: R\$ 26,98
30: R\$ 27,52 45: R\$ 28,07 60: R\$ 28,63
↑ 38 cm
↔ 16 cm



CASINHA PLANTA GDE CAFE 130

Código: Fábrica: Unidade:
37146 PAIOL UN/1
F1 F4

UN: R\$ 48,95 AV: R\$ 48,95 15: R\$ 49,97
30: R\$ 50,97 45: R\$ 51,99 60: R\$ 53,03
↑ 52 cm
↔ 23 cm



CASINHA PLANTA 2 ANDARES CAFE 0392

Código: Fábrica: Unidade:
37145 PAIOL UN/1
F1 F4

UN: R\$ 39,16 AV: R\$ 39,16 15: R\$ 39,97
30: R\$ 40,77 45: R\$ 41,59 60: R\$ 42,42
↑ 40 cm
↔ 27 cm



CASINHA PLANTA 2 VIOLETAS CAFE 2460

Código: Fábrica: Unidade:
37147 PAIOL UN/1
F1 F4

UN: R\$ 68,53 AV: R\$ 68,53 15: R\$ 69,96
30: R\$ 71,36 45: R\$ 72,79 60: R\$ 74,24
↑ 77 cm
↔ 24 cm



CASINHA PLANTA 3 ANDARES CAFE 0404

Código: Fábrica: Unidade:
37144 PAIOL UN/1
F1 F4

UN: R\$ 21,53 AV: R\$ 21,53 15: R\$ 21,98
30: R\$ 22,42 45: R\$ 22,87 60: R\$ 23,33
↑ 33cm
↑ 10,5cm
↔ 23,5cm



CESTA CAFE MANHA KRAFT 23,5X33X10,5CM UN

Código: Fábrica: Unidade:
44233 PFEIFER UN/1
F1 F4

UN: R\$ 9,01 AV: R\$ 9,01 15: R\$ 9,20
30: R\$ 9,38 45: R\$ 9,57 60: R\$ 9,76
↑ 19cm
↔ 11cm



CESTA FRALDEIRA 11CM RED PINUS 8940

Código: Fábrica: Unidade:
50819 PAIOL UN/1
F1 F4

UN: R\$ 9,99 AV: R\$ 9,99 15: R\$ 10,20
30: R\$ 10,40 45: R\$ 10,61 60: R\$ 10,82
↑ 21cm
↔ 13cm



CESTA FRALDEIRA 13CM RED PINUS 8941

Código: Fábrica: Unidade:
50820 PAIOL UN/1
F1 F4

UN: R\$ 11,02 AV: R\$ 11,02 15: R\$ 11,25
30: R\$ 11,47 45: R\$ 11,70 60: R\$ 11,93
↑ 23cm
↔ 15cm



CESTA FRALDEIRA 15CM RED PINUS 8942

Código: Fábrica: Unidade:
50821 PAIOL UN/1
F1 F4

UN: R\$ 12,34 AV: R\$ 12,34 15: R\$ 12,60
30: R\$ 12,85 45: R\$ 13,10 60: R\$ 13,37
↑ 27cm
↔ 18cm



CESTA FRALDEIRA 18CM RED PINUS 8943

Código: Fábrica: Unidade:
41297 PAIOL UN/1
F1 F4

UN: R\$ 20,19 AV: R\$ 20,19 15: R\$ 20,61
30: R\$ 21,02 45: R\$ 21,44 60: R\$ 21,87
↑ 31cm
↔ 25cm



CESTA FRALDEIRA 25CM RED PINUS 8944

Código: Fábrica: Unidade:
41298 PAIOL UN/1
F1 F4

UN: R\$ 24,11 AV: R\$ 24,11 15: R\$ 24,61
30: R\$ 25,10 45: R\$ 25,60 60: R\$ 26,12
↑ 37cm
↔ 30cm



CESTA FRALDEIRA 30CM RED PINUS 8945

Código: Fábrica: Unidade:
41299 PAIOL UN/1
F1 F4

UN: R\$ 28,39 AV: R\$ 28,39 15: R\$ 28,98
30: R\$ 29,56 45: R\$ 30,15 60: R\$ 30,75
↑ 32 cm
↔ 31 cm



CESTA VIME RED PEQ 5081

Código: Fábrica: Unidade:
40611 PAIOL UN/1
F1 F4

UN: R\$ 6,49 AV: R\$ 6,49 15: R\$ 6,49
30: R\$ 6,49 45: R\$ 6,49 60: R\$ 6,49
↑ 25cm
↔ 24cm



CESTO PAPELEIRO TELADO QUAD PTO 24X24CM

Código: Fábrica: Unidade:
32922 SHANGRILA UN/1
F1 F4

UN: R\$ 6,49 AV: R\$ 6,49 15: R\$ 6,49
30: R\$ 6,49 45: R\$ 6,49 60: R\$ 6,49

1 24cm
2 30cm



CESTO PAPELEIRO TELADO RED PTO 23X30CM

Código: Fábrica: Unidade:
32923 SHANGRILA UN/1
F1 F4

UN: R\$ 86,59 AV: R\$ 86,59 15: R\$ 88,39
30: R\$ 90,16 45: R\$ 91,97 60: R\$ 93,81

1 52cm
2 75cm
3 60lts



CESTO PLAST BASIC 60 LTS ECO 3081/79

Código: Fábrica: Unidade:
49172 JAGUAR UN/1
F1 F4

UN: R\$ 69,51 AV: R\$ 69,51 15: R\$ 70,96
30: R\$ 72,38 45: R\$ 73,83 60: R\$ 75,31

1 55cm
2 63cm
3 95lts



CESTO PLAST FECHADO COLOR 95 LTS 6862

Código: Fábrica: Unidade:
41663 INPLAST UN/1
F1 F4

UN: R\$ 14,51 AV: R\$ 14,51 15: R\$ 14,81
30: R\$ 15,11 45: R\$ 15,41 60: R\$ 15,72

1 5,5cm
2 34,4cm
3 11cm

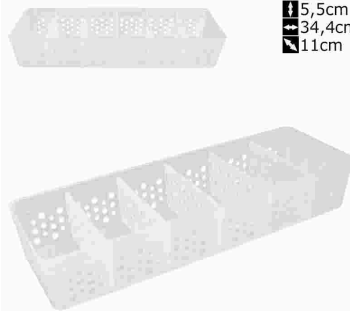

CESTO PLAST GDE C/5 DIV TRANSL 760

Código: Fábrica: Unidade:
44428 USUAL UN/1
F1 F4

UN: R\$ 21,02 AV: R\$ 21,02 15: R\$ 21,46
30: R\$ 21,89 45: R\$ 22,33 60: R\$ 22,78

1 6cm
2 34,4cm
3 17cm

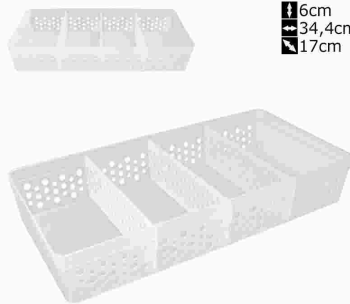

CESTO PLAST MAXI C/3 DIV TRANSL 796

Código: Fábrica: Unidade:
44429 USUAL UN/1
F1 F4

UN: R\$ 10,04 AV: R\$ 10,04 15: R\$ 10,25
30: R\$ 10,45 45: R\$ 10,66 60: R\$ 10,87

1 6cm
2 24,4cm
3 19cm



CESTO PLAST MED 24,2X19,6,5CM PRETO 617

Código: Fábrica: Unidade:
44430 USUAL UN/1
F1 F4

UN: R\$ 3,75 AV: R\$ 3,75 15: R\$ 3,83
30: R\$ 3,91 45: R\$ 3,98 60: R\$ 4,06

1 6cm
2 8,5cm
3 11cm

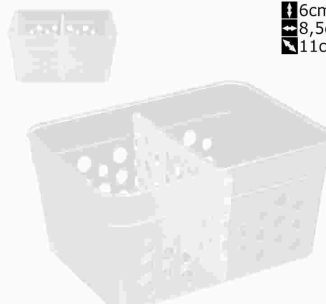

CESTO PLAST MINI C/1 DIV TRANSL 757

Código: Fábrica: Unidade:
44427 USUAL UN/1
F1 F4

UN: R\$ 37,63 AV: R\$ 37,63 15: R\$ 38,41
30: R\$ 39,18 45: R\$ 39,97 60: R\$ 40,77



CESTO PLAST ROUPEIRO 30 LTS COLOR 828

Código: Fábrica: Unidade:
51064 LUMAR UN/1
F1 F4

UN: R\$ 46,99 AV: R\$ 46,99 15: R\$ 47,97
30: R\$ 48,93 45: R\$ 49,91 60: R\$ 50,91



CESTO PLAST ROUPEIRO 60 LTS 849

Código: Fábrica: Unidade:
46666 LUMAR UN/1
F1 F4

UN: R\$ 69,51 AV: R\$ 69,51 15: R\$ 70,96
30: R\$ 72,38 45: R\$ 73,83 60: R\$ 75,31

1 64cm
2 58cm
3 100lts



CESTO PLAST ROUPEIRO 100 LTS PRETO 3100

Código: Fábrica: Unidade:
46667 LUMAR UN/1
F1 F4

UN: R\$ 45,03 AV: R\$ 45,03 15: R\$ 45,97
30: R\$ 46,89 45: R\$ 47,83 60: R\$ 48,79

1 45cm
2 52cm



CESTO PLAST TELADO COLOR 62 LTS 6682

Código: Fábrica: Unidade:
41665 INPLAST UN/1
F1 F4

UN: R\$ 8,76 AV: R\$ 8,76 15: R\$ 8,95
30: R\$ 9,13 45: R\$ 9,31 60: R\$ 9,49

1 24 cm
2 25 cm

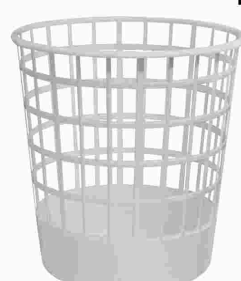

CESTO PLAST TELADO RED BCO 24X25CM 340

Código: Fábrica: Unidade:
33032 TRITEC UN/1
F1 F4

UN: R\$ 29,57 AV: R\$ 29,57 15: R\$ 30,19
30: R\$ 30,79 45: R\$ 31,41 60: R\$ 32,04



CESTO PLAST TELADO RED 30 LTS PRETO 789

Código: Fábrica: Unidade:
51062 LUMAR UN/1
F1 F4

UN: R\$ 53,24 AV: R\$ 53,24 15: R\$ 54,35
30: R\$ 55,44 45: R\$ 56,54 60: R\$ 57,67



CESTO PLAST TELADO RED 60 LTS PRETO 937

Código: Fábrica: Unidade:
51063 LUMAR UN/1
F1 F4

UN: R\$ 33,17 AV: R\$ 33,17 15: R\$ 33,86
30: R\$ 34,53 45: R\$ 35,22 60: R\$ 35,93



CESTO PLAST TELADO RET 35 LTS PRETO 1015

Código: Fábrica: Unidade:
51047 LUMAR UN/1
F1 F4

UN: R\$ 55,61 AV: R\$ 55,61 15: R\$ 56,77
30: R\$ 57,90 45: R\$ 59,06 60: R\$ 60,24



CESTO PLAST TELADO RET 72 LTS PRETO 931

Código: Fábrica: Unidade:
51046 LUMAR UN/1
F1 F4

UN: R\$ 7,33 AV: R\$ 7,33 15: R\$ 7,49
30: R\$ 7,64 45: R\$ 7,79 60: R\$ 7,95



CESTO PLAST TELADO 10 LTS PRETO 163

Código: 38656 Fábrica: MOLDE MINAS Unidade: UN/1 F1 F4

UN: R\$ 9,78 AV: R\$ 9,78 15: R\$ 9,99
30: R\$ 10,19 45: R\$ 10,39 60: R\$ 10,60



CESTO PLAST TELADO 10 LTS 118

Código: 50003 Fábrica: PLASMARC Unidade: UN/1 F1 F4

UN: R\$ 9,21 AV: R\$ 9,21 15: R\$ 9,41
30: R\$ 9,59 45: R\$ 9,79 60: R\$ 9,98

52cm
10lts



CESTO PLAST TELADO 10 LTS 728

Código: 37264 Fábrica: LUMAR Unidade: UN/1 F1 F4

UN: R\$ 33,76 AV: R\$ 33,76 15: R\$ 34,47
30: R\$ 35,16 45: R\$ 35,86 60: R\$ 36,58

52cm
30lts



CESTO PLAST TELADO 30 LTS AZUL BABY 831

Código: 50943 Fábrica: LUMAR Unidade: UN/1 F1 F4

UN: R\$ 33,77 AV: R\$ 33,77 15: R\$ 34,48
30: R\$ 35,17 45: R\$ 35,87 60: R\$ 36,59

52cm
30lts



CESTO PLAST TELADO 30 LTS BRANCO 776

Código: 39552 Fábrica: LUMAR Unidade: UN/1 F1 F4

UN: R\$ 33,77 AV: R\$ 33,77 15: R\$ 34,48
30: R\$ 35,17 45: R\$ 35,87 60: R\$ 36,59

30 lts



CESTO PLAST TELADO 30 LTS FENDI 873

Código: 39554 Fábrica: LUMAR Unidade: UN/1 F1 F4

UN: R\$ 33,76 AV: R\$ 33,76 15: R\$ 34,47
30: R\$ 35,16 45: R\$ 35,86 60: R\$ 36,58

52cm
30lts



CESTO PLAST TELADO 30 LTS ROSA BABY 831

Código: 48998 Fábrica: LUMAR Unidade: UN/1 F1 F4

UN: R\$ 16,64 AV: R\$ 16,64 15: R\$ 16,98
30: R\$ 17,32 45: R\$ 17,67 60: R\$ 18,02

6cm
30cm

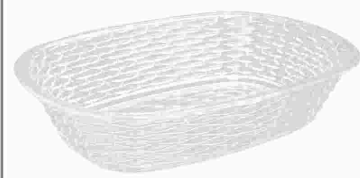

CESTO P/PAO CRISTAL NATURAL 2342

Código: 44255 Fábrica: TRITEC Unidade: UN/1 F1 F4

UN: R\$ 49,99 AV: R\$ 49,99 15: R\$ 49,99
30: R\$ 49,99 45: R\$ 49,99 60: R\$ 49,99



CESTO TELADO RET P/ROUPA 60 LTS CORES

Código: 40878 Fábrica: ANTARES Unidade: UN/1 F1 F4

UN: R\$ 24,47 AV: R\$ 24,47 15: R\$ 24,98
30: R\$ 25,48 45: R\$ 25,99 60: R\$ 26,51



CESTO TELADO ROUPAS 30LTS COLOR 951765

Código: 41199 Fábrica: PLASTSU Unidade: UN/1 F1 F4

UN: R\$ 24,47 AV: R\$ 24,47 15: R\$ 24,98
30: R\$ 25,48 45: R\$ 25,99 60: R\$ 26,51



CESTO TELADO ROUPAS 30LTS PRETO 951000

Código: 41198 Fábrica: PLASTSU Unidade: UN/1 F1 F4

UN: R\$ 6,84 AV: R\$ 6,84 15: R\$ 6,99
30: R\$ 7,13 45: R\$ 7,27 60: R\$ 7,41



CHIPS DE COCO 1 LITRO

Código: 48533 Fábrica: NOVATROPICAL Unidade: PT/1 F1 F4

UN: R\$ 2,94 AV: R\$ 35,24 15: R\$ 35,98
30: R\$ 36,70 45: R\$ 37,43 60: R\$ 38,18



CHUVEIRINHO P/TORNEIRA PIA TANQUE 1 12X1

Código: 33735 Fábrica: REBOUCAS Unidade: PT/12 F1 F4

UN: R\$ 6,53 AV: R\$ 78,33 15: R\$ 79,96
30: R\$ 81,56 45: R\$ 83,19 60: R\$ 84,85



COADOR FLANELA CAFE SEM CABO 12X1

Código: 50969 Fábrica: BEAUTY Unidade: DZ/12 F1 F4

UN: R\$ 4,41 AV: R\$ 52,88 15: R\$ 53,98
30: R\$ 55,06 45: R\$ 56,16 60: R\$ 57,28



COADOR FLANELA CAFE 102 CB MAD 12X1

Código: 27405 Fábrica: MCPAN/BEAUTY Unidade: DZ/12 F1 F4

UN: R\$ 4,74 AV: R\$ 56,88 15: R\$ 56,88
30: R\$ 56,88 45: R\$ 56,88 60: R\$ 56,88



COADOR FLANELA CAFE 103 CB MAD 12X1

Código: 27406 Fábrica: BEAU/AMO/MAR Unidade: DZ/12 F1 F4

UN: R\$ 6,36 AV: R\$ 76,38 15: R\$ 77,97
30: R\$ 79,53 45: R\$ 81,12 60: R\$ 82,74



COADOR FLANELA CAFE 104 CB ALUM 12X1
Código: 27412 Fábrica: FERREIRA Unidade: DZ/12 F1 F4

UN: R\$ 4,89 AV: R\$ 4,89 15: R\$ 4,99
30: R\$ 5,09 45: R\$ 5,19 60: R\$ 5,29



COADOR FLANELA CAFE 104 CB MAD UN
Código: 46137 Fábrica: MC PANOS Unidade: UN/1 F1 F4

UN: R\$ 5,51 AV: R\$ 66,10 15: R\$ 67,47
30: R\$ 68,82 45: R\$ 70,20 60: R\$ 71,60



COADOR FLANELA CAFE 104 CB MAD 12X1
Código: 27408 Fábrica: MC PANOS Unidade: DZ/12 F1 F4

UN: R\$ 5,39 AV: R\$ 64,63 15: R\$ 65,97
30: R\$ 67,29 45: R\$ 68,64 60: R\$ 70,01



COADOR FLANELA CAFE 105 CB MAD 12X1
Código: 23956 Fábrica: MC PANOS Unidade: DZ/12 F1 F4

UN: R\$ 5,88 AV: R\$ 70,50 15: R\$ 71,97
30: R\$ 73,41 45: R\$ 74,88 60: R\$ 76,38



COADOR FLANELA CAFE 107 CB MAD 12X1
Código: 34505 Fábrica: MC PANOS Unidade: DZ/12 F1 F4

UN: R\$ 4,08 AV: R\$ 48,95 15: R\$ 49,97
30: R\$ 50,97 45: R\$ 51,99 60: R\$ 53,03



COADOR MALHA CAFE GDE CB PLAST 12X1
Código: 24949 Fábrica: NZA Unidade: DZ/12 F1 F4

UN: R\$ 1,46 AV: R\$ 1,46 15: R\$ 1,49
30: R\$ 1,52 45: R\$ 1,55 60: R\$ 1,58



COADOR PLASTICO 07 CM 3020 UN
Código: 48015 Fábrica: SBRISSA Unidade: UN/1 F1 F4

UN: R\$ 3,07 AV: R\$ 3,07 15: R\$ 3,14
30: R\$ 3,20 45: R\$ 3,27 60: R\$ 3,33



COADOR PLASTICO 12 CM 3021 UN
Código: 16642 Fábrica: SBRISSA Unidade: UN/1 F1 F4

UN: R\$ 5,87 AV: R\$ 5,87 15: R\$ 5,99
30: R\$ 6,11 45: R\$ 6,23 60: R\$ 6,35



COADOR PLASTICO 18 CM 3023 UN
Código: 48009 Fábrica: SBRISSA Unidade: UN/1 F1 F4

UN: R\$ 3,92 AV: R\$ 46,99 15: R\$ 47,97
30: R\$ 48,93 45: R\$ 49,91 60: R\$ 50,91



COLEIRA PET FIBRA C/SINO 30 CM 12X1
Código: 45878 Fábrica: ALMEGA Unidade: PT/12 F1 F4

UN: R\$ 5,63 AV: R\$ 33,78 15: R\$ 34,49
30: R\$ 35,18 45: R\$ 35,88 60: R\$ 36,60



COLEIRA PET TIPO COURO 38 CM 15593 6X1
Código: 39244 Fábrica: ALIANCA Unidade: PT/6 F1 F4

UN: R\$ 3,54 AV: R\$ 21,26 15: R\$ 21,70
30: R\$ 22,14 45: R\$ 22,58 60: R\$ 23,03



COLHER ACO INOX REFEICAO 21CM 14736 6X1
Código: 46490 Fábrica: NICOBEM Unidade: PT/6 F1 F4

UN: R\$ 2,95 AV: R\$ 17,72 15: R\$ 18,09
30: R\$ 18,45 45: R\$ 18,82 60: R\$ 19,20

17cm



COLHER ACO INOX SOBREMESA 17CM 14771 6X1
Código: 46489 Fábrica: NICOBEM Unidade: PT/6 F1 F4

UN: R\$ 10,49 AV: R\$ 10,49 15: R\$ 10,71
30: R\$ 10,92 45: R\$ 11,14 60: R\$ 11,36

34cm



COLHER ACO INOX 34CM GDE 14785
Código: 46488 Fábrica: NICOBEM Unidade: UN/1 F1 F4

UN: R\$ 12,72 AV: R\$ 12,72 15: R\$ 12,98
30: R\$ 13,24 45: R\$ 13,51 60: R\$ 13,78

30cm



COLHER ALUM BATIDO 30CM ARROZ 2641
Código: 45293 Fábrica: MSR Unidade: UN/1 F1 F4

UN: R\$ 4,26 AV: R\$ 4,26 15: R\$ 4,35
30: R\$ 4,44 45: R\$ 4,52 60: R\$ 4,61

30 cm



COLHER ALUM 27CM INTEIRICO 2018 UN
Código: 48018 Fábrica: COFAX Unidade: UN/1 F1 F4

UN: R\$ 4,75 AV: R\$ 4,75 15: R\$ 4,85
30: R\$ 4,95 45: R\$ 5,04 60: R\$ 5,14



COLHER ALUM 28CM CB MAD 2003 UN
Código: 48035 Fábrica: COFAX Unidade: UN/1
F1 F4

UN: R\$ 6,84 AV: R\$ 6,84 15: R\$ 6,99
30: R\$ 7,13 45: R\$ 7,27 60: R\$ 7,41



COLHER BAMBU 23 CM 050
Código: 46252 Fábrica: CASITA Unidade: UN/1
F1 F4

UN: R\$ 6,84 AV: R\$ 6,84 15: R\$ 6,99
30: R\$ 7,13 45: R\$ 7,27 60: R\$ 7,41



COLHER BAMBU 30 CM 052
Código: 46253 Fábrica: CASITA Unidade: UN/1
F1 F4

UN: R\$ 0,10 AV: R\$ 5,14 15: R\$ 5,25
30: R\$ 5,35 45: R\$ 5,46 60: R\$ 5,57



COLHER DESCARTAVEL 50X1
Código: 42147 Fábrica: PLAZA/RIOFES Unidade: PT/50
F1 F4

UN: R\$ 1,14 AV: R\$ 3,42 15: R\$ 3,49
30: R\$ 3,56 45: R\$ 3,63 60: R\$ 3,70



COLHER ESPATULA GARFO MADEIRA 30CM 6029
Código: 44738 Fábrica: WINCY Unidade: CJ/3
F1 F4

UN: R\$ 6,66 AV: R\$ 6,66 15: R\$ 6,80
30: R\$ 6,93 45: R\$ 7,07 60: R\$ 7,21



COLHER INOX CACIQUE 33CM 137
Código: 39351 Fábrica: PLANETA Unidade: UN/1
F1 F4

UN: R\$ 2,12 AV: R\$ 25,45 15: R\$ 25,98
30: R\$ 26,50 45: R\$ 27,03 60: R\$ 27,57



COLHER INOX CHA LINHA PRATA 110 12X1
Código: 47628 Fábrica: PLANETA Unidade: PT/12
F1 F4

UN: R\$ 1,96 AV: R\$ 23,49 15: R\$ 23,98
30: R\$ 24,46 45: R\$ 24,95 60: R\$ 25,45



COLHER INOX MESA LINHA AMERICA 2223 12X1
Código: 50620 Fábrica: STEEL Unidade: PT/12
F1 F4

UN: R\$ 2,73 AV: R\$ 16,35 15: R\$ 16,69
30: R\$ 17,03 45: R\$ 17,37 60: R\$ 17,72



COLHER INOX MESA UNIVERSO 2046 6X1
Código: 50136 Fábrica: GP6 Unidade: PT/6
F1 F4

UN: R\$ 1,96 AV: R\$ 23,49 15: R\$ 23,98
30: R\$ 24,46 45: R\$ 24,95 60: R\$ 25,45



COLHER INOX MESA 19CM VERSA PTO 954 12X1
Código: 50163 Fábrica: PLANETA Unidade: DZ/12
F1 F4

UN: R\$ 14,68 AV: R\$ 14,68 15: R\$ 14,98
30: R\$ 15,28 45: R\$ 15,59 60: R\$ 15,90



COLHER INOX P/ARROZ 35CM 173
Código: 19947 Fábrica: PLANETA Unidade: UN/1
F1 F4

UN: R\$ 5,87 AV: R\$ 5,87 15: R\$ 5,99
30: R\$ 6,11 45: R\$ 6,23 60: R\$ 6,35



COLHER INOX P/SUCO 30,5CM 8189
Código: 41541 Fábrica: ELITE Unidade: UN/1
F1 F4

UN: R\$ 1,36 AV: R\$ 16,35 15: R\$ 16,69
30: R\$ 17,03 45: R\$ 17,37 60: R\$ 17,72



COLHER INOX SOBREMESA BRONZE 522 12X1
Código: 39346 Fábrica: PLANETA Unidade: PT/12
F1 F4

UN: R\$ 1,22 AV: R\$ 14,68 15: R\$ 14,98
30: R\$ 15,28 45: R\$ 15,59 60: R\$ 15,90



COLHER INOX SOBREMESA VANGUARD 15CM 12X1
Código: 50906 Fábrica: GP INOX Unidade: CX/12
F1 F4

UN: R\$ 12,39 AV: R\$ 12,39 15: R\$ 12,64
30: R\$ 12,90 45: R\$ 13,16 60: R\$ 13,42



COLHER INOX SORVETE C/EXTRATOR 19CM 3025
Código: 44728 Fábrica: WINCY Unidade: UN/1
F1 F4

UN: R\$ 3,18 AV: R\$ 3,18 15: R\$ 3,25
30: R\$ 3,31 45: R\$ 3,38 60: R\$ 3,45



COLHER INOX SORVETE 19CM CB PLAST 3243
Código: 44727 Fábrica: WINCY Unidade: UN/1
F1 F4

UN: R\$ 3,62 AV: R\$ 3,62 15: R\$ 3,70
30: R\$ 3,77 45: R\$ 3,85 60: R\$ 3,92



COLHER MACARRAO NYLON PRETO 1085

Código: Fábrica: Unidade:
37804 ENGIPLAST UN/1
F1 F4

UN: R\$ 3,91 AV: R\$ 3,91 15: R\$ 3,99
30: R\$ 4,07 45: R\$ 4,15 60: R\$ 4,23



COLHER MADEIRA 23 CM 01

Código: Fábrica: Unidade:
41315 MAD LAR UN/1
F1 F4

UN: R\$ 6,84 AV: R\$ 6,84 15: R\$ 6,99
30: R\$ 7,13 45: R\$ 7,27 60: R\$ 7,41



COLHER MADEIRA 38 CM 105/05

Código: Fábrica: Unidade:
30807 CSD/MAD LAR UN/1
F1 F4

UN: R\$ 1,22 AV: R\$ 4,89 15: R\$ 4,99
30: R\$ 5,09 45: R\$ 5,19 60: R\$ 5,29



COLHER MEDIDORA CHA SOPA 400 4X1

Código: Fábrica: Unidade:
37080 DELTA UTIL PT/4
F1 F4

UN: R\$ 17,62 AV: R\$ 17,62 15: R\$ 17,98
30: R\$ 18,34 45: R\$ 18,71 60: R\$ 19,08



COLHER NYLON ARROZ 33,5CM CB CROMADO 424

Código: Fábrica: Unidade:
41351 HAUSKRAFT UN/1
F1 F4

UN: R\$ 11,74 AV: R\$ 11,74 15: R\$ 11,99
30: R\$ 12,22 45: R\$ 12,47 60: R\$ 12,72



COLHER NYLON BRANCA CB ACO 113-001

Código: Fábrica: Unidade:
41487 HERCULES UN/1
F1 F4

UN: R\$ 3,71 AV: R\$ 3,71 15: R\$ 3,79
30: R\$ 3,86 45: R\$ 3,94 60: R\$ 4,02



COLHER PLAST COLOR 24CM 1014

Código: Fábrica: Unidade:
36953 ENGIPLAST UN/1
F1 F4

UN: R\$ 3,91 AV: R\$ 3,91 15: R\$ 3,99
30: R\$ 4,07 45: R\$ 4,15 60: R\$ 4,23



COLHER PLAST COLOR 30CM 1015

Código: Fábrica: Unidade:
36954 ENGIPLAST UN/1
F1 F4

UN: R\$ 3,91 AV: R\$ 3,91 15: R\$ 3,99
30: R\$ 4,07 45: R\$ 4,15 60: R\$ 4,23



COLHER PLASTICA 36CM 1016

Código: Fábrica: Unidade:
36955 ENGIPLAST UN/1
F1 F4

UN: R\$ 4,07 AV: R\$ 4,07 15: R\$ 4,16
30: R\$ 4,24 45: R\$ 4,33 60: R\$ 4,41



COLHER PLAST COLOR 40CM 1017

Código: Fábrica: Unidade:
36956 ENGIPLAST UN/1
F1 F4

UN: R\$ 2,79 AV: R\$ 2,79 15: R\$ 2,85
30: R\$ 2,91 45: R\$ 2,96 60: R\$ 3,02



COLHER PLAST COLOR 5022

Código: Fábrica: Unidade:
31279 SBRISSA UN/1
F1 F4

UN: R\$ 6,61 AV: R\$ 6,61 15: R\$ 6,75
30: R\$ 6,88 45: R\$ 7,02 60: R\$ 7,16



COLHER PLAST P/SORVETE 19CM 290

Código: Fábrica: Unidade:
39241 DELTA UTIL UN/1
F1 F4

UN: R\$ 0,49 AV: R\$ 5,87 15: R\$ 5,99
30: R\$ 6,11 45: R\$ 6,23 60: R\$ 6,35



COLHER PLASTICA 17CM 12X1

Código: Fábrica: Unidade:
14580 ECOPLASTIC DZ/12
F1 F4

UN: R\$ 14,68 AV: R\$ 14,68 15: R\$ 14,98
30: R\$ 15,28 45: R\$ 15,59 60: R\$ 15,90



COLHER SILICONE ARROZ 27CM 110-11

Código: Fábrica: Unidade:
44772 NICOBEM UN/1
F1 F4

UN: R\$ 14,38 AV: R\$ 14,38 15: R\$ 14,84
30: R\$ 15,29 45: R\$ 15,74 60: R\$ 16,22



COLHER SILICONE VM CB ACO INOX 3098

Código: Fábrica: Unidade:
33822 SATYAM UN/1
F1 F4

UN: R\$ 11,74 AV: R\$ 11,74 15: R\$ 11,99
30: R\$ 12,22 45: R\$ 12,47 60: R\$ 12,72



COLHER SILICONE 30X8,5CM CORACAO 9701

Código: Fábrica: Unidade:
50220 CASITA UN/1
F1 F4

UN: R\$ 4,80 AV: R\$ 4,80 15: R\$ 4,90
30: R\$ 5,00 45: R\$ 5,10 60: R\$ 5,20



COLHER+CONCHA NYLON PTO 5003 2X1
Código: Fábrica: Unidade:
18708 SBRISSA KT/1
F1 F4

UN: R\$ 2,40 AV: R\$ 4,80 15: R\$ 4,90
30: R\$ 5,00 45: R\$ 5,10 60: R\$ 5,20



COLHER+PEGADOR MACARRAO NYLON 5004 2X1
Código: Fábrica: Unidade:
18709 SBRISSA KT/2
F1 F4

UN: R\$ 2,22 AV: R\$ 2,22 15: R\$ 2,27
30: R\$ 2,31 45: R\$ 2,36 60: R\$ 2,41



COMEDOIRO PLAST P/CAES MINI AZUL 170ML
Código: Fábrica: Unidade:
24166 NUTRIPLAN UN/1
F1 F4

UN: R\$ 2,22 AV: R\$ 2,22 15: R\$ 2,27
30: R\$ 2,31 45: R\$ 2,36 60: R\$ 2,41



COMEDOIRO PLAST P/CAES MINI ROSA 170ML
Código: Fábrica: Unidade:
24164 NUTRIPLAN UN/1
F1 F4

UN: R\$ 5,04 AV: R\$ 5,04 15: R\$ 5,15
30: R\$ 5,25 45: R\$ 5,36 60: R\$ 5,46

 0,5 lts



COMEDOIRO PLAST PET 500 ML M COLOR
Código: Fábrica: Unidade:
40037 ANTARES UN/1
F1 F4

UN: R\$ 5,87 AV: R\$ 5,87 15: R\$ 5,99
30: R\$ 6,11 45: R\$ 6,23 60: R\$ 6,35

 25cm



CONCHA ACO INOX FEIJAO 25CM 059
Código: Fábrica: Unidade:
47490 PLANETA UN/1
F1 F4

UN: R\$ 8,65 AV: R\$ 8,65 15: R\$ 8,83
30: R\$ 9,00 45: R\$ 9,18 60: R\$ 9,37

 29cm



CONCHA ACO INOX MINI 29CM SAFIRA 160
Código: Fábrica: Unidade:
28768 PLANETA UN/1
F1 F4

UN: R\$ 12,72 AV: R\$ 12,72 15: R\$ 12,98
30: R\$ 13,24 45: R\$ 13,51 60: R\$ 13,78

 30cm



CONCHA ALUM BATIDO 30CM 2643
Código: Fábrica: Unidade:
45294 MSR UN/1
F1 F4

UN: R\$ 4,26 AV: R\$ 4,26 15: R\$ 4,35
30: R\$ 4,44 45: R\$ 4,52 60: R\$ 4,61



CONCHA ALUM 27CM INTEIRICO 2020 UN
Código: Fábrica: Unidade:
48022 COFAX UN/1
F1 F4

UN: R\$ 4,69 AV: R\$ 4,69 15: R\$ 4,79
30: R\$ 4,88 45: R\$ 4,98 60: R\$ 5,08



CONCHA ALUM 28CM CB MAD 2000 UN
Código: Fábrica: Unidade:
48019 COFAX UN/1
F1 F4

UN: R\$ 6,66 AV: R\$ 6,66 15: R\$ 6,80
30: R\$ 6,93 45: R\$ 7,07 60: R\$ 7,21



CONCHA INOX CACIQUE 33CM 136
Código: Fábrica: Unidade:
39350 PLANETA UN/1
F1 F4

UN: R\$ 11,75 AV: R\$ 11,75 15: R\$ 12,00
30: R\$ 12,24 45: R\$ 12,48 60: R\$ 12,73



CONCHA INOX COZINHA 32CM 700-42
Código: Fábrica: Unidade:
40534 CASA ONZE UN/1
F1 F4

UN: R\$ 17,23 AV: R\$ 17,23 15: R\$ 17,59
30: R\$ 17,94 45: R\$ 18,30 60: R\$ 18,67

 26 cm



CONCHA INOX FEIJAO 26 CM 147-48
Código: Fábrica: Unidade:
44770 NICOBEM UN/1
F1 F4

UN: R\$ 6,85 AV: R\$ 6,85 15: R\$ 7,00
30: R\$ 7,14 45: R\$ 7,28 60: R\$ 7,43



CONCHA INOX SAFIRA 23CM 159
Código: Fábrica: Unidade:
39354 PLANETA UN/1
F1 F4

UN: R\$ 8,22 AV: R\$ 8,22 15: R\$ 8,39
30: R\$ 8,55 45: R\$ 8,73 60: R\$ 8,90



CONCHA INOX VAZADA MINI 23CM SAFIRA 158
Código: Fábrica: Unidade:
39353 PLANETA UN/1
F1 F4

UN: R\$ 8,04 AV: R\$ 96,45 15: R\$ 98,46
30: R\$ 100,43 45: R\$ 102,44 60: R\$ 104,49



CONCHA INOX 30CM FDO CB MAD 32 12X1
Código: Fábrica: Unidade:
38435 ARTE INOX DZ/12
F1 F4

UN: R\$ 9,79 AV: R\$ 58,74 15: R\$ 59,97
30: R\$ 61,17 45: R\$ 62,39 60: R\$ 63,64



CONCHA INOX 32CM FDO INTEIRICO 50 6X1

Código: 38433 Fábrica: ARTE INOX Unidade: PT/6
F1 F4

UN: R\$ 5,39 AV: R\$ 64,63 15: R\$ 65,97
30: R\$ 67,29 45: R\$ 68,64 60: R\$ 70,01



CONCHA INOX 32CM RASO CB MAD 33 12X1

Código: 38436 Fábrica: ARTE INOX Unidade: DZ/12
F1 F4

UN: R\$ 10,77 AV: R\$ 129,25 15: R\$ 131,95
30: R\$ 134,59 45: R\$ 137,28 60: R\$ 140,02



CONCHA INOX 36CM RS S/SOL CB MAD 63 12X1

Código: 38442 Fábrica: ARTE INOX Unidade: DZ/12
F1 F4

UN: R\$ 11,74 AV: R\$ 11,74 15: R\$ 11,99
30: R\$ 12,22 45: R\$ 12,47 60: R\$ 12,72



CONCHA NYLON BRANCA CB ACO 1103-002

Código: 41300 Fábrica: HERCULES Unidade: UN/1
F1 F4

UN: R\$ 17,62 AV: R\$ 17,62 15: R\$ 17,98
30: R\$ 18,34 45: R\$ 18,71 60: R\$ 19,08



CONCHA NYLON 33,2M CB CROMADO 069

Código: 41352 Fábrica: HAUSKRAFT Unidade: UN/1
F1 F4

UN: R\$ 3,08 AV: R\$ 3,08 15: R\$ 3,15
30: R\$ 3,21 45: R\$ 3,28 60: R\$ 3,34



CONCHA PERFORADA INOX 27CM 72005

Código: 38429 Fábrica: ALMEGA Unidade: UN/1
F1 F4

UN: R\$ 2,79 AV: R\$ 2,79 15: R\$ 2,85
30: R\$ 2,91 45: R\$ 2,96 60: R\$ 3,02



CONCHA PLAST COLOR 5023

Código: 31280 Fábrica: SBRISSA Unidade: UN/1
F1 F4

UN: R\$ 14,68 AV: R\$ 14,68 15: R\$ 14,98
30: R\$ 15,28 45: R\$ 15,59 60: R\$ 15,90



CONCHA SILICONE 28,5CM 110-12

Código: 44773 Fábrica: NICOBEM Unidade: UN/1
F1 F4

UN: R\$ 4,57 AV: R\$ 13,70 15: R\$ 13,98
30: R\$ 14,26 45: R\$ 14,55 60: R\$ 14,84



CONCHA+COLHER+PEGADOR MACARR NYLON 5021

Código: 18711 Fábrica: SBRISSA Unidade: KT/3
F1 F4

UN: R\$ 4,13 AV: R\$ 4,13 15: R\$ 4,22
30: R\$ 4,30 45: R\$ 4,39 60: R\$ 4,48



CONCHINHA PLAST MEDIDORA 150GRS 030

Código: 37881 Fábrica: BENEDETTI Unidade: UN/1
F1 F4

UN: R\$ 11,49 AV: R\$ 11,49 15: R\$ 11,73
30: R\$ 11,96 45: R\$ 12,20 60: R\$ 12,44



CONEXAO PLAST ENGATE RAPIDO MANGUEIR 213

Código: 40240 Fábrica: MONTEREY Unidade: UN/1
F1 F4

UN: R\$ 26,43 AV: R\$ 26,43 15: R\$ 26,98
30: R\$ 27,52 45: R\$ 28,07 60: R\$ 28,63



CONJ INOX P/SERVIR ARROZ 2PCS 152

Código: 41435 Fábrica: MADEFERINOX Unidade: CJ/1
F1 F4

UN: R\$ 26,43 AV: R\$ 26,43 15: R\$ 26,98
30: R\$ 27,52 45: R\$ 28,07 60: R\$ 28,63



CONJ INOX P/SERVIR FEIJAO 2PCS 153

Código: 41436 Fábrica: MADEFERINOX Unidade: CJ/1
F1 F4

UN: R\$ 26,43 AV: R\$ 26,43 15: R\$ 26,98
30: R\$ 27,52 45: R\$ 28,07 60: R\$ 28,63



CONJ INOX P/SERVIR MASSA 2PCS 150

Código: 41438 Fábrica: MADEFERINOX Unidade: CJ/1
F1 F4

UN: R\$ 26,43 AV: R\$ 26,43 15: R\$ 26,98
30: R\$ 27,52 45: R\$ 28,07 60: R\$ 28,63



CONJ INOX P/SERVIR SALADA 2PCS 155

Código: 41437 Fábrica: MADEFERINOX Unidade: CJ/1
F1 F4

UN: R\$ 18,60 AV: R\$ 18,60 15: R\$ 18,98
30: R\$ 19,36 45: R\$ 19,75 60: R\$ 20,14



CONJ INOX P/TORTA E BOLO 7PCS 42

Código: 41440 Fábrica: MADEFERINOX Unidade: CJ/1
F1 F4

UN: R\$ 181,30 AV: R\$ 181,30 15: R\$ 185,08
30: R\$ 188,78 45: R\$ 192,55 60: R\$ 196,40



CONJ PANELA ALUM EXTR 14/16/18/20/22 720
Código: Fábrica: Unidade:
35256 MSR CJ/1
F1 F4

UN: R\$ 15,67 AV: R\$ 15,67 15: R\$ 15,99
30: R\$ 16,31 45: R\$ 16,64 60: R\$ 16,97



CONJ P/COZINHA ABRIDOR+DESCACADOR 7652
Código: Fábrica: Unidade:
34805 IDEA CR/1
F1 F4

UN: R\$ 12,72 AV: R\$ 12,72 15: R\$ 12,98
30: R\$ 13,24 45: R\$ 13,51 60: R\$ 13,78



CONJ SOBREMESA VIDRO BOWLS 150ML 3PC 014
Código: Fábrica: Unidade:
49431 RIOHOME UN/1
F1 F4

UN: R\$ 2,45 AV: R\$ 29,37 15: R\$ 29,98
30: R\$ 30,58 45: R\$ 31,19 60: R\$ 31,81



CONJ TALHERES CB MAD CHURRASCO 6007 12X1
Código: Fábrica: Unidade:
44734 WINCY CJ/12
F1 F4

UN: R\$ 29,37 AV: R\$ 29,37 15: R\$ 29,98
30: R\$ 30,58 45: R\$ 31,19 60: R\$ 31,81



CONJ UTENSILIOS INOX 4PCS 809
Código: Fábrica: Unidade:
41439 MADEFERINOX CJ/1
F1 F4

UN: R\$ 73,83 AV: R\$ 73,83 15: R\$ 75,37
30: R\$ 76,88 45: R\$ 78,41 60: R\$ 79,98



CONJ 6 TACA VIDRO 300ML BERLIM TRANSP
Código: Fábrica: Unidade:
49428 RIOHOME UN/1
F1 F4

UN: R\$ 14,36 AV: R\$ 86,16 15: R\$ 87,95
30: R\$ 89,71 45: R\$ 91,51 60: R\$ 93,34



CONJ 6 TACA VIDRO 320ML DIAMOND TRANSP
Código: Fábrica: Unidade:
49804 FUTURO CASA CJ/6
F1 F4

UN: R\$ 9,79 AV: R\$ 58,74 15: R\$ 59,97
30: R\$ 61,17 45: R\$ 62,39 60: R\$ 63,64



CONJ 6 TACA VIDRO 330ML BICO JACA TRANSP
Código: Fábrica: Unidade:
48204 VIVA FLOR CJ/6
F1 F4

UN: R\$ 98,43 AV: R\$ 98,43 15: R\$ 100,48
30: R\$ 102,49 45: R\$ 104,54 60: R\$ 106,63



CONJ 6 TACA VIDRO 335ML MADRID TRANSP
Código: Fábrica: Unidade:
49429 RIOHOME UN/1
F1 F4

UN: R\$ 9,79 AV: R\$ 58,74 15: R\$ 59,97
30: R\$ 61,17 45: R\$ 62,39 60: R\$ 63,64



CONJ 6 TACA VIDRO 340ML DIAMANTE TRANSP
Código: Fábrica: Unidade:
48203 VIVA FLOR CJ/6
F1 F4

UN: R\$ 45,42 AV: R\$ 45,42 15: R\$ 46,36
30: R\$ 47,29 45: R\$ 48,23 60: R\$ 49,20



CONJ 6 XICARAS CAFE CERAM 90 ML S/PIR 54
Código: Fábrica: Unidade:
49434 RIOHOME CJ/1
F1 F4

UN: R\$ 58,74 AV: R\$ 58,74 15: R\$ 59,97
30: R\$ 61,17 45: R\$ 62,39 60: R\$ 63,64



CONJ 6 XICARAS CHA VID C/PIRES ALEXA 10A
Código: Fábrica: Unidade:
47416 DIAMONDS CJ/1
F1 F4

UN: R\$ 64,99 AV: R\$ 64,99 15: R\$ 64,99
30: R\$ 64,99 45: R\$ 64,99 60: R\$ 64,99



CONJ 6 XICARAS CHA VID C/PIRES BELLA 753
Código: Fábrica: Unidade:
47400 NUNESTAR CJ/1
F1 F4

UN: R\$ 78,33 AV: R\$ 78,33 15: R\$ 79,96
30: R\$ 81,56 45: R\$ 83,19 60: R\$ 84,85



CONJ 6 XICARAS CHA VID C/PIRES STAR8983
Código: Fábrica: Unidade:
47405 NUNESTAR CJ/1
F1 F4

UN: R\$ 78,33 AV: R\$ 78,33 15: R\$ 79,96
30: R\$ 81,56 45: R\$ 83,19 60: R\$ 84,85



CONJ 6 XICARAS CHA VID C/PIRES STAR8984
Código: Fábrica: Unidade:
47404 NUNESTAR CJ/1
F1 F4

UN: R\$ 78,33 AV: R\$ 78,33 15: R\$ 79,96
30: R\$ 81,56 45: R\$ 83,19 60: R\$ 84,85



CONJ 6 XICARAS CHA VID C/PIRES STAR8986
Código: Fábrica: Unidade:
47406 NUNESTAR CJ/1
F1 F4

UN: R\$ 64,99 AV: R\$ 64,99 15: R\$ 64,99
30: R\$ 64,99 45: R\$ 64,99 60: R\$ 64,99



CONJ 6 XICARAS CHA VID C/PIRES TULIP 748

Código: Fábrika: Unidade:
47399 NUNESTAR CJ/1
F1 F4

UN: R\$ 64,99 AV: R\$ 64,99 15: R\$ 64,99
30: R\$ 64,99 45: R\$ 64,99 60: R\$ 64,99



CONJ 6 XICARAS CHA VID C/PIRES VINO 793

Código: Fábrika: Unidade:
47403 NUNESTAR CJ/1
F1 F4

UN: R\$ 66,58 AV: R\$ 66,58 15: R\$ 67,96
30: R\$ 69,32 45: R\$ 70,71 60: R\$ 72,12



CONJ 6 XICARAS PORC C/PIRES CAFE CUPC 29

Código: Fábrika: Unidade:
41332 HAUSKKRAFT CJ/1
F1 F4

UN: R\$ 108,69 AV: R\$ 108,69 15: R\$ 110,96
30: R\$ 113,17 45: R\$ 115,44 60: R\$ 117,75



COOLER 10 LATAS 2674

Código: Fábrika: Unidade:
45378 MSR UN/1
F1 F4

UN: R\$ 253,60 AV: R\$ 253,60 15: R\$ 258,89
30: R\$ 264,06 45: R\$ 269,35 60: R\$ 274,73



COOLER 30 LATAS 2673

Código: Fábrika: Unidade:
45377 MSR UN/1
F1 F4

UN: R\$ 5,74 AV: R\$ 5,74 15: R\$ 5,86
30: R\$ 5,97 45: R\$ 6,09 60: R\$ 6,22



COPO ACRIL MEDIDOR GRADUADO 500ML 989

Código: Fábrika: Unidade:
41641 QUALYPLAS UN/1
F1 F4

UN: R\$ 9,78 AV: R\$ 9,78 15: R\$ 9,99
30: R\$ 10,19 45: R\$ 10,39 60: R\$ 10,60



COPO ALUM LEVE 300 ML LISO

Código: Fábrika: Unidade:
34326 AVELAR UN/1
F1 F4

UN: R\$ 5,87 AV: R\$ 5,87 15: R\$ 5,99
30: R\$ 6,11 45: R\$ 6,23 60: R\$ 6,35



COPO ALUM LISO 1285

Código: Fábrika: Unidade:
37525 MSR UN/1
F1 F4

UN: R\$ 8,30 AV: R\$ 8,30 15: R\$ 8,48
30: R\$ 8,65 45: R\$ 8,82 60: R\$ 9,00



COPO ALUM 200 ML 1423

Código: Fábrika: Unidade:
37526 MSR UN/1
F1 F4

UN: R\$ 15,47 AV: R\$ 15,47 15: R\$ 15,79
30: R\$ 16,11 45: R\$ 16,43 60: R\$ 16,76



COPO ALUM 290ML MUNICH MIX 76640

Código: Fábrika: Unidade:
40401 UN-ART UN/1
F1 F4

UN: R\$ 8,80 AV: R\$ 8,80 15: R\$ 8,99
30: R\$ 9,17 45: R\$ 9,35 60: R\$ 9,54



COPO ALUM 300 ML BRASIL

Código: Fábrika: Unidade:
26860 AVELAR UN/1
F1 F4

UN: R\$ 9,19 AV: R\$ 9,19 15: R\$ 9,39
30: R\$ 9,57 45: R\$ 9,77 60: R\$ 9,96



COPO ALUM 300 ML 666

Código: Fábrika: Unidade:
35269 MSR UN/1
F1 F4

UN: R\$ 15,47 AV: R\$ 15,47 15: R\$ 15,79
30: R\$ 16,11 45: R\$ 16,43 60: R\$ 16,76



COPO ALUM 410ML BERLIM MIX 76642

Código: Fábrika: Unidade:
40402 UN-ART UN/1
F1 F4

UN: R\$ 5,39 AV: R\$ 5,39 15: R\$ 5,50
30: R\$ 5,61 45: R\$ 5,72 60: R\$ 5,83



COPO CRISTAL PEQ TRANSP C/PISCA 70790/21

Código: Fábrika: Unidade:
26452 Y888/HAI BRA UN/1
F1 F4

UN: R\$ 11,74 AV: R\$ 11,74 15: R\$ 11,99
30: R\$ 12,22 45: R\$ 12,47 60: R\$ 12,72



COPO CRISTAL 550 ML GRADUADO TRANSP 1005

Código: Fábrika: Unidade:
35493 TRITEC UN/1
F1 F4

UN: R\$ 0,04 AV: R\$ 3,91 15: R\$ 3,99
30: R\$ 4,07 45: R\$ 4,15 60: R\$ 4,23



COPO DESCARTAVEL 50ML 100X1

Código: Fábrika: Unidade:
50776 COPOPLAST PT/100
F1 F4

UN: R\$ 0,07 AV: R\$ 6,84 15: R\$ 6,99
30: R\$ 7,13 45: R\$ 7,27 60: R\$ 7,41



COPO DESCARTAVEL 100ML (POTE) 100X1

Código: Fábrika: Unidade:
50294 COPOPLAST PT/100
F1 F4

UN: R\$ 0,09 AV: R\$ 8,80 15: R\$ 8,99
30: R\$ 9,17 45: R\$ 9,35 60: R\$ 9,54



COPO DESCARTAVEL 200ML 100X1

Código: Fábrika: Unidade:
47738 COPO MAIS/FL PT/100
F1 F4

UN: R\$ 117,50 AV: R\$ 117,50 15: R\$ 119,95
30: R\$ 122,35 45: R\$ 124,80 60: R\$ 127,29



COPO INOX TERM 500ML AZUL C/TPA ABRIDOR

Código: Fábrika: Unidade:
40662 INGA UN/1
F1 F4

UN: R\$ 117,50 AV: R\$ 117,50 15: R\$ 119,95
30: R\$ 122,35 45: R\$ 124,80 60: R\$ 127,29



COPO INOX TERM 500ML BRANCO C/TPA ABRIDOR

Código: Fábrika: Unidade:
40661 INGA UN/1
F1 F4

UN: R\$ 117,50 AV: R\$ 117,50 15: R\$ 119,95
30: R\$ 122,35 45: R\$ 124,80 60: R\$ 127,29



COPO INOX TERM 500ML CINZA C/TPA ABRIDOR

Código: Fábrika: Unidade:
40664 INGA UN/1
F1 F4

UN: R\$ 117,50 AV: R\$ 117,50 15: R\$ 119,95
30: R\$ 122,35 45: R\$ 124,80 60: R\$ 127,29



COPO INOX TERM 500ML ROSA C/TPA ABRIDOR

Código: Fábrika: Unidade:
40665 INGA UN/1
F1 F4

UN: R\$ 7,02 AV: R\$ 7,02 15: R\$ 7,17
30: R\$ 7,31 45: R\$ 7,46 60: R\$ 7,61



COPO INOX 500ML 14X8,5X8,5CM 110021

Código: Fábrika: Unidade:
39229 SATYAM UN/1
F1 F4

UN: R\$ 2,73 AV: R\$ 2,73 15: R\$ 2,79
30: R\$ 2,84 45: R\$ 2,90 60: R\$ 2,96



COPO LONG DRINK CRISTAL 2654 UN

Código: Fábrika: Unidade:
50677 TRITEC UN/1
F1 F4

UN: R\$ 2,70 AV: R\$ 32,41 15: R\$ 33,09
30: R\$ 33,75 45: R\$ 34,42 60: R\$ 35,11



COPO LONG DRINK CRISTAL 2654 12X1

Código: Fábrika: Unidade:
36234 TRITEC PT/12
F1 F4

UN: R\$ 4,23 AV: R\$ 4,23 15: R\$ 4,32
30: R\$ 4,40 45: R\$ 4,49 60: R\$ 4,58



COPO PLAST DEC 430ML DONUTS 1405

Código: Fábrika: Unidade:
40129 KOZI PLAST UN/1
F1 F4

UN: R\$ 4,23 AV: R\$ 4,23 15: R\$ 4,32
30: R\$ 4,40 45: R\$ 4,49 60: R\$ 4,58



COPO PLAST DEC 430ML FELIZ NATAL 1406

Código: Fábrika: Unidade:
40128 KOZI PLAST UN/1
F1 F4

UN: R\$ 1,94 AV: R\$ 1,94 15: R\$ 2,00
30: R\$ 2,06 45: R\$ 2,12 60: R\$ 2,18



COPO PLAST INF C/TPA BIQUEIRA 985

Código: Fábrika: Unidade:
20058 ERCAPLAST UN/1
F1 F4

UN: R\$ 5,66 AV: R\$ 5,66 15: R\$ 5,78
30: R\$ 5,89 45: R\$ 6,01 60: R\$ 6,13



COPO PLAST INF P/SUCO PLUS 100 ML 130

Código: Fábrika: Unidade:
14574 MAMITA UN/1
F1 F4

UN: R\$ 3,78 AV: R\$ 3,78 15: R\$ 3,86
30: R\$ 3,94 45: R\$ 4,01 60: R\$ 4,09



COPO PLAST INF 245ML C/TPA 1490

Código: Fábrika: Unidade:
47062 JAGUAR UN/1
F1 F4

UN: R\$ 1,90 AV: R\$ 22,82 15: R\$ 23,29
30: R\$ 23,76 45: R\$ 24,23 60: R\$ 24,72



COPO PLAST INF 250 ML DEC 8017 12X1

Código: Fábrika: Unidade:
35221 SBRISSA PT/12
F1 F4

UN: R\$ 1,22 AV: R\$ 14,68 15: R\$ 14,98
30: R\$ 15,28 45: R\$ 15,59 60: R\$ 15,90



COPO PLAST INF 250 ML 7001 12X1

Código: Fábrika: Unidade:
9797 SBRISSA PT/12
F1 F4

Departamento: UTILIDADE Região: GRANDE BH Pagina 40

UN: R\$ 3,43 AV: R\$ 34,26 15: R\$ 34,98
30: R\$ 35,68 45: R\$ 36,39 60: R\$ 37,12



COPO PLAST INF 250ML C/BIC DEC 8018 10X1
Código: 35216 Fábrica: SBRISSA Unidade: PT/10 F1 F4

UN: R\$ 2,25 AV: R\$ 22,51 15: R\$ 22,98
30: R\$ 23,44 45: R\$ 23,91 60: R\$ 24,39



COPO PLAST INF 250ML C/BICO 7011 10X1
Código: 31286 Fábrica: SBRISSA Unidade: PT/10 F1 F4

UN: R\$ 2,61 AV: R\$ 2,61 15: R\$ 2,67
30: R\$ 2,72 45: R\$ 2,78 60: R\$ 2,83



COPO PLAST INF 300 ML COLOR U020
Código: 45740 Fábrica: APAS Unidade: UN/1 F1 F4

UN: R\$ 5,18 AV: R\$ 5,18 15: R\$ 5,29
30: R\$ 5,39 45: R\$ 5,50 60: R\$ 5,61



COPO PLAST INF 300 ML C/TAMPA COLOR U060
Código: 45742 Fábrica: APAS Unidade: UN/1 F1 F4

UN: R\$ 4,75 AV: R\$ 4,75 15: R\$ 4,85
30: R\$ 4,95 45: R\$ 5,04 60: R\$ 5,14



COPO PLAST INF 300 ML C/TAMPA COLOR U061
Código: 45741 Fábrica: APAS Unidade: UN/1 F1 F4

UN: R\$ 48,95 AV: R\$ 48,95 15: R\$ 49,97
30: R\$ 50,97 45: R\$ 51,99 60: R\$ 53,03



COPO PLAST INOX 450ML FLAMENGO 2885
Código: 39042 Fábrica: BRASFOOT Unidade: UN/1 F1 F4

UN: R\$ 48,95 AV: R\$ 48,95 15: R\$ 49,97
30: R\$ 50,97 45: R\$ 51,99 60: R\$ 53,03



COPO PLAST INOX 450ML MEU GAME FORT 1154
Código: 39038 Fábrica: BRASFOOT Unidade: UN/1 F1 F4

UN: R\$ 1,40 AV: R\$ 1,40 15: R\$ 1,43
30: R\$ 1,46 45: R\$ 1,49 60: R\$ 1,52



COPO PLAST LONG DRINK 200ML AMARELO 2285
Código: 40101 Fábrica: MASSARI Unidade: UN/1 F1 F4

UN: R\$ 1,40 AV: R\$ 1,40 15: R\$ 1,43
30: R\$ 1,46 45: R\$ 1,49 60: R\$ 1,52



COPO PLAST LONG DRINK 200ML AZUL 2283
Código: 40100 Fábrica: MASSARI Unidade: UN/1 F1 F4

UN: R\$ 1,40 AV: R\$ 1,40 15: R\$ 1,43
30: R\$ 1,46 45: R\$ 1,49 60: R\$ 1,52



COPO PLAST LONG DRINK 200ML BRANCO 2281
Código: 40098 Fábrica: MASSARI Unidade: UN/1 F1 F4

UN: R\$ 1,40 AV: R\$ 1,40 15: R\$ 1,43
30: R\$ 1,46 45: R\$ 1,49 60: R\$ 1,52



COPO PLAST LONG DRINK 200ML CRISTAL 2280
Código: 40104 Fábrica: MASSARI Unidade: UN/1 F1 F4

UN: R\$ 1,40 AV: R\$ 1,40 15: R\$ 1,43
30: R\$ 1,46 45: R\$ 1,49 60: R\$ 1,52

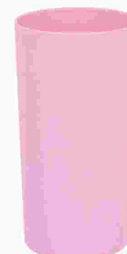

COPO PLAST LONG DRINK 200ML ROSA 2282
Código: 40102 Fábrica: MASSARI Unidade: UN/1 F1 F4

UN: R\$ 1,40 AV: R\$ 1,40 15: R\$ 1,43
30: R\$ 1,46 45: R\$ 1,49 60: R\$ 1,52



COPO PLAST LONG DRINK 200ML VERMELH 2284
Código: 40103 Fábrica: MASSARI Unidade: UN/1 F1 F4

UN: R\$ 2,15 AV: R\$ 2,15 15: R\$ 2,20
30: R\$ 2,24 45: R\$ 2,29 60: R\$ 2,33



COPO PLAST LONG DRINK 350ML CANDY 1317
Código: 38132 Fábrica: KRIA KOISAS Unidade: UN/1 F1 F4

UN: R\$ 4,10 AV: R\$ 4,10 15: R\$ 4,19
30: R\$ 4,27 45: R\$ 4,36 60: R\$ 4,44



COPO PLAST MEDIDA TRANSP 5509
Código: 41667 Fábrica: INPLAST Unidade: UN/1 F1 F4

UN: R\$ 11,26 AV: R\$ 11,26 15: R\$ 11,50
30: R\$ 11,73 45: R\$ 11,96 60: R\$ 12,20



COPO PLAST P/CAIPIRINHA PEQ C/PILAO 403
Código: 33036 Fábrica: TRITEC Unidade: UN/1 F1 F4

UN: R\$ 2,35 AV: R\$ 14,10 15: R\$ 14,39
30: R\$ 14,68 45: R\$ 14,98 60: R\$ 15,28
108 cm



COPO PLAST RETRATIL 8734 6X1

Código: Fábrika: Unidade:
36117 PLASTSANDRI PT/6
F1 F4

UN: R\$ 32,30 AV: R\$ 32,30 15: R\$ 32,98
30: R\$ 33,64 45: R\$ 34,31 60: R\$ 35,00



COPO PLAST TERMICO 200ML ATLETICO 2419

Código: Fábrika: Unidade:
39040 BRASFOOT UN/1
F1 F4

UN: R\$ 1,85 AV: R\$ 7,38 15: R\$ 7,54
30: R\$ 7,69 45: R\$ 7,84 60: R\$ 8,00



COPO PLAST 350ML CONJ 0008 4X1

Código: Fábrika: Unidade:
6187 JAGUAR CJ/4
F1 F4

UN: R\$ 1,75 AV: R\$ 1,75 15: R\$ 1,79
30: R\$ 1,83 45: R\$ 1,86 60: R\$ 1,90



COPO PLAST 350ML 0505

Código: Fábrika: Unidade:
47058 JAGUAR UN/1
F1 F4

UN: R\$ 10,06 AV: R\$ 10,06 15: R\$ 10,27
30: R\$ 10,47 45: R\$ 10,68 60: R\$ 10,89



COPO PLAST 600ML C/TP CANUDO GUERREI 900

Código: Fábrika: Unidade:
42757 LUMAR UN/1
F1 F4

UN: R\$ 10,06 AV: R\$ 10,06 15: R\$ 10,27
30: R\$ 10,47 45: R\$ 10,68 60: R\$ 10,89



COPO PLAST 600ML C/TP CANUDO PRINCES 901

Código: Fábrika: Unidade:
42759 LUMAR UN/1
F1 F4

UN: R\$ 10,06 AV: R\$ 10,06 15: R\$ 10,27
30: R\$ 10,47 45: R\$ 10,68 60: R\$ 10,89



COPO PLAST 600ML C/TP CANUDO SPIDER 899

Código: Fábrika: Unidade:
42756 LUMAR UN/1
F1 F4

UN: R\$ 10,06 AV: R\$ 10,06 15: R\$ 10,27
30: R\$ 10,47 45: R\$ 10,68 60: R\$ 10,89



COPO PLAST 600ML C/TP CANUDO UNICORN 902

Código: Fábrika: Unidade:
42758 LUMAR UN/1
F1 F4

UN: R\$ 68,53 AV: R\$ 68,53 15: R\$ 69,96
30: R\$ 71,36 45: R\$ 72,79 60: R\$ 74,24



COPO TERM INOX 450ML 18X8CM 3696

Código: Fábrika: Unidade:
41459 MABEL UN/1
F1 F4

UN: R\$ 144,91 AV: R\$ 144,91 15: R\$ 147,93
30: R\$ 150,89 45: R\$ 153,91 60: R\$ 156,99



COPO TERM 500ML STONE ATLETICO 10675

Código: Fábrika: Unidade:
41149 BRASFOOT UN/1
F1 F4

UN: R\$ 144,91 AV: R\$ 144,91 15: R\$ 147,93
30: R\$ 150,89 45: R\$ 153,91 60: R\$ 156,99



COPO TERM 500ML STONE CRUZEIRO 10676

Código: Fábrika: Unidade:
41148 BRASFOOT UN/1
F1 F4

UN: R\$ 3,04 AV: R\$ 36,43 15: R\$ 37,19
30: R\$ 37,93 45: R\$ 38,69 60: R\$ 39,46
6 cm
50 ml



COPO VIDRO 50ML TRANSP 732 12X1

Código: Fábrika: Unidade:
40228 HAI BRASIL CJ/12
F1 F4

UN: R\$ 3,87 AV: R\$ 371,34 15: R\$ 379,08
30: R\$ 386,66 45: R\$ 394,39 60: R\$ 402,28
9 cm
4 cm
74 ml



COPO VIDRO 74ML SHOT LEXINGTO 1063 96X1

Código: Fábrika: Unidade:
39521 MULTIPRESENT CX/96
F1 F4

UN: R\$ 14,68 AV: R\$ 14,68 15: R\$ 14,98
30: R\$ 15,28 45: R\$ 15,59 60: R\$ 15,90



COPO VIDRO AMERICANO 190ML ATLETICO10845

Código: Fábrika: Unidade:
41111 BRASFOOT UN/1
F1 F4

UN: R\$ 14,68 AV: R\$ 14,68 15: R\$ 14,98
30: R\$ 15,28 45: R\$ 15,59 60: R\$ 15,90



COPO VIDRO AMERICANO 190ML CRUZEIRO10846

Código: Fábrika: Unidade:
41110 BRASFOOT UN/1
F1 F4

UN: R\$ 1,71 AV: R\$ 41,12 15: R\$ 41,97
30: R\$ 42,81 45: R\$ 43,67 60: R\$ 44,54



COPO VIDRO AMERICANO 190ML 24X1

Código: Fábrika: Unidade:
47410 NADIR CX/24
F1 F4

UN: R\$ 3,67 AV: R\$ 88,12 15: R\$ 89,95
30: R\$ 91,75 45: R\$ 93,59 60: R\$ 95,46



COPO VIDRO AMERICANO 300ML 24X1

Código: Fábrika: Unidade:
50369 NADIR CX/24
F1 F4

UN: R\$ 29,37 AV: R\$ 29,37 15: R\$ 29,98
30: R\$ 30,58 45: R\$ 31,19 60: R\$ 31,81



COPO VIDRO CAIPIRINHA FLAMENGO 9059

Código: Fábrika: Unidade:
39013 BRASFOOT UN/1
F1 F4

UN: R\$ 58,74 AV: R\$ 58,74 15: R\$ 59,97
30: R\$ 61,17 45: R\$ 62,39 60: R\$ 63,64



COPO VIDRO CONJ CAIPIRINHA CRUZEIRO 2426

Código: Fábrika: Unidade:
39123 BRASFOOT UN/1
F1 F4

UN: R\$ 58,74 AV: R\$ 58,74 15: R\$ 59,97
30: R\$ 61,17 45: R\$ 62,39 60: R\$ 63,64



COPO VIDRO CONJ CAIPIRINHA FLAMENGO 2429

Código: Fábrika: Unidade:
39267 BRASFOOT UN/1
F1 F4

UN: R\$ 14,68 AV: R\$ 14,68 15: R\$ 14,98
30: R\$ 15,28 45: R\$ 15,59 60: R\$ 15,90



COPO VIDRO DOSE 60ML ATLETICO 2340

Código: Fábrika: Unidade:
39121 BRASFOOT UN/1
F1 F4

UN: R\$ 9,78 AV: R\$ 9,78 15: R\$ 9,99
30: R\$ 10,19 45: R\$ 10,39 60: R\$ 10,60



COPO VIDRO DOSE 60ML FRASE DE BOTECO3916

Código: Fábrika: Unidade:
39018 BRASFOOT UN/1
F1 F4

UN: R\$ 9,78 AV: R\$ 9,78 15: R\$ 9,99
30: R\$ 10,19 45: R\$ 10,39 60: R\$ 10,60



COPO VIDRO DOSE 60ML HARLEY DAVIDSON 2935

Código: Fábrika: Unidade:
39019 BRASFOOT UN/1
F1 F4

UN: R\$ 9,78 AV: R\$ 9,78 15: R\$ 9,99
30: R\$ 10,19 45: R\$ 10,39 60: R\$ 10,60



COPO VIDRO DOSE 60ML PERAQUEFALTA 1648

Código: Fábrika: Unidade:
39021 BRASFOOT UN/1
F1 F4

UN: R\$ 39,16 AV: R\$ 39,16 15: R\$ 39,97
30: R\$ 40,77 45: R\$ 41,59 60: R\$ 42,42



COPO VIDRO WHISKY ATOL 310ML ATLET 11220

Código: Fábrika: Unidade:
41146 BRASFOOT UN/1
F1 F4

UN: R\$ 39,16 AV: R\$ 39,16 15: R\$ 39,97
30: R\$ 40,77 45: R\$ 41,59 60: R\$ 42,42



COPO VIDRO WHISKY ATOL 310ML CRUZE 11221

Código: Fábrika: Unidade:
41147 BRASFOOT UN/1
F1 F4

UN: R\$ 34,26 AV: R\$ 34,26 15: R\$ 34,98
30: R\$ 35,68 45: R\$ 36,39 60: R\$ 37,12



COPO VIDRO WHISKY ATOL 310ML POKER 4524

Código: Fábrika: Unidade:
39016 BRASFOOT UN/1
F1 F4

UN: R\$ 48,95 AV: R\$ 48,95 15: R\$ 49,97
30: R\$ 50,97 45: R\$ 51,99 60: R\$ 53,03



COPO VIDRO 145ML SCALE 017 6X1

Código: Fábrika: Unidade:
49437 RIOHOME CX/1
F1 F4

UN: R\$ 2,83 AV: R\$ 16,99 15: R\$ 16,99
30: R\$ 16,99 45: R\$ 16,99 60: R\$ 16,99



COPO VIDRO 180 ML TRANSP 18899 6X1

Código: Fábrika: Unidade:
48719 WELLMIX CJ/6
F1 F4

UN: R\$ 2,83 AV: R\$ 16,99 15: R\$ 16,99
30: R\$ 16,99 45: R\$ 16,99 60: R\$ 16,99



COPO VIDRO 180 ML TRANSP 18903 6X1

Código: Fábrika: Unidade:
48717 WELLMIX CJ/6
F1 F4

UN: R\$ 2,83 AV: R\$ 16,99 15: R\$ 16,99
30: R\$ 16,99 45: R\$ 16,99 60: R\$ 16,99



COPO VIDRO 180 ML TRANSP 18905 6X1

Código: Fábrika: Unidade:
48718 WELLMIX CJ/6
F1 F4

UN: R\$ 22,51 AV: R\$ 22,51 15: R\$ 22,98
30: R\$ 23,44 45: R\$ 23,91 60: R\$ 24,39



COPO VIDRO 200ML MUNICH DRAHMA 1255

Código: Fábrika: Unidade:
39035 BRASFOOT UN/1
F1 F4

UN: R\$ 14,99 AV: R\$ 14,99 15: R\$ 14,99
30: R\$ 14,99 45: R\$ 14,99 60: R\$ 14,99



COPO VIDRO 200ML MUNICH MIX 14269
Código: Fábrika: Unidade:
40397 UN-ART UN/1
F1 F4

UN: R\$ 22,51 AV: R\$ 22,51 15: R\$ 22,98
30: R\$ 23,44 45: R\$ 23,91 60: R\$ 24,39



COPO VIDRO 200ML MUNICH SO VOU 1259
Código: Fábrika: Unidade:
39037 BRASFOOT UN/1
F1 F4

UN: R\$ 3,61 AV: R\$ 216,40 15: R\$ 220,91
30: R\$ 225,33 45: R\$ 229,84 60: R\$ 234,43



COPO VIDRO 207 ML TRANSP 60X1
Código: Fábrika: Unidade:
39324 FUTURO CJ/60
F1 F4

UN: R\$ 8,81 AV: R\$ 35,25 15: R\$ 35,99
30: R\$ 36,71 45: R\$ 37,44 60: R\$ 38,19



COPO VIDRO 250ML TRENTO CUBIC 943764 6X1
Código: Fábrika: Unidade:
40891 CEDAR GLASS CJ/4
F1 F4

UN: R\$ 8,81 AV: R\$ 35,25 15: R\$ 35,99
30: R\$ 36,71 45: R\$ 37,44 60: R\$ 38,19



COPO VIDRO 250ML TRENTO ROMAN 943765 6X1
Código: Fábrika: Unidade:
40783 CEDAR GLASS CJ/4
F1 F4

UN: R\$ 8,81 AV: R\$ 35,25 15: R\$ 35,99
30: R\$ 36,71 45: R\$ 37,44 60: R\$ 38,19



COPO VIDRO 290ML TRENTO SMALL 943762 6X1
Código: Fábrika: Unidade:
40890 CEDAR GLASS CJ/4
F1 F4

UN: R\$ 6,46 AV: R\$ 129,25 15: R\$ 131,95
30: R\$ 134,59 45: R\$ 137,28 60: R\$ 140,02



COPO VIDRO 300ML CHOPP ROSTOCK 1035 20X1
Código: Fábrika: Unidade:
51078 MULTIPRESENT CX/20
F1 F4

UN: R\$ 6,45 AV: R\$ 154,71 15: R\$ 157,94
30: R\$ 161,10 45: R\$ 164,32 60: R\$ 167,60



COPO VIDRO 300ML CHOPP ROSTOCK 1035 24X1
Código: Fábrika: Unidade:
39531 MULTIPRESENT CX/24
F1 F4

UN: R\$ 4,78 AV: R\$ 343,99 15: R\$ 351,16
30: R\$ 358,18 45: R\$ 365,35 60: R\$ 372,65



COPO VIDRO 340ML ALTO MONTECAR 1193 72X1
Código: Fábrika: Unidade:
39529 MULTIPRESENT CX/72
F1 F4

UN: R\$ 5,88 AV: R\$ 423,01 15: R\$ 431,83
30: R\$ 440,46 45: R\$ 449,27 60: R\$ 458,26



COPO VIDRO 348ML ALTO ALEGRO 1053 72X1
Código: Fábrika: Unidade:
39525 MULTIPRESENT CX/72
F1 F4

UN: R\$ 6,01 AV: R\$ 144,29 15: R\$ 147,29
30: R\$ 150,24 45: R\$ 153,24 60: R\$ 156,31



COPO VIDRO 350ML CHOPP TRANSP VD52 24X1
Código: Fábrika: Unidade:
40300 MAXXIMUS CX/24
F1 F4

UN: R\$ 41,49 AV: R\$ 41,49 15: R\$ 42,35
30: R\$ 43,20 45: R\$ 44,06 60: R\$ 44,95



COQUETELEIRA INOX 500 ML 924
Código: Fábrika: Unidade:
50068 PLANETA UN/1
F1 F4

UN: R\$ 21,53 AV: R\$ 21,53 15: R\$ 21,98
30: R\$ 22,42 45: R\$ 22,87 60: R\$ 23,33



COQUETELEIRA PLAST 600ML NOW OR NERVER75
Código: Fábrika: Unidade:
39137 BRASFOOT UN/1
F1 F4

UN: R\$ 21,53 AV: R\$ 21,53 15: R\$ 21,98
30: R\$ 22,42 45: R\$ 22,87 60: R\$ 23,33



COQUETELEIRA PLAST 600ML PUSH YOUR LIMIT
Código: Fábrika: Unidade:
39138 BRASFOOT UN/1
F1 F4

UN: R\$ 21,53 AV: R\$ 21,53 15: R\$ 21,98
30: R\$ 22,42 45: R\$ 22,87 60: R\$ 23,33



COQUETELEIRA PLAST 600ML TODA CONQUISTA
Código: Fábrika: Unidade:
39139 BRASFOOT UN/1
F1 F4

UN: R\$ 21,53 AV: R\$ 21,53 15: R\$ 21,98
30: R\$ 22,42 45: R\$ 22,87 60: R\$ 23,33



COQUETELEIRA PLAST 600ML TREINE COMO UMA
Código: Fábrika: Unidade:
39140 BRASFOOT UN/1
F1 F4

UN: R\$ 283,60 AV: R\$ 283,60 15: R\$ 289,50
30: R\$ 295,29 45: R\$ 301,20 60: R\$ 307,22

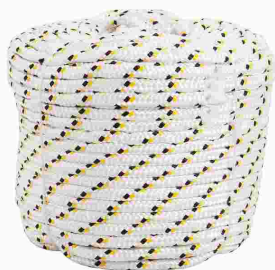

CORDA TRANCADA 14MM 50 MTS 4,5KG
Código: Fábrika: Unidade:
46809 VONDER RL/1
F1 F4

UN: R\$ 3,18 AV: R\$ 38,19 15: R\$ 38,98
30: R\$ 39,76 45: R\$ 40,56 60: R\$ 41,37



CORDA VARAL ACO ENCAPADO 10 MTS 12X1
Código: Fábrika: Unidade:
29842 DEL WAL PT/12
F1 F4

UN: R\$ 4,97 AV: R\$ 59,61 15: R\$ 60,86
30: R\$ 62,07 45: R\$ 63,31 60: R\$ 64,58



CORDA VARAL ACO ENCAPADO 15 MTS 12X1
Código: Fábrika: Unidade:
29843 DEL WAL PT/12
F1 F4

UN: R\$ 6,36 AV: R\$ 76,38 15: R\$ 77,97
30: R\$ 79,53 45: R\$ 81,12 60: R\$ 82,74



CORDA VARAL ACO ENCAPADO 20 MTS 12X1
Código: Fábrika: Unidade:
29844 DEL WAL PT/12
F1 F4

UN: R\$ 4,89 AV: R\$ 4,89 15: R\$ 4,99
30: R\$ 5,09 45: R\$ 5,19 60: R\$ 5,29



CORDA VARAL NYLON 3MM 10 MTS 1540
Código: Fábrika: Unidade:
41539 ELITE UN/1
F1 F4

UN: R\$ 5,87 AV: R\$ 5,87 15: R\$ 5,99
30: R\$ 6,11 45: R\$ 6,23 60: R\$ 6,35



CORDA VARAL NYLON 4MM 10 MTS 2938
Código: Fábrika: Unidade:
41545 ELITE UN/1
F1 F4

UN: R\$ 9,50 AV: R\$ 9,50 15: R\$ 9,70
30: R\$ 9,89 45: R\$ 10,09 60: R\$ 10,29



CORDA VARAL NYLON 5MM 20 MTS 3556
Código: Fábrika: Unidade:
49628 WINMAX UN/1
F1 F4

UN: R\$ 3,18 AV: R\$ 3,18 15: R\$ 3,25
30: R\$ 3,31 45: R\$ 3,38 60: R\$ 3,45



CORDA VARAL PLAST MULTI USO 5 MTS 93003
Código: Fábrika: Unidade:
45877 ALMEGA UN/1
F1 F4

UN: R\$ 4,89 AV: R\$ 4,89 15: R\$ 4,99
30: R\$ 5,09 45: R\$ 5,19 60: R\$ 5,29



CORDA VARAL PLAST MULTI USO 10 MTS 93002
Código: Fábrika: Unidade:
34656 ALMEGA UN/1
F1 F4

UN: R\$ 7,39 AV: R\$ 7,39 15: R\$ 7,55
30: R\$ 7,70 45: R\$ 7,85 60: R\$ 8,01



CORDA VARAL PLAST 5MM 10 MTS 93002
Código: Fábrika: Unidade:
45529 WINMAX UN/1
F1 F4

UN: R\$ 4,40 AV: R\$ 4,40 15: R\$ 4,49
30: R\$ 4,58 45: R\$ 4,67 60: R\$ 4,76



CORDA VARAL POLIESTER 15 MTS UNIVER 614
Código: Fábrika: Unidade:
46871 PLANETA UN/1
F1 F4

UN: R\$ 16,65 AV: R\$ 16,65 15: R\$ 16,99
30: R\$ 17,33 45: R\$ 17,68 60: R\$ 18,03

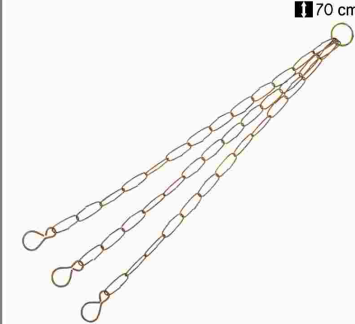

CORRENTAO METAL DOURADA XAXIM 70CM
Código: Fábrika: Unidade:
39471 WS CORRENTES UN/1
F1 F4

UN: R\$ 13,71 AV: R\$ 164,51 15: R\$ 167,93
30: R\$ 171,29 45: R\$ 174,72 60: R\$ 178,21



CORRENTAO METAL DOURADA XAXIM 70CM 12X1
Código: Fábrika: Unidade:
39470 WS CORRENTES PT/12
F1 F4

UN: R\$ 9,79 AV: R\$ 117,49 15: R\$ 119,94
30: R\$ 122,34 45: R\$ 124,79 60: R\$ 127,28



CORRENTE METAL DOURADA XAXIM 84CM 12X1
Código: Fábrika: Unidade:
39472 WS CORRENTES PT/12
F1 F4

UN: R\$ 9,06 AV: R\$ 9,06 15: R\$ 9,25
30: R\$ 9,43 45: R\$ 9,62 60: R\$ 9,81



CORTADOR INOX MELANCIA 25,5CM 3029
Código: Fábrika: Unidade:
44730 WINCY UN/1
F1 F4

UN: R\$ 8,31 AV: R\$ 8,31 15: R\$ 8,49
30: R\$ 8,66 45: R\$ 8,83 60: R\$ 9,01

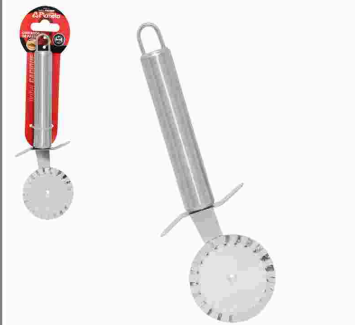

CORTADOR INOX PASTEL CACIQUE 19,5CM 145
Código: Fábrika: Unidade:
39356 PLANETA UN/1
F1 F4

UN: R\$ 8,31 AV: R\$ 8,31 15: R\$ 8,49
30: R\$ 8,66 45: R\$ 8,83 60: R\$ 9,01

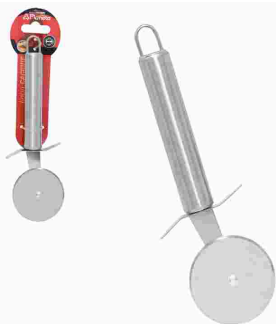

CORTADOR INOX PIZZA CACIQUE 20,5CM 146
Código: Fábrica: Unidade:
39355 PLANETA UN/1
F1 F4

UN: R\$ 6,84 AV: R\$ 6,84 15: R\$ 6,99
30: R\$ 7,13 45: R\$ 7,27 60: R\$ 7,41



CORTADOR INOX QUEIJO 22X7,5CM 147-103
Código: Fábrica: Unidade:
47149 NICOBEM UN/1
F1 F4

UN: R\$ 19,73 AV: R\$ 19,73 15: R\$ 20,14
30: R\$ 20,54 45: R\$ 20,96 60: R\$ 21,37

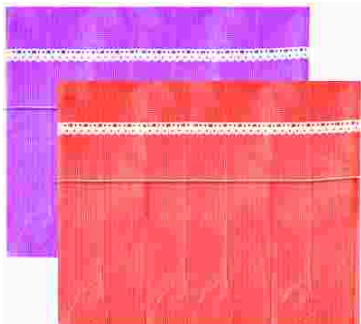

CORTINA P/PIA P 120X90CM
Código: Fábrica: Unidade:
11294 FERREIRA UN/1
F1 F4

UN: R\$ 8,80 AV: R\$ 8,80 15: R\$ 8,99
30: R\$ 9,17 45: R\$ 9,35 60: R\$ 9,54



CUMBUCA BARRO 300 ML RED
Código: Fábrica: Unidade:
30157 AVELAR UN/1
F4

UN: R\$ 9,78 AV: R\$ 9,78 15: R\$ 9,99
30: R\$ 10,19 45: R\$ 10,39 60: R\$ 10,60



CUMBUCA BARRO 400 ML RED
Código: Fábrica: Unidade:
36288 AVELAR UN/1
F1 F4

UN: R\$ 3,12 AV: R\$ 3,12 15: R\$ 3,19
30: R\$ 3,25 45: R\$ 3,32 60: R\$ 3,38



CUMBUCA PLAST 500 ML OVAL 11X15CM 683
Código: Fábrica: Unidade:
50343 QUALYPLAS UN/1
F1 F4

UN: R\$ 5,55 AV: R\$ 5,55 15: R\$ 5,67
30: R\$ 5,78 45: R\$ 5,90 60: R\$ 6,01



CUMBUCA PLAST 650 ML COLOR 907
Código: Fábrica: Unidade:
42762 LUMAR UN/1
F1 F4

UN: R\$ 34,26 AV: R\$ 34,26 15: R\$ 34,98
30: R\$ 35,68 45: R\$ 36,39 60: R\$ 37,12



CUSCUZEIRO ALUM 14 1147
Código: Fábrica: Unidade:
35271 MSR UN/1
F1 F4

UN: R\$ 40,88 AV: R\$ 40,88 15: R\$ 41,73
30: R\$ 42,57 45: R\$ 43,42 60: R\$ 44,29



CUSCUZEIRO ALUM 16 668
Código: Fábrica: Unidade:
35272 MSR UN/1
F1 F4

UN: R\$ 45,03 AV: R\$ 45,03 15: R\$ 45,97
30: R\$ 46,89 45: R\$ 47,83 60: R\$ 48,79



CUSCUZEIRO ALUM 18 669
Código: Fábrica: Unidade:
35273 MSR UN/1
F1 F4

UN: R\$ 4,20 AV: R\$ 4,20 15: R\$ 4,29
30: R\$ 4,37 45: R\$ 4,46 60: R\$ 4,55



DEBULHADOR PLAST MILHO 11,5X7CM 3204
Código: Fábrica: Unidade:
44724 WINCY UN/1
F1 F4

UN: R\$ 9,52 AV: R\$ 9,52 15: R\$ 9,72
30: R\$ 9,91 45: R\$ 10,11 60: R\$ 10,31



DECORADOR PLAST P/BOLO C/8 BICOS 7139
Código: Fábrica: Unidade:
38346 ALIANCA UN/1
F1 F4

UN: R\$ 6,61 AV: R\$ 6,61 15: R\$ 6,75
30: R\$ 6,88 45: R\$ 7,02 60: R\$ 7,16

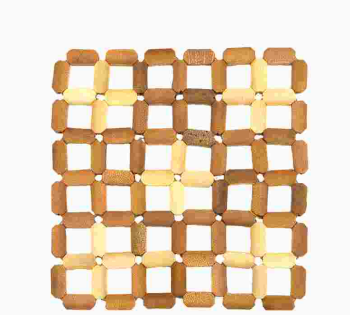

DESCANSO P/PANELAS BAMBU (ESTEIRA) 14752
Código: Fábrica: Unidade:
44524 NICOBEM UN/1
F1 F4

UN: R\$ 6,92 AV: R\$ 6,92 15: R\$ 7,07
30: R\$ 7,21 45: R\$ 7,35 60: R\$ 7,50

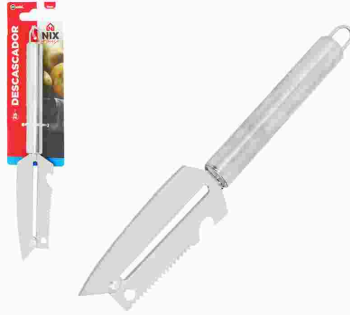

DESCASCADOR FATIAD INOX 25CM LEGUMES 063
Código: Fábrica: Unidade:
47334 NIX UN/1
F1 F4

UN: R\$ 7,82 AV: R\$ 7,82 15: R\$ 7,99
30: R\$ 8,15 45: R\$ 8,31 60: R\$ 8,48



DESCASCADOR MANUAL FRUTAS LEGUMES 147-57
Código: Fábrica: Unidade:
46740 NICOBEM UN/1
F1 F4

UN: R\$ 7,33 AV: R\$ 7,33 15: R\$ 7,49
30: R\$ 7,64 45: R\$ 7,79 60: R\$ 7,95



DESENTUPIDOR DE PIA SANFONADO 5033
Código: Fábrica: Unidade:
47251 SHANGRILA UN/1
F1 F4

UN: R\$ 10,76 AV: R\$ 10,76 15: R\$ 10,99
30: R\$ 11,21 45: R\$ 11,43 60: R\$ 11,66



DESENTUPIDOR SANITARIO WC 332

Código: 5544 Fábrica: N.HORIZONTE Unidade: UN/1 F1 F4

UN: R\$ 4,90 AV: R\$ 4,90 15: R\$ 5,00
30: R\$ 5,10 45: R\$ 5,20 60: R\$ 5,30



DISPENSADOR VIDRO 210ML ACUCAR 18394

Código: 40902 Fábrica: FUTURO Unidade: UN/1 F1 F4

UN: R\$ 63,64 AV: R\$ 63,64 15: R\$ 64,96
30: R\$ 66,26 45: R\$ 67,59 60: R\$ 68,94



DISPENSER INOX CILIND P/COPO AGUA 200ML

Código: 41851 Fábrica: AURIMAR Unidade: UN/1 F1 F4

UN: R\$ 39,16 AV: R\$ 39,16 15: R\$ 39,97
30: R\$ 40,77 45: R\$ 41,59 60: R\$ 42,42



DISPENSER PLAST PAPEL HIG ROLAO 300/500M

Código: 47834 Fábrica: NOBRE Unidade: UN/1 F1 F4

UN: R\$ 34,26 AV: R\$ 34,26 15: R\$ 34,98
30: R\$ 35,68 45: R\$ 36,39 60: R\$ 37,12



DISPENSER PLAST PAPEL TOALHA 1/3D 39999

Código: 47832 Fábrica: NOBRE Unidade: UN/1 F1 F4

UN: R\$ 107,70 AV: R\$ 107,70 15: R\$ 109,95
30: R\$ 112,14 45: R\$ 114,39 60: R\$ 116,68



DISPENSER PLAST POUPADOR COPO AGUA 200ML

Código: 47831 Fábrica: NOBRE Unidade: UN/1 F1 F4

UN: R\$ 39,16 AV: R\$ 39,16 15: R\$ 39,97
30: R\$ 40,77 45: R\$ 41,59 60: R\$ 42,42



DISPENSER PLAST SABONE LIQ/ALCOOL 800ML

Código: 47833 Fábrica: NOBRE Unidade: UN/1 F1 F4

UN: R\$ 1,52 AV: R\$ 3,05 15: R\$ 3,11
30: R\$ 3,17 45: R\$ 3,23 60: R\$ 3,30



DOSADOR PLASTICO GARRAFA 707 2X1

Código: 27647 Fábrica: CLINK Unidade: PT/2 F1 F4

UN: R\$ 35,24 AV: R\$ 35,24 15: R\$ 35,98
30: R\$ 36,70 45: R\$ 37,43 60: R\$ 38,18



EBULIDOR ALUMINIO 127 V 1000W PEQ 101/WA

Código: 22827 Fábrica: IMC/RESIS Unidade: UN/1 F1 F4

UN: R\$ 51,89 AV: R\$ 51,89 15: R\$ 52,97
30: R\$ 54,03 45: R\$ 55,11 60: R\$ 56,21



EBULIDOR ALUMINIO 127 V 2000W GDE 103

Código: 27093 Fábrica: IMC/RESISWAL Unidade: UN/1 F1 F4

UN: R\$ 34,26 AV: R\$ 34,26 15: R\$ 34,98
30: R\$ 35,68 45: R\$ 36,39 60: R\$ 37,12



EBULIDOR ALUMINIO 220 V 1000W PEQ 104

Código: 26118 Fábrica: IMC/RESISWAL Unidade: UN/1 F1 F4

UN: R\$ 51,89 AV: R\$ 51,89 15: R\$ 52,97
30: R\$ 54,03 45: R\$ 55,11 60: R\$ 56,21



EBULIDOR ALUMINIO 220 V 2000W GDE GB

Código: 41653 Fábrica: IMC/RESISWAL Unidade: UN/1 F1 F4

UN: R\$ 14,19 AV: R\$ 14,19 15: R\$ 14,48
30: R\$ 14,77 45: R\$ 15,07 60: R\$ 15,37



EMBALAGEM C/ALCA P/MUDA PL 21 LTS PRETO

Código: 41374 Fábrica: NUTRIPLAN Unidade: UN/1 F1 F4

UN: R\$ 18,11 AV: R\$ 18,11 15: R\$ 18,48
30: R\$ 18,85 45: R\$ 19,23 60: R\$ 19,61



EMBALAGEM C/ALCA P/MUDA PL 33 LTS PRETO

Código: 41373 Fábrica: NUTRIPLAN Unidade: UN/1 F1 F4

UN: R\$ 21,53 AV: R\$ 21,53 15: R\$ 21,98
30: R\$ 22,42 45: R\$ 22,87 60: R\$ 23,33



EMBALAGEM C/ALCA P/MUDA PL 39 LTS PRETO

Código: 41375 Fábrica: NUTRIPLAN Unidade: UN/1 F1 F4

UN: R\$ 25,45 AV: R\$ 25,45 15: R\$ 25,98
30: R\$ 26,50 45: R\$ 27,03 60: R\$ 27,57



EMBALAGEM C/ALCA P/MUDA PL 40 LTS PRETO

Código: 41376 Fábrica: NUTRIPLAN Unidade: UN/1 F1 F4

UN: R\$ 32,30 AV: R\$ 32,30 15: R\$ 32,98
30: R\$ 33,64 45: R\$ 34,31 60: R\$ 35,00



EMBALAGEM C/ALCA P/MUDA PL 50 LTS PRETO
Código: 41377 Fábrica: NUTRIPLAN Unidade: UN/1 F1 F4

UN: R\$ 43,08 AV: R\$ 43,08 15: R\$ 43,97
30: R\$ 44,85 45: R\$ 45,75 60: R\$ 46,66



EMBALAGEM C/ALCA P/MUDA PL 60 LTS PRETO
Código: 41378 Fábrica: NUTRIPLAN Unidade: UN/1 F1 F4

UN: R\$ 55,80 AV: R\$ 55,80 15: R\$ 56,97
30: R\$ 58,11 45: R\$ 59,27 60: R\$ 60,45



EMBALAGEM C/ALCA P/MUDA PL 85 LTS PRETO
Código: 41379 Fábrica: NUTRIPLAN Unidade: UN/1 F1 F4

UN: R\$ 78,33 AV: R\$ 78,33 15: R\$ 79,96
30: R\$ 81,56 45: R\$ 83,19 60: R\$ 84,85



EMBALAGEM C/ALCA P/MUDA PL 110 LTS PTO
Código: 41380 Fábrica: NUTRIPLAN Unidade: UN/1 F1 F4

UN: R\$ 1,70 AV: R\$ 1,70 15: R\$ 1,74
30: R\$ 1,77 45: R\$ 1,81 60: R\$ 1,85
12 cm
12 cm
1 lts



EMBALAGEM P/MUDA PL 1 LT PRETO
Código: 38912 Fábrica: NUTRIPLAN Unidade: UN/1 F1 F4

UN: R\$ 3,59 AV: R\$ 3,59 15: R\$ 3,67
30: R\$ 3,74 45: R\$ 3,82 60: R\$ 3,89
Altura : 15 cm
Larg : 18 cm



EMBALAGEM P/MUDA PL 2,8 LTS PRETO
Código: 30320 Fábrica: NUTRIPLAN Unidade: UN/1 F1 F4

UN: R\$ 4,77 AV: R\$ 4,77 15: R\$ 4,87
30: R\$ 4,97 45: R\$ 5,06 60: R\$ 5,17
Altura : 20 cm
Larg : 20 cm



EMBALAGEM P/MUDA PL 5 LTS PRETO
Código: 30318 Fábrica: NUTRIPLAN Unidade: UN/1 F1 F4

UN: R\$ 5,87 AV: R\$ 5,87 15: R\$ 5,99
30: R\$ 6,11 45: R\$ 6,23 60: R\$ 6,35



EMBALAGEM P/MUDA PL 7 LTS PRETO
Código: 41372 Fábrica: NUTRIPLAN Unidade: UN/1 F1 F4

UN: R\$ 6,16 AV: R\$ 6,16 15: R\$ 6,29
30: R\$ 6,41 45: R\$ 6,54 60: R\$ 6,67
Altura : 22 cm
Larg : 23 cm



EMBALAGEM P/MUDA PL 8 LTS PRETO
Código: 30319 Fábrica: NUTRIPLAN Unidade: UN/1 F1 F4

UN: R\$ 7,56 AV: R\$ 7,56 15: R\$ 7,72
30: R\$ 7,87 45: R\$ 8,03 60: R\$ 8,19
25cm
25 cm
10 lts



EMBALAGEM P/MUDA PL 10 LTS PRETO
Código: 38915 Fábrica: NUTRIPLAN Unidade: UN/1 F1 F4

UN: R\$ 6,56 AV: R\$ 6,56 15: R\$ 6,70
30: R\$ 6,83 45: R\$ 6,97 60: R\$ 7,11
24 cm
27,5 cm



EMBALAGEM P/MUDA PL 11 LTS PRETO
Código: 31389 Fábrica: NUTRIPLAN Unidade: UN/1 F1 F4

UN: R\$ 7,44 AV: R\$ 7,44 15: R\$ 7,60
30: R\$ 7,75 45: R\$ 7,90 60: R\$ 8,06
28cm
28 cm
14.3 lts



EMBALAGEM P/MUDA PL 14,3 LTS PRETO
Código: 38913 Fábrica: NUTRIPLAN Unidade: UN/1 F1 F4

UN: R\$ 9,30 AV: R\$ 9,30 15: R\$ 9,50
30: R\$ 9,69 45: R\$ 9,88 60: R\$ 10,08
30 cm
30 cm
18 lts



EMBALAGEM P/MUDA PL 18 LTS PRETO
Código: 33531 Fábrica: NUTRIPLAN Unidade: UN/1 F1 F4

UN: R\$ 11,65 AV: R\$ 11,65 15: R\$ 11,90
30: R\$ 12,13 45: R\$ 12,38 60: R\$ 12,62
35cm
34 cm
25 lts



EMBALAGEM P/MUDA PL 25 LTS PRETO
Código: 38914 Fábrica: NUTRIPLAN Unidade: UN/1 F1 F4

UN: R\$ 15,66 AV: R\$ 15,66 15: R\$ 15,98
30: R\$ 16,30 45: R\$ 16,63 60: R\$ 16,96



EMBALAGEM P/MUDA PL 35 LTS PRETO
Código: 41401 Fábrica: NUTRIPLAN Unidade: UN/1 F1 F4

UN: R\$ 7,41 AV: R\$ 7,41 15: R\$ 7,57
30: R\$ 7,72 45: R\$ 7,87 60: R\$ 8,03



EMENDA PLAST MANGUEIRA SMART 212
Código: 40239 Fábrica: MONTEREY Unidade: UN/1 F1 F4

UN: R\$ 12,27 AV: R\$ 12,27 15: R\$ 12,53
30: R\$ 12,78 45: R\$ 13,03 60: R\$ 13,29



ENGATE RAPIDO PLAST MANGUEIRA 4X1 4092
Código: Fábrica: Unidade:
50145 GP6 CR/1
F1 F4

UN: R\$ 27,81 AV: R\$ 27,81 15: R\$ 28,39
30: R\$ 28,96 45: R\$ 29,54 60: R\$ 30,13



ESCORREDOR ACO INOX 18X10CM 9375
Código: Fábrica: Unidade:
50219 CASITA UN/1
F1 F4

UN: R\$ 34,26 AV: R\$ 34,26 15: R\$ 34,98
30: R\$ 35,68 45: R\$ 36,39 60: R\$ 37,12



ESCORREDOR ACO INOX 28X35X14CM 9376
Código: Fábrica: Unidade:
50218 CASITA UN/1
F1 F4

UN: R\$ 23,49 AV: R\$ 23,49 15: R\$ 23,98
30: R\$ 24,46 45: R\$ 24,95 60: R\$ 25,45



ESCORREDOR ALUM ARROZ 670
Código: Fábrica: Unidade:
6733 MSR UN/1
F1 F4

UN: R\$ 170,38 AV: R\$ 170,38 15: R\$ 173,93
30: R\$ 177,41 45: R\$ 180,96 60: R\$ 184,58



ESCORREDOR ALUM MACARRAO HOTEL 45
Código: Fábrica: Unidade:
50168 MSR UN/1
F1 F4

UN: R\$ 52,87 AV: R\$ 52,87 15: R\$ 53,97
30: R\$ 55,05 45: R\$ 56,15 60: R\$ 57,27



ESCORREDOR CROM PRAT/COP MEIA LUA 806
Código: Fábrica: Unidade:
33913 ARAMINAS UN/1
F1 F4

UN: R\$ 38,18 AV: R\$ 38,18 15: R\$ 38,97
30: R\$ 39,75 45: R\$ 40,55 60: R\$ 41,36



ESCORREDOR CROM PRAT/COP MINI 947
Código: Fábrica: Unidade:
49960 ARAMINAS UN/1
F1 F4

UN: R\$ 63,64 AV: R\$ 63,64 15: R\$ 64,96
30: R\$ 66,26 45: R\$ 67,59 60: R\$ 68,94



ESCORREDOR CROM PRAT/COP 2AND 39X25CM 31
Código: Fábrica: Unidade:
24607 ARAMINAS UN/1
F1 F4

UN: R\$ 46,99 AV: R\$ 46,99 15: R\$ 47,97
30: R\$ 48,93 45: R\$ 49,91 60: R\$ 50,91

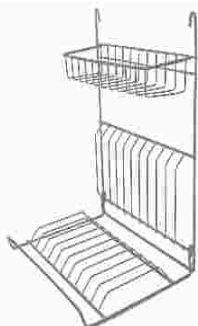

ESCORREDOR CROM PRATO PAREDE 563
Código: Fábrica: Unidade:
28955 ARAMINAS UN/1
F1 F4

UN: R\$ 38,97 AV: R\$ 38,97 15: R\$ 39,78
30: R\$ 40,58 45: R\$ 41,39 60: R\$ 42,22

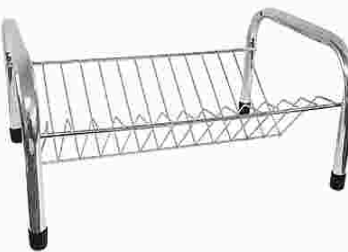

ESCORREDOR CROM PRATO SIMPLES 697
Código: Fábrica: Unidade:
20174 ARAMINAS UN/1
F1 F4

UN: R\$ 65,60 AV: R\$ 65,60 15: R\$ 66,96
30: R\$ 68,30 45: R\$ 69,67 60: R\$ 71,06



ESCORREDOR CROM PRATO/COPO 32 BAIXO41X32
Código: Fábrica: Unidade:
24608 ARAMINAS UN/1
F1 F4

UN: R\$ 56,78 AV: R\$ 56,78 15: R\$ 57,97
30: R\$ 59,13 45: R\$ 60,31 60: R\$ 61,51



ESCORREDOR CROM 2AND TUBULAR 30
Código: Fábrica: Unidade:
40248 ARAMINAS UN/1
F1 F4

UN: R\$ 3,42 AV: R\$ 3,42 15: R\$ 3,49
30: R\$ 3,56 45: R\$ 3,63 60: R\$ 3,70



ESCORREDOR PLAST ARROZ CORES 467
Código: Fábrica: Unidade:
46642 QUALYPLAS UN/1
F1 F4

UN: R\$ 8,24 AV: R\$ 8,24 15: R\$ 8,42
30: R\$ 8,59 45: R\$ 8,76 60: R\$ 8,93



ESCORREDOR PLAST ARROZ 5589
Código: Fábrica: Unidade:
35485 TRITEC UN/1
F1 F4

UN: R\$ 13,70 AV: R\$ 13,70 15: R\$ 13,98
30: R\$ 14,26 45: R\$ 14,55 60: R\$ 14,84



ESCORREDOR PLAST LOUCA PRETO 410
Código: Fábrica: Unidade:
48378 PLASMARC UN/1
F1 F4

UN: R\$ 15,14 AV: R\$ 15,14 15: R\$ 15,45
30: R\$ 15,76 45: R\$ 16,08 60: R\$ 16,40



ESCORREDOR PLAST MASSAS 0013
Código: Fábrica: Unidade:
2675 JAGUAR UN/1
F1 F4

UN: R\$ 11,41 AV: R\$ 11,41 15: R\$ 11,65
30: R\$ 11,88 45: R\$ 12,12 60: R\$ 12,36
11cm
30cm



ESCORREDOR PLAST MULTI USO C/ALCAS 987
Código: Fábrica: Unidade:
46673 LUMAR UN/1
F1 F4

UN: R\$ 22,91 AV: R\$ 22,91 15: R\$ 23,39
30: R\$ 23,86 45: R\$ 24,34 60: R\$ 24,82

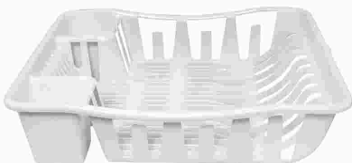

ESCORREDOR PLAST PRATO 503
Código: Fábrica: Unidade:
35487 TRITEC UN/1
F1 F4

UN: R\$ 19,08 AV: R\$ 19,08 15: R\$ 19,48
30: R\$ 19,87 45: R\$ 20,27 60: R\$ 20,67
10cm
48cm



ESCORREDOR PLAST PRATOS 16
Código: Fábrica: Unidade:
2076 JAGUAR UN/1
F1 F4

UN: R\$ 4,37 AV: R\$ 4,37 15: R\$ 4,46
30: R\$ 4,55 45: R\$ 4,64 60: R\$ 4,73
3 cm
39 cm
12,5cm



ESCORREDOR PLAST P/TINTA DE PINTURA
Código: Fábrica: Unidade:
40076 MOLDE MINAS UN/1
F1 F4

UN: R\$ 4,41 AV: R\$ 52,88 15: R\$ 53,98
30: R\$ 55,06 45: R\$ 56,16 60: R\$ 57,28



ESCOVA LAVAR ROUPA MAD OVAL MAX 4 12X1
Código: Fábrica: Unidade:
28872 N.HORIZONTE PT/12
F1 F4

UN: R\$ 3,90 AV: R\$ 46,79 15: R\$ 47,76
30: R\$ 48,72 45: R\$ 49,69 60: R\$ 50,68



ESCOVA LAVAR ROUPA MAD OVAL MED 3 12X1
Código: Fábrica: Unidade:
7122 N.HORIZONTE PT/12
F1 F4

UN: R\$ 3,26 AV: R\$ 39,16 15: R\$ 39,97
30: R\$ 40,77 45: R\$ 41,59 60: R\$ 42,42



ESCOVA LAVAR ROUPA MAD OVAL PEQ 5 12X1
Código: Fábrica: Unidade:
34403 N.HORIZONTE PT/12
F1 F4

UN: R\$ 4,04 AV: R\$ 48,47 15: R\$ 49,48
30: R\$ 50,47 45: R\$ 51,48 60: R\$ 52,51



ESCOVA LAVAR ROUPA MAD RET MED 26 12X1
Código: Fábrica: Unidade:
28135 N.HORIZONTE PT/12
F1 F4

UN: R\$ 3,18 AV: R\$ 38,18 15: R\$ 38,97
30: R\$ 39,75 45: R\$ 40,55 60: R\$ 41,36



ESCOVA LAVAR ROUPA MAD RET PEQ 12X1
Código: Fábrica: Unidade:
36310 N.HORIZONTE PT/12
F1 F4

UN: R\$ 4,24 AV: R\$ 50,91 15: R\$ 51,97
30: R\$ 53,01 45: R\$ 54,07 60: R\$ 55,15



ESCOVA LAVAR ROUPA MAD 16 MED 85175 12X1
Código: Fábrica: Unidade:
6290 CONDOR DZ/12
F1 F4

UN: R\$ 4,08 AV: R\$ 4,08 15: R\$ 4,17
30: R\$ 4,25 45: R\$ 4,34 60: R\$ 4,42



ESCOVA LAVAR ROUPA PLAST ANTIDERRAP UN
Código: Fábrica: Unidade:
20137 N.HORIZONTE UN/1
F1 F4

UN: R\$ 5,71 AV: R\$ 68,53 15: R\$ 69,96
30: R\$ 71,36 45: R\$ 72,79 60: R\$ 74,24



ESCOVA LAVAR ROUPA PLAST OVAL 25 12X1
Código: Fábrica: Unidade:
22595 N.HORIZONTE PT/12
F1 F4

UN: R\$ 4,30 AV: R\$ 4,30 15: R\$ 4,39
30: R\$ 4,48 45: R\$ 4,57 60: R\$ 4,66



ESCOVA LAVAR ROUPA UN
Código: Fábrica: Unidade:
47255 SHANG/NHORIZ UN/1
F1 F4

UN: R\$ 6,84 AV: R\$ 6,84 15: R\$ 6,99
30: R\$ 7,13 45: R\$ 7,27 60: R\$ 7,41



ESCOVA MAD P/SAPATO 6/287
Código: Fábrica: Unidade:
28136 N.HORIZONTE UN/1
F1 F4

UN: R\$ 7,82 AV: R\$ 7,82 15: R\$ 7,99
30: R\$ 8,15 45: R\$ 8,31 60: R\$ 8,48

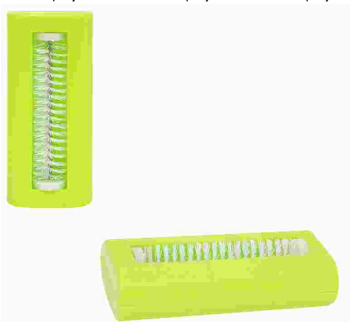

ESCOVA PLAST LIMPEZA 15,5CM 1467
Código: Fábrica: Unidade:
41542 ELITE UN/1
F1 F4

UN: R\$ 6,84 AV: R\$ 6,84 15: R\$ 6,99
30: R\$ 7,13 45: R\$ 7,27 60: R\$ 7,41



ESCOVA P/ROUPA MAD RET MULTI USO 29/316
Código: Fábrica: Unidade:
28873 N.HORIZONTE UN/1
F1 F4

UN: R\$ 3,26 AV: R\$ 39,16 15: R\$ 39,97
30: R\$ 40,77 45: R\$ 41,59 60: R\$ 42,42



ESCOVA SANIT LAVATINA NYLON 12X1

Código: 29313 Fábrica: N.HORIZONTE Unidade: DZ/12 F1 F4

UN: R\$ 4,49 AV: R\$ 4,49 15: R\$ 4,59
30: R\$ 4,68 45: R\$ 4,77 60: R\$ 4,87



ESCOVA SANITARIA CB PLAST C/SUP AZUL 151

Código: 46865 Fábrica: PLANETA Unidade: UN/1 F1 F4

UN: R\$ 4,49 AV: R\$ 4,49 15: R\$ 4,59
30: R\$ 4,68 45: R\$ 4,77 60: R\$ 4,87



ESCOVA SANITARIA CB PLAST C/SUP BCO 150

Código: 41564 Fábrica: PLANETA Unidade: UN/1 F1 F4

UN: R\$ 4,49 AV: R\$ 4,49 15: R\$ 4,59
30: R\$ 4,68 45: R\$ 4,77 60: R\$ 4,87



ESCOVA SANITARIA CB PLAST C/SUP ROSA 152

Código: 46866 Fábrica: PLANETA Unidade: UN/1 F1 F4

UN: R\$ 9,00 AV: R\$ 9,00 15: R\$ 9,19
30: R\$ 9,37 45: R\$ 9,56 60: R\$ 9,75



ESCOVA SANITARIA CB PLAST C/SUPORTE 2355

Código: 38001 Fábrica: DALCIN Unidade: UN/1 F1 F4

UN: R\$ 5,28 AV: R\$ 5,28 15: R\$ 5,39
30: R\$ 5,50 45: R\$ 5,61 60: R\$ 5,72



ESCUMADEIRA ACO INOX 25,5CM LAR 060

Código: 50101 Fábrica: PLANETA Unidade: UN/1 F1 F4

UN: R\$ 12,72 AV: R\$ 12,72 15: R\$ 12,98
30: R\$ 13,24 45: R\$ 13,51 60: R\$ 13,78



ESCUMADEIRA ALUM BATIDO 30CM 2644

Código: 45295 Fábrica: MSR Unidade: UN/1 F1 F4

UN: R\$ 9,78 AV: R\$ 9,78 15: R\$ 9,99
30: R\$ 10,19 45: R\$ 10,39 60: R\$ 10,60



ESCUMADEIRA ALUM FUNDIDO 30CM

Código: 29648 Fábrica: AVELAR Unidade: UN/1 F1 F4

UN: R\$ 4,26 AV: R\$ 4,26 15: R\$ 4,35
30: R\$ 4,44 45: R\$ 4,52 60: R\$ 4,61



ESCUMADEIRA ALUM 27CM INTEIRIC 2019 UN

Código: 48020 Fábrica: COFAX Unidade: UN/1 F1 F4

UN: R\$ 4,75 AV: R\$ 4,75 15: R\$ 4,85
30: R\$ 4,95 45: R\$ 5,04 60: R\$ 5,14



ESCUMADEIRA ALUM 28CM CB MAD 2001 UN

Código: 48036 Fábrica: COFAX Unidade: UN/1 F1 F4

UN: R\$ 20,55 AV: R\$ 20,55 15: R\$ 20,98
30: R\$ 21,40 45: R\$ 21,83 60: R\$ 22,27



ESCUMADEIRA CROM 01 CB MADEIRA 01 33

Código: 28964 Fábrica: ARAMINAS Unidade: UN/1 F1 F4

UN: R\$ 11,93 AV: R\$ 11,93 15: R\$ 12,18
30: R\$ 12,42 45: R\$ 12,67 60: R\$ 12,92

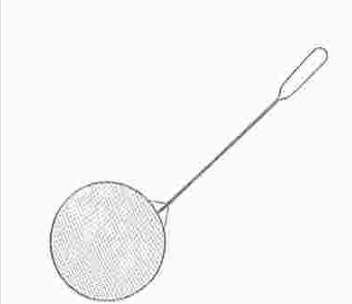

ESCUMADEIRA CROM 02 CB INTEIRICO 277

Código: 20177 Fábrica: ARAMINAS Unidade: UN/1 F1 F4

UN: R\$ 22,03 AV: R\$ 22,03 15: R\$ 22,49
30: R\$ 22,94 45: R\$ 23,40 60: R\$ 23,87



ESCUMADEIRA CROM 02 CB MADEIRA 34

Código: 28965 Fábrica: ARAMINAS Unidade: UN/1 F1 F4

UN: R\$ 16,51 AV: R\$ 16,51 15: R\$ 16,85
30: R\$ 17,19 45: R\$ 17,53 60: R\$ 17,88

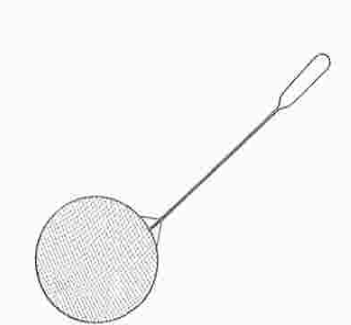

ESCUMADEIRA CROM 03 CB INTEIRICO 278

Código: 20178 Fábrica: ARAMINAS Unidade: UN/1 F1 F4

UN: R\$ 23,38 AV: R\$ 23,38 15: R\$ 23,87
30: R\$ 24,35 45: R\$ 24,83 60: R\$ 25,33



ESCUMADEIRA CROM 03 CB MADEIRA 35

Código: 28966 Fábrica: ARAMINAS Unidade: UN/1 F1 F4

UN: R\$ 21,15 AV: R\$ 21,15 15: R\$ 21,59
30: R\$ 22,02 45: R\$ 22,46 60: R\$ 22,91



ESCUMADEIRA CROM 04 CB INTEIRICO 279

Código: 29831 Fábrica: ARAMINAS Unidade: UN/1 F1 F4

UN: R\$ 35,24 AV: R\$ 35,24 15: R\$ 35,98
30: R\$ 36,70 45: R\$ 37,43 60: R\$ 38,18



ESCUMADEIRA CROM 04 CB MADEIRA 36
Código: 28967 Fábrica: ARAMINAS Unidade: UN/1
F1 F4

UN: R\$ 25,66 AV: R\$ 25,66 15: R\$ 26,19
30: R\$ 26,71 45: R\$ 27,25 60: R\$ 27,79



ESCUMADEIRA CROM 05 CB INTEIR INDST 189
Código: 29832 Fábrica: ARAMINAS Unidade: UN/1
F1 F4

UN: R\$ 34,26 AV: R\$ 34,26 15: R\$ 34,98
30: R\$ 35,68 45: R\$ 36,39 60: R\$ 37,12



ESCUMADEIRA CROM 05 CB MAD INDUST 05
Código: 28968 Fábrica: ARAMINAS Unidade: UN/1
F1 F4

UN: R\$ 34,42 AV: R\$ 34,42 15: R\$ 35,14
30: R\$ 35,84 45: R\$ 36,56 60: R\$ 37,29

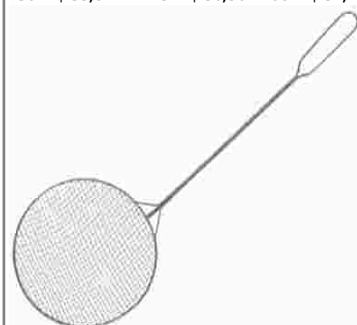

ESCUMADEIRA CROM 06 CB INTEIR INDST 114
Código: 12165 Fábrica: ARAMINAS Unidade: UN/1
F1 F4

UN: R\$ 36,23 AV: R\$ 36,23 15: R\$ 36,99
30: R\$ 37,72 45: R\$ 38,48 60: R\$ 39,25



ESCUMADEIRA CROM 06 CB MAD INDST 38
Código: 28969 Fábrica: ARAMINAS Unidade: UN/1
F1 F4

UN: R\$ 6,66 AV: R\$ 6,66 15: R\$ 6,80
30: R\$ 6,93 45: R\$ 7,07 60: R\$ 7,21



ESCUMADEIRA INOX CACIQUE 33CM 138
Código: 39352 Fábrica: PLANETA Unidade: UN/1
F1 F4

UN: R\$ 11,74 AV: R\$ 11,74 15: R\$ 11,99
30: R\$ 12,22 45: R\$ 12,47 60: R\$ 12,72



ESCUMADEIRA NYLON BRANCA CB ACO 113-005
Código: 41599 Fábrica: HERCULES Unidade: UN/1
F1 F4

UN: R\$ 5,29 AV: R\$ 5,29 15: R\$ 5,40
30: R\$ 5,51 45: R\$ 5,62 60: R\$ 5,73



ESCUMADEIRA NYLON PRETO 28CM 1084
Código: 37803 Fábrica: ENGIPLAST Unidade: UN/1
F1 F4

UN: R\$ 17,62 AV: R\$ 17,62 15: R\$ 17,98
30: R\$ 18,34 45: R\$ 18,71 60: R\$ 19,08

35 cm



ESCUMADEIRA NYLON 35CM CB CROMADO 66
Código: 41350 Fábrica: HAUSKRAFT Unidade: UN/1
F1 F4

UN: R\$ 2,34 AV: R\$ 2,34 15: R\$ 2,39
30: R\$ 2,44 45: R\$ 2,49 60: R\$ 2,54



ESCUMADEIRA PLAST 33CM COLOR 823
Código: 41644 Fábrica: QUALYPLAS Unidade: UN/1
F1 F4

UN: R\$ 14,35 AV: R\$ 14,35 15: R\$ 14,64
30: R\$ 14,94 45: R\$ 15,24 60: R\$ 15,54



ESCUMADEIRA SILICONE COLOR 29CM 17071
Código: 33951 Fábrica: PRATIBELLA Unidade: UN/1
F1 F4

UN: R\$ 29,37 AV: R\$ 29,37 15: R\$ 29,98
30: R\$ 30,58 45: R\$ 31,19 60: R\$ 31,81



ESGUICHO ADAP/CONEC/PISTOL MANGUEIR 1/2"
Código: 50968 Fábrica: FBG Unidade: CR/1
F1 F4

UN: R\$ 40,10 AV: R\$ 40,10 15: R\$ 40,93
30: R\$ 41,75 45: R\$ 42,59 60: R\$ 43,44



ESGUICHO PIST PLAST ADAPT MANGUEIR 1/2"
Código: 49642 Fábrica: WINMAX Unidade: UN/1
F1 F4

UN: R\$ 11,93 AV: R\$ 11,93 15: R\$ 12,18
30: R\$ 12,42 45: R\$ 12,67 60: R\$ 12,92



ESGUICHO PLAST ADAP/CONEC MANGUEIR 1/2"
Código: 50966 Fábrica: IMPORIENTE Unidade: CR/1
F1 F4

UN: R\$ 20,02 AV: R\$ 20,02 15: R\$ 20,44
30: R\$ 20,85 45: R\$ 21,27 60: R\$ 21,69



ESGUICHO PLAST ADAP/CONEC MANGUEIR 1/2"
Código: 49643 Fábrica: WINMAX Unidade: UN/1
F1 F4

UN: R\$ 15,13 AV: R\$ 15,13 15: R\$ 15,44
30: R\$ 15,75 45: R\$ 16,07 60: R\$ 16,39



ESPANADOR PENA 20 NOMO COLOR 100
Código: 48401 Fábrica: SHANGRILA Unidade: UN/1
F1 F4

Departamento: UTILIDADE Região: GRANDE BH Pagina 52

UN: R\$ 24,47 AV: R\$ 24,47 15: R\$ 24,98
30: R\$ 25,48 45: R\$ 25,99 60: R\$ 26,51



ESPANADOR PENA 20 NOMO 86
Código: Fábrica: Unidade:
48399 SHANGRILA UN/1
F1 F4

UN: R\$ 20,06 AV: R\$ 20,06 15: R\$ 20,48
30: R\$ 20,89 45: R\$ 21,31 60: R\$ 21,74



ESPANADOR PENA 25 NOMO CLEAN 5844
Código: Fábrica: Unidade:
50196 SHANGRILA UN/1
F1 F4

UN: R\$ 16,64 AV: R\$ 16,64 15: R\$ 16,98
30: R\$ 17,32 45: R\$ 17,67 60: R\$ 18,02



ESPANADOR PENA 30 NOMO COLOR 101
Código: Fábrica: Unidade:
48402 SHANGRILA UN/1
F1 F4

UN: R\$ 29,37 AV: R\$ 29,37 15: R\$ 29,98
30: R\$ 30,58 45: R\$ 31,19 60: R\$ 31,81



ESPANADOR PENA 35 NOMO CLEAN 5718
Código: Fábrica: Unidade:
50195 SHANGRILA UN/1
F1 F4

UN: R\$ 33,28 AV: R\$ 33,28 15: R\$ 33,98
30: R\$ 34,66 45: R\$ 35,35 60: R\$ 36,06



ESPANADOR PENA 45 NOMO CLEAN 5719
Código: Fábrica: Unidade:
50194 SHANGRILA UN/1
F1 F4

UN: R\$ 18,60 AV: R\$ 18,60 15: R\$ 18,98
30: R\$ 19,36 45: R\$ 19,75 60: R\$ 20,14



ESPATULA ALUM FUNDIDO 30CM
Código: Fábrica: Unidade:
32524 AVELAR UN/1
F1 F4

UN: R\$ 2,92 AV: R\$ 2,92 15: R\$ 2,98
30: R\$ 3,04 45: R\$ 3,10 60: R\$ 3,16

30 cm



ESPATULA BAMBU VAZADA 30CM CB COLOR 6025
Código: Fábrica: Unidade:
44737 WINCY UN/1
F1 F4

UN: R\$ 8,28 AV: R\$ 8,28 15: R\$ 8,46
30: R\$ 8,63 45: R\$ 8,80 60: R\$ 8,97



ESPATULA INOX P/BOLO 24CM CTL 1736
Código: Fábrica: Unidade:
15922 SIMONAGGIO UN/1
F1 F4

UN: R\$ 4,89 AV: R\$ 4,89 15: R\$ 4,99
30: R\$ 5,09 45: R\$ 5,19 60: R\$ 5,29

26cm



ESPATULA INOX P/BOLO 26CM 062
Código: Fábrica: Unidade:
46841 PLANETA UN/1
F1 F4

UN: R\$ 18,26 AV: R\$ 18,26 15: R\$ 18,64
30: R\$ 19,02 45: R\$ 19,40 60: R\$ 19,78

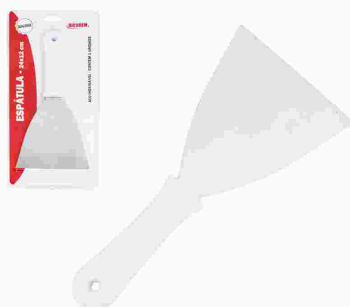

ESPATULA INOX RETA 24X12CM CB PLAST -25
Código: Fábrica: Unidade:
45292 NICOBEM UN/1
F1 F4

UN: R\$ 6,95 AV: R\$ 6,95 15: R\$ 7,10
30: R\$ 7,24 45: R\$ 7,38 60: R\$ 7,53



ESPATULA INOX 26,5CM P/BOLO 061
Código: Fábrica: Unidade:
47326 NIX UN/1
F1 F4

UN: R\$ 10,38 AV: R\$ 10,38 15: R\$ 10,60
30: R\$ 10,81 45: R\$ 11,02 60: R\$ 11,24

24cm



ESPATULA SILICONE CURVA VERMELH 24CM 328
Código: Fábrica: Unidade:
46870 PLANETA UN/1
F1 F4

UN: R\$ 10,13 AV: R\$ 10,13 15: R\$ 10,35
30: R\$ 10,55 45: R\$ 10,76 60: R\$ 10,98



ESPATULA SILICONE VAZADA 27CM PRETO 653
Código: Fábrica: Unidade:
50099 PLANETA UN/1
F1 F4

UN: R\$ 10,76 AV: R\$ 10,76 15: R\$ 10,99
30: R\$ 11,21 45: R\$ 11,43 60: R\$ 11,66



ESPATULA SILICONE VAZADA 27CM VERMEL 993
Código: Fábrica: Unidade:
50098 PLANETA UN/1
F1 F4

UN: R\$ 14,69 AV: R\$ 14,69 15: R\$ 14,99
30: R\$ 15,29 45: R\$ 15,60 60: R\$ 15,91



ESPATULA SILICONE VM CB ACO INOX 3094
Código: Fábrica: Unidade:
33820 GEDEX UN/1
F1 F4

UN: R\$ 0,08 AV: R\$ 3,91 15: R\$ 3,99
30: R\$ 4,07 45: R\$ 4,15 60: R\$ 4,23



ESPETO BAMBU CHURRASCO 25CM 24260 50X1
Código: Fábrica: Unidade:
47880 BOMPACK PT/50
F1 F4

UN: R\$ 0,10 AV: R\$ 4,89 15: R\$ 4,99
30: R\$ 5,09 45: R\$ 5,19 60: R\$ 5,29



ESPETO BAMBU CHURRASCO 30CM 24672 50X1
Código: Fábrica: Unidade:
44763 BOMPACK PT/50
F1 F4

UN: R\$ 11,51 AV: R\$ 11,51 15: R\$ 11,75
30: R\$ 11,98 45: R\$ 12,22 60: R\$ 12,46



ESPETO DUPLO 55 CM 02
Código: Fábrica: Unidade:
24059 ARAMINAS UN/1
F1 F4

UN: R\$ 13,22 AV: R\$ 13,22 15: R\$ 13,49
30: R\$ 13,76 45: R\$ 14,04 60: R\$ 14,32



ESPETO DUPLO 65 CM 03
Código: Fábrica: Unidade:
24060 ARAMINAS UN/1
F1 F4

UN: R\$ 18,19 AV: R\$ 18,19 15: R\$ 18,57
30: R\$ 18,94 45: R\$ 19,32 60: R\$ 19,71



ESPETO DUPLO 75 CM 04
Código: Fábrica: Unidade:
24061 ARAMINAS UN/1
F1 F4

UN: R\$ 0,06 AV: R\$ 6,07 15: R\$ 6,20
30: R\$ 6,32 45: R\$ 6,45 60: R\$ 6,58



ESPETO MAD CHURRASCO 18CM 64008 100X1
Código: Fábrica: Unidade:
41178 THEOTO PT/100
F1 F4

UN: R\$ 0,09 AV: R\$ 447,48 15: R\$ 456,81
30: R\$ 465,94 45: R\$ 475,26 60: R\$ 484,77

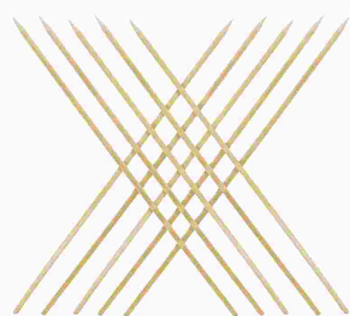

ESPETO MAD CHURRASCO 25CM 5000X1
Código: Fábrica: Unidade:
49693 ESTILO CX/5000
F1 F4

UN: R\$ 0,08 AV: R\$ 8,47 15: R\$ 8,65
30: R\$ 8,82 45: R\$ 9,00 60: R\$ 9,18



ESPETO MAD CHURRASCO 25CM 64021 100X1
Código: Fábrica: Unidade:
1938 THEOTO PT/100
F1 F4

UN: R\$ 0,11 AV: R\$ 8,80 15: R\$ 8,99
30: R\$ 9,17 45: R\$ 9,35 60: R\$ 9,54



ESPETO MAD CHURRASCO 25CM 80X1
Código: Fábrica: Unidade:
49694 ESTILO CX/80
F1 F4

UN: R\$ 11,51 AV: R\$ 11,51 15: R\$ 11,75
30: R\$ 11,98 45: R\$ 12,22 60: R\$ 12,46



ESPETO SIMPLES ACO ESTANHADO 55 CM 05
Código: Fábrica: Unidade:
12947 ARAMINAS UN/1
F1 F4

UN: R\$ 13,42 AV: R\$ 13,42 15: R\$ 13,69
30: R\$ 13,97 45: R\$ 14,25 60: R\$ 14,53



ESPETO SIMPLES ACO ESTANHADO 65 CM 06
Código: Fábrica: Unidade:
12948 ARAMINAS UN/1
F1 F4

UN: R\$ 14,44 AV: R\$ 14,44 15: R\$ 14,74
30: R\$ 15,04 45: R\$ 15,34 60: R\$ 15,65



ESPETO SIMPLES ACO ESTANHADO 75 CM 07
Código: Fábrica: Unidade:
12949 ARAMINAS UN/1
F1 F4

UN: R\$ 15,37 AV: R\$ 15,37 15: R\$ 15,69
30: R\$ 16,01 45: R\$ 16,33 60: R\$ 16,65



ESPETO SIMPLES ACO ESTANHADO 85 CM 0215
Código: Fábrica: Unidade:
40264 ARAMIG UN/1
F1 F4

UN: R\$ 15,37 AV: R\$ 15,37 15: R\$ 15,69
30: R\$ 16,01 45: R\$ 16,33 60: R\$ 16,65

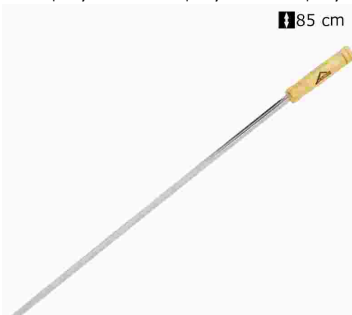

ESPETO SIMPLES ACO ESTANHADO 85 CM 26
Código: Fábrica: Unidade:
44718 ARAMINAS UN/1
F1 F4

UN: R\$ 3,48 AV: R\$ 3,48 15: R\$ 3,55
30: R\$ 3,62 45: R\$ 3,69 60: R\$ 3,77

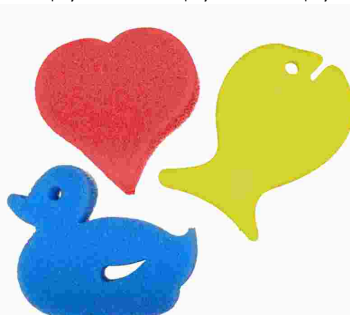

ESPUNJA BANHO INFANTIL UN
Código: Fábrica: Unidade:
44333 MC PANOS UN/1
F1 F4

UN: R\$ 4,89 AV: R\$ 4,89 15: R\$ 4,99
30: R\$ 5,09 45: R\$ 5,19 60: R\$ 5,29



ESPUNJA BANHO MASSAGEADORA
Código: Fábrica: Unidade:
50150 MC PANOS UN/1
F1 F4

UN: R\$ 1,36 AV: R\$ 1,36 15: R\$ 1,39
30: R\$ 1,42 45: R\$ 1,45 60: R\$ 1,47



ESPUNJA LIMPEZA DUPLA FACE UN
Código: Fábrica: Unidade:
46436 NOBRE UN/1
F1 F4

UN: R\$ 0,86 AV: R\$ 2,59 15: R\$ 2,64
30: R\$ 2,69 45: R\$ 2,75 60: R\$ 2,80



ESPONJA LIMPEZA DUPLA FACE 3X1

Código: Fábrika: Unidade:
50125 ESPONFLORA PT/3
F1 F4

UN: R\$ 4,16 AV: R\$ 4,16 15: R\$ 4,25
30: R\$ 4,33 45: R\$ 4,42 60: R\$ 4,51



ESPONJA MODELO LUVA P/LAVAR CARRO

Código: Fábrika: Unidade:
11331 FERREIRA UN/1
F1 F4

UN: R\$ 6,75 AV: R\$ 6,75 15: R\$ 6,89
30: R\$ 7,03 45: R\$ 7,17 60: R\$ 7,31



ESPONJA P/LAVAR CARRO

Código: Fábrika: Unidade:
11333 FERREIRA UN/1
F1 F4

UN: R\$ 318,24 AV: R\$ 318,24 15: R\$ 324,87
30: R\$ 331,37 45: R\$ 337,99 60: R\$ 344,75



Produto
* Altura: 90 cm
* Comp: 187 cm
* Largura: 70 cm

ESPREGUICADEIRA PITANGUI BRANCA

Código: Fábrika: Unidade:
7749 ANTARES UN/1
F1 F4

UN: R\$ 10,13 AV: R\$ 10,13 15: R\$ 10,35
30: R\$ 10,55 45: R\$ 10,76 60: R\$ 10,98

18 cm

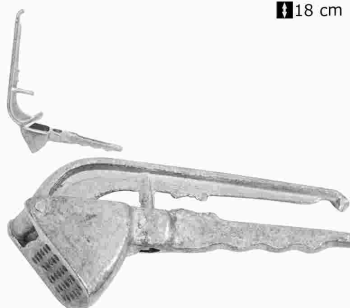

ESPREDADOR ALUM INTEIR ALHO BIG 2008 UN

Código: Fábrika: Unidade:
48034 COFAX UN/1
F1 F4

UN: R\$ 4,75 AV: R\$ 4,75 15: R\$ 4,85
30: R\$ 4,95 45: R\$ 5,04 60: R\$ 5,14

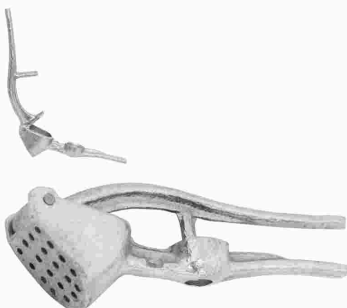

ESPREDADOR ALUM INTEIR ALHO 2F 2030 UN

Código: Fábrika: Unidade:
48032 COFAX UN/1
F1 F4

UN: R\$ 8,81 AV: R\$ 8,81 15: R\$ 9,00
30: R\$ 9,18 45: R\$ 9,36 60: R\$ 9,55

7 cm
9 cm



ESPREDADOR PLAST LARANJA 13X09CM 3174

Código: Fábrika: Unidade:
40311 WINCY UN/1
F1 F4

UN: R\$ 24,47 AV: R\$ 24,47 15: R\$ 24,98
30: R\$ 25,48 45: R\$ 25,99 60: R\$ 26,51



ESTACA P/PLANTA FIBRA DE COCO 60X5X5CM

Código: Fábrika: Unidade:
30295 NUTRIPLAN UN/1
F1 F4

UN: R\$ 35,85 AV: R\$ 35,85 15: R\$ 36,60
30: R\$ 37,33 45: R\$ 38,07 60: R\$ 38,84

80cm



ESTACA P/PLANTA FIBRA DE COCO 80X5X5CM

Código: Fábrika: Unidade:
30296 NUTRIPLAN UN/1
F1 F4

UN: R\$ 156,66 AV: R\$ 156,66 15: R\$ 159,93
30: R\$ 163,12 45: R\$ 166,39 60: R\$ 169,71

Produto
* Altura: 128 cm
* Largura: 75 cm



ESTANTE MODULAR 4 PRATELEIRAS PRETA

Código: Fábrika: Unidade:
12899 ANTARES UN/1
F1 F4

UN: R\$ 5,87 AV: R\$ 5,87 15: R\$ 5,99
30: R\$ 6,11 45: R\$ 6,23 60: R\$ 6,35



ESTEIRA MADEIRA FIXA 25 CM IND 162

Código: Fábrika: Unidade:
41323 MAD LAR UN/1
F1 F4

UN: R\$ 6,36 AV: R\$ 6,36 15: R\$ 6,49
30: R\$ 6,62 45: R\$ 6,75 60: R\$ 6,88



ESTEIRA MADEIRA G 25 CM 156

Código: Fábrika: Unidade:
41321 MAD LAR UN/1
F1 F4

UN: R\$ 5,87 AV: R\$ 5,87 15: R\$ 5,99
30: R\$ 6,11 45: R\$ 6,23 60: R\$ 6,35

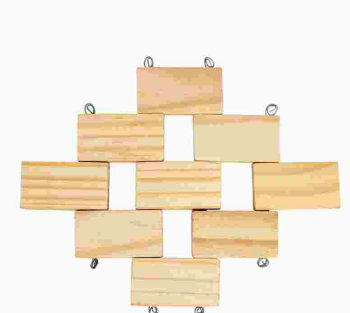

ESTEIRA MADEIRA M 20 CM 157

Código: Fábrika: Unidade:
41322 MAD LAR UN/1
F1 F4

UN: R\$ 7,82 AV: R\$ 7,82 15: R\$ 7,99
30: R\$ 8,15 45: R\$ 8,31 60: R\$ 8,48



ESTERCO DE GALINHA 1 LITRO

Código: Fábrika: Unidade:
48536 NOVATROPICAL PT/1
F1 F4

UN: R\$ 1,95 AV: R\$ 23,38 15: R\$ 23,87
30: R\$ 24,35 45: R\$ 24,83 60: R\$ 25,33



FACA INOX MESA LINHA AMERICA 2224 12X1

Código: Fábrika: Unidade:
50621 STEEL PT/12
F1 F4

UN: R\$ 7,82 AV: R\$ 7,82 15: R\$ 7,99
30: R\$ 8,15 45: R\$ 8,31 60: R\$ 8,48



FACA ACO CARBONO 3" CB MAD LEGUMES 222

Código: Fábrika: Unidade:
39348 PLANETA CR/1
F1 F4

UN: R\$ 17,44 AV: R\$ 209,30 15: R\$ 213,66
30: R\$ 217,94 45: R\$ 222,30 60: R\$ 226,74



FACA ACO CARBONO 5" CB MAD 22950/5 12X1
Código: Fábrica: Unidade:
34848 TRAMONTINA DZ/12
F1 F4

UN: R\$ 14,85 AV: R\$ 178,20 15: R\$ 181,92
30: R\$ 185,56 45: R\$ 189,27 60: R\$ 193,05



FACA ACO CARBONO 5" CB MAD 22953/5 12X1
Código: Fábrica: Unidade:
34847 TRAMONTINA DZ/12
F1 F4

UN: R\$ 16,73 AV: R\$ 200,74 15: R\$ 204,92
30: R\$ 209,02 45: R\$ 213,20 60: R\$ 217,46



FACA ACO CARBONO 6" CB MAD 22953/6 12X1
Código: Fábrica: Unidade:
34850 TRAMONTINA DZ/12
F1 F4

UN: R\$ 22,51 AV: R\$ 22,51 15: R\$ 22,98
30: R\$ 23,44 45: R\$ 23,91 60: R\$ 24,39



FACA ACO CARBONO 6" CB MAD 252
Código: Fábrica: Unidade:
39349 PLANETA CR/1
F1 F4

UN: R\$ 18,77 AV: R\$ 225,21 15: R\$ 229,90
30: R\$ 234,50 45: R\$ 239,19 60: R\$ 243,97



FACA ACO CARBONO 7" CB MAD 22953/7 12X1
Código: Fábrica: Unidade:
34849 TRAMONTINA DZ/12
F1 F4

UN: R\$ 2,45 AV: R\$ 29,38 15: R\$ 29,99
30: R\$ 30,59 45: R\$ 31,20 60: R\$ 31,82



FACA ACO INOX 3" CB PLAST COZINHA 12X1
Código: Fábrica: Unidade:
36919 MABEL CX/12
F1 F4

UN: R\$ 14,69 AV: R\$ 14,69 15: R\$ 14,99
30: R\$ 15,29 45: R\$ 15,60 60: R\$ 15,91



FACA ACO INOX 3 1/4" CB PLAST LEGUMES
Código: Fábrica: Unidade:
36573 MUNDIAL UN/1
F1 F4

UN: R\$ 10,61 AV: R\$ 63,64 15: R\$ 64,96
30: R\$ 66,26 45: R\$ 67,59 60: R\$ 68,94



FACA ACO INOX 5" CB MAD CHURRSACO 6X1
Código: Fábrica: Unidade:
46583 MUNDIAL CX/6
F1 F4

UN: R\$ 8,96 AV: R\$ 8,96 15: R\$ 9,15
30: R\$ 9,33 45: R\$ 9,52 60: R\$ 9,71



FACA ACO INOX 5" CB PLAST BCO MAX 53
Código: Fábrica: Unidade:
50100 PLANETA CR/1
F1 F4

UN: R\$ 10,14 AV: R\$ 10,14 15: R\$ 10,36
30: R\$ 10,56 45: R\$ 10,77 60: R\$ 10,99



FACA ACO INOX 5" CB PLAST BCO TOMATE
Código: Fábrica: Unidade:
46578 MUNDIAL UN/1
F1 F4

UN: R\$ 7,41 AV: R\$ 7,41 15: R\$ 7,57
30: R\$ 7,72 45: R\$ 7,87 60: R\$ 8,03



FACA ACO INOX 5" CB PLAST PTO TOMATE
Código: Fábrica: Unidade:
47376 SIMONAGGIO UN/1
F1 F4

UN: R\$ 32,84 AV: R\$ 32,84 15: R\$ 33,53
30: R\$ 34,20 45: R\$ 34,88 60: R\$ 35,58



FACA ACO INOX 6" CB PLAST BCO CARNE 815
Código: Fábrica: Unidade:
36575 MUNDIAL UN/1
F1 F4

UN: R\$ 13,02 AV: R\$ 13,02 15: R\$ 13,29
30: R\$ 13,56 45: R\$ 13,83 60: R\$ 14,11



FACA ACO INOX 6" CB PLAST BCO COZINHA
Código: Fábrica: Unidade:
37807 NICOBEM UN/1
F1 F4

UN: R\$ 31,32 AV: R\$ 31,32 15: R\$ 31,98
30: R\$ 32,62 45: R\$ 33,27 60: R\$ 33,93



FACA ACO INOX 6" CB PLAST BCO COZINHA31
Código: Fábrica: Unidade:
36576 MUNDIAL UN/1
F1 F4

UN: R\$ 15,86 AV: R\$ 15,86 15: R\$ 16,19
30: R\$ 16,52 45: R\$ 16,85 60: R\$ 17,18



FACA ACO INOX 7" CB PLAST BCO COZINHA
Código: Fábrica: Unidade:
50953 HAI BRASIL UN/1
F1 F4

UN: R\$ 10,23 AV: R\$ 10,23 15: R\$ 10,45
30: R\$ 10,65 45: R\$ 10,87 60: R\$ 11,09



FACA ACO INOX 7" CB PLAST BCO MAX 55
Código: Fábrica: Unidade:
47988 PLANETA CR/1
F1 F4

UN: R\$ 21,53 AV: R\$ 21,53 15: R\$ 21,98
30: R\$ 22,42 45: R\$ 22,87 60: R\$ 23,33



FACA ACO INOX 7" CB PLAST PTO CARNE 107
Código: Fábrica: Unidade:
46577 MUNDIAL UN/1
F1 F4

UN: R\$ 9,96 AV: R\$ 9,96 15: R\$ 10,17
30: R\$ 10,37 45: R\$ 10,58 60: R\$ 10,79



FACA ACO INOX 8" CB PLAST BCO COZINHA
Código: Fábrica: Unidade:
46492 NICOBEM UN/1
F1 F4

UN: R\$ 17,14 AV: R\$ 17,14 15: R\$ 17,49
30: R\$ 17,84 45: R\$ 18,20 60: R\$ 18,56



FACA ACO INOX 8" CB PLAST BCO COZINHA
Código: Fábrica: Unidade:
50945 HAI BRASIL UN/1
F1 F4

UN: R\$ 31,33 AV: R\$ 31,33 15: R\$ 31,99
30: R\$ 32,63 45: R\$ 33,28 60: R\$ 33,95
133 cm



FACA ACO INOX 8" CB PLAST BCO COZINHA31
Código: Fábrica: Unidade:
36579 MUNDIAL UN/1
F1 F4

UN: R\$ 10,28 AV: R\$ 10,28 15: R\$ 10,50
30: R\$ 10,71 45: R\$ 10,92 60: R\$ 11,14



FACA ACO INOX 8" PAO CB PLAST BCO MAX57
Código: Fábrica: Unidade:
47989 PLANETA CR/1
F1 F4

UN: R\$ 18,60 AV: R\$ 18,60 15: R\$ 18,98
30: R\$ 19,36 45: R\$ 19,75 60: R\$ 20,14



FACA ACO INOX 9" CB PLAST BCO COZINHA
Código: Fábrica: Unidade:
50952 HAI BRASIL UN/1
F1 F4

UN: R\$ 56,30 AV: R\$ 56,30 15: R\$ 57,48
30: R\$ 58,63 45: R\$ 59,80 60: R\$ 61,00
39 cm



FACA ACO INOX 10" CB PLAST BCO CARNE 781
Código: Fábrica: Unidade:
36581 MUNDIAL UN/1
F1 F4

UN: R\$ 44,75 AV: R\$ 44,75 15: R\$ 45,68
30: R\$ 46,60 45: R\$ 47,53 60: R\$ 48,48
38 cm



FACA ACO INOX 10" CB PLAST BCO CARNE 820
Código: Fábrica: Unidade:
36582 MUNDIAL UN/1
F1 F4

UN: R\$ 12,97 AV: R\$ 12,97 15: R\$ 13,24
30: R\$ 13,51 45: R\$ 13,78 60: R\$ 14,06



FACA ACO 7" PAO CB PLAST PRETO 6013
Código: Fábrica: Unidade:
44645 MART/SIMONAG UN/1
F1 F4

UN: R\$ 10,28 AV: R\$ 10,28 15: R\$ 10,50
30: R\$ 10,71 45: R\$ 10,92 60: R\$ 11,14



FACA INOX 5" CB PLAST BCO COZINHA 3186
Código: Fábrica: Unidade:
49646 WINMAX UN/1
F1 F4

UN: R\$ 10,76 AV: R\$ 10,76 15: R\$ 10,99
30: R\$ 11,21 45: R\$ 11,43 60: R\$ 11,66



FACA INOX 6" CB PLAST BCO COZINHA 3187
Código: Fábrica: Unidade:
49647 WINMAX UN/1
F1 F4

UN: R\$ 11,06 AV: R\$ 11,06 15: R\$ 11,29
30: R\$ 11,51 45: R\$ 11,74 60: R\$ 11,98



FACA INOX 7" CB PLAST BCO COZINHA 3188
Código: Fábrica: Unidade:
49648 WINMAX UN/1
F1 F4

UN: R\$ 1,96 AV: R\$ 23,49 15: R\$ 23,98
30: R\$ 24,46 45: R\$ 24,95 60: R\$ 25,45



FACA INOX CHURR 20CM VERSA AZ 731 12X1
Código: Fábrica: Unidade:
50162 PLANETA DZ/12
F1 F4

UN: R\$ 17,63 AV: R\$ 17,63 15: R\$ 17,99
30: R\$ 18,35 45: R\$ 18,72 60: R\$ 19,09



FACA INOX KIT C/3 PLENUS CB PLAS BCO 312
Código: Fábrica: Unidade:
40391 TRAMONTINA CR/1
F1 F4

UN: R\$ 17,63 AV: R\$ 17,63 15: R\$ 17,99
30: R\$ 18,35 45: R\$ 18,72 60: R\$ 19,09



FACA INOX KIT C/3 PLENUS CB PLAS PTO 612
Código: Fábrica: Unidade:
40390 TRAMONTINA CR/1
F1 F4

UN: R\$ 1,96 AV: R\$ 5,87 15: R\$ 5,99
30: R\$ 6,11 45: R\$ 6,23 60: R\$ 6,35



FACA INOX MESA LINHA BRONZE 517 3X1
Código: Fábrica: Unidade:
48008 PLANETA PT/3
F1 F4

UN: R\$ 46,01 AV: R\$ 46,01 15: R\$ 46,97
30: R\$ 47,91 45: R\$ 48,87 60: R\$ 49,85



FACA INOX 3PCS CB PLAST GOLDEN DARK 106

Código: 41348 Fábrica: HAUSKRAFT Unidade: CJ/1 F1 F4

UN: R\$ 6,36 AV: R\$ 6,36 15: R\$ 6,49
30: R\$ 6,62 45: R\$ 6,75 60: R\$ 6,88



FACA INOX 3,5" LINH MAX LEGUMES CB BC52

Código: 47629 Fábrica: PLANETA Unidade: CR/1 F1 F4

UN: R\$ 5,98 AV: R\$ 5,98 15: R\$ 6,11
30: R\$ 6,23 45: R\$ 6,35 60: R\$ 6,48



FACA INOX 3,5" LINH MERCOSU LEGUMES 234

Código: 46868 Fábrica: PLANETA Unidade: CR/1 F1 F4

UN: R\$ 19,57 AV: R\$ 19,57 15: R\$ 19,98
30: R\$ 20,38 45: R\$ 20,79 60: R\$ 21,21



FACA INOX 6" CB PLAST P/DESOSSAR 5421

Código: 43277 Fábrica: MAGAGIFT Unidade: CR/1 F1 F4

UN: R\$ 12,48 AV: R\$ 12,48 15: R\$ 12,74
30: R\$ 13,00 45: R\$ 13,26 60: R\$ 13,53



FACA INOX 7" CB MAD JATOBA CTL 225

Código: 48692 Fábrica: PLANETA Unidade: CR/1 F1 F4

UN: R\$ 22,51 AV: R\$ 22,51 15: R\$ 22,98
30: R\$ 23,44 45: R\$ 23,91 60: R\$ 24,39



FACA INOX 7" CB PLAST PROFESSIONAL 5423

Código: 43278 Fábrica: MAGAGIFT Unidade: CR/1 F1 F4

UN: R\$ 12,97 AV: R\$ 12,97 15: R\$ 13,24
30: R\$ 13,51 45: R\$ 13,78 60: R\$ 14,06



FACA INOX 8" CB MAD JATOBA CTL 226

Código: 48693 Fábrica: PLANETA Unidade: CR/1 F1 F4

UN: R\$ 11,74 AV: R\$ 11,74 15: R\$ 11,99
30: R\$ 12,22 45: R\$ 12,47 60: R\$ 12,72



FACA PEIXEIRA ACO CARBONO 5" CB MAD 319

Código: 44641 Fábrica: SIMONAGGIO Unidade: UN/1 F1 F4

UN: R\$ 16,23 AV: R\$ 16,23 15: R\$ 16,56
30: R\$ 16,89 45: R\$ 17,23 60: R\$ 17,58



FACA PEIXEIRA ACO CARBONO 7" CB MAD 321

Código: 47375 Fábrica: SIMONAGGIO Unidade: UN/1 F1 F4

UN: R\$ 17,14 AV: R\$ 17,14 15: R\$ 17,49
30: R\$ 17,84 45: R\$ 18,20 60: R\$ 18,56



FACA PEIXEIRA ACO CARBONO 8" CB MAD 322

Código: 44642 Fábrica: SIMONAGGIO Unidade: UN/1 F1 F4

UN: R\$ 16,64 AV: R\$ 16,64 15: R\$ 16,98
30: R\$ 17,32 45: R\$ 17,67 60: R\$ 18,02



FACA PEIXEIRA ACO 7" CB PLAST VM 321007

Código: 44644 Fábrica: SIMONAGGIO Unidade: UN/1 F1 F4

UN: R\$ 21,53 AV: R\$ 21,53 15: R\$ 21,98
30: R\$ 22,42 45: R\$ 22,87 60: R\$ 23,33



FACA ACO INOX 10" CB MAD 117

Código: 45531 Fábrica: WINMAX Unidade: UN/1 F1 F4

UN: R\$ 1,49 AV: R\$ 17,87 15: R\$ 18,24
30: R\$ 18,61 45: R\$ 18,98 60: R\$ 19,36



FAQUEIRO 12 PCS CB PLAST COLOR 80

Código: 41064 Fábrica: TAGLIATORI Unidade: CJ/12 F1 F4

UN: R\$ 1,38 AV: R\$ 22,03 15: R\$ 22,49
30: R\$ 22,94 45: R\$ 23,40 60: R\$ 23,87



FAQUEIRO 16 PCS CB PLAST COLOR 318

Código: 41065 Fábrica: TAGLIATORI Unidade: CJ/16 F1 F4

UN: R\$ 1,27 AV: R\$ 25,45 15: R\$ 25,98
30: R\$ 26,50 45: R\$ 27,03 60: R\$ 27,57



FAQUEIRO 20 PCS CB PLAST COLOR 313

Código: 41063 Fábrica: TAGLIATORI Unidade: CJ/20 F1 F4

UN: R\$ 1,20 AV: R\$ 28,89 15: R\$ 29,49
30: R\$ 30,08 45: R\$ 30,68 60: R\$ 31,29

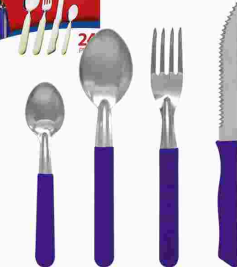

FAQUEIRO 24 PCS CB PLAST COLOR 115

Código: 41062 Fábrica: TAGLIATORI Unidade: CJ/24 F1 F4

UN: R\$ 3,87 AV: R\$ 92,83 15: R\$ 94,76
30: R\$ 96,66 45: R\$ 98,59 60: R\$ 100,56



FAQUEIRO 24 PCS INOX 4829
Código: Fábrica: Unidade:
49759 SQ CJ/24
F1 F4

UN: R\$ 3,67 AV: R\$ 58,74 15: R\$ 59,97
30: R\$ 61,17 45: R\$ 62,39 60: R\$ 63,64



FAQUEIRO 25 PCS CB PLAST BCO PORTA TALHE
Código: Fábrica: Unidade:
41337 HAUSKRAFT CJ/16
F1 F4

UN: R\$ 3,67 AV: R\$ 58,74 15: R\$ 59,97
30: R\$ 61,17 45: R\$ 62,39 60: R\$ 63,64



FAQUEIRO 25 PCS CB PLAST PTO PORTA TALHE
Código: Fábrica: Unidade:
41338 HAUSKRAFT CJ/16
F1 F4

UN: R\$ 3,67 AV: R\$ 58,74 15: R\$ 59,97
30: R\$ 61,17 45: R\$ 62,39 60: R\$ 63,64



FAQUEIRO 25 PCS CB PLAST VM PORTA TALHE
Código: Fábrica: Unidade:
41339 HAUSKRAFT CJ/16
F1 F4

UN: R\$ 5,39 AV: R\$ 5,39 15: R\$ 5,50
30: R\$ 5,61 45: R\$ 5,72 60: R\$ 5,83



FARINHEIRO PLAST 800 ML LEITOSO 21
Código: Fábrica: Unidade:
40374 FORMPLAST UN/1
F1 F4

UN: R\$ 3,87 AV: R\$ 3,87 15: R\$ 3,95
30: R\$ 4,03 45: R\$ 4,11 60: R\$ 4,19



FATIADOR INOX PIZZA 18,9CM 8178
Código: Fábrica: Unidade:
44729 WINCY UN/1
F1 F4

UN: R\$ 7,46 AV: R\$ 7,46 15: R\$ 7,62
30: R\$ 7,77 45: R\$ 7,92 60: R\$ 8,08



FERRAMENTA ACO CB PLAST JARDIM 2X1 74307
Código: Fábrica: Unidade:
49599 ALMEGA CJ/1
F1 F4

UN: R\$ 6,35 AV: R\$ 6,35 15: R\$ 6,48
30: R\$ 6,61 45: R\$ 6,74 60: R\$ 6,87



FERRAMENTA ESPATULA METAL CB PLAST 3080
Código: Fábrica: Unidade:
38453 FENIMA UN/1
F1 F4

UN: R\$ 10,47 AV: R\$ 10,47 15: R\$ 10,69
30: R\$ 10,90 45: R\$ 11,12 60: R\$ 11,34



FERRAMENTA PLAST ARRANCADOR 28,6CM VERDE
Código: Fábrica: Unidade:
47609 NUTRIPLAN UN/1
F1 F4

UN: R\$ 9,24 AV: R\$ 36,96 15: R\$ 37,73
30: R\$ 38,49 45: R\$ 39,26 60: R\$ 40,04



FERRAMENTA PLAST KIT RAST/PA/ARRAN VERDE
Código: Fábrica: Unidade:
47610 NUTRIPLAN CJ/4
F1 F4

UN: R\$ 10,47 AV: R\$ 10,47 15: R\$ 10,69
30: R\$ 10,90 45: R\$ 11,12 60: R\$ 11,34



FERRAMENTA PLAST PAZINHA ESTR 28CM VERDE
Código: Fábrica: Unidade:
47608 NUTRIPLAN UN/1
F1 F4

UN: R\$ 10,47 AV: R\$ 10,47 15: R\$ 10,69
30: R\$ 10,90 45: R\$ 11,12 60: R\$ 11,34



FERRAMENTA PLAST PAZINHA 27,5CM VERDE
Código: Fábrica: Unidade:
47607 NUTRIPLAN UN/1
F1 F4

UN: R\$ 10,47 AV: R\$ 10,47 15: R\$ 10,69
30: R\$ 10,90 45: R\$ 11,12 60: R\$ 11,34



FERRAMENTA PLAST RATELO 24CM VERDE
Código: Fábrica: Unidade:
47606 NUTRIPLAN UN/1
F1 F4

UN: R\$ 25,45 AV: R\$ 25,45 15: R\$ 25,98
30: R\$ 26,50 45: R\$ 27,03 60: R\$ 27,57



FERRAMENTA TESOURA P/PODA 46CM AIH1239
Código: Fábrica: Unidade:
42465 AIH UN/1
F1 F4

UN: R\$ 29,38 AV: R\$ 29,38 15: R\$ 29,99
30: R\$ 30,59 45: R\$ 31,20 60: R\$ 31,82



FERRAMENTA TESOURA P/PODA 8" CTL 9165T
Código: Fábrica: Unidade:
40077 IDEA UN/1
F1 F4

UN: R\$ 11,63 AV: R\$ 11,63 15: R\$ 11,88
30: R\$ 12,11 45: R\$ 12,36 60: R\$ 12,60



FERTILIZANTE CACTOS SUCULENTAS 150GRS CX
Código: Fábrica: Unidade:
33547 VITAPLAN CX/1
F1 F4

UN: R\$ 24,32 AV: R\$ 24,32 15: R\$ 24,83
30: R\$ 25,33 45: R\$ 25,83 60: R\$ 26,35



FERTILIZANTE COMP ORGANICO JAPONES 800G
Código: Fábrica: Unidade:
39213 VITAPLAN CX/1
F1 F4

UN: R\$ 22,51 AV: R\$ 22,51 15: R\$ 22,98
30: R\$ 23,44 45: R\$ 23,91 60: R\$ 24,39



FERTILIZANTE FARINHA DE OSSO 1KG C/CX
Código: Fábrica: Unidade:
30303 VITAPLAN CX/1
F1 F4

UN: R\$ 12,53 AV: R\$ 12,53 15: R\$ 12,79
30: R\$ 13,05 45: R\$ 13,31 60: R\$ 13,58



FERTILIZANTE NUTRIFLORES 250 GRS POTE
Código: Fábrica: Unidade:
39653 VITAPLAN CX/1
F1 F4

UN: R\$ 30,64 AV: R\$ 30,64 15: R\$ 31,28
30: R\$ 31,90 45: R\$ 32,54 60: R\$ 33,19



FERTILIZANTE NUTRIFLORES 500 GRS POTE
Código: Fábrica: Unidade:
39212 VITAPLAN CX/1
F1 F4

UN: R\$ 33,64 AV: R\$ 33,64 15: R\$ 34,34
30: R\$ 35,02 45: R\$ 35,72 60: R\$ 36,44



FERTILIZANTE NUTRIFRUTAS 600 GRS POTE
Código: Fábrica: Unidade:
49345 VITAPLAN CX/1
F1 F4

UN: R\$ 17,14 AV: R\$ 17,14 15: R\$ 17,49
30: R\$ 17,84 45: R\$ 18,20 60: R\$ 18,56



FERTILIZANTE NUTRIPLANTAS 250 GRS POTE
Código: Fábrica: Unidade:
44136 VITAPLAN CX/1
F1 F4

UN: R\$ 26,68 AV: R\$ 26,68 15: R\$ 27,24
30: R\$ 27,78 45: R\$ 28,34 60: R\$ 28,91



FERTILIZANTE NUTRIPLANTAS 500 GRS POTE
Código: Fábrica: Unidade:
44132 VITAPLAN UN/1
F1 F4

UN: R\$ 15,51 AV: R\$ 15,51 15: R\$ 15,83
30: R\$ 16,15 45: R\$ 16,47 60: R\$ 16,80



FERTILIZANTE NUTRIVERDE 250 GRS POTE
Código: Fábrica: Unidade:
39654 VITAPLAN CX/1
F1 F4

UN: R\$ 23,11 AV: R\$ 23,11 15: R\$ 23,59
30: R\$ 24,06 45: R\$ 24,54 60: R\$ 25,03



FERTILIZANTE NUTRIVERDE 500 GRS POTE
Código: Fábrica: Unidade:
23212 VITAPLAN CX/1
F1 F4

UN: R\$ 39,16 AV: R\$ 39,16 15: R\$ 39,97
30: R\$ 40,77 45: R\$ 41,59 60: R\$ 42,42



FERTILIZANTE NUTRIVERDE 600 GRS POTE
Código: Fábrica: Unidade:
49344 VITAPLAN CX/1
F1 F4

UN: R\$ 9,29 AV: R\$ 9,29 15: R\$ 9,49
30: R\$ 9,68 45: R\$ 9,87 60: R\$ 10,07



FERTILIZANTE ORQUIDEAS 150 GRS C/CX
Código: Fábrica: Unidade:
22292 VITAPLAN UN/1
F1 F4

UN: R\$ 9,29 AV: R\$ 9,29 15: R\$ 9,49
30: R\$ 9,68 45: R\$ 9,87 60: R\$ 10,07



FERTILIZANTE SAMAMBAIAS 150 GRS
Código: Fábrica: Unidade:
22291 VITAPLAN CX/1
F1 F4

UN: R\$ 22,51 AV: R\$ 22,51 15: R\$ 22,98
30: R\$ 23,44 45: R\$ 23,91 60: R\$ 24,39



FERTILIZANTE TORTA MAMONA +FARIN OSSO 1K
Código: Fábrica: Unidade:
30301 VITAPLAN CX/1
F1 F4

UN: R\$ 9,33 AV: R\$ 9,33 15: R\$ 9,53
30: R\$ 9,72 45: R\$ 9,91 60: R\$ 10,11



FERTILIZANTE VIOLETA 150 GR
Código: Fábrica: Unidade:
22290 VITAPLAN CX/1
F1 F4

11,5 cm
8,5 cm

UN: R\$ 29,37 AV: R\$ 29,37 15: R\$ 29,98
30: R\$ 30,58 45: R\$ 31,19 60: R\$ 31,81



FERTILIZANTE 04-14-08 1 KG C/CX
Código: Fábrica: Unidade:
22294 VITAPLAN UN/1
F1 F4

UN: R\$ 6,84 AV: R\$ 6,84 15: R\$ 6,99
30: R\$ 7,13 45: R\$ 7,27 60: R\$ 7,41

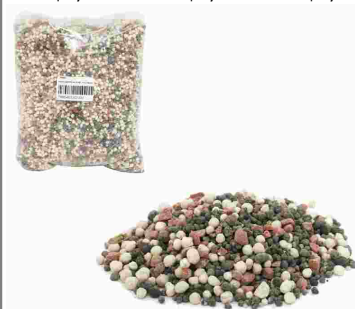

FERTILIZANTE 04-14-08 1 KG SACO
Código: Fábrica: Unidade:
30800 FAZENDEIRO KG/1
F1 F4

UN: R\$ 27,41 AV: R\$ 27,41 15: R\$ 27,98
30: R\$ 28,54 45: R\$ 29,11 60: R\$ 29,69



FERTILIZANTE 04-14-08 1 KG SACO

Código: Fábrica: Unidade:
30297 VITAPLAN UN/1
F1 F4

UN: R\$ 30,35 AV: R\$ 30,35 15: R\$ 30,98
30: R\$ 31,60 45: R\$ 32,23 60: R\$ 32,87

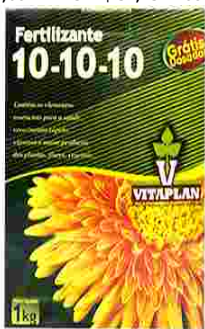

FERTILIZANTE 10-10-10 1 KG C/CX

Código: Fábrica: Unidade:
22293 VITAPLAN UN/1
F1 F4

UN: R\$ 24,47 AV: R\$ 24,47 15: R\$ 24,98
30: R\$ 25,48 45: R\$ 25,99 60: R\$ 26,51



FERTILIZANTE 10-10-10 1 KG SACO

Código: Fábrica: Unidade:
30298 VITAPLAN UN/1
F1 F4

UN: R\$ 24,47 AV: R\$ 24,47 15: R\$ 24,98
30: R\$ 25,48 45: R\$ 25,99 60: R\$ 26,51



FERVEDOR ALUM LEVE 14 C/ TAMP A 1,7 LTS

Código: Fábrica: Unidade:
5895 AVELAR UN/1
F1 F4

UN: R\$ 5,00 AV: R\$ 5,00 15: R\$ 5,11
30: R\$ 5,21 45: R\$ 5,31 60: R\$ 5,42



FILME PVC TRANSP 25CMX15M 21752

Código: Fábrica: Unidade:
50077 BOMPACK RL/1
F1 F4

UN: R\$ 22,75 AV: R\$ 22,75 15: R\$ 23,22
30: R\$ 23,69 45: R\$ 24,16 60: R\$ 24,64



FILME PVC TRANSP 28CMX100M 23263

Código: Fábrica: Unidade:
50078 BOMPACK RL/1
F1 F4

UN: R\$ 24,47 AV: R\$ 24,47 15: R\$ 24,98
30: R\$ 25,48 45: R\$ 25,99 60: R\$ 26,51



FILTRA OLEO ALUM LEVE 1 1,0 LT

Código: Fábrica: Unidade:
36286 AVELAR UN/1
F1 F4

UN: R\$ 19,57 AV: R\$ 19,57 15: R\$ 19,98
30: R\$ 20,38 45: R\$ 20,79 60: R\$ 21,21



FILTRA OLEO ALUMINIO 12 673

Código: Fábrica: Unidade:
24782 MSR UN/1
F1 F4

UN: R\$ 66,39 AV: R\$ 66,39 15: R\$ 67,77
30: R\$ 69,13 45: R\$ 70,51 60: R\$ 71,92



FILTRO COADOR INOX P/CAFE 103 4380

Código: Fábrica: Unidade:
49758 SQ UN/1
F1 F4

UN: R\$ 5,71 AV: R\$ 68,53 15: R\$ 69,96
30: R\$ 71,36 45: R\$ 72,79 60: R\$ 74,24



FILTRO PERMANENTE P/ COAR CAFE 102 12X1

Código: Fábrica: Unidade:
27442 FERREIRA DZ/12
F1 F4

UN: R\$ 6,12 AV: R\$ 73,43 15: R\$ 74,96
30: R\$ 76,46 45: R\$ 77,99 60: R\$ 79,55



FILTRO PERMANENTE P/ COAR CAFE 103 12X1

Código: Fábrica: Unidade:
27443 FERREIRA DZ/12
F1 F4

UN: R\$ 2,00 AV: R\$ 23,99 15: R\$ 24,49
30: R\$ 24,98 45: R\$ 25,48 60: R\$ 25,99



FLANELA BRANCA 28X38 CM 12X1

Código: Fábrica: Unidade:
34897 MC PANOS PT/12
F1 F4

UN: R\$ 2,86 AV: R\$ 34,26 15: R\$ 34,98
30: R\$ 35,68 45: R\$ 36,39 60: R\$ 37,12



FLANELA BRANCA 36X56CM 12X1

Código: Fábrica: Unidade:
34501 P & F PT/12
F1 F4

UN: R\$ 4,16 AV: R\$ 49,93 15: R\$ 50,97
30: R\$ 51,99 45: R\$ 53,03 60: R\$ 54,09



FLANELA COLOR 38X58 CM 12X1

Código: Fábrica: Unidade:
42841 MC PANOS PT/12
F1 F4

UN: R\$ 10,76 AV: R\$ 10,76 15: R\$ 10,99
30: R\$ 11,21 45: R\$ 11,43 60: R\$ 11,66



FLANELA MICROFIBRA 50X70 CM COLOR

Código: Fábrica: Unidade:
44155 MC PANOS UN/1
F1 F4

UN: R\$ 15,66 AV: R\$ 15,66 15: R\$ 15,98
30: R\$ 16,30 45: R\$ 16,63 60: R\$ 16,96



FORMA ALUM BOLO ALTA 01 1966

Código: Fábrica: Unidade:
37514 MSR UN/1
F1 F4

UN: R\$ 21,53 AV: R\$ 21,53 15: R\$ 21,98
30: R\$ 22,42 45: R\$ 22,87 60: R\$ 23,33



FORMA ALUM BOLO ALTA 02 1967

Código: Fábrika: Unidade:
37515 MSR UN/1
F1 F4

UN: R\$ 22,51 AV: R\$ 22,51 15: R\$ 22,98
30: R\$ 23,44 45: R\$ 23,91 60: R\$ 24,39



FORMA ALUM BOLO ALTA 03 1968

Código: Fábrika: Unidade:
37516 MSR UN/1
F1 F4

UN: R\$ 16,99 AV: R\$ 16,99 15: R\$ 17,34
30: R\$ 17,69 45: R\$ 18,04 60: R\$ 18,40



FORMA ALUM CB MAD BAURUTEX OVAL 2014 UN

Código: Fábrika: Unidade:
48073 COFAX UN/1
F1 F4

UN: R\$ 0,61 AV: R\$ 7,33 15: R\$ 7,49
30: R\$ 7,64 45: R\$ 7,79 60: R\$ 7,95



FORMA ALUM EMPADA CRESPA 2 009 CTL 12X1

Código: Fábrika: Unidade:
41356 WESTERN CR/12
F1 F4

UN: R\$ 0,37 AV: R\$ 4,41 15: R\$ 4,50
30: R\$ 4,59 45: R\$ 4,68 60: R\$ 4,77



FORMA ALUM EMPADA LISA 0 12X1

Código: Fábrika: Unidade:
36896 MABEL DZ/12
F1 F4

UN: R\$ 1,12 AV: R\$ 13,46 15: R\$ 13,74
30: R\$ 14,02 45: R\$ 14,30 60: R\$ 14,59



FORMA ALUM EMPADA LISA 00 12X1

Código: Fábrika: Unidade:
44386 DAMIAO DZ/12
F1 F4

UN: R\$ 0,61 AV: R\$ 7,33 15: R\$ 7,49
30: R\$ 7,64 45: R\$ 7,79 60: R\$ 7,95



FORMA ALUM EMPADA LISA 1 CTL 011 12X1

Código: Fábrika: Unidade:
41357 WESTERN CR/12
F1 F4

UN: R\$ 1,30 AV: R\$ 15,66 15: R\$ 15,98
30: R\$ 16,30 45: R\$ 16,63 60: R\$ 16,96



FORMA ALUM EMPADA LISA 1 12X1

Código: Fábrika: Unidade:
44388 DAMIAO DZ/12
F1 F4

UN: R\$ 0,65 AV: R\$ 7,82 15: R\$ 7,99
30: R\$ 8,15 45: R\$ 8,31 60: R\$ 8,48



FORMA ALUM EMPADA LISA 2 CTL 012 12X1

Código: Fábrika: Unidade:
41355 WESTERN CR/12
F1 F4

UN: R\$ 1,39 AV: R\$ 16,64 15: R\$ 16,98
30: R\$ 17,32 45: R\$ 17,67 60: R\$ 18,02



FORMA ALUM EMPADA LISA 2 12X1

Código: Fábrika: Unidade:
44389 DAMIAO DZ/12
F1 F4

UN: R\$ 1,59 AV: R\$ 19,09 15: R\$ 19,49
30: R\$ 19,88 45: R\$ 20,28 60: R\$ 20,69



FORMA ALUM EMPADA LISA 3 12X1

Código: Fábrika: Unidade:
44390 DAMIAO DZ/12
F1 F4

UN: R\$ 0,49 AV: R\$ 2,93 15: R\$ 2,99
30: R\$ 3,05 45: R\$ 3,11 60: R\$ 3,17



FORMA ALUM EMPADA LISA 3 6X1

Código: Fábrika: Unidade:
41448 MABEL PT/6
F1 F4

UN: R\$ 1,96 AV: R\$ 23,49 15: R\$ 23,98
30: R\$ 24,46 45: R\$ 24,95 60: R\$ 25,45



FORMA ALUM EMPADA LISA 4 12X1

Código: Fábrika: Unidade:
44391 DAMIAO DZ/12
F1 F4

UN: R\$ 3,10 AV: R\$ 37,20 15: R\$ 37,97
30: R\$ 38,73 45: R\$ 39,51 60: R\$ 40,30



FORMA ALUM EMPADA LISA 5 12X1

Código: Fábrika: Unidade:
44392 DAMIAO DZ/12
F1 F4

UN: R\$ 3,48 AV: R\$ 41,71 15: R\$ 42,58
30: R\$ 43,43 45: R\$ 44,30 60: R\$ 45,19



FORMA ALUM EMPADA LISA 6 12X1

Código: Fábrika: Unidade:
25554 DAMIAO DZ/12
F1 F4

UN: R\$ 5,30 AV: R\$ 63,64 15: R\$ 64,96
30: R\$ 66,26 45: R\$ 67,59 60: R\$ 68,94



FORMA ALUM EMPADA LISA 7 12X1

Código: Fábrika: Unidade:
38505 DAMIAO DZ/12
F1 F4

UN: R\$ 27,74 AV: R\$ 83,22 15: R\$ 84,96
30: R\$ 86,66 45: R\$ 88,39 60: R\$ 90,16



FORMA ALUM FDO REMOV 23/26/28CM 710 3X1

Código: Fábrika: Unidade:
41250 123UTIL CX/3
F1 F4

UN: R\$ 24,47 AV: R\$ 24,47 15: R\$ 24,98
30: R\$ 25,48 45: R\$ 25,99 60: R\$ 26,51



FORMA ALUM LEVE PIZZA 30

Código: Fábrika: Unidade:
5900 AVELAR UN/1
F1 F4

UN: R\$ 24,47 AV: R\$ 24,47 15: R\$ 24,98
30: R\$ 25,48 45: R\$ 25,99 60: R\$ 26,51



FORMA ALUM LEVE PUDIM 18

Código: Fábrika: Unidade:
27867 AVELAR UN/1
F1 F4

UN: R\$ 24,47 AV: R\$ 24,47 15: R\$ 24,98
30: R\$ 25,48 45: R\$ 25,99 60: R\$ 26,51



FORMA ALUM LEVE TORTA 24

Código: Fábrika: Unidade:
5901 AVELAR UN/1
F1 F4

UN: R\$ 13,70 AV: R\$ 13,70 15: R\$ 13,98
30: R\$ 14,26 45: R\$ 14,55 60: R\$ 14,84



FORMA ALUM PAO 01 1253

Código: Fábrika: Unidade:
37256 MSR UN/1
F1 F4

UN: R\$ 21,53 AV: R\$ 21,53 15: R\$ 21,98
30: R\$ 22,42 45: R\$ 22,87 60: R\$ 23,33



FORMA ALUM PAO 02 1254

Código: Fábrika: Unidade:
37255 MSR UN/1
F1 F4

UN: R\$ 28,39 AV: R\$ 28,39 15: R\$ 28,98
30: R\$ 29,56 45: R\$ 30,15 60: R\$ 30,75



FORMA ALUM PAO 03 1255

Código: Fábrika: Unidade:
37448 MSR UN/1
F1 F4

UN: R\$ 3,91 AV: R\$ 3,91 15: R\$ 3,99
30: R\$ 4,07 45: R\$ 4,15 60: R\$ 4,23



FORMA ALUM PIZZA MINI 12 CM 696

Código: Fábrika: Unidade:
37528 MSR UN/1
F1 F4

UN: R\$ 15,66 AV: R\$ 15,66 15: R\$ 15,98
30: R\$ 16,30 45: R\$ 16,63 60: R\$ 16,96



FORMA ALUM PIZZA 25 1229

Código: Fábrika: Unidade:
35274 MSR UN/1
F1 F4

UN: R\$ 22,51 AV: R\$ 22,51 15: R\$ 22,98
30: R\$ 23,44 45: R\$ 23,91 60: R\$ 24,39



FORMA ALUM PIZZA 30 675

Código: Fábrika: Unidade:
25308 MSR UN/1
F1 F4

UN: R\$ 33,28 AV: R\$ 33,28 15: R\$ 33,98
30: R\$ 34,66 45: R\$ 35,35 60: R\$ 36,06



FORMA ALUM PIZZA 35 674

Código: Fábrika: Unidade:
20736 MSR UN/1
F1 F4

UN: R\$ 38,19 AV: R\$ 38,19 15: R\$ 38,98
30: R\$ 39,76 45: R\$ 40,56 60: R\$ 41,37



FORMA ALUM POLIDO 22 BOLO VITORIA

Código: Fábrika: Unidade:
48127 ALEGRETE UN/1
F1 F4

UN: R\$ 6,84 AV: R\$ 6,84 15: R\$ 6,99
30: R\$ 7,13 45: R\$ 7,27 60: R\$ 7,41



FORMA ALUM PUDIM 12 MINI 1955

Código: Fábrika: Unidade:
37524 MSR UN/1
F1 F4

UN: R\$ 13,21 AV: R\$ 13,21 15: R\$ 13,48
30: R\$ 13,75 45: R\$ 14,03 60: R\$ 14,31



FORMA ALUM PUDIM 16 679

Código: Fábrika: Unidade:
24364 MSR UN/1
F1 F4

UN: R\$ 14,68 AV: R\$ 14,68 15: R\$ 14,98
30: R\$ 15,28 45: R\$ 15,59 60: R\$ 15,90



FORMA ALUM PUDIM 18 680

Código: Fábrika: Unidade:
24363 MSR UN/1
F1 F4

UN: R\$ 16,64 AV: R\$ 16,64 15: R\$ 16,98
30: R\$ 17,32 45: R\$ 17,67 60: R\$ 18,02



FORMA ALUM PUDIM 20 681

Código: Fábrika: Unidade:
24362 MSR UN/1
F1 F4

UN: R\$ 18,60 AV: R\$ 18,60 15: R\$ 18,98
30: R\$ 19,36 45: R\$ 19,75 60: R\$ 20,14



FORMA ALUM PUDIM 22 682

Código: Fábrica: Unidade:
24361 MSR UN/1
F1 F4

UN: R\$ 27,41 AV: R\$ 27,41 15: R\$ 27,98
30: R\$ 28,54 45: R\$ 29,11 60: R\$ 29,69



FORMA ALUM PUDIM 26 1969

Código: Fábrica: Unidade:
37522 MSR UN/1
F1 F4

UN: R\$ 21,53 AV: R\$ 21,53 15: R\$ 21,98
30: R\$ 22,42 45: R\$ 22,87 60: R\$ 23,33



FORMA ALUM TORTA 25 676

Código: Fábrica: Unidade:
8236 MSR UN/1
F1 F4

UN: R\$ 29,37 AV: R\$ 29,37 15: R\$ 29,98
30: R\$ 30,58 45: R\$ 31,19 60: R\$ 31,81



FORMA ALUM TORTA 30 677

Código: Fábrica: Unidade:
22730 MSR UN/1
F1 F4

UN: R\$ 35,24 AV: R\$ 35,24 15: R\$ 35,98
30: R\$ 36,70 45: R\$ 37,43 60: R\$ 38,18



FORMA ALUM TORTA 35 678

Código: Fábrica: Unidade:
8238 MSR UN/1
F1 F4

UN: R\$ 2,93 AV: R\$ 2,93 15: R\$ 2,99
30: R\$ 3,05 45: R\$ 3,11 60: R\$ 3,17



FORMA PLAST GELO COLOR 151

Código: Fábrica: Unidade:
12666 FORMPLAST UN/1
F1 F4

UN: R\$ 3,86 AV: R\$ 3,86 15: R\$ 3,94
30: R\$ 4,02 45: R\$ 4,10 60: R\$ 4,18



FORMA PLAST GELO TRANSP FAFILLITA 6211

Código: Fábrica: Unidade:
20713 RISCHIOTO UN/1
F1 F4

UN: R\$ 5,12 AV: R\$ 10,24 15: R\$ 10,46
30: R\$ 10,66 45: R\$ 10,88 60: R\$ 11,10

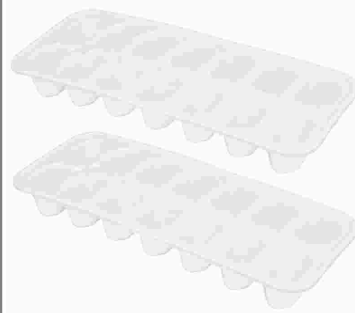

FORMA PLAST GELO 3105 2X1

Código: Fábrica: Unidade:
47056 JAGUAR CJ/2
F1 F4

UN: R\$ 5,11 AV: R\$ 5,11 15: R\$ 5,22
30: R\$ 5,32 45: R\$ 5,43 60: R\$ 5,54

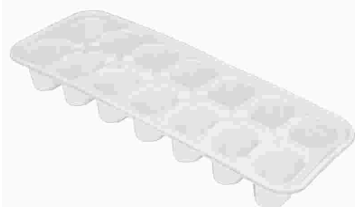

FORMA PLAST GELO 615

Código: Fábrica: Unidade:
9986 JAGUAR UN/1
F1 F4

UN: R\$ 3,21 AV: R\$ 6,41 15: R\$ 6,55
30: R\$ 6,68 45: R\$ 6,81 60: R\$ 6,95

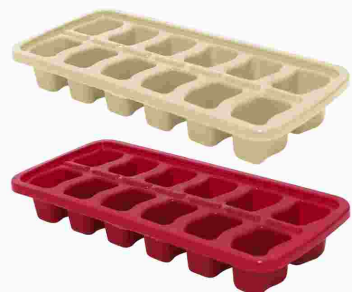

FORMA PLAST GELO 6626 2X1

Código: Fábrica: Unidade:
22501 INPLAST CJ/2
F1 F4

UN: R\$ 7,15 AV: R\$ 7,15 15: R\$ 7,30
30: R\$ 7,44 45: R\$ 7,59 60: R\$ 7,74

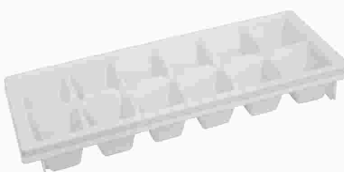

FORMA PLAST P/GELO 502

Código: Fábrica: Unidade:
35497 TRITEC UN/1
F1 F4

UN: R\$ 0,69 AV: R\$ 8,32 15: R\$ 8,50
30: R\$ 8,67 45: R\$ 8,84 60: R\$ 9,02



FORMINHA INOX CORTADOR COOKIE 12X1

Código: Fábrica: Unidade:
40525 MINGJIAN DZ/12
F1 F4

UN: R\$ 352,50 AV: R\$ 352,50 15: R\$ 359,85
30: R\$ 367,04 45: R\$ 374,38 60: R\$ 381,87



FORRO MESA LAMINADO 50M 614 0,10MM CRIST

Código: Fábrica: Unidade:
39358 PERFETTO RL/1
F1 F4

UN: R\$ 329,99 AV: R\$ 329,99 15: R\$ 336,87
30: R\$ 343,60 45: R\$ 350,47 60: R\$ 357,48



FORRO MESA LAMINADO 50M 617 CRISTAL OUTO

Código: Fábrica: Unidade:
39359 PERFETTO RL/1
F1 F4

UN: R\$ 329,99 AV: R\$ 329,99 15: R\$ 336,87
30: R\$ 343,60 45: R\$ 350,47 60: R\$ 357,48

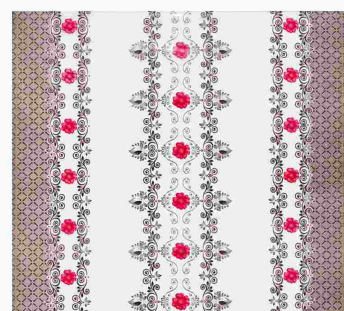

FORRO MESA LAMINADO 50M 619 CRISTAL HIBI

Código: Fábrica: Unidade:
39360 PERFETTO RL/1
F1 F4

UN: R\$ 329,99 AV: R\$ 329,99 15: R\$ 336,87
30: R\$ 343,60 45: R\$ 350,47 60: R\$ 357,48

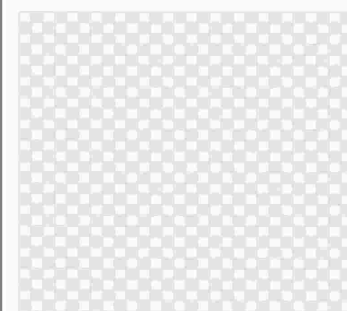

FORRO MESA LAMINADO 50M 623 CRISTAL XADR

Código: Fábrica: Unidade:
39964 PERFETTO RL/1
F1 F4

UN: R\$ 329,99 AV: R\$ 329,99 15: R\$ 336,87
30: R\$ 343,60 45: R\$ 350,47 60: R\$ 357,48

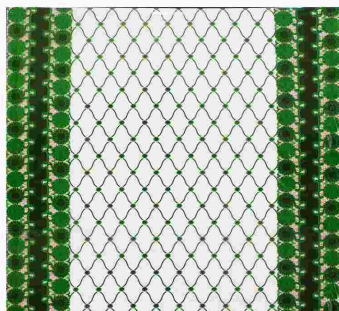

FORRO MESA LAMINADO 50M 626 CRISTAL FLOX
Código: Fábrica: Unidade:
39963 PERFETTO RL/1
F1 F4

UN: R\$ 329,99 AV: R\$ 329,99 15: R\$ 336,87
30: R\$ 343,60 45: R\$ 350,47 60: R\$ 357,48



FORRO MESA LAMINADO 50M 659 CRISTAL MARG
Código: Fábrica: Unidade:
39361 PERFETTO RL/1
F1 F4

UN: R\$ 329,99 AV: R\$ 329,99 15: R\$ 336,87
30: R\$ 343,60 45: R\$ 350,47 60: R\$ 357,48

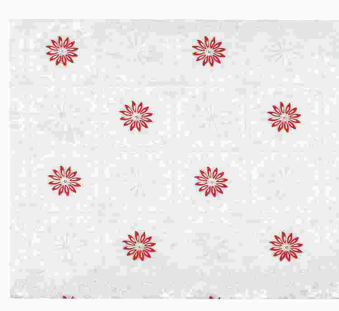

FORRO MESA LAMINADO 50M 663 CRISTAL FLOR
Código: Fábrica: Unidade:
39362 PERFETTO RL/1
F1 F4

UN: R\$ 329,99 AV: R\$ 329,99 15: R\$ 336,87
30: R\$ 343,60 45: R\$ 350,47 60: R\$ 357,48

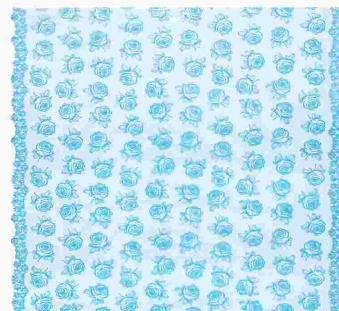

FORRO MESA LAMINADO 50M 665 CRISTAL ROSA
Código: Fábrica: Unidade:
44661 PERFETTO RL/1
F1 F4

UN: R\$ 329,99 AV: R\$ 329,99 15: R\$ 336,87
30: R\$ 343,60 45: R\$ 350,47 60: R\$ 357,48

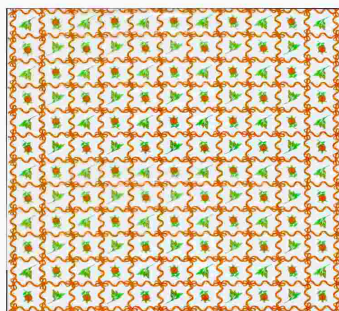

FORRO MESA LAMINADO 50M 669 CRISTAL FLOR
Código: Fábrica: Unidade:
44659 PERFETTO RL/1
F1 F4

UN: R\$ 329,99 AV: R\$ 329,99 15: R\$ 336,87
30: R\$ 343,60 45: R\$ 350,47 60: R\$ 357,48

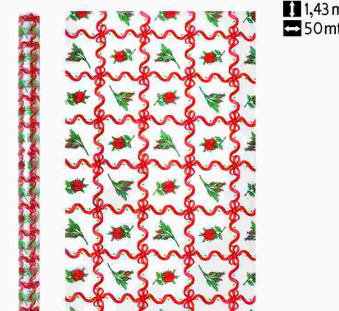

FORRO MESA LAMINADO 50M 670 CRISTAL LACO
Código: Fábrica: Unidade:
39363 PERFETTO RL/1
F1 F4

UN: R\$ 329,99 AV: R\$ 329,99 15: R\$ 336,87
30: R\$ 343,60 45: R\$ 350,47 60: R\$ 357,48

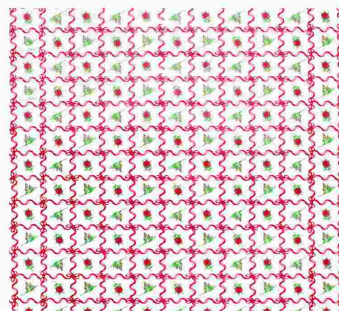

FORRO MESA LAMINADO 50M 670/1 XAD VERMEL
Código: Fábrica: Unidade:
48662 PERFETTO RL/1
F1 F4

UN: R\$ 421,05 AV: R\$ 421,05 15: R\$ 429,82
30: R\$ 438,41 45: R\$ 447,18 60: R\$ 456,13



FORRO MESA LAMINADO 50M 694 0,15MM CRIST
Código: Fábrica: Unidade:
42507 PERFETTO RL/1
F1 F4

UN: R\$ 31,32 AV: R\$ 31,32 15: R\$ 31,98
30: R\$ 32,62 45: R\$ 33,27 60: R\$ 33,93



FORRO MESA PEQ TERMICO 1,40X1,40CM T
Código: Fábrica: Unidade:
14558 FERREIRA UN/1
F1 F4

UN: R\$ 9,74 AV: R\$ 292,34 15: R\$ 298,43
30: R\$ 304,40 45: R\$ 310,49 60: R\$ 316,70



FORRO MESA TERMICO 30M 902 FLORAL ROSAS
Código: Fábrica: Unidade:
39365 PERFETTO RL/30
F1 F4

UN: R\$ 9,74 AV: R\$ 292,34 15: R\$ 298,43
30: R\$ 304,40 45: R\$ 310,49 60: R\$ 316,70



FORRO MESA TERMICO 30M 912 FLORAL MARIA
Código: Fábrica: Unidade:
39366 PERFETTO RL/30
F1 F4

UN: R\$ 9,74 AV: R\$ 292,34 15: R\$ 298,43
30: R\$ 304,40 45: R\$ 310,49 60: R\$ 316,70



FORRO MESA TERMICO 30M 1024 PONTO CRUZ M
Código: Fábrica: Unidade:
40814 PERFETTO RL/30
F1 F4

UN: R\$ 9,74 AV: R\$ 292,34 15: R\$ 298,43
30: R\$ 304,40 45: R\$ 310,49 60: R\$ 316,70



FORRO MESA TERMICO 30M 1107 VASO CORACAO
Código: Fábrica: Unidade:
40815 PERFETTO RL/30
F1 F4

UN: R\$ 9,74 AV: R\$ 292,34 15: R\$ 298,43
30: R\$ 304,40 45: R\$ 310,49 60: R\$ 316,70



FORRO MESA TERMICO 30M 1113 CAFE JADE
Código: Fábrica: Unidade:
40816 PERFETTO RL/30
F1 F4

UN: R\$ 9,74 AV: R\$ 292,34 15: R\$ 298,43
30: R\$ 304,40 45: R\$ 310,49 60: R\$ 316,70



FORRO MESA TERMICO 30M 1114 CAFE HOTENSI
Código: Fábrica: Unidade:
42504 PERFETTO RL/30
F1 F4

UN: R\$ 9,74 AV: R\$ 292,34 15: R\$ 298,43
30: R\$ 304,40 45: R\$ 310,49 60: R\$ 316,70



FORRO MESA TERMICO 30M 1115 GIRASSOL MAR
Código: Fábrica: Unidade:
40817 PERFETTO RL/30
F1 F4

UN: R\$ 9,74 AV: R\$ 292,34 15: R\$ 298,43
30: R\$ 304,40 45: R\$ 310,49 60: R\$ 316,70



FORRO MESA TERMICO 30M 1121 BANANEIRA PI
Código: Fábrica: Unidade:
42498 PERFETTO RL/30
F1 F4

UN: R\$ 9,74 AV: R\$ 292,34 15: R\$ 298,43
30: R\$ 304,40 45: R\$ 310,49 60: R\$ 316,70



FORRO MESA TERMICO 30M 1125 3 ESTACOES
Código: Fábrica: Unidade:
42494 PERFETTO RL/30
F1 F4

UN: R\$ 9,74 AV: R\$ 292,34 15: R\$ 298,43
30: R\$ 304,40 45: R\$ 310,49 60: R\$ 316,70



FORRO MESA TERMICO 30M 1128 LISTR HORTEN
Código: Fábrica: Unidade:
44658 PERFETTO RL/30
F1 F4

UN: R\$ 9,74 AV: R\$ 292,34 15: R\$ 298,43
30: R\$ 304,40 45: R\$ 310,49 60: R\$ 316,70



FORRO MESA TERMICO 30M 1133 BARRAD RENDA
Código: Fábrica: Unidade:
47098 PERFETTO RL/30
F1 F4

UN: R\$ 9,74 AV: R\$ 292,34 15: R\$ 298,43
30: R\$ 304,40 45: R\$ 310,49 60: R\$ 316,70

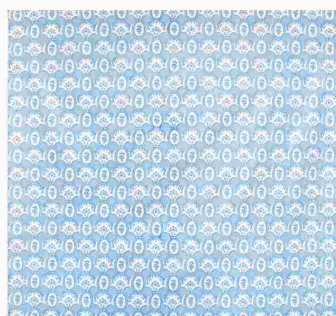

FORRO MESA TERMICO 30M 1137 RENDA AZULEJ
Código: Fábrica: Unidade:
47096 PERFETTO RL/30
F1 F4

UN: R\$ 9,74 AV: R\$ 292,34 15: R\$ 298,43
30: R\$ 304,40 45: R\$ 310,49 60: R\$ 316,70



FORRO MESA TERMICO 30M 1172 BUQUE FLORAL
Código: Fábrica: Unidade:
47100 PERFETTO RL/30
F1 F4

UN: R\$ 9,74 AV: R\$ 292,34 15: R\$ 298,43
30: R\$ 304,40 45: R\$ 310,49 60: R\$ 316,70



FORRO MESA TERMICO 30M 1176 JARRO TERRAC
Código: Fábrica: Unidade:
39966 PERFETTO RL/30
F1 F4

UN: R\$ 0,31 AV: R\$ 15,34 15: R\$ 15,66
30: R\$ 15,98 45: R\$ 16,30 60: R\$ 16,62



FORRO PAPEL P/AIR FRYER QUAD 130G 50X1
Código: Fábrica: Unidade:
45908 WINMAX PT/50
F1 F4

UN: R\$ 0,31 AV: R\$ 15,28 15: R\$ 15,59
30: R\$ 15,91 45: R\$ 16,22 60: R\$ 16,55



FORRO PAPEL P/AIR FRYER RED 111G 50X1
Código: Fábrica: Unidade:
45907 WINMAX PT/50
F1 F4

UN: R\$ 1,26 AV: R\$ 1,26 15: R\$ 1,29
30: R\$ 1,32 45: R\$ 1,34 60: R\$ 1,37



FRASCO PLAST 200 ML C/TAMPA (GARRAFA)
Código: Fábrica: Unidade:
51074 DECOPLAST UN/1
F1 F4

UN: R\$ 1,26 AV: R\$ 1,26 15: R\$ 1,29
30: R\$ 1,32 45: R\$ 1,34 60: R\$ 1,37



FRASCO PLAST 300 ML C/TAMPA (GARRAFA)
Código: Fábrica: Unidade:
40505 ARBRA UN/1
F1 F4

UN: R\$ 21,53 AV: R\$ 21,53 15: R\$ 21,98
30: R\$ 22,42 45: R\$ 22,87 60: R\$ 23,33



FRIGIDEIRA ALUM EXTRA FORTE 20 683
Código: Fábrica: Unidade:
8490 MSR UN/1
F1 F4

UN: R\$ 27,41 AV: R\$ 27,41 15: R\$ 27,98
30: R\$ 28,54 45: R\$ 29,11 60: R\$ 29,69



FRIGIDEIRA ALUM EXTRA FORTE 22 684
Código: Fábrica: Unidade:
8241 MSR UN/1
F1 F4

UN: R\$ 30,45 AV: R\$ 30,45 15: R\$ 31,09
30: R\$ 31,71 45: R\$ 32,34 60: R\$ 32,99



FRIGIDEIRA ALUM FRANCESA 18 PRIME 1557
Código: Fábrica: Unidade:
45291 MSR UN/1
F1 F4

UN: R\$ 33,43 AV: R\$ 33,43 15: R\$ 34,13
30: R\$ 34,81 45: R\$ 35,51 60: R\$ 36,22



FRIGIDEIRA ALUM FRANCESA 20 PRIME 1560
Código: Fábrica: Unidade:
45287 MSR UN/1
F1 F4

UN: R\$ 38,18 AV: R\$ 38,18 15: R\$ 38,97
30: R\$ 39,75 45: R\$ 40,55 60: R\$ 41,36



FRIGIDEIRA ALUM FRANCESA 22 ANTI IN 2547
Código: Fábrica: Unidade:
45286 MSR UN/1
F1 F4

UN: R\$ 36,52 AV: R\$ 36,52 15: R\$ 37,29
30: R\$ 38,03 45: R\$ 38,79 60: R\$ 39,57



FRIGIDEIRA ALUM FRANCESA 22 PRIME 1563
Código: Fábrica: Unidade:
45290 MSR UN/1
F1 F4

UN: R\$ 36,72 AV: R\$ 36,72 15: R\$ 37,49
30: R\$ 38,23 45: R\$ 39,00 60: R\$ 39,78



FRIGIDEIRA ALUM FRANCESA 24 ANTI IN 2548
Código: Fábrica: Unidade:
45285 MSR UN/1
F1 F4

UN: R\$ 41,62 AV: R\$ 41,62 15: R\$ 42,48
30: R\$ 43,33 45: R\$ 44,20 60: R\$ 45,08



FRIGIDEIRA ALUM FRANCESA 24 PRIME 1566
Código: Fábrica: Unidade:
45289 MSR UN/1
F1 F4

UN: R\$ 13,68 AV: R\$ 13,68 15: R\$ 13,96
30: R\$ 14,24 45: R\$ 14,53 60: R\$ 14,82



FRIGIDEIRA ALUM LEVE 16 685
Código: Fábrica: Unidade:
35268 MSR UN/1
F1 F4

UN: R\$ 24,47 AV: R\$ 24,47 15: R\$ 24,98
30: R\$ 25,48 45: R\$ 25,99 60: R\$ 26,51



FRIGIDEIRA ALUM LEVE 20 S/TAMPA 1,3LTS
Código: Fábrica: Unidade:
5898 AVELAR UN/1
F1 F4

UN: R\$ 112,02 AV: R\$ 112,02 15: R\$ 114,35
30: R\$ 116,64 45: R\$ 118,97 60: R\$ 121,35



FRIGIDEIRA ALUM 34 TOP QUALI FRANC CINZA
Código: Fábrica: Unidade:
48121 ALEGRETE UN/1
F1 F4

UN: R\$ 23,63 AV: R\$ 23,63 15: R\$ 24,12
30: R\$ 24,60 45: R\$ 25,09 60: R\$ 25,60



FRITURAMA CROM P/FRIGIDEIRA 116
Código: Fábrica: Unidade:
28963 ARAMINAS UN/1
F1 F4

UN: R\$ 34,27 AV: R\$ 34,27 15: R\$ 34,99
30: R\$ 35,69 45: R\$ 36,40 60: R\$ 37,13



FRITURAMA CROM REDONDA 15 42
Código: Fábrica: Unidade:
28970 ARAMINAS UN/1
F1 F4

UN: R\$ 38,19 AV: R\$ 38,19 15: R\$ 38,98
30: R\$ 39,76 45: R\$ 40,56 60: R\$ 41,37

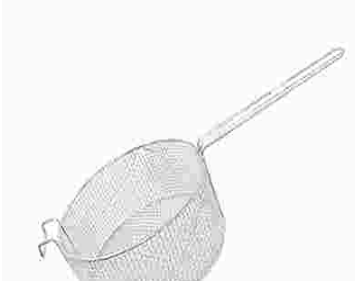

FRITURAMA CROM REDONDA 20 43
Código: Fábrica: Unidade:
28971 ARAMINAS UN/1
F1 F4

UN: R\$ 44,06 AV: R\$ 44,06 15: R\$ 44,98
30: R\$ 45,88 45: R\$ 46,80 60: R\$ 47,74



FRITURAMA CROM REDONDA 25 44
Código: Fábrica: Unidade:
28972 ARAMINAS UN/1
F1 F4

UN: R\$ 47,98 AV: R\$ 47,98 15: R\$ 48,98
30: R\$ 49,96 45: R\$ 50,96 60: R\$ 51,98

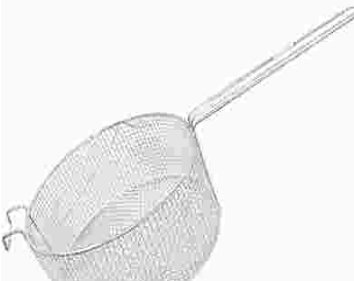

FRITURAMA CROM REDONDA 30 45
Código: Fábrica: Unidade:
28973 ARAMINAS UN/1
F1 F4

UN: R\$ 33,28 AV: R\$ 33,28 15: R\$ 33,98
30: R\$ 34,66 45: R\$ 35,35 60: R\$ 36,06



FRUTEIRA CROM DE MESA 367
Código: Fábrica: Unidade:
28956 ARAMINAS UN/1
F1 F4

UN: R\$ 32,51 AV: R\$ 32,51 15: R\$ 33,19
30: R\$ 33,85 45: R\$ 34,53 60: R\$ 35,22

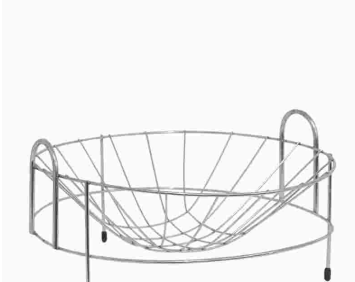

FRUTEIRA CROM RED 1 ANDAR 2378
Código: Fábrica: Unidade:
40250 ARAMIG UN/1
F1 F4

UN: R\$ 43,43 AV: R\$ 43,43 15: R\$ 44,33
30: R\$ 45,22 45: R\$ 46,12 60: R\$ 47,05



FRUTEIRA CROM RED 2 ANDARES 2377
Código: Fábrica: Unidade:
40245 ARAMIG UN/1
F1 F4

UN: R\$ 3,15 AV: R\$ 3,15 15: R\$ 3,22
30: R\$ 3,28 45: R\$ 3,35 60: R\$ 3,42



FRUTEIRA REF 119 32 CM
Código: Fábrica: Unidade:
12128 PARAMOUNT UN/1
F1 F4

UN: R\$ 25,80 AV: R\$ 25,80 15: R\$ 26,34
30: R\$ 26,87 45: R\$ 27,40 60: R\$ 27,95



FUMO P/PLANTA LIQUIDO 500 ML
Código: Fábrica: Unidade:
30300 VITAPLAN UN/1
F1 F4

UN: R\$ 23,43 AV: R\$ 23,43 15: R\$ 23,92
30: R\$ 24,40 45: R\$ 24,89 60: R\$ 25,38



FUMO P/PLANTA PO 400 GRS
Código: Fábrica: Unidade:
30299 VITAPLAN CX/1
F1 F4

UN: R\$ 1,50 AV: R\$ 17,99 15: R\$ 18,36
30: R\$ 18,73 45: R\$ 19,10 60: R\$ 19,49



FUNIL PLAST 10 CM DIAM 5016 12X1
Código: Fábrica: Unidade:
15315 SBRISSA DZ/12
F1 F4

UN: R\$ 5,87 AV: R\$ 5,87 15: R\$ 5,99
30: R\$ 6,11 45: R\$ 6,23 60: R\$ 6,35



FUNIL PLAST 12,5X25CM C/PENEIRA 0621
Código: Fábrica: Unidade:
44505 PLANETA UN/1
F1 F4

UN: R\$ 7,54 AV: R\$ 7,54 15: R\$ 7,70
30: R\$ 7,85 45: R\$ 8,01 60: R\$ 8,17



FUNIL PLAST 15 CM DIAM C/PENEIRA 0622
Código: Fábrica: Unidade:
44504 PLANETA UN/1
F1 F4

UN: R\$ 11,16 AV: R\$ 11,16 15: R\$ 11,40
30: R\$ 11,62 45: R\$ 11,86 60: R\$ 12,09



FUNIL PLAST 4" C/PENEIRA BICO FLEX 1473
Código: Fábrica: Unidade:
51039 BESTFER UN/1
F1 F4

UN: R\$ 3,42 AV: R\$ 3,42 15: R\$ 3,49
30: R\$ 3,56 45: R\$ 3,63 60: R\$ 3,70

10cm



FUNIL PLASTICO 10 CM DIAM 32020
Código: Fábrica: Unidade:
38425 ALMEGA UN/1
F1 F4

UN: R\$ 3,91 AV: R\$ 3,91 15: R\$ 3,99
30: R\$ 4,07 45: R\$ 4,15 60: R\$ 4,23



FUNIL PLASTICO 3PCS 9,5X8X6,5CM 13784
Código: Fábrica: Unidade:
34443 ALIANCA CJ/1
F1 F4

UN: R\$ 4,34 AV: R\$ 52,04 15: R\$ 53,13
30: R\$ 54,19 45: R\$ 55,28 60: R\$ 56,38



FURA COCO INOX 10CM 1009 12X1
Código: Fábrica: Unidade:
33291 JWC DZ/12
F1 F4

UN: R\$ 2,63 AV: R\$ 2,63 15: R\$ 2,69
30: R\$ 2,74 45: R\$ 2,80 60: R\$ 2,85



GANCHEIRA P/VASSOURAS 1521
Código: Fábrica: Unidade:
12908 CONDOR UN/1
F1 F4

UN: R\$ 3,71 AV: R\$ 3,71 15: R\$ 3,79
30: R\$ 3,86 45: R\$ 3,94 60: R\$ 4,02



GANCHO CROM ACOUGUE 01 141
Código: Fábrica: Unidade:
49013 ARAMINAS UN/1
F1 F4

UN: R\$ 4,20 AV: R\$ 4,20 15: R\$ 4,29
30: R\$ 4,37 45: R\$ 4,46 60: R\$ 4,55



GANCHO CROM ACOUGUE 02 140
Código: Fábrica: Unidade:
49014 ARAMINAS UN/1
F1 F4

UN: R\$ 4,89 AV: R\$ 4,89 15: R\$ 4,99
30: R\$ 5,09 45: R\$ 5,19 60: R\$ 5,29



GANCHO CROM ACOUGUE 03 181
Código: Fábrica: Unidade:
49015 ARAMINAS UN/1
F1 F4

UN: R\$ 6,84 AV: R\$ 6,84 15: R\$ 6,99
30: R\$ 7,13 45: R\$ 7,27 60: R\$ 7,41



GANCHO CROM ACOUGUE 04 182
Código: Fábrica: Unidade:
48403 ARAMINAS UN/1
F1 F4

UN: R\$ 11,05 AV: R\$ 11,05 15: R\$ 11,28
30: R\$ 11,50 45: R\$ 11,73 60: R\$ 11,97



GANCHO DECORATIVO MDF 13X9,5CM 804
Código: Fábrica: Unidade:
40906 FUTURO UN/1
F1 F4

UN: R\$ 6,07 AV: R\$ 6,07 15: R\$ 6,20
30: R\$ 6,32 45: R\$ 6,45 60: R\$ 6,58



GANCHO PLAST C/VENTOSA 8 PCS 56045
Código: Fábrica: Unidade:
40809 BLESSED CJ/1
F1 F4





UN: R\$ 12,72 AV: R\$ 12,72 15: R\$ 12,98
30: R\$ 13,24 45: R\$ 13,51 60: R\$ 13,78

30cm



GARFO ALUM BATIDO 30CM 2642
Código: Fábrica: Unidade:
45296 MSR UN/1
F1 F4

Departamento: UTILIDADE Região: GRANDE BH Pagina 68

<p>UN: R\$ 9,78 AV: R\$ 9,78 15: R\$ 9,99 30: R\$ 10,19 45: R\$ 10,39 60: R\$ 10,60</p>  <p>GARFO ALUM FUNDIDO 30CM Código: 32525 Fábrica: AVELAR Unidade: UN/1 F1 F4</p>	<p>UN: R\$ 8,81 AV: R\$ 52,88 15: R\$ 53,98 30: R\$ 55,06 45: R\$ 56,16 60: R\$ 57,28</p>  <p>GARFO ALUM INTERICO 28CM 12X1 Código: 41834 Fábrica: COFAX Unidade: PT/6 F1 F4</p>	<p>UN: R\$ 4,75 AV: R\$ 4,75 15: R\$ 4,85 30: R\$ 4,95 45: R\$ 5,04 60: R\$ 5,14</p>  <p>GARFO ALUM 28CM CB MAD 2004 UN Código: 48074 Fábrica: COFAX Unidade: UN/1 F1 F4</p>	<p>UN: R\$ 10,76 AV: R\$ 10,76 15: R\$ 10,99 30: R\$ 11,21 45: R\$ 11,43 60: R\$ 11,66</p>  <p>GARFO CROM CABO MADEIRA 35 0050 Código: 40256 Fábrica: ARAMINAS Unidade: UN/1 F1 F4</p>
<p>UN: R\$ 18,60 AV: R\$ 18,60 15: R\$ 18,98 30: R\$ 19,36 45: R\$ 19,75 60: R\$ 20,14</p>  <p>GARFO CROM CABO MADEIRA 45 0051 Código: 40257 Fábrica: ARAMINAS Unidade: UN/1 F1 F4</p>	<p>UN: R\$ 22,51 AV: R\$ 22,51 15: R\$ 22,98 30: R\$ 23,44 45: R\$ 23,91 60: R\$ 24,39</p>  <p>GARFO CROM CABO MADEIRA 55 0052 Código: 40258 Fábrica: ARAMINAS Unidade: UN/1 F1 F4</p>	<p>UN: R\$ 1,95 AV: R\$ 23,38 15: R\$ 23,87 30: R\$ 24,35 45: R\$ 24,83 60: R\$ 25,33</p>  <p>GARFO INOX MESA LINHA AMERICA 2221 12X1 Código: 50622 Fábrica: STEEL Unidade: PT/12 F1 F4</p>	<p>UN: R\$ 2,73 AV: R\$ 16,35 15: R\$ 16,69 30: R\$ 17,03 45: R\$ 17,37 60: R\$ 17,72</p>  <p>GARFO INOX MESA UNIVERSO 2047 6X1 Código: 50137 Fábrica: GP6 Unidade: PT/6 F1 F4</p>
<p>UN: R\$ 1,96 AV: R\$ 23,49 15: R\$ 23,98 30: R\$ 24,46 45: R\$ 24,95 60: R\$ 25,45</p>  <p>GARFO INOX MESA 19CM VERS PTO 952 12X1 Código: 50161 Fábrica: PLANETA Unidade: DZ/12 F1 F4</p>	<p>UN: R\$ 0,38 AV: R\$ 4,55 15: R\$ 4,65 30: R\$ 4,74 45: R\$ 4,84 60: R\$ 4,93</p>  <p>GARFO PLASTICO 402 12X1 Código: 10957 Fábrica: ECOPLASTIC Unidade: DZ/12 F1 F4</p>	<p>UN: R\$ 73,43 AV: R\$ 73,43 15: R\$ 74,96 30: R\$ 76,46 45: R\$ 77,99 60: R\$ 79,55</p>  <p>GARRAFA INOX TERM 500ML DIGITAL LED 2117 Código: 41450 Fábrica: EXCALIBUR Unidade: UN/1 F1 F4</p>	<p>UN: R\$ 49,99 AV: R\$ 49,99 15: R\$ 51,03 30: R\$ 52,05 45: R\$ 53,09 60: R\$ 54,15</p>  <p>GARRAFA INOX TERM 650ML 803-16 Código: 40670 Fábrica: CASA ONZE Unidade: UN/1 F1 F4</p>
<p>UN: R\$ 6,36 AV: R\$ 6,36 15: R\$ 6,49 30: R\$ 6,62 45: R\$ 6,75 60: R\$ 6,88</p>  <p>GARRAFA PLAST 1,0 LT COLOR RED 840 Código: 35838 Fábrica: LUMAR Unidade: UN/1 F1 F4</p>	<p>UN: R\$ 6,11 AV: R\$ 6,11 15: R\$ 6,24 30: R\$ 6,36 45: R\$ 6,49 60: R\$ 6,62</p>  <p>GARRAFA PLAST 1,0 LT COLOR RET 841 Código: 35839 Fábrica: LUMAR Unidade: UN/1 F1 F4</p>	<p>UN: R\$ 8,93 AV: R\$ 8,93 15: R\$ 9,12 30: R\$ 9,30 45: R\$ 9,48 60: R\$ 9,67</p>  <p>GARRAFA PLAST 1,1 LTS AGUA 1092 Código: 33025 Fábrica: TRITEC Unidade: UN/1 F1 F4</p>	<p>UN: R\$ 8,34 AV: R\$ 8,34 15: R\$ 8,52 30: R\$ 8,69 45: R\$ 8,86 60: R\$ 9,04</p>  <p>GARRAFA PLAST 1,5 LTS AGUA 1470 Código: 47061 Fábrica: JAGUAR Unidade: UN/1 F1 F4</p>

UN: R\$ 7,82 AV: R\$ 7,82 15: R\$ 7,99
30: R\$ 8,15 45: R\$ 8,31 60: R\$ 8,48



GARRAFA PLAST 1,5 LTS COLOR 812

Código: 35833 Fábrica: LUMAR Unidade: UN/1 F1 F4

UN: R\$ 7,82 AV: R\$ 7,82 15: R\$ 7,99
30: R\$ 8,15 45: R\$ 8,31 60: R\$ 8,48



GARRAFA PLAST 1,5 LTS TRANSP 810

Código: 35834 Fábrica: LUMAR Unidade: UN/1 F1 F4

UN: R\$ 13,11 AV: R\$ 13,11 15: R\$ 13,38
30: R\$ 13,65 45: R\$ 13,93 60: R\$ 14,20

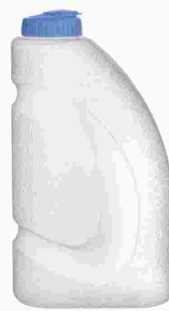

GARRAFA PLAST 2,0 LTS AGUA 697

Código: 33030 Fábrica: TRITEC Unidade: UN/1 F1 F4

UN: R\$ 9,61 AV: R\$ 9,61 15: R\$ 9,81
30: R\$ 10,00 45: R\$ 10,20 60: R\$ 10,41



GARRAFA PLAST 2,0 LTS COLOR 813

Código: 35837 Fábrica: LUMAR Unidade: UN/1 F1 F4

UN: R\$ 9,08 AV: R\$ 9,08 15: R\$ 9,27
30: R\$ 9,45 45: R\$ 9,64 60: R\$ 9,83



GARRAFA PLAST 2,0 LTS TRANSP 809

Código: 35836 Fábrica: LUMAR Unidade: UN/1 F1 F4

UN: R\$ 21,76 AV: R\$ 21,76 15: R\$ 22,21
30: R\$ 22,66 45: R\$ 23,11 60: R\$ 23,57



GARRAFA PLAST 3,2 LTS RET C/TPA 3003

Código: 47064 Fábrica: JAGUAR Unidade: UN/1 F1 F4

UN: R\$ 6,44 AV: R\$ 6,44 15: R\$ 6,58
30: R\$ 6,71 45: R\$ 6,84 60: R\$ 6,98



GARRAFA PLAST 750ML AGUA 1469

Código: 47060 Fábrica: JAGUAR Unidade: UN/1 F1 F4

UN: R\$ 48,95 AV: R\$ 48,95 15: R\$ 49,97
30: R\$ 50,97 45: R\$ 51,99 60: R\$ 53,03



GARRAFA TERM 1LT BCA C/TAMPA COLOR 41458

Código: 41458 Fábrica: MABEL Unidade: UN/1 F1 F4

UN: R\$ 121,41 AV: R\$ 121,41 15: R\$ 123,94
30: R\$ 126,42 45: R\$ 128,95 60: R\$ 131,53



GARRAFA TERM 500ML EMB CRUZEIRO 2913

Código: 39043 Fábrica: BRASFOOT Unidade: UN/1 F1 F4

UN: R\$ 69,86 AV: R\$ 69,86 15: R\$ 71,31
30: R\$ 72,74 45: R\$ 74,19 60: R\$ 75,68



GARRAFA TERMICA 1 LT COLOR C/4 CANECAS

Código: 49733 Fábrica: FUTURO CASA Unidade: UN/1 F1 F4

UN: R\$ 33,19 AV: R\$ 33,19 15: R\$ 33,89
30: R\$ 34,56 45: R\$ 35,26 60: R\$ 35,96



GARRAFA TERMICA 1 LT LOTUS COLOR

Código: 44784 Fábrica: SOPRANO Unidade: UN/1 F1 F4

UN: R\$ 32,84 AV: R\$ 197,02 15: R\$ 201,12
30: R\$ 205,14 45: R\$ 209,24 60: R\$ 213,43



GARRAFA TERMICA 1 LT PRETO 6X1

Código: 36732 Fábrica: INVICTA Unidade: CX/6 F1 F4

UN: R\$ 49,78 AV: R\$ 298,66 15: R\$ 304,88
30: R\$ 310,98 45: R\$ 317,20 60: R\$ 323,54



GARRAFA TERMICA 1 LT SONETO FEN SORT 6X1

Código: 45638 Fábrica: SOPRANO Unidade: CX/6 F1 F4

UN: R\$ 74,41 AV: R\$ 74,41 15: R\$ 75,96
30: R\$ 77,48 45: R\$ 79,03 60: R\$ 80,61



GARRAFA TERMICA 1L INOX 965

Código: 50229 Fábrica: FUTURO Unidade: UN/1 F1 F4

UN: R\$ 62,23 AV: R\$ 62,23 15: R\$ 63,52
30: R\$ 64,80 45: R\$ 66,09 60: R\$ 67,41



GARRAFA TERMICA 1L SAMOA AZUL 9397

Código: 51139 Fábrica: GP6 Unidade: UN/1 F1 F4

UN: R\$ 127,29 AV: R\$ 127,29 15: R\$ 129,94
30: R\$ 132,54 45: R\$ 135,19 60: R\$ 137,89



GARRAFA TERMICA 1,9L ACO 12418

Código: 46248 Fábrica: CASITA Unidade: UN/1 F1 F4

UN: R\$ 123,37 AV: R\$ 123,37 15: R\$ 125,94
30: R\$ 128,46 45: R\$ 131,03 60: R\$ 133,65



GARRAFA TERMICA 1,9L INOX 12482
Código: 47313 Fábrica: CASITA Unidade: UN/1 F1 F4

UN: R\$ 120,93 AV: R\$ 120,93 15: R\$ 123,45
30: R\$ 125,92 45: R\$ 128,44 60: R\$ 131,01



GARRAFA TERMICA 1,9L INOX 14X25CM 12489
Código: 50214 Fábrica: CASITA Unidade: UN/1 F1 F4

UN: R\$ 107,70 AV: R\$ 107,70 15: R\$ 109,95
30: R\$ 112,14 45: R\$ 114,39 60: R\$ 116,68



GARRAFA TERMICA 500ML NEO EMB ATLETICO
Código: 39044 Fábrica: BRASFOOT Unidade: UN/1 F1 F4

UN: R\$ 9,78 AV: R\$ 9,78 15: R\$ 9,99
30: R\$ 10,19 45: R\$ 10,39 60: R\$ 10,60



GARRAFA VIDRO 460ML C/CANUDO PLAST 16015
Código: 47899 Fábrica: CASITA Unidade: UN/1 F1 F4

UN: R\$ 6,84 AV: R\$ 6,84 15: R\$ 6,99
30: R\$ 7,13 45: R\$ 7,27 60: R\$ 7,41



GARRAFA 1L SPORT PLAST COLOR 4101
Código: 42767 Fábrica: DITTOY Unidade: UN/1 F1 F4

UN: R\$ 6,84 AV: R\$ 6,84 15: R\$ 6,99
30: R\$ 7,13 45: R\$ 7,27 60: R\$ 7,41



GARRAFA 500 ML GALAO PLAST COLOR 4014
Código: 42770 Fábrica: DITTOY Unidade: UN/1 F1 F4

UN: R\$ 6,84 AV: R\$ 6,84 15: R\$ 6,99
30: R\$ 7,13 45: R\$ 7,27 60: R\$ 7,41



GARRAFA 500 ML SPORT PLAST COLOR 4103
Código: 42776 Fábrica: DITTOY Unidade: UN/1 F1 F4

UN: R\$ 48,95 AV: R\$ 48,95 15: R\$ 49,97
30: R\$ 50,97 45: R\$ 51,99 60: R\$ 53,03



GARRAFAO TERMICO 3 LITS AZUL
Código: 40035 Fábrica: ANTARES Unidade: UN/1 F1 F4

UN: R\$ 48,95 AV: R\$ 48,95 15: R\$ 49,97
30: R\$ 50,97 45: R\$ 51,99 60: R\$ 53,03



GARRAFAO TERMICO 3 LITS VERMELHO
Código: 49919 Fábrica: ANTARES Unidade: UN/1 F1 F4

UN: R\$ 54,83 AV: R\$ 54,83 15: R\$ 55,97
30: R\$ 57,09 45: R\$ 58,23 60: R\$ 59,39



GARRAFAO TERMICO 5 LITS VERMELHO
Código: 40170 Fábrica: ANTARES Unidade: UN/1 F1 F4

UN: R\$ 36,22 AV: R\$ 36,22 15: R\$ 36,98
30: R\$ 37,71 45: R\$ 38,47 60: R\$ 39,24



GRELHA DOBRAVEL ABAULADA 01 PQ 58X17CM
Código: 24062 Fábrica: ARAMINAS Unidade: UN/1 F1 F4

UN: R\$ 48,95 AV: R\$ 48,95 15: R\$ 49,97
30: R\$ 50,97 45: R\$ 51,99 60: R\$ 53,03



GRELHA DOBRAVEL ABAULADA 02 MED 65X21CM
Código: 24063 Fábrica: ARAMINAS Unidade: UN/1 F1 F4

UN: R\$ 64,07 AV: R\$ 64,07 15: R\$ 65,40
30: R\$ 66,71 45: R\$ 68,05 60: R\$ 69,41



GRELHA DOBRAVEL ABAULADA 03 GDE 74X26CM
Código: 24064 Fábrica: ARAMINAS Unidade: UN/1 F1 F4

UN: R\$ 38,18 AV: R\$ 38,18 15: R\$ 38,97
30: R\$ 39,75 45: R\$ 40,55 60: R\$ 41,36



GRELHA DOBRAVEL RETA 01 PQ 58X17CM
Código: 24065 Fábrica: ARAMINAS Unidade: UN/1 F1 F4

UN: R\$ 48,95 AV: R\$ 48,95 15: R\$ 49,97
30: R\$ 50,97 45: R\$ 51,99 60: R\$ 53,03



GRELHA DOBRAVEL RETA 02 MED 65X21CM
Código: 24066 Fábrica: ARAMINAS Unidade: UN/1 F1 F4

UN: R\$ 67,56 AV: R\$ 67,56 15: R\$ 68,96
30: R\$ 70,34 45: R\$ 71,75 60: R\$ 73,18



GRELHA DOBRAVEL RETA 03 GDE 74X26CM
Código: 24067 Fábrica: ARAMINAS Unidade: UN/1 F1 F4

UN: R\$ 88,12 AV: R\$ 88,12 15: R\$ 89,95
30: R\$ 91,75 45: R\$ 93,59 60: R\$ 95,46



GUARDA SOL 1,80X2,0 MTS

Código: 32361 Fábrica: ANTARES Unidade: UN/1 F1 F4

UN: R\$ 1,82 AV: R\$ 16,35 15: R\$ 16,69
30: R\$ 17,03 45: R\$ 17,37 60: R\$ 17,72

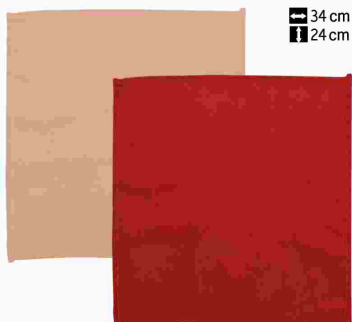

GUARDANAPO PANO LISO 34X24CM 1150 9X1

Código: 40449 Fábrica: SUN WELLS Unidade: PT/9 F1 F4

UN: R\$ 0,01 AV: R\$ 19,57 15: R\$ 19,98
30: R\$ 20,38 45: R\$ 20,79 60: R\$ 21,21



GUARDANAPO PAPEL 14X13CM C/500 4X1

Código: 40581 Fábrica: PANTANAL Unidade: PT/2000 F1 F4

UN: R\$ 0,03 AV: R\$ 1,71 15: R\$ 1,75
30: R\$ 1,78 45: R\$ 1,82 60: R\$ 1,86



GUARDANAPO PAPEL 22,5X20CM 50X1

Código: 47275 Fábrica: DOURADAO Unidade: PT/50 F1 F4

UN: R\$ 0,07 AV: R\$ 3,61 15: R\$ 3,69
30: R\$ 3,76 45: R\$ 3,84 60: R\$ 3,91



GUARDANAPO PAPEL 32,5X30CM 50X1

Código: 47263 Fábrica: DOURADAO Unidade: PT/50 F1 F4

UN: R\$ 10,28 AV: R\$ 10,28 15: R\$ 10,50
30: R\$ 10,71 45: R\$ 10,92 60: R\$ 11,14



GUIA PET 3 MTS 13345

Código: 39245 Fábrica: ALIANCA Unidade: UN/1 F1 F4

UN: R\$ 1,81 AV: R\$ 1,81 15: R\$ 1,85
30: R\$ 1,89 45: R\$ 1,92 60: R\$ 1,96



HASTE PLAST P/VASO 40 CM MARRON

Código: 39215 Fábrica: NUTRIPLAN Unidade: UN/1 F1 F4

UN: R\$ 2,11 AV: R\$ 2,11 15: R\$ 2,15
30: R\$ 2,19 45: R\$ 2,24 60: R\$ 2,28



HASTE PLAST P/VASO 40 CM PRETA

Código: 39214 Fábrica: NUTRIPLAN Unidade: UN/1 F1 F4

UN: R\$ 41,25 AV: R\$ 41,25 15: R\$ 42,11
30: R\$ 42,96 45: R\$ 43,81 60: R\$ 44,69



HUMUS DE MINHOCAS 10 KG

Código: 30088 Fábrica: NOVATROPICAL Unidade: PT/1 F1 F4

UN: R\$ 36,22 AV: R\$ 36,22 15: R\$ 36,98
30: R\$ 37,71 45: R\$ 38,47 60: R\$ 39,24



JARDINEIRA ELEGANCE AUTOIR 01 VERDE NEON

Código: 42167 Fábrica: NUTRIPLAN Unidade: UN/1 F1 F4

UN: R\$ 39,16 AV: R\$ 39,16 15: R\$ 39,97
30: R\$ 40,77 45: R\$ 41,59 60: R\$ 42,42



JARDINEIRA ELEGANCE AUTOIRR 01 CAFE IMP

Código: 36202 Fábrica: NUTRIPLAN Unidade: UN/1 F1 F4

UN: R\$ 34,26 AV: R\$ 34,26 15: R\$ 34,98
30: R\$ 35,68 45: R\$ 36,39 60: R\$ 37,12



JARDINEIRA ELEGANCE AUTOIRR 01 VINHO IMP

Código: 42166 Fábrica: NUTRIPLAN Unidade: UN/1 F1 F4

UN: R\$ 4,89 AV: R\$ 4,89 15: R\$ 4,99
30: R\$ 5,09 45: R\$ 5,19 60: R\$ 5,29



JARRA PLAST 1,0 LT C/ ESPREM COLOR 4032

Código: 17401 Fábrica: SBRISSA Unidade: UN/1 F1 F4

UN: R\$ 5,87 AV: R\$ 5,87 15: R\$ 5,99
30: R\$ 6,11 45: R\$ 6,23 60: R\$ 6,35



JARRA PLAST 1,0 LT GRAD C/ESP TRANSP4031

Código: 44234 Fábrica: SBRISSA Unidade: UN/1 F1 F4

UN: R\$ 2,11 AV: R\$ 2,11 15: R\$ 2,15
30: R\$ 2,19 45: R\$ 2,24 60: R\$ 2,28



JARRA PLAST 1,0 LT GRADUADA CORES 4010

Código: 17980 Fábrica: SBRISSA Unidade: UN/1 F1 F4

UN: R\$ 4,11 AV: R\$ 4,11 15: R\$ 4,20
30: R\$ 4,28 45: R\$ 4,37 60: R\$ 4,46



JARRA PLAST 1,0 LT GRADUADA TRANSP 4004

Código: 18714 Fábrica: SBRISSA Unidade: UN/1 F1 F4

UN: R\$ 4,01 AV: R\$ 4,01 15: R\$ 4,10
30: R\$ 4,18 45: R\$ 4,26 60: R\$ 4,35



JARRA PLAST 1,0 LT GRADUADA 866 UN
Código: Fábrica: Unidade:
49483 TRITEC UN/1
F1 F4

UN: R\$ 9,19 AV: R\$ 9,19 15: R\$ 9,39
30: R\$ 9,57 45: R\$ 9,77 60: R\$ 9,96



JARRA PLAST 1,5 LT RED C/TPA 6606
Código: Fábrica: Unidade:
11211 INPLAST UN/1
F1 F4

UN: R\$ 10,95 AV: R\$ 10,95 15: R\$ 11,18
30: R\$ 11,40 45: R\$ 11,63 60: R\$ 11,86



JARRA PLAST 1,5 LTS TRANSP 814
Código: Fábrica: Unidade:
35841 LUMAR UN/1
F1 F4

UN: R\$ 8,99 AV: R\$ 8,99 15: R\$ 8,99
30: R\$ 8,99 45: R\$ 8,99 60: R\$ 8,99



JARRA PLAST 2,1 LT QUAD C/TPA 6652
Código: Fábrica: Unidade:
20146 INPLAST UN/1
F1 F4

UN: R\$ 11,32 AV: R\$ 11,32 15: R\$ 11,56
30: R\$ 11,79 45: R\$ 12,02 60: R\$ 12,26

2lts



JARRA PLAST 2,0 LT QD C/TPA 0078
Código: Fábrica: Unidade:
4462 JAGUAR UN/1
F1 F4

UN: R\$ 16,64 AV: R\$ 16,64 15: R\$ 16,98
30: R\$ 17,32 45: R\$ 17,67 60: R\$ 18,02

23cm
2,5lts



JARRA PLAST 2,5 LTS TRANSP TPA COLOR 863
Código: Fábrica: Unidade:
46674 LUMAR UN/1
F1 F4

UN: R\$ 16,64 AV: R\$ 16,64 15: R\$ 16,98
30: R\$ 17,32 45: R\$ 17,67 60: R\$ 18,02



JARRA PLAST 2,5LTS RED NOVELLE 6071
Código: Fábrica: Unidade:
46798 RISCHIOTO UN/1
F1 F4

UN: R\$ 19,39 AV: R\$ 19,39 15: R\$ 19,79
30: R\$ 20,19 45: R\$ 20,59 60: R\$ 21,00

3,3lts



JARRA PLAST 3,3 LTS QUAD C/TPA 0002
Código: Fábrica: Unidade:
18920 JAGUAR UN/1
F1 F4

UN: R\$ 20,97 AV: R\$ 20,97 15: R\$ 21,41
30: R\$ 21,84 45: R\$ 22,28 60: R\$ 22,72

3,7lts



JARRA PLAST 3,7 LTS RED C/TPA 1565
Código: Fábrica: Unidade:
4723 JAGUAR UN/1
F1 F4

UN: R\$ 18,00 AV: R\$ 18,00 15: R\$ 18,37
30: R\$ 18,74 45: R\$ 19,11 60: R\$ 19,50



JARRA PLAST 3,8 LTS AQUARELA C/TPA 6814
Código: Fábrica: Unidade:
41670 INPLAST UN/1
F1 F4

UN: R\$ 18,00 AV: R\$ 18,00 15: R\$ 18,37
30: R\$ 18,74 45: R\$ 19,11 60: R\$ 19,50



JARRA PLAST 3,8 LTS TRANSP C/TPA 6813
Código: Fábrica: Unidade:
41666 INPLAST UN/1
F1 F4

UN: R\$ 22,07 AV: R\$ 22,07 15: R\$ 22,53
30: R\$ 22,98 45: R\$ 23,44 60: R\$ 23,91



JARRA PLAST 4,0 LT TRANSP C/TAMPA 398
Código: Fábrica: Unidade:
33026 TRITEC UN/1
F1 F4

UN: R\$ 15,20 AV: R\$ 15,20 15: R\$ 15,51
30: R\$ 15,82 45: R\$ 16,14 60: R\$ 16,46



JARRA VIDRO 1L P/CANTO GELADEIRA 234
Código: Fábrica: Unidade:
47325 NIX UN/1
F1 F4

UN: R\$ 22,03 AV: R\$ 22,03 15: R\$ 22,49
30: R\$ 22,94 45: R\$ 23,40 60: R\$ 23,87



JARRA VIDRO 1,1 LTS TPA PLAST C/CX 7694
Código: Fábrica: Unidade:
47354 ALTIHOME UN/1
F1 F4

UN: R\$ 22,03 AV: R\$ 22,03 15: R\$ 22,49
30: R\$ 22,94 45: R\$ 23,40 60: R\$ 23,87



JARRA VIDRO 1,1 LTS TPA PLAST C/CX 7695
Código: Fábrica: Unidade:
47356 ALTIHOME UN/1
F1 F4

UN: R\$ 19,99 AV: R\$ 19,99 15: R\$ 19,99
30: R\$ 19,99 45: R\$ 19,99 60: R\$ 19,99



JARRA VIDRO 1,1 LTS TPA PLAST FC019
Código: Fábrica: Unidade:
49439 SATYAM UN/1
F1 F4

UN: R\$ 22,03 AV: R\$ 22,03 15: R\$ 22,49
30: R\$ 22,94 45: R\$ 23,40 60: R\$ 23,87



JARRA VIDRO 1,1 LTS TPA PLAST FC020
Código: Fábrica: Unidade:
49440 SATYAM UN/1
F1 F4

UN: R\$ 22,51 AV: R\$ 22,51 15: R\$ 22,98
30: R\$ 23,44 45: R\$ 23,91 60: R\$ 24,39



JARRA VIDRO 1,1 LTS TRANSP TPA PLAST 016
Código: Fábrica: Unidade:
50805 SATYAM UN/1
F1 F4

UN: R\$ 22,51 AV: R\$ 22,51 15: R\$ 22,98
30: R\$ 23,44 45: R\$ 23,91 60: R\$ 24,39



JARRA VIDRO 1,1 LTS TRANSP TPA PLAST 017
Código: Fábrica: Unidade:
50804 SATYAM UN/1
F1 F4

UN: R\$ 37,20 AV: R\$ 37,20 15: R\$ 37,97
30: R\$ 38,73 45: R\$ 39,51 60: R\$ 40,30



JARRA VIDRO 1,6 LTS C/TPA PLAST 1090
Código: Fábrica: Unidade:
49481 LEHAVI UN/1
F1 F4

UN: R\$ 39,16 AV: R\$ 39,16 15: R\$ 39,97
30: R\$ 40,77 45: R\$ 41,59 60: R\$ 42,42



JARRA VIDRO 1,8 LTS C/TPA PLAST 1091
Código: Fábrica: Unidade:
49482 LEHAVI UN/1
F1 F4

UN: R\$ 28,39 AV: R\$ 28,39 15: R\$ 28,98
30: R\$ 29,56 45: R\$ 30,15 60: R\$ 30,75



JARRA VIDRO 1,8 LTS TRANSP C/TPA ACR 026
Código: Fábrica: Unidade:
50803 PRATIBELLA UN/1
F1 F4

UN: R\$ 46,67 AV: R\$ 46,67 15: R\$ 47,64
30: R\$ 48,59 45: R\$ 49,57 60: R\$ 50,56



JARRA VIDRO 1,8 LTS TRANSP C/TPA ACR 156
Código: Fábrica: Unidade:
49801 FUTURO UN/1
F1 F4

UN: R\$ 46,67 AV: R\$ 46,67 15: R\$ 47,64
30: R\$ 48,59 45: R\$ 49,57 60: R\$ 50,56



JARRA VIDRO 1,8 LTS TRANSP C/TPA ACR 157
Código: Fábrica: Unidade:
49799 FUTURO UN/1
F1 F4

UN: R\$ 7,99 AV: R\$ 7,99 15: R\$ 7,99
30: R\$ 7,99 45: R\$ 7,99 60: R\$ 7,99



JARRA 1,8 LT TRANSP C/TPA 4000
Código: Fábrica: Unidade:
17979 SBRISSA UN/1
F1 F4

UN: R\$ 10,91 AV: R\$ 10,91 15: R\$ 11,14
30: R\$ 11,36 45: R\$ 11,59 60: R\$ 11,82



JARRA 1,8 LT TRANSP DEC C/TPA 8013
Código: Fábrica: Unidade:
35219 SBRISSA UN/1
F1 F4

UN: R\$ 15,98 AV: R\$ 15,98 15: R\$ 16,31
30: R\$ 16,64 45: R\$ 16,97 60: R\$ 17,31



JARRA 1,8 LT TRANSP KIT C/4 COPOS 4041
Código: Fábrica: Unidade:
31277 SBRISSA UN/1
F1 F4

UN: R\$ 1,33 AV: R\$ 66,58 15: R\$ 67,96
30: R\$ 69,32 45: R\$ 70,71 60: R\$ 72,12



JOELHO 1/2 PRETO JO51N 50X1
Código: Fábrica: Unidade:
40153 REBOUCAS PT/50
F1 F4

UN: R\$ 1,34 AV: R\$ 67,17 15: R\$ 68,57
30: R\$ 69,94 45: R\$ 71,34 60: R\$ 72,77



JOELHO 3/4 PRETO JO52N 50X1
Código: Fábrica: Unidade:
40154 REBOUCAS PT/50
F1 F4

UN: R\$ 15,66 AV: R\$ 15,66 15: R\$ 15,98
30: R\$ 16,30 45: R\$ 16,63 60: R\$ 16,96



JOGO CHURRASCO FACA GARFO CB MAD 0091
Código: Fábrica: Unidade:
41748 Q.P.BEST FER CJ/1
F1 F4

UN: R\$ 32,30 AV: R\$ 32,30 15: R\$ 32,98
30: R\$ 33,64 45: R\$ 34,31 60: R\$ 35,00



JOGO CHURRASCO FACA GARFO CB MAD 204
Código: Fábrica: Unidade:
41346 HAUSKRAFT CJ/1
F1 F4

UN: R\$ 19,57 AV: R\$ 19,57 15: R\$ 19,98
30: R\$ 20,38 45: R\$ 20,79 60: R\$ 21,21



JOGO CHURRASCO FACA/CHAIRA CB MAD 0071
Código: Fábrica: Unidade:
41221 TALBERG CJ/1
F1 F4

UN: R\$ 87,15 AV: R\$ 87,15 15: R\$ 88,96
30: R\$ 90,74 45: R\$ 92,56 60: R\$ 94,41



JOGO CHURRASCO FACA/GARF/PEGAD CB MAD 75
Código: Fábrika: Unidade:
40458 TRAMONTINA CJ/1
F1 F4

UN: R\$ 38,68 AV: R\$ 38,68 15: R\$ 39,48
30: R\$ 40,27 45: R\$ 41,08 60: R\$ 41,90



KIT CAIPIRINHA 3CS(COPO/TABUA/AMASSA 681
Código: Fábrika: Unidade:
40392 TRAMONTINA CJ/1
F1 F4

UN: R\$ 17,94 AV: R\$ 17,94 15: R\$ 18,31
30: R\$ 18,68 45: R\$ 19,05 60: R\$ 19,43



KIT COZINHA 3PCS(CAP BOT/CAP LIQ/FOR FOG
Código: Fábrika: Unidade:
38506 FERREIRA UN/1
F1 F4

UN: R\$ 17,92 AV: R\$ 17,92 15: R\$ 18,29
30: R\$ 18,66 45: R\$ 19,03 60: R\$ 19,41



KIT COZINHA 3PCS(CAP BOT/FOGAO/PUX SACO)
Código: Fábrika: Unidade:
11332 FERREIRA UN/1
F1 F4

UN: R\$ 117,49 AV: R\$ 117,49 15: R\$ 119,94
30: R\$ 122,34 45: R\$ 124,79 60: R\$ 127,28



KIT CUIA GDE NUTRICOCO (CORRENT/SUPORTE)
Código: Fábrika: Unidade:
31903 NUTRIPLAN UN/1
F1 F4

UN: R\$ 154,70 AV: R\$ 154,70 15: R\$ 157,93
30: R\$ 161,09 45: R\$ 164,31 60: R\$ 167,59



KIT CUIA GIG NUTRICOCO (CORRENT/SUPORTE)
Código: Fábrika: Unidade:
31904 NUTRIPLAN UN/1
F1 F4

UN: R\$ 18,60 AV: R\$ 18,60 15: R\$ 18,98
30: R\$ 19,36 45: R\$ 19,75 60: R\$ 20,14



KIT CUIA 1 MARROM (PRATO/CORREN/VASO)
Código: Fábrika: Unidade:
18496 NUTRIPLAN UN/1
F1 F4

UN: R\$ 17,62 AV: R\$ 17,62 15: R\$ 17,98
30: R\$ 18,34 45: R\$ 18,71 60: R\$ 19,08



KIT CUIA 1 PRETO (PRATO /CORREN/VASO)
Código: Fábrika: Unidade:
18494 NUTRIPLAN UN/1
F1 F4

UN: R\$ 18,60 AV: R\$ 18,60 15: R\$ 18,99
30: R\$ 19,37 45: R\$ 19,76 60: R\$ 20,15



KIT CUIA 1,5 MARROM (PRATO/CORREN/VASO)
Código: Fábrika: Unidade:
27334 NUTRIPLAN UN/1
F1 F4

UN: R\$ 29,08 AV: R\$ 29,08 15: R\$ 29,69
30: R\$ 30,28 45: R\$ 30,89 60: R\$ 31,51



KIT CUIA 2 MARROM (PRATO/CORREN/VASO)
Código: Fábrika: Unidade:
22283 NUTRIPLAN UN/1
F1 F4

UN: R\$ 25,63 AV: R\$ 25,63 15: R\$ 26,16
30: R\$ 26,68 45: R\$ 27,22 60: R\$ 27,76



KIT CUIA 2 PRETO (PRATO /CORREN/VASO)
Código: Fábrika: Unidade:
22285 NUTRIPLAN UN/1
F1 F4

UN: R\$ 27,91 AV: R\$ 27,91 15: R\$ 28,49
30: R\$ 29,06 45: R\$ 29,64 60: R\$ 30,23



KIT CUIA 3 MARROM (PRATO/CORREN/VASO)
Código: Fábrika: Unidade:
31390 NUTRIPLAN UN/1
F1 F4

UN: R\$ 31,03 AV: R\$ 31,03 15: R\$ 31,68
30: R\$ 32,31 45: R\$ 32,96 60: R\$ 33,62



KIT CUIA 3 PRETO (PRATO/CORREN/VASO)
Código: Fábrika: Unidade:
30307 NUTRIPLAN UN/1
F1 F4

UN: R\$ 6,75 AV: R\$ 6,75 15: R\$ 6,89
30: R\$ 7,03 45: R\$ 7,17 60: R\$ 7,31



KIT INF ESCOLAR PRATO+COLHER+CANECA 5013
Código: Fábrika: Unidade:
41896 SBRISSA CJ/1
F1 F4

UN: R\$ 1,96 AV: R\$ 5,87 15: R\$ 5,99
30: R\$ 6,11 45: R\$ 6,23 60: R\$ 6,35



KIT INOX 3 FACAS HERCULES MUNDIAL
Código: Fábrika: Unidade:
41170 HERCULES CJ/3
F1 F4

UN: R\$ 9,07 AV: R\$ 9,07 15: R\$ 9,26
30: R\$ 9,44 45: R\$ 9,63 60: R\$ 9,82



KIT MERENDA PLAST(PRATO/CUMB/CANECA/COLH
Código: Fábrika: Unidade:
44236 SBRISSA CJ/1
F1 F4

UN: R\$ 7,82 AV: R\$ 7,82 15: R\$ 7,99
30: R\$ 8,15 45: R\$ 8,31 60: R\$ 8,48



KIT MERENDA PLAST(PRATO/CUMB/CANECA/COLH
Código: Fábrica: Unidade:
44235 SBRISSA CJ/1
F1 F4

UN: R\$ 47,49 AV: R\$ 47,49 15: R\$ 48,48
30: R\$ 49,45 45: R\$ 50,44 60: R\$ 51,45



KIT P/BANHEIRO 4 PCS PLAST CORUJA 4054
Código: Fábrica: Unidade:
47314 CASITA CJ/1
F1 F4

UN: R\$ 24,09 AV: R\$ 24,09 15: R\$ 24,59
30: R\$ 25,08 45: R\$ 25,58 60: R\$ 26,10



KIT PIA (LIXEIRA/PA/PORTA DETE) DEC 8020
Código: Fábrica: Unidade:
35224 SBRISSA UN/1
F1 F4

UN: R\$ 20,61 AV: R\$ 20,61 15: R\$ 21,04
30: R\$ 21,46 45: R\$ 21,89 60: R\$ 22,33



KIT PIA (LIXEIRA/PA/PORTA DETE) 8002
Código: Fábrica: Unidade:
34563 SBRISSA UN/1
F1 F4

UN: R\$ 30,35 AV: R\$ 30,35 15: R\$ 30,98
30: R\$ 31,60 45: R\$ 32,23 60: R\$ 32,87



KIT STANDART/TABU MAD C/GARF 20X33CM 57H
Código: Fábrica: Unidade:
41739 DEBIASI UN/1
F1 F4

UN: R\$ 12,68 AV: R\$ 12,68 15: R\$ 12,94
30: R\$ 13,20 45: R\$ 13,47 60: R\$ 13,74



KIT 10 POTES RET 3500/1500/750/350/200ML
Código: Fábrica: Unidade:
34573 PLASTBON CJ/1
F1 F4

UN: R\$ 17,69 AV: R\$ 17,69 15: R\$ 18,06
30: R\$ 18,42 45: R\$ 18,79 60: R\$ 19,17



KIT 2 POTES ORGANIZA QUAD 3L 6332
Código: Fábrica: Unidade:
47050 JAGUAR CJ/1
F1 F4

UN: R\$ 17,48 AV: R\$ 17,48 15: R\$ 17,84
30: R\$ 18,20 45: R\$ 18,56 60: R\$ 18,94



KIT 2 POTES ORGANIZA RED 3L 6331
Código: Fábrica: Unidade:
47049 JAGUAR CJ/1
F1 F4

UN: R\$ 20,22 AV: R\$ 20,22 15: R\$ 20,64
30: R\$ 21,05 45: R\$ 21,48 60: R\$ 21,91



KIT 2 POTES ORGANIZA RET 3,6L 6333
Código: Fábrica: Unidade:
47051 JAGUAR CJ/1
F1 F4

UN: R\$ 12,52 AV: R\$ 12,52 15: R\$ 12,78
30: R\$ 13,04 45: R\$ 13,30 60: R\$ 13,57



KIT 2 POTES RED 4003/02
Código: Fábrica: Unidade:
22916 SBRISSA CJ/1
F1 F4

UN: R\$ 17,10 AV: R\$ 17,10 15: R\$ 17,45
30: R\$ 17,80 45: R\$ 18,16 60: R\$ 18,52



KIT 3 POTES ORGANIZA QUAD 1,2L 6328
Código: Fábrica: Unidade:
47046 JAGUAR CJ/1
F1 F4

UN: R\$ 15,70 AV: R\$ 15,70 15: R\$ 16,02
30: R\$ 16,34 45: R\$ 16,67 60: R\$ 17,00



KIT 3 POTES ORGANIZA RED 1,22L 6330
Código: Fábrica: Unidade:
47048 JAGUAR CJ/1
F1 F4

UN: R\$ 17,09 AV: R\$ 17,09 15: R\$ 17,44
30: R\$ 17,79 45: R\$ 18,15 60: R\$ 18,51



KIT 3 POTES ORGANIZA RET 1,270ML 6329
Código: Fábrica: Unidade:
47047 JAGUAR CJ/1
F1 F4

UN: R\$ 12,04 AV: R\$ 12,04 15: R\$ 12,30
30: R\$ 12,54 45: R\$ 12,79 60: R\$ 13,05



KIT 3 POTES QUAD MED 1200ML 5513
Código: Fábrica: Unidade:
41478 KOZI PLAST UN/1
F1 F4

UN: R\$ 19,57 AV: R\$ 19,57 15: R\$ 19,98
30: R\$ 20,38 45: R\$ 20,79 60: R\$ 21,21



KIT 3 POTES QUAD PMG 380/770/1400ML 7415
Código: Fábrica: Unidade:
22917 RISCHIOTO CJ/1
F1 F4

UN: R\$ 11,30 AV: R\$ 11,30 15: R\$ 11,54
30: R\$ 11,77 45: R\$ 12,00 60: R\$ 12,24



KIT 3 POTES QUAD 230/390/390ML 4128
Código: Fábrica: Unidade:
8270 JAGUAR CJ/1
F1 F4

UN: R\$ 11,30 AV: R\$ 11,30 15: R\$ 11,54
30: R\$ 11,77 45: R\$ 12,00 60: R\$ 12,24



KIT 3 POTES QUAD 230/390/690ML 4129
Código: 9836 Fábrica: JAGUAR Unidade: CJ/1 F1 F4

UN: R\$ 11,30 AV: R\$ 11,30 15: R\$ 11,54
30: R\$ 11,77 45: R\$ 12,00 60: R\$ 12,24



KIT 3 POTES RED 210/370/740ML 4054
Código: 8267 Fábrica: JAGUAR Unidade: CJ/1 F1 F4

UN: R\$ 17,62 AV: R\$ 17,62 15: R\$ 17,98
30: R\$ 18,34 45: R\$ 18,71 60: R\$ 19,08



KIT 3 POTES RED 4003
Código: 30698 Fábrica: SBRISSA Unidade: CJ/1 F1 F4

UN: R\$ 19,49 AV: R\$ 19,49 15: R\$ 19,89
30: R\$ 20,29 45: R\$ 20,70 60: R\$ 21,11



KIT 3 POTES RET PMG 380/740/1200ML 215
Código: 22918 Fábrica: RISCHIOTO Unidade: CJ/1 F1 F4

UN: R\$ 10,77 AV: R\$ 10,77 15: R\$ 11,00
30: R\$ 11,22 45: R\$ 11,44 60: R\$ 11,67



KIT 3 POTES RET 220/420/750ML 4021
Código: 9838 Fábrica: JAGUAR Unidade: CJ/1 F1 F4

UN: R\$ 18,94 AV: R\$ 18,94 15: R\$ 19,33
30: R\$ 19,72 45: R\$ 20,11 60: R\$ 20,52



KIT 4 POTES QUAD 230/390/690/1200ML 4126
Código: 9076 Fábrica: JAGUAR Unidade: CJ/1 F1 F4

UN: R\$ 18,94 AV: R\$ 18,94 15: R\$ 19,33
30: R\$ 19,72 45: R\$ 20,11 60: R\$ 20,52



KIT 4 POTES QUAD 230/390/690/1200ML 4127
Código: 9077 Fábrica: JAGUAR Unidade: CJ/1 F1 F4

UN: R\$ 17,53 AV: R\$ 17,53 15: R\$ 17,89
30: R\$ 18,25 45: R\$ 18,62 60: R\$ 18,99



KIT 4 POTES RED 210/370/740/1220ML 4063
Código: 9835 Fábrica: JAGUAR Unidade: CJ/1 F1 F4

UN: R\$ 17,53 AV: R\$ 17,53 15: R\$ 17,89
30: R\$ 18,25 45: R\$ 18,62 60: R\$ 18,99



KIT 4 POTES RED 210/370/740/1220ML 4064
Código: 9078 Fábrica: JAGUAR Unidade: CJ/1 F1 F4

UN: R\$ 8,49 AV: R\$ 8,49 15: R\$ 8,67
30: R\$ 8,84 45: R\$ 9,02 60: R\$ 9,20

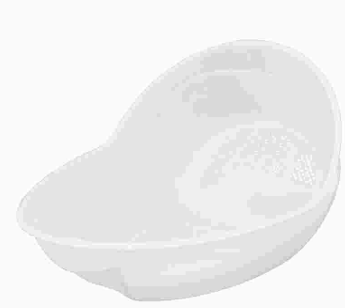

LAVA ARROZ PLAST 0795
Código: 47059 Fábrica: JAGUAR Unidade: UN/1 F1 F4

UN: R\$ 4,16 AV: R\$ 4,16 15: R\$ 4,25
30: R\$ 4,33 45: R\$ 4,42 60: R\$ 4,51



LAVA ARROZ PLAST 5015
Código: 14573 Fábrica: SBRISSA Unidade: UN/1 F1 F4

UN: R\$ 6,12 AV: R\$ 6,12 15: R\$ 6,25
30: R\$ 6,37 45: R\$ 6,50 60: R\$ 6,63



LAVA TUDO PLAST COLOR 5027
Código: 30262 Fábrica: SBRISSA Unidade: UN/1 F1 F4

UN: R\$ 4,89 AV: R\$ 4,89 15: R\$ 4,99
30: R\$ 5,09 45: R\$ 5,19 60: R\$ 5,29



LAVA TUDO PLAST COLOR 674
Código: 18306 Fábrica: ECOPLASTIC Unidade: UN/1 F1 F4

UN: R\$ 29,37 AV: R\$ 29,37 15: R\$ 29,98
30: R\$ 30,58 45: R\$ 31,19 60: R\$ 31,81



LEITEIRA ALUM EXTRA 14 C/TAMPA 1,7LTS
Código: 40290 Fábrica: AVELAR Unidade: UN/1 F1 F4

UN: R\$ 13,27 AV: R\$ 13,27 15: R\$ 13,54
30: R\$ 13,82 45: R\$ 14,09 60: R\$ 14,37



LICOREIRA VIDRO 250ML 19,3CM 22169
Código: 36770 Fábrica: MABEL Unidade: CX/1 F1 F4

UN: R\$ 4,40 AV: R\$ 4,40 15: R\$ 4,49
30: R\$ 4,58 45: R\$ 4,67 60: R\$ 4,76



LIMPA ALUMINIO DULAR 500 ML
Código: 48941 Fábrica: DULAR Unidade: UN/1 F1 F4

UN: R\$ 22,33 AV: R\$ 22,33 15: R\$ 22,79
30: R\$ 23,25 45: R\$ 23,71 60: R\$ 24,19



LIMPA TETO NYLON UN

Código: Fábrica: Unidade:
50868 HALLEY UN/1
F1 F4

UN: R\$ 97,87 AV: R\$ 97,87 15: R\$ 99,91
30: R\$ 101,91 45: R\$ 103,95 60: R\$ 106,03



LIMPADOR MULT 500ML 8X3 AZULIM

Código: Fábrica: Unidade:
48834 AZULIM PT/1
F1 F4

UN: R\$ 84,20 AV: R\$ 84,20 15: R\$ 85,96
30: R\$ 87,67 45: R\$ 89,43 60: R\$ 91,22



LIMPADOR MULTIUSO 5 LTS CONCENTRADO OX2

Código: Fábrica: Unidade:
49516 UP PRO PT/1
F1 F4

UN: R\$ 34,99 AV: R\$ 34,99 15: R\$ 34,99
30: R\$ 34,99 45: R\$ 34,99 60: R\$ 34,99



LIXEIRA C/ PEDAL 15 L ECO 3065

Código: Fábrica: Unidade:
19089 JAGUAR UN/1
F1 F4

1 37cm
2 28cm
3 15lts

UN: R\$ 55,65 AV: R\$ 55,65 15: R\$ 56,81
30: R\$ 57,94 45: R\$ 59,10 60: R\$ 60,28



LIXEIRA CANELADA N 60 56 LTS FECH C/TPA

Código: Fábrica: Unidade:
18340 ANTARES UN/1
F1 F4

UN: R\$ 88,12 AV: R\$ 88,12 15: R\$ 89,95
30: R\$ 91,75 45: R\$ 93,59 60: R\$ 95,46



LIXEIRA CANELADA N100 86 LTS FECH C/TP

Código: Fábrica: Unidade:
22734 ANTARES UN/1
F1 F4

UN: R\$ 193,69 AV: R\$ 193,69 15: R\$ 197,72
30: R\$ 201,68 45: R\$ 205,71 60: R\$ 209,82



LIXEIRA INOX C/PEDAL 20 LTS 7022

Código: Fábrica: Unidade:
47312 CASITA UN/1
F1 F4

1 43cm

UN: R\$ 144,09 AV: R\$ 144,09 15: R\$ 147,09
30: R\$ 150,03 45: R\$ 153,03 60: R\$ 156,09



LIXEIRA INOX 12 LTS 99-004

Código: Fábrica: Unidade:
46893 SATYAM UN/1
F1 F4

1 39cm
2 12lts

UN: R\$ 3,92 AV: R\$ 3,92 15: R\$ 4,00
30: R\$ 4,08 45: R\$ 4,16 60: R\$ 4,24



LIXEIRA PLAST BASC 3 LTS 938

Código: Fábrica: Unidade:
34576 PLASTBON UN/1
F1 F4

UN: R\$ 23,49 AV: R\$ 23,49 15: R\$ 23,98
30: R\$ 24,46 45: R\$ 24,95 60: R\$ 25,45



LIXEIRA PLAST BASC 3LTS DEC BIRDS 1741

Código: Fábrica: Unidade:
37315 MONTE LIBANO UN/1
F1 F4

UN: R\$ 19,57 AV: R\$ 19,57 15: R\$ 19,98
30: R\$ 20,38 45: R\$ 20,79 60: R\$ 21,21



LIXEIRA PLAST BASC 3LTS DEC BLACK B 1743

Código: Fábrica: Unidade:
37317 MONTE LIBANO UN/1
F1 F4

UN: R\$ 23,49 AV: R\$ 23,49 15: R\$ 23,98
30: R\$ 24,46 45: R\$ 24,95 60: R\$ 25,45



LIXEIRA PLAST BASC 3LTS DEC FENDI 1742

Código: Fábrica: Unidade:
37316 MONTE LIBANO UN/1
F1 F4

UN: R\$ 12,72 AV: R\$ 12,72 15: R\$ 12,98
30: R\$ 13,24 45: R\$ 13,51 60: R\$ 13,78



LIXEIRA PLAST BASC 4,8 LTS PRETA

Código: Fábrica: Unidade:
45447 PLASMARC UN/1
F1 F4

UN: R\$ 16,15 AV: R\$ 16,15 15: R\$ 16,48
30: R\$ 16,81 45: R\$ 17,15 60: R\$ 17,49



LIXEIRA PLAST BASC 6,2 LTS 6672

Código: Fábrica: Unidade:
26199 INPLAST UN/1
F1 F4

UN: R\$ 21,05 AV: R\$ 21,05 15: R\$ 21,49
30: R\$ 21,92 45: R\$ 22,36 60: R\$ 22,81



LIXEIRA PLAST BASC 7,5 LTS ECO 3065

Código: Fábrica: Unidade:
3077 JAGUAR UN/1
F1 F4

1 40cm
2 7,5lts

UN: R\$ 32,57 AV: R\$ 32,57 15: R\$ 33,25
30: R\$ 33,91 45: R\$ 34,59 60: R\$ 35,28



LIXEIRA PLAST C/ PEDAL 12 LTS PRETA

Código: Fábrica: Unidade:
34092 SHANGRILA UN/1
F1 F4

1 33cm
2 29cm
3 12lts

UN: R\$ 43,53 AV: R\$ 43,53 15: R\$ 44,43
30: R\$ 45,32 45: R\$ 46,23 60: R\$ 47,15

1 42cm
2 32cm
3 20lts



LIXEIRA PLAST C/ PEDAL 20 LTS ECO 3073
Código: 49170 Fábrica: JAGUAR Unidade: UN/1
F1 F4

UN: R\$ 85,18 AV: R\$ 85,18 15: R\$ 86,96
30: R\$ 88,69 45: R\$ 90,47 60: R\$ 92,28

1 53cm
2 40cm
3 40lts



LIXEIRA PLAST C/ PEDAL 40 LTS ECO 3074
Código: 49171 Fábrica: JAGUAR Unidade: UN/1
F1 F4

UN: R\$ 332,92 AV: R\$ 332,92 15: R\$ 339,85
30: R\$ 346,65 45: R\$ 353,58 60: R\$ 360,66

1 90cm
2 50cm



LIXEIRA PLAST C/PEDAL E RODINHA 120 LTS
Código: 45930 Fábrica: ANTARES Unidade: UN/1
F1 F4

UN: R\$ 48,95 AV: R\$ 48,95 15: R\$ 49,97
30: R\$ 50,97 45: R\$ 51,99 60: R\$ 53,03



LIXEIRA PLAST C/PEDAL LTS DEC COLOR 1557
Código: 41465 Fábrica: MABEL Unidade: UN/1
F1 F4

UN: R\$ 69,52 AV: R\$ 69,52 15: R\$ 70,97
30: R\$ 72,39 45: R\$ 73,84 60: R\$ 75,32



LIXEIRA PLAST C/PEDAL 12 LTS BRANCA 300
Código: 39343 Fábrica: GUARANY Unidade: UN/1
F1 F4

UN: R\$ 32,30 AV: R\$ 32,30 15: R\$ 32,98
30: R\$ 33,64 45: R\$ 34,31 60: R\$ 35,00



LIXEIRA PLAST C/PEDAL 13 LTS 6313
Código: 40984 Fábrica: PLASTIBRASIL Unidade: UN/1
F1 F4

UN: R\$ 37,47 AV: R\$ 37,47 15: R\$ 38,25
30: R\$ 39,02 45: R\$ 39,80 60: R\$ 40,60

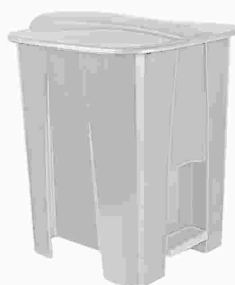

LIXEIRA PLAST C/PEDAL 15 LTS BRANCA 805
Código: 51048 Fábrica: LUMAR Unidade: UN/1
F1 F4

UN: R\$ 47,30 AV: R\$ 47,30 15: R\$ 48,28
30: R\$ 49,25 45: R\$ 50,23 60: R\$ 51,24



LIXEIRA PLAST C/PEDAL 15 LTS PRETO 383
Código: 44424 Fábrica: USUAL Unidade: UN/1
F1 F4

UN: R\$ 375,30 AV: R\$ 375,30 15: R\$ 383,12
30: R\$ 390,78 45: R\$ 398,59 60: R\$ 406,57



LIXEIRA PLAST C/PEDAL 15 LTS PRETO 808
Código: 51049 Fábrica: LUMAR Unidade: UN/1
F1 F4

UN: R\$ 97,91 AV: R\$ 97,91 15: R\$ 99,95
30: R\$ 101,95 45: R\$ 103,99 60: R\$ 106,07

1 67cm
2 39cm



LIXEIRA PLAST C/PEDAL 60 LTS BRANCA
Código: 45929 Fábrica: ANTARES Unidade: UN/1
F1 F4

UN: R\$ 92,17 AV: R\$ 92,17 15: R\$ 94,09
30: R\$ 95,97 45: R\$ 97,89 60: R\$ 99,85

1 67cm
2 39cm



LIXEIRA PLAST C/PEDAL 60 LTS PRETA
Código: 48663 Fábrica: ANTARES Unidade: UN/1
F1 F4

UN: R\$ 30,35 AV: R\$ 30,35 15: R\$ 30,98
30: R\$ 31,60 45: R\$ 32,23 60: R\$ 32,87



LIXEIRA PLAST C/PEDAL 7,0 LTS 281
Código: 45443 Fábrica: TRITEC Unidade: UN/1
F1 F4

UN: R\$ 13,70 AV: R\$ 13,70 15: R\$ 13,98
30: R\$ 14,26 45: R\$ 14,55 60: R\$ 14,84

1 25 cm
2 25 cm



LIXEIRA PLAST C/PEDAL 7,5 LTS RED PRETA
Código: 45446 Fábrica: PLASMARC Unidade: UN/1
F1 F4

UN: R\$ 3,28 AV: R\$ 3,28 15: R\$ 3,35
30: R\$ 3,42 45: R\$ 3,48 60: R\$ 3,55



LIXEIRA PLAST C/TAMPA LTS 921
Código: 34577 Fábrica: PLASTBON Unidade: UN/1
F1 F4

UN: R\$ 12,72 AV: R\$ 12,72 15: R\$ 12,98
30: R\$ 13,24 45: R\$ 13,51 60: R\$ 13,78



LIXEIRA PLAST C/TAMPA 6 LTS PRETO 112
Código: 50004 Fábrica: PLASMARC Unidade: UN/1
F1 F4

UN: R\$ 12,90 AV: R\$ 12,90 15: R\$ 13,16
30: R\$ 13,43 45: R\$ 13,70 60: R\$ 13,97

1 36cm
2 5,5lts



LIXEIRA PLAST C/TPA 5,5 LTS 3067
Código: 492 Fábrica: JAGUAR Unidade: UN/1
F1 F4

UN: R\$ 4,40 AV: R\$ 4,40 15: R\$ 4,49
30: R\$ 4,58 45: R\$ 4,67 60: R\$ 4,76
13,5 cm



LIXEIRA PLAST DE MESA 13.5CM 57010
Código: 38423 Fábrica: ALMEGA Unidade: UN/1
F1 F4

UN: R\$ 52,87 AV: R\$ 52,87 15: R\$ 53,97
30: R\$ 55,05 45: R\$ 56,15 60: R\$ 57,27



LIXEIRA PLAST PEDAL 7LT RATTAN PRET 1987
Código: 38377 Fábrica: MONTE LIBANO Unidade: UN/1
F1 F4

UN: R\$ 14,39 AV: R\$ 14,39 15: R\$ 14,69
30: R\$ 14,99 45: R\$ 15,29 60: R\$ 15,59



LIXEIRA PLAST 13 LTS PRETA
Código: 28677 Fábrica: ECOPLASTIC Unidade: UN/1
F1 F4

UN: R\$ 9,59 AV: R\$ 9,59 15: R\$ 9,79
30: R\$ 9,98 45: R\$ 10,18 60: R\$ 10,39



LIXEIRA PLAST 2 LTS BASIC P/PIA 4001
Código: 13891 Fábrica: SBRISSA Unidade: UN/1
F1 F4

UN: R\$ 8,80 AV: R\$ 8,80 15: R\$ 8,99
30: R\$ 9,17 45: R\$ 9,35 60: R\$ 9,54



LIXEIRA PLAST 2,5 LTS P/PIA 7010
Código: 31285 Fábrica: SBRISSA Unidade: UN/1
F1 F4

UN: R\$ 11,02 AV: R\$ 11,02 15: R\$ 11,25
30: R\$ 11,47 45: R\$ 11,70 60: R\$ 11,93
26cm
8cm
3,2lts



LIXEIRA PLAST 3,2 LTS BASIC 6650
Código: 20157 Fábrica: INPLAST Unidade: UN/1
F1 F4

UN: R\$ 31,95 AV: R\$ 31,95 15: R\$ 32,62
30: R\$ 33,27 45: R\$ 33,93 60: R\$ 34,61



MACARICO PORTATIL PROF 17X6CM 1853
Código: 50956 Fábrica: HAI BRASIL Unidade: UN/1
F1 F4

UN: R\$ 15,66 AV: R\$ 15,66 15: R\$ 15,98
30: R\$ 16,30 45: R\$ 16,63 60: R\$ 16,96



MANGUEIRA GAS 1,00M MANTAC 100
Código: 47883 Fábrica: MANTAC Unidade: UN/1
F1 F4

UN: R\$ 21,53 AV: R\$ 21,53 15: R\$ 21,98
30: R\$ 22,42 45: R\$ 22,87 60: R\$ 23,33



MANGUEIRA GAS 1,25M C/2 ABRACADEIRAS 500
Código: 47884 Fábrica: VINIGAS Unidade: UN/1
F1 F4

UN: R\$ 67,56 AV: R\$ 67,56 15: R\$ 68,96
30: R\$ 70,34 45: R\$ 71,75 60: R\$ 73,18



MANGUEIRA JD 10M ESG REG CAM DUPLA AZUL
Código: 18512 Fábrica: NUTRIPLAN Unidade: UN/1
F1 F4

UN: R\$ 40,79 AV: R\$ 40,79 15: R\$ 41,64
30: R\$ 42,48 45: R\$ 43,33 60: R\$ 44,19



MANGUEIRA JD 10MTS TRANC CRISTAL 14017
Código: 48828 Fábrica: ARQUA Unidade: UN/1
F1 F4

UN: R\$ 39,91 AV: R\$ 39,91 15: R\$ 40,74
30: R\$ 41,56 45: R\$ 42,39 60: R\$ 43,24



MANGUEIRA JD 10MTS TRANC FLEX VERD 14007
Código: 48830 Fábrica: ARQUA Unidade: UN/1
F1 F4

UN: R\$ 50,71 AV: R\$ 50,71 15: R\$ 51,77
30: R\$ 52,80 45: R\$ 53,86 60: R\$ 54,94



MANGUEIRA JD 15MTS POP VERDE 14002
Código: 48826 Fábrica: ARQUA Unidade: UN/1
F1 F4

UN: R\$ 59,08 AV: R\$ 59,08 15: R\$ 60,31
30: R\$ 61,51 45: R\$ 62,74 60: R\$ 64,00



MANGUEIRA JD 15MTS TRANC CRISTAL 14018
Código: 48831 Fábrica: ARQUA Unidade: UN/1
F1 F4

UN: R\$ 57,91 AV: R\$ 57,91 15: R\$ 59,12
30: R\$ 60,30 45: R\$ 61,50 60: R\$ 62,73



MANGUEIRA JD 15MTS TRANC FLEX VERD 14008
Código: 48827 Fábrica: ARQUA Unidade: UN/1
F1 F4

UN: R\$ 67,00 AV: R\$ 67,00 15: R\$ 68,39
30: R\$ 69,76 45: R\$ 71,16 60: R\$ 72,58



MANGUEIRA JD 20MTS POP VERDE 14003
Código: 48825 Fábrica: ARQUA Unidade: UN/1
F1 F4

UN: R\$ 77,15 AV: R\$ 77,15 15: R\$ 78,76
30: R\$ 80,33 45: R\$ 81,94 60: R\$ 83,58



MANGUEIRA JD 20MTS TRANC CRISTAL 14019
Código: Fábrica: Unidade:
48832 ARQUA UN/1
F1 F4

UN: R\$ 71,14 AV: R\$ 71,14 15: R\$ 72,62
30: R\$ 74,07 45: R\$ 75,55 60: R\$ 77,07



MANGUEIRA JD 20MTS TRANC FLEX COLOR 158
Código: Fábrica: Unidade:
40231 MONTEREY UN/1
F1 F4

UN: R\$ 76,15 AV: R\$ 76,15 15: R\$ 77,74
30: R\$ 79,29 45: R\$ 80,88 60: R\$ 82,50



MANGUEIRA JD 20MTS TRANC FLEX VERD 14009
Código: Fábrica: Unidade:
48833 ARQUA UN/1
F1 F4

UN: R\$ 159,60 AV: R\$ 159,60 15: R\$ 162,92
30: R\$ 166,18 45: R\$ 169,51 60: R\$ 172,90



MANGUEIRA JD 30M ESG REG CAM DUPLA AZUL
Código: Fábrica: Unidade:
27119 NUTRIPLAN UN/1
F1 F4

UN: R\$ 98,32 AV: R\$ 98,32 15: R\$ 100,37
30: R\$ 102,38 45: R\$ 104,42 60: R\$ 106,51



MANGUEIRA JD 30MTS POP VERDE 14030
Código: Fábrica: Unidade:
48824 ARQUA UN/1
F1 F4

UN: R\$ 106,63 AV: R\$ 106,63 15: R\$ 108,85
30: R\$ 111,02 45: R\$ 113,24 60: R\$ 115,51



MANGUEIRA JD 30MTS TRANC FLEX COLOR 160
Código: Fábrica: Unidade:
34405 MONTEREY UN/1
F1 F4

UN: R\$ 112,95 AV: R\$ 112,95 15: R\$ 115,30
30: R\$ 117,61 45: R\$ 119,96 60: R\$ 122,36



MANGUEIRA JD 30MTS TRANC FLEX VERD 14011
Código: Fábrica: Unidade:
48823 ARQUA UN/1
F1 F4

UN: R\$ 8,31 AV: R\$ 8,31 15: R\$ 8,49
30: R\$ 8,66 45: R\$ 8,83 60: R\$ 9,01



MARMITA ALUM REDONDA 10 686
Código: Fábrica: Unidade:
12305 MSR UN/1
F1 F4

UN: R\$ 10,09 AV: R\$ 10,09 15: R\$ 10,30
30: R\$ 10,50 45: R\$ 10,71 60: R\$ 10,93



MARMITA ALUM REDONDA 12 687
Código: Fábrica: Unidade:
10431 MSR UN/1
F1 F4

UN: R\$ 15,66 AV: R\$ 15,66 15: R\$ 15,98
30: R\$ 16,30 45: R\$ 16,63 60: R\$ 16,96



MARMITA ALUM REDONDA 14 688
Código: Fábrica: Unidade:
24365 MSR UN/1
F1 F4

UN: R\$ 16,64 AV: R\$ 16,64 15: R\$ 16,98
30: R\$ 17,32 45: R\$ 17,67 60: R\$ 18,02



MARMITA ALUM REDONDA 16 689
Código: Fábrica: Unidade:
22729 MSR UN/1
F1 F4

UN: R\$ 19,57 AV: R\$ 19,57 15: R\$ 19,98
30: R\$ 20,38 45: R\$ 20,79 60: R\$ 21,21



MARMITA ALUM REDONDA 18 690
Código: Fábrica: Unidade:
14610 MSR UN/1
F1 F4

UN: R\$ 8,91 AV: R\$ 8,91 15: R\$ 9,10
30: R\$ 9,28 45: R\$ 9,46 60: R\$ 9,65



MARMITA PLAST INF 2 DIV C/COLHER 8345
Código: Fábrica: Unidade:
26086 SATYAM UN/1
F1 F4

UN: R\$ 10,76 AV: R\$ 10,76 15: R\$ 10,99
30: R\$ 11,21 45: R\$ 11,43 60: R\$ 11,66



MARMITA PLAST 1 LT C/TRAVA VALVULA 256
Código: Fábrica: Unidade:
44436 USUAL UN/1
F1 F4

UN: R\$ 29,99 AV: R\$ 29,99 15: R\$ 29,99
30: R\$ 29,99 45: R\$ 29,99 60: R\$ 29,99



MARMITA TERMICA ALUM RED 14 692
Código: Fábrica: Unidade:
19605 MSR UN/1
F1 F4

UN: R\$ 34,26 AV: R\$ 34,26 15: R\$ 34,98
30: R\$ 35,68 45: R\$ 36,39 60: R\$ 37,12



MARMITA TERMICA ALUM RED 16 C/BOLSA 694
Código: Fábrica: Unidade:
26822 MSR UN/1
F1 F4

UN: R\$ 29,99 AV: R\$ 29,99 15: R\$ 29,99
30: R\$ 29,99 45: R\$ 29,99 60: R\$ 29,99



MARMITA TERMICA ALUM RED 16 693

Código: 2218 Fábrica: MSR Unidade: UN/1
F1 F4

UN: R\$ 27,99 AV: R\$ 27,99 15: R\$ 27,99
30: R\$ 27,99 45: R\$ 27,99 60: R\$ 27,99



MARMITA TERMICA ALUM RET 16

Código: 2219 Fábrica: MSR/DF Unidade: UN/1
F1 F4

UN: R\$ 0,51 AV: R\$ 50,92 15: R\$ 51,98
30: R\$ 53,02 45: R\$ 54,08 60: R\$ 55,16



MARMITEX ISOPOR C/TAMPA 500 ML 100X1

Código: 50421 Fábrica: ULTRA Unidade: PT/100
F1 F4

UN: R\$ 12,24 AV: R\$ 12,24 15: R\$ 12,50
30: R\$ 12,74 45: R\$ 13,00 60: R\$ 13,26



MARTELO ALUM INTEIRICO 2006 UN

Código: 48023 Fábrica: COFAX Unidade: UN/1
F1 F4

UN: R\$ 6,54 AV: R\$ 6,54 15: R\$ 6,68
30: R\$ 6,81 45: R\$ 6,95 60: R\$ 7,09



MARTELO ALUM 19CM CB MAD 2021 UN

Código: 48021 Fábrica: COFAX Unidade: UN/1
F1 F4

UN: R\$ 32,22 AV: R\$ 32,22 15: R\$ 32,89
30: R\$ 33,54 45: R\$ 34,22 60: R\$ 34,90



MASSAGEADOR ROSTO E LIMPEZA FACIAL RECAR

Código: 35624 Fábrica: FOREVER Unidade: CX/1
F1 F4

UN: R\$ 1,00 AV: R\$ 2,01 15: R\$ 2,05
30: R\$ 2,09 45: R\$ 2,13 60: R\$ 2,17



MATA MOSCA PLAST 48CM CB MADEIRA 264 UN

Código: 45440 Fábrica: TRITEC Unidade: PT/2
F1 F4

UN: R\$ 52,87 AV: R\$ 52,87 15: R\$ 53,97
30: R\$ 55,05 45: R\$ 56,15 60: R\$ 57,27



MESA INFANTIL AZUL

Código: 22789 Fábrica: ANTARES Unidade: UN/1
F1 F4

UN: R\$ 137,08 AV: R\$ 137,08 15: R\$ 139,93
30: R\$ 142,73 45: R\$ 145,59 60: R\$ 148,50



MESA INFANTIL DOBRAVEL AZUL

Código: 28513 Fábrica: ANTARES Unidade: UN/1
F1 F4

UN: R\$ 137,08 AV: R\$ 137,08 15: R\$ 139,93
30: R\$ 142,73 45: R\$ 145,59 60: R\$ 148,50



MESA INFANTIL DOBRAVEL ROSA

Código: 28512 Fábrica: ANTARES Unidade: UN/1
F1 F4

UN: R\$ 52,87 AV: R\$ 52,87 15: R\$ 53,97
30: R\$ 55,05 45: R\$ 56,15 60: R\$ 57,27



MESA INFANTIL ROSA

Código: 23042 Fábrica: ANTARES Unidade: UN/1
F1 F4

UN: R\$ 249,70 AV: R\$ 249,70 15: R\$ 254,90
30: R\$ 260,00 45: R\$ 265,20 60: R\$ 270,50



MESA MADEIRA C/ 2 BANQUETAS STELL

Código: 35641 Fábrica: AMOF Unidade: UN/1
F1 F4

UN: R\$ 112,60 AV: R\$ 112,60 15: R\$ 114,94
30: R\$ 117,24 45: R\$ 119,59 60: R\$ 121,98



MESA MONOBLOCO BEGE

Código: 23044 Fábrica: ANTARES Unidade: UN/1
F1 F4

UN: R\$ 131,20 AV: R\$ 131,20 15: R\$ 133,94
30: R\$ 136,62 45: R\$ 139,35 60: R\$ 142,13



MESA MONOBLOCO BRANCA

Código: 22589 Fábrica: ANTARES Unidade: UN/1
F1 F4

UN: R\$ 117,49 AV: R\$ 117,49 15: R\$ 119,94
30: R\$ 122,34 45: R\$ 124,79 60: R\$ 127,28



MESA MONOBLOCO OURO PRETO PRETA

Código: 44669 Fábrica: ANTARES Unidade: UN/1
F1 F4

UN: R\$ 117,49 AV: R\$ 117,49 15: R\$ 119,94
30: R\$ 122,34 45: R\$ 124,79 60: R\$ 127,28



MESA MONOBLOCO VINHO

Código: 22591 Fábrica: ANTARES Unidade: UN/1
F1 F4

UN: R\$ 186,04 AV: R\$ 186,04 15: R\$ 189,91
30: R\$ 193,71 45: R\$ 197,59 60: R\$ 201,54



MESA PLASTICA RED BEGE DESMONTAVEL

Código: Fábrica: Unidade:
20001 ANTARES UN/1
F1 F4

UN: R\$ 186,04 AV: R\$ 186,04 15: R\$ 189,91
30: R\$ 193,71 45: R\$ 197,59 60: R\$ 201,54



MESA PLASTICA RED BRANCA DESMONTAVEL

Código: Fábrica: Unidade:
20002 ANTARES UN/1
F1 F4

UN: R\$ 5,87 AV: R\$ 5,87 15: R\$ 5,99
30: R\$ 6,11 45: R\$ 6,23 60: R\$ 6,35



MIX PERLITA CARVAO CASCA DE ARROZ 1 LITR

Código: Fábrica: Unidade:
48529 NOVATROPICAL PT/1
F1 F4

UN: R\$ 78,33 AV: R\$ 78,33 15: R\$ 79,96
30: R\$ 81,56 45: R\$ 83,19 60: R\$ 84,85



MOP FLAT C/1 REFIL 474

Código: Fábrica: Unidade:
41263 123UTIL UN/1
F1 F4

UN: R\$ 7,28 AV: R\$ 7,28 15: R\$ 7,43
30: R\$ 7,58 45: R\$ 7,73 60: R\$ 7,88



26cm
1,2lts

MORINGA PLAST 1,2 LTS COLOR 817

Código: Fábrica: Unidade:
35842 LUMAR UN/1
F1 F4

UN: R\$ 6,84 AV: R\$ 6,84 15: R\$ 6,99
30: R\$ 7,13 45: R\$ 7,27 60: R\$ 7,41



MUSGO SPHAGNUM 1 LITRO

Código: Fábrica: Unidade:
48535 NOVATROPICAL PT/1
F1 F4

UN: R\$ 7,10 AV: R\$ 7,10 15: R\$ 7,25
30: R\$ 7,39 45: R\$ 7,54 60: R\$ 7,69



MUSGO VERDE 50 GRS 1 LITRO

Código: Fábrica: Unidade:
34750 NOVATROPICAL PT/1
F1 F4

UN: R\$ 12,59 AV: R\$ 12,59 15: R\$ 12,85
30: R\$ 13,11 45: R\$ 13,37 60: R\$ 13,64



NHOQUEIRA ALUM INTERICO 22CM 2015 UN

Código: Fábrica: Unidade:
48025 COFAX UN/1
F1 F4

UN: R\$ 7,78 AV: R\$ 7,78 15: R\$ 7,95
30: R\$ 8,11 45: R\$ 8,27 60: R\$ 8,43



ORGANIZADOR MOD RATTAN 10X7X11CM BABY942

Código: Fábrica: Unidade:
38393 MONTE LIBANO UN/1
F1 F4

UN: R\$ 7,78 AV: R\$ 7,78 15: R\$ 7,95
30: R\$ 8,11 45: R\$ 8,27 60: R\$ 8,43



ORGANIZADOR MOD RATTAN 10X7X11CM BCO 940

Código: Fábrica: Unidade:
38391 MONTE LIBANO UN/1
F1 F4

UN: R\$ 7,78 AV: R\$ 7,78 15: R\$ 7,95
30: R\$ 8,11 45: R\$ 8,27 60: R\$ 8,43



ORGANIZADOR MOD RATTAN 10X7X11CM TEND943

Código: Fábrica: Unidade:
38394 MONTE LIBANO UN/1
F1 F4

UN: R\$ 12,63 AV: R\$ 12,63 15: R\$ 12,89
30: R\$ 13,15 45: R\$ 13,42 60: R\$ 13,68



ORGANIZADOR MOD RATTAN 15X10X11CM BAB962

Código: Fábrica: Unidade:
38397 MONTE LIBANO UN/1
F1 F4

UN: R\$ 12,63 AV: R\$ 12,63 15: R\$ 12,89
30: R\$ 13,15 45: R\$ 13,42 60: R\$ 13,68



ORGANIZADOR MOD RATTAN 15X10X11CM BCO960

Código: Fábrica: Unidade:
38395 MONTE LIBANO UN/1
F1 F4

UN: R\$ 12,63 AV: R\$ 12,63 15: R\$ 12,89
30: R\$ 13,15 45: R\$ 13,42 60: R\$ 13,68



ORGANIZADOR MOD RATTAN 15X10X11CM PTO961

Código: Fábrica: Unidade:
38396 MONTE LIBANO UN/1
F1 F4

UN: R\$ 12,63 AV: R\$ 12,63 15: R\$ 12,89
30: R\$ 13,15 45: R\$ 13,42 60: R\$ 13,68

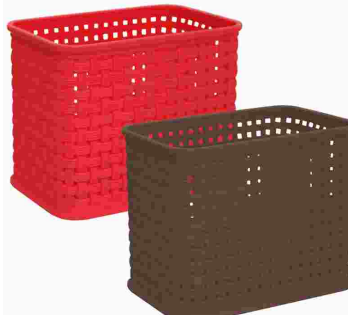

ORGANIZADOR MOD RATTAN 15X10X11CM TEN963

Código: Fábrica: Unidade:
38398 MONTE LIBANO UN/1
F1 F4

UN: R\$ 8,80 AV: R\$ 8,80 15: R\$ 8,99
30: R\$ 9,17 45: R\$ 9,35 60: R\$ 9,54

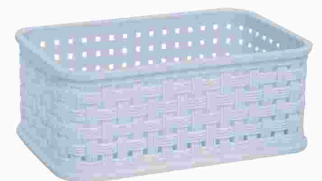

ORGANIZADOR MOD RATTAN 15X10X6CM BABY932

Código: Fábrica: Unidade:
38402 MONTE LIBANO UN/1
F1 F4

UN: R\$ 8,80 AV: R\$ 8,80 15: R\$ 8,99
30: R\$ 9,17 45: R\$ 9,35 60: R\$ 9,54

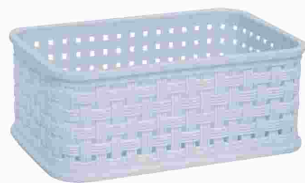

ORGANIZADOR MOD RATTAN 15X10X6CM BCO 930
Código: 38388 Fábrica: MONTE LIBANO Unidade: UN/1
F1 F4

UN: R\$ 8,80 AV: R\$ 8,80 15: R\$ 8,99
30: R\$ 9,17 45: R\$ 9,35 60: R\$ 9,54

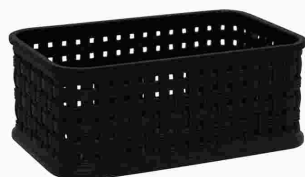

ORGANIZADOR MOD RATTAN 15X10X6CM PTO 931
Código: 38389 Fábrica: MONTE LIBANO Unidade: UN/1
F1 F4

UN: R\$ 8,80 AV: R\$ 8,80 15: R\$ 8,99
30: R\$ 9,17 45: R\$ 9,35 60: R\$ 9,54



ORGANIZADOR MOD RATTAN 15X10X6CM TEND933
Código: 38390 Fábrica: MONTE LIBANO Unidade: UN/1
F1 F4

UN: R\$ 15,13 AV: R\$ 15,13 15: R\$ 15,44
30: R\$ 15,75 45: R\$ 16,07 60: R\$ 16,39



ORGANIZADOR MOD RATTAN 20X15X6CM 970
Código: 38384 Fábrica: MONTE LIBANO Unidade: UN/1
F1 F4

UN: R\$ 12,62 AV: R\$ 12,62 15: R\$ 12,88
30: R\$ 13,14 45: R\$ 13,41 60: R\$ 13,67

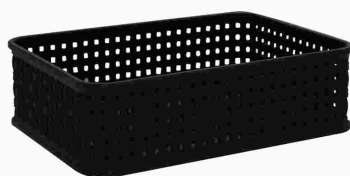

ORGANIZADOR MOD RATTAN 20X15X6CM PTO 971
Código: 38386 Fábrica: MONTE LIBANO Unidade: UN/1
F1 F4

UN: R\$ 17,13 AV: R\$ 17,13 15: R\$ 17,48
30: R\$ 17,83 45: R\$ 18,19 60: R\$ 18,55



ORGANIZADOR MOD RATTAN 30X10X6CM BABY952
Código: 38382 Fábrica: MONTE LIBANO Unidade: UN/1
F1 F4

UN: R\$ 17,13 AV: R\$ 17,13 15: R\$ 17,48
30: R\$ 17,83 45: R\$ 18,19 60: R\$ 18,55

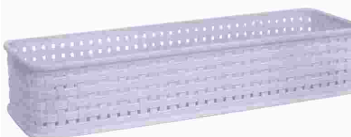

ORGANIZADOR MOD RATTAN 30X10X6CM BCO 950
Código: 38380 Fábrica: MONTE LIBANO Unidade: UN/1
F1 F4

UN: R\$ 17,13 AV: R\$ 17,13 15: R\$ 17,48
30: R\$ 17,83 45: R\$ 18,19 60: R\$ 18,55



ORGANIZADOR MOD RATTAN 30X10X6CM TEND953
Código: 38381 Fábrica: MONTE LIBANO Unidade: UN/1
F1 F4

UN: R\$ 16,77 AV: R\$ 16,77 15: R\$ 17,12
30: R\$ 17,47 45: R\$ 17,81 60: R\$ 18,17



ORGANIZADOR PLAST C/DIV 23X14,8X4CM 2015
Código: 37313 Fábrica: MONTE LIBANO Unidade: UN/1
F1 F4

UN: R\$ 21,49 AV: R\$ 21,49 15: R\$ 21,94
30: R\$ 22,38 45: R\$ 22,83 60: R\$ 23,28



ORGANIZADOR PLAST C/DIV 28X18X4,5CM 2020
Código: 37312 Fábrica: MONTE LIBANO Unidade: UN/1
F1 F4

UN: R\$ 35,25 AV: R\$ 35,25 15: R\$ 35,99
30: R\$ 36,71 45: R\$ 37,44 60: R\$ 38,19



ORGANIZADOR PLAST C/DIV 37X28,5X7CM 2025
Código: 38376 Fábrica: MONTE LIBANO Unidade: UN/1
F1 F4

UN: R\$ 7,64 AV: R\$ 7,64 15: R\$ 7,80
30: R\$ 7,95 45: R\$ 8,11 60: R\$ 8,27



ORGANIZADORA PLAST RED 5,5 LTS BCA 952
Código: 34581 Fábrica: PLASTBON Unidade: UN/1
F1 F4

UN: R\$ 7,98 AV: R\$ 7,98 15: R\$ 8,15
30: R\$ 8,31 45: R\$ 8,48 60: R\$ 8,65



ORGANIZADORA PLAST RED 5,5 LTS COLOR1088
Código: 34584 Fábrica: PLASTBON Unidade: UN/1
F1 F4

UN: R\$ 11,70 AV: R\$ 11,70 15: R\$ 11,95
30: R\$ 12,18 45: R\$ 12,43 60: R\$ 12,68



PA LIXO METAL CB MADEIRA 60CM
Código: 17510 Fábrica: HALLE Unidade: UN/1
F1 F4

UN: R\$ 13,22 AV: R\$ 13,22 15: R\$ 13,49
30: R\$ 13,76 45: R\$ 14,04 60: R\$ 14,32

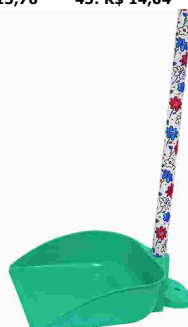

PA LIXO PLAST C/CABO MAD LONGO 033
Código: 33514 Fábrica: BENEDETTI Unidade: UN/1
F1 F4

UN: R\$ 8,80 AV: R\$ 8,80 15: R\$ 8,99
30: R\$ 9,17 45: R\$ 9,35 60: R\$ 9,54



PA LIXO PLAST C/CABO PEQ COLOR PLUS 3051
Código: 49812 Fábrica: HALLEY Unidade: UN/1
F1 F4

UN: R\$ 6,84 AV: R\$ 6,84 15: R\$ 6,99
30: R\$ 7,13 45: R\$ 7,27 60: R\$ 7,41



PA LIXO PLAST C/CABO PEQ PRETA 2497
Código: Fábrica: Unidade:
49813 EDS UN/1
F1 F4

UN: R\$ 3,28 AV: R\$ 3,28 15: R\$ 3,35
30: R\$ 3,42 45: R\$ 3,48 60: R\$ 3,55



PA LIXO PLAST COLOR 28CM 09
Código: Fábrica: Unidade:
44084 QUALYPLAS UN/1
F1 F4

UN: R\$ 3,62 AV: R\$ 3,62 15: R\$ 3,70
30: R\$ 3,77 45: R\$ 3,85 60: R\$ 3,92
F1 28cm



PA LIXO PLAST CORES
Código: Fábrica: Unidade:
12902 ANTARES UN/1
F1 F4

UN: R\$ 3,79 AV: R\$ 3,79 15: R\$ 3,87
30: R\$ 3,95 45: R\$ 4,02 60: R\$ 4,11
F1 28cm



PA LIXO PLAST PRETA
Código: Fábrica: Unidade:
34093 SHANGRILA UN/1
F1 F4

UN: R\$ 7,78 AV: R\$ 7,78 15: R\$ 7,95
30: R\$ 8,11 45: R\$ 8,27 60: R\$ 8,43



PA LIXO PLAST TABACO
Código: Fábrica: Unidade:
40779 NUTRIPLAN UN/1
F1 F4

UN: R\$ 2,69 AV: R\$ 2,69 15: R\$ 2,75
30: R\$ 2,80 45: R\$ 2,86 60: R\$ 2,92



PA LIXO PLAST 032
Código: Fábrica: Unidade:
23995 BENEDETTI UN/1
F1 F4

UN: R\$ 5,63 AV: R\$ 5,63 15: R\$ 5,75
30: R\$ 5,86 45: R\$ 5,98 60: R\$ 6,10
F1 28cm



PA LIXO PLAST 0698
Código: Fábrica: Unidade:
47067 JAGUAR UN/1
F1 F4

UN: R\$ 3,81 AV: R\$ 3,81 15: R\$ 3,89
30: R\$ 3,97 45: R\$ 4,05 60: R\$ 4,13



PA LIXO PLAST 2466
Código: Fábrica: Unidade:
49809 EDS UN/1
F1 F4

UN: R\$ 5,22 AV: R\$ 5,22 15: R\$ 5,33
30: R\$ 5,43 45: R\$ 5,54 60: R\$ 5,65



PA LIXO PLAST 7003
Código: Fábrica: Unidade:
14585 SBRISSA UN/1
F1 F4

UN: R\$ 5,87 AV: R\$ 5,87 15: R\$ 5,99
30: R\$ 6,11 45: R\$ 6,23 60: R\$ 6,35



PA MADEIRA 30 CM (ESPATULA) 012
Código: Fábrica: Unidade:
41318 MAD LAR UN/1
F1 F4

UN: R\$ 6,16 AV: R\$ 6,16 15: R\$ 6,29
30: R\$ 6,41 45: R\$ 6,54 60: R\$ 6,67



PA MADEIRA 38 CM (ESPATULA) 014
Código: Fábrica: Unidade:
41317 MAD LAR UN/1
F1 F4

UN: R\$ 4,11 AV: R\$ 4,11 15: R\$ 4,20
30: R\$ 4,28 45: R\$ 4,37 60: R\$ 4,46



PA MADEIRA 38 CM 110
Código: Fábrica: Unidade:
35827 CSD UN/1
F1 F4

UN: R\$ 72,36 AV: R\$ 72,36 15: R\$ 73,87
30: R\$ 75,35 45: R\$ 76,85 60: R\$ 78,39



PANELA ALUM BATIDO 16 CB MADEIRA 1511
Código: Fábrica: Unidade:
45371 MSR UN/1
F1 F4

UN: R\$ 78,33 AV: R\$ 78,33 15: R\$ 79,96
30: R\$ 81,56 45: R\$ 83,19 60: R\$ 84,85



PANELA ALUM BATIDO 18 CB INTEIRICO 1551
Código: Fábrica: Unidade:
45376 MSR UN/1
F1 F4

UN: R\$ 78,33 AV: R\$ 78,33 15: R\$ 79,96
30: R\$ 81,56 45: R\$ 83,19 60: R\$ 84,85



PANELA ALUM BATIDO 18 CB MADEIRA 1512
Código: Fábrica: Unidade:
45370 MSR UN/1
F1 F4

UN: R\$ 94,35 AV: R\$ 94,35 15: R\$ 96,31
30: R\$ 98,24 45: R\$ 100,20 60: R\$ 102,21



PANELA ALUM BATIDO 20 CB INTEIRICO 1554
Código: Fábrica: Unidade:
45375 MSR UN/1
F1 F4

UN: R\$ 94,35 AV: R\$ 94,35 15: R\$ 96,31
30: R\$ 98,24 45: R\$ 100,20 60: R\$ 102,21



PANELA ALUM BATIDO 20 CB MADEIRA 1513
Código: Fábrika: Unidade:
45369 MSR UN/1
F1 F4

UN: R\$ 111,97 AV: R\$ 111,97 15: R\$ 114,30
30: R\$ 116,59 45: R\$ 118,92 60: R\$ 121,30



PANELA ALUM BATIDO 22 CB INTEIRICO 1552
Código: Fábrika: Unidade:
45374 MSR UN/1
F1 F4

UN: R\$ 137,08 AV: R\$ 137,08 15: R\$ 139,93
30: R\$ 142,73 45: R\$ 145,59 60: R\$ 148,50



PANELA ALUM BATIDO 24 CB INTEIRICO 1553
Código: Fábrika: Unidade:
45373 MSR UN/1
F1 F4

UN: R\$ 210,13 AV: R\$ 210,13 15: R\$ 214,50
30: R\$ 218,79 45: R\$ 223,17 60: R\$ 227,63



PANELA ALUM BATIDO 28 CB MADEIRA 1517
Código: Fábrika: Unidade:
45368 MSR UN/1
F1 F4

UN: R\$ 226,73 AV: R\$ 226,73 15: R\$ 231,46
30: R\$ 236,09 45: R\$ 240,81 60: R\$ 245,62



PANELA ALUM BATIDO 30 CB INTEIRICO 1576
Código: Fábrika: Unidade:
45372 MSR UN/1
F1 F4

UN: R\$ 24,47 AV: R\$ 24,47 15: R\$ 24,98
30: R\$ 25,48 45: R\$ 25,99 60: R\$ 26,51



PANELA ALUM EXTRA 14 CB MADEIRA 697
Código: Fábrika: Unidade:
24373 MSR UN/1
F1 F4

UN: R\$ 31,32 AV: R\$ 31,32 15: R\$ 31,98
30: R\$ 32,62 45: R\$ 33,27 60: R\$ 33,93



PANELA ALUM EXTRA 16 CB MADEIRA 698
Código: Fábrika: Unidade:
24374 MSR UN/1
F1 F4

UN: R\$ 35,24 AV: R\$ 35,24 15: R\$ 35,98
30: R\$ 36,70 45: R\$ 37,43 60: R\$ 38,18



PANELA ALUM EXTRA 18 CB MADEIRA 699
Código: Fábrika: Unidade:
24375 MSR UN/1
F1 F4

UN: R\$ 39,16 AV: R\$ 39,16 15: R\$ 39,97
30: R\$ 40,77 45: R\$ 41,59 60: R\$ 42,42



PANELA ALUM EXTRA 20 CB MADEIRA 700/701
Código: Fábrika: Unidade:
24376 MSR UN/1
F1 F4

UN: R\$ 44,05 AV: R\$ 44,05 15: R\$ 44,97
30: R\$ 45,87 45: R\$ 46,79 60: R\$ 47,72



PANELA ALUM EXTRA 22 CB MADEIRA 701
Código: Fábrika: Unidade:
24377 MSR UN/1
F1 F4

UN: R\$ 51,89 AV: R\$ 51,89 15: R\$ 52,97
30: R\$ 54,03 45: R\$ 55,11 60: R\$ 56,21



PANELA ALUM EXTRA 24 CB MADEIRA 702
Código: Fábrika: Unidade:
24378 MSR UN/1
F1 F4

UN: R\$ 24,47 AV: R\$ 24,47 15: R\$ 24,98
30: R\$ 25,48 45: R\$ 25,99 60: R\$ 26,51



PANELA ALUM LEVE 14 C/TAMPA
Código: Fábrika: Unidade:
5884 AVELAR UN/1
F1 F4

UN: R\$ 24,47 AV: R\$ 24,47 15: R\$ 24,98
30: R\$ 25,48 45: R\$ 25,99 60: R\$ 26,51



PANELA ALUM LEVE 16 C/TAMPA
Código: Fábrika: Unidade:
5885 AVELAR UN/1
F1 F4

UN: R\$ 24,47 AV: R\$ 24,47 15: R\$ 24,98
30: R\$ 25,48 45: R\$ 25,99 60: R\$ 26,51



PANELA ALUM LEVE 18 S/TAMPA
Código: Fábrika: Unidade:
5886 AVELAR UN/1
F1 F4

UN: R\$ 24,47 AV: R\$ 24,47 15: R\$ 24,98
30: R\$ 25,48 45: R\$ 25,99 60: R\$ 26,51



PANELA ALUM LEVE 20 S/TAMPA
Código: Fábrika: Unidade:
5887 AVELAR UN/1
F1 F4

UN: R\$ 28,39 AV: R\$ 28,39 15: R\$ 28,98
30: R\$ 29,56 45: R\$ 30,15 60: R\$ 30,75



PANELA ALUM LUXO 14 CB BAQUELITE 703
Código: Fábrika: Unidade:
25302 MSR UN/1
F1 F4

UN: R\$ 33,21 AV: R\$ 33,21 15: R\$ 33,91
30: R\$ 34,58 45: R\$ 35,28 60: R\$ 35,98



PANELA ALUM LUXO 16 CB BAQUELITE 704
Código: Fábrica: Unidade:
25306 MSR UN/1
F1 F4

UN: R\$ 37,20 AV: R\$ 37,20 15: R\$ 37,97
30: R\$ 38,73 45: R\$ 39,51 60: R\$ 40,30



PANELA ALUM LUXO 18 CB BAQUELITE 705
Código: Fábrica: Unidade:
25307 MSR UN/1
F1 F4

UN: R\$ 41,12 AV: R\$ 41,12 15: R\$ 41,97
30: R\$ 42,81 45: R\$ 43,67 60: R\$ 44,54



PANELA ALUM LUXO 20 CB BAQUELITE 706
Código: Fábrica: Unidade:
25303 MSR UN/1
F1 F4

UN: R\$ 45,03 AV: R\$ 45,03 15: R\$ 45,97
30: R\$ 46,89 45: R\$ 47,83 60: R\$ 48,79



PANELA ALUM LUXO 22 CB BAQUELITE 707
Código: Fábrica: Unidade:
25304 MSR UN/1
F1 F4

UN: R\$ 173,29 AV: R\$ 173,29 15: R\$ 176,90
30: R\$ 180,44 45: R\$ 184,05 60: R\$ 187,73



PANELA PRESSAO 7,0 LTS POLIDA ALUMINE
Código: Fábrica: Unidade:
48116 ALEGRETE UN/1
F1 F4

UN: R\$ 213,44 AV: R\$ 213,44 15: R\$ 217,88
30: R\$ 222,24 45: R\$ 226,69 60: R\$ 231,22



PANELA PRESSAO 10,0 LTS POLIDA ALUMINE
Código: Fábrica: Unidade:
48120 ALEGRETE UN/1
F1 F4

UN: R\$ 4,89 AV: R\$ 4,89 15: R\$ 4,99
30: R\$ 5,09 45: R\$ 5,19 60: R\$ 5,29



PANO CHAO SACO ALG ALVEJ COMBATE 38X58CM
Código: Fábrica: Unidade:
49840 TEXTIL UN/1
F1 F4

UN: R\$ 5,87 AV: R\$ 5,87 15: R\$ 5,99
30: R\$ 6,11 45: R\$ 6,23 60: R\$ 6,35



PANO CHAO SACO ALG ALVEJ M 43X63CM
Código: Fábrica: Unidade:
49831 TEXTIL UN/1
F1 F4

UN: R\$ 3,91 AV: R\$ 3,91 15: R\$ 3,99
30: R\$ 4,07 45: R\$ 4,15 60: R\$ 4,23



PANO CHAO SACO ALG ALVEJ PP 30X55CM
Código: Fábrica: Unidade:
50090 TEXTIL UN/1
F1 F4

UN: R\$ 6,84 AV: R\$ 6,84 15: R\$ 6,99
30: R\$ 7,13 45: R\$ 7,27 60: R\$ 7,41



PANO CHAO SACO ALG ALVEJ TRAD 43X68CM
Código: Fábrica: Unidade:
49839 TEXTIL UN/1
F1 F4

UN: R\$ 7,63 AV: R\$ 7,63 15: R\$ 7,79
30: R\$ 7,94 45: R\$ 8,10 60: R\$ 8,26



PANO CHAO SACO ALG XADREZ M 43X68CM
Código: Fábrica: Unidade:
48794 TEXTIL UN/1
F1 F4

UN: R\$ 9,78 AV: R\$ 9,78 15: R\$ 9,99
30: R\$ 10,19 45: R\$ 10,39 60: R\$ 10,60



PANO CHAO SACO ALG XADREZ SG 78X53CM
Código: Fábrica: Unidade:
20249 TEXTIL UN/1
F1 F4

UN: R\$ 7,82 AV: R\$ 7,82 15: R\$ 7,99
30: R\$ 8,15 45: R\$ 8,31 60: R\$ 8,48



PANO CHAO SACO CRU ECOPLUS 48X85CM
Código: Fábrica: Unidade:
47137 TEXTIL/ENCOP UN/1
F1 F4

UN: R\$ 2,61 AV: R\$ 7,82 15: R\$ 7,99
30: R\$ 8,15 45: R\$ 8,31 60: R\$ 8,48



PANO MULTIUSO MICROFIBRA 30X30CM 010 3X1
Código: Fábrica: Unidade:
49394 RIOHOME PT/3
F1 F4

UN: R\$ 0,70 AV: R\$ 3,52 15: R\$ 3,59
30: R\$ 3,66 45: R\$ 3,73 60: R\$ 3,81



PANO MULTIUSO 30X50CM AZUL 5X1
Código: Fábrica: Unidade:
48716 NOBRE PT/5
F1 F4

UN: R\$ 5,42 AV: R\$ 5,42 15: R\$ 5,54
30: R\$ 5,65 45: R\$ 5,76 60: R\$ 5,88



PANO PRATO ALGODAO LISO RUBI 65X40CM
Código: Fábrica: Unidade:
49795 ENGOMATEXTIL UN/1
F1 F4

UN: R\$ 5,95 AV: R\$ 5,95 15: R\$ 5,95
30: R\$ 5,95 45: R\$ 5,95 60: R\$ 5,95



PANO PRATO LISO EXTRA 100% ALGO 72X45CM
Código: Fábrica: Unidade:
48813 ENGOMATEX UN/1
F1 F4

UN: R\$ 2,94 AV: R\$ 29,37 15: R\$ 29,98
30: R\$ 30,58 45: R\$ 31,19 60: R\$ 31,81



PANO PRATO LISO RUBI 65X40CM 114 10X1
Código: Fábrica: Unidade:
39380 ENGOMATEXIL PT/10
F1 F4

UN: R\$ 11,74 AV: R\$ 11,74 15: R\$ 11,99
30: R\$ 12,22 45: R\$ 12,47 60: R\$ 12,72



PAPEIRO ALUM LEVE 16 708
Código: Fábrica: Unidade:
20734 MSR UN/1
F1 F4

UN: R\$ 7,59 AV: R\$ 7,59 15: R\$ 7,75
30: R\$ 7,90 45: R\$ 8,06 60: R\$ 8,22

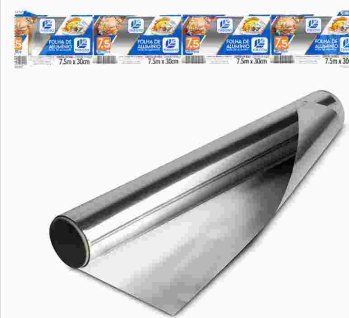

PAPEL ALUMINIO 7,5MTSX30CM 19935
Código: Fábrica: Unidade:
47844 THEOTO/MELLO RL/1
F1 F4

UN: R\$ 5,09 AV: R\$ 5,09 15: R\$ 5,20
30: R\$ 5,30 45: R\$ 5,41 60: R\$ 5,52



PAPEL MANTEIGA 28CMX4M 21754
Código: Fábrica: Unidade:
50076 BOMPACK RL/1
F1 F4

UN: R\$ 6,84 AV: R\$ 6,84 15: R\$ 6,99
30: R\$ 7,13 45: R\$ 7,27 60: R\$ 7,41



PAPEL MANTEIGA 28CMX7,5M
Código: Fábrica: Unidade:
48695 BOMPACK RL/1
F1 F4

UN: R\$ 3,91 AV: R\$ 7,82 15: R\$ 7,99
30: R\$ 8,15 45: R\$ 8,31 60: R\$ 8,48



PAPEL TOALHA 20X22CM BCO FOLHA DUPLA 2X1
Código: Fábrica: Unidade:
47980 NOBRE SENSE PT/2
F1 F4

UN: R\$ 6,84 AV: R\$ 6,84 15: R\$ 6,99
30: R\$ 7,13 45: R\$ 7,27 60: R\$ 7,41

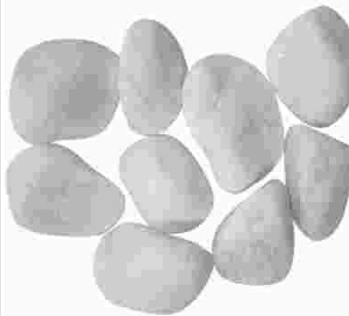

PEDRA DOLOMITA BRANCO 3 1 KG
Código: Fábrica: Unidade:
22888 NOVATROPICAL PT/1
F1 F4

UN: R\$ 48,95 AV: R\$ 48,95 15: R\$ 49,97
30: R\$ 50,97 45: R\$ 51,99 60: R\$ 53,03



PEDRA SEIXO MARMORE 15 KG N0
Código: Fábrica: Unidade:
34647 NOVATROPICAL PT/1
F1 F4

UN: R\$ 48,95 AV: R\$ 48,95 15: R\$ 49,97
30: R\$ 50,97 45: R\$ 51,99 60: R\$ 53,03



PEDRA SEIXO MARMORE 15 KG N1
Código: Fábrica: Unidade:
33905 NOVATROPICAL PT/1
F1 F4

UN: R\$ 48,95 AV: R\$ 48,95 15: R\$ 49,97
30: R\$ 50,97 45: R\$ 51,99 60: R\$ 53,03



PEDRA SEIXO MARMORE 15 KG N2
Código: Fábrica: Unidade:
33430 NOVATROPICAL PT/1
F1 F4

UN: R\$ 48,95 AV: R\$ 48,95 15: R\$ 49,97
30: R\$ 50,97 45: R\$ 51,99 60: R\$ 53,03



PEDRA SEIXO MARMORE 15 KG N3
Código: Fábrica: Unidade:
33235 NOVATROPICAL PT/1
F1 F4

UN: R\$ 39,16 AV: R\$ 39,16 15: R\$ 39,97
30: R\$ 40,77 45: R\$ 41,59 60: R\$ 42,42



PEGADOR INOX CHURRASCO 38CM CAB MAD 2038
Código: Fábrica: Unidade:
41347 HAUSKRAFT UN/1
F1 F4

UN: R\$ 9,78 AV: R\$ 9,78 15: R\$ 9,99
30: R\$ 10,19 45: R\$ 10,39 60: R\$ 10,60



PEGADOR INOX MASSAS 29CM ITALIA CTL 800
Código: Fábrica: Unidade:
47990 PLANETA CR/1
F1 F4

UN: R\$ 21,52 AV: R\$ 21,52 15: R\$ 21,97
30: R\$ 22,41 45: R\$ 22,86 60: R\$ 23,32



PEGADOR INOX MULTUSO 28CM PE60
Código: Fábrica: Unidade:
46582 HERCULES UN/1
F1 F4

UN: R\$ 1,81 AV: R\$ 1,81 15: R\$ 1,85
30: R\$ 1,89 45: R\$ 1,92 60: R\$ 1,96



PEGADOR MACARRAO NYLON REF 503
Código: Fábrica: Unidade:
10988 PLASUTIL UN/1
F1 F4

UN: R\$ 2,18 AV: R\$ 4,36 15: R\$ 4,45
30: R\$ 4,54 45: R\$ 4,63 60: R\$ 4,72

14 cm

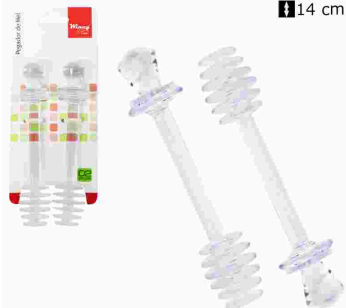

PEGADOR MEL ACRILICO 14CM 2X1 CTL 3170
Código: Fábrika: Unidade:
44725 WINCY CJ/2
F1 F4

UN: R\$ 0,98 AV: R\$ 3,91 15: R\$ 3,99
30: R\$ 4,07 45: R\$ 4,15 60: R\$ 4,23

15 cm



PEGADOR MEL MADEIRA 15CM 6027 4X1
Código: Fábrika: Unidade:
44726 WINCY CJ/4
F1 F4

UN: R\$ 2,79 AV: R\$ 2,79 15: R\$ 2,85
30: R\$ 2,91 45: R\$ 2,96 60: R\$ 3,02



PEGADOR PLAST MACARRAO COLOR 5024
Código: Fábrika: Unidade:
31281 SBRISSA UN/1
F1 F4

UN: R\$ 13,70 AV: R\$ 13,70 15: R\$ 13,98
30: R\$ 14,26 45: R\$ 14,55 60: R\$ 14,84

14 cm



PENEIRA ACO INOX 14CM 003
Código: Fábrika: Unidade:
41353 HAUSKRAFT UN/1
F1 F4

UN: R\$ 8,80 AV: R\$ 8,80 15: R\$ 8,99
30: R\$ 9,17 45: R\$ 9,35 60: R\$ 9,54



PENEIRA ACO INOX 16 CM DUPLA CAMADA 345
Código: Fábrika: Unidade:
44507 PLANETA UN/1
F1 F4

UN: R\$ 10,76 AV: R\$ 10,76 15: R\$ 10,99
30: R\$ 11,21 45: R\$ 11,43 60: R\$ 11,66



PENEIRA ACO INOX 18 CM DUPLA CAMADA 346
Código: Fábrika: Unidade:
44506 PLANETA UN/1
F1 F4

UN: R\$ 2,24 AV: R\$ 2,24 15: R\$ 2,29
30: R\$ 2,33 45: R\$ 2,38 60: R\$ 2,43



PENEIRA PLAST C/CABO 07 CM 661
Código: Fábrika: Unidade:
35494 TRITEC UN/1
F1 F4

UN: R\$ 2,93 AV: R\$ 2,93 15: R\$ 2,99
30: R\$ 3,05 45: R\$ 3,11 60: R\$ 3,17



PENEIRA PLAST C/CABO 10 CM 660
Código: Fábrika: Unidade:
35495 TRITEC UN/1
F1 F4

UN: R\$ 7,53 AV: R\$ 45,20 15: R\$ 46,14
30: R\$ 47,06 45: R\$ 48,01 60: R\$ 48,97



PENEIRA PLAST C/CABO 18 CM 3182 6X1
Código: Fábrika: Unidade:
37691 MAMITA PT/6
F1 F4

UN: R\$ 8,92 AV: R\$ 8,92 15: R\$ 9,11
30: R\$ 9,29 45: R\$ 9,47 60: R\$ 9,66



PENEIRA PLAST C/CABO 28 CM 659
Código: Fábrika: Unidade:
35496 TRITEC UN/1
F1 F4

UN: R\$ 54,95 AV: R\$ 54,95 15: R\$ 56,10
30: R\$ 57,22 45: R\$ 58,36 60: R\$ 59,53



PENEIRA PLAST C/FUNIL COLOR 3024 6X1
Código: Fábrika: Unidade:
41894 SBRISSA PT/1
F1 F4

UN: R\$ 4,06 AV: R\$ 4,06 15: R\$ 4,15
30: R\$ 4,23 45: R\$ 4,32 60: R\$ 4,40



PENEIRA PLAST DE NYLON 8 CM 677
Código: Fábrika: Unidade:
48664 PLANETA UN/1
F1 F4

UN: R\$ 3,26 AV: R\$ 39,16 15: R\$ 39,97
30: R\$ 40,77 45: R\$ 41,59 60: R\$ 42,42



PENEIRA PLASTICA 16 CM 3011 12X1
Código: Fábrika: Unidade:
11022 SBRISSA PT/12
F1 F4

UN: R\$ 4,65 AV: R\$ 55,80 15: R\$ 56,97
30: R\$ 58,11 45: R\$ 59,27 60: R\$ 60,45



PENEIRA PLASTICA 20 CM 3012 12X1
Código: Fábrika: Unidade:
2940 SBRISSA PT/12
F1 F4

UN: R\$ 7,82 AV: R\$ 7,82 15: R\$ 7,99
30: R\$ 8,15 45: R\$ 8,31 60: R\$ 8,48



PERLITA EXPANDIDA 1 LITRO
Código: Fábrika: Unidade:
48530 NOVATROPICAL PT/1
F1 F4

UN: R\$ 6,73 AV: R\$ 67,32 15: R\$ 68,72
30: R\$ 70,10 45: R\$ 71,50 60: R\$ 72,93



PESO UNIV PANELA PRESS CROMADO 3002 10X1
Código: Fábrika: Unidade:
19368 PINOLAR PT/10
F1 F4

UN: R\$ 4,50 AV: R\$ 45,04 15: R\$ 45,98
30: R\$ 46,90 45: R\$ 47,84 60: R\$ 48,80



PESO UNIV PANELA PRESS ENCAPAD 4001 10X1
Código: Fábrika: Unidade:
40032 PINOLAR PT/10
F1 F4

UN: R\$ 5,41 AV: R\$ 27,07 15: R\$ 27,64
30: R\$ 28,19 45: R\$ 28,76 60: R\$ 29,33



PESO UNIV PANELA PRESS ENCAPAD 4001 5X1
Código: Fábrika: Unidade:
34633 PINOLAR PT/5
F1 F4

UN: R\$ 14,19 AV: R\$ 14,19 15: R\$ 14,48
30: R\$ 14,77 45: R\$ 15,07 60: R\$ 15,37



PILAO ALUM INTEIRICO ALHO GDE 2032 UN
Código: Fábrika: Unidade:
46852 COFAX UN/1
F1 F4

UN: R\$ 10,23 AV: R\$ 10,23 15: R\$ 10,45
30: R\$ 10,65 45: R\$ 10,87 60: R\$ 11,09



PILAO ALUM INTEIRICO ALHO PEQ 2012 UN
Código: Fábrika: Unidade:
48076 COFAX UN/1
F1 F4

UN: R\$ 9,78 AV: R\$ 9,78 15: R\$ 9,99
30: R\$ 10,19 45: R\$ 10,39 60: R\$ 10,60



PILAO MAD 08 CM C/SOCADOR 101
Código: Fábrika: Unidade:
41324 MAD LAR UN/1
F1 F4

UN: R\$ 7,00 AV: R\$ 7,00 15: R\$ 7,15
30: R\$ 7,29 45: R\$ 7,44 60: R\$ 7,58



PILAO PLASTICO 8,5X17CM 1059/1070
Código: Fábrika: Unidade:
20927 ENGIPLAST UN/1
F1 F4

UN: R\$ 12,53 AV: R\$ 12,53 15: R\$ 12,79
30: R\$ 13,05 45: R\$ 13,31 60: R\$ 13,58



PINCEL COZINHA COLOR SILICONE 24CM 16058
Código: Fábrika: Unidade:
26125 ALIANCA UN/1
F1 F4

UN: R\$ 46,01 AV: R\$ 46,01 15: R\$ 46,97
30: R\$ 47,91 45: R\$ 48,87 60: R\$ 49,85



PIPOQUEIRA ALUM 20 709
Código: Fábrika: Unidade:
22731 MSR UN/1
F1 F4

UN: R\$ 4,49 AV: R\$ 4,49 15: R\$ 4,59
30: R\$ 4,68 45: R\$ 4,77 60: R\$ 4,87



PLAFON PLAST C/SOQUETE PORCELANA BCO E27
Código: Fábrika: Unidade:
48603 REBOUCAS UN/1
F1 F4

UN: R\$ 6,92 AV: R\$ 6,92 15: R\$ 7,07
30: R\$ 7,21 45: R\$ 7,35 60: R\$ 7,50



PLAINA INOX 25CM P/QUEIJOS 065
Código: Fábrika: Unidade:
47332 NIX UN/1
F1 F4

UN: R\$ 7,82 AV: R\$ 7,82 15: R\$ 7,99
30: R\$ 8,15 45: R\$ 8,31 60: R\$ 8,48



PO DE CARVAO VEGETAL 1 LITRO
Código: Fábrika: Unidade:
48528 NOVATROPICAL PT/1
F1 F4

UN: R\$ 7,82 AV: R\$ 7,82 15: R\$ 7,99
30: R\$ 8,15 45: R\$ 8,31 60: R\$ 8,48



PO DE COCO 1 LITRO
Código: Fábrika: Unidade:
48532 NOVATROPICAL PT/1
F1 F4

UN: R\$ 7,82 AV: R\$ 7,82 15: R\$ 7,99
30: R\$ 8,15 45: R\$ 8,31 60: R\$ 8,48



PO DE PINUS 1 LITRO
Código: Fábrika: Unidade:
48531 NOVATROPICAL PT/1
F1 F4

UN: R\$ 50,92 AV: R\$ 50,92 15: R\$ 51,98
30: R\$ 53,02 45: R\$ 54,08 60: R\$ 55,16
154 cm



POLVILHADEIRA MATA FORMIGA CAP 1KG
Código: Fábrika: Unidade:
38650 GUARANY UN/1
F1 F4

UN: R\$ 4,89 AV: R\$ 4,89 15: R\$ 4,99
30: R\$ 5,09 45: R\$ 5,19 60: R\$ 5,29



PORTA CHA MDF 10X10CM 470
Código: Fábrika: Unidade:
45985 R A ARTESANA UN/1
F1 F4

UN: R\$ 29,37 AV: R\$ 29,37 15: R\$ 29,98
30: R\$ 30,58 45: R\$ 31,19 60: R\$ 31,81



PORTA CHAVE DE FERRO 5062
Código: Fábrika: Unidade:
42171 PAIOL UN/1
F1 F4

UN: R\$ 2,67 AV: R\$ 2,67 15: R\$ 2,73
30: R\$ 2,78 45: R\$ 2,84 60: R\$ 2,90



PORTA COND PLAST COLORAU 499
Código: Fábrika: Unidade:
46644 QUALYPLAS UN/1
F1 F4

UN: R\$ 2,67 AV: R\$ 2,67 15: R\$ 2,73
30: R\$ 2,78 45: R\$ 2,84 60: R\$ 2,90



PORTA COND PLAST OREGANO 416
Código: Fábrika: Unidade:
46645 QUALYPLAS UN/1
F1 F4

UN: R\$ 2,67 AV: R\$ 2,67 15: R\$ 2,73
30: R\$ 2,78 45: R\$ 2,84 60: R\$ 2,90



PORTA COND PLAST PIMENTA DO REINO 418
Código: Fábrika: Unidade:
46648 QUALYPLAS UN/1
F1 F4

UN: R\$ 2,67 AV: R\$ 2,67 15: R\$ 2,73
30: R\$ 2,78 45: R\$ 2,84 60: R\$ 2,90



PORTA COND PLAST PIMENTA 417
Código: Fábrika: Unidade:
46647 QUALYPLAS UN/1
F1 F4

UN: R\$ 2,67 AV: R\$ 2,67 15: R\$ 2,73
30: R\$ 2,78 45: R\$ 2,84 60: R\$ 2,90



PORTA COND PLAST SAL419
Código: Fábrika: Unidade:
46646 QUALYPLAS UN/1
F1 F4

UN: R\$ 10,50 AV: R\$ 10,50 15: R\$ 10,72
30: R\$ 10,93 45: R\$ 11,15 60: R\$ 11,37



PORTA CONDIMENTO VIDRO 100ML 008 2X1
Código: Fábrika: Unidade:
49375 RIOHOME UN/1
F1 F4

UN: R\$ 19,57 AV: R\$ 19,57 15: R\$ 19,98
30: R\$ 20,38 45: R\$ 20,79 60: R\$ 21,21



PORTA COPOS MDF PEQ FLAMENGO 10688 6X1
Código: Fábrika: Unidade:
41151 BRASFOOT UN/1
F1 F4

UN: R\$ 7,82 AV: R\$ 7,82 15: R\$ 7,99
30: R\$ 8,15 45: R\$ 8,31 60: R\$ 8,48



PORTA COTONETE/ALGODAO PLAST 10CM 2638
Código: Fábrika: Unidade:
41554 PLASUTIL UN/1
F1 F4

UN: R\$ 16,97 AV: R\$ 16,97 15: R\$ 17,32
30: R\$ 17,67 45: R\$ 18,02 60: R\$ 18,38



PORTA DETERGENTE BUCHA 550 ML DISPEN 976
Código: Fábrika: Unidade:
46671 LUMAR UN/1
F1 F4

UN: R\$ 22,51 AV: R\$ 22,51 15: R\$ 22,98
30: R\$ 23,44 45: R\$ 23,91 60: R\$ 24,39



PORTA DETERGENTE E BUCHA RATTAN BCO 1970
Código: Fábrika: Unidade:
37292 MONTE LIBANO UN/1
F1 F4

UN: R\$ 21,00 AV: R\$ 21,00 15: R\$ 21,44
30: R\$ 21,87 45: R\$ 22,31 60: R\$ 22,75



PORTA DETERGENTE E BUCHA RATTAN BCO 920
Código: Fábrika: Unidade:
38399 MONTE LIBANO UN/1
F1 F4

UN: R\$ 22,51 AV: R\$ 22,51 15: R\$ 22,98
30: R\$ 23,44 45: R\$ 23,91 60: R\$ 24,39



PORTA DETERGENTE E BUCHA RATTAN PTO 1971
Código: Fábrika: Unidade:
37291 MONTE LIBANO UN/1
F1 F4

UN: R\$ 21,00 AV: R\$ 21,00 15: R\$ 21,44
30: R\$ 21,87 45: R\$ 22,31 60: R\$ 22,75



PORTA DETERGENTE E BUCHA RATTAN PTO 921
Código: Fábrika: Unidade:
38400 MONTE LIBANO UN/1
F1 F4

UN: R\$ 21,00 AV: R\$ 21,00 15: R\$ 21,44
30: R\$ 21,87 45: R\$ 22,31 60: R\$ 22,75



PORTA DETERGENTE E BUCHA RATTAN TEND 923
Código: Fábrika: Unidade:
38401 MONTE LIBANO UN/1
F1 F4

UN: R\$ 3,43 AV: R\$ 3,43 15: R\$ 3,50
30: R\$ 3,57 45: R\$ 3,64 60: R\$ 3,71



PORTA DETERGENTE SABAO ESPONJA 5028
Código: Fábrika: Unidade:
10403 SBRISSA UN/1
F1 F4

UN: R\$ 2,54 AV: R\$ 2,54 15: R\$ 2,59
30: R\$ 2,64 45: R\$ 2,69 60: R\$ 2,75



PORTA DETERGENTE SABAO PLAST 180CM 84
Código: Fábrika: Unidade:
44087 QUALYPLAS UN/1
F1 F4

UN: R\$ 8,49 AV: R\$ 8,49 15: R\$ 8,67
30: R\$ 8,84 45: R\$ 9,02 60: R\$ 9,20



PORTA ESCOVA DENTES PLAST 1616

Código: 47065 Fábrica: JAGUAR Unidade: UN/1 F1 F4

21cm

UN: R\$ 2,91 AV: R\$ 2,91 15: R\$ 2,97
30: R\$ 3,03 45: R\$ 3,09 60: R\$ 3,15



PORTA ESCOVA PLAST 20CM COLOR 669

Código: 44086 Fábrica: QUALYPLAS Unidade: UN/1 F1 F4

UN: R\$ 18,07 AV: R\$ 18,07 15: R\$ 18,44
30: R\$ 18,81 45: R\$ 19,19 60: R\$ 19,57



PORTA ESCOVAS DENTE C/TAMPA 980

Código: 46672 Fábrica: LUMAR Unidade: UN/1 F1 F4

UN: R\$ 5,67 AV: R\$ 5,67 15: R\$ 5,79
30: R\$ 5,90 45: R\$ 6,02 60: R\$ 6,14



PORTA FILTRO PLAST UN 5025

Código: 31282 Fábrica: SBRISSA Unidade: UN/1 F1 F4

UN: R\$ 21,90 AV: R\$ 21,90 15: R\$ 22,36
30: R\$ 22,81 45: R\$ 23,26 60: R\$ 23,73

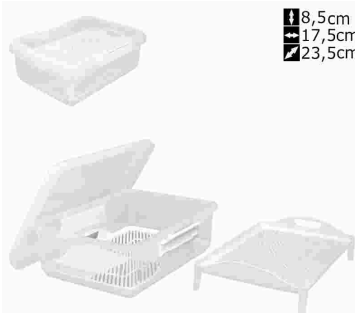

8,5cm
17,5cm
23,5cm

PORTA FRIO PLAST 2 LTS C/TRAV TRANSL 393

Código: 44437 Fábrica: USUAL Unidade: UN/1 F1 F4

UN: R\$ 21,54 AV: R\$ 21,54 15: R\$ 21,99
30: R\$ 22,43 45: R\$ 22,88 60: R\$ 23,34



PORTA GUARDANAPO INOX 13X5,5X9CM 180225

Código: 39222 Fábrica: SATYAM Unidade: UN/1 F1 F4

UN: R\$ 11,95 AV: R\$ 11,95 15: R\$ 12,20
30: R\$ 12,44 45: R\$ 12,69 60: R\$ 12,94



PORTA GUARDANAPO INOX 15X3X6,5CM 110060

Código: 39221 Fábrica: SATYAM Unidade: UN/1 F1 F4

UN: R\$ 4,56 AV: R\$ 4,56 15: R\$ 4,66
30: R\$ 4,75 45: R\$ 4,85 60: R\$ 4,94



PORTA LEITE PLAST SQUIN 16,5X7,5X16,5CM

Código: 20013 Fábrica: DELTA UTIL Unidade: UN/1 F1 F4

UN: R\$ 3,12 AV: R\$ 3,12 15: R\$ 3,19
30: R\$ 3,25 45: R\$ 3,32 60: R\$ 3,38



PORTA SABAO 335

Código: 28886 Fábrica: JOREAL Unidade: UN/1 F1 F4

UN: R\$ 4,59 AV: R\$ 4,59 15: R\$ 4,69
30: R\$ 4,78 45: R\$ 4,88 60: R\$ 4,98



PORTA SABAO/DET/BUCHA PLAST 6611

Código: 41671 Fábrica: INPLAST Unidade: UN/1 F1 F4

UN: R\$ 12,60 AV: R\$ 12,60 15: R\$ 12,86
30: R\$ 13,12 45: R\$ 13,38 60: R\$ 13,65



PORTA SABONETE LIQ PLAST 500 ML 981

Código: 46670 Fábrica: LUMAR Unidade: UN/1 F1 F4

UN: R\$ 9,78 AV: R\$ 9,78 15: R\$ 9,99
30: R\$ 10,19 45: R\$ 10,39 60: R\$ 10,60



PORTA SABONETE LIQUIDO PLAST 250ML 2636

Código: 41556 Fábrica: PLASUTIL Unidade: UN/1 F1 F4

UN: R\$ 10,97 AV: R\$ 10,97 15: R\$ 11,20
30: R\$ 11,42 45: R\$ 11,65 60: R\$ 11,88



PORTA SACHES INOX 10X4,5X6,5CM 180224

Código: 39220 Fábrica: SATYAM Unidade: UN/1 F1 F4

UN: R\$ 36,22 AV: R\$ 36,22 15: R\$ 36,98
30: R\$ 37,71 45: R\$ 38,47 60: R\$ 39,24



PORTA TALHER CROM 561

Código: 20176 Fábrica: ARAMINAS Unidade: UN/1 F1 F4

UN: R\$ 34,47 AV: R\$ 34,47 15: R\$ 35,19
30: R\$ 35,89 45: R\$ 36,61 60: R\$ 37,34

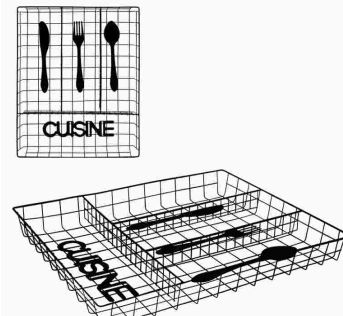

PORTA TALHER INOX ARAMADO 32X26X3,5CM

Código: 38529 Fábrica: WINCY Unidade: UN/1 F1 F4

UN: R\$ 5,18 AV: R\$ 5,18 15: R\$ 5,29
30: R\$ 5,39 45: R\$ 5,50 60: R\$ 5,61



PORTA TALHER PLAST COLOR 6699

Código: 41672 Fábrica: INPLAST Unidade: UN/1 F1 F4

UN: R\$ 31,98 AV: R\$ 31,98 15: R\$ 32,65
30: R\$ 33,30 45: R\$ 33,97 60: R\$ 34,65



PORTA TALHER PLASTICO C/TAMPA 517

Código: Fábrica: Unidade:
35484 TRITEC UN/1
F1 F4

UN: R\$ 47,97 AV: R\$ 47,97 15: R\$ 48,97
30: R\$ 49,95 45: R\$ 50,95 60: R\$ 51,97

11 cm
35 cm



PORTA VINHO DEITADO ENVELHEC 3424-1

Código: Fábrica: Unidade:
37189 PAIOL UN/1
F1 F4

UN: R\$ 47,97 AV: R\$ 47,97 15: R\$ 48,97
30: R\$ 49,95 45: R\$ 50,95 60: R\$ 51,97

22cm
37 cm

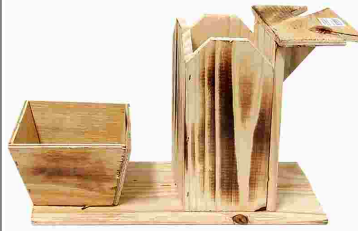

PORTA VINHO E TACAS VIOLETA 4546

Código: Fábrica: Unidade:
37188 PAIOL UN/1
F1 F4

UN: R\$ 23,98 AV: R\$ 23,98 15: R\$ 24,48
30: R\$ 24,97 45: R\$ 25,47 60: R\$ 25,98



POTE CAFE ACUCAR PORTA FILT/ADAPTAD 8001

Código: Fábrica: Unidade:
34564 SBRISSA CJ/1
F1 F4

UN: R\$ 18,11 AV: R\$ 18,11 15: R\$ 18,48
30: R\$ 18,85 45: R\$ 19,23 60: R\$ 19,61



POTE CAFE ACUCAR PREMIUM 8005

Código: Fábrica: Unidade:
34565 SBRISSA CJ/1
F1 F4

UN: R\$ 28,39 AV: R\$ 28,39 15: R\$ 28,98
30: R\$ 29,56 45: R\$ 30,15 60: R\$ 30,75



POTE HERMETICO 4,5LTS RET C/TRAVA 952

Código: Fábrica: Unidade:
48669 LIG BRIN UN/1
F1 F4

UN: R\$ 24,47 AV: R\$ 24,47 15: R\$ 24,98
30: R\$ 25,48 45: R\$ 25,99 60: R\$ 26,51



POTE MANTIMENTO ALUM LEVE 14

Código: Fábrica: Unidade:
11260 AVELAR UN/1
F1 F4

UN: R\$ 8,80 AV: R\$ 8,80 15: R\$ 8,99
30: R\$ 9,17 45: R\$ 9,35 60: R\$ 9,54



POTE PLAST C/TAMPA MULTIUSO G COLOR

Código: Fábrica: Unidade:
41209 PLASTSU UN/1
F1 F4

UN: R\$ 14,68 AV: R\$ 14,68 15: R\$ 14,98
30: R\$ 15,28 45: R\$ 15,59 60: R\$ 15,90



POTE PLAST C/TRAVA GG COLOR 2,5LT 331030

Código: Fábrica: Unidade:
41207 PLASTSU UN/1
F1 F4

UN: R\$ 0,14 AV: R\$ 6,84 15: R\$ 6,99
30: R\$ 7,13 45: R\$ 7,27 60: R\$ 7,41



POTE PLAST DESC 250 ML 50X1

Código: Fábrica: Unidade:
47739 COPOZAN PT/50
F1 F4

UN: R\$ 11,09 AV: R\$ 11,09 15: R\$ 11,33
30: R\$ 11,55 45: R\$ 11,78 60: R\$ 12,02



POTE PLAST HERM 2,2 LTS ALTO TRANSP 183T

Código: Fábrica: Unidade:
34068 GIOTTO UN/1
F1 F4

UN: R\$ 5,39 AV: R\$ 5,39 15: R\$ 5,50
30: R\$ 5,61 45: R\$ 5,72 60: R\$ 5,83



POTE PLAST MANT 2,5LTS QUAD ACUCAR 244

Código: Fábrica: Unidade:
40367 FORMPLAST UN/1
F1 F4

UN: R\$ 5,39 AV: R\$ 5,39 15: R\$ 5,50
30: R\$ 5,61 45: R\$ 5,72 60: R\$ 5,83



POTE PLAST MANT 2,5LTS QUAD ARROZ 241

Código: Fábrica: Unidade:
40370 FORMPLAST UN/1
F1 F4

UN: R\$ 5,39 AV: R\$ 5,39 15: R\$ 5,50
30: R\$ 5,61 45: R\$ 5,72 60: R\$ 5,83



POTE PLAST MANT 2,5LTS QUAD CAFE 245

Código: Fábrica: Unidade:
40368 FORMPLAST UN/1
F1 F4

UN: R\$ 5,39 AV: R\$ 5,39 15: R\$ 5,50
30: R\$ 5,61 45: R\$ 5,72 60: R\$ 5,83



POTE PLAST MANT 2,5LTS QUAD FARINHA 243

Código: Fábrica: Unidade:
40366 FORMPLAST UN/1
F1 F4

UN: R\$ 5,39 AV: R\$ 5,39 15: R\$ 5,50
30: R\$ 5,61 45: R\$ 5,72 60: R\$ 5,83



POTE PLAST MANT 2,5LTS QUAD FEIJAO 242

Código: Fábrica: Unidade:
40365 FORMPLAST UN/1
F1 F4

UN: R\$ 11,52 AV: R\$ 11,52 15: R\$ 11,76
30: R\$ 11,99 45: R\$ 12,23 60: R\$ 12,47



POTE PLAST RED 5LTS PREMIUM FACILITT 155
Código: 45190 Fábrica: RISCHIOTO Unidade: UN/1
F1 F4

UN: R\$ 12,12 AV: R\$ 12,12 15: R\$ 12,38
30: R\$ 12,62 45: R\$ 12,88 60: R\$ 13,13



POTE PLAST RET ALTO 4,2LTS 342
Código: 45196 Fábrica: RISCHIOTO Unidade: UN/1
F1 F4

UN: R\$ 7,53 AV: R\$ 7,53 15: R\$ 7,69
30: R\$ 7,84 45: R\$ 8,00 60: R\$ 8,16

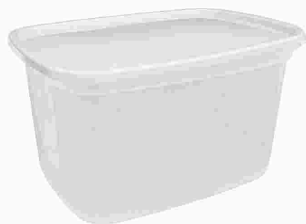

POTE PLAST RET FACILITTA ALTO 2,5LTS 341
Código: 45191 Fábrica: RISCHIOTO Unidade: UN/1
F1 F4

UN: R\$ 18,18 AV: R\$ 18,18 15: R\$ 18,56
30: R\$ 18,93 45: R\$ 19,31 60: R\$ 19,70

28cm
10cm
19cm



POTE PLAST RET 2,75L C/TRAVA 3312
Código: 47055 Fábrica: JAGUAR Unidade: UN/1
F1 F4

UN: R\$ 13,49 AV: R\$ 13,49 15: R\$ 13,77
30: R\$ 14,05 45: R\$ 14,33 60: R\$ 14,62

30cm
10cm
20cm



POTE PLAST RET 3,6LTS 1666
Código: 6195 Fábrica: JAGUAR Unidade: UN/1
F1 F4

UN: R\$ 22,23 AV: R\$ 22,23 15: R\$ 22,69
30: R\$ 23,14 45: R\$ 23,61 60: R\$ 24,08

28cm
17cm
19cm



POTE PLAST RET 5LTS C/TRAVA 3313
Código: 47057 Fábrica: JAGUAR Unidade: UN/1
F1 F4

UN: R\$ 6,79 AV: R\$ 6,79 15: R\$ 6,93
30: R\$ 7,07 45: R\$ 7,21 60: R\$ 7,35

17cm
8cm
19cm



POTE PLAST RET 850 ML C/TRAVA 3306
Código: 47044 Fábrica: JAGUAR Unidade: UN/1
F1 F4

UN: R\$ 7,33 AV: R\$ 7,33 15: R\$ 7,49
30: R\$ 7,64 45: R\$ 7,79 60: R\$ 7,95



POTE PLAST SUPERCLICK 800ML 1545 UN
Código: 45442 Fábrica: TRITEC Unidade: UN/1
F1 F4

UN: R\$ 7,44 AV: R\$ 7,44 15: R\$ 7,60
30: R\$ 7,75 45: R\$ 7,90 60: R\$ 8,06

6,5 cm
22 cm
1250ml



POTE PLAST 1250 ML RET CLICK G 75832
Código: 40396 Fábrica: UN-ART Unidade: UN/1
F1 F4

UN: R\$ 5,39 AV: R\$ 5,39 15: R\$ 5,50
30: R\$ 5,61 45: R\$ 5,72 60: R\$ 5,83

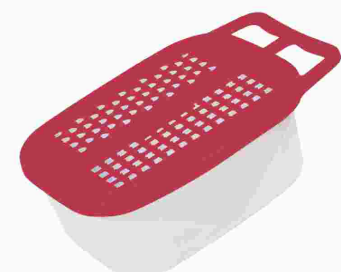

POTE PLAST 1,4 LTS C/RALADOR COLOR 4035
Código: 40376 Fábrica: FORMPLAST Unidade: UN/1
F1 F4

UN: R\$ 7,82 AV: R\$ 7,82 15: R\$ 7,99
30: R\$ 8,15 45: R\$ 8,31 60: R\$ 8,48



POTE PLAST 1,5 LTS COLOR 819
Código: 45843 Fábrica: LUMAR Unidade: UN/1
F1 F4

UN: R\$ 5,39 AV: R\$ 5,39 15: R\$ 5,50
30: R\$ 5,61 45: R\$ 5,72 60: R\$ 5,83



POTE PLAST 1,7 LTS DUPLO COLOR 14
Código: 40372 Fábrica: FORMPLAST Unidade: UN/1
F1 F4

UN: R\$ 8,32 AV: R\$ 8,32 15: R\$ 8,50
30: R\$ 8,67 45: R\$ 8,84 60: R\$ 9,02



POTE PLAST 2 LTS ALTO FRUTAS 002
Código: 36530 Fábrica: MAXIMAPLASTI Unidade: UN/1
F1 F4

UN: R\$ 10,40 AV: R\$ 10,40 15: R\$ 10,62
30: R\$ 10,83 45: R\$ 11,04 60: R\$ 11,27



POTE PLAST 2,5 LT RED P/ ALIMENT 4009
Código: 13912 Fábrica: SBRISSA Unidade: UN/1
F1 F4

UN: R\$ 11,54 AV: R\$ 11,54 15: R\$ 11,79
30: R\$ 12,02 45: R\$ 12,26 60: R\$ 12,51



POTE PLAST 2,5 LT RED P/ALIMENT DEC 8015
Código: 35220 Fábrica: SBRISSA Unidade: UN/1
F1 F4

UN: R\$ 12,73 AV: R\$ 12,73 15: R\$ 12,99
30: R\$ 13,25 45: R\$ 13,52 60: R\$ 13,79



POTE PLAST 3 LTS ALTO FRUTAS 003
Código: 36529 Fábrica: MAXIMAPLASTI Unidade: UN/1
F1 F4

<p>UN: R\$ 5,48 AV: R\$ 5,48 15: R\$ 5,60 30: R\$ 5,71 45: R\$ 5,82 60: R\$ 5,94</p>  <p>POTE PLAST 380 ML RET CLICK P 75820 Código: Fábrica: Unidade: 40394 UN-ART UN/1 F1 F4</p>	<p>UN: R\$ 15,28 AV: R\$ 15,28 15: R\$ 15,59 30: R\$ 15,91 45: R\$ 16,22 60: R\$ 16,55</p>  <p>POTE PLAST 4,5LTS C/ROSCA SPINLOCK 7704 Código: Fábrica: Unidade: 50230 RISCHIOTO UN/1 F1 F4</p>	<p>UN: R\$ 19,58 AV: R\$ 19,58 15: R\$ 19,99 30: R\$ 20,39 45: R\$ 20,80 60: R\$ 21,22</p>  <p>POTE PLAST 5 LTS ALTO FRUTAS 004 Código: Fábrica: Unidade: 36528 MAXIMAPLASTI UN/1 F1 F4</p>	<p>UN: R\$ 6,66 AV: R\$ 6,66 15: R\$ 6,80 30: R\$ 6,93 45: R\$ 7,07 60: R\$ 7,21</p>  <p>POTE PLAST 740 ML RET CLICK M 75826 Código: Fábrica: Unidade: 40395 UN-ART UN/1 F1 F4</p>
<p>UN: R\$ 4,23 AV: R\$ 4,23 15: R\$ 4,32 30: R\$ 4,40 45: R\$ 4,49 60: R\$ 4,58</p>  <p>POTE PLAST 800ML QUAD TRANSP TP AZUL PER Código: Fábrica: Unidade: 40134 KOZI PLAST UN/1 F1 F4</p>	<p>UN: R\$ 4,23 AV: R\$ 4,23 15: R\$ 4,32 30: R\$ 4,40 45: R\$ 4,49 60: R\$ 4,58</p>  <p>POTE PLAST 800ML QUAD TRANSP TP BRANCA Código: Fábrica: Unidade: 40133 KOZI PLAST UN/1 F1 F4</p>	<p>UN: R\$ 4,23 AV: R\$ 4,23 15: R\$ 4,32 30: R\$ 4,40 45: R\$ 4,49 60: R\$ 4,58</p>  <p>POTE PLAST 800ML RED TRANSP TP AZUL PER Código: Fábrica: Unidade: 40139 KOZI PLAST UN/1 F1 F4</p>	<p>UN: R\$ 4,23 AV: R\$ 4,23 15: R\$ 4,32 30: R\$ 4,40 45: R\$ 4,49 60: R\$ 4,58</p>  <p>POTE PLAST 800ML RED TRANSP TP AZUL ROY Código: Fábrica: Unidade: 40140 KOZI PLAST UN/1 F1 F4</p>
<p>UN: R\$ 4,23 AV: R\$ 4,23 15: R\$ 4,32 30: R\$ 4,40 45: R\$ 4,49 60: R\$ 4,58</p>  <p>POTE PLAST 800ML RED TRANSP TP BRANCA Código: Fábrica: Unidade: 40138 KOZI PLAST UN/1 F1 F4</p>	<p>UN: R\$ 4,23 AV: R\$ 4,23 15: R\$ 4,32 30: R\$ 4,40 45: R\$ 4,49 60: R\$ 4,58</p>  <p>POTE PLAST 800ML RED TRANSP TP ROSA PER Código: Fábrica: Unidade: 40141 KOZI PLAST UN/1 F1 F4</p>	<p>UN: R\$ 8,76 AV: R\$ 8,76 15: R\$ 8,95 30: R\$ 9,13 45: R\$ 9,31 60: R\$ 9,49</p>  <p>POTE VIDRO 1 LT C/TPA PLAST 22011 Código: Fábrica: Unidade: 46889 SATYAM UN/1 F1 F4</p>	<p>UN: R\$ 11,75 AV: R\$ 11,75 15: R\$ 12,00 30: R\$ 12,24 45: R\$ 12,48 60: R\$ 12,73</p>  <p>POTE VIDRO 1,0 L C/TPA PLAST 0017 Código: Fábrica: Unidade: 35096 SATYAM UN/1 F1 F4</p>
<p>UN: R\$ 14,69 AV: R\$ 14,69 15: R\$ 14,99 30: R\$ 15,29 45: R\$ 15,60 60: R\$ 15,91</p>  <p>POTE VIDRO 1,0 L C/TPA PLAST 0022 Código: Fábrica: Unidade: 35097 SATYAM UN/1 F1 F4</p>	<p>UN: R\$ 10,76 AV: R\$ 10,76 15: R\$ 10,99 30: R\$ 11,21 45: R\$ 11,43 60: R\$ 11,66</p>  <p>POTE VIDRO 1,0 L C/TPA PLAST 9426 Código: Fábrica: Unidade: 47316 CASITA UN/1 F1 F4</p>	<p>UN: R\$ 10,28 AV: R\$ 10,28 15: R\$ 10,50 30: R\$ 10,71 45: R\$ 10,92 60: R\$ 11,14</p>  <p>POTE VIDRO 720 ML C/TPA PLAST 0016 Código: Fábrica: Unidade: 35098 SATYAM UN/1 F1 F4</p>	<p>UN: R\$ 12,72 AV: R\$ 12,72 15: R\$ 12,98 30: R\$ 13,24 45: R\$ 13,51 60: R\$ 13,78</p>  <p>PRATO ALUM FUNDO 1290 Código: Fábrica: Unidade: 37253 MSR/YANG UN/1 F1 F4</p>

UN: R\$ 9,78 AV: R\$ 9,78 15: R\$ 9,99
30: R\$ 10,19 45: R\$ 10,39 60: R\$ 10,60



PRATO ALUM LEVE ESCOLAR

Código: 27596 Fábrica: AVELAR Unidade: UN/1 F1 F4

UN: R\$ 22,85 AV: R\$ 274,17 15: R\$ 279,88
30: R\$ 285,48 45: R\$ 291,19 60: R\$ 297,01



PRATO CERAMICA BCO RASO LISO 10.5 12X1

Código: 41460 Fábrica: MABEL Unidade: CX/12 F1 F4

UN: R\$ 3,91 AV: R\$ 3,91 15: R\$ 3,99
30: R\$ 4,07 45: R\$ 4,15 60: R\$ 4,23



PRATO DESCARTAVEL FUNDO N20 10UN

Código: 48319 Fábrica: COPOPLAST Unidade: PT/1 F1 F4

UN: R\$ 2,87 AV: R\$ 2,87 15: R\$ 2,93
30: R\$ 2,99 45: R\$ 3,05 60: R\$ 3,11



PRATO INF FUNDO DECORADO 1648

Código: 7964 Fábrica: PLASUTIL Unidade: UN/1 F1 F4

UN: R\$ 4,89 AV: R\$ 4,89 15: R\$ 4,99
30: R\$ 5,09 45: R\$ 5,19 60: R\$ 5,29



PRATO MELAMINE FUNDO 20 CM 528P

Código: 10059 Fábrica: IDEA Unidade: UN/1 F1 F4

UN: R\$ 0,88 AV: R\$ 0,88 15: R\$ 0,90
30: R\$ 0,92 45: R\$ 0,94 60: R\$ 0,95

11 2,5 cm
12 09 cm



PRATO PL 09 PRETO 9X25CM 222

Código: 37709 Fábrica: BIG PLAST Unidade: UN/1 F1 F4

UN: R\$ 1,65 AV: R\$ 1,65 15: R\$ 1,69
30: R\$ 1,72 45: R\$ 1,76 60: R\$ 1,79

11 2,5 cm
12 13 cm



PRATO PL 1 RED PRETO

Código: 18462 Fábrica: NUTRIPLAN Unidade: UN/1 F1 F4

UN: R\$ 1,06 AV: R\$ 1,06 15: R\$ 1,08
30: R\$ 1,10 45: R\$ 1,12 60: R\$ 1,15

11 2,5 cm
12 11 cm



PRATO PL 11 PRETO 11X2,5CM 224

Código: 37708 Fábrica: BIG PLAST Unidade: UN/1 F1 F4

UN: R\$ 3,53 AV: R\$ 3,53 15: R\$ 3,60
30: R\$ 3,67 45: R\$ 3,74 60: R\$ 3,82

11 1,5 cm
12 15 cm



PRATO PL 1,2 RED PEQ AMARELO CLARO

Código: 34596 Fábrica: NUTRIPLAN Unidade: UN/1 F1 F4

UN: R\$ 3,53 AV: R\$ 3,53 15: R\$ 3,60
30: R\$ 3,67 45: R\$ 3,74 60: R\$ 3,82

11 1,5 cm
12 15 cm



PRATO PL 1,2 RED PEQ LILAS CLARO

Código: 34597 Fábrica: NUTRIPLAN Unidade: UN/1 F1 F4

UN: R\$ 3,53 AV: R\$ 3,53 15: R\$ 3,60
30: R\$ 3,67 45: R\$ 3,74 60: R\$ 3,82

11 1,5 cm
12 15 cm



PRATO PL 1,2 RED PEQ ROSA BEBE

Código: 34599 Fábrica: NUTRIPLAN Unidade: UN/1 F1 F4

UN: R\$ 3,91 AV: R\$ 3,91 15: R\$ 3,99
30: R\$ 4,07 45: R\$ 4,15 60: R\$ 4,23

11 1,5 cm
12 15 cm



PRATO PL 1,2 RED PEQ VERDE CLARO

Código: 34598 Fábrica: NUTRIPLAN Unidade: UN/1 F1 F4

UN: R\$ 2,40 AV: R\$ 2,40 15: R\$ 2,45
30: R\$ 2,50 45: R\$ 2,55 60: R\$ 2,60

11 2,8 cm
12 17 cm



PRATO PL 1,5 RED PEQ MARROM

Código: 22296 Fábrica: NUTRIPLAN Unidade: UN/1 F1 F4

UN: R\$ 2,44 AV: R\$ 2,44 15: R\$ 2,49
30: R\$ 2,54 45: R\$ 2,59 60: R\$ 2,64

11 2,8 cm
12 17 cm



PRATO PL 1,5 RED PEQ PRETO

Código: 18463 Fábrica: NUTRIPLAN Unidade: UN/1 F1 F4

UN: R\$ 4,20 AV: R\$ 4,20 15: R\$ 4,29
30: R\$ 4,37 45: R\$ 4,46 60: R\$ 4,55

11 3 cm
12 19 cm



PRATO PL 2 RED MARROM

Código: 30286 Fábrica: NUTRIPLAN Unidade: UN/1 F1 F4

UN: R\$ 3,32 AV: R\$ 3,32 15: R\$ 3,39
30: R\$ 3,46 45: R\$ 3,53 60: R\$ 3,60

11 3 cm
12 19 cm



PRATO PL 2 RED PRETO

Código: 18464 Fábrica: NUTRIPLAN Unidade: UN/1 F1 F4

UN: R\$ 4,89 AV: R\$ 4,89 15: R\$ 4,99
 30: R\$ 5,09 45: R\$ 5,19 60: R\$ 5,29



PRATO PL 3 RED MARROM

Código: Fábrika: Unidade:
30288 NUTRIPLAN UN/1
 F1 F4

UN: R\$ 3,91 AV: R\$ 3,91 15: R\$ 3,99
 30: R\$ 4,07 45: R\$ 4,15 60: R\$ 4,23



PRATO PL 3 RED PRETO

Código: Fábrika: Unidade:
18465 NUTRIPLAN UN/1
 F1 F4

UN: R\$ 6,51 AV: R\$ 6,51 15: R\$ 6,65
 30: R\$ 6,78 45: R\$ 6,92 60: R\$ 7,05



PRATO PL 4 RED MARROM

Código: Fábrika: Unidade:
18484 NUTRIPLAN UN/1
 F1 F4

UN: R\$ 5,38 AV: R\$ 5,38 15: R\$ 5,49
 30: R\$ 5,60 45: R\$ 5,71 60: R\$ 5,82



PRATO PL 4 RED PRETO

Código: Fábrika: Unidade:
18466 NUTRIPLAN UN/1
 F1 F4

UN: R\$ 6,25 AV: R\$ 6,25 15: R\$ 6,38
 30: R\$ 6,51 45: R\$ 6,64 60: R\$ 6,77



PRATO PL 5 MARROM

Código: Fábrika: Unidade:
30289 NUTRIPLAN UN/1
 F1 F4

UN: R\$ 6,84 AV: R\$ 6,84 15: R\$ 6,99
 30: R\$ 7,13 45: R\$ 7,27 60: R\$ 7,41



PRATO PL 5 PRETO

Código: Fábrika: Unidade:
30290 NUTRIPLAN UN/1
 F1 F4

UN: R\$ 6,84 AV: R\$ 6,84 15: R\$ 6,99
 30: R\$ 7,13 45: R\$ 7,27 60: R\$ 7,41



PRATO PL 6 RED PRETO

Código: Fábrika: Unidade:
18467 NUTRIPLAN UN/1
 F1 F4

UN: R\$ 8,42 AV: R\$ 8,42 15: R\$ 8,60
 30: R\$ 8,77 45: R\$ 8,94 60: R\$ 9,12



PRATO PL 7 MARROM

Código: Fábrika: Unidade:
18485 NUTRIPLAN UN/1
 F1 F4

UN: R\$ 8,74 AV: R\$ 8,74 15: R\$ 8,93
 30: R\$ 9,11 45: R\$ 9,29 60: R\$ 9,47



PRATO PL 7 RED PRETO

Código: Fábrika: Unidade:
18468 NUTRIPLAN UN/1
 F1 F4

UN: R\$ 12,00 AV: R\$ 12,00 15: R\$ 12,25
 30: R\$ 12,49 45: R\$ 12,74 60: R\$ 12,99



PRATO PL 8 RED PRETO

Código: Fábrika: Unidade:
18469 NUTRIPLAN UN/1
 F1 F4

UN: R\$ 14,68 AV: R\$ 14,68 15: R\$ 14,98
 30: R\$ 15,28 45: R\$ 15,59 60: R\$ 15,90



PRATO PL 9 PRETO

Código: Fábrika: Unidade:
30291 NUTRIPLAN UN/1
 F1 F4

UN: R\$ 3,43 AV: R\$ 3,43 15: R\$ 3,50
 30: R\$ 3,57 45: R\$ 3,64 60: R\$ 3,71



PRATO PL FLOREIRA 1 MARROM

Código: Fábrika: Unidade:
18511 NUTRIPLAN UN/1
 F1 F4

UN: R\$ 2,45 AV: R\$ 2,45 15: R\$ 2,50
 30: R\$ 2,55 45: R\$ 2,60 60: R\$ 2,65



PRATO PL FLOREIRA 1 17CM MARMORE

Código: Fábrika: Unidade:
22299 NUTRIPLAN UN/1
 F1 F4

UN: R\$ 4,50 AV: R\$ 4,50 15: R\$ 4,60
 30: R\$ 4,69 45: R\$ 4,78 60: R\$ 4,88

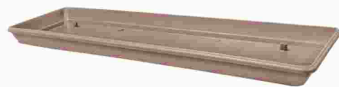
PRATO PL JARDINEIRA 35CM CAPUCCINO

Código: Fábrika: Unidade:
35206 NUTRIPLAN UN/1
 F1 F4

UN: R\$ 4,50 AV: R\$ 4,50 15: R\$ 4,60
 30: R\$ 4,69 45: R\$ 4,78 60: R\$ 4,88



PRATO PL JARDINEIRA 35CM CINZA

Código: Fábrika: Unidade:
35207 NUTRIPLAN UN/1
 F1 F4

UN: R\$ 5,98 AV: R\$ 5,98 15: R\$ 6,11
 30: R\$ 6,23 45: R\$ 6,35 60: R\$ 6,48

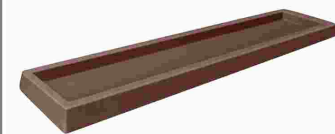

PRATO PL JARDINEIRA 35CM TABACO

Código: Fábrika: Unidade:
33907 NUTRIPLAN UN/1
 F1 F4

UN: R\$ 9,79 AV: R\$ 9,79 15: R\$ 10,00
30: R\$ 10,20 45: R\$ 10,40 60: R\$ 10,61

11cm
50cm



PRATO PL JARDINEIRA 50 CM CAPUCCINO

Código: 35208 Fábrica: NUTRIPLAN Unidade: UN/1
F1 F4

UN: R\$ 13,91 AV: R\$ 13,91 15: R\$ 14,20
30: R\$ 14,49 45: R\$ 14,78 60: R\$ 15,07

11cm
50cm



PRATO PL JARDINEIRA 50 CM CINZA

Código: 35209 Fábrica: NUTRIPLAN Unidade: UN/1
F1 F4

UN: R\$ 19,57 AV: R\$ 19,57 15: R\$ 19,98
30: R\$ 20,38 45: R\$ 20,79 60: R\$ 21,21

11cm
35cm

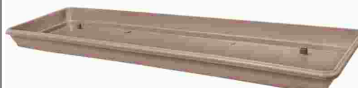

PRATO PL JARDINEIRA 80 CM CAPUCCINO

Código: 35461 Fábrica: NUTRIPLAN Unidade: UN/1
F1 F4

UN: R\$ 28,29 AV: R\$ 28,29 15: R\$ 28,88
30: R\$ 29,46 45: R\$ 30,05 60: R\$ 30,65

11cm
35cm

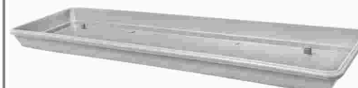

PRATO PL JARDINEIRA 80 CM CINZA

Código: 35462 Fábrica: NUTRIPLAN Unidade: UN/1
F1 F4

UN: R\$ 1,03 AV: R\$ 1,03 15: R\$ 1,05
30: R\$ 1,07 45: R\$ 1,09 60: R\$ 1,11

1,5 cm
8,5 cm



PRATO PL MINI FLOREIRA QUAD MARMORE

Código: 22298 Fábrica: NUTRIPLAN Unidade: UN/1
F1 F4

UN: R\$ 1,35 AV: R\$ 1,35 15: R\$ 1,38
30: R\$ 1,41 45: R\$ 1,44 60: R\$ 1,46

1,5 cm
8,5 cm



PRATO PL MINI FLOREIRA QUAD MARROM

Código: 22297 Fábrica: NUTRIPLAN Unidade: UN/1
F1 F4

UN: R\$ 0,88 AV: R\$ 0,88 15: R\$ 0,90
30: R\$ 0,92 45: R\$ 0,94 60: R\$ 0,95

1,5 cm
8,5 cm



PRATO PL MINI FLOREIRA QUAD PRETO

Código: 30208 Fábrica: NUTRIPLAN Unidade: UN/1
F1 F4

UN: R\$ 2,66 AV: R\$ 2,66 15: R\$ 2,72
30: R\$ 2,77 45: R\$ 2,83 60: R\$ 2,89



PRATO PL 0,5 RED PEQ AMARELO CLARO

Código: 35713 Fábrica: NUTRIPLAN Unidade: UN/1
F1 F4

UN: R\$ 2,66 AV: R\$ 2,66 15: R\$ 2,72
30: R\$ 2,77 45: R\$ 2,83 60: R\$ 2,89



PRATO PL 0,5 RED PEQ LILAS CLARO

Código: 35714 Fábrica: NUTRIPLAN Unidade: UN/1
F1 F4

UN: R\$ 2,66 AV: R\$ 2,66 15: R\$ 2,72
30: R\$ 2,77 45: R\$ 2,83 60: R\$ 2,89



PRATO PL 0,5 RED PEQ ROSA BEBE

Código: 35715 Fábrica: NUTRIPLAN Unidade: UN/1
F1 F4

UN: R\$ 2,66 AV: R\$ 2,66 15: R\$ 2,72
30: R\$ 2,77 45: R\$ 2,83 60: R\$ 2,89



PRATO PL 0,5 RED PEQ VERDE CLARO

Código: 35716 Fábrica: NUTRIPLAN Unidade: UN/1
F1 F4

UN: R\$ 21,44 AV: R\$ 21,44 15: R\$ 21,89
30: R\$ 22,33 45: R\$ 22,78 60: R\$ 23,23

6 cm
41 cm



PRATO PL 10 MARROM

Código: 30292 Fábrica: NUTRIPLAN Unidade: UN/1
F1 F4

UN: R\$ 1,22 AV: R\$ 1,22 15: R\$ 1,25
30: R\$ 1,27 45: R\$ 1,30 60: R\$ 1,33

3cm
14cm



PRATO PL 14 PRETO 14X3CM 226

Código: 47291 Fábrica: BIG PLAST Unidade: UN/1
F1 F4

UN: R\$ 1,47 AV: R\$ 1,47 15: R\$ 1,50
30: R\$ 1,53 45: R\$ 1,56 60: R\$ 1,59



PRATO PL 14 RED 14CM PRETO 344

Código: 40847 Fábrica: JOREAL Unidade: UN/1
F1 F4

UN: R\$ 2,30 AV: R\$ 2,30 15: R\$ 2,35
30: R\$ 2,40 45: R\$ 2,44 60: R\$ 2,49

3,5 cm
17 cm



PRATO PL 17 PRETO 17X3,5CM 228

Código: 37707 Fábrica: BIG PLAST Unidade: UN/1
F1 F4

UN: R\$ 2,63 AV: R\$ 2,63 15: R\$ 2,69
30: R\$ 2,74 45: R\$ 2,80 60: R\$ 2,85

3,5 cm
20 cm



PRATO PL 20 PRETO 20X3,5CM 230

Código: 47290 Fábrica: BIG PLAST Unidade: UN/1
F1 F4

UN: R\$ 3,76 AV: R\$ 3,76 15: R\$ 3,84
 30: R\$ 3,92 45: R\$ 3,99 60: R\$ 4,07



PRATO PL 22 PRETO 22X3,5CM 232
 Código: 37706 Fábrica: BIG PLAST Unidade: UN/1
 F1 F4

UN: R\$ 33,39 AV: R\$ 33,39 15: R\$ 34,09
 30: R\$ 34,77 45: R\$ 35,46 60: R\$ 36,17





PRATO PL 29 QUAD TEXTUR AREIA
 Código: 30342 Fábrica: NUTRIPLAN Unidade: UN/1
 F1 F4

UN: R\$ 25,95 AV: R\$ 25,95 15: R\$ 26,49
 30: R\$ 27,02 45: R\$ 27,56 60: R\$ 28,11





PRATO PL 29 QUAD TEXTUR FERRUGEM
 Código: 30343 Fábrica: NUTRIPLAN Unidade: UN/1
 F1 F4

UN: R\$ 40,93 AV: R\$ 40,93 15: R\$ 41,78
 30: R\$ 42,62 45: R\$ 43,47 60: R\$ 44,34





PRATO PL 33 QUAD TEXTUR FERRUGEM
 Código: 30344 Fábrica: NUTRIPLAN Unidade: UN/1
 F1 F4

UN: R\$ 53,86 AV: R\$ 53,86 15: R\$ 54,98
 30: R\$ 56,08 45: R\$ 57,20 60: R\$ 58,34





PRATO PL 41 RED TEXTUR AREIA
 Código: 36795 Fábrica: NUTRIPLAN Unidade: UN/1
 F1 F4

UN: R\$ 43,08 AV: R\$ 43,08 15: R\$ 43,98
 30: R\$ 44,86 45: R\$ 45,76 60: R\$ 46,67





PRATO PL 41 RED TEXTUR FERRUGEM
 Código: 30345 Fábrica: NUTRIPLAN Unidade: UN/1
 F1 F4

UN: R\$ 52,88 AV: R\$ 52,88 15: R\$ 53,98
 30: R\$ 55,06 45: R\$ 56,16 60: R\$ 57,28





PRATO PL 44 QUAD LISO AREIA
 Código: 30346 Fábrica: NUTRIPLAN Unidade: UN/1
 F1 F4

UN: R\$ 49,65 AV: R\$ 49,65 15: R\$ 50,68
 30: R\$ 51,69 45: R\$ 52,73 60: R\$ 53,78





PRATO PL 46 RED LISO FERRUGEM
 Código: 30341 Fábrica: NUTRIPLAN Unidade: UN/1
 F1 F4

UN: R\$ 51,41 AV: R\$ 51,41 15: R\$ 52,48
 30: R\$ 53,53 45: R\$ 54,60 60: R\$ 55,69



PRATO PL 47 RED TEXTUR FERRUGEM
 Código: 30347 Fábrica: NUTRIPLAN Unidade: UN/1
 F1 F4

UN: R\$ 64,92 AV: R\$ 64,92 15: R\$ 66,27
 30: R\$ 67,60 45: R\$ 68,95 60: R\$ 70,33



PRATO PL 50 RED TEXTUR AREIA
 Código: 36283 Fábrica: NUTRIPLAN Unidade: UN/1
 F1 F4

UN: R\$ 3,12 AV: R\$ 3,12 15: R\$ 3,19
 30: R\$ 3,25 45: R\$ 3,32 60: R\$ 3,38



PRATO PLAST FUNDO KIDS CORES 21X30CM 756
 Código: 46643 Fábrica: QUALYPLAS Unidade: UN/1
 F1 F4

UN: R\$ 2,73 AV: R\$ 2,73 15: R\$ 2,79
 30: R\$ 2,84 45: R\$ 2,90 60: R\$ 2,96



PRATO PLAST FUNDO 3000
 Código: 20712 Fábrica: SBRISSA Unidade: UN/1
 F1 F4

UN: R\$ 3,91 AV: R\$ 3,91 15: R\$ 3,99
 30: R\$ 4,07 45: R\$ 4,15 60: R\$ 4,23



PRATO PLAST INF FUNDO 22 CM C/ABA 1276
 Código: 18213 Fábrica: ECOPLASTIC Unidade: UN/1
 F1 F4

UN: R\$ 3,91 AV: R\$ 3,91 15: R\$ 3,99
 30: R\$ 4,07 45: R\$ 4,15 60: R\$ 4,23



PRATO PLAST INF RASO 20 CM S/ABA 1278
 Código: 22322 Fábrica: ECOPLASTIC Unidade: UN/1
 F1 F4

UN: R\$ 2,16 AV: R\$ 2,16 15: R\$ 2,21
 30: R\$ 2,25 45: R\$ 2,30 60: R\$ 2,34



PRATO PLAST RASO 3007
 Código: 14576 Fábrica: SBRISSA Unidade: UN/1
 F1 F4

UN: R\$ 10,77 AV: R\$ 64,63 15: R\$ 65,97
 30: R\$ 67,29 45: R\$ 68,64 60: R\$ 70,01



PRATO PORC FUNDO FEST BCO 23CM 7507 6X1
 Código: 35059 Fábrica: CHEF LINE Unidade: PT/6
 F1 F4

UN: R\$ 16,32 AV: R\$ 97,92 15: R\$ 99,96
30: R\$ 101,96 45: R\$ 104,00 60: R\$ 106,08



PRATO PORC FUNDO QUAD BCO 24CM 7500 6X1
Código: Fábrika: Unidade:
35060 CHEF LINE PT/6
F1 F4

UN: R\$ 10,77 AV: R\$ 64,63 15: R\$ 65,97
30: R\$ 67,29 45: R\$ 68,64 60: R\$ 70,01



PRATO PORC FUNDO RED BCO 24CM 7504 6X1
Código: Fábrika: Unidade:
35058 CHEF LINE PT/6
F1 F4

UN: R\$ 25,92 AV: R\$ 155,50 15: R\$ 158,74
30: R\$ 161,91 45: R\$ 165,15 60: R\$ 168,45

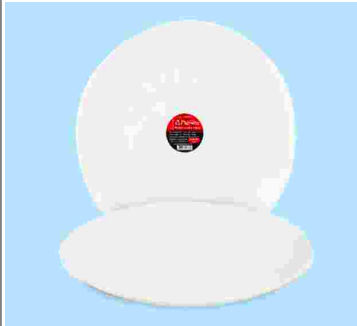

PRATO VIDRO RASO RED BCO 26,67CM 631 6X1
Código: Fábrika: Unidade:
48680 PLANETA CX/6
F1 F4

UN: R\$ 5,99 AV: R\$ 23,96 15: R\$ 23,96
30: R\$ 23,96 45: R\$ 23,96 60: R\$ 23,96



PRATO VIDRO TRANSP FUNDO 22CM MILLY 4X1
Código: Fábrika: Unidade:
50167 WELLMIX CJ/4
F1 F4

UN: R\$ 0,19 AV: R\$ 2,29 15: R\$ 2,29
30: R\$ 2,29 45: R\$ 2,29 60: R\$ 2,29



PRENDEDOR ROUPAS MADEIRA 7CM 12X1
Código: Fábrika: Unidade:
23765 AGUIA BRANCA DZ/12
F1 F4

UN: R\$ 0,17 AV: R\$ 6,06 15: R\$ 6,19
30: R\$ 6,31 45: R\$ 6,44 60: R\$ 6,57



PRENDEDOR ROUPAS MADEIRA 7,2CM 36X1
Código: Fábrika: Unidade:
47001 PRENDE MAIS PT/36
F1 F4

UN: R\$ 0,29 AV: R\$ 3,43 15: R\$ 3,50
30: R\$ 3,57 45: R\$ 3,64 60: R\$ 3,71



PRENDEDOR ROUPAS MADEIRA 9CM 12X1
Código: Fábrika: Unidade:
47000 PRENDE MAIS DZ/12
F1 F4

UN: R\$ 0,26 AV: R\$ 78,33 15: R\$ 79,96
30: R\$ 81,56 45: R\$ 83,19 60: R\$ 84,85



PRENDEDOR ROUPAS PLAST GDE 25X12
Código: Fábrika: Unidade:
41238 POLICORDA PT/300
F1 F4

UN: R\$ 0,90 AV: R\$ 10,76 15: R\$ 10,99
30: R\$ 11,21 45: R\$ 11,43 60: R\$ 11,66



PRENDEDOR ROUPAS PLAST 7CM 12X1 49 A
Código: Fábrika: Unidade:
27432 DEBIASI DZ/12
F1 F4

UN: R\$ 0,30 AV: R\$ 3,56 15: R\$ 3,64
30: R\$ 3,71 45: R\$ 3,79 60: R\$ 3,86



PRENDEDOR ROUPAS PLAST 8,5CM 12X1
Código: Fábrika: Unidade:
24652 PRENDE MAIS DZ/12
F1 F4

UN: R\$ 19,82 AV: R\$ 19,82 15: R\$ 20,23
30: R\$ 20,64 45: R\$ 21,05 60: R\$ 21,47



PREPARO P/ORQUÍDEAS 1KG
Código: Fábrika: Unidade:
32771 VITAPLAN UN/1
F1 F4

UN: R\$ 14,68 AV: R\$ 14,68 15: R\$ 14,98
30: R\$ 15,28 45: R\$ 15,59 60: R\$ 15,90



PROCESSADOR PLAST ALIMENTOS MANUAL 200ML
Código: Fábrika: Unidade:
44518 NICOBEM UN/1
F1 F4

UN: R\$ 24,47 AV: R\$ 24,47 15: R\$ 24,98
30: R\$ 25,48 45: R\$ 25,99 60: R\$ 26,51



PROCESSADOR PLAST ALIMENTOS MANUAL 450ML
Código: Fábrika: Unidade:
39793 HAI BRASIL UN/1
F1 F4

UN: R\$ 16,89 AV: R\$ 16,89 15: R\$ 17,24
30: R\$ 17,59 45: R\$ 17,94 60: R\$ 18,30



PROCESSADOR PLAST ALIMENTOS MANUAL 500ML
Código: Fábrika: Unidade:
40342 PLANETA UN/1
F1 F4

UN: R\$ 17,62 AV: R\$ 17,62 15: R\$ 17,98
30: R\$ 18,34 45: R\$ 18,71 60: R\$ 19,08



PROCESSADOR PLAST ALIMENTOS MANUAL 500ML
Código: Fábrika: Unidade:
49651 WINCY UN/1
F1 F4

UN: R\$ 15,99 AV: R\$ 15,99 15: R\$ 15,99
30: R\$ 15,99 45: R\$ 15,99 60: R\$ 15,99



PROCESSADOR PLAST ALIMENTOS MANUAL 500ML
Código: Fábrika: Unidade:
50138 GP6 UN/1
F1 F4

UN: R\$ 56,78 AV: R\$ 56,78 15: R\$ 57,97
30: R\$ 59,13 45: R\$ 60,31 60: R\$ 61,51



PROCESSADOR PLAST ALIMENTOS USB 220ML779
Código: Fábrika: Unidade:
41598 EMILAR UN/1
F1 F4

UN: R\$ 16,45 AV: R\$ 16,45 15: R\$ 16,79
30: R\$ 17,13 45: R\$ 17,47 60: R\$ 17,82



PULVERIZADOR BOMBA FLITZ 3267
Código: Fábrika: Unidade:
50967 FGB UN/1
F1 F4

UN: R\$ 74,42 AV: R\$ 74,42 15: R\$ 75,97
30: R\$ 77,49 45: R\$ 79,04 60: R\$ 80,62



PULVERIZADOR DE COMPRESSAO PREVIA 1,2 LT
Código: Fábrika: Unidade:
38649 GUARANY UN/1
F1 F4

UN: R\$ 7,44 AV: R\$ 7,44 15: R\$ 7,60
30: R\$ 7,75 45: R\$ 7,90 60: R\$ 8,06



PULVERIZADOR PET PLAST 500ML TRANSP 7631
Código: Fábrika: Unidade:
47358 ALTIHOME UN/1
F1 F4

UN: R\$ 7,00 AV: R\$ 7,00 15: R\$ 7,15
30: R\$ 7,29 45: R\$ 7,44 60: R\$ 7,58



PULVERIZADOR PLAST P/GARRAFA PET 4017
Código: Fábrika: Unidade:
50146 GP6 UN/1
F1 F4

UN: R\$ 6,51 AV: R\$ 6,51 15: R\$ 6,65
30: R\$ 6,78 45: R\$ 6,92 60: R\$ 7,05



PULVERIZADOR PLAST 300 ML DISPENSER 001
Código: Fábrika: Unidade:
49377 RIOHOME UN/1
F1 F4

UN: R\$ 8,75 AV: R\$ 8,75 15: R\$ 8,94
30: R\$ 9,12 45: R\$ 9,30 60: R\$ 9,48



PULVERIZADOR PLAST 350 ML QUALITY 843
Código: Fábrika: Unidade:
35831 LUMAR UN/1
F1 F4

UN: R\$ 9,59 AV: R\$ 9,59 15: R\$ 9,79
30: R\$ 9,98 45: R\$ 10,18 60: R\$ 10,39



PULVERIZADOR PLAST 450 ML QUALITY 842
Código: Fábrika: Unidade:
35832 LUMAR UN/1
F1 F4

UN: R\$ 6,18 AV: R\$ 6,18 15: R\$ 6,31
30: R\$ 6,43 45: R\$ 6,56 60: R\$ 6,69



PULVERIZADOR PLAST 500 ML TRANSP 5028
Código: Fábrika: Unidade:
39375 ARBRA UN/1
F1 F4

UN: R\$ 12,99 AV: R\$ 12,99 15: R\$ 13,26
30: R\$ 13,53 45: R\$ 13,80 60: R\$ 14,08



PULVERIZADOR PLAST 500 ML VERDE
Código: Fábrika: Unidade:
37222 NUTRIPLAN UN/1
F1 F4

UN: R\$ 6,84 AV: R\$ 6,84 15: R\$ 6,99
30: R\$ 7,13 45: R\$ 7,27 60: R\$ 7,41



PULVERIZADOR PLAST 500ML TRANSP 35654
Código: Fábrika: Unidade:
44098 NOBRE UN/1
F1 F4

UN: R\$ 13,02 AV: R\$ 13,02 15: R\$ 13,29
30: R\$ 13,56 45: R\$ 13,83 60: R\$ 14,11



PULVERIZADOR PLAST 550 ML GIRAFA 430150
Código: Fábrika: Unidade:
38894 PLASDURAN UN/1
F1 F4

UN: R\$ 14,00 AV: R\$ 14,00 15: R\$ 14,29
30: R\$ 14,58 45: R\$ 14,87 60: R\$ 15,17



PULVERIZADOR PLAST 580 ML AZUL
Código: Fábrika: Unidade:
18503 NUTRIPLAN UN/1
F1 F4

UN: R\$ 11,64 AV: R\$ 11,64 15: R\$ 11,89
30: R\$ 12,12 45: R\$ 12,37 60: R\$ 12,61



PULVERIZADOR PLAST 750 ML QUALITY 847
Código: Fábrika: Unidade:
35835 LUMAR UN/1
F1 F4

UN: R\$ 9,78 AV: R\$ 9,78 15: R\$ 9,99
30: R\$ 10,19 45: R\$ 10,39 60: R\$ 10,60



PUXA SACO
Código: Fábrika: Unidade:
11337 MC PANOS UN/1
F1 F4

UN: R\$ 2,54 AV: R\$ 2,54 15: R\$ 2,59
30: R\$ 2,64 45: R\$ 2,69 60: R\$ 2,75

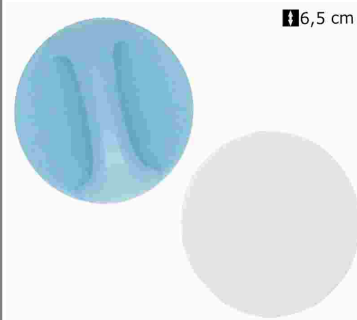

PUXADOR PLAST AUTO COLANTE 6,5CM 106-9
Código: Fábrika: Unidade:
44520 NICOBEM UN/1
F1 F4

UN: R\$ 9,60 AV: R\$ 9,60 15: R\$ 9,80
30: R\$ 9,99 45: R\$ 10,19 60: R\$ 10,40



PUXADOR P/TAMPA DE PANELA 105753113 2X1
Código: Fábrica: Unidade:
33444 MAXPING UN/1
F1 F4

UN: R\$ 23,49 AV: R\$ 23,49 15: R\$ 23,98
30: R\$ 24,46 45: R\$ 24,95 60: R\$ 25,45

1146 cm
38 cm



QUADRO PL PAINEL 1 PINUS 3004
Código: Fábrica: Unidade:
37163 PAIOL UN/1
F1 F4

UN: R\$ 27,41 AV: R\$ 27,41 15: R\$ 27,98
30: R\$ 28,54 45: R\$ 29,11 60: R\$ 29,69

1157 cm
46 cm



QUADRO PL PAINEL 2 PINUS 3005
Código: Fábrica: Unidade:
37164 PAIOL UN/1
F1 F4

UN: R\$ 29,37 AV: R\$ 29,37 15: R\$ 29,98
30: R\$ 30,58 45: R\$ 31,19 60: R\$ 31,81

1163 cm
57 cm



QUADRO PL PAINEL 3 PINUS 3006
Código: Fábrica: Unidade:
37165 PAIOL UN/1
F1 F4

UN: R\$ 39,16 AV: R\$ 39,16 15: R\$ 39,97
30: R\$ 40,77 45: R\$ 41,59 60: R\$ 42,42

1193 cm
39 cm



QUADRO PL PAINEL 4 PINUS 3007
Código: Fábrica: Unidade:
37166 PAIOL UN/1
F1 F4

UN: R\$ 47,00 AV: R\$ 47,00 15: R\$ 47,98
30: R\$ 48,94 45: R\$ 49,92 60: R\$ 50,92

11115 cm
46 cm



QUADRO PL PAINEL 5 PINUS 3008
Código: Fábrica: Unidade:
37167 PAIOL UN/1
F1 F4

UN: R\$ 34,26 AV: R\$ 34,26 15: R\$ 34,98
30: R\$ 35,68 45: R\$ 36,39 60: R\$ 37,12

1138 cm
40 cm

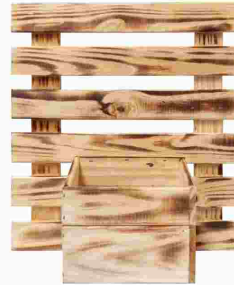

QUADRO PL 1 CRISANTEMO PINUS ENV 3201-2
Código: Fábrica: Unidade:
37162 PAIOL UN/1
F1 F4

UN: R\$ 34,26 AV: R\$ 34,26 15: R\$ 34,98
30: R\$ 35,68 45: R\$ 36,39 60: R\$ 37,12

1140 cm
37,5 cm

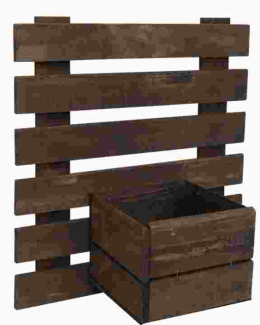

QUADRO PL 1 CRISANTEMO PINUS PINT 3201-1
Código: Fábrica: Unidade:
39469 PAIOL UN/1
F1 F4

UN: R\$ 30,35 AV: R\$ 30,35 15: R\$ 30,98
30: R\$ 31,60 45: R\$ 32,23 60: R\$ 32,87

1133 cm
28 cm

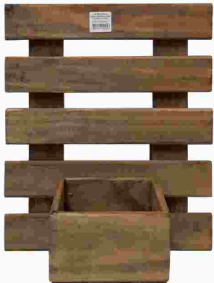

QUADRO PL 1 VIOLETA PINOS PINTADO 0024-1
Código: Fábrica: Unidade:
37156 PAIOL UN/1
F1 F4

UN: R\$ 30,35 AV: R\$ 30,35 15: R\$ 30,98
30: R\$ 31,60 45: R\$ 32,23 60: R\$ 32,87

1133 cm
28 cm

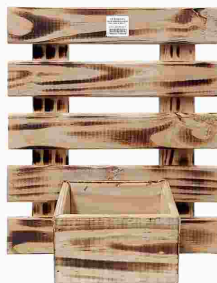

QUADRO PL 1 VIOLETA PINUS ENVELHEC 0024-2
Código: Fábrica: Unidade:
37155 PAIOL UN/1
F1 F4

UN: R\$ 38,18 AV: R\$ 38,18 15: R\$ 38,97
30: R\$ 39,75 45: R\$ 40,55 60: R\$ 41,36

1147 cm
43 cm



QUADRO PL 2 CRISANTEMO PINUS ENV 3200-2
Código: Fábrica: Unidade:
37161 PAIOL UN/1
F1 F4

UN: R\$ 38,18 AV: R\$ 38,18 15: R\$ 38,97
30: R\$ 39,75 45: R\$ 40,55 60: R\$ 41,36

1147 cm
43 cm



QUADRO PL 2 CRISANTEMO PINUS PINT 3200-1
Código: Fábrica: Unidade:
37957 PAIOL UN/1
F1 F4

UN: R\$ 32,30 AV: R\$ 32,30 15: R\$ 32,98
30: R\$ 33,64 45: R\$ 34,31 60: R\$ 35,00

1140 cm
38 cm

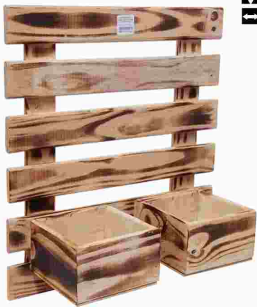

QUADRO PL 2 VIOLETAS PINUS ENVELHEC 26-1
Código: Fábrica: Unidade:
37158 PAIOL UN/1
F1 F4

UN: R\$ 32,30 AV: R\$ 32,30 15: R\$ 32,98
30: R\$ 33,64 45: R\$ 34,31 60: R\$ 35,00

1140 cm
38 cm



QUADRO PL 2 VIOLETAS PINUS PINTADO 26-2
Código: Fábrica: Unidade:
37157 PAIOL UN/1
F1 F4

UN: R\$ 34,26 AV: R\$ 34,26 15: R\$ 34,98
30: R\$ 35,68 45: R\$ 36,39 60: R\$ 37,12

1140 cm
47 cm



QUADRO PL 3 VIOLETAS PINUS ENVELHEC 23-2
Código: Fábrica: Unidade:
37159 PAIOL UN/1
F1 F4

UN: R\$ 14,68 AV: R\$ 14,68 15: R\$ 14,98
30: R\$ 15,28 45: R\$ 15,59 60: R\$ 15,90

22cm



QUEIJEIRA PLAST 0027
Código: Fábrica: Unidade:
4269 JAGUAR UN/1
F1 F4

UN: R\$ 33,28 AV: R\$ 33,28 15: R\$ 33,98
30: R\$ 34,66 45: R\$ 35,35 60: R\$ 36,06



RALADOR INOX 6 FACES CB PLAST BRANCO 59
Código: Fábrika: Unidade:
46584 HERCULES UN/1
F1 F4

UN: R\$ 6,92 AV: R\$ 6,92 15: R\$ 7,07
30: R\$ 7,21 45: R\$ 7,35 60: R\$ 7,50



RALADOR 1 FACE INOX 25CM 062
Código: Fábrika: Unidade:
47327 NIX UN/1
F1 F4

UN: R\$ 11,74 AV: R\$ 11,74 15: R\$ 11,99
30: R\$ 12,22 45: R\$ 12,47 60: R\$ 12,72



RALADOR 4 FACES FLANDRES CB PLAST 3201
Código: Fábrika: Unidade:
38331 VIEL UN/1
F1 F4

UN: R\$ 2,93 AV: R\$ 2,93 15: R\$ 2,99
30: R\$ 3,05 45: R\$ 3,11 60: R\$ 3,17

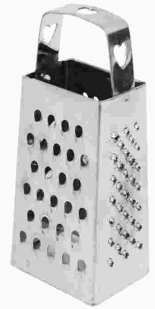

RALADOR 4 FACES INOX MINI 14713
Código: Fábrika: Unidade:
46493 NICOBEM UN/1
F1 F4

UN: R\$ 10,27 AV: R\$ 10,27 15: R\$ 10,49
30: R\$ 10,70 45: R\$ 10,91 60: R\$ 11,13

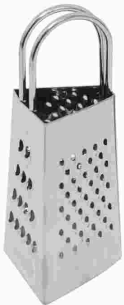

RALADOR 4 FACES INOX MINI 8CM 272
Código: Fábrika: Unidade:
48681 PLANETA UN/1
F1 F4

UN: R\$ 7,33 AV: R\$ 7,33 15: R\$ 7,49
30: R\$ 7,64 45: R\$ 7,79 60: R\$ 7,95



RALADOR 4 FACES PLAST 732
Código: Fábrika: Unidade:
35845 LUMAR UN/1
F1 F4

UN: R\$ 20,55 AV: R\$ 20,55 15: R\$ 20,98
30: R\$ 21,40 45: R\$ 21,83 60: R\$ 22,27



RALADOR 6 FACES INOX 22CM CB METAL 12946
Código: Fábrika: Unidade:
41290 GP6 UN/1
F1 F4

UN: R\$ 1,75 AV: R\$ 1,75 15: R\$ 1,79
30: R\$ 1,83 45: R\$ 1,86 60: R\$ 1,90



RALINHO INOX P/PIA 5,2CM CTL 348
Código: Fábrika: Unidade:
44502 PLANETA CR/1
F1 F4

UN: R\$ 3,91 AV: R\$ 3,91 15: R\$ 3,99
30: R\$ 4,07 45: R\$ 4,15 60: R\$ 4,23



RALINHO INOX P/PIA 5,5CM CTL 4472
Código: Fábrika: Unidade:
49630 WINMAX CR/1
F1 F4

UN: R\$ 1,47 AV: R\$ 17,62 15: R\$ 17,98
30: R\$ 18,34 45: R\$ 18,71 60: R\$ 19,08



RALINHO TELA GALV P/PIA 4,5 CM 1011 12X1
Código: Fábrika: Unidade:
13446 JWC DZ/12
F1 F4

UN: R\$ 2,04 AV: R\$ 24,47 15: R\$ 24,98
30: R\$ 25,48 45: R\$ 25,99 60: R\$ 26,51



RALINHO TELA GALV P/PIA 7 CM G 1010 12X1
Código: Fábrika: Unidade:
25222 JWC DZ/12
F1 F4

UN: R\$ 4,70 AV: R\$ 4,70 15: R\$ 4,80
30: R\$ 4,89 45: R\$ 4,99 60: R\$ 5,09



RALO INOX P/PIA 7CM CTL MG-2984
Código: Fábrika: Unidade:
40303 MEGAGIFT CR/1
F1 F4

UN: R\$ 35,74 AV: R\$ 35,74 15: R\$ 36,49
30: R\$ 37,22 45: R\$ 37,96 60: R\$ 38,72



RALO OCULTO SIFONADO 150X150MM BEGE
Código: Fábrika: Unidade:
48608 REBOUCAS UN/1
F1 F4

UN: R\$ 35,24 AV: R\$ 35,24 15: R\$ 35,98
30: R\$ 36,70 45: R\$ 37,43 60: R\$ 38,18



RALO OCULTO SIFONADO 150X150MM BRANCO
Código: Fábrika: Unidade:
48604 REBOUCAS UN/1
F1 F4

UN: R\$ 35,74 AV: R\$ 35,74 15: R\$ 36,49
30: R\$ 37,22 45: R\$ 37,96 60: R\$ 38,72

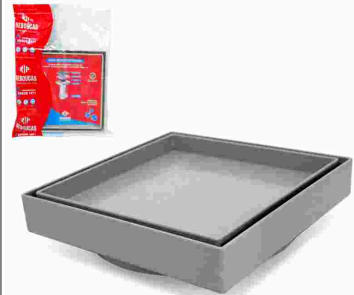

RALO OCULTO SIFONADO 150X150MM CINZA
Código: Fábrika: Unidade:
48606 REBOUCAS UN/1
F1 F4

UN: R\$ 35,74 AV: R\$ 35,74 15: R\$ 36,49
30: R\$ 37,22 45: R\$ 37,96 60: R\$ 38,72



RALO OCULTO SIFONADO 150X150MM MARROM
Código: Fábrika: Unidade:
48607 REBOUCAS UN/1
F1 F4

UN: R\$ 35,24 AV: R\$ 35,24 15: R\$ 35,98
30: R\$ 36,70 45: R\$ 37,43 60: R\$ 38,18



RALO OCULTO SIFONADO 150X150MM PRETO
Código: Fábrica: Unidade:
48605 REBOUCAS UN/1
F1 F4

UN: R\$ 17,62 AV: R\$ 17,62 15: R\$ 17,98
30: R\$ 18,34 45: R\$ 18,71 60: R\$ 19,08



REFRESQUEIRA ALUM LEVE 14 1,2 LTS
Código: Fábrica: Unidade:
5894 AVELAR UN/1
F1 F4

UN: R\$ 44,36 AV: R\$ 44,36 15: R\$ 45,28
30: R\$ 46,19 45: R\$ 47,11 60: R\$ 48,05
17 cm



REGADOR ALUM MEDIO 600 ML 648
Código: Fábrica: Unidade:
39542 BMC ALUMINIO UN/1
F1 F4

UN: R\$ 13,70 AV: R\$ 13,70 15: R\$ 13,98
30: R\$ 14,26 45: R\$ 14,55 60: R\$ 14,84



REGADOR PLAST 5 LTS RECICL VERDE 7006
Código: Fábrica: Unidade:
49519 ARBRA UN/1
F1 F4

UN: R\$ 21,79 AV: R\$ 21,79 15: R\$ 22,24
30: R\$ 22,69 45: R\$ 23,14 60: R\$ 23,60



REGADOR PLAST 8 LTS RECICL PRETO 7004
Código: Fábrica: Unidade:
9513 ARBRA UN/1
F1 F4

UN: R\$ 21,79 AV: R\$ 21,79 15: R\$ 22,24
30: R\$ 22,69 45: R\$ 23,14 60: R\$ 23,60
35 cm
8 lts



REGADOR PLAST 8 LTS RECICL VERDE 7005
Código: Fábrica: Unidade:
39373 ARBRA UN/1
F1 F4

UN: R\$ 15,34 AV: R\$ 15,34 15: R\$ 15,66
30: R\$ 15,98 45: R\$ 16,30 60: R\$ 16,62
20 cm
37 cm



REGADOR PLAST PEQ 1,5LT C/CHUVEIRO LILAS
Código: Fábrica: Unidade:
46044 NUTRIPLAN UN/1
F1 F4

UN: R\$ 15,34 AV: R\$ 15,34 15: R\$ 15,66
30: R\$ 15,98 45: R\$ 16,30 60: R\$ 16,62
20 cm
37 cm



REGADOR PLAST PEQ 1,5LT C/CHUVEIRO ROSA
Código: Fábrica: Unidade:
46043 NUTRIPLAN UN/1
F1 F4

UN: R\$ 22,51 AV: R\$ 22,51 15: R\$ 22,98
30: R\$ 23,44 45: R\$ 23,91 60: R\$ 24,39



REGADOR PLAST 10 LTS RECICL PRETO 7001
Código: Fábrica: Unidade:
49518 ARBRA UN/1
F1 F4

UN: R\$ 22,03 AV: R\$ 22,03 15: R\$ 22,49
30: R\$ 22,94 45: R\$ 23,40 60: R\$ 23,87
35 cm
66 cm
10 L



REGADOR PLAST 10 LTS RECICL VERDE 7002
Código: Fábrica: Unidade:
44981 ARBRA UN/1
F1 F4

UN: R\$ 8,81 AV: R\$ 105,74 15: R\$ 107,95
30: R\$ 110,11 45: R\$ 112,31 60: R\$ 114,55



REGISTRO PRESSAO PVC BCO C/VOL 51N 12X1
Código: Fábrica: Unidade:
40159 REBOUCAS PT/12
F1 F4

UN: R\$ 9,79 AV: R\$ 117,49 15: R\$ 119,94
30: R\$ 122,34 45: R\$ 124,79 60: R\$ 127,28



REGISTRO PRESSAO PVC BCO C/VOL 52N 12X1
Código: Fábrica: Unidade:
40158 REBOUCAS PT/12
F1 F4

UN: R\$ 9,03 AV: R\$ 108,42 15: R\$ 110,68
30: R\$ 112,89 45: R\$ 115,15 60: R\$ 117,45



REGISTRO PRESSAO PVC BCO C/VOL 53N 12X1
Código: Fábrica: Unidade:
40157 REBOUCAS PT/12
F1 F4

UN: R\$ 9,79 AV: R\$ 117,50 15: R\$ 119,95
30: R\$ 122,35 45: R\$ 124,80 60: R\$ 127,29



REGISTRO PRESSAO PVC BCO C/VOL 54N 12X1
Código: Fábrica: Unidade:
40162 REBOUCAS PT/12
F1 F4

UN: R\$ 8,81 AV: R\$ 105,74 15: R\$ 107,95
30: R\$ 110,11 45: R\$ 112,31 60: R\$ 114,55



REGISTRO PRESSAO PVC MARR C/VOL 55N 12X1
Código: Fábrica: Unidade:
40160 REBOUCAS PT/12
F1 F4

UN: R\$ 9,79 AV: R\$ 117,49 15: R\$ 119,94
30: R\$ 122,34 45: R\$ 124,79 60: R\$ 127,28



REGISTRO PRESSAO PVC MARR C/VOL 56N 12X1
Código: Fábrica: Unidade:
40161 REBOUCAS PT/12
F1 F4

UN: R\$ 48,95 AV: R\$ 48,95 15: R\$ 49,97
30: R\$ 50,97 45: R\$ 51,99 60: R\$ 53,03



REGULADOR GAS 1KG COMPLETO 14400 163
Código: 47760 Fábrica: VINIGAS Unidade: UN/1 F1 F4

UN: R\$ 31,32 AV: R\$ 31,32 15: R\$ 31,98
30: R\$ 32,62 45: R\$ 33,27 60: R\$ 33,93



REGULADOR GAS 1KG C/REGISTRO 14300 162
Código: 47882 Fábrica: VINIGAS Unidade: UN/1 F1 F4

UN: R\$ 1,85 AV: R\$ 1,85 15: R\$ 1,89
30: R\$ 1,93 45: R\$ 1,97 60: R\$ 2,00



RODINHO DE PIA CABO MADEIRA 37
Código: 6293 Fábrica: N.HORIZONTE Unidade: UN/1 F1 F4

UN: R\$ 3,46 AV: R\$ 3,46 15: R\$ 3,53
30: R\$ 3,60 45: R\$ 3,67 60: R\$ 3,74



RODINHO DE PIA CABO PLAST 83
Código: 48937 Fábrica: N.HORIZONTE Unidade: UN/1 F1 F4

UN: R\$ 2,73 AV: R\$ 2,73 15: R\$ 2,79
30: R\$ 2,84 45: R\$ 2,90 60: R\$ 2,96



RODINHO PLAST PIA COLOR 744
Código: 44085 Fábrica: QUALYPLAS Unidade: UN/1 F1 F4

UN: R\$ 16,99 AV: R\$ 16,99 15: R\$ 17,34
30: R\$ 17,69 45: R\$ 18,04 60: R\$ 18,40



RODIZIO METAL E PLAST GIRATORIO C/FREIO
Código: 50834 Fábrica: GP6 Unidade: UN/1 F1 F4

UN: R\$ 48,95 AV: R\$ 48,95 15: R\$ 49,97
30: R\$ 50,97 45: R\$ 51,99 60: R\$ 53,03



RODO ALUM 40 CM C/CABO ALUM
Código: 50913 Fábrica: SANCHES Unidade: UN/1 F1 F4

UN: R\$ 58,74 AV: R\$ 58,74 15: R\$ 59,97
30: R\$ 61,17 45: R\$ 62,39 60: R\$ 63,64



RODO ALUM 60 CM C/CABO ALUM
Código: 50631 Fábrica: SANCHES Unidade: UN/1 F1 F4

UN: R\$ 13,15 AV: R\$ 13,15 15: R\$ 13,42
30: R\$ 13,69 45: R\$ 13,97 60: R\$ 14,25



RODO FIORY 30CM CM C/CABO MADEIRA UN
Código: 47252 Fábrica: SHANGRILA Unidade: UN/1 F1 F4

UN: R\$ 14,94 AV: R\$ 14,94 15: R\$ 15,25
30: R\$ 15,56 45: R\$ 15,87 60: R\$ 16,19



RODO FIORY 40CM CM C/CABO MADEIRA UN
Código: 47253 Fábrica: SHANGRILA Unidade: UN/1 F1 F4

UN: R\$ 22,81 AV: R\$ 22,81 15: R\$ 23,28
30: R\$ 23,75 45: R\$ 24,22 60: R\$ 24,71



RODO FIORY 60CM CM C/CABO MADEIRA UN
Código: 47254 Fábrica: SHANGRILA Unidade: UN/1 F1 F4

UN: R\$ 7,18 AV: R\$ 86,17 15: R\$ 87,96
30: R\$ 89,72 45: R\$ 91,52 60: R\$ 93,35



RODO MADEIRA 30CM 2700 12X1
Código: 37977 Fábrica: DALCIN Unidade: PT/12 F1 F4

UN: R\$ 21,05 AV: R\$ 21,05 15: R\$ 21,49
30: R\$ 21,92 45: R\$ 22,36 60: R\$ 22,81



RODO PLAST P/LIMPAR VIDRO 30X26CM 110-19
Código: 40659 Fábrica: CASA ONZE Unidade: UN/1 F1 F4

UN: R\$ 11,60 AV: R\$ 139,21 15: R\$ 142,11
30: R\$ 144,96 45: R\$ 147,85 60: R\$ 150,81



RODO PLAST PUXA SECA 30CM C/CB 5109 12X1
Código: 49814 Fábrica: EDS Unidade: PT/12 F1 F4

UN: R\$ 16,15 AV: R\$ 16,15 15: R\$ 16,48
30: R\$ 16,81 45: R\$ 17,15 60: R\$ 17,49



RODO PLAST PUXA SECA 60 CM C/CABO 5123
Código: 49808 Fábrica: EDS Unidade: UN/1 F1 F4

UN: R\$ 15,07 AV: R\$ 15,07 15: R\$ 15,38
30: R\$ 15,69 45: R\$ 16,01 60: R\$ 16,33



RODO PLAST 60 CM C/CABO MAD 85
Código: 50234 Fábrica: HALLEY Unidade: UN/1 F1 F4

UN: R\$ 34,26 AV: R\$ 34,26 15: R\$ 34,98
30: R\$ 35,68 45: R\$ 36,39 60: R\$ 37,12

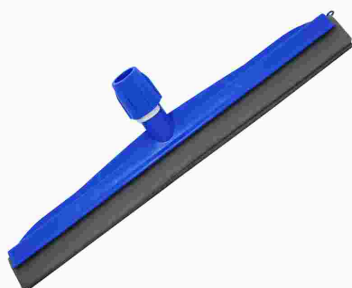

RODO 45CM DRY BRALIMPIA AZUL S/CABO
Código: Fábrica: Unidade:
46721 BRALIMPIA UN/1
F1 F4

UN: R\$ 26,93 AV: R\$ 26,93 15: R\$ 27,49
30: R\$ 28,04 45: R\$ 28,60 60: R\$ 29,17



ROLETE PLAST P/PAPEL HIGIENICO 1053 12X1
Código: Fábrica: Unidade:
33289 JWC PT/1
F1 F4

UN: R\$ 14,68 AV: R\$ 14,68 15: R\$ 14,98
30: R\$ 15,28 45: R\$ 15,59 60: R\$ 15,90



ROLO MADEIRA P/MASSA 107
Código: Fábrica: Unidade:
41319 MAD LAR UN/1
F1 F4

UN: R\$ 9,78 AV: R\$ 9,78 15: R\$ 9,99
30: R\$ 10,19 45: R\$ 10,39 60: R\$ 10,60



ROLO MADEIRA P/MASSA 4,5X40CM 083
Código: Fábrica: Unidade:
47900 CASITA UN/1
F1 F4

UN: R\$ 6,26 AV: R\$ 6,26 15: R\$ 6,39
30: R\$ 6,52 45: R\$ 6,65 60: R\$ 6,78



SABONETEIRA PET PLAST 500ML TRANSP 7632
Código: Fábrica: Unidade:
47359 ALTIHOME UN/1
F1 F4

UN: R\$ 3,46 AV: R\$ 3,46 15: R\$ 3,53
30: R\$ 3,60 45: R\$ 3,67 60: R\$ 3,74



SABONETEIRA PLAST C/TELA 605
Código: Fábrica: Unidade:
12167 JAGUAR UN/1
F1 F4

UN: R\$ 3,43 AV: R\$ 3,43 15: R\$ 3,50
30: R\$ 3,57 45: R\$ 3,64 60: R\$ 3,71



SACO P/LAVAR ROUPA 30X40CM 19006/15885
Código: Fábrica: Unidade:
36951 ALIANCA UN/1
F1 F4

UN: R\$ 20,55 AV: R\$ 20,55 15: R\$ 20,98
30: R\$ 21,40 45: R\$ 21,83 60: R\$ 22,27



SACOLA NYLON 20X38CM MARIA C/BOTAO
Código: Fábrica: Unidade:
27404 FERREIRA UN/1
F1 F4

UN: R\$ 21,53 AV: R\$ 21,53 15: R\$ 21,98
30: R\$ 22,42 45: R\$ 22,87 60: R\$ 23,33



SACOLA NYLON 24X36CM P UTIL C/ZIPER
Código: Fábrica: Unidade:
27401 FERREIRA UN/1
F1 F4

UN: R\$ 19,57 AV: R\$ 19,57 15: R\$ 19,98
30: R\$ 20,38 45: R\$ 20,79 60: R\$ 21,21



SACOLA NYLON 32X29CM TULIPA
Código: Fábrica: Unidade:
29114 FERREIRA UN/1
F1 F4

UN: R\$ 14,68 AV: R\$ 14,68 15: R\$ 14,98
30: R\$ 15,28 45: R\$ 15,59 60: R\$ 15,90



SACOLA NYLON 37X36CM ECONOMICA TRAD
Código: Fábrica: Unidade:
27402 FERREIRA UN/1
F1 F4

UN: R\$ 19,57 AV: R\$ 19,57 15: R\$ 19,98
30: R\$ 20,38 45: R\$ 20,79 60: R\$ 21,21



SACOLA NYLON 39X41CM M TRAD
Código: Fábrica: Unidade:
27400 FERREIRA UN/1
F1 F4

UN: R\$ 29,37 AV: R\$ 29,37 15: R\$ 29,98
30: R\$ 30,58 45: R\$ 31,19 60: R\$ 31,81



SACOLA NYLON 40X39CM FERREIRA
Código: Fábrica: Unidade:
27403 FERREIRA UN/1
F1 F4

UN: R\$ 0,38 AV: R\$ 38,24 15: R\$ 39,03
30: R\$ 39,82 45: R\$ 40,61 60: R\$ 41,42



SACOLA PLAST PRES 20X30CM ESTAMP 100X1
Código: Fábrica: Unidade:
49637 WINMAX PT/100
F1 F4

UN: R\$ 0,44 AV: R\$ 43,97 15: R\$ 44,88
30: R\$ 45,78 45: R\$ 46,70 60: R\$ 47,63



SACOLA PLAST PRES 25X35CM ESTAMP 100X1
Código: Fábrica: Unidade:
49638 WINMAX PT/100
F1 F4

UN: R\$ 0,52 AV: R\$ 51,70 15: R\$ 52,78
30: R\$ 53,83 45: R\$ 54,91 60: R\$ 56,01



SACOLA PLAST PRES 30X40CM ESTAMP 100X1
Código: Fábrica: Unidade:
49639 WINMAX PT/100
F1 F4

UN: R\$ 0,64 AV: R\$ 64,48 15: R\$ 65,82
30: R\$ 67,14 45: R\$ 68,48 60: R\$ 69,85



SACOLA PLAST PRES 35X45CM ESTAMP 100X1

Código: 49640 Fábrica: WINMAX Unidade: PT/100
F1 F4

UN: R\$ 0,87 AV: R\$ 87,44 15: R\$ 89,26
30: R\$ 91,05 45: R\$ 92,87 60: R\$ 94,73

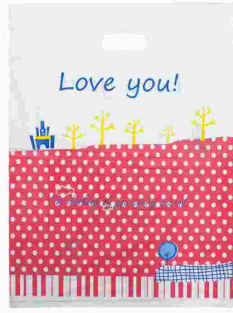

SACOLA PLAST PRES 40X50CM ESTAMP 100X1

Código: 49641 Fábrica: WINMAX Unidade: PT/100
F1 F4

UN: R\$ 13,70 AV: R\$ 13,70 15: R\$ 13,98
30: R\$ 14,26 45: R\$ 14,55 60: R\$ 14,84



SACOLA PLAST 45X50X20CM ESTAMP 150-11

Código: 42402 Fábrica: NICOBEM Unidade: UN/1
F1 F4

UN: R\$ 24,09 AV: R\$ 24,09 15: R\$ 24,59
30: R\$ 25,08 45: R\$ 25,58 60: R\$ 26,10

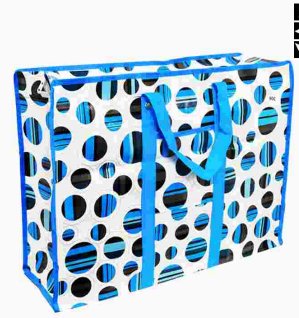

45cm
60cm
20cm

SACOLA PLAST 60X45X20CM ESTAMP 756

Código: 45911 Fábrica: WINMAX Unidade: UN/1
F1 F4

UN: R\$ 38,40 AV: R\$ 38,40 15: R\$ 39,20
30: R\$ 39,99 45: R\$ 40,79 60: R\$ 41,60



60cm
80cm
25cm

SACOLA PLAST 800X60X25CM ESTAMP 758

Código: 45912 Fábrica: WINMAX Unidade: UN/1
F1 F4

UN: R\$ 33,98 AV: R\$ 33,98 15: R\$ 34,69
30: R\$ 35,38 45: R\$ 36,09 60: R\$ 36,81



10 lts

SALADEIRA PLAST C/TAMPA GDE 10,0LTS 825

Código: 39560 Fábrica: LUMAR Unidade: UN/1
F1 F4

UN: R\$ 14,93 AV: R\$ 14,93 15: R\$ 15,24
30: R\$ 15,55 45: R\$ 15,86 60: R\$ 16,18



3 lts

SALADEIRA PLAST C/TAMPA GDE 3,0LTS 854

Código: 39558 Fábrica: LUMAR Unidade: UN/1
F1 F4

UN: R\$ 27,03 AV: R\$ 27,03 15: R\$ 27,59
30: R\$ 28,14 45: R\$ 28,70 60: R\$ 29,28



6 lts

SALADEIRA PLAST C/TAMPA GDE 6,0LTS 820

Código: 39559 Fábrica: LUMAR Unidade: UN/1
F1 F4

UN: R\$ 9,59 AV: R\$ 9,59 15: R\$ 9,79
30: R\$ 9,98 45: R\$ 10,18 60: R\$ 10,39



1 lts

SALADEIRA PLAST C/TAMPA MED 1,5LTS 853

Código: 39557 Fábrica: LUMAR Unidade: UN/1
F1 F4

UN: R\$ 6,51 AV: R\$ 6,51 15: R\$ 6,65
30: R\$ 6,78 45: R\$ 6,92 60: R\$ 7,05



0,8 lts

SALADEIRA PLAST C/TAMPA PEQ 800ML 852

Código: 39556 Fábrica: LUMAR Unidade: UN/1
F1 F4

UN: R\$ 7,63 AV: R\$ 7,63 15: R\$ 7,79
30: R\$ 7,94 45: R\$ 8,10 60: R\$ 8,26



SALADEIRA PLAST C/TPA ONDUL 2,6 LTS 42

Código: 49705 Fábrica: NOVA ERA Unidade: UN/1
F1 F4

UN: R\$ 7,38 AV: R\$ 7,38 15: R\$ 7,54
30: R\$ 7,69 45: R\$ 7,84 60: R\$ 8,00



SALADEIRA PLAST GDE S/TAMPA 25X10CM 1053

Código: 36962 Fábrica: ENGIPLAST Unidade: UN/1
F1 F4

UN: R\$ 4,69 AV: R\$ 4,69 15: R\$ 4,79
30: R\$ 4,88 45: R\$ 4,98 60: R\$ 5,08



SALADEIRA PLAST MED S/TAMPA 20X8CM 1052

Código: 36961 Fábrica: ENGIPLAST Unidade: UN/1
F1 F4

UN: R\$ 6,59 AV: R\$ 6,59 15: R\$ 6,73
30: R\$ 6,86 45: R\$ 7,00 60: R\$ 7,14



SALADEIRA PLAST PEQ C/TAMPA 15X6CM 1055

Código: 36957 Fábrica: ENGIPLAST Unidade: UN/1
F1 F4

UN: R\$ 3,07 AV: R\$ 3,07 15: R\$ 3,14
30: R\$ 3,20 45: R\$ 3,27 60: R\$ 3,33



SALADEIRA PLAST PEQ S/TAMPA 15X6CM 1051

Código: 36960 Fábrica: ENGIPLAST Unidade: UN/1
F1 F4

UN: R\$ 2,52 AV: R\$ 2,52 15: R\$ 2,57
30: R\$ 2,62 45: R\$ 2,67 60: R\$ 2,73



SALEIRO CRISTAL P/MESA 700

Código: 37260 Fábrica: LUMAR Unidade: UN/1
F1 F4

UN: R\$ 9,42 AV: R\$ 9,42 15: R\$ 9,62
30: R\$ 9,81 45: R\$ 10,00 60: R\$ 10,20



SALEIRO PLAST GRANDE 366

Código: Fábrika: Unidade:
10174 TRITEC UN/1
F1 F4

UN: R\$ 2,11 AV: R\$ 2,11 15: R\$ 2,15
30: R\$ 2,19 45: R\$ 2,24 60: R\$ 2,28



SANDUICHEIRA REF 1315

Código: Fábrika: Unidade:
11029 PLASUTIL UN/1
F1 F4

UN: R\$ 9,78 AV: R\$ 9,78 15: R\$ 9,99
30: R\$ 10,19 45: R\$ 10,39 60: R\$ 10,60

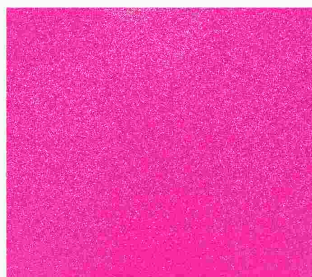

SELADORA PLAST 10X4CM PILHA AA 37-26

Código: Fábrika: Unidade:
46967 NICOBEM UN/1
F1 F4

UN: R\$ 2,35 AV: R\$ 58,74 15: R\$ 59,97
30: R\$ 61,17 45: R\$ 62,39 60: R\$ 63,64



SEMENTE ABOBORA HIROKO 550MG 25X1

Código: Fábrika: Unidade:
33984 FELTRIN PT/25
F1 F4

UN: R\$ 2,35 AV: R\$ 58,74 15: R\$ 59,97
30: R\$ 61,17 45: R\$ 62,39 60: R\$ 63,64

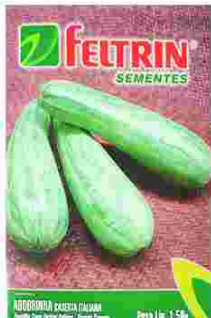

SEMENTE ABOBRINHA CASERT ITAL 1,50G 25X1

Código: Fábrika: Unidade:
31427 FELTRIN PT/25
F1 F4

UN: R\$ 2,35 AV: R\$ 58,74 15: R\$ 59,97
30: R\$ 61,17 45: R\$ 62,39 60: R\$ 63,64



SEMENTE ALFACE AMERICANA 700MG 25X1

Código: Fábrika: Unidade:
31435 FELTRIN PT/25
F1 F4

UN: R\$ 2,35 AV: R\$ 58,74 15: R\$ 59,97
30: R\$ 61,17 45: R\$ 62,39 60: R\$ 63,64



SEMENTE ALFACE MONICA 700MG 25X1

Código: Fábrika: Unidade:
31423 FELTRIN PT/25
F1 F4

UN: R\$ 2,35 AV: R\$ 58,74 15: R\$ 59,97
30: R\$ 61,17 45: R\$ 62,39 60: R\$ 63,64



SEMENTE ALMEIRAO PAO D ACUCAR 700MG 25X1

Código: Fábrika: Unidade:
31410 FELTRIN PT/25
F1 F4

UN: R\$ 2,35 AV: R\$ 58,74 15: R\$ 59,97
30: R\$ 61,17 45: R\$ 62,39 60: R\$ 63,64



SEMENTE BERINGELA EMBU 400MG 25X1

Código: Fábrika: Unidade:
32288 FELTRIN PT/25
F1 F4

UN: R\$ 2,35 AV: R\$ 58,74 15: R\$ 59,97
30: R\$ 61,17 45: R\$ 62,39 60: R\$ 63,64



SEMENTE BETERRABA KATRINA 1,20G 25X1

Código: Fábrika: Unidade:
31419 FELTRIN PT/25
F1 F4

UN: R\$ 2,35 AV: R\$ 58,74 15: R\$ 59,97
30: R\$ 61,17 45: R\$ 62,39 60: R\$ 63,64



SEMENTE CEBOLINHA NEBUKA 400MG 25X1

Código: Fábrika: Unidade:
31440 FELTRIN PT/25
F1 F4

UN: R\$ 2,35 AV: R\$ 58,74 15: R\$ 59,97
30: R\$ 61,17 45: R\$ 62,39 60: R\$ 63,64

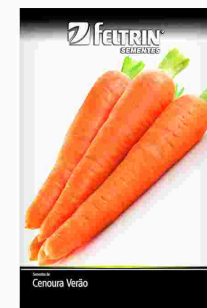

SEMENTE CENOURA BRASILIA IRECE 700G 25X1

Código: Fábrika: Unidade:
31413 FELTRIN PT/25
F1 F4

UN: R\$ 2,35 AV: R\$ 58,74 15: R\$ 59,97
30: R\$ 61,17 45: R\$ 62,39 60: R\$ 63,64



SEMENTE COENTRO PACIFICO 1,60G 25X1

Código: Fábrika: Unidade:
32283 FELTRIN PT/25
F1 F4

UN: R\$ 2,35 AV: R\$ 58,74 15: R\$ 59,97
30: R\$ 61,17 45: R\$ 62,39 60: R\$ 63,64



SEMENTE COENTRO VERDAO 1,6G 25X1

Código: Fábrika: Unidade:
31418 FELTRIN PT/25
F1 F4

UN: R\$ 2,35 AV: R\$ 58,74 15: R\$ 59,97
30: R\$ 61,17 45: R\$ 62,39 60: R\$ 63,64



SEMENTE COUVE MANTEIGA 1,00G 25X1

Código: Fábrika: Unidade:
31431 FELTRIN PT/25
F1 F4

UN: R\$ 2,35 AV: R\$ 58,74 15: R\$ 59,97
30: R\$ 61,17 45: R\$ 62,39 60: R\$ 63,64



SEMENTE JILO COMPRIDO GDE RIO 400MG 25X1

Código: Fábrika: Unidade:
32302 FELTRIN PT/25
F1 F4

UN: R\$ 2,35 AV: R\$ 58,74 15: R\$ 59,97
30: R\$ 61,17 45: R\$ 62,39 60: R\$ 63,64



SEMENTE MAMAO FORMOSA 120MG 25X1

Código: 31422 Fábrica: FELTRIN Unidade: PT/25 F1 F4

UN: R\$ 2,94 AV: R\$ 58,74 15: R\$ 59,97
30: R\$ 61,17 45: R\$ 62,39 60: R\$ 63,64



SEMENTE MELAO GAUCHO 100MG 20X1

Código: 32291 Fábrica: FELTRIN/HORT Unidade: PT/20 F1 F4

UN: R\$ 2,35 AV: R\$ 58,74 15: R\$ 59,97
30: R\$ 61,17 45: R\$ 62,39 60: R\$ 63,64



SEMENTE MORANGA EXPOSITAO 2,00G 25X1

Código: 31439 Fábrica: FELTRIN Unidade: PT/25 F1 F4

UN: R\$ 2,35 AV: R\$ 58,74 15: R\$ 59,97
30: R\$ 61,17 45: R\$ 62,39 60: R\$ 63,64



SEMENTE PIMENTA BICO 400MG 25X1

Código: 31429 Fábrica: FELTRIN Unidade: PT/25 F1 F4

UN: R\$ 2,35 AV: R\$ 58,74 15: R\$ 59,97
30: R\$ 61,17 45: R\$ 62,39 60: R\$ 63,64



SEMENTE PIMENTA CAYENNE LONG 400MG 25X1

Código: 32290 Fábrica: FELTRIN Unidade: PT/25 F1 F4

UN: R\$ 1,96 AV: R\$ 48,95 15: R\$ 49,97
30: R\$ 50,97 45: R\$ 51,99 60: R\$ 53,03



SEMENTE PIMENTA DEDO DE MOCA 400MG 25X1

Código: 49387 Fábrica: FELTRIN Unidade: PT/25 F1 F4

UN: R\$ 1,96 AV: R\$ 48,95 15: R\$ 49,97
30: R\$ 50,97 45: R\$ 51,99 60: R\$ 53,03



SEMENTE PIMENTAO AMARELO 400MG 25X1

Código: 49386 Fábrica: FELTRIN Unidade: PT/25 F1 F4

UN: R\$ 2,35 AV: R\$ 58,74 15: R\$ 59,97
30: R\$ 61,17 45: R\$ 62,39 60: R\$ 63,64



SEMENTE PIMENTAO RUBI GIGANTE 400MG 25X1

Código: 31412 Fábrica: FELTRIN Unidade: PT/25 F1 F4

UN: R\$ 2,35 AV: R\$ 58,74 15: R\$ 59,97
30: R\$ 61,17 45: R\$ 62,39 60: R\$ 63,64



SEMENTE QUIABO SANTA CRUZ 2,00G 25X1

Código: 31411 Fábrica: FELTRIN Unidade: PT/25 F1 F4

UN: R\$ 2,35 AV: R\$ 58,74 15: R\$ 59,97
30: R\$ 61,17 45: R\$ 62,39 60: R\$ 63,64



SEMENTE RABANETE CRIMSON GIG 1,40G 25X1

Código: 31432 Fábrica: FELTRIN Unidade: PT/25 F1 F4

UN: R\$ 2,35 AV: R\$ 58,74 15: R\$ 59,97
30: R\$ 61,17 45: R\$ 62,39 60: R\$ 63,64

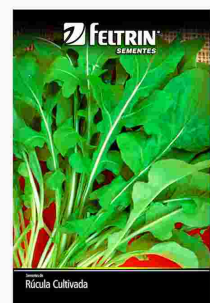

SEMENTE RUCULA CULTIVADA 1G 25X1

Código: 31424 Fábrica: FELTRIN Unidade: PT/25 F1 F4

UN: R\$ 2,35 AV: R\$ 58,74 15: R\$ 59,97
30: R\$ 61,17 45: R\$ 62,39 60: R\$ 63,64

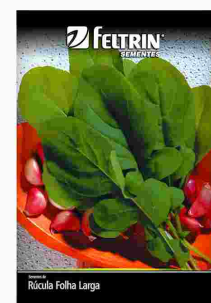

SEMENTE RUCULA FOLHA LARGA 700MG 25X1

Código: 32293 Fábrica: FELTRIN Unidade: PT/25 F1 F4

UN: R\$ 2,35 AV: R\$ 58,74 15: R\$ 59,97
30: R\$ 61,17 45: R\$ 62,39 60: R\$ 63,64



SEMENTE SALSA GRAUDA PORT NOV 900MG 25X1

Código: 31420 Fábrica: FELTRIN Unidade: PT/25 F1 F4

UN: R\$ 2,35 AV: R\$ 58,74 15: R\$ 59,97
30: R\$ 61,17 45: R\$ 62,39 60: R\$ 63,64



SEMENTE SALSA LISA 900MG 25X1

Código: 31434 Fábrica: FELTRIN Unidade: PT/25 F1 F4

UN: R\$ 2,35 AV: R\$ 58,74 15: R\$ 59,97
30: R\$ 61,17 45: R\$ 62,39 60: R\$ 63,64

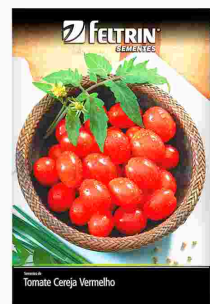

SEMENTE TOMATE CAROLINA 100MG 25X1

Código: 31416 Fábrica: FELTRIN Unidade: PT/25 F1 F4

UN: R\$ 2,35 AV: R\$ 58,74 15: R\$ 59,97
30: R\$ 61,17 45: R\$ 62,39 60: R\$ 63,64



SEMENTE TOMATE YASHI 100MG 25X1

Código: 35086 Fábrica: FELTRIN Unidade: PT/25 F1 F4

UN: R\$ 5,87 AV: R\$ 5,87 15: R\$ 5,99
30: R\$ 6,11 45: R\$ 6,23 60: R\$ 6,35



SOCADOR FEIJAO 28 CM MADEIRA 115

Código: Fábrica: Unidade:
1485 MAD LAR UN/1
F1 F4

UN: R\$ 6,06 AV: R\$ 6,06 15: R\$ 6,19
30: R\$ 6,31 45: R\$ 6,44 60: R\$ 6,57



SOLO (SUBSTRATO) 2 KG

Código: Fábrica: Unidade:
31469 NOVATROPICAL PT/1
F1 F4

UN: R\$ 10,06 AV: R\$ 10,06 15: R\$ 10,27
30: R\$ 10,47 45: R\$ 10,68 60: R\$ 10,89



SOLO (SUBSTRATO) 5 KG

Código: Fábrica: Unidade:
31470 NOVATROPICAL PT/1
F1 F4

UN: R\$ 29,37 AV: R\$ 29,37 15: R\$ 29,98
30: R\$ 30,58 45: R\$ 31,19 60: R\$ 31,81



SOLO (SUBSTRATO) 20 KG

Código: Fábrica: Unidade:
31472 NOVATROPICAL PT/1
F1 F4

UN: R\$ 4,89 AV: R\$ 4,89 15: R\$ 4,99
30: R\$ 5,09 45: R\$ 5,19 60: R\$ 5,29

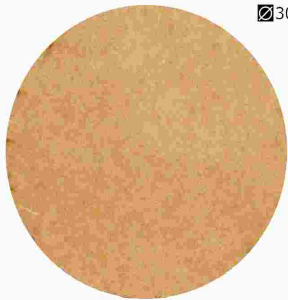

30cm

SOUPLA MDF 30CM 174

Código: Fábrica: Unidade:
45986 R A ARTESANA UN/1
F1 F4

UN: R\$ 5,18 AV: R\$ 5,18 15: R\$ 5,29
30: R\$ 5,39 45: R\$ 5,50 60: R\$ 5,61



SQUEEZE PLAST 300 ML (GALAOZINHO) 982

Código: Fábrica: Unidade:
49707 NOVA ERA UN/1
F1 F4

UN: R\$ 5,18 AV: R\$ 5,18 15: R\$ 5,29
30: R\$ 5,39 45: R\$ 5,50 60: R\$ 5,61



SQUEEZE PLAST 300 ML (GARRAFA) COLOR 972

Código: Fábrica: Unidade:
49719 NOVA ERA UN/1
F1 F4

UN: R\$ 4,02 AV: R\$ 4,02 15: R\$ 4,11
30: R\$ 4,19 45: R\$ 4,27 60: R\$ 4,36



SQUEEZE PLAST 350 ML 846

Código: Fábrica: Unidade:
35843 LUMAR UN/1
F1 F4

UN: R\$ 15,66 AV: R\$ 15,66 15: R\$ 15,98
30: R\$ 16,30 45: R\$ 16,63 60: R\$ 16,96



SQUEEZE PLAST 360ML REFIL FLAMENGO 10625

Código: Fábrica: Unidade:
41106 BRASFOOT UN/1
F1 F4

UN: R\$ 6,16 AV: R\$ 6,16 15: R\$ 6,29
30: R\$ 6,41 45: R\$ 6,54 60: R\$ 6,67



SQUEEZE PLAST 500 ML (GARRAFA) COLOR 962

Código: Fábrica: Unidade:
49712 NOVA ERA UN/1
F1 F4

UN: R\$ 6,26 AV: R\$ 6,26 15: R\$ 6,39
30: R\$ 6,52 45: R\$ 6,65 60: R\$ 6,78



SQUEEZE PLAST 600 ML (GARRAFA) QUAD 1199

Código: Fábrica: Unidade:
49706 NOVA ERA UN/1
F1 F4

UN: R\$ 6,26 AV: R\$ 6,26 15: R\$ 6,39
30: R\$ 6,52 45: R\$ 6,65 60: R\$ 6,78



SQUEEZE PLAST 750 ML (GARRAFA) COLOR 952

Código: Fábrica: Unidade:
49709 NOVA ERA UN/1
F1 F4

UN: R\$ 3,42 AV: R\$ 3,42 15: R\$ 3,49
30: R\$ 3,56 45: R\$ 3,63 60: R\$ 3,70



SQUEEZE 250 ML PLAST ARANHA 479

Código: Fábrica: Unidade:
41636 QUALYPLAS UN/1
F1 F4

UN: R\$ 3,42 AV: R\$ 3,42 15: R\$ 3,49
30: R\$ 3,56 45: R\$ 3,63 60: R\$ 3,70



SQUEEZE 250 ML PLAST COELHO 584

Código: Fábrica: Unidade:
41637 QUALYPLAS UN/1
F1 F4

UN: R\$ 3,42 AV: R\$ 3,42 15: R\$ 3,49
30: R\$ 3,56 45: R\$ 3,63 60: R\$ 3,70



SQUEEZE 250 ML PLAST DINOSSAURO 135/480

Código: Fábrica: Unidade:
41635 QUALYPLAS UN/1
F1 F4

UN: R\$ 3,42 AV: R\$ 3,42 15: R\$ 3,49
30: R\$ 3,56 45: R\$ 3,63 60: R\$ 3,70



SQUEEZE 250 ML PLAST DRAGAO 1202

Código: Fábrica: Unidade:
50341 QUALYPLAS UN/1
F1 F4

UN: R\$ 3,42 AV: R\$ 3,42 15: R\$ 3,49
30: R\$ 3,56 45: R\$ 3,63 60: R\$ 3,70



SQUEEZE 250 ML PLAST FROOZER 130/136

Código: Fábrika: Unidade:
41645 QALYPLAS UN/1
F1 F4

UN: R\$ 3,42 AV: R\$ 3,42 15: R\$ 3,49
30: R\$ 3,56 45: R\$ 3,63 60: R\$ 3,70



SQUEEZE 250 ML PLAST PRINCESA 1142

Código: Fábrika: Unidade:
50340 QALYPLAS UN/1
F1 F4

UN: R\$ 3,42 AV: R\$ 3,42 15: R\$ 3,49
30: R\$ 3,56 45: R\$ 3,63 60: R\$ 3,70



SQUEEZE 250 ML PLAST SEREIA 482

Código: Fábrika: Unidade:
41638 QALYPLAS UN/1
F1 F4

UN: R\$ 3,42 AV: R\$ 3,42 15: R\$ 3,49
30: R\$ 3,56 45: R\$ 3,63 60: R\$ 3,70



SQUEEZE 250 ML PLAST TUBARAO 138/485

Código: Fábrika: Unidade:
41640 QALYPLAS UN/1
F1 F4

UN: R\$ 3,42 AV: R\$ 3,42 15: R\$ 3,49
30: R\$ 3,56 45: R\$ 3,63 60: R\$ 3,70



SQUEEZE 250 ML PLAST UNICORNIO 483

Código: Fábrika: Unidade:
41639 QALYPLAS UN/1
F1 F4

UN: R\$ 3,42 AV: R\$ 3,42 15: R\$ 3,49
30: R\$ 3,56 45: R\$ 3,63 60: R\$ 3,70



SQUEEZE 250 ML PLAST VIDEO GAME 1141

Código: Fábrika: Unidade:
50342 QALYPLAS UN/1
F1 F4

UN: R\$ 7,39 AV: R\$ 7,39 15: R\$ 7,55
30: R\$ 7,70 45: R\$ 7,85 60: R\$ 8,01



SQUEEZE 600 ML PLAST NEON AZUL TPA CLICK

Código: Fábrika: Unidade:
49827 CREATIVE UN/1
F1 F4

UN: R\$ 7,39 AV: R\$ 7,39 15: R\$ 7,55
30: R\$ 7,70 45: R\$ 7,85 60: R\$ 8,01



SQUEEZE 600 ML PLAST NEON ROSA TPA CLICK

Código: Fábrika: Unidade:
49828 CREATIVE UN/1
F1 F4

UN: R\$ 7,10 AV: R\$ 7,10 15: R\$ 7,25
30: R\$ 7,39 45: R\$ 7,54 60: R\$ 7,69



SQUEEZE 700 ML PLAST DIAMANT FUME 22390

Código: Fábrika: Unidade:
49822 CREATIVE UN/1
F1 F4

UN: R\$ 7,10 AV: R\$ 7,10 15: R\$ 7,25
30: R\$ 7,39 45: R\$ 7,54 60: R\$ 7,69



SQUEEZE 700 ML PLAST DIAMANT TIFFAN 2391

Código: Fábrika: Unidade:
49823 CREATIVE UN/1
F1 F4

UN: R\$ 7,10 AV: R\$ 7,10 15: R\$ 7,25
30: R\$ 7,39 45: R\$ 7,54 60: R\$ 7,69



SQUEEZE 700 ML PLAST TOP TRANS FUME 2393

Código: Fábrika: Unidade:
49824 CREATIVE UN/1
F1 F4

UN: R\$ 7,10 AV: R\$ 7,10 15: R\$ 7,25
30: R\$ 7,39 45: R\$ 7,54 60: R\$ 7,69



SQUEEZE 700 ML PLAST TOP TRANS TIFFA 384

Código: Fábrika: Unidade:
49825 CREATIVE UN/1
F1 F4

UN: R\$ 7,10 AV: R\$ 7,10 15: R\$ 7,25
30: R\$ 7,39 45: R\$ 7,54 60: R\$ 7,69



SQUEEZE 700 ML PLAST TOP TRANS TPA COLOR

Código: Fábrika: Unidade:
49826 CREATIVE UN/1
F1 F4

UN: R\$ 21,20 AV: R\$ 21,20 15: R\$ 21,64
30: R\$ 22,07 45: R\$ 22,52 60: R\$ 22,97



SUPORTE A MED METAL DOURADO P/PLANTAS

Código: Fábrika: Unidade:
18493 NUTRIPLAN UN/1
F1 F4

UN: R\$ 26,43 AV: R\$ 26,43 15: R\$ 26,98
30: R\$ 27,52 45: R\$ 28,07 60: R\$ 28,63

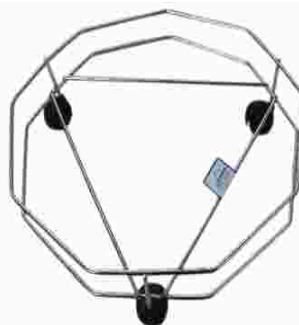

SUPORTE CROM BOTIJAO REFOR C/RODINHAS 21

Código: Fábrika: Unidade:
24069 ARAMINAS UN/1
F1 F4

UN: R\$ 37,20 AV: R\$ 37,20 15: R\$ 37,97
30: R\$ 38,73 45: R\$ 39,51 60: R\$ 40,30



SUPORTE CROM BOTIJAO TUBULAR C/ROD 799

Código: Fábrika: Unidade:
33634 ARAMINAS UN/1
F1 F4

UN: R\$ 23,08 AV: R\$ 23,08 15: R\$ 23,56
30: R\$ 24,03 45: R\$ 24,51 60: R\$ 25,00

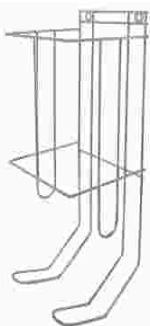

SUPORTE CROM P/PAPEL HIGIENICO 87

Código: Fábrika: Unidade:
28961 ARAMINAS UN/1
F1 F4

UN: R\$ 16,24 AV: R\$ 16,24 15: R\$ 16,58
30: R\$ 16,92 45: R\$ 17,25 60: R\$ 17,60

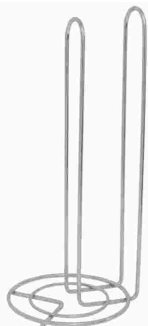

SUPORTE CROM P/PAPEL TOALHA DE MESA 89

Código: Fábrika: Unidade:
38982 ARAMINAS UN/1
F1 F4

UN: R\$ 28,10 AV: R\$ 28,10 15: R\$ 28,69
30: R\$ 29,26 45: R\$ 29,85 60: R\$ 30,44

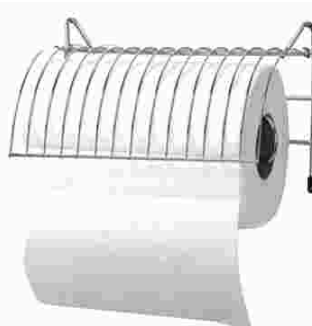

SUPORTE CROM P/PAPEL TOALHA PAREDE 22

Código: Fábrika: Unidade:
18739 ARAMINAS UN/1
F1 F4

UN: R\$ 44,80 AV: R\$ 44,80 15: R\$ 45,73
30: R\$ 46,65 45: R\$ 47,58 60: R\$ 48,53



SUPORTE CROM 20 COPOS PAREDE 52X30CM 28

Código: Fábrika: Unidade:
24068 ARAMINAS UN/1
F1 F4

Produto
* Altura: 52 cm
* Largura: 30 cm

UN: R\$ 34,26 AV: R\$ 34,26 15: R\$ 34,98
30: R\$ 35,68 45: R\$ 36,39 60: R\$ 37,12

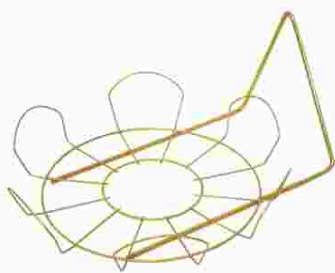

SUPORTE MARGARIDA MED DOURADO P/PLANTAS

Código: Fábrika: Unidade:
33397 NUTRIPLAN UN/1
F1 F4

UN: R\$ 107,70 AV: R\$ 107,70 15: R\$ 109,95
30: R\$ 112,14 45: R\$ 114,39 60: R\$ 116,68
30 cm



SUPORTE METAL RODIZIO PRATO 25CM PRETO

Código: Fábrika: Unidade:
42182 NUTRIPLAN UN/1
F1 F4

UN: R\$ 117,49 AV: R\$ 117,49 15: R\$ 119,94
30: R\$ 122,34 45: R\$ 124,79 60: R\$ 127,28
30 cm



SUPORTE METAL RODIZIO PRATO 28CM PRETO

Código: Fábrika: Unidade:
42179 NUTRIPLAN UN/1
F1 F4

UN: R\$ 124,35 AV: R\$ 124,35 15: R\$ 126,94
30: R\$ 129,48 45: R\$ 132,07 60: R\$ 134,71
30 cm



SUPORTE METAL RODIZIO PRATO 30CM PRETO

Código: Fábrika: Unidade:
42180 NUTRIPLAN UN/1
F1 F4

UN: R\$ 146,87 AV: R\$ 146,87 15: R\$ 149,93
30: R\$ 152,93 45: R\$ 155,99 60: R\$ 159,11
36 cm



SUPORTE METAL RODIZIO PRATO 36CM PRETO

Código: Fábrika: Unidade:
42181 NUTRIPLAN UN/1
F1 F4

UN: R\$ 11,20 AV: R\$ 11,20 15: R\$ 11,44
30: R\$ 11,66 45: R\$ 11,90 60: R\$ 12,14



SUPORTE OLEO PET 773

Código: Fábrika: Unidade:
44719 ARAMINAS UN/1
F1 F4

UN: R\$ 9,55 AV: R\$ 9,55 15: R\$ 9,75
30: R\$ 9,94 45: R\$ 10,14 60: R\$ 10,34



SUPORTE PLAST BOTIJAO SB054

Código: Fábrika: Unidade:
45109 BUDEPLAST UN/1
F1 F4

UN: R\$ 7,14 AV: R\$ 7,14 15: R\$ 7,29
30: R\$ 7,43 45: R\$ 7,58 60: R\$ 7,73



SUPORTE PLAST BOTIJAO 760

Código: Fábrika: Unidade:
46631 LUMAR UN/1
F1 F4

UN: R\$ 6,02 AV: R\$ 6,02 15: R\$ 6,15
30: R\$ 6,27 45: R\$ 6,40 60: R\$ 6,52



SUPORTE PLAST FILTRO CAFE 103 6920

Código: Fábrika: Unidade:
47145 INPLAST UN/1
F1 F4

UN: R\$ 8,31 AV: R\$ 8,31 15: R\$ 8,49
30: R\$ 8,66 45: R\$ 8,83 60: R\$ 9,01



SUPORTE PLAST P/BOTIJAO PRETO 91

Código: Fábrika: Unidade:
22450 MOLDE MINAS UN/1
F1 F4

UN: R\$ 2,84 AV: R\$ 2,84 15: R\$ 2,90
30: R\$ 2,96 45: R\$ 3,02 60: R\$ 3,08



SUPORTE PLAST P/CAIXA SABAO EM PO 4418

Código: Fábrika: Unidade:
10396 NITRON UN/1
F1 F4

UN: R\$ 48,95 AV: R\$ 48,95 15: R\$ 49,97
30: R\$ 50,97 45: R\$ 51,99 60: R\$ 53,03



SUPORTE PLAST P/GARRAFAO AGUA

Código: Fábrika: Unidade:
50368 HERC UN/1
F1 F4

UN: R\$ 4,41 AV: R\$ 4,41 15: R\$ 4,50
30: R\$ 4,59 45: R\$ 4,68 60: R\$ 4,77



SUPORTE PLASTICO P/QUADRO CRISTAL 19 CM

Código: Fábrika: Unidade:
31482 YING FA UN/1
F1 F4

UN: R\$ 5,58 AV: R\$ 5,58 15: R\$ 5,70
30: R\$ 5,81 45: R\$ 5,93 60: R\$ 6,05

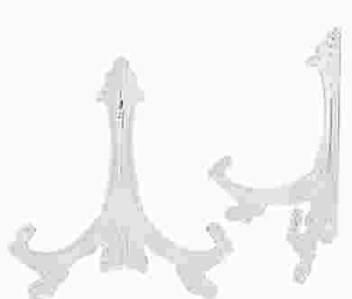

SUPORTE PLASTICO P/QUADRO CRISTAL 21 CM

Código: Fábrika: Unidade:
31483 YING FA UN/1
F1 F4

UN: R\$ 39,17 AV: R\$ 39,17 15: R\$ 39,98
30: R\$ 40,78 45: R\$ 41,60 60: R\$ 42,43



SUQUEIRA VIDRO 3,0 LTS 3182

Código: Fábrika: Unidade:
34816 BATIKI UN/1
F1 F4

UN: R\$ 18,60 AV: R\$ 18,60 15: R\$ 18,98
30: R\$ 19,36 45: R\$ 19,75 60: R\$ 20,14



TABUA MAD HAMBURGUER NATURAL 20X19CM 48B

Código: Fábrika: Unidade:
41740 DEBIASI UN/1
F1 F4

UN: R\$ 19,57 AV: R\$ 19,57 15: R\$ 19,98
30: R\$ 20,38 45: R\$ 20,79 60: R\$ 21,21



TABUA MAD RED PETISCO NATURAL 20CM

Código: Fábrika: Unidade:
41741 DEBIASI UN/1
F1 F4

UN: R\$ 18,60 AV: R\$ 18,60 15: R\$ 18,98
30: R\$ 19,36 45: R\$ 19,75 60: R\$ 20,14



TABUA MAD RED P/FRIOS 25CM 57B

Código: Fábrika: Unidade:
41742 DEBIASI UN/1
F1 F4

UN: R\$ 31,32 AV: R\$ 31,32 15: R\$ 31,98
30: R\$ 32,62 45: R\$ 33,27 60: R\$ 33,93



TABUA MAD RED P/FRIOS C/GARF 25CM 57E

Código: Fábrika: Unidade:
41743 DEBIASI UN/1
F1 F4

UN: R\$ 33,28 AV: R\$ 33,28 15: R\$ 33,98
30: R\$ 34,66 45: R\$ 35,35 60: R\$ 36,06



TABUA PETISQUEIRA ACRÍ PTO 25CM

Código: Fábrika: Unidade:
41744 DEBIASI UN/1
F1 F4

UN: R\$ 3,88 AV: R\$ 3,88 15: R\$ 3,96
30: R\$ 4,04 45: R\$ 4,12 60: R\$ 4,20



TABUA PLAST COLOR 31X18CM 611

Código: Fábrika: Unidade:
41634 QALYPLAS UN/1
F1 F4

UN: R\$ 24,47 AV: R\$ 24,47 15: R\$ 24,98
30: R\$ 25,48 45: R\$ 25,99 60: R\$ 26,51



TABUA PLAST DE CORTE 320X220X4MM P 3050

Código: Fábrika: Unidade:
46243 JAGUAR UN/1
F1 F4

UN: R\$ 34,26 AV: R\$ 34,26 15: R\$ 34,98
30: R\$ 35,68 45: R\$ 36,39 60: R\$ 37,12



TABUA PLAST DE CORTE 35X24X07CM CA08104

Código: Fábrika: Unidade:
50644 CASITA UN/1
F1 F4

UN: R\$ 39,16 AV: R\$ 39,16 15: R\$ 39,97
30: R\$ 40,77 45: R\$ 41,59 60: R\$ 42,42



TABUA PLAST DE CORTE 360X260X6MM G 3051

Código: Fábrika: Unidade:
49219 JAGUAR UN/1
F1 F4

UN: R\$ 22,51 AV: R\$ 22,51 15: R\$ 22,98
30: R\$ 23,44 45: R\$ 23,91 60: R\$ 24,39

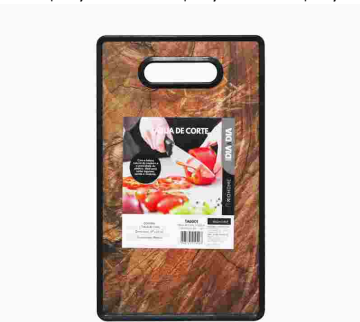

TABUA PLAST DE CORTE 37X23CM 001

Código: Fábrika: Unidade:
11000 RIOHOME UN/1
F1 F4

UN: R\$ 32,06 AV: R\$ 32,06 15: R\$ 32,73
30: R\$ 33,38 45: R\$ 34,05 60: R\$ 34,73



TABUA PLAST MEGA 969

Código: Fábrika: Unidade:
46669 LUMAR UN/1
F1 F4

UN: R\$ 20,45 AV: R\$ 20,45 15: R\$ 20,87
30: R\$ 21,29 45: R\$ 21,71 60: R\$ 22,15



TABUA PLAST P/CARNE 36X21X0,5CM 514

Código: Fábrika: Unidade:
33034 TRITEC UN/1
F1 F4

UN: R\$ 9,40 AV: R\$ 9,40 15: R\$ 9,70
30: R\$ 9,99 45: R\$ 10,29 60: R\$ 10,60



TABUA PLASTICA 33X20CM

Código: Fábrika: Unidade:
28706 PLASTBRASIL UN/1
F1 F4

UN: R\$ 23,78 AV: R\$ 23,78 15: R\$ 24,28
30: R\$ 24,77 45: R\$ 25,26 60: R\$ 25,77



TABULEIRO ALUM 1 ALTO 710

Código: 8256 Fábrica: MSR Unidade: UN/1
F1 F4

UN: R\$ 19,54 AV: R\$ 19,54 15: R\$ 19,94
30: R\$ 20,34 45: R\$ 20,75 60: R\$ 21,16



TABULEIRO ALUM 1 PADRAO 30X21X3,0CM 715

Código: 22790 Fábrica: MSR Unidade: UN/1
F1 F4

UN: R\$ 22,51 AV: R\$ 22,51 15: R\$ 22,98
30: R\$ 23,44 45: R\$ 23,91 60: R\$ 24,39



TABULEIRO ALUM 1 RET EXTRA 30X20X4,0CM

Código: 27599 Fábrica: AVELAR Unidade: UN/1
F1 F4

UN: R\$ 28,54 AV: R\$ 28,54 15: R\$ 29,14
30: R\$ 29,72 45: R\$ 30,32 60: R\$ 30,92



TABULEIRO ALUM 2 ALTO 711

Código: 7908 Fábrica: MSR Unidade: UN/1
F1 F4

UN: R\$ 19,57 AV: R\$ 19,57 15: R\$ 19,98
30: R\$ 20,38 45: R\$ 20,79 60: R\$ 21,21



TABULEIRO ALUM 2 PADRAO 33X23X3,0CM 716

Código: 8257 Fábrica: MSR Unidade: UN/1
F1 F4

UN: R\$ 27,41 AV: R\$ 27,41 15: R\$ 27,98
30: R\$ 28,54 45: R\$ 29,11 60: R\$ 29,69



TABULEIRO ALUM 2 RET EXTRA 33X23X4,0CM

Código: 22791 Fábrica: AVELAR Unidade: UN/1
F1 F4

UN: R\$ 34,26 AV: R\$ 34,26 15: R\$ 34,98
30: R\$ 35,68 45: R\$ 36,39 60: R\$ 37,12



TABULEIRO ALUM 3 ALTO 712

Código: 7909 Fábrica: MSR Unidade: UN/1
F1 F4

UN: R\$ 30,35 AV: R\$ 30,35 15: R\$ 30,98
30: R\$ 31,60 45: R\$ 32,23 60: R\$ 32,87



TABULEIRO ALUM 3 PADRAO 40X30X3,5CM 717

Código: 22792 Fábrica: MSR Unidade: UN/1
F1 F4

UN: R\$ 29,37 AV: R\$ 29,37 15: R\$ 29,98
30: R\$ 30,58 45: R\$ 31,19 60: R\$ 31,81



TABULEIRO ALUM 3 RET EXTRA 37X26X4,0CM

Código: 27601 Fábrica: AVELAR Unidade: UN/1
F1 F4

UN: R\$ 47,97 AV: R\$ 47,97 15: R\$ 48,97
30: R\$ 49,95 45: R\$ 50,95 60: R\$ 51,97



TABULEIRO ALUM 4 ALTO 713 ASSAD 42X29X6

Código: 7911 Fábrica: MSR Unidade: UN/1
F1 F4

UN: R\$ 43,08 AV: R\$ 43,08 15: R\$ 43,97
30: R\$ 44,85 45: R\$ 45,75 60: R\$ 46,66



TABULEIRO ALUM 4 PADRAO 45X33X4,0CM 718

Código: 22793 Fábrica: MSR Unidade: UN/1
F1 F4

UN: R\$ 42,10 AV: R\$ 42,10 15: R\$ 42,97
30: R\$ 43,83 45: R\$ 44,71 60: R\$ 45,60



TABULEIRO ALUM 4 RET EXTRA 42X30X4,0CM

Código: 27602 Fábrica: AVELAR Unidade: UN/1
F1 F4

UN: R\$ 58,74 AV: R\$ 58,74 15: R\$ 59,97
30: R\$ 61,17 45: R\$ 62,39 60: R\$ 63,64



TABULEIRO ALUM 5 ALTO 714

Código: 11262 Fábrica: MSR Unidade: UN/1
F1 F4

UN: R\$ 52,87 AV: R\$ 52,87 15: R\$ 53,97
30: R\$ 55,05 45: R\$ 56,15 60: R\$ 57,27



TABULEIRO ALUM 5 PADRAO 48X35X4,5CM 719

Código: 22794 Fábrica: MSR Unidade: UN/1
F1 F4

UN: R\$ 48,95 AV: R\$ 48,95 15: R\$ 49,97
30: R\$ 50,97 45: R\$ 51,99 60: R\$ 53,03



TABULEIRO ALUM 5 RET EXTRA 46X33X4,0CM

Código: 27603 Fábrica: AVELAR Unidade: UN/1
F1 F4

UN: R\$ 3,18 AV: R\$ 3,18 15: R\$ 3,25
30: R\$ 3,31 45: R\$ 3,38 60: R\$ 3,45



TACA ACRILICO 190ML CHAMPANHE CRISTAL 14

Código: 50344 Fábrica: QUALYPLAS Unidade: UN/1
F1 F4

UN: R\$ 14,68 AV: R\$ 29,37 15: R\$ 29,98
30: R\$ 30,58 45: R\$ 31,19 60: R\$ 31,81



TACA PLAST 360ML GIN BICOLOR VC11327 2X1
Código: 41130 Fábrica: BRASFOOT Unidade: CJ/2 F1 F4

UN: R\$ 18,60 AV: R\$ 37,20 15: R\$ 37,97
30: R\$ 38,73 45: R\$ 39,51 60: R\$ 40,30



TACA PLAST 580ML DEGRADE GIN 10565 2X1
Código: 39133 Fábrica: BRASFOOT Unidade: CJ/2 F1 F4

UN: R\$ 18,60 AV: R\$ 37,20 15: R\$ 37,97
30: R\$ 38,73 45: R\$ 39,51 60: R\$ 40,30



TACA PLAST 580ML DEGRADE GIN 10570 2X1
Código: 39134 Fábrica: BRASFOOT Unidade: CJ/2 F1 F4

UN: R\$ 29,37 AV: R\$ 29,37 15: R\$ 29,98
30: R\$ 30,58 45: R\$ 31,19 60: R\$ 31,81



TACA PLAST 580ML GIN ATLETICO 10800 2X1
Código: 41128 Fábrica: BRASFOOT Unidade: UN/1 F1 F4

UN: R\$ 14,68 AV: R\$ 29,37 15: R\$ 29,98
30: R\$ 30,58 45: R\$ 31,19 60: R\$ 31,81



TACA PLAST 580ML GIN FLAMENGO 10801 2X1
Código: 41129 Fábrica: BRASFOOT Unidade: CJ/2 F1 F4

UN: R\$ 2,06 AV: R\$ 2,06 15: R\$ 2,10
30: R\$ 2,14 45: R\$ 2,18 60: R\$ 2,23



TACA PLASTICO COPACABANA GDE 073
Código: 27699 Fábrica: HEMITOYS Unidade: UN/1 F1 F4

UN: R\$ 15,67 AV: R\$ 15,67 15: R\$ 15,99
30: R\$ 16,31 45: R\$ 16,64 60: R\$ 16,97



TACA VIDRO 300ML CERVEJA COLECCION 524093
Código: 39258 Fábrica: FRATELLI Unidade: UN/1 F1 F4

UN: R\$ 24,47 AV: R\$ 24,47 15: R\$ 24,98
30: R\$ 25,48 45: R\$ 25,99 60: R\$ 26,51



TACA VIDRO 300ML WINDSOR AGRADECA 2611
Código: 39034 Fábrica: BRASFOOT Unidade: UN/1 F1 F4

UN: R\$ 24,47 AV: R\$ 24,47 15: R\$ 24,98
30: R\$ 25,48 45: R\$ 25,99 60: R\$ 26,51



TACA VIDRO 300ML WINDSOR BEBO PRA E 2612
Código: 39031 Fábrica: BRASFOOT Unidade: UN/1 F1 F4

UN: R\$ 24,47 AV: R\$ 24,47 15: R\$ 24,98
30: R\$ 25,48 45: R\$ 25,99 60: R\$ 26,51



TACA VIDRO 300ML WINDSOR E MELHOR U 2613
Código: 39033 Fábrica: BRASFOOT Unidade: UN/1 F1 F4

UN: R\$ 32,30 AV: R\$ 32,30 15: R\$ 32,98
30: R\$ 33,64 45: R\$ 34,31 60: R\$ 35,00



TACA VIDRO 300ML WINDSOR FLAMENGO 1551
Código: 39026 Fábrica: BRASFOOT Unidade: UN/1 F1 F4

UN: R\$ 32,30 AV: R\$ 32,30 15: R\$ 32,98
30: R\$ 33,64 45: R\$ 34,31 60: R\$ 35,00



TACA VIDRO 300ML WINDSOR FLAMENGO 2661
Código: 39030 Fábrica: BRASFOOT Unidade: UN/1 F1 F4

UN: R\$ 24,47 AV: R\$ 24,47 15: R\$ 24,98
30: R\$ 25,48 45: R\$ 25,99 60: R\$ 26,51



TACA VIDRO 300ML WINDSOR QUEM BEBE 2610
Código: 39032 Fábrica: BRASFOOT Unidade: UN/1 F1 F4

UN: R\$ 27,41 AV: R\$ 54,83 15: R\$ 55,97
30: R\$ 57,09 45: R\$ 58,23 60: R\$ 59,39



TACA VIDRO 330ML WINDSOR ADORO 11597 2X1
Código: 41115 Fábrica: BRASFOOT Unidade: CJ/2 F1 F4

UN: R\$ 29,37 AV: R\$ 29,37 15: R\$ 29,98
30: R\$ 30,58 45: R\$ 31,19 60: R\$ 31,81



TACA VIDRO 330ML WINDSOR ADORO 11600
Código: 41117 Fábrica: BRASFOOT Unidade: UN/1 F1 F4

UN: R\$ 72,45 AV: R\$ 72,45 15: R\$ 73,96
30: R\$ 75,44 45: R\$ 76,95 60: R\$ 78,49



TACA VIDRO 330ML+AVENTAL ATLETICO 10000
Código: 41114 Fábrica: BRASFOOT Unidade: UN/1 F1 F4

UN: R\$ 72,45 AV: R\$ 72,45 15: R\$ 73,96
30: R\$ 75,44 45: R\$ 76,95 60: R\$ 78,49



TACA VIDRO 330ML+AVENTAL CRUZEIRO 10001

Código: 41113 Fábrica: BRASFOOT Unidade: UN/1
F1 F4

UN: R\$ 30,35 AV: R\$ 30,35 15: R\$ 30,98
30: R\$ 31,60 45: R\$ 32,23 60: R\$ 32,87

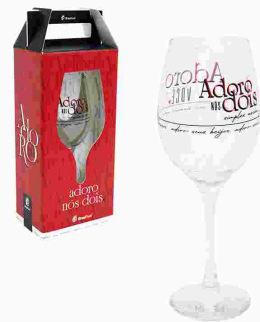

TACA VIDRO 385ML VINHO ADORO 11609

Código: 41118 Fábrica: BRASFOOT Unidade: UN/1
F1 F4

UN: R\$ 4,50 AV: R\$ 27,03 15: R\$ 27,59
30: R\$ 28,14 45: R\$ 28,70 60: R\$ 29,28



TACA VIDRO 40ML TRANSP 23353 6X1

Código: 36756 Fábrica: MABEL Unidade: CX/6
F1 F4

UN: R\$ 4,50 AV: R\$ 27,03 15: R\$ 27,59
30: R\$ 28,14 45: R\$ 28,70 60: R\$ 29,28



TACA VIDRO 40ML TRANSP 23354 6X1

Código: 36757 Fábrica: MABEL Unidade: CX/6
F1 F4

UN: R\$ 39,16 AV: R\$ 39,16 15: R\$ 39,97
30: R\$ 40,77 45: R\$ 41,59 60: R\$ 42,42



TACA VIDRO 400ML DUBLIN ATLETICO 10451

Código: 39109 Fábrica: BRASFOOT Unidade: UN/1
F1 F4

UN: R\$ 39,16 AV: R\$ 39,16 15: R\$ 39,97
30: R\$ 40,77 45: R\$ 41,59 60: R\$ 42,42



TACA VIDRO 400ML DUBLIN FLAMENGO 10453

Código: 39023 Fábrica: BRASFOOT Unidade: UN/1
F1 F4

UN: R\$ 0,43 AV: R\$ 43,08 15: R\$ 43,97
30: R\$ 44,85 45: R\$ 45,75 60: R\$ 46,66

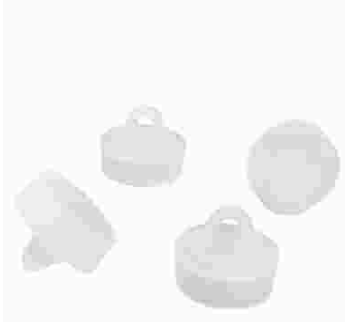

TAMPA PLAST P/LAVATORIO PIA TV51N 100X1

Código: 33734 Fábrica: REBOUCAS Unidade: PT/100
F1 F4

UN: R\$ 0,57 AV: R\$ 56,78 15: R\$ 57,97
30: R\$ 59,13 45: R\$ 60,31 60: R\$ 61,51



TAMPA PLAST P/TANQUE TV52N 100X1

Código: 33733 Fábrica: REBOUCAS Unidade: PT/100
F1 F4

UN: R\$ 11,21 AV: R\$ 11,21 15: R\$ 11,45
30: R\$ 11,67 45: R\$ 11,91 60: R\$ 12,15



TAPETE ANTID BANHEIRO BCO 66X36CM 619

Código: 44508 Fábrica: PLANETA Unidade: UN/1
F1 F4

UN: R\$ 11,21 AV: R\$ 11,21 15: R\$ 11,45
30: R\$ 11,67 45: R\$ 11,91 60: R\$ 12,15



TAPETE ANTID BANHEIRO TRANSP 66X36CM 625

Código: 44509 Fábrica: PLANETA Unidade: UN/1
F1 F4

UN: R\$ 12,72 AV: R\$ 12,72 15: R\$ 12,98
30: R\$ 13,24 45: R\$ 13,51 60: R\$ 13,78



TAPETE ANTID BOX TRANSP 65X35CM 7692

Código: 47360 Fábrica: ALTHOME Unidade: UN/1
F1 F4

UN: R\$ 25,45 AV: R\$ 25,45 15: R\$ 25,98
30: R\$ 26,50 45: R\$ 27,03 60: R\$ 27,57

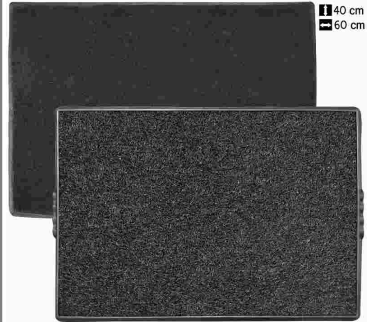

TAPETE BALME 40X60CM CORES 091

Código: 36935 Fábrica: RIOHOME Unidade: UN/1
F1 F4

UN: R\$ 38,18 AV: R\$ 38,18 15: R\$ 38,97
30: R\$ 39,75 45: R\$ 40,55 60: R\$ 41,36



TAPETE FIBRA COCO BORRACHA 40X60CM 088

Código: 49365 Fábrica: RIOHOME Unidade: UN/1
F1 F4

UN: R\$ 23,49 AV: R\$ 23,49 15: R\$ 23,98
30: R\$ 24,46 45: R\$ 24,95 60: R\$ 25,45



TAPETE MICROFIBRA ANTIDER 38X58CM 064

Código: 49363 Fábrica: RIOHOME Unidade: UN/1
F1 F4

UN: R\$ 22,51 AV: R\$ 22,51 15: R\$ 22,98
30: R\$ 23,44 45: R\$ 23,91 60: R\$ 24,39



TAPETE MICROFIBRA 38X58CM SOFT BALL 027

Código: 49364 Fábrica: RIOHOME Unidade: UN/1
F1 F4

UN: R\$ 12,07 AV: R\$ 12,07 15: R\$ 12,33
30: R\$ 12,57 45: R\$ 12,82 60: R\$ 13,08



TAPETE POLIESTER BEM VINDO 37X57CM 11611

Código: 44515 Fábrica: NICOBEM Unidade: UN/1
F1 F4

UN: R\$ 11,74 AV: R\$ 11,74 15: R\$ 11,99
30: R\$ 12,22 45: R\$ 12,47 60: R\$ 12,72



TAPETE POLIESTER BEM VINDO 37X57CM 2167
Código: Fábrica: Unidade:
47094 GP6 UN/1
F1 F4

UN: R\$ 12,43 AV: R\$ 12,43 15: R\$ 12,68
30: R\$ 12,94 45: R\$ 13,20 60: R\$ 13,46



TAPETE POP POLIESTER ANTIDERRAP 59X39CM
Código: Fábrica: Unidade:
39967 PERFETTO RL/1
F1 F4

UN: R\$ 18,60 AV: R\$ 18,60 15: R\$ 18,98
30: R\$ 19,36 45: R\$ 19,75 60: R\$ 20,14



TAPETE PVC ANTID BOX CORUJA 67X35CM 4048
Código: Fábrica: Unidade:
47897 CASITA UN/1
F1 F4

UN: R\$ 18,60 AV: R\$ 18,60 15: R\$ 18,98
30: R\$ 19,36 45: R\$ 19,75 60: R\$ 20,14



TAPETE PVC/FLAN BANH CORUJA 40X60CM 4046
Código: Fábrica: Unidade:
47898 CASITA UN/1
F1 F4

UN: R\$ 13,70 AV: R\$ 13,70 15: R\$ 13,98
30: R\$ 14,26 45: R\$ 14,55 60: R\$ 14,84

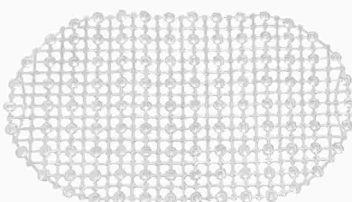

TAPETE SILIC ANTID BANHEIRO 62X35CM 7040
Código: Fábrica: Unidade:
41536 ELITE UN/1
F1 F4

UN: R\$ 1,52 AV: R\$ 75,89 15: R\$ 77,47
30: R\$ 79,02 45: R\$ 80,60 60: R\$ 82,21



TEE 1/2 ACOPLAR MANGUEIRA PTO TE51N 50X1
Código: Fábrica: Unidade:
40149 REBOUCAS PT/50
F1 F4

UN: R\$ 2,55 AV: R\$ 127,29 15: R\$ 129,94
30: R\$ 132,54 45: R\$ 135,19 60: R\$ 137,89



TEE 3/4 ACOPLAR MANGUEIRA PTO TE52N 50X1
Código: Fábrica: Unidade:
40150 REBOUCAS PT/50
F1 F4

UN: R\$ 19,57 AV: R\$ 19,57 15: R\$ 19,98
30: R\$ 20,38 45: R\$ 20,79 60: R\$ 21,21



TERRA ESP P/CACTOS E SUCULENTAS 1,5 KG
Código: Fábrica: Unidade:
35708 NUTRIPLAN PT/1
F1 F4

UN: R\$ 6,84 AV: R\$ 6,84 15: R\$ 6,99
30: R\$ 7,13 45: R\$ 7,27 60: R\$ 7,41



TERRA ORQUIDEA 1 LITRO
Código: Fábrica: Unidade:
48526 NOVATROPICAL PT/1
F1 F4

UN: R\$ 7,82 AV: R\$ 7,82 15: R\$ 7,99
30: R\$ 8,15 45: R\$ 8,31 60: R\$ 8,48



TERRA SAMAMBAIA 1 LITRO
Código: Fábrica: Unidade:
48527 NOVATROPICAL PT/1
F1 F4

UN: R\$ 13,98 AV: R\$ 13,98 15: R\$ 14,27
30: R\$ 14,56 45: R\$ 14,85 60: R\$ 15,15



TERRA SAMAMBAIA 1,5 KG
Código: Fábrica: Unidade:
22287 VITAPLAN PT/1
F1 F4

UN: R\$ 15,84 AV: R\$ 15,84 15: R\$ 16,17
30: R\$ 16,50 45: R\$ 16,83 60: R\$ 17,16



TERRA SAMAMBAIA 2 KG
Código: Fábrica: Unidade:
47464 VITAPLAN KG/1
F1 F4

UN: R\$ 4,79 AV: R\$ 4,79 15: R\$ 4,89
30: R\$ 4,99 45: R\$ 5,09 60: R\$ 5,19

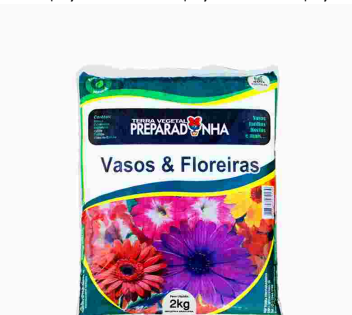

TERRA VEGETAL 2 KG
Código: Fábrica: Unidade:
19888 NOVATROPICAL PT/1
F1 F4

UN: R\$ 9,65 AV: R\$ 9,65 15: R\$ 9,85
30: R\$ 10,04 45: R\$ 10,24 60: R\$ 10,45

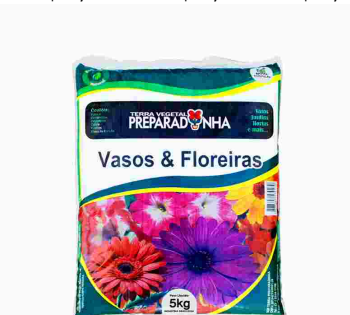

TERRA VEGETAL 5 KG
Código: Fábrica: Unidade:
19889 NOVATROPICAL PT/1
F1 F4

UN: R\$ 14,68 AV: R\$ 14,68 15: R\$ 14,98
30: R\$ 15,28 45: R\$ 15,59 60: R\$ 15,90



TERRA VEGETAL 10 KG
Código: Fábrica: Unidade:
30504 NOVATROPICAL PT/1
F1 F4

UN: R\$ 24,47 AV: R\$ 24,47 15: R\$ 24,98
30: R\$ 25,48 45: R\$ 25,99 60: R\$ 26,51



TERRA VEGETAL 20 KG
Código: Fábrica: Unidade:
30765 NOVATROPICAL PT/1
F1 F4

UN: R\$ 29,37 AV: R\$ 29,37 15: R\$ 29,98
30: R\$ 30,58 45: R\$ 31,19 60: R\$ 31,81



TERRA VEGETAL 25 KG
Código: 47378 Fábrica: NOVATROPICAL Unidade: PT/1 F1 F4

UN: R\$ 19,57 AV: R\$ 19,57 15: R\$ 19,98
30: R\$ 20,38 45: R\$ 20,79 60: R\$ 21,21



TIGELA ACRILIC BOWL C/TAMPA COLOR 33127
Código: 41214 Fábrica: PLASTSU Unidade: UN/1 F1 F4

UN: R\$ 17,14 AV: R\$ 17,14 15: R\$ 17,49
30: R\$ 17,84 45: R\$ 18,20 60: R\$ 18,56



TIGELA ALUM 20 1197
Código: 45284 Fábrica: MSR Unidade: UN/1 F1 F4

UN: R\$ 2,44 AV: R\$ 2,44 15: R\$ 2,49
30: R\$ 2,54 45: R\$ 2,59 60: R\$ 2,64



TIGELA PLASTICA BOWL 350 ML 115
Código: 14583 Fábrica: ECOPLASTIC Unidade: UN/1 F1 F4

UN: R\$ 9,06 AV: R\$ 217,38 15: R\$ 221,91
30: R\$ 226,35 45: R\$ 230,88 60: R\$ 235,49

12,5 cm
10,5 cm
620 ml



TIGELA VIDRO 620ML PREMIERE 1067 24X1
Código: 39522 Fábrica: MULTIPRESENT Unidade: CX/24 F1 F4

UN: R\$ 34,24 AV: R\$ 34,24 15: R\$ 34,96
30: R\$ 35,66 45: R\$ 36,37 60: R\$ 37,10



TOALHA BANHO PROF 1,30X70XM BRANCA
Código: 47342 Fábrica: MARCOTEX Unidade: UN/1 F1 F4

UN: R\$ 4,49 AV: R\$ 53,86 15: R\$ 54,98
30: R\$ 56,08 45: R\$ 57,20 60: R\$ 58,34



TOALHA LAVABO SLIM 45X29CM AMARELO 12X1
Código: 47661 Fábrica: MARCOTEX Unidade: PT/12 F1 F4

UN: R\$ 8,98 AV: R\$ 53,86 15: R\$ 54,98
30: R\$ 56,08 45: R\$ 57,20 60: R\$ 58,34

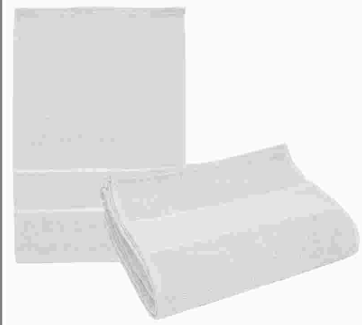

TOALHA LAVABO SLIM 45X29CM BRANCO 6X1
Código: 47654 Fábrica: MARCOTEX Unidade: PT/6 F1 F4

UN: R\$ 4,49 AV: R\$ 53,86 15: R\$ 54,98
30: R\$ 56,08 45: R\$ 57,20 60: R\$ 58,34



TOALHA LAVABO SLIM 45X29CM LARANJA 6X1
Código: 47660 Fábrica: MARCOTEX Unidade: PT/12 F1 F4

UN: R\$ 4,49 AV: R\$ 53,86 15: R\$ 54,98
30: R\$ 56,08 45: R\$ 57,20 60: R\$ 58,34



TOALHA LAVABO SLIM 45X29CM ROSA FLOR12X1
Código: 47657 Fábrica: MARCOTEX Unidade: PT/12 F1 F4

UN: R\$ 21,74 AV: R\$ 21,74 15: R\$ 22,19
30: R\$ 22,63 45: R\$ 23,09 60: R\$ 23,55

1,48m 1,50m



TOALHA MESA PANO 1,48X1,50M LISA 1101
Código: 40444 Fábrica: SUN WELLS Unidade: UN/1 F1 F4

UN: R\$ 32,31 AV: R\$ 32,31 15: R\$ 32,99
30: R\$ 33,65 45: R\$ 34,32 60: R\$ 35,01

1,48m 1,50m

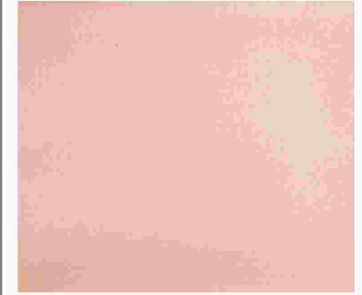

TOALHA MESA PANO 1,48X1,50M NATAL
Código: 40446 Fábrica: SUN WELLS Unidade: UN/1 F1 F4

UN: R\$ 43,29 AV: R\$ 43,29 15: R\$ 44,19
30: R\$ 45,08 45: R\$ 45,98 60: R\$ 46,90

1,50m 2,20m



TOALHA MESA PANO 2,20X1,50M ESTAMP
Código: 40447 Fábrica: SUN WELLS Unidade: UN/1 F1 F4

UN: R\$ 4,41 AV: R\$ 4,41 15: R\$ 4,50
30: R\$ 4,59 45: R\$ 4,68 60: R\$ 4,77



TOALHA MULTIUSO MICROFIBRA 30X30CM 163
Código: 50790 Fábrica: HOME&MORE Unidade: UN/1 F1 F4

UN: R\$ 2,87 AV: R\$ 34,47 15: R\$ 35,19
30: R\$ 35,89 45: R\$ 36,61 60: R\$ 37,34



TOALHA SOCIAL LISA 36X23CM BRANCO 12X1
Código: 47668 Fábrica: MARCOTEX Unidade: PT/12 F1 F4

UN: R\$ 2,65 AV: R\$ 31,82 15: R\$ 32,49
30: R\$ 33,14 45: R\$ 33,80 60: R\$ 34,48



TOALHA SOCIAL LISA 36X23CM PRETO 12X1
Código: 47669 Fábrica: MARCOTEX Unidade: PT/12 F1 F4

UN: R\$ 18,60 AV: R\$ 18,60 15: R\$ 18,98
30: R\$ 19,36 45: R\$ 19,75 60: R\$ 20,14

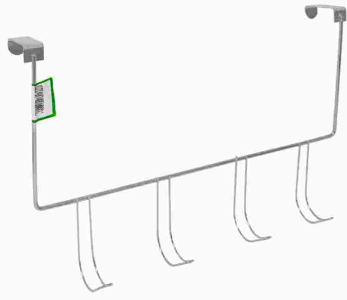

TOALHEIRO CROM DE PORTA 67

Código: Fábrica: Unidade:
28958 ARAMINAS UN/1
F1 F4

UN: R\$ 3,22 AV: R\$ 3,22 15: R\$ 3,29
30: R\$ 3,35 45: R\$ 3,42 60: R\$ 3,49



TOALHEIRO CROM PAREDE N1 1 GANCHO 64

Código: Fábrica: Unidade:
44242 ARAMINAS UN/1
F1 F4

UN: R\$ 11,26 AV: R\$ 11,26 15: R\$ 11,50
30: R\$ 11,73 45: R\$ 11,96 60: R\$ 12,20



TOALHEIRO CROM PAREDE N4 4 GANCHOS 66

Código: Fábrica: Unidade:
40516 ARAMINAS UN/1
F1 F4

UN: R\$ 3,80 AV: R\$ 45,63 15: R\$ 46,58
30: R\$ 47,51 45: R\$ 48,46 60: R\$ 49,43



TORNEIRA JARDIM 1/2 C/BIC COL TVC1N 12X1

Código: Fábrica: Unidade:
33726 REBOUCAS PT/12
F1 F4

UN: R\$ 3,02 AV: R\$ 36,22 15: R\$ 36,98
30: R\$ 37,71 45: R\$ 38,47 60: R\$ 39,24



TORNEIRA JARDIM 1/2 C/BICO PT TTV1N 12X1

Código: Fábrica: Unidade:
30743 REBOUCAS PT/12
F1 F4

UN: R\$ 3,64 AV: R\$ 43,72 15: R\$ 44,63
30: R\$ 45,52 45: R\$ 46,44 60: R\$ 47,36



TORNEIRA JARDIM 3/4 1/2 10CM C/B B1N12X1

Código: Fábrica: Unidade:
51130 REBOUCAS PT/12
F1 F4

UN: R\$ 3,26 AV: R\$ 39,16 15: R\$ 39,97
30: R\$ 40,77 45: R\$ 41,59 60: R\$ 42,42



TORNEIRA JARDIM 3/4 1/2 10CM C/B R1N12X1

Código: Fábrica: Unidade:
35660 REBOUCAS PT/12
F1 F4

UN: R\$ 6,32 AV: R\$ 75,89 15: R\$ 77,47
30: R\$ 79,02 45: R\$ 80,60 60: R\$ 82,21



TORNEIRA P/FILTRO AUTOM MARROM 342 12X1

Código: Fábrica: Unidade:
8042 MINERAL PT/12
F1 F4

UN: R\$ 11,42 AV: R\$ 137,08 15: R\$ 139,93
30: R\$ 142,73 45: R\$ 145,59 60: R\$ 148,50



TORNEIRA P/FILTRO CROMO AUTOMAT 31 12X1

Código: Fábrica: Unidade:
27209 MINERAL PT/12
F1 F4

UN: R\$ 5,70 AV: R\$ 68,35 15: R\$ 69,77
30: R\$ 71,17 45: R\$ 72,59 60: R\$ 74,04



TORNEIRA P/FILTRO MANUAL MARROM 341 12X1

Código: Fábrica: Unidade:
8043 MINERAL PT/12
F1 F4

UN: R\$ 6,85 AV: R\$ 82,24 15: R\$ 83,96
30: R\$ 85,64 45: R\$ 87,35 60: R\$ 89,10



TORNEIRA P/FILTRO TOC BRANCA 86 12X1

Código: Fábrica: Unidade:
28807 MINERAL PT/12
F1 F4

UN: R\$ 6,20 AV: R\$ 74,41 15: R\$ 75,96
30: R\$ 77,48 45: R\$ 79,03 60: R\$ 80,61



TORNEIRA P/FILTRO TOC MARROM 34 12X1

Código: Fábrica: Unidade:
38332 MINERAL PT/12
F1 F4

UN: R\$ 6,20 AV: R\$ 74,41 15: R\$ 75,96
30: R\$ 77,48 45: R\$ 79,03 60: R\$ 80,61



TORNEIRA PIA LG 3/4 1/2 15CM C/B18N 12X1

Código: Fábrica: Unidade:
47223 REBOUCAS PT/12
F1 F4

UN: R\$ 4,90 AV: R\$ 58,74 15: R\$ 59,97
30: R\$ 61,17 45: R\$ 62,39 60: R\$ 63,64



TORNEIRA PIA LONG 3/4 1/2 15CM TR5N 12X1

Código: Fábrica: Unidade:
35659 REBOUCAS PT/12
F1 F4

UN: R\$ 5,87 AV: R\$ 70,49 15: R\$ 71,96
30: R\$ 73,40 45: R\$ 74,87 60: R\$ 76,37



TORNEIRA PIA LONGA 1/2 15CM C/B 18N 12X1

Código: Fábrica: Unidade:
33722 REBOUCAS PT/12
F1 F4

UN: R\$ 3,59 AV: R\$ 43,08 15: R\$ 43,97
30: R\$ 44,85 45: R\$ 45,75 60: R\$ 46,66



TORNEIRA PIA LONGA 1/2 15CM TTV5N 12X1

Código: Fábrica: Unidade:
30742 REBOUCAS PT/12
F1 F4

UN: R\$ 5,18 AV: R\$ 5,18 15: R\$ 5,29
30: R\$ 5,39 45: R\$ 5,50 60: R\$ 5,61



TORNEIRA PIA LONGA 3/4X1/2 15CM TV5N UN
Código: Fábrica: Unidade:
39370 REBOUCAS UN/1
F1 F4

UN: R\$ 4,32 AV: R\$ 51,90 15: R\$ 52,98
30: R\$ 54,04 45: R\$ 55,12 60: R\$ 56,22



TORNEIRA PIA 3/4X1/2 15CM UNIV TV5N 12X1
Código: Fábrica: Unidade:
33729 REBOUCAS PT/12
F1 F4

UN: R\$ 3,59 AV: R\$ 43,08 15: R\$ 43,97
30: R\$ 44,85 45: R\$ 45,75 60: R\$ 46,66

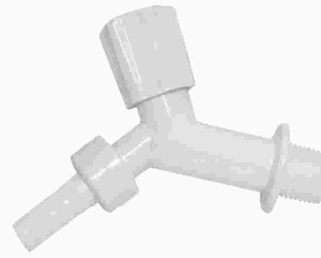

TORNEIRA PIA/TANQUE 1/2 15CM TVC5N 12X1
Código: Fábrica: Unidade:
34844 REBOUCAS PT/12
F1 F4

UN: R\$ 2,90 AV: R\$ 34,86 15: R\$ 35,59
30: R\$ 36,30 45: R\$ 37,02 60: R\$ 37,76

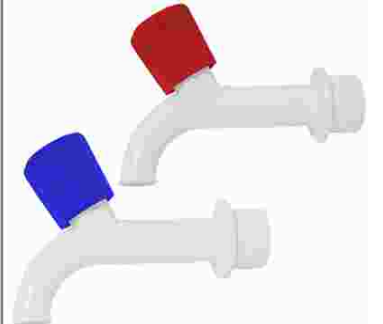

TORNEIRA PIA/TANQUE 3/4 10CM CL C4N 12X1
Código: Fábrica: Unidade:
33727 REBOUCAS PT/12
F1 F4

UN: R\$ 3,34 AV: R\$ 40,14 15: R\$ 40,97
30: R\$ 41,79 45: R\$ 42,63 60: R\$ 43,48

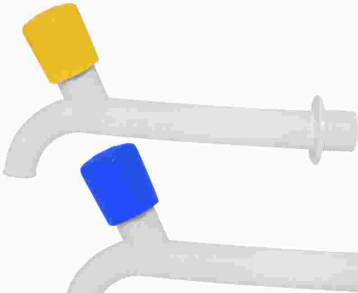

TORNEIRA P/JARDIM 1/2 10CM C/B VB1N 12X1
Código: Fábrica: Unidade:
34846 REBOUCAS PT/12
F1 F4

UN: R\$ 11,74 AV: R\$ 11,74 15: R\$ 11,99
30: R\$ 12,22 45: R\$ 12,47 60: R\$ 12,72



TORNEIRA PLAST ESFERA 1/2 10CM UN
Código: Fábrica: Unidade:
46804 CAERUS UN/1
F1 F4

UN: R\$ 11,10 AV: R\$ 133,16 15: R\$ 135,94
30: R\$ 138,65 45: R\$ 141,43 60: R\$ 144,26



TORNEIRA P/LAVATORIO 1/2 TTV7N 12X1
Código: Fábrica: Unidade:
33217 REBOUCAS PT/12
F1 F4

UN: R\$ 4,36 AV: R\$ 52,29 15: R\$ 53,38
30: R\$ 54,45 45: R\$ 55,54 60: R\$ 56,65



TORNEIRA TANQUE/MAQ 1/2 10CM C/A TV20N12X1
Código: Fábrica: Unidade:
34845 REBOUCAS PT/12
F1 F4

UN: R\$ 4,08 AV: R\$ 48,95 15: R\$ 49,97
30: R\$ 50,97 45: R\$ 51,99 60: R\$ 53,03



TORNEIRA TANQUE CURT 1/2 10CM TTV3N 12X1
Código: Fábrica: Unidade:
32565 REBOUCAS PT/12
F1 F4

UN: R\$ 5,14 AV: R\$ 61,68 15: R\$ 62,96
30: R\$ 64,22 45: R\$ 65,51 60: R\$ 66,82



TORNEIRA TANQUE 1/2 10CM C/B16N 12X1
Código: Fábrica: Unidade:
33723 REBOUCAS PT/12
F1 F4

UN: R\$ 3,92 AV: R\$ 46,99 15: R\$ 47,97
30: R\$ 48,93 45: R\$ 49,91 60: R\$ 50,91



TORNEIRA TANQUE 3/4X1/2 10CM U TR3N 12X1
Código: Fábrica: Unidade:
48609 REBOUCAS PT/12
F1 F4

UN: R\$ 4,30 AV: R\$ 4,30 15: R\$ 4,39
30: R\$ 4,48 45: R\$ 4,57 60: R\$ 4,66



TORNEIRA TANQUE 3/4X1/2 10CM U TV3N UN
Código: Fábrica: Unidade:
40675 REBOUCAS PT/1
F1 F4

UN: R\$ 3,88 AV: R\$ 46,51 15: R\$ 47,48
30: R\$ 48,43 45: R\$ 49,40 60: R\$ 50,39



TORNEIRA TANQUE 3/4X1/2 10CM U TV3N 12X1
Código: Fábrica: Unidade:
33730 REBOUCAS PT/12
F1 F4

UN: R\$ 3,20 AV: R\$ 38,38 15: R\$ 39,18
30: R\$ 39,97 45: R\$ 40,77 60: R\$ 41,58



TORNEIRA TANQUE/PIA 3/4 10CM TTV4N 12X1
Código: Fábrica: Unidade:
31572 REBOUCAS PT/12
F1 F4

UN: R\$ 10,76 AV: R\$ 10,76 15: R\$ 10,99
30: R\$ 11,21 45: R\$ 11,43 60: R\$ 11,66



TRAVESSA ALUM PORCAO 1
Código: Fábrica: Unidade:
37341 MSR UN/1
F1 F4

UN: R\$ 26,43 AV: R\$ 26,43 15: R\$ 26,98
30: R\$ 27,52 45: R\$ 28,07 60: R\$ 28,63



TRAVESSA ALUM PORCAO 2 1194
Código: Fábrica: Unidade:
37342 MSR UN/1
F1 F4

UN: R\$ 27,22 AV: R\$ 27,22 15: R\$ 27,79
30: R\$ 28,34 45: R\$ 28,91 60: R\$ 29,49



TRAVESSA ALUM PORCAO 3

Código: 37343 Fábrica: MSR Unidade: UN/1
F1 F4

UN: R\$ 15,08 AV: R\$ 15,08 15: R\$ 15,39
30: R\$ 15,70 45: R\$ 16,02 60: R\$ 16,34



TRAVESSA INOX 31X21CM (TABULEIRO)800-11

Código: 40530 Fábrica: CASA ONZE Unidade: UN/1
F1 F4

UN: R\$ 24,38 AV: R\$ 24,38 15: R\$ 24,89
30: R\$ 25,39 45: R\$ 25,90 60: R\$ 26,41



TRAVESSA INOX 39X29CM (TABULEIRO)800-13

Código: 40658 Fábrica: CASA ONZE Unidade: UN/1
F1 F4

UN: R\$ 4,31 AV: R\$ 4,31 15: R\$ 4,40
30: R\$ 4,49 45: R\$ 4,58 60: R\$ 4,67



TRAVESSA PLAST PEQ RET C/TAMPA 147

Código: 33502 Fábrica: ARIPLAS Unidade: UN/1
F1 F4

UN: R\$ 1,86 AV: R\$ 1,86 15: R\$ 1,90
30: R\$ 1,94 45: R\$ 1,98 60: R\$ 2,02



TRAVESSA PLASTICA FUNDA

Código: 14579 Fábrica: ECOPLASTIC Unidade: UN/1
F1 F4

UN: R\$ 15,11 AV: R\$ 15,11 15: R\$ 15,42
30: R\$ 15,73 45: R\$ 16,05 60: R\$ 16,37



TRAVESSA PORC 320ML PEQ BRANCA G14

Código: 40019 Fábrica: TERRAMADA Unidade: UN/1
F1 F4

UN: R\$ 16,79 AV: R\$ 16,79 15: R\$ 17,14
30: R\$ 17,49 45: R\$ 17,84 60: R\$ 18,19



TRAVESSA PORC 450ML MED BRANCA G15

Código: 40020 Fábrica: TERRAMADA Unidade: UN/1
F1 F4

UN: R\$ 5,87 AV: R\$ 5,87 15: R\$ 5,99
30: R\$ 6,11 45: R\$ 6,23 60: R\$ 6,35



TRITURADOR PLAST GIRATORIO P/ALHO 1032

Código: 50375 Fábrica: ENGIPLAST Unidade: UN/1
F1 F4

UN: R\$ 2,93 AV: R\$ 2,93 15: R\$ 2,99
30: R\$ 3,05 45: R\$ 3,11 60: R\$ 3,17



TRITURADOR PLAST GIRATORIO P/ALHO 780

Código: 36963 Fábrica: QUALYPLAS Unidade: UN/1
F1 F4

UN: R\$ 19,18 AV: R\$ 19,18 15: R\$ 19,58
30: R\$ 19,97 45: R\$ 20,37 60: R\$ 20,78

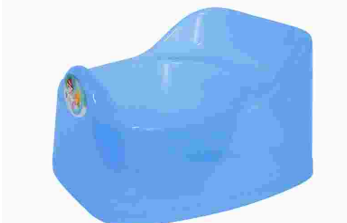

TRONINHO PLAST BABY AZUL 3638

Código: 35480 Fábrica: TRITEC Unidade: UN/1
F1 F4

UN: R\$ 19,18 AV: R\$ 19,18 15: R\$ 19,58
30: R\$ 19,97 45: R\$ 20,37 60: R\$ 20,78



TRONINHO PLAST BABY ROSA 3636

Código: 6456 Fábrica: TRITEC Unidade: UN/1
F1 F4

UN: R\$ 4,52 AV: R\$ 4,52 15: R\$ 4,62
30: R\$ 4,71 45: R\$ 4,80 60: R\$ 4,90



UNIAO PLAST MANGUEIRA STANDARD 215

Código: 40242 Fábrica: MONTEREY Unidade: UN/1
F1 F4

UN: R\$ 1,96 AV: R\$ 48,95 15: R\$ 49,97
30: R\$ 50,97 45: R\$ 51,99 60: R\$ 53,03



UNIAO 1/2 P/IRRIGACAO INTERNA 25X1

Código: 50817 Fábrica: MC LOREN Unidade: PT/25
F1 F4

UN: R\$ 0,51 AV: R\$ 25,45 15: R\$ 25,98
30: R\$ 26,50 45: R\$ 27,03 60: R\$ 27,57



UNIAO 1/2 P/MANGUEIRA PRETO UN51N 50X1

Código: 40151 Fábrica: REBOUCAS Unidade: PT/50
F1 F4

UN: R\$ 0,59 AV: R\$ 29,37 15: R\$ 29,98
30: R\$ 30,58 45: R\$ 31,19 60: R\$ 31,81



UNIAO 3/4 P/MANGUEIRA PRETO UN52N 50X1

Código: 40152 Fábrica: REBOUCAS Unidade: PT/50
F1 F4

UN: R\$ 6,41 AV: R\$ 6,41 15: R\$ 6,55
30: R\$ 6,68 45: R\$ 6,81 60: R\$ 6,95



URINOL GRANDE PLAST 5017

Código: 14026 Fábrica: SBRISSA Unidade: UN/1
F1 F4

UN: R\$ 8,12 AV: R\$ 8,12 15: R\$ 8,29
30: R\$ 8,45 45: R\$ 8,62 60: R\$ 8,79



URINOL PLAST 713

Código: Fábrica: Unidade:
37261 LUMAR UN/1
F1 F4

UN: R\$ 8,80 AV: R\$ 8,80 15: R\$ 8,99
30: R\$ 9,17 45: R\$ 9,35 60: R\$ 9,54



URINOL PLASTICO GDE 113

Código: Fábrica: Unidade:
20915 ECOPLASTIC UN/1
F1 F4

UN: R\$ 3,71 AV: R\$ 3,71 15: R\$ 3,79
30: R\$ 3,86 45: R\$ 3,94 60: R\$ 4,02



VALVULA GATILHO P/PULVERIZADOR 28

Código: Fábrica: Unidade:
49398 ARBRA UN/1
F1 F4

UN: R\$ 8,98 AV: R\$ 107,71 15: R\$ 109,96
30: R\$ 112,16 45: R\$ 114,40 60: R\$ 116,69



VALVULA P/TANQUE 1.1/4" MET VC53N 12X1

Código: Fábrica: Unidade:
40155 REBOUCAS PT/12
F1 F4

UN: R\$ 4,57 AV: R\$ 54,83 15: R\$ 55,97
30: R\$ 57,09 45: R\$ 58,23 60: R\$ 59,39



VALVULA P/TANQUE 1.1/4" PLAS VO53N 12X1

Código: Fábrica: Unidade:
40156 REBOUCAS PT/12
F1 F4

UN: R\$ 2,35 AV: R\$ 23,49 15: R\$ 23,98
30: R\$ 24,46 45: R\$ 24,95 60: R\$ 25,45



VALVULA SEG PAINELA PRESS METAL 2000 10X1

Código: Fábrica: Unidade:
25505 PINOLAR PT/10
F1 F4

UN: R\$ 1,96 AV: R\$ 19,57 15: R\$ 19,98
30: R\$ 20,38 45: R\$ 20,79 60: R\$ 21,21



VALVULA SEG PAINELA PRESS SILIC 6000 10X1

Código: Fábrica: Unidade:
31035 PINOLAR PT/10
F1 F4

UN: R\$ 2,44 AV: R\$ 4,88 15: R\$ 4,98
30: R\$ 5,08 45: R\$ 5,18 60: R\$ 5,28



VALVULA (SELO) PAINELA PRESSAO 62 2X1

Código: Fábrica: Unidade:
49742 NOVA MARCA CR/2
F1 F4

UN: R\$ 11,54 AV: R\$ 11,54 15: R\$ 11,79
30: R\$ 12,02 45: R\$ 12,26 60: R\$ 12,51



VARAL MULTIUSO N1 08 PRENDEDORES 433

Código: Fábrica: Unidade:
38887 LIG BRIN UN/1
F1 F4

UN: R\$ 21,53 AV: R\$ 21,53 15: R\$ 21,98
30: R\$ 22,42 45: R\$ 22,87 60: R\$ 23,33



VARAL MULTIUSO N2 16 PRENDEDORES 440

Código: Fábrica: Unidade:
38888 LIG BRIN UN/1
F1 F4

UN: R\$ 29,37 AV: R\$ 29,37 15: R\$ 29,98
30: R\$ 30,58 45: R\$ 31,19 60: R\$ 31,81



VARAL MULTIUSO N3 26 PRENDEDORES 471

Código: Fábrica: Unidade:
38886 LIG BRIN UN/1
F1 F4

UN: R\$ 45,03 AV: R\$ 45,03 15: R\$ 45,97
30: R\$ 46,89 45: R\$ 47,83 60: R\$ 48,79



VARAL MULTIUSO N4 36 PRENDEDORES 587

Código: Fábrica: Unidade:
38889 LIG BRIN UN/1
F1 F4

UN: R\$ 71,47 AV: R\$ 71,47 15: R\$ 72,96
30: R\$ 74,42 45: R\$ 75,91 60: R\$ 77,43

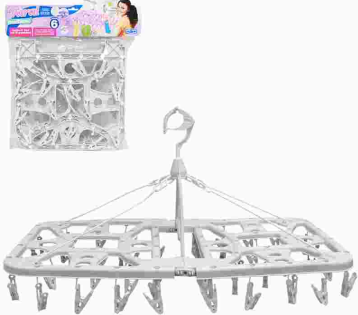

VARAL MULTIUSO N6 48 PRENDEDORES 624

Código: Fábrica: Unidade:
38891 LIG BRIN UN/1
F1 F4

UN: R\$ 12,72 AV: R\$ 12,72 15: R\$ 12,98
30: R\$ 13,24 45: R\$ 13,51 60: R\$ 13,78



VARAL PLAST MULTIUSO 12 PRENDEDORES 0219

Código: Fábrica: Unidade:
31365 TALBERG UN/1
F1 F4

UN: R\$ 39,16 AV: R\$ 39,16 15: R\$ 39,97
30: R\$ 40,77 45: R\$ 41,59 60: R\$ 42,42



VARAO (BASTAO) EXTENSIV METAL 1,40A2,60M

Código: Fábrica: Unidade:
47374 ALTIHOME UN/1
F1 F4

UN: R\$ 0,12 AV: R\$ 12,23 15: R\$ 12,49
30: R\$ 12,73 45: R\$ 12,99 60: R\$ 13,25



VARETA BAMBU ALGODAO DOCE 40CM 100X1

Código: Fábrica: Unidade:
50075 BOMPACK PT/100
F1 F4

UN: R\$ 6,46 AV: R\$ 6,46 15: R\$ 6,60
30: R\$ 6,73 45: R\$ 6,86 60: R\$ 7,00



VASO CERAMICA MINI 5,5X6CM 172116

Código: 34775 Fábrica: FREECOM Unidade: UN/1 F1 F4

UN: R\$ 26,44 AV: R\$ 26,44 15: R\$ 26,99
30: R\$ 27,53 45: R\$ 28,08 60: R\$ 28,64

12 cm
15 cm
1,3 lts



VASO ELEGANCE AUTOIRRIG 03 CAFE IMP 1,3L

Código: 34619 Fábrica: NUTRIPLAN Unidade: UN/1 F1 F4

UN: R\$ 31,92 AV: R\$ 31,92 15: R\$ 32,59
30: R\$ 33,24 45: R\$ 33,90 60: R\$ 34,58

16 cm
15 cm
1,8 lts



VASO ELEGANCE AUTOIRRIG 3,5 TRAVERT 1,8L

Código: 34620 Fábrica: NUTRIPLAN Unidade: UN/1 F1 F4

UN: R\$ 1,41 AV: R\$ 1,41 15: R\$ 1,44
30: R\$ 1,47 45: R\$ 1,50 60: R\$ 1,53

415 ml



VASO PL 1 RED PEQ MARROM 415ML

Código: 39638 Fábrica: NUTRIPLAN Unidade: UN/1 F1 F4

UN: R\$ 1,29 AV: R\$ 1,29 15: R\$ 1,32
30: R\$ 1,35 45: R\$ 1,37 60: R\$ 1,40

7,8cm
10,2cm



VASO PL 1 RED PEQ PRETO 415ML

Código: 18470 Fábrica: NUTRIPLAN Unidade: UN/1 F1 F4

UN: R\$ 2,93 AV: R\$ 2,93 15: R\$ 2,99
30: R\$ 3,05 45: R\$ 3,11 60: R\$ 3,17

12cm
16cm
1lts



VASO PL 1,0 L RED PEQ TERRACOTA 6715

Código: 26766 Fábrica: INPLAST Unidade: UN/1 F1 F4

UN: R\$ 1,74 AV: R\$ 1,74 15: R\$ 1,78
30: R\$ 1,81 45: R\$ 1,85 60: R\$ 1,89

9 cm
12 cm
0,75 L



VASO PL 1,5 RED PEQ PRETO 750ML

Código: 33551 Fábrica: NUTRIPLAN Unidade: UN/1 F1 F4

UN: R\$ 2,87 AV: R\$ 2,87 15: R\$ 2,93
30: R\$ 2,99 45: R\$ 3,05 60: R\$ 3,11

9 cm
13 cm
01 L



VASO PL 2 RED PEQ MARROM 1LT

Código: 33537 Fábrica: NUTRIPLAN Unidade: UN/1 F1 F4

UN: R\$ 2,12 AV: R\$ 2,12 15: R\$ 2,16
30: R\$ 2,20 45: R\$ 2,25 60: R\$ 2,29

9,8cm
13cm



VASO PL 2 RED PEQ PRETO 1LT

Código: 18471 Fábrica: NUTRIPLAN Unidade: UN/1 F1 F4

UN: R\$ 3,29 AV: R\$ 3,29 15: R\$ 3,36
30: R\$ 3,43 45: R\$ 3,49 60: R\$ 3,56

11 cm
14 cm
1,4 L



VASO PL 2,5 RED PEQ MARROM 1,4LTS

Código: 33538 Fábrica: NUTRIPLAN Unidade: UN/1 F1 F4

UN: R\$ 2,99 AV: R\$ 2,99 15: R\$ 3,05
30: R\$ 3,11 45: R\$ 3,17 60: R\$ 3,24

10,5cm
14,5cm



VASO PL 2,5 RED PEQ PRETO 1,4LTS

Código: 18472 Fábrica: NUTRIPLAN Unidade: UN/1 F1 F4

UN: R\$ 5,39 AV: R\$ 5,39 15: R\$ 5,50
30: R\$ 5,61 45: R\$ 5,72 60: R\$ 5,83



VASO PL 3 LTS QUAD PRETO 7002

Código: 40417 Fábrica: FORMPLAST Unidade: UN/1 F1 F4

UN: R\$ 5,07 AV: R\$ 5,07 15: R\$ 5,18
30: R\$ 5,28 45: R\$ 5,39 60: R\$ 5,49

12 cm
17 cm
02 L



VASO PL 3 RED PEQ MARROM 2LTS

Código: 33539 Fábrica: NUTRIPLAN Unidade: UN/1 F1 F4

UN: R\$ 4,40 AV: R\$ 4,40 15: R\$ 4,49
30: R\$ 4,58 45: R\$ 4,67 60: R\$ 4,76

12,5cm
17cm



VASO PL 3 RED PEQ PRETO 2LTS

Código: 18473 Fábrica: NUTRIPLAN Unidade: UN/1 F1 F4

UN: R\$ 7,59 AV: R\$ 7,59 15: R\$ 7,75
30: R\$ 7,90 45: R\$ 8,06 60: R\$ 8,22

15 cm
20 cm
03 L



VASO PL 3,5 RED MED MARROM 3LTS

Código: 33552 Fábrica: NUTRIPLAN Unidade: UN/1 F1 F4

UN: R\$ 10,50 AV: R\$ 10,50 15: R\$ 10,72
30: R\$ 10,93 45: R\$ 11,15 60: R\$ 11,37

17 cm
21 cm
4,9 L



VASO PL 4 RED MED MARROM 4,9LTS

Código: 26911 Fábrica: NUTRIPLAN Unidade: UN/1 F1 F4

UN: R\$ 7,59 AV: R\$ 7,59 15: R\$ 7,75
30: R\$ 7,90 45: R\$ 8,06 60: R\$ 8,22

17cm
21cm



VASO PL 4 RED MED PRETO 4,9LTS

Código: 18475 Fábrica: NUTRIPLAN Unidade: UN/1 F1 F4

UN: R\$ 14,68 AV: R\$ 14,68 15: R\$ 14,98
30: R\$ 15,28 45: R\$ 15,59 60: R\$ 15,90

23 cm
26 cm
8,7 L



VASO PL 5 RED GDE MARROM 8,7LTS

Código: 33553 Fábrica: NUTRIPLAN Unidade: UN/1 F1 F4

UN: R\$ 14,68 AV: R\$ 14,68 15: R\$ 14,98
30: R\$ 15,28 45: R\$ 15,59 60: R\$ 15,90

23cm
26cm



VASO PL 5 RED GDE PRETO 8,7LTS

Código: 18476 Fábrica: NUTRIPLAN Unidade: UN/1 F1 F4

UN: R\$ 7,33 AV: R\$ 7,33 15: R\$ 7,49
30: R\$ 7,64 45: R\$ 7,79 60: R\$ 7,95



VASO PL 5LTS MARFIM 6412

Código: 41480 Fábrica: KOZI PLAST Unidade: UN/1 F1 F4

UN: R\$ 5,14 AV: R\$ 5,14 15: R\$ 5,25
30: R\$ 5,35 45: R\$ 5,46 60: R\$ 5,57



VASO PL 5LTS PRETO 6400

Código: 41494 Fábrica: KOZI PLAST Unidade: UN/1 F1 F4

UN: R\$ 22,86 AV: R\$ 22,86 15: R\$ 23,34
30: R\$ 23,81 45: R\$ 24,28 60: R\$ 24,77

25 cm
20 cm
12 L



VASO PL 6 RED GDE MARROM 12LTS

Código: 33554 Fábrica: NUTRIPLAN Unidade: UN/1 F1 F4

UN: R\$ 18,60 AV: R\$ 18,60 15: R\$ 18,98
30: R\$ 19,36 45: R\$ 19,75 60: R\$ 20,14

25cm
37 cm
30cm



VASO PL 6 RED GDE PRETO 12LTS

Código: 18477 Fábrica: NUTRIPLAN Unidade: UN/1 F1 F4

UN: R\$ 33,28 AV: R\$ 33,28 15: R\$ 33,98
30: R\$ 34,66 45: R\$ 35,35 60: R\$ 36,06

29 cm
37 cm
21,5 L



VASO PL 7 RED GDE MARROM 21,5LTS

Código: 33555 Fábrica: NUTRIPLAN Unidade: UN/1 F1 F4

UN: R\$ 33,28 AV: R\$ 33,28 15: R\$ 33,98
30: R\$ 34,66 45: R\$ 35,35 60: R\$ 36,06

29cm
37cm



VASO PL 7 RED GDE PRETO 21,2LTS

Código: 18478 Fábrica: NUTRIPLAN Unidade: UN/1 F1 F4

UN: R\$ 74,42 AV: R\$ 74,42 15: R\$ 75,97
30: R\$ 77,49 45: R\$ 79,04 60: R\$ 80,62

38 cm
44 cm
42,5 L



VASO PL 8 RED GIG MARROM 42,5LTS

Código: 33535 Fábrica: NUTRIPLAN Unidade: UN/1 F1 F4

UN: R\$ 65,61 AV: R\$ 65,61 15: R\$ 66,97
30: R\$ 68,31 45: R\$ 69,68 60: R\$ 71,07

38 cm
44 cm
42,5 L



VASO PL 8 RED GIG PRETO 42,5LTS

Código: 33536 Fábrica: NUTRIPLAN Unidade: UN/1 F1 F4

UN: R\$ 97,43 AV: R\$ 97,43 15: R\$ 99,46
30: R\$ 101,45 45: R\$ 103,48 60: R\$ 105,55

45 cm
51 cm
65Lts



VASO PL 9 RED GIG PRETO 65LTS

Código: 39639 Fábrica: NUTRIPLAN Unidade: UN/1 F1 F4

UN: R\$ 19,58 AV: R\$ 19,58 15: R\$ 19,99
30: R\$ 20,39 45: R\$ 20,80 60: R\$ 21,22

21,5cm
29 cm
30 lts



VASO PL ADRI 30 PRETO 8L 788

Código: 37712 Fábrica: BIG PLAST Unidade: UN/1 F1 F4

UN: R\$ 6,35 AV: R\$ 6,35 15: R\$ 6,48
30: R\$ 6,61 45: R\$ 6,74 60: R\$ 6,87



VASO PL AQUARELA 2,5 RED AMARELO CLARO

Código: 35709 Fábrica: NUTRIPLAN Unidade: UN/1 F1 F4

UN: R\$ 6,45 AV: R\$ 6,45 15: R\$ 6,59
30: R\$ 6,72 45: R\$ 6,85 60: R\$ 6,99



VASO PL AQUARELA 2,5 RED LILAS CLARO

Código: 35710 Fábrica: NUTRIPLAN Unidade: UN/1 F1 F4

UN: R\$ 6,45 AV: R\$ 6,45 15: R\$ 6,59
30: R\$ 6,72 45: R\$ 6,85 60: R\$ 6,99



VASO PL AQUARELA 2,5 RED ROSA BEBE

Código: 35711 Fábrica: NUTRIPLAN Unidade: UN/1 F1 F4

UN: R\$ 6,35 AV: R\$ 6,35 15: R\$ 6,48
30: R\$ 6,61 45: R\$ 6,74 60: R\$ 6,87



VASO PL AQUARELA 2,5 RED VERDE CLARO

Código: 35712 Fábrica: NUTRIPLAN Unidade: UN/1 F1 F4

UN: R\$ 8,18 AV: R\$ 8,18 15: R\$ 8,35
30: R\$ 8,51 45: R\$ 8,68 60: R\$ 8,86

14 cm
15 cm
1,6 lts



VASO PL AQUARELA 3,5 RED AMARELO CL 1,7L

Código: 34600 Fábrica: NUTRIPLAN Unidade: UN/1 F1 F4

UN: R\$ 8,18 AV: R\$ 8,18 15: R\$ 8,35
30: R\$ 8,51 45: R\$ 8,68 60: R\$ 8,86

14 cm
15 cm
1,6 lts



VASO PL AQUARELA 3,5 RED VERDE CLAR 1,7L

Código: 34603 Fábrica: NUTRIPLAN Unidade: UN/1 F1 F4

UN: R\$ 21,30 AV: R\$ 21,30 15: R\$ 21,74
30: R\$ 22,18 45: R\$ 22,62 60: R\$ 23,07

13 cm
19 cm



VASO PL AZALEIA QUAD CAFE 1132

Código: 37215 Fábrica: PAIOL Unidade: UN/1 F1 F4

UN: R\$ 49,35 AV: R\$ 49,35 15: R\$ 50,38
30: R\$ 51,39 45: R\$ 52,42 60: R\$ 53,46

35 cm
28,5 cm



VASO PL BACIA GREGA P AZUL 29-9

Código: 40022 Fábrica: PAIOL Unidade: UN/1 F1 F4

UN: R\$ 55,80 AV: R\$ 55,80 15: R\$ 56,97
30: R\$ 58,11 45: R\$ 59,27 60: R\$ 60,45

35 cm
28,5 cm



VASO PL BACIA GREGA P BEGE 29-1

Código: 40021 Fábrica: PAIOL Unidade: UN/1 F1 F4

UN: R\$ 188,44 AV: R\$ 188,44 15: R\$ 192,36
30: R\$ 196,21 45: R\$ 200,13 60: R\$ 204,14

45 cm
28 cm



VASO PL BAMBU OVAL 45 CARVALHO 22LTS

Código: 34609 Fábrica: NUTRIPLAN Unidade: UN/1 F1 F4

UN: R\$ 15,03 AV: R\$ 15,03 15: R\$ 15,34
30: R\$ 15,65 45: R\$ 15,96 60: R\$ 16,28

30 cm
35 cm
13,5 L



VASO PL BELLA FIOR RED 35 PTO 13,5L 9201

Código: 45208 Fábrica: RISCHIOTO Unidade: UN/1 F1 F4

UN: R\$ 21,45 AV: R\$ 21,45 15: R\$ 21,90
30: R\$ 22,34 45: R\$ 22,79 60: R\$ 23,24

36 cm
42 cm
29,6 L



VASO PL BELLA FIORE RED 42 PTO 25L 9202

Código: 45209 Fábrica: RISCHIOTO Unidade: UN/1 F1 F4

UN: R\$ 8,61 AV: R\$ 8,61 15: R\$ 8,79
30: R\$ 8,96 45: R\$ 9,14 60: R\$ 9,32

24 cm
28 cm
9,7 L



VASO PL BELLA QUAD 28 PTO 9,7LTS 9250

Código: 45204 Fábrica: RISCHIOTO Unidade: UN/1 F1 F4

UN: R\$ 5,38 AV: R\$ 5,38 15: R\$ 5,49
30: R\$ 5,60 45: R\$ 5,71 60: R\$ 5,82

19 cm
22 cm
4 L



VASO PL BELLA RED 22 PTO 4LTS 9199

Código: 45206 Fábrica: RISCHIOTO Unidade: UN/1 F1 F4

UN: R\$ 43,50 AV: R\$ 43,50 15: R\$ 44,40
30: R\$ 45,29 45: R\$ 46,20 60: R\$ 47,12

43 cm
50 cm
42,5 L



VASO PL BELLA RED 50 PTO 42,5LTS 9203

Código: 45210 Fábrica: RISCHIOTO Unidade: UN/1 F1 F4

UN: R\$ 40,25 AV: R\$ 40,25 15: R\$ 41,09
30: R\$ 41,92 45: R\$ 42,75 60: R\$ 43,61

25 cm
26 cm



VASO PL CACHEPO GDE SISAL 1725

Código: 37217 Fábrica: PAIOL Unidade: UN/1 F1 F4

UN: R\$ 139,05 AV: R\$ 139,05 15: R\$ 141,94
30: R\$ 144,78 45: R\$ 147,68 60: R\$ 150,63

70 cm
38 cm
27,5 lts



VASO PL CLASS CONE 70 VERDE GUATEMA 27,5L

Código: 39652 Fábrica: NUTRIPLAN Unidade: UN/1 F1 F4

UN: R\$ 220,32 AV: R\$ 220,32 15: R\$ 224,91
30: R\$ 229,41 45: R\$ 234,00 60: R\$ 238,68

65 cm
38 cm
50 lts



VASO PL CLASS CONICO 66 VERDE GUATEMA 50L

Código: 39647 Fábrica: NUTRIPLAN Unidade: UN/1 F1 F4

UN: R\$ 129,61 AV: R\$ 129,61 15: R\$ 132,31
30: R\$ 134,95 45: R\$ 137,65 60: R\$ 140,41

33 cm
35 cm
22 lts



VASO PL CLASS RED 33 VERDE GUATEMALA 22L

Código: 39648 Fábrica: NUTRIPLAN Unidade: UN/1 F1 F4

UN: R\$ 117,49 AV: R\$ 117,49 15: R\$ 119,94
 30: R\$ 122,34 45: R\$ 124,79 60: R\$ 127,28





VASO PL CLASSIC CILINDRICO 32 AREIA 35LT
 Código: 30277 Fábrica: NUTRIPLAN Unidade: UN/1
 F1 F4

UN: R\$ 107,70 AV: R\$ 107,70 15: R\$ 109,95
 30: R\$ 112,14 45: R\$ 114,39 60: R\$ 116,68



VASO PL CLASSIC CILINDRICO 32 AZUL COB
 Código: 41390 Fábrica: NUTRIPLAN Unidade: UN/1
 F1 F4

UN: R\$ 127,29 AV: R\$ 127,29 15: R\$ 129,94
 30: R\$ 132,54 45: R\$ 135,19 60: R\$ 137,89



VASO PL CLASSIC CILINDRICO 32 FERRU 35L
 Código: 30278 Fábrica: NUTRIPLAN Unidade: UN/1
 F1 F4

UN: R\$ 137,08 AV: R\$ 137,08 15: R\$ 139,93
 30: R\$ 142,73 45: R\$ 145,59 60: R\$ 148,50



VASO PL CLASSIC CILINDRICO 75 AREIA
 Código: 42173 Fábrica: NUTRIPLAN Unidade: UN/1
 F1 F4

UN: R\$ 137,08 AV: R\$ 137,08 15: R\$ 139,93
 30: R\$ 142,73 45: R\$ 145,59 60: R\$ 148,50



VASO PL CLASSIC CILINDRICO 75 AZUL COB
 Código: 42169 Fábrica: NUTRIPLAN Unidade: UN/1
 F1 F4

UN: R\$ 137,08 AV: R\$ 137,08 15: R\$ 139,93
 30: R\$ 142,73 45: R\$ 145,59 60: R\$ 148,50



VASO PL CLASSIC CILINDRICO 75 FERRUGEM
 Código: 42172 Fábrica: NUTRIPLAN Unidade: UN/1
 F1 F4

UN: R\$ 55,57 AV: R\$ 55,57 15: R\$ 56,73
 30: R\$ 57,86 45: R\$ 59,02 60: R\$ 60,20

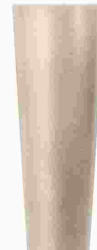



VASO PL CLASSIC CONE 30 AREIA
 Código: 36801 Fábrica: NUTRIPLAN Unidade: UN/1
 F1 F4

UN: R\$ 55,57 AV: R\$ 55,57 15: R\$ 56,73
 30: R\$ 57,86 45: R\$ 59,02 60: R\$ 60,20





VASO PL CLASSIC CONE 30 COBRE
 Código: 36803 Fábrica: NUTRIPLAN Unidade: UN/1
 F1 F4

UN: R\$ 55,57 AV: R\$ 55,57 15: R\$ 56,73
 30: R\$ 57,86 45: R\$ 59,02 60: R\$ 60,20





VASO PL CLASSIC CONE 30 FERRUGEM
 Código: 36799 Fábrica: NUTRIPLAN Unidade: UN/1
 F1 F4

UN: R\$ 55,57 AV: R\$ 55,57 15: R\$ 56,73
 30: R\$ 57,86 45: R\$ 59,02 60: R\$ 60,20





VASO PL CLASSIC CONE 30 RUBI
 Código: 36802 Fábrica: NUTRIPLAN Unidade: UN/1
 F1 F4

UN: R\$ 139,05 AV: R\$ 139,05 15: R\$ 141,94
 30: R\$ 144,78 45: R\$ 147,68 60: R\$ 150,63



VASO PL CLASSIC CONE 70 AREIA
 Código: 36798 Fábrica: NUTRIPLAN Unidade: UN/1
 F1 F4

UN: R\$ 117,49 AV: R\$ 117,49 15: R\$ 119,94
 30: R\$ 122,34 45: R\$ 124,79 60: R\$ 127,28



VASO PL CLASSIC CONE 70 AZUL COB
 Código: 41382 Fábrica: NUTRIPLAN Unidade: UN/1
 F1 F4

UN: R\$ 139,05 AV: R\$ 139,05 15: R\$ 141,94
 30: R\$ 144,78 45: R\$ 147,68 60: R\$ 150,63





VASO PL CLASSIC CONE 70 GRAFITE
 Código: 36797 Fábrica: NUTRIPLAN Unidade: UN/1
 F1 F4

UN: R\$ 88,12 AV: R\$ 88,12 15: R\$ 89,95
 30: R\$ 91,75 45: R\$ 93,59 60: R\$ 95,46



VASO PL CLASSIC CONICO 46 AZUL COB 50L
 Código: 41384 Fábrica: NUTRIPLAN Unidade: UN/1
 F1 F4

UN: R\$ 97,91 AV: R\$ 97,91 15: R\$ 99,95
 30: R\$ 101,95 45: R\$ 103,99 60: R\$ 106,07



VASO PL CLASSIC CONICO 46 GRAFITE 18LTS
 Código: 32739 Fábrica: NUTRIPLAN Unidade: UN/1
 F1 F4

UN: R\$ 156,66 AV: R\$ 156,66 15: R\$ 159,93
 30: R\$ 163,12 45: R\$ 166,39 60: R\$ 169,71



VASO PL CLASSIC CONICO 66 AZUL COB
 Código: 41400 Fábrica: NUTRIPLAN Unidade: UN/1
 F1 F4

UN: R\$ 235,07 AV: R\$ 235,07 15: R\$ 239,96
30: R\$ 244,76 45: R\$ 249,66 60: R\$ 254,65

65 cm
38 cm
50 lts



VASO PL CLASSIC CONICO 66 GRAFITE 50LTS

Código: 32738 Fábrica: NUTRIPLAN Unidade: UN/1 F1 F4

UN: R\$ 213,47 AV: R\$ 213,47 15: R\$ 217,91
30: R\$ 222,27 45: R\$ 226,72 60: R\$ 231,25

65 cm
38 cm
50 lts



VASO PL CLASSIC CONICO 66 RUBI 50LTS

Código: 32737 Fábrica: NUTRIPLAN Unidade: UN/1 F1 F4

UN: R\$ 75,40 AV: R\$ 75,40 15: R\$ 76,97
30: R\$ 78,51 45: R\$ 80,08 60: R\$ 81,68

26 cm
27,5 cm
11 lts



VASO PL CLASSIC REDONDO 26 AREIA 11LTS

Código: 33398 Fábrica: NUTRIPLAN Unidade: UN/1 F1 F4

UN: R\$ 74,82 AV: R\$ 74,82 15: R\$ 76,38
30: R\$ 77,91 45: R\$ 79,47 60: R\$ 81,05

26 cm
27,5 cm
11 lts



VASO PL CLASSIC REDONDO 26 FERRUGEM 11LT

Código: 33392 Fábrica: NUTRIPLAN Unidade: UN/1 F1 F4

UN: R\$ 177,24 AV: R\$ 177,24 15: R\$ 180,93
30: R\$ 184,55 45: R\$ 188,24 60: R\$ 192,00

40 cm
42,6 cm
45 lts



VASO PL CLASSIC REDONDO 40 RUBI 45LTS

Código: 34097 Fábrica: NUTRIPLAN Unidade: UN/1 F1 F4

UN: R\$ 381,88 AV: R\$ 381,88 15: R\$ 389,83
30: R\$ 397,63 45: R\$ 405,58 60: R\$ 413,70

62 cm
67 cm



VASO PL CLASSIC REDONDO 62 FERRUGEM 170LTS

Código: 30331 Fábrica: NUTRIPLAN Unidade: UN/1 F1 F4

UN: R\$ 19,57 AV: R\$ 19,57 15: R\$ 19,98
30: R\$ 20,38 45: R\$ 20,79 60: R\$ 21,21



VASO PL COLOR M 951994

Código: 41203 Fábrica: PLASTSU Unidade: UN/1 F1 F4

UN: R\$ 17,62 AV: R\$ 17,62 15: R\$ 17,98
30: R\$ 18,34 45: R\$ 18,71 60: R\$ 19,08



VASO PL COLOR P 9LTS 951512

Código: 41201 Fábrica: PLASTSU Unidade: UN/1 F1 F4

UN: R\$ 16,45 AV: R\$ 16,45 15: R\$ 16,79
30: R\$ 17,13 45: R\$ 17,47 60: R\$ 17,82

28 cm
21 cm
8 lts



VASO PL COLUNA MARROM 8 LTS 2302

Código: 36994 Fábrica: ERCAPLAST Unidade: UN/1 F1 F4

UN: R\$ 19,58 AV: R\$ 19,58 15: R\$ 19,99
30: R\$ 20,39 45: R\$ 20,80 60: R\$ 21,22

34 cm
25 cm
13,5 lts



VASO PL COLUNA PRETO 13,5 LTS 2344

Código: 36992 Fábrica: ERCAPLAST Unidade: UN/1 F1 F4

UN: R\$ 13,71 AV: R\$ 13,71 15: R\$ 13,99
30: R\$ 14,27 45: R\$ 14,56 60: R\$ 14,85

28 cm
21 cm
8 lts



VASO PL COLUNA PRETO 8 LTS 2301

Código: 36993 Fábrica: ERCAPLAST Unidade: UN/1 F1 F4

UN: R\$ 82,25 AV: R\$ 82,25 15: R\$ 83,97
30: R\$ 85,65 45: R\$ 87,36 60: R\$ 89,11

35 cm
28,5 cm

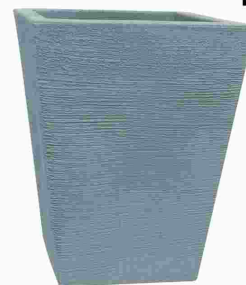

VASO PL COLUNA QUAD PEQ AZUL 79-7

Código: 39961 Fábrica: PAIOL Unidade: UN/1 F1 F4

UN: R\$ 97,53 AV: R\$ 97,53 15: R\$ 99,56
30: R\$ 101,55 45: R\$ 103,58 60: R\$ 105,65

35 cm
28,5 cm



VASO PL COLUNA QUAD PEQ BEGE 79-3

Código: 39959 Fábrica: PAIOL Unidade: UN/1 F1 F4

UN: R\$ 82,25 AV: R\$ 82,25 15: R\$ 83,97
30: R\$ 85,65 45: R\$ 87,36 60: R\$ 89,11

35 cm
28,5 cm



VASO PL COLUNA QUAD PEQ CIMENTO 79-4

Código: 39960 Fábrica: PAIOL Unidade: UN/1 F1 F4

UN: R\$ 82,25 AV: R\$ 82,25 15: R\$ 83,97
30: R\$ 85,65 45: R\$ 87,36 60: R\$ 89,11

35 cm
28,5 cm



VASO PL COLUNA QUAD PEQ MARROM 79-7

Código: 39958 Fábrica: PAIOL Unidade: UN/1 F1 F4

UN: R\$ 49,35 AV: R\$ 49,35 15: R\$ 50,38
30: R\$ 51,39 45: R\$ 52,42 60: R\$ 53,46

27 cm
22 cm



VASO PL COLUNA QUAD PP AZUL 99-7

Código: 39957 Fábrica: PAIOL Unidade: UN/1 F1 F4

UN: R\$ 49,35 AV: R\$ 49,35 15: R\$ 50,38
 30: R\$ 51,39 45: R\$ 52,42 60: R\$ 53,46
 27 cm
 22 cm

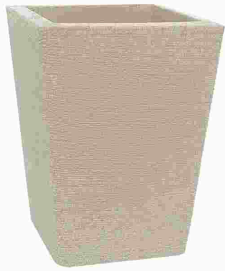

VASO PL COLUNA QUAD PP BEGE 99-1
 Código: Fábrica: Unidade:
39955 PAIOL UN/1
 F1 F4

UN: R\$ 49,35 AV: R\$ 49,35 15: R\$ 50,38
 30: R\$ 51,39 45: R\$ 52,42 60: R\$ 53,46
 27 cm
 22 cm

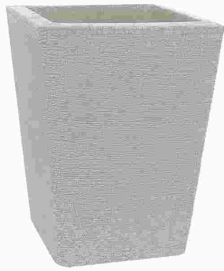

VASO PL COLUNA QUAD PP CIMENTO 99-3
 Código: Fábrica: Unidade:
39956 PAIOL UN/1
 F1 F4

UN: R\$ 49,35 AV: R\$ 49,35 15: R\$ 50,38
 30: R\$ 51,39 45: R\$ 52,42 60: R\$ 53,46
 27 cm
 22 cm



VASO PL COLUNA QUAD PP MARROM 99-2
 Código: Fábrica: Unidade:
39954 PAIOL UN/1
 F1 F4

UN: R\$ 49,35 AV: R\$ 49,35 15: R\$ 50,38
 30: R\$ 51,39 45: R\$ 52,42 60: R\$ 53,46
 26 cm
 21,5 cm



VASO PL COLUNA RED PP BEGE 50-1
 Código: Fábrica: Unidade:
39948 PAIOL UN/1
 F1 F4

UN: R\$ 49,35 AV: R\$ 49,35 15: R\$ 50,38
 30: R\$ 51,39 45: R\$ 52,42 60: R\$ 53,46
 26 cm
 21,5 cm



VASO PL COLUNA RED PP CIMENTO 50-3
 Código: Fábrica: Unidade:
39949 PAIOL UN/1
 F1 F4

UN: R\$ 55,93 AV: R\$ 55,93 15: R\$ 57,10
 30: R\$ 58,24 45: R\$ 59,40 60: R\$ 60,59
 29 cm
 26,5 cm



VASO PL COLUNA RED PP LISO AZUL B50-9
 Código: Fábrica: Unidade:
40027 PAIOL UN/1
 F1 F4

UN: R\$ 55,93 AV: R\$ 55,93 15: R\$ 57,10
 30: R\$ 58,24 45: R\$ 59,40 60: R\$ 60,59
 29 cm
 26,5 cm



VASO PL COLUNA RED PP LISO BEGE B50-1
 Código: Fábrica: Unidade:
40025 PAIOL UN/1
 F1 F4

UN: R\$ 58,74 AV: R\$ 58,74 15: R\$ 59,97
 30: R\$ 61,17 45: R\$ 62,39 60: R\$ 63,64
 29 cm
 26,5 cm

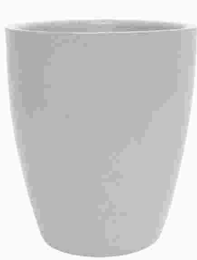

VASO PL COLUNA RED PP LISO CIMENTO B50-5
 Código: Fábrica: Unidade:
40026 PAIOL UN/1
 F1 F4

UN: R\$ 55,93 AV: R\$ 55,93 15: R\$ 57,10
 30: R\$ 58,24 45: R\$ 59,40 60: R\$ 60,59
 26 cm
 26,5 cm

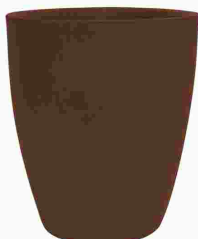

VASO PL COLUNA RED PP LISO MARROM B50-2
 Código: Fábrica: Unidade:
40024 PAIOL UN/1
 F1 F4

UN: R\$ 49,35 AV: R\$ 49,35 15: R\$ 50,38
 30: R\$ 51,39 45: R\$ 52,42 60: R\$ 53,46
 26 cm
 21,5 cm



VASO PL COLUNA RED PP MARROM 50-2
 Código: Fábrica: Unidade:
39947 PAIOL UN/1
 F1 F4

UN: R\$ 49,35 AV: R\$ 49,35 15: R\$ 50,38
 30: R\$ 51,39 45: R\$ 52,42 60: R\$ 53,46
 18,5 cm
 23 cm



VASO PL CONE BERLIAN GOLD PP AZUL A96-9
 Código: Fábrica: Unidade:
39942 PAIOL UN/1
 F1 F4

UN: R\$ 49,35 AV: R\$ 49,35 15: R\$ 50,38
 30: R\$ 51,39 45: R\$ 52,42 60: R\$ 53,46
 18,5 cm
 23 cm



VASO PL CONE BERLIAN GOLD PP BEGE A96-1
 Código: Fábrica: Unidade:
39940 PAIOL UN/1
 F1 F4

UN: R\$ 49,35 AV: R\$ 49,35 15: R\$ 50,38
 30: R\$ 51,39 45: R\$ 52,42 60: R\$ 53,46
 18,5 cm
 23 cm



VASO PL CONE BERLIAN GOLD PP MARRO A96-2
 Código: Fábrica: Unidade:
39939 PAIOL UN/1
 F1 F4

UN: R\$ 41,12 AV: R\$ 41,12 15: R\$ 41,97
 30: R\$ 42,81 45: R\$ 43,67 60: R\$ 44,54



VASO PL CONIC SINT S/BORDA M BANANAS011
 Código: Fábrica: Unidade:
41756 PAIOL UN/1
 F1 F4

UN: R\$ 29,37 AV: R\$ 29,37 15: R\$ 29,98
 30: R\$ 30,58 45: R\$ 31,19 60: R\$ 31,81
 21 cm
 24 cm



VASO PL CONIC SINT S/BORDA P BANANA3536
 Código: Fábrica: Unidade:
37124 PAIOL UN/1
 F1 F4

UN: R\$ 35,25 AV: R\$ 35,25 15: R\$ 35,99
 30: R\$ 36,71 45: R\$ 37,44 60: R\$ 38,19
 24 cm
 17 cm

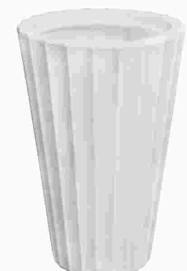

VASO PL CRETA CONICO 24 BRANCO 3LTS
 Código: Fábrica: Unidade:
34605 NUTRIPLAN UN/1
 F1 F4

UN: R\$ 35,25 AV: R\$ 35,25 15: R\$ 35,99
30: R\$ 36,71 45: R\$ 37,44 60: R\$ 38,19

11 24 cm
17 cm



VASO PL CRETA CONICO 24 TABACO 3LTS

Código: 34604 Fábrica: NUTRIPLAN Unidade: UN/1 F1 F4

UN: R\$ 283,97 AV: R\$ 283,97 15: R\$ 289,88
30: R\$ 295,68 45: R\$ 301,60 60: R\$ 307,63

11 60 cm
42 cm

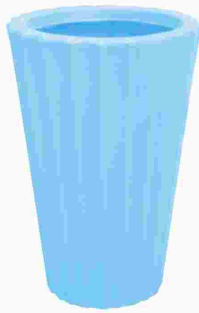

VASO PL CRETA CONICO 60 AZUL CELESTE 50L

Código: 35456 Fábrica: NUTRIPLAN Unidade: UN/1 F1 F4

UN: R\$ 197,80 AV: R\$ 197,80 15: R\$ 201,92
30: R\$ 205,96 45: R\$ 210,08 60: R\$ 214,28

11 60 cm
42 cm

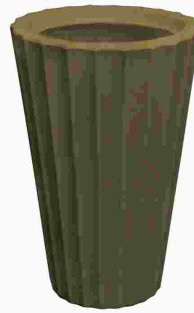

VASO PL CRETA CONICO 60 ENVELHECIDO 50LT

Código: 34607 Fábrica: NUTRIPLAN Unidade: UN/1 F1 F4

UN: R\$ 15,66 AV: R\$ 15,66 15: R\$ 15,98
30: R\$ 16,30 45: R\$ 16,63 60: R\$ 16,96

11 12 cm
17 cm



VASO PL CRISANTEMO CONE CAPIM 2582

Código: 37107 Fábrica: PAIOL Unidade: UN/1 F1 F4

UN: R\$ 20,55 AV: R\$ 20,55 15: R\$ 20,98
30: R\$ 21,40 45: R\$ 21,83 60: R\$ 22,27

11 13 cm
18 cm



VASO PL CRISANTEMO CONE SINT ARGILA 2674

Código: 37105 Fábrica: PAIOL Unidade: UN/1 F1 F4

UN: R\$ 23,49 AV: R\$ 23,49 15: R\$ 23,98
30: R\$ 24,46 45: R\$ 24,95 60: R\$ 25,45

11 14 cm
18 cm



VASO PL CRISANTEMO CONE SINT BANANA 2674

Código: 40118 Fábrica: PAIOL Unidade: UN/1 F1 F4

UN: R\$ 26,43 AV: R\$ 26,43 15: R\$ 26,98
30: R\$ 27,52 45: R\$ 28,07 60: R\$ 28,63

11 14 cm
19 cm



VASO PL CRISANTEMO RED MAD C/LACO 1459

Código: 37109 Fábrica: PAIOL Unidade: UN/1 F1 F4

UN: R\$ 19,57 AV: R\$ 19,57 15: R\$ 19,98
30: R\$ 20,38 45: R\$ 20,79 60: R\$ 21,21

11 14 cm
18 cm



VASO PL CRISANTEMO RED MADEIRA PT/BC5914

Código: 37116 Fábrica: PAIOL Unidade: UN/1 F1 F4

UN: R\$ 15,42 AV: R\$ 15,42 15: R\$ 15,74
30: R\$ 16,06 45: R\$ 16,38 60: R\$ 16,71

11 14 cm
20 cm



VASO PL CRISANTEMO RED SINT ARGILA 40435

Código: 37132 Fábrica: PAIOL Unidade: UN/1 F1 F4

UN: R\$ 26,43 AV: R\$ 26,43 15: R\$ 26,98
30: R\$ 27,52 45: R\$ 28,07 60: R\$ 28,63

11 14 cm
18,5 cm



VASO PL CRISANTEMO RED TEXTURA LACO 3208

Código: 40614 Fábrica: PAIOL Unidade: UN/1 F1 F4

UN: R\$ 3,25 AV: R\$ 3,25 15: R\$ 3,32
30: R\$ 3,39 45: R\$ 3,45 60: R\$ 3,52



VASO PL CUIA CLASSIC 22 MARROM/PRETO

Código: 30348 Fábrica: NUTRIPLAN Unidade: UN/1 F1 F4

UN: R\$ 2,73 AV: R\$ 2,73 15: R\$ 2,79
30: R\$ 2,84 45: R\$ 2,90 60: R\$ 2,96



VASO PL CUIA CLASSIC 22 PRETO

Código: 30349 Fábrica: NUTRIPLAN Unidade: UN/1 F1 F4

UN: R\$ 8,32 AV: R\$ 8,32 15: R\$ 8,50
30: R\$ 8,67 45: R\$ 8,84 60: R\$ 9,02

11 12cm
22cm
2,7lts



VASO PL CUIA NOBRE 1 C/PRATO MARROM

Código: 37857 Fábrica: NUTRIPLAN Unidade: UN/1 F1 F4

UN: R\$ 6,95 AV: R\$ 6,95 15: R\$ 7,10
30: R\$ 7,24 45: R\$ 7,38 60: R\$ 7,53

11 12cm
22cm
2,7lts



VASO PL CUIA NOBRE 1 C/PRATO PRETO

Código: 38674 Fábrica: NUTRIPLAN Unidade: UN/1 F1 F4

UN: R\$ 7,82 AV: R\$ 7,82 15: R\$ 7,99
30: R\$ 8,15 45: R\$ 8,31 60: R\$ 8,48

11 13cm
27cm



VASO PL CUIA NOBRE 1,5 PRETO 4,5LTS

Código: 48428 Fábrica: NUTRIPLAN Unidade: UN/1 F1 F4

UN: R\$ 8,80 AV: R\$ 8,80 15: R\$ 8,99
30: R\$ 9,17 45: R\$ 9,35 60: R\$ 9,54

11 6,5 cm
13 cm



VASO PL CUIA SINT 13 S/BORDA BANAN 27066

Código: 37099 Fábrica: PAIOL Unidade: UN/1 F1 F4

UN: R\$ 7,14 AV: R\$ 7,14 15: R\$ 7,29
30: R\$ 7,43 45: R\$ 7,58 60: R\$ 7,73





VASO PL CUIA SINT 13 S/BORDA CAFE 27066
Código: Fábrica: Unidade:
39454 PAIOL UN/1
F1 F4

UN: R\$ 7,14 AV: R\$ 7,14 15: R\$ 7,29
30: R\$ 7,43 45: R\$ 7,58 60: R\$ 7,73



VASO PL CUIA SINT 13 S/BORDA CAPUC 27066
Código: Fábrica: Unidade:
42967 PAIOL UN/1
F1 F4

UN: R\$ 12,72 AV: R\$ 12,72 15: R\$ 12,98
30: R\$ 13,24 45: R\$ 13,51 60: R\$ 13,78





VASO PL CUIA SINT 17 S/BORDA BANAN 26910
Código: Fábrica: Unidade:
39455 PAIOL UN/1
F1 F4

UN: R\$ 12,72 AV: R\$ 12,72 15: R\$ 12,98
30: R\$ 13,24 45: R\$ 13,51 60: R\$ 13,78





VASO PL CUIA SINT 17 S/BORDA CAFE 26910
Código: Fábrica: Unidade:
37098 PAIOL UN/1
F1 F4

UN: R\$ 12,72 AV: R\$ 12,72 15: R\$ 12,98
30: R\$ 13,24 45: R\$ 13,51 60: R\$ 13,78





VASO PL CUIA SINT 17 S/BORDA CAPUC 26910
Código: Fábrica: Unidade:
39456 PAIOL UN/1
F1 F4

UN: R\$ 18,60 AV: R\$ 18,60 15: R\$ 18,98
30: R\$ 19,36 45: R\$ 19,75 60: R\$ 20,14





VASO PL CUIA SINT 20 S/BORDA ARGIL 26909
Código: Fábrica: Unidade:
39457 PAIOL UN/1
F1 F4

UN: R\$ 18,60 AV: R\$ 18,60 15: R\$ 18,98
30: R\$ 19,36 45: R\$ 19,75 60: R\$ 20,14





VASO PL CUIA SINT 20 S/BORDA BANAN 26909
Código: Fábrica: Unidade:
37097 PAIOL UN/1
F1 F4

UN: R\$ 18,82 AV: R\$ 18,82 15: R\$ 19,21
30: R\$ 19,60 45: R\$ 19,99 60: R\$ 20,39





VASO PL CUIA SINT 20 S/BORDA CAFE 26909
Código: Fábrica: Unidade:
39458 PAIOL UN/1
F1 F4

UN: R\$ 22,51 AV: R\$ 22,51 15: R\$ 22,98
30: R\$ 23,44 45: R\$ 23,91 60: R\$ 24,39





VASO PL CUIA SINT 25 S/BORDA ARGIL 40468
Código: Fábrica: Unidade:
39461 PAIOL UN/1
F1 F4

UN: R\$ 22,51 AV: R\$ 22,51 15: R\$ 22,98
30: R\$ 23,44 45: R\$ 23,91 60: R\$ 24,39





VASO PL CUIA SINT 25 S/BORDA BANAN 40468
Código: Fábrica: Unidade:
37096 PAIOL UN/1
F1 F4

UN: R\$ 23,23 AV: R\$ 23,23 15: R\$ 23,71
30: R\$ 24,18 45: R\$ 24,67 60: R\$ 25,16





VASO PL CUIA SINT 25 S/BORDA CAFE 40468
Código: Fábrica: Unidade:
39460 PAIOL UN/1
F1 F4

UN: R\$ 35,24 AV: R\$ 35,24 15: R\$ 35,98
30: R\$ 36,70 45: R\$ 37,43 60: R\$ 38,18





VASO PL CUIA SINT 28 S/BORDA ARG 26896-1
Código: Fábrica: Unidade:
37095 PAIOL UN/1
F1 F4

UN: R\$ 39,16 AV: R\$ 39,16 15: R\$ 39,97
30: R\$ 40,77 45: R\$ 41,59 60: R\$ 42,42





VASO PL CUIA SINT 32 S/BORDA ARGIL 50523
Código: Fábrica: Unidade:
37094 PAIOL UN/1
F1 F4

UN: R\$ 45,53 AV: R\$ 45,53 15: R\$ 46,48
30: R\$ 47,41 45: R\$ 48,36 60: R\$ 49,33



VASO PL CUIA SINT 32 S/BORDA BANAN 50523
Código: Fábrica: Unidade:
41055 PAIOL UN/1
F1 F4

UN: R\$ 68,53 AV: R\$ 68,53 15: R\$ 69,96
30: R\$ 71,36 45: R\$ 72,79 60: R\$ 74,24



VASO PL CUIA SINT 40 S/BORDA ARGIL 26944
Código: Fábrica: Unidade:
37093 PAIOL UN/1
F1 F4

UN: R\$ 2,99 AV: R\$ 2,99 15: R\$ 3,05
30: R\$ 3,11 45: R\$ 3,17 60: R\$ 3,24



VASO PL CUIA 13 PRETO C/ALCA 350ML 15
Código: Fábrica: Unidade:
38359 BIG PLAST UN/1
F1 F4

UN: R\$ 4,03 AV: R\$ 4,03 15: R\$ 4,12
30: R\$ 4,20 45: R\$ 4,28 60: R\$ 4,37

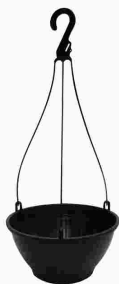

VASO PL CUIA 18 PRETO C/GANCHO 121
Código: 40795 Fábrica: NOVA BRASIL Unidade: UN/1 F1 F4

UN: R\$ 15,96 AV: R\$ 15,96 15: R\$ 16,29
30: R\$ 16,62 45: R\$ 16,95 60: R\$ 17,29



VASO PL CUIA 21 COLOR C/ALCA BA 2,4L 815
Código: 39854 Fábrica: BIG PLAST Unidade: UN/1 F1 F4

UN: R\$ 4,03 AV: R\$ 4,03 15: R\$ 4,12
30: R\$ 4,20 45: R\$ 4,28 60: R\$ 4,37

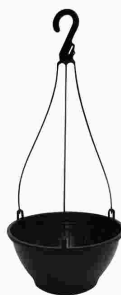

VASO PL CUIA 21 PRETO C/GANCHO 125
Código: 40796 Fábrica: NOVA BRASIL Unidade: UN/1 F1 F4

UN: R\$ 6,13 AV: R\$ 6,13 15: R\$ 6,26
30: R\$ 6,38 45: R\$ 6,51 60: R\$ 6,64



VASO PL CUIA 22 PRETO C/GANCHO 133
Código: 40797 Fábrica: NOVA BRASIL Unidade: UN/1 F1 F4

UN: R\$ 95,47 AV: R\$ 95,47 15: R\$ 97,46
30: R\$ 99,41 45: R\$ 101,40 60: R\$ 103,43



VASO PL DIAMANTE CONICO 38 AREIA 14LT
Código: 32744 Fábrica: NUTRIPLAN Unidade: UN/1 F1 F4

UN: R\$ 95,47 AV: R\$ 95,47 15: R\$ 97,46
30: R\$ 99,41 45: R\$ 101,40 60: R\$ 103,43



VASO PL DIAMANTE CONICO 38 FERRUGEM 14LT
Código: 32743 Fábrica: NUTRIPLAN Unidade: UN/1 F1 F4

UN: R\$ 79,32 AV: R\$ 79,32 15: R\$ 80,97
30: R\$ 82,59 45: R\$ 84,24 60: R\$ 85,92



VASO PL ELO REDONDO 22 CARVALHO 6,5 L
Código: 38923 Fábrica: NUTRIPLAN Unidade: UN/1 F1 F4

UN: R\$ 58,74 AV: R\$ 58,74 15: R\$ 59,97
30: R\$ 61,17 45: R\$ 62,39 60: R\$ 63,64



VASO PL ELO REDONDO 22 CIMENTO 6,5 L
Código: 38922 Fábrica: NUTRIPLAN Unidade: UN/1 F1 F4

UN: R\$ 79,32 AV: R\$ 79,32 15: R\$ 80,97
30: R\$ 82,59 45: R\$ 84,24 60: R\$ 85,92



VASO PL ELO REDONDO 22 ENVELHECIDO 6,5 L
Código: 38921 Fábrica: NUTRIPLAN Unidade: UN/1 F1 F4

UN: R\$ 58,74 AV: R\$ 58,74 15: R\$ 59,97
30: R\$ 61,17 45: R\$ 62,39 60: R\$ 63,64



VASO PL ELO REDONDO 22 PRETO 6,5 L
Código: 38920 Fábrica: NUTRIPLAN Unidade: UN/1 F1 F4

UN: R\$ 192,02 AV: R\$ 192,02 15: R\$ 196,02
30: R\$ 199,94 45: R\$ 203,94 60: R\$ 208,02



VASO PL ELO REDONDO 35 CARVALHO 27 L
Código: 38927 Fábrica: NUTRIPLAN Unidade: UN/1 F1 F4

UN: R\$ 137,08 AV: R\$ 137,08 15: R\$ 139,93
30: R\$ 142,73 45: R\$ 145,59 60: R\$ 148,50



VASO PL ELO REDONDO 35 CIMENTO 27 L
Código: 38926 Fábrica: NUTRIPLAN Unidade: UN/1 F1 F4

UN: R\$ 160,10 AV: R\$ 160,10 15: R\$ 163,43
30: R\$ 166,70 45: R\$ 170,04 60: R\$ 173,44



VASO PL ELO REDONDO 35 PRETO 27 L
Código: 38924 Fábrica: NUTRIPLAN Unidade: UN/1 F1 F4

UN: R\$ 1,27 AV: R\$ 1,27 15: R\$ 1,30
30: R\$ 1,33 45: R\$ 1,35 60: R\$ 1,38



VASO PL ES 07 COLOR 160ML 386
Código: 38362 Fábrica: BIG PLAST Unidade: UN/1 F1 F4

UN: R\$ 2,84 AV: R\$ 2,84 15: R\$ 2,90
30: R\$ 2,96 45: R\$ 3,02 60: R\$ 3,08



VASO PL ES 16 PRETO 1,9L 400
Código: 38360 Fábrica: BIG PLAST Unidade: UN/1 F1 F4

UN: R\$ 39,16 AV: R\$ 39,16 15: R\$ 39,97
30: R\$ 40,77 45: R\$ 41,59 60: R\$ 42,42



VASO PL FACE HOMEM 24 BRANCO 2,75LT
Código: 42162 Fábrica: NUTRIPLAN Unidade: UN/1 F1 F4

UN: R\$ 39,16 AV: R\$ 39,16 15: R\$ 39,97
30: R\$ 40,77 45: R\$ 41,59 60: R\$ 42,42
17 cm
14 cm



VASO PL FACE HOMEM 24 CIMENTO 2,75LT
Código: 42159 Fábrica: NUTRIPLAN Unidade: UN/1
F1 F4

UN: R\$ 39,16 AV: R\$ 39,16 15: R\$ 39,97
30: R\$ 40,77 45: R\$ 41,59 60: R\$ 42,42
17 cm
14 cm



VASO PL FACE HOMEM 24 COBRE 2,75LT
Código: 42161 Fábrica: NUTRIPLAN Unidade: UN/1
F1 F4

UN: R\$ 39,16 AV: R\$ 39,16 15: R\$ 39,97
30: R\$ 40,77 45: R\$ 41,59 60: R\$ 42,42
17 cm
14 cm



VASO PL FACE HOMEM 24 PRETO 2,75LT
Código: 42163 Fábrica: NUTRIPLAN Unidade: UN/1
F1 F4

UN: R\$ 39,16 AV: R\$ 39,16 15: R\$ 39,97
30: R\$ 40,77 45: R\$ 41,59 60: R\$ 42,42
17 cm
16 cm



VASO PL FACE MULHER 17 BRANCO 2,19LT
Código: 42156 Fábrica: NUTRIPLAN Unidade: UN/1
F1 F4

UN: R\$ 39,16 AV: R\$ 39,16 15: R\$ 39,97
30: R\$ 40,77 45: R\$ 41,59 60: R\$ 42,42
17 cm
16 cm



VASO PL FACE MULHER 17 CIMENTO 2,19LT
Código: 42157 Fábrica: NUTRIPLAN Unidade: UN/1
F1 F4

UN: R\$ 39,16 AV: R\$ 39,16 15: R\$ 39,97
30: R\$ 40,77 45: R\$ 41,59 60: R\$ 42,42
17 cm
16 cm



VASO PL FACE MULHER 17 COBRE 2,19LT
Código: 42153 Fábrica: NUTRIPLAN Unidade: UN/1
F1 F4

UN: R\$ 39,16 AV: R\$ 39,16 15: R\$ 39,97
30: R\$ 40,77 45: R\$ 41,59 60: R\$ 42,42
17 cm
16 cm



VASO PL FACE MULHER 17 PRETO 2,19LT
Código: 42155 Fábrica: NUTRIPLAN Unidade: UN/1
F1 F4

UN: R\$ 132,18 AV: R\$ 132,18 15: R\$ 134,94
30: R\$ 137,63 45: R\$ 140,39 60: R\$ 143,20
34 cm
33 cm



VASO PL FACE MULHER 34 BRANCO 14,5LT
Código: 42164 Fábrica: NUTRIPLAN Unidade: UN/1
F1 F4

UN: R\$ 132,18 AV: R\$ 132,18 15: R\$ 134,94
30: R\$ 137,63 45: R\$ 140,39 60: R\$ 143,20
34 cm
33 cm



VASO PL FACE MULHER 34 PRETO 14,5LT
Código: 42165 Fábrica: NUTRIPLAN Unidade: UN/1
F1 F4

UN: R\$ 89,46 AV: R\$ 89,46 15: R\$ 91,32
30: R\$ 93,15 45: R\$ 95,01 60: R\$ 96,91



VASO PL FIBRA COCO PAREDE G 19,6X26X26CM
Código: 30294 Fábrica: NUTRIPLAN Unidade: UN/1
F1 F4

UN: R\$ 52,88 AV: R\$ 52,88 15: R\$ 53,98
30: R\$ 55,06 45: R\$ 56,16 60: R\$ 57,28



VASO PL FIBRA COCO PAREDE M 15,5X20,5CM
Código: 30293 Fábrica: NUTRIPLAN Unidade: UN/1
F1 F4

UN: R\$ 23,66 AV: R\$ 23,66 15: R\$ 24,15
30: R\$ 24,63 45: R\$ 25,13 60: R\$ 25,63
21 cm



VASO PL FIBRA DE COCO CONE 21,5X13X9CM
Código: 34907 Fábrica: NUTRIPLAN Unidade: UN/1
F1 F4

UN: R\$ 26,98 AV: R\$ 26,98 15: R\$ 27,54
30: R\$ 28,09 45: R\$ 28,65 60: R\$ 29,22
9,5 cm
16 cm



VASO PL FIBRA DE COCO 2 9,5X16X16CM
Código: 18499 Fábrica: NUTRIPLAN Unidade: UN/1
F1 F4

UN: R\$ 53,85 AV: R\$ 53,85 15: R\$ 54,97
30: R\$ 56,07 45: R\$ 57,19 60: R\$ 58,33
13 cm
25 cm



VASO PL FIBRA DE COCO 4 13X25,5X25,5CM
Código: 18501 Fábrica: NUTRIPLAN Unidade: UN/1
F1 F4

UN: R\$ 82,24 AV: R\$ 82,24 15: R\$ 83,96
30: R\$ 85,64 45: R\$ 87,35 60: R\$ 89,10
14 cm
31 cm



VASO PL FIBRA DE COCO 5 14X31X31CM
Código: 18502 Fábrica: NUTRIPLAN Unidade: UN/1
F1 F4

UN: R\$ 5,88 AV: R\$ 5,88 15: R\$ 6,00
30: R\$ 6,12 45: R\$ 6,24 60: R\$ 6,36
11 cm
34 cm
3 lts



VASO PL FLOREIRA MARRON 3 LITS 1377
Código: 37009 Fábrica: ERCAPLAST Unidade: UN/1
F1 F4

UN: R\$ 17,63 AV: R\$ 17,63 15: R\$ 17,99
30: R\$ 18,35 45: R\$ 18,72 60: R\$ 19,09

20 cm
24 cm
6,3 lts



VASO PL FLOREIRA 1 QUAD MARMORE

Código: 22303 Fábrica: NUTRIPLAN Unidade: UN/1 F1 F4

UN: R\$ 18,60 AV: R\$ 18,60 15: R\$ 18,98
30: R\$ 19,36 45: R\$ 19,75 60: R\$ 20,14

20 cm
24 cm
6,3 lts



VASO PL FLOREIRA 1 QUAD MARROM

Código: 22304 Fábrica: NUTRIPLAN Unidade: UN/1 F1 F4

UN: R\$ 6,65 AV: R\$ 6,65 15: R\$ 6,79
30: R\$ 6,92 45: R\$ 7,06 60: R\$ 7,20

4 L



VASO PL FLOREIRA 4 LTS MED PRETO 6704

Código: 41668 Fábrica: INPLAST Unidade: UN/1 F1 F4

UN: R\$ 137,09 AV: R\$ 137,09 15: R\$ 139,94
30: R\$ 142,74 45: R\$ 145,60 60: R\$ 148,51

48 cm
34 cm



VASO PL GRAFIATO CONICO 48 AREIA 25 L

Código: 30267 Fábrica: NUTRIPLAN Unidade: UN/1 F1 F4

UN: R\$ 137,09 AV: R\$ 137,09 15: R\$ 139,94
30: R\$ 142,74 45: R\$ 145,60 60: R\$ 148,51

48 cm
34 cm



VASO PL GRAFIATO CONICO 48 FERRUGEM 25 L

Código: 30266 Fábrica: NUTRIPLAN Unidade: UN/1 F1 F4

UN: R\$ 218,95 AV: R\$ 218,95 15: R\$ 223,51
30: R\$ 227,98 45: R\$ 232,54 60: R\$ 237,19

42 cm
37 cm
53 lts



VASO PL GRAFIATO OVAL 42 PRETO 53 LTS

Código: 33085 Fábrica: NUTRIPLAN Unidade: UN/1 F1 F4

UN: R\$ 136,19 AV: R\$ 136,19 15: R\$ 139,02
30: R\$ 141,80 45: R\$ 144,64 60: R\$ 147,53

22 cm
50 cm
45 lts



VASO PL GRAFIATO RED BAIX 22 CIMENTO 28L

Código: 36194 Fábrica: NUTRIPLAN Unidade: UN/1 F1 F4

UN: R\$ 136,19 AV: R\$ 136,19 15: R\$ 139,02
30: R\$ 141,80 45: R\$ 144,64 60: R\$ 147,53

22 cm
45 cm



VASO PL GRAFIATO REDONDO 22 AREIA 28 L

Código: 30276 Fábrica: NUTRIPLAN Unidade: UN/1 F1 F4

UN: R\$ 136,19 AV: R\$ 136,19 15: R\$ 139,02
30: R\$ 141,80 45: R\$ 144,64 60: R\$ 147,53

22 cm
45 cm



VASO PL GRAFIATO REDONDO 22 FERRUGE 28 L

Código: 30275 Fábrica: NUTRIPLAN Unidade: UN/1 F1 F4

UN: R\$ 136,19 AV: R\$ 136,19 15: R\$ 139,02
30: R\$ 141,80 45: R\$ 144,64 60: R\$ 147,53

22 cm
45 cm
28 lts



VASO PL GRAFIATO REDONDO 22 TABACO 28 L

Código: 33084 Fábrica: NUTRIPLAN Unidade: UN/1 F1 F4

UN: R\$ 76,38 AV: R\$ 76,38 15: R\$ 77,97
30: R\$ 79,53 45: R\$ 81,12 60: R\$ 82,74

28,5 cm
22 cm



VASO PL GRAFIATO TRAPEZIO 28 FERRUGEM 8L

Código: 32751 Fábrica: NUTRIPLAN Unidade: UN/1 F1 F4

UN: R\$ 76,38 AV: R\$ 76,38 15: R\$ 77,97
30: R\$ 79,53 45: R\$ 81,12 60: R\$ 82,74

28 cm
22 cm
08 lts

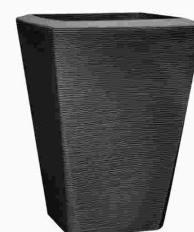

VASO PL GRAFIATO TRAPEZIO 28 PRETO 8L

Código: 36200 Fábrica: NUTRIPLAN Unidade: UN/1 F1 F4

UN: R\$ 114,57 AV: R\$ 114,57 15: R\$ 116,95
30: R\$ 119,29 45: R\$ 121,68 60: R\$ 124,11

35 cm
30 cm



VASO PL GRAFIATO TRAPEZIO 35 FERRUG 17 L

Código: 28675 Fábrica: NUTRIPLAN Unidade: UN/1 F1 F4

UN: R\$ 181,15 AV: R\$ 181,15 15: R\$ 184,93
30: R\$ 188,62 45: R\$ 192,40 60: R\$ 196,25

43 cm
34 cm



VASO PL GRAFIATO TRAPEZIO 43 AREIA 28 L

Código: 27474 Fábrica: NUTRIPLAN Unidade: UN/1 F1 F4

UN: R\$ 159,61 AV: R\$ 159,61 15: R\$ 162,93
30: R\$ 166,19 45: R\$ 169,52 60: R\$ 172,91

50 cm
37 cm
43 lts

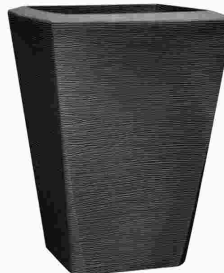

VASO PL GRAFIATO TRAPEZIO 50 PRETO 43L

Código: 36201 Fábrica: NUTRIPLAN Unidade: UN/1 F1 F4

UN: R\$ 5,87 AV: R\$ 5,87 15: R\$ 5,99
30: R\$ 6,11 45: R\$ 6,23 60: R\$ 6,35

1,6 L



VASO PL GREGO PAREDE COLOR 1,6LTS 421

Código: 41524 Fábrica: ARIPLAS Unidade: UN/1 F1 F4

UN: R\$ 7,82 AV: R\$ 7,82 15: R\$ 7,99
30: R\$ 8,15 45: R\$ 8,31 60: R\$ 8,48
☒ 2,8 L



VASO PL GREGO PAREDE COLOR 2,8LTS 421
Código: Fábrika: Unidade:
41522 ARIPLAS UN/1
F1 F4

UN: R\$ 5,38 AV: R\$ 5,38 15: R\$ 5,49
30: R\$ 5,60 45: R\$ 5,71 60: R\$ 5,82
☒ 820ml



VASO PL GREGO PAREDE COLOR 820ML 422
Código: Fábrika: Unidade:
41527 ARIPLAS UN/1
F1 F4

UN: R\$ 5,87 AV: R\$ 5,87 15: R\$ 5,99
30: R\$ 6,11 45: R\$ 6,23 60: R\$ 6,35
☒ 1,6 L



VASO PL GREGO PAREDE PRETO 1,6LTS 421
Código: Fábrika: Unidade:
41526 ARIPLAS UN/1
F1 F4

UN: R\$ 7,82 AV: R\$ 7,82 15: R\$ 7,99
30: R\$ 8,15 45: R\$ 8,31 60: R\$ 8,48
☒ 2,8 L



VASO PL GREGO PAREDE PRETO 2,8LTS 424
Código: Fábrika: Unidade:
41523 ARIPLAS UN/1
F1 F4

UN: R\$ 5,38 AV: R\$ 5,38 15: R\$ 5,49
30: R\$ 5,60 45: R\$ 5,71 60: R\$ 5,82
☒ 820 ml



VASO PL GREGO PAREDE PRETO 820ML 422
Código: Fábrika: Unidade:
41528 ARIPLAS UN/1
F1 F4

UN: R\$ 5,87 AV: R\$ 5,87 15: R\$ 5,99
30: R\$ 6,11 45: R\$ 6,23 60: R\$ 6,35
☒ 2,2 L



VASO PL GREGO RED COLOR 2,2LTS 345
Código: Fábrika: Unidade:
41515 ARIPLAS UN/1
F1 F4

UN: R\$ 9,78 AV: R\$ 9,78 15: R\$ 9,99
30: R\$ 10,19 45: R\$ 10,39 60: R\$ 10,60
☒ 9 L



VASO PL GREGO RED COLOR 9 LTS 341
Código: Fábrika: Unidade:
41510 ARIPLAS UN/1
F1 F4

UN: R\$ 5,87 AV: R\$ 5,87 15: R\$ 5,99
30: R\$ 6,11 45: R\$ 6,23 60: R\$ 6,35
☒ 2,2 L



VASO PL GREGO RED PRETO 2,2LTS 346
Código: Fábrika: Unidade:
41514 ARIPLAS UN/1
F1 F4

UN: R\$ 7,82 AV: R\$ 7,82 15: R\$ 7,99
30: R\$ 8,15 45: R\$ 8,31 60: R\$ 8,48
☒ 4,8 L



VASO PL GREGO RED PRETO 4,8 LTS 344
Código: Fábrika: Unidade:
41513 ARIPLAS UN/1
F1 F4

UN: R\$ 9,78 AV: R\$ 9,78 15: R\$ 9,99
30: R\$ 10,19 45: R\$ 10,39 60: R\$ 10,60
☒ 9 L



VASO PL GREGO RED PRETO 9 LTS 342
Código: Fábrika: Unidade:
41511 ARIPLAS UN/1
F1 F4

UN: R\$ 0,41 AV: R\$ 0,41 15: R\$ 0,42
30: R\$ 0,43 45: R\$ 0,44 60: R\$ 0,45
☒ 5cm
☒ 5,8cm



VASO PL HOLAMBRA POTE NP06 PRETO 80ML
Código: Fábrika: Unidade:
39210 NUTRIPLAN UN/1
F1 F4

UN: R\$ 0,47 AV: R\$ 0,47 15: R\$ 0,48
30: R\$ 0,49 45: R\$ 0,50 60: R\$ 0,51
☒ 5cm
☒ 5,8cm



VASO PL HOLAMBRA POTE NP11 PRETO 415ML
Código: Fábrika: Unidade:
38917 NUTRIPLAN UN/1
F1 F4

UN: R\$ 1,03 AV: R\$ 1,03 15: R\$ 1,05
30: R\$ 1,07 45: R\$ 1,09 60: R\$ 1,11
☒ 9 cm
☒ 12 cm
☒ 0,7 lts



VASO PL HOLAMBRA POTE NP13 PRETO 725ML
Código: Fábrika: Unidade:
39211 NUTRIPLAN UN/1
F1 F4

UN: R\$ 1,13 AV: R\$ 1,13 15: R\$ 1,15
30: R\$ 1,17 45: R\$ 1,20 60: R\$ 1,22
☒ 9.8 cm
☒ 13 cm
☒ 1 lts



VASO PL HOLAMBRA POTE NP14 PRETO 1LT
Código: Fábrika: Unidade:
38918 NUTRIPLAN UN/1
F1 F4

UN: R\$ 1,22 AV: R\$ 1,22 15: R\$ 1,25
30: R\$ 1,27 45: R\$ 1,30 60: R\$ 1,33
☒ 10,5 cm
☒ 14,5 cm
☒ 1,16 lts



VASO PL HOLAMBRA POTE NP15 PRETO 1,16LT
Código: Fábrika: Unidade:
38919 NUTRIPLAN UN/1
F1 F4

UN: R\$ 5,39 AV: R\$ 5,39 15: R\$ 5,50
30: R\$ 5,61 45: R\$ 5,72 60: R\$ 5,83



VASO PL JARDINEIRA 2 LTS PRETA 3072
Código: Fábrika: Unidade:
40412 FORMPLAST UN/1
F1 F4

UN: R\$ 6,85 AV: R\$ 6,85 15: R\$ 7,00
30: R\$ 7,14 45: R\$ 7,28 60: R\$ 7,43



VASO PL JARDINEIRA 5 LTS PRETA 3080
Código: 40413 Fábrica: FORMPLAST Unidade: UN/1 F1 F4

UN: R\$ 97,91 AV: R\$ 97,91 15: R\$ 99,95
30: R\$ 101,95 45: R\$ 103,99 60: R\$ 106,07
11 cm
100 cm



VASO PL JARDINEIRA CAFE 1MT 145
Código: 37149 Fábrica: PAIOL Unidade: UN/1 F1 F4

UN: R\$ 53,85 AV: R\$ 53,85 15: R\$ 54,97
30: R\$ 56,07 45: R\$ 57,19 60: R\$ 58,33
11 cm
40 cm



VASO PL JARDINEIRA CAFE 40CM 148
Código: 37221 Fábrica: PAIOL Unidade: UN/1 F1 F4

UN: R\$ 42,11 AV: R\$ 42,11 15: R\$ 42,98
30: R\$ 43,84 45: R\$ 44,72 60: R\$ 45,61
11 cm
60 cm



VASO PL JARDINEIRA CAFE 60CM 0047
Código: 37151 Fábrica: PAIOL Unidade: UN/1 F1 F4

UN: R\$ 53,37 AV: R\$ 53,37 15: R\$ 54,48
30: R\$ 55,57 45: R\$ 56,68 60: R\$ 57,81
11 cm
80 cm



VASO PL JARDINEIRA CAFE 80CM 0046
Código: 37150 Fábrica: PAIOL Unidade: UN/1 F1 F4

UN: R\$ 10,77 AV: R\$ 10,77 15: R\$ 11,00
30: R\$ 11,22 45: R\$ 11,44 60: R\$ 11,67



VASO PL JARDINEIRA 10 LTS PRETA 3087
Código: 40414 Fábrica: FORMPLAST Unidade: UN/1 F1 F4

UN: R\$ 11,51 AV: R\$ 11,51 15: R\$ 11,75
30: R\$ 11,98 45: R\$ 12,22 60: R\$ 12,46
11 cm
35cm



VASO PL JARDINEIRA 35 CM BRANCO 3,5L
Código: 13603 Fábrica: NUTRIPLAN Unidade: UN/1 F1 F4

UN: R\$ 12,72 AV: R\$ 12,72 15: R\$ 12,98
30: R\$ 13,24 45: R\$ 13,51 60: R\$ 13,78
11 cm
35cm



VASO PL JARDINEIRA 35 CM CAPUCCINO 3,5L
Código: 35202 Fábrica: NUTRIPLAN Unidade: UN/1 F1 F4

UN: R\$ 11,51 AV: R\$ 11,51 15: R\$ 11,75
30: R\$ 11,98 45: R\$ 12,22 60: R\$ 12,46
11 cm
35cm

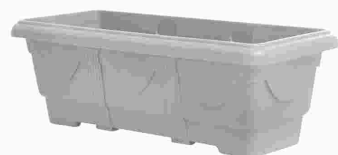

VASO PL JARDINEIRA 35 CM CINZA 3,5L
Código: 35203 Fábrica: NUTRIPLAN Unidade: UN/1 F1 F4

UN: R\$ 12,66 AV: R\$ 12,66 15: R\$ 12,92
30: R\$ 13,18 45: R\$ 13,45 60: R\$ 13,72
11 cm
35 cm



VASO PL JARDINEIRA 35 CM MARMORE 3,5L
Código: 30309 Fábrica: NUTRIPLAN Unidade: UN/1 F1 F4

UN: R\$ 12,72 AV: R\$ 12,72 15: R\$ 12,98
30: R\$ 13,24 45: R\$ 13,51 60: R\$ 13,78

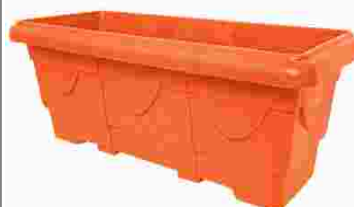

VASO PL JARDINEIRA 35 CM MARROM 3,5L
Código: 18507 Fábrica: NUTRIPLAN Unidade: UN/1 F1 F4

UN: R\$ 12,72 AV: R\$ 12,72 15: R\$ 12,98
30: R\$ 13,24 45: R\$ 13,51 60: R\$ 13,78
11 cm
35 cm



VASO PL JARDINEIRA 35 CM TABACO 3,5L
Código: 30308 Fábrica: NUTRIPLAN Unidade: UN/1 F1 F4

UN: R\$ 29,37 AV: R\$ 29,37 15: R\$ 29,98
30: R\$ 30,58 45: R\$ 31,19 60: R\$ 31,81
11 cm
80 cm



VASO PL JARDINEIRA 50 CM CAPUCCINO 11,5
Código: 35204 Fábrica: NUTRIPLAN Unidade: UN/1 F1 F4

UN: R\$ 27,41 AV: R\$ 27,41 15: R\$ 27,98
30: R\$ 28,54 45: R\$ 29,11 60: R\$ 29,69
11 cm
80 cm

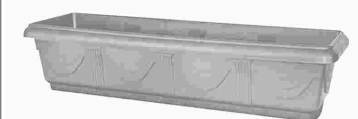

VASO PL JARDINEIRA 50 CM CINZA 11,5L
Código: 35205 Fábrica: NUTRIPLAN Unidade: UN/1 F1 F4

UN: R\$ 60,97 AV: R\$ 60,97 15: R\$ 62,24
30: R\$ 63,48 45: R\$ 64,75 60: R\$ 66,04
11 cm
80 cm



VASO PL JARDINEIRA 80 CM CAPUCCINO 24,5L
Código: 35457 Fábrica: NUTRIPLAN Unidade: UN/1 F1 F4

UN: R\$ 60,97 AV: R\$ 60,97 15: R\$ 62,24
30: R\$ 63,48 45: R\$ 64,75 60: R\$ 66,04
11 cm
80 cm

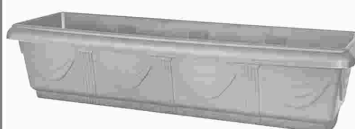

VASO PL JARDINEIRA 80 CM CINZA 34,5L
Código: 35458 Fábrica: NUTRIPLAN Unidade: UN/1 F1 F4

UN: R\$ 60,97 AV: R\$ 60,97 15: R\$ 62,24
30: R\$ 63,48 45: R\$ 64,75 60: R\$ 66,04

11 cm
35 cm

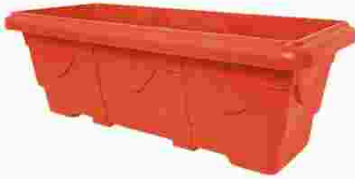

VASO PL JARDINEIRA 80 CM MARROM 24,5L

Código: 30310 Fábrica: NUTRIPLAN Unidade: UN/1 F1 F4

UN: R\$ 7,34 AV: R\$ 7,34 15: R\$ 7,50
30: R\$ 7,65 45: R\$ 7,80 60: R\$ 7,96

20 cm
14 cm
2,1 lts



VASO PL KIREY COLOR 2,1L 391

Código: 37720 Fábrica: BIG PLAST Unidade: UN/1 F1 F4

UN: R\$ 82,64 AV: R\$ 82,64 15: R\$ 84,37
30: R\$ 86,05 45: R\$ 87,77 60: R\$ 89,53

17 cm
30 cm
9 lts



VASO PL LUNA RED 17 TABACO 9LTS

Código: 37752 Fábrica: NUTRIPLAN Unidade: UN/1 F1 F4

UN: R\$ 74,42 AV: R\$ 74,42 15: R\$ 75,97
30: R\$ 77,49 45: R\$ 79,04 60: R\$ 80,62

17 cm
30 cm
9 lts



VASO PL LUNA RED 17 CIMENTO 9LTS

Código: 37754 Fábrica: NUTRIPLAN Unidade: UN/1 F1 F4

UN: R\$ 102,82 AV: R\$ 102,82 15: R\$ 104,96
30: R\$ 107,06 45: R\$ 109,20 60: R\$ 111,38

17 cm
30 cm
9 lts



VASO PL LUNA RED 17 ENVELHECIDO 9LTS

Código: 37753 Fábrica: NUTRIPLAN Unidade: UN/1 F1 F4

UN: R\$ 113,59 AV: R\$ 113,59 15: R\$ 115,95
30: R\$ 118,27 45: R\$ 120,64 60: R\$ 123,05

47 cm
31 cm
18 lts



VASO PL MING CONICO 47 AREIA 18LTS

Código: 33641 Fábrica: NUTRIPLAN Unidade: UN/1 F1 F4

UN: R\$ 72,07 AV: R\$ 72,07 15: R\$ 73,57
30: R\$ 75,04 45: R\$ 76,54 60: R\$ 78,07

23 cm
36 cm
12 lts



VASO PL MING RED BAIXO 23 AREIA 12LTS

Código: 33639 Fábrica: NUTRIPLAN Unidade: UN/1 F1 F4

UN: R\$ 72,07 AV: R\$ 72,07 15: R\$ 73,57
30: R\$ 75,04 45: R\$ 76,54 60: R\$ 78,07

23 cm
36 cm
12 lts



VASO PL MING RED BAIXO 23 CIMENTO 12LTS

Código: 33640 Fábrica: NUTRIPLAN Unidade: UN/1 F1 F4

UN: R\$ 72,07 AV: R\$ 72,07 15: R\$ 73,57
30: R\$ 75,04 45: R\$ 76,54 60: R\$ 78,07

23 cm
36 cm
12 lts



VASO PL MING RED BAIXO 23 FERRUGEM 12LTS

Código: 33644 Fábrica: NUTRIPLAN Unidade: UN/1 F1 F4

UN: R\$ 72,07 AV: R\$ 72,07 15: R\$ 73,57
30: R\$ 75,04 45: R\$ 76,54 60: R\$ 78,07

23 cm
36 cm
12 lts



VASO PL MING RED BAIXO 23 GRANITO 12LTS

Código: 33638 Fábrica: NUTRIPLAN Unidade: UN/1 F1 F4

UN: R\$ 139,05 AV: R\$ 139,05 15: R\$ 141,94
30: R\$ 144,78 45: R\$ 147,68 60: R\$ 150,63

33 cm
53 cm
44 lts



VASO PL MING RED BAIXO 33 AREIA 44LTS

Código: 33642 Fábrica: NUTRIPLAN Unidade: UN/1 F1 F4

UN: R\$ 156,18 AV: R\$ 156,18 15: R\$ 159,44
30: R\$ 162,62 45: R\$ 165,88 60: R\$ 169,20

33 cm
53 cm
44 lts



VASO PL MING RED BAIXO 33 FERRUGEM 44LTS

Código: 33643 Fábrica: NUTRIPLAN Unidade: UN/1 F1 F4

UN: R\$ 59,73 AV: R\$ 59,73 15: R\$ 60,98
30: R\$ 62,20 45: R\$ 63,44 60: R\$ 64,71

30 cm
36 cm



VASO PL N99 VIME SINTETICO ARGILA 0106

Código: 37123 Fábrica: PAIOL Unidade: UN/1 F1 F4

UN: R\$ 49,35 AV: R\$ 49,35 15: R\$ 50,38
30: R\$ 51,39 45: R\$ 52,42 60: R\$ 53,46

21,5 cm
28 cm



VASO PL ONDULADO PEQ AZUL 84-7

Código: 39953 Fábrica: PAIOL Unidade: UN/1 F1 F4

UN: R\$ 49,35 AV: R\$ 49,35 15: R\$ 50,38
30: R\$ 51,39 45: R\$ 52,42 60: R\$ 53,46

21,5 cm
28 cm



VASO PL ONDULADO PEQ BEGE 84-1

Código: 39951 Fábrica: PAIOL Unidade: UN/1 F1 F4

UN: R\$ 49,35 AV: R\$ 49,35 15: R\$ 50,38
30: R\$ 51,39 45: R\$ 52,42 60: R\$ 53,46

21,5 cm
28 cm



VASO PL ONDULADO PEQ CIMENTO 84-5

Código: 39952 Fábrica: PAIOL Unidade: UN/1 F1 F4

UN: R\$ 49,35 AV: R\$ 49,35 15: R\$ 50,38
30: R\$ 51,39 45: R\$ 52,42 60: R\$ 53,46
11 21,5 cm
12 28 cm



VASO PL ONDULADO PEQ MARROM 84-2
Código: Fábrika: Unidade:
39950 PAIOL UN/1
F1 F4

UN: R\$ 85,39 AV: R\$ 85,39 15: R\$ 87,17
30: R\$ 88,91 45: R\$ 90,69 60: R\$ 92,50
11 22 cm
12 20 cm



VASO PL ORIGAMI RED 22 BRANCO 5,5LTS
Código: Fábrika: Unidade:
34615 NUTRIPLAN UN/1
F1 F4

UN: R\$ 85,39 AV: R\$ 85,39 15: R\$ 87,17
30: R\$ 88,91 45: R\$ 90,69 60: R\$ 92,50
11 22 cm
12 20 cm



VASO PL ORIGAMI RED 22 CIMENTO 5,5LTS
Código: Fábrika: Unidade:
34616 NUTRIPLAN UN/1
F1 F4

UN: R\$ 85,39 AV: R\$ 85,39 15: R\$ 87,17
30: R\$ 88,91 45: R\$ 90,69 60: R\$ 92,50
11 22 cm
12 20 cm



VASO PL ORIGAMI RED 22 ENVELHECIDO 5,5LTS
Código: Fábrika: Unidade:
34617 NUTRIPLAN UN/1
F1 F4

UN: R\$ 107,71 AV: R\$ 107,71 15: R\$ 109,96
30: R\$ 112,16 45: R\$ 114,40 60: R\$ 116,69
11 22 cm
12 20 cm



VASO PL ORIGAMI RED 22 RUBI 5,5LTS
Código: Fábrika: Unidade:
34618 NUTRIPLAN UN/1
F1 F4

UN: R\$ 29,37 AV: R\$ 29,37 15: R\$ 29,98
30: R\$ 30,58 45: R\$ 31,19 60: R\$ 31,81
11 19 cm
12 20 cm



VASO PL ORQUIDEA CONE SINT ARGILA 2673-1
Código: Fábrika: Unidade:
37104 PAIOL UN/1
F1 F4

UN: R\$ 29,37 AV: R\$ 29,37 15: R\$ 29,98
30: R\$ 30,58 45: R\$ 31,19 60: R\$ 31,81
11 19,5 cm
12 21 cm



VASO PL ORQUIDEA CONE SINT ARGILA 2673-1
Código: Fábrika: Unidade:
40119 PAIOL UN/1
F1 F4

UN: R\$ 33,28 AV: R\$ 33,28 15: R\$ 33,98
30: R\$ 34,66 45: R\$ 35,35 60: R\$ 36,06
11 19,5 cm
12 21 cm



VASO PL ORQUIDEA CONE SINT BANANA 2673-2
Código: Fábrika: Unidade:
40120 PAIOL UN/1
F1 F4

UN: R\$ 41,12 AV: R\$ 41,12 15: R\$ 41,97
30: R\$ 42,81 45: R\$ 43,67 60: R\$ 44,54
11 23 cm
12 23 cm



VASO PL ORQUIDEA RED CAFE 00138
Código: Fábrika: Unidade:
37119 PAIOL UN/1
F1 F4

UN: R\$ 23,40 AV: R\$ 23,40 15: R\$ 23,89
30: R\$ 24,37 45: R\$ 24,86 60: R\$ 25,35
11 20 cm
12 23 cm



VASO PL ORQUIDEA RED MAD C/FLOR 1458/327
Código: Fábrika: Unidade:
37108 PAIOL UN/1
F1 F4

UN: R\$ 34,26 AV: R\$ 34,26 15: R\$ 34,98
30: R\$ 35,68 45: R\$ 36,39 60: R\$ 37,12
11 20 cm
12 20 cm



VASO PL ORQUIDEA RED MADEIRA PT/BC 5912
Código: Fábrika: Unidade:
37117 PAIOL UN/1
F1 F4

UN: R\$ 3,91 AV: R\$ 3,91 15: R\$ 3,99
30: R\$ 4,07 45: R\$ 4,15 60: R\$ 4,23
11 13 cm
12 26 cm
13 1,7 L



VASO PL PAREDE BELLA 1,7LTS PTO 9500
Código: Fábrika: Unidade:
45182 RISCHIOTO UN/1
F1 F4

UN: R\$ 41,71 AV: R\$ 41,71 15: R\$ 42,58
30: R\$ 43,43 45: R\$ 44,30 60: R\$ 45,19
11 18 cm
12 29 cm



VASO PL PAREDE GDE BANANA 27001-2
Código: Fábrika: Unidade:
37101 PAIOL UN/1
F1 F4

UN: R\$ 53,85 AV: R\$ 53,85 15: R\$ 54,97
30: R\$ 56,07 45: R\$ 57,19 60: R\$ 58,33
11 18 cm
12 29 cm



VASO PL PAREDE GDE C/BORD ARGILA 27001-1
Código: Fábrika: Unidade:
37100 PAIOL UN/1
F1 F4

UN: R\$ 5,13 AV: R\$ 5,13 15: R\$ 5,24
30: R\$ 5,34 45: R\$ 5,45 60: R\$ 5,56
11 18 cm
12 22 cm
13 1,6 lts



VASO PL PAREDE MARROM 1650 ML 2470
Código: Fábrika: Unidade:
37013 ERCAPLAST UN/1
F1 F4

UN: R\$ 8,15 AV: R\$ 8,15 15: R\$ 8,32
30: R\$ 8,48 45: R\$ 8,65 60: R\$ 8,83
11 17,5 cm
12 31 cm
13 3,4 lts



VASO PL PAREDE MARROM 3400 ML 2472
Código: Fábrika: Unidade:
37010 ERCAPLAST UN/1
F1 F4

UN: R\$ 3,92 AV: R\$ 3,92 15: R\$ 4,00
30: R\$ 4,08 45: R\$ 4,16 60: R\$ 4,24
11cm



VASO PL PAREDE MED PRETO 11CM 287
Código: 40715 Fábrica: PLASMARC Unidade: UN/1
F1 F4

UN: R\$ 15,66 AV: R\$ 15,66 15: R\$ 15,98
30: R\$ 16,30 45: R\$ 16,63 60: R\$ 16,96
17cm
32cm



VASO PL PAREDE MED VERDE
Código: 46045 Fábrica: NUTRIPLAN Unidade: UN/1
F1 F4

UN: R\$ 12,81 AV: R\$ 12,81 15: R\$ 13,07
30: R\$ 13,34 45: R\$ 13,60 60: R\$ 13,88



VASO PL PAREDE MEDIO MARROM
Código: 30313 Fábrica: NUTRIPLAN Unidade: UN/1
F1 F4

UN: R\$ 11,26 AV: R\$ 11,26 15: R\$ 11,50
30: R\$ 11,73 45: R\$ 11,96 60: R\$ 12,20



VASO PL PAREDE MEDIO PRETO
Código: 30314 Fábrica: NUTRIPLAN Unidade: UN/1
F1 F4

UN: R\$ 12,81 AV: R\$ 12,81 15: R\$ 13,07
30: R\$ 13,34 45: R\$ 13,60 60: R\$ 13,88



VASO PL PAREDE MEDIO TABACO
Código: 30312 Fábrica: NUTRIPLAN Unidade: UN/1
F1 F4

UN: R\$ 6,11 AV: R\$ 6,11 15: R\$ 6,24
30: R\$ 6,36 45: R\$ 6,49 60: R\$ 6,62
10 cm
20 cm



VASO PL PAREDE MINI MARROM
Código: 30316 Fábrica: NUTRIPLAN Unidade: UN/1
F1 F4

UN: R\$ 5,43 AV: R\$ 5,43 15: R\$ 5,55
30: R\$ 5,66 45: R\$ 5,77 60: R\$ 5,89



VASO PL PAREDE MINI PRETO
Código: 30315 Fábrica: NUTRIPLAN Unidade: UN/1
F1 F4

UN: R\$ 6,11 AV: R\$ 6,11 15: R\$ 6,24
30: R\$ 6,36 45: R\$ 6,49 60: R\$ 6,62



VASO PL PAREDE MINI TABACO
Código: 30317 Fábrica: NUTRIPLAN Unidade: UN/1
F1 F4

UN: R\$ 7,82 AV: R\$ 7,82 15: R\$ 7,99
30: R\$ 8,15 45: R\$ 8,31 60: R\$ 8,48
10cm
20cm



VASO PL PAREDE MINI VERDE
Código: 47605 Fábrica: NUTRIPLAN Unidade: UN/1
F1 F4

UN: R\$ 48,95 AV: R\$ 48,95 15: R\$ 49,97
30: R\$ 50,97 45: R\$ 51,99 60: R\$ 53,03
10,5 cm
16 cm



VASO PL PAREDE PEQ ARGILA 27005-1
Código: 37102 Fábrica: PAIOL Unidade: UN/1
F1 F4

UN: R\$ 3,72 AV: R\$ 3,72 15: R\$ 3,80
30: R\$ 3,87 45: R\$ 3,95 60: R\$ 4,03
8 cm



VASO PL PAREDE PEQ PRETO 8CM 255
Código: 40714 Fábrica: PLASMARC Unidade: UN/1
F1 F4

UN: R\$ 11,41 AV: R\$ 11,41 15: R\$ 11,65
30: R\$ 11,88 45: R\$ 12,12 60: R\$ 12,36
13 cm
26 cm
2 lts



VASO PL PAREDE PEQ VERDE
Código: 34611 Fábrica: NUTRIPLAN Unidade: UN/1
F1 F4

UN: R\$ 4,41 AV: R\$ 4,41 15: R\$ 4,50
30: R\$ 4,59 45: R\$ 4,68 60: R\$ 4,77
18 cm
22 cm
1,6 lts



VASO PL PAREDE PRETO 1650 ML 2469
Código: 37012 Fábrica: ERCAPLAST Unidade: UN/1
F1 F4

UN: R\$ 7,21 AV: R\$ 7,21 15: R\$ 7,36
30: R\$ 7,50 45: R\$ 7,65 60: R\$ 7,81
17,5 cm
31 cm
3,4 lts



VASO PL PAREDE PRETO 3400 ML 2471
Código: 37011 Fábrica: ERCAPLAST Unidade: UN/1
F1 F4

UN: R\$ 9,94 AV: R\$ 9,94 15: R\$ 10,15
30: R\$ 10,35 45: R\$ 10,56 60: R\$ 10,77
17 cm
30 cm
3 lts



VASO PL PAREDE 30 PRETO 3L 268
Código: 37701 Fábrica: BIG PLAST Unidade: UN/1
F1 F4

UN: R\$ 103,01 AV: R\$ 103,01 15: R\$ 105,16
30: R\$ 107,26 45: R\$ 109,41 60: R\$ 111,59
30 cm



VASO PL PETRA CONE 30 C/PRATO AREIA
Código: 36810 Fábrica: NUTRIPLAN Unidade: UN/1
F1 F4

UN: R\$ 103,01 AV: R\$ 103,01 15: R\$ 105,16
30: R\$ 107,26 45: R\$ 109,41 60: R\$ 111,59

30 cm



VASO PL PETRA CONE 30 C/PRATO FERRUGEM

Código: 36809 Fábrica: NUTRIPLAN Unidade: UN/1 F1 F4

UN: R\$ 0,93 AV: R\$ 0,93 15: R\$ 0,95
30: R\$ 0,97 45: R\$ 0,99 60: R\$ 1,01

8 cm
11 cm
300 ml



VASO PL PF 11 PRETO 300ML 130

Código: 38361 Fábrica: BIG PLAST Unidade: UN/1 F1 F4

UN: R\$ 4,40 AV: R\$ 4,40 15: R\$ 4,49
30: R\$ 4,58 45: R\$ 4,67 60: R\$ 4,76

5 cm
8 cm



VASO PL POTE SINT 07 S/BORDA ARGIL 60623

Código: 39437 Fábrica: PAIOL Unidade: UN/1 F1 F4

UN: R\$ 4,89 AV: R\$ 4,89 15: R\$ 4,99
30: R\$ 5,09 45: R\$ 5,19 60: R\$ 5,29

5 cm
8 cm



VASO PL POTE SINT 07 S/BORDA CAFE 60623

Código: 37087 Fábrica: PAIOL Unidade: UN/1 F1 F4

UN: R\$ 4,40 AV: R\$ 4,40 15: R\$ 4,49
30: R\$ 4,58 45: R\$ 4,67 60: R\$ 4,76

5 cm
8 cm



VASO PL POTE SINT 07 S/BORDA CAPUC 60623

Código: 39438 Fábrica: PAIOL Unidade: UN/1 F1 F4

UN: R\$ 6,21 AV: R\$ 6,21 15: R\$ 6,34
30: R\$ 6,46 45: R\$ 6,59 60: R\$ 6,73

7 cm
9 cm



VASO PL POTE SINT 09 S/BORDA CAFE 4046

Código: 39442 Fábrica: PAIOL Unidade: UN/1 F1 F4

UN: R\$ 6,21 AV: R\$ 6,21 15: R\$ 6,34
30: R\$ 6,46 45: R\$ 6,59 60: R\$ 6,73

7 cm
9 cm



VASO PL POTE SINT 09 S/BORDA CAPUCI 4046

Código: 39444 Fábrica: PAIOL Unidade: UN/1 F1 F4

UN: R\$ 7,43 AV: R\$ 7,43 15: R\$ 7,59
30: R\$ 7,74 45: R\$ 7,89 60: R\$ 8,05

7 cm
12 cm



VASO PL POTE SINT 11 S/BORDA ARGIL 40461

Código: 39439 Fábrica: PAIOL Unidade: UN/1 F1 F4

UN: R\$ 7,43 AV: R\$ 7,43 15: R\$ 7,59
30: R\$ 7,74 45: R\$ 7,89 60: R\$ 8,05

7 cm
12 cm



VASO PL POTE SINT 11 S/BORDA BANAN 40461

Código: 39440 Fábrica: PAIOL Unidade: UN/1 F1 F4

UN: R\$ 7,43 AV: R\$ 7,43 15: R\$ 7,59
30: R\$ 7,74 45: R\$ 7,89 60: R\$ 8,05

7 cm
9 cm



VASO PL POTE SINT 11 S/BORDA BRANC 40461

Código: 39441 Fábrica: PAIOL Unidade: UN/1 F1 F4

UN: R\$ 7,43 AV: R\$ 7,43 15: R\$ 7,59
30: R\$ 7,74 45: R\$ 7,89 60: R\$ 8,05

8 cm
10 cm



VASO PL POTE SINT 11 S/BORDA CAFE 40461

Código: 37084 Fábrica: PAIOL Unidade: UN/1 F1 F4

UN: R\$ 7,43 AV: R\$ 7,43 15: R\$ 7,59
30: R\$ 7,74 45: R\$ 7,89 60: R\$ 8,05

VASO PL POTE SINT 11 S/BORDA CAPUC 40461

Código: 39931 Fábrica: PAIOL Unidade: UN/1 F1 F4

UN: R\$ 20,55 AV: R\$ 20,55 15: R\$ 20,98
30: R\$ 21,40 45: R\$ 21,83 60: R\$ 22,27



VASO PL PRETO G 24LTS 650011

Código: 41204 Fábrica: PLASTSU Unidade: UN/1 F1 F4

UN: R\$ 18,60 AV: R\$ 18,60 15: R\$ 18,98
30: R\$ 19,36 45: R\$ 19,75 60: R\$ 20,14



VASO PL PRETO M 951710

Código: 41202 Fábrica: PLASTSU Unidade: UN/1 F1 F4

UN: R\$ 16,64 AV: R\$ 16,64 15: R\$ 16,98
30: R\$ 17,32 45: R\$ 17,67 60: R\$ 18,02



VASO PL PRETO P 9LTS 951314

Código: 41200 Fábrica: PLASTSU Unidade: UN/1 F1 F4

UN: R\$ 5,50 AV: R\$ 5,50 15: R\$ 5,62
30: R\$ 5,73 45: R\$ 5,84 60: R\$ 5,96

13 cm
17 cm
1,9 L



VASO PL PRIMAVERA 2 RED PEQ MARROM 3 L

Código: 33540 Fábrica: NUTRIPLAN Unidade: UN/1 F1 F4

UN: R\$ 3,96 AV: R\$ 3,96 15: R\$ 4,04
 30: R\$ 4,12 45: R\$ 4,20 60: R\$ 4,29





VASO PL PRIMAVERA 2 RED PEQ PRETO 3 L
 Código: 33541 Fábrica: NUTRIPLAN Unidade: UN/1
 F1 F4

UN: R\$ 4,41 AV: R\$ 4,41 15: R\$ 4,50
 30: R\$ 4,59 45: R\$ 4,68 60: R\$ 4,77





VASO PL PRIMAVERA 3 RED PEQ MARROM 3 L
 Código: 22164 Fábrica: NUTRIPLAN Unidade: UN/1
 F1 F4

UN: R\$ 5,01 AV: R\$ 5,01 15: R\$ 5,12
 30: R\$ 5,22 45: R\$ 5,32 60: R\$ 5,43





VASO PL PRIMAVERA 3 RED PEQ PRETO 3L
 Código: 22168 Fábrica: NUTRIPLAN Unidade: UN/1
 F1 F4

UN: R\$ 10,70 AV: R\$ 10,70 15: R\$ 10,93
 30: R\$ 11,14 45: R\$ 11,37 60: R\$ 11,59





VASO PL PRIMAVERA 4 RED MED MARROM
 Código: 22165 Fábrica: NUTRIPLAN Unidade: UN/1
 F1 F4

UN: R\$ 10,70 AV: R\$ 10,70 15: R\$ 10,93
 30: R\$ 11,14 45: R\$ 11,37 60: R\$ 11,59





VASO PL PRIMAVERA 4 RED MED PRETO
 Código: 33542 Fábrica: NUTRIPLAN Unidade: UN/1
 F1 F4

UN: R\$ 10,77 AV: R\$ 10,77 15: R\$ 11,00
 30: R\$ 11,22 45: R\$ 11,44 60: R\$ 11,67





VASO PL PRIMAVERA 5 RED MED CINZA
 Código: 35215 Fábrica: NUTRIPLAN Unidade: UN/1
 F1 F4

UN: R\$ 13,45 AV: R\$ 13,45 15: R\$ 13,73
 30: R\$ 14,01 45: R\$ 14,29 60: R\$ 14,58





VASO PL PRIMAVERA 5 RED MED MARROM
 Código: 22166 Fábrica: NUTRIPLAN Unidade: UN/1
 F1 F4

UN: R\$ 11,75 AV: R\$ 11,75 15: R\$ 12,00
 30: R\$ 12,24 45: R\$ 12,48 60: R\$ 12,73





VASO PL PRIMAVERA 5 RED MED PRETO
 Código: 22170 Fábrica: NUTRIPLAN Unidade: UN/1
 F1 F4

UN: R\$ 18,02 AV: R\$ 18,02 15: R\$ 18,39
 30: R\$ 18,76 45: R\$ 19,14 60: R\$ 19,52





VASO PL PRIMAVERA 6 RED GDE MARROM 6 L
 Código: 22167 Fábrica: NUTRIPLAN Unidade: UN/1
 F1 F4

UN: R\$ 16,30 AV: R\$ 16,30 15: R\$ 16,64
 30: R\$ 16,98 45: R\$ 17,32 60: R\$ 17,66



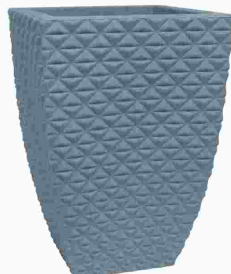

VASO PL PRIMAVERA 6 RED GDE PRETO
 Código: 22171 Fábrica: NUTRIPLAN Unidade: UN/1
 F1 F4

UN: R\$ 125,34 AV: R\$ 125,34 15: R\$ 127,95
 30: R\$ 130,51 45: R\$ 133,12 60: R\$ 135,78



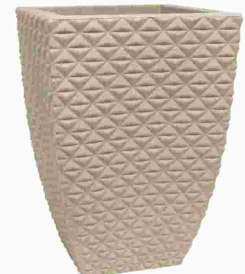

VASO PL QUAD BERLIAN GOLD P AZUL A82-9
 Código: 40031 Fábrica: PAIOL Unidade: UN/1
 F1 F4

UN: R\$ 125,34 AV: R\$ 125,34 15: R\$ 127,95
 30: R\$ 130,51 45: R\$ 133,12 60: R\$ 135,78



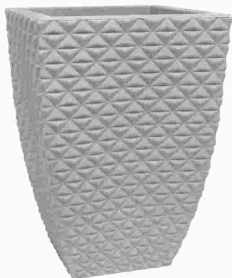

VASO PL QUAD BERLIAN GOLD P BEGE A82-1
 Código: 40029 Fábrica: PAIOL Unidade: UN/1
 F1 F4

UN: R\$ 125,34 AV: R\$ 125,34 15: R\$ 127,95
 30: R\$ 130,51 45: R\$ 133,12 60: R\$ 135,78





VASO PL QUAD BERLIAN GOLD P CIMENT A82-5
 Código: 40030 Fábrica: PAIOL Unidade: UN/1
 F1 F4

UN: R\$ 137,08 AV: R\$ 137,08 15: R\$ 139,93
 30: R\$ 142,73 45: R\$ 145,59 60: R\$ 148,50





VASO PL QUAD BERLIAN GOLD P MAROM A82-2
 Código: 40028 Fábrica: PAIOL Unidade: UN/1
 F1 F4

UN: R\$ 55,80 AV: R\$ 55,80 15: R\$ 56,97
 30: R\$ 58,11 45: R\$ 59,27 60: R\$ 60,45



VASO PL QUAD BOJO 0 AZUL 53-7
 Código: 39946 Fábrica: PAIOL Unidade: UN/1
 F1 F4

UN: R\$ 49,35 AV: R\$ 49,35 15: R\$ 50,38
 30: R\$ 51,39 45: R\$ 52,42 60: R\$ 53,46



VASO PL QUAD BOJO 0 BEGE 53-2
 Código: 39944 Fábrica: PAIOL Unidade: UN/1
 F1 F4

UN: R\$ 49,35 AV: R\$ 49,35 15: R\$ 50,38
 30: R\$ 51,39 45: R\$ 52,42 60: R\$ 53,46
 27 cm
 19,5 cm

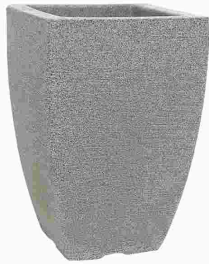

VASO PL QUAD BOJO 0 CIMENTO 53-4
 Código: 39945 Fábrica: PAIOL Unidade: UN/1 F1 F4

UN: R\$ 49,35 AV: R\$ 49,35 15: R\$ 50,38
 30: R\$ 51,39 45: R\$ 52,42 60: R\$ 53,46
 27 cm
 19,5 cm

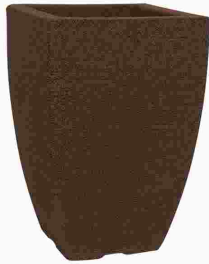

VASO PL QUAD BOJO 0 MARROM 53-3
 Código: 39943 Fábrica: PAIOL Unidade: UN/1 F1 F4

UN: R\$ 5,67 AV: R\$ 5,67 15: R\$ 5,79
 30: R\$ 5,90 45: R\$ 6,02 60: R\$ 6,14
 1,7 L



VASO PL QUAD COLOR 1,7LTS 403
 Código: 41516 Fábrica: ARIPLAS Unidade: UN/1 F1 F4

UN: R\$ 6,84 AV: R\$ 6,84 15: R\$ 6,99
 30: R\$ 7,13 45: R\$ 7,27 60: R\$ 7,41
 3,5 L



VASO PL QUAD COLOR 3,5LTS 405
 Código: 41518 Fábrica: ARIPLAS Unidade: UN/1 F1 F4

UN: R\$ 8,80 AV: R\$ 8,80 15: R\$ 8,99
 30: R\$ 9,17 45: R\$ 9,35 60: R\$ 9,54
 6 L



VASO PL QUAD COLOR 6,4LTS 407
 Código: 41520 Fábrica: ARIPLAS Unidade: UN/1 F1 F4

UN: R\$ 4,21 AV: R\$ 4,21 15: R\$ 4,30
 30: R\$ 4,38 45: R\$ 4,47 60: R\$ 4,56
 14 cm
 16 cm
 2 lts



VASO PL QUAD MARROM 2,0 LTS 1332
 Código: 36988 Fábrica: ERCAPLAST Unidade: UN/1 F1 F4

UN: R\$ 7,36 AV: R\$ 7,36 15: R\$ 7,52
 30: R\$ 7,67 45: R\$ 7,82 60: R\$ 7,98
 19 cm
 22 cm
 4,6 lts



VASO PL QUAD MARROM 4,6 LTS 1334
 Código: 36987 Fábrica: ERCAPLAST Unidade: UN/1 F1 F4

UN: R\$ 2,02 AV: R\$ 4,03 15: R\$ 4,12
 30: R\$ 4,20 45: R\$ 4,28 60: R\$ 4,37
 11 cm
 18 cm
 0,8 lts



VASO PL QUAD MARROM 800 ML 1384 2X1
 Código: 36990 Fábrica: ERCAPLAST Unidade: CJ/2 F1 F4

UN: R\$ 5,67 AV: R\$ 5,67 15: R\$ 5,79
 30: R\$ 5,90 45: R\$ 6,02 60: R\$ 6,14
 1,7 L



VASO PL QUAD PRETO 1,7LTS 404
 Código: 41517 Fábrica: ARIPLAS Unidade: UN/1 F1 F4

UN: R\$ 3,82 AV: R\$ 3,82 15: R\$ 3,90
 30: R\$ 3,98 45: R\$ 4,06 60: R\$ 4,14
 14 cm
 16 cm
 2 lts



VASO PL QUAD PRETO 2,0 LTS 1331
 Código: 36989 Fábrica: ERCAPLAST Unidade: UN/1 F1 F4

UN: R\$ 6,36 AV: R\$ 6,36 15: R\$ 6,49
 30: R\$ 6,62 45: R\$ 6,75 60: R\$ 6,88
 3,5 L



VASO PL QUAD PRETO 3,5LTS 406
 Código: 41519 Fábrica: ARIPLAS Unidade: UN/1 F1 F4

UN: R\$ 8,31 AV: R\$ 8,31 15: R\$ 8,49
 30: R\$ 8,66 45: R\$ 8,83 60: R\$ 9,01
 6 L



VASO PL QUAD PRETO 6,4LTS 408
 Código: 41521 Fábrica: ARIPLAS Unidade: UN/1 F1 F4

UN: R\$ 1,86 AV: R\$ 3,72 15: R\$ 3,80
 30: R\$ 3,87 45: R\$ 3,95 60: R\$ 4,03
 11 cm
 18 cm
 0,8 lts



VASO PL QUAD PRETO 800 ML 1383 2X1
 Código: 36991 Fábrica: ERCAPLAST Unidade: CJ/2 F1 F4

UN: R\$ 12,95 AV: R\$ 12,95 15: R\$ 13,21
 30: R\$ 13,48 45: R\$ 13,75 60: R\$ 14,02
 24 cm
 28 cm
 9,5 lts



VASO PL QUAD PRETO 9,5 LTS 1349
 Código: 36985 Fábrica: ERCAPLAST Unidade: UN/1 F1 F4

UN: R\$ 19,57 AV: R\$ 19,57 15: R\$ 19,98
 30: R\$ 20,38 45: R\$ 20,79 60: R\$ 21,21
 11 cm
 16 cm
 0,85 lts





VASO PL QUARTZO 11 FERRUGEM 0,85 LTS
 Código: 37845 Fábrica: NUTRIPLAN Unidade: UN/1 F1 F4

UN: R\$ 46,61 AV: R\$ 46,61 15: R\$ 47,58
 30: R\$ 48,53 45: R\$ 49,50 60: R\$ 50,49
 16 cm
 23 cm
 4,75 lts





VASO PL QUARTZO 16 FERRUGEM 4,75 LTS
 Código: 37846 Fábrica: NUTRIPLAN Unidade: UN/1 F1 F4

UN: R\$ 73,44 AV: R\$ 73,44 15: R\$ 74,97
 30: R\$ 76,47 45: R\$ 78,00 60: R\$ 79,56





VASO PL QUARTZO 22 FERRUGEM 8LTS



Código: 37847 Fábrica: NUTRIPLAN Unidade: UN/1
 F1 F4

UN: R\$ 86,17 AV: R\$ 86,17 15: R\$ 87,96
 30: R\$ 89,72 45: R\$ 91,52 60: R\$ 93,35





VASO PL QUARTZO 30 FERRUGEM 25LTS



Código: 37848 Fábrica: NUTRIPLAN Unidade: UN/1
 F1 F4

UN: R\$ 36,23 AV: R\$ 36,23 15: R\$ 36,99
 30: R\$ 37,72 45: R\$ 38,48 60: R\$ 39,25





VASO PL RED BOJO CONE 0 BEGE 96-1



Código: 39934 Fábrica: PAIOL Unidade: UN/1
 F1 F4

UN: R\$ 36,23 AV: R\$ 36,23 15: R\$ 36,99
 30: R\$ 37,72 45: R\$ 38,48 60: R\$ 39,25





VASO PL RED BOJO CONE 0 CIMENTO 96-5

Código: 39933 Fábrica: PAIOL Unidade: UN/1
 F1 F4

UN: R\$ 72,46 AV: R\$ 72,46 15: R\$ 73,97
 30: R\$ 75,45 45: R\$ 76,96 60: R\$ 78,50





VASO PL RED BOJO CONE 1 AZUL 73-7

Código: 39938 Fábrica: PAIOL Unidade: UN/1
 F1 F4

UN: R\$ 72,46 AV: R\$ 72,46 15: R\$ 73,97
 30: R\$ 75,45 45: R\$ 76,96 60: R\$ 78,50





VASO PL RED BOJO CONE 1 BEGE 73-2

Código: 39936 Fábrica: PAIOL Unidade: UN/1
 F1 F4

UN: R\$ 72,46 AV: R\$ 72,46 15: R\$ 73,97
 30: R\$ 75,45 45: R\$ 76,96 60: R\$ 78,50





VASO PL RED BOJO CONE 1 MARROM 73-1

Código: 39935 Fábrica: PAIOL Unidade: UN/1
 F1 F4

UN: R\$ 9,77 AV: R\$ 9,77 15: R\$ 9,98
 30: R\$ 10,18 45: R\$ 10,38 60: R\$ 10,59





VASO PL RED CANELADO PRETO 6L C/ALCA 2617

Código: 37002 Fábrica: ERCAPLAST Unidade: UN/1
 F1 F4

UN: R\$ 7,79 AV: R\$ 7,79 15: R\$ 7,96
 30: R\$ 8,12 45: R\$ 8,28 60: R\$ 8,44







VASO PL RED CUIJA COLOR 3L 2598

Código: 37006 Fábrica: ERCAPLAST Unidade: UN/1
 F1 F4



UN: R\$ 2,08 AV: R\$ 4,15 15: R\$ 4,24
 30: R\$ 4,32 45: R\$ 4,41 60: R\$ 4,50



VASO PL RED MARROM 700 ML 1382 2X1

Código: 36984 Fábrica: ERCAPLAST Unidade: CJ/2
 F1 F4

UN: R\$ 11,79 AV: R\$ 11,79 15: R\$ 12,04
 30: R\$ 12,28 45: R\$ 12,52 60: R\$ 12,77





VASO PL RED MARROM 7,5 LTS 1323

Código: 36979 Fábrica: ERCAPLAST Unidade: UN/1
 F1 F4

UN: R\$ 7,62 AV: R\$ 7,62 15: R\$ 7,78
 30: R\$ 7,93 45: R\$ 8,09 60: R\$ 8,25



VASO PL RED PRETO N22 3,7LTS 926

Código: 51043 Fábrica: LUMAR Unidade: UN/1
 F1 F4

UN: R\$ 12,34 AV: R\$ 12,34 15: R\$ 12,60
 30: R\$ 12,85 45: R\$ 13,10 60: R\$ 13,37



VASO PL RED PRETO N28 8,0LTS 915



Código: 51044 Fábrica: LUMAR Unidade: UN/1
 F1 F4

UN: R\$ 22,05 AV: R\$ 22,05 15: R\$ 22,51
 30: R\$ 22,96 45: R\$ 23,42 60: R\$ 23,89



VASO PL RED PRETO N36 16LTS 916

Código: 51045 Fábrica: LUMAR Unidade: UN/1
 F1 F4

UN: R\$ 20,32 AV: R\$ 20,32 15: R\$ 20,74
 30: R\$ 21,16 45: R\$ 21,58 60: R\$ 22,01





VASO PL RED PRETO 15 LTS 1328

Código: 36977 Fábrica: ERCAPLAST Unidade: UN/1
 F1 F4

UN: R\$ 4,21 AV: R\$ 4,21 15: R\$ 4,30
 30: R\$ 4,38 45: R\$ 4,47 60: R\$ 4,56





VASO PL RED PRETO 1,75 LTS 1305

Código: 36982 Fábrica: ERCAPLAST Unidade: UN/1
 F1 F4

UN: R\$ 5,70 AV: R\$ 5,70 15: R\$ 5,82
 30: R\$ 5,93 45: R\$ 6,05 60: R\$ 6,17
 18 cm
 22 cm
 3,8 lts



VASO PL RED PRETO 3,8 LTS 1306



Código: 36981 Fábrica: ERCAPLAST Unidade: UN/1
 F1 F4

UN: R\$ 1,91 AV: R\$ 3,82 15: R\$ 3,90
 30: R\$ 3,98 45: R\$ 4,06 60: R\$ 4,14
 11 cm
 12 cm
 0,7 lts



VASO PL RED PRETO 700 ML 1381 2X1



Código: 36983 Fábrica: ERCAPLAST Unidade: CJ/2
 F1 F4

UN: R\$ 10,38 AV: R\$ 10,38 15: R\$ 10,60
 30: R\$ 10,81 45: R\$ 11,02 60: R\$ 11,24
 37 cm
 28 cm
 7,5 lts



VASO PL RED PRETO 7,5 LTS 1322



Código: 36978 Fábrica: ERCAPLAST Unidade: UN/1
 F1 F4

UN: R\$ 195,83 AV: R\$ 195,83 15: R\$ 199,91
 30: R\$ 203,91 45: R\$ 207,99 60: R\$ 212,15
 48 cm
 40 cm



VASO PL RED RELEVO 40 PRETO



Código: 41387 Fábrica: NUTRIPLAN Unidade: UN/1
 F1 F4

UN: R\$ 183,10 AV: R\$ 183,10 15: R\$ 186,92
 30: R\$ 190,65 45: R\$ 194,47 60: R\$ 198,36
 48 cm
 40 cm



VASO PL RED RELEVO 40 TABACO



Código: 41386 Fábrica: NUTRIPLAN Unidade: UN/1
 F1 F4

UN: R\$ 214,93 AV: R\$ 214,93 15: R\$ 219,41
 30: R\$ 223,80 45: R\$ 228,28 60: R\$ 232,84
 24 cm
 54 cm



VASO PL RELEVO OVAL 23 CARVALHO



Código: 44137 Fábrica: NUTRIPLAN Unidade: UN/1
 F1 F4

UN: R\$ 263,16 AV: R\$ 263,16 15: R\$ 268,64
 30: R\$ 274,02 45: R\$ 279,50 60: R\$ 285,09
 42 cm
 40 cm



VASO PL RELEVO OVAL 42 CARVALHO



Código: 44139 Fábrica: NUTRIPLAN Unidade: UN/1
 F1 F4

UN: R\$ 219,33 AV: R\$ 219,33 15: R\$ 223,90
 30: R\$ 228,38 45: R\$ 232,95 60: R\$ 237,60
 42 cm
 40 cm



VASO PL RELEVO OVAL 42 CIMENTO



Código: 44140 Fábrica: NUTRIPLAN Unidade: UN/1
 F1 F4

UN: R\$ 235,00 AV: R\$ 235,00 15: R\$ 239,89
 30: R\$ 244,69 45: R\$ 249,59 60: R\$ 254,58
 67cm
 48cm



VASO PL RELEVO REDONDO 67 97LT CIMENTO

Código: 42183 Fábrica: NUTRIPLAN Unidade: UN/1
 F1 F4

UN: R\$ 293,75 AV: R\$ 293,75 15: R\$ 299,87
 30: R\$ 305,87 45: R\$ 311,98 60: R\$ 318,22
 67cm
 48cm



VASO PL RELEVO REDONDO 67 97LT CIMENTO Q



Código: 42184 Fábrica: NUTRIPLAN Unidade: UN/1
 F1 F4

UN: R\$ 293,75 AV: R\$ 293,75 15: R\$ 299,87
 30: R\$ 305,87 45: R\$ 311,98 60: R\$ 318,22
 67cm
 48cm



VASO PL RELEVO REDONDO 67 97LT OURO ENVE



Código: 42185 Fábrica: NUTRIPLAN Unidade: UN/1
 F1 F4

UN: R\$ 135,78 AV: R\$ 135,78 15: R\$ 138,60
 30: R\$ 141,38 45: R\$ 144,20 60: R\$ 147,09
 42 cm
 30 cm



VASO PL RISCATTO CONICO 42 FERRUGEM 20LT

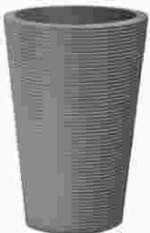

Código: 30280 Fábrica: NUTRIPLAN Unidade: UN/1
 F1 F4

UN: R\$ 135,78 AV: R\$ 135,78 15: R\$ 138,60
 30: R\$ 141,38 45: R\$ 144,20 60: R\$ 147,09
 42 cm
 30 cm



VASO PL RISCATTO CONICO 42 GRANITO 20LTS



Código: 30281 Fábrica: NUTRIPLAN Unidade: UN/1
 F1 F4

UN: R\$ 228,64 AV: R\$ 228,64 15: R\$ 233,41
 30: R\$ 238,07 45: R\$ 242,84 60: R\$ 247,69
 55 cm
 39 cm



VASO PL RISCATTO CONICO 55 FERRUGEM 44LT



Código: 30282 Fábrica: NUTRIPLAN Unidade: UN/1
 F1 F4

UN: R\$ 159,04 AV: R\$ 159,04 15: R\$ 162,36
 30: R\$ 165,60 45: R\$ 168,91 60: R\$ 172,29
 55 cm
 39 cm



VASO PL RISCATTO CONICO 55 GRANITO 44LTS

Código: 30283 Fábrica: NUTRIPLAN Unidade: UN/1
 F1 F4

UN: R\$ 79,61 AV: R\$ 79,61 15: R\$ 81,27
 30: R\$ 82,89 45: R\$ 84,55 60: R\$ 86,24
 42 cm
 31 cm



VASO PL RISCATTO OVAL BAIXO 22 AREIA 12L

Código: 30270 Fábrica: NUTRIPLAN Unidade: UN/1
 F1 F4

UN: R\$ 79,61 AV: R\$ 79,61 15: R\$ 81,27
 30: R\$ 82,89 45: R\$ 84,55 60: R\$ 86,24



VASO PL RISCATTO OVAL BAIXO 22 FERRU 12L
 Código: 30271 Fábrica: NUTRIPLAN Unidade: UN/1
 F1 F4

UN: R\$ 79,61 AV: R\$ 79,61 15: R\$ 81,27
 30: R\$ 82,89 45: R\$ 84,55 60: R\$ 86,24





VASO PL RISCATTO OVAL BAIXO 22 GRANI 12L
 Código: 37410 Fábrica: NUTRIPLAN Unidade: UN/1
 F1 F4

UN: R\$ 141,00 AV: R\$ 141,00 15: R\$ 143,94
 30: R\$ 146,82 45: R\$ 149,76 60: R\$ 152,75





VASO PL RISCATTO OVAL BAIXO 30 AREIA 32L
 Código: 30269 Fábrica: NUTRIPLAN Unidade: UN/1
 F1 F4

UN: R\$ 141,00 AV: R\$ 141,00 15: R\$ 143,94
 30: R\$ 146,82 45: R\$ 149,76 60: R\$ 152,75





VASO PL RISCATTO OVAL BAIXO 30 FERRU 32L
 Código: 30268 Fábrica: NUTRIPLAN Unidade: UN/1
 F1 F4

UN: R\$ 104,58 AV: R\$ 104,58 15: R\$ 106,76
 30: R\$ 108,89 45: R\$ 111,07 60: R\$ 113,29





VASO PL RISCATTO RED 34 AREIA 26,5LT
 Código: 30272 Fábrica: NUTRIPLAN Unidade: UN/1
 F1 F4

UN: R\$ 108,30 AV: R\$ 108,30 15: R\$ 110,56
 30: R\$ 112,77 45: R\$ 115,02 60: R\$ 117,32





VASO PL RISCATTO RED 34 FERRUGEM 26,5LTS
 Código: 30273 Fábrica: NUTRIPLAN Unidade: UN/1
 F1 F4

UN: R\$ 104,58 AV: R\$ 104,58 15: R\$ 106,76
 30: R\$ 108,89 45: R\$ 111,07 60: R\$ 113,29



VASO PL RISCATTO RED 34 GRANITO 26,5LTS
 Código: 30274 Fábrica: NUTRIPLAN Unidade: UN/1
 F1 F4

UN: R\$ 2,66 AV: R\$ 2,66 15: R\$ 2,72
 30: R\$ 2,77 45: R\$ 2,83 60: R\$ 2,89



VASO PL ROMANO RED MINI MARROM 0,6L
 Código: 22309 Fábrica: NUTRIPLAN Unidade: UN/1
 F1 F4

UN: R\$ 8,24 AV: R\$ 8,24 15: R\$ 8,42
 30: R\$ 8,59 45: R\$ 8,76 60: R\$ 8,93



VASO PL ROMANO 0 RED PEQ MARROM 2L
 Código: 22308 Fábrica: NUTRIPLAN Unidade: UN/1
 F1 F4

UN: R\$ 6,85 AV: R\$ 6,85 15: R\$ 7,00
 30: R\$ 7,14 45: R\$ 7,28 60: R\$ 7,43





VASO PL ROMANO 0 RED PEQ PRETO 2L
 Código: 39641 Fábrica: NUTRIPLAN Unidade: UN/1
 F1 F4

UN: R\$ 15,88 AV: R\$ 15,88 15: R\$ 16,21
 30: R\$ 16,54 45: R\$ 16,87 60: R\$ 17,21





VASO PL ROMANO 1 RED MED MARROM 5L
 Código: 22307 Fábrica: NUTRIPLAN Unidade: UN/1
 F1 F4

UN: R\$ 13,51 AV: R\$ 13,51 15: R\$ 13,79
 30: R\$ 14,07 45: R\$ 14,35 60: R\$ 14,64





VASO PL ROMANO 1 RED MED PRETO 5L
 Código: 39642 Fábrica: NUTRIPLAN Unidade: UN/1
 F1 F4

UN: R\$ 21,89 AV: R\$ 21,89 15: R\$ 22,34
 30: R\$ 22,79 45: R\$ 23,24 60: R\$ 23,71





VASO PL ROMANO 2 RED GDE MARROM 8,5L
 Código: 22306 Fábrica: NUTRIPLAN Unidade: UN/1
 F1 F4

UN: R\$ 18,60 AV: R\$ 18,60 15: R\$ 18,99
 30: R\$ 19,37 45: R\$ 19,76 60: R\$ 20,15





VASO PL ROMANO 2 RED PRETO 8,5L
 Código: 39643 Fábrica: NUTRIPLAN Unidade: UN/1
 F1 F4

UN: R\$ 22,03 AV: R\$ 22,03 15: R\$ 22,49
 30: R\$ 22,94 45: R\$ 23,40 60: R\$ 23,87





VASO PL ROMANO 2 RED TABACO 8,5L
 Código: 39855 Fábrica: NUTRIPLAN Unidade: UN/1
 F1 F4

UN: R\$ 26,44 AV: R\$ 26,44 15: R\$ 26,99
 30: R\$ 27,53 45: R\$ 28,08 60: R\$ 28,64





VASO PL ROMANO 3 RED CAPUCCINO 19L
 Código: 36195 Fábrica: NUTRIPLAN Unidade: UN/1
 F1 F4

UN: R\$ 34,27 AV: R\$ 34,27 15: R\$ 34,99
 30: R\$ 35,69 45: R\$ 36,40 60: R\$ 37,13





VASO PL ROMANO 3 RED MARROM 19 L
 Código: 22305 Fábrica: NUTRIPLAN Unidade: UN/1
 F1 F4

UN: R\$ 35,45 AV: R\$ 35,45 15: R\$ 36,19
 30: R\$ 36,91 45: R\$ 37,65 60: R\$ 38,40





VASO PL ROMANO 3 RED PRETO 19 L
 Código: 39644 Fábrica: NUTRIPLAN Unidade: UN/1
 F1 F4

UN: R\$ 8,13 AV: R\$ 8,13 15: R\$ 8,30
 30: R\$ 8,46 45: R\$ 8,63 60: R\$ 8,80





VASO PL SINT 13 S/BORDA ARGILA 0908-1
 Código: 37083 Fábrica: PAIOL Unidade: UN/1
 F1 F4

UN: R\$ 7,82 AV: R\$ 7,82 15: R\$ 7,99
 30: R\$ 8,15 45: R\$ 8,31 60: R\$ 8,48



VASO PL SINT 13 S/BORDA BANANA 0908-2
 Código: 39445 Fábrica: PAIOL Unidade: UN/1
 F1 F4

UN: R\$ 14,44 AV: R\$ 14,44 15: R\$ 14,74
 30: R\$ 15,04 45: R\$ 15,34 60: R\$ 15,65





VASO PL SINT 16 S/BORDA BANANA 3598-2
 Código: 37082 Fábrica: PAIOL Unidade: UN/1
 F1 F4

UN: R\$ 14,44 AV: R\$ 14,44 15: R\$ 14,74
 30: R\$ 15,04 45: R\$ 15,34 60: R\$ 15,65



VASO PL SINT 16 S/BORDA CAPUCINO 3598
 Código: 39465 Fábrica: PAIOL Unidade: UN/1
 F1 F4

UN: R\$ 19,57 AV: R\$ 19,57 15: R\$ 19,98
 30: R\$ 20,38 45: R\$ 20,79 60: R\$ 21,21



VASO PL SINT 18 S/BORDA ARGILA 909-1
 Código: 37081 Fábrica: PAIOL Unidade: UN/1
 F1 F4

UN: R\$ 19,57 AV: R\$ 19,57 15: R\$ 19,98
 30: R\$ 20,38 45: R\$ 20,79 60: R\$ 21,21



VASO PL SINT 18 S/BORDA BANANA 909-2
 Código: 40843 Fábrica: PAIOL Unidade: UN/1
 F1 F4

UN: R\$ 19,57 AV: R\$ 19,57 15: R\$ 19,98
 30: R\$ 20,38 45: R\$ 20,79 60: R\$ 21,21



VASO PL SINT 18 S/BORDA CAFE 909-4
 Código: 39462 Fábrica: PAIOL Unidade: UN/1
 F1 F4

UN: R\$ 19,57 AV: R\$ 19,57 15: R\$ 19,98
 30: R\$ 20,38 45: R\$ 20,79 60: R\$ 21,21



VASO PL SINT 18 S/BORDA CAPUCINO 909
 Código: 39463 Fábrica: PAIOL Unidade: UN/1
 F1 F4

UN: R\$ 29,37 AV: R\$ 29,37 15: R\$ 29,98
 30: R\$ 30,58 45: R\$ 31,19 60: R\$ 31,81



VASO PL SINT 20 S/BORDA BANANA 8006-4
 Código: 40844 Fábrica: PAIOL Unidade: UN/1
 F1 F4

UN: R\$ 35,24 AV: R\$ 35,24 15: R\$ 35,98
 30: R\$ 36,70 45: R\$ 37,43 60: R\$ 38,18



VASO PL SINT 24 S/BORDA BANANA 3538-2
 Código: 37089 Fábrica: PAIOL Unidade: UN/1
 F1 F4

UN: R\$ 35,24 AV: R\$ 35,24 15: R\$ 35,98
 30: R\$ 36,70 45: R\$ 37,43 60: R\$ 38,18



VASO PL SINT 24 S/BORDA CAPUCINO 3538-3
 Código: 39929 Fábrica: PAIOL Unidade: UN/1
 F1 F4

UN: R\$ 39,16 AV: R\$ 39,16 15: R\$ 39,97
 30: R\$ 40,77 45: R\$ 41,59 60: R\$ 42,42



VASO PL SINT 27 S/BORDA ARGILA 3541-1
 Código: 41755 Fábrica: PAIOL Unidade: UN/1
 F1 F4

UN: R\$ 44,72 AV: R\$ 44,72 15: R\$ 45,65
 30: R\$ 46,56 45: R\$ 47,50 60: R\$ 48,45



VASO PL SINT 27 S/BORDA BANANA 3541-2
 Código: 37088 Fábrica: PAIOL Unidade: UN/1
 F1 F4

UN: R\$ 87,42 AV: R\$ 87,42 15: R\$ 89,24
 30: R\$ 91,03 45: R\$ 92,85 60: R\$ 94,71



VASO PL SINT 98 C/BORDA ARGILA 26958-1
 Código: 37122 Fábrica: PAIOL Unidade: UN/1
 F1 F4

UN: R\$ 3,87 AV: R\$ 3,87 15: R\$ 3,95
30: R\$ 4,03 45: R\$ 4,11 60: R\$ 4,19

11 5 cm
12 7 cm



VASO PL SISAL POTE MINI AVELA 8000-4

Código: Fábrica: Unidade:
40594 PAIOL UN/1
F1 F4

UN: R\$ 3,87 AV: R\$ 3,87 15: R\$ 3,95
30: R\$ 4,03 45: R\$ 4,11 60: R\$ 4,19

11 5 cm
12 7 cm



VASO PL SISAL POTE MINI MARROM 8000-1

Código: Fábrica: Unidade:
40592 PAIOL UN/1
F1 F4

UN: R\$ 4,89 AV: R\$ 4,89 15: R\$ 4,99
30: R\$ 5,09 45: R\$ 5,19 60: R\$ 5,29

11 5,5 cm
12 7,5 cm



VASO PL SISAL POTE MINI NATURAL 8000-2

Código: Fábrica: Unidade:
37131 PAIOL UN/1
F1 F4

UN: R\$ 6,22 AV: R\$ 6,22 15: R\$ 6,35
30: R\$ 6,47 45: R\$ 6,60 60: R\$ 6,74



VASO PL SISAL POTE 10 AVELA 8001

Código: Fábrica: Unidade:
39448 PAIOL UN/1
F1 F4

UN: R\$ 6,22 AV: R\$ 6,22 15: R\$ 6,35
30: R\$ 6,47 45: R\$ 6,60 60: R\$ 6,74



VASO PL SISAL POTE 10 CARAMELO 8001

Código: Fábrica: Unidade:
39449 PAIOL UN/1
F1 F4

UN: R\$ 6,22 AV: R\$ 6,22 15: R\$ 6,35
30: R\$ 6,47 45: R\$ 6,60 60: R\$ 6,74



VASO PL SISAL POTE 10 MARROM 8001

Código: Fábrica: Unidade:
39447 PAIOL UN/1
F1 F4

UN: R\$ 6,46 AV: R\$ 6,46 15: R\$ 6,60
30: R\$ 6,73 45: R\$ 6,86 60: R\$ 7,00

11 8 cm
12 11 cm



VASO PL SISAL POTE 10 NATURAL 8001-3

Código: Fábrica: Unidade:
37130 PAIOL UN/1
F1 F4

UN: R\$ 8,71 AV: R\$ 8,71 15: R\$ 8,90
30: R\$ 9,07 45: R\$ 9,26 60: R\$ 9,44

11 9 cm
12 13 cm



VASO PL SISAL POTE 12 CORES 8002

Código: Fábrica: Unidade:
37129 PAIOL UN/1
F1 F4

UN: R\$ 9,99 AV: R\$ 9,99 15: R\$ 10,20
30: R\$ 10,40 45: R\$ 10,61 60: R\$ 10,82

11 10 cm
12 15 cm



VASO PL SISAL POTE 14 CORES 8003

Código: Fábrica: Unidade:
37128 PAIOL UN/1
F1 F4

UN: R\$ 11,36 AV: R\$ 11,36 15: R\$ 11,60
30: R\$ 11,83 45: R\$ 12,06 60: R\$ 12,31

11 12 cm
12 16 cm



VASO PL SISAL POTE 16 CORES 8004

Código: Fábrica: Unidade:
37127 PAIOL UN/1
F1 F4

UN: R\$ 20,27 AV: R\$ 20,27 15: R\$ 20,69
30: R\$ 21,11 45: R\$ 21,53 60: R\$ 21,96

11 25 cm
12 30 cm



VASO PL TERRACOTA 2 MED MARROM

Código: Fábrica: Unidade:
18480 NUTRIPLAN UN/1
F1 F4

UN: R\$ 35,09 AV: R\$ 35,09 15: R\$ 35,83
30: R\$ 36,54 45: R\$ 37,27 60: R\$ 38,02

11 31 cm
12 39 cm



VASO PL TERRACOTA 3 GDE MARROM 22 L

Código: Fábrica: Unidade:
18482 NUTRIPLAN UN/1
F1 F4

UN: R\$ 30,36 AV: R\$ 30,36 15: R\$ 30,99
30: R\$ 31,61 45: R\$ 32,24 60: R\$ 32,88

1 22 lts



VASO PL TERRACOTA 3 GDE PTO 22 L

Código: Fábrica: Unidade:
18483 NUTRIPLAN UN/1
F1 F4

UN: R\$ 57,04 AV: R\$ 57,04 15: R\$ 58,23
30: R\$ 59,39 45: R\$ 60,58 60: R\$ 61,79

1 19cm



VASO PL TEXTURIZADO OVAL 19 AREIA 5,3L

Código: Fábrica: Unidade:
47612 NUTRIPLAN UN/1
F1 F4

UN: R\$ 57,04 AV: R\$ 57,04 15: R\$ 58,23
30: R\$ 59,39 45: R\$ 60,58 60: R\$ 61,79

1 19cm



VASO PL TEXTURIZADO OVAL 19 CIMENTO 5,3L

Código: Fábrica: Unidade:
47614 NUTRIPLAN UN/1
F1 F4

UN: R\$ 57,04 AV: R\$ 57,04 15: R\$ 58,23
30: R\$ 59,39 45: R\$ 60,58 60: R\$ 61,79

1 19cm



VASO PL TEXTURIZADO OVAL 19 FERRUGEM 5,3L

Código: Fábrica: Unidade:
47611 NUTRIPLAN UN/1
F1 F4

UN: R\$ 57,04 AV: R\$ 57,04 15: R\$ 58,23
30: R\$ 59,39 45: R\$ 60,58 60: R\$ 61,79

19cm



VASO PL TEXTURIZADO OVAL 19 GRANITO 5,3L

Código: 47613 Fábrica: NUTRIPLAN Unidade: UN/1
F1 F4

UN: R\$ 57,04 AV: R\$ 57,04 15: R\$ 58,23
30: R\$ 59,39 45: R\$ 60,58 60: R\$ 61,79

19cm



VASO PL TEXTURIZADO OVAL 19 PRETO 5,3L

Código: 47615 Fábrica: NUTRIPLAN Unidade: UN/1
F1 F4

UN: R\$ 148,84 AV: R\$ 148,84 15: R\$ 151,94
30: R\$ 154,98 45: R\$ 158,08 60: R\$ 161,24

34 cm
41 cm



VASO PL TINA RED 34 CARVALHO 30LTS

Código: 30311 Fábrica: NUTRIPLAN Unidade: UN/1
F1 F4

UN: R\$ 235,99 AV: R\$ 235,99 15: R\$ 240,90
30: R\$ 245,72 45: R\$ 250,64 60: R\$ 255,65

45 cm
54 cm



VASO PL TINA RED 45 CARVALHO 80LTS

Código: 30332 Fábrica: NUTRIPLAN Unidade: UN/1
F1 F4

UN: R\$ 56,79 AV: R\$ 56,79 15: R\$ 57,98
30: R\$ 59,14 45: R\$ 60,32 60: R\$ 61,53

30 cm
14 cm
6,5 lts



VASO PL TRECCIA CONICO 30 CARVALHO 6,5LT

Código: 33388 Fábrica: NUTRIPLAN Unidade: UN/1
F1 F4

UN: R\$ 84,20 AV: R\$ 84,20 15: R\$ 85,96
30: R\$ 87,67 45: R\$ 89,43 60: R\$ 91,22

30 cm
14 cm
6,5 lts



VASO PL TRECCIA CONICO 30 ENVELHECI 6,5L

Código: 32745 Fábrica: NUTRIPLAN Unidade: UN/1
F1 F4

UN: R\$ 68,15 AV: R\$ 68,15 15: R\$ 69,57
30: R\$ 70,96 45: R\$ 72,38 60: R\$ 73,83

39 cm
30 cm
33 lts



VASO PL TRECCIA CONICO 39 GRAFITE 33LTS

Código: 36806 Fábrica: NUTRIPLAN Unidade: UN/1
F1 F4

UN: R\$ 254,59 AV: R\$ 254,59 15: R\$ 259,90
30: R\$ 265,09 45: R\$ 270,40 60: R\$ 275,80

53 cm
36 cm



VASO PL TRECCIA CONICO 53 CARVALHO 42LTS

Código: 32747 Fábrica: NUTRIPLAN Unidade: UN/1
F1 F4

UN: R\$ 88,13 AV: R\$ 88,13 15: R\$ 89,96
30: R\$ 91,76 45: R\$ 93,60 60: R\$ 95,47

33 cm
43 cm



VASO PL TRECCIA OVAL 33 CARVALHO 19LTS

Código: 32748 Fábrica: NUTRIPLAN Unidade: UN/1
F1 F4

UN: R\$ 76,38 AV: R\$ 76,38 15: R\$ 77,97
30: R\$ 79,53 45: R\$ 81,12 60: R\$ 82,74

24 cm
26,5 cm
8,5 lts



VASO PL TRECCIA RED 24 CARVALHO 8,5LTS

Código: 33389 Fábrica: NUTRIPLAN Unidade: UN/1
F1 F4

UN: R\$ 77,14 AV: R\$ 77,14 15: R\$ 78,75
30: R\$ 80,32 45: R\$ 81,93 60: R\$ 83,57

24 cm
26,5 cm
8,5 lts



VASO PL TRECCIA RED 24 ENVELHECIDO 8,5LT

Código: 33390 Fábrica: NUTRIPLAN Unidade: UN/1
F1 F4

UN: R\$ 76,38 AV: R\$ 76,38 15: R\$ 77,97
30: R\$ 79,53 45: R\$ 81,12 60: R\$ 82,74

24 cm
26,5 cm
8,5 lts



VASO PL TRECCIA RED 24 RUBI 8,5LTS

Código: 33391 Fábrica: NUTRIPLAN Unidade: UN/1
F1 F4

UN: R\$ 151,77 AV: R\$ 151,77 15: R\$ 154,93
30: R\$ 158,03 45: R\$ 161,19 60: R\$ 164,41

31 cm
34 cm
20 lts



VASO PL TRECCIA RED 31 CARVALHO 20LTS

Código: 33393 Fábrica: NUTRIPLAN Unidade: UN/1
F1 F4

UN: R\$ 117,50 AV: R\$ 117,50 15: R\$ 119,95
30: R\$ 122,35 45: R\$ 124,80 60: R\$ 127,29

31 cm
34 cm
20 lts



VASO PL TRECCIA RED 31 ENVELHECIDO 20LTS

Código: 32749 Fábrica: NUTRIPLAN Unidade: UN/1
F1 F4

UN: R\$ 86,17 AV: R\$ 86,17 15: R\$ 87,96
30: R\$ 89,72 45: R\$ 91,52 60: R\$ 93,35

31 cm
34 cm
20 lts



VASO PL TRECCIA RED 31 GRAFITE 20LTS

Código: 36804 Fábrica: NUTRIPLAN Unidade: UN/1
F1 F4

UN: R\$ 86,17 AV: R\$ 86,17 15: R\$ 87,96
30: R\$ 89,72 45: R\$ 91,52 60: R\$ 93,35

31 cm
34 cm
20 lts



VASO PL TRECCIA RED 31 MARINHO 20LTS

Código: 36805 Fábrica: NUTRIPLAN Unidade: UN/1
F1 F4

UN: R\$ 86,17 AV: R\$ 86,17 15: R\$ 87,96
 30: R\$ 89,72 45: R\$ 91,52 60: R\$ 93,35
 31 cm
 34 cm
 20 lts



VASO PL TRECCIA RED 31 RUBI 20LTS
 Código: 33394 Fábrica: NUTRIPLAN Unidade: UN/1
 F1 F4

UN: R\$ 3,82 AV: R\$ 3,82 15: R\$ 3,90
 30: R\$ 3,98 45: R\$ 4,06 60: R\$ 4,14
 109 cm



VASO PL TREVO PRETO 09CM 226
 Código: 40716 Fábrica: PLASMARC Unidade: UN/1
 F1 F4

UN: R\$ 9,45 AV: R\$ 9,45 15: R\$ 9,65
 30: R\$ 9,84 45: R\$ 10,04 60: R\$ 10,24
 22 cm
 25 cm
 5 lts



VASO PL VB 25 PRETO 5L 525
 Código: 37716 Fábrica: BIG PLAST Unidade: UN/1
 F1 F4

UN: R\$ 42,61 AV: R\$ 42,61 15: R\$ 43,49
 30: R\$ 44,36 45: R\$ 45,25 60: R\$ 46,15
 27 cm
 30 cm



VASO PL VB 30 S/BORDA 7059
 Código: 37090 Fábrica: PAIOL Unidade: UN/1
 F1 F4

UN: R\$ 20,07 AV: R\$ 20,07 15: R\$ 20,49
 30: R\$ 20,90 45: R\$ 21,32 60: R\$ 21,75
 30 cm
 34 cm
 13 lts



VASO PL VB 34 PRETO 13L 534
 Código: 37711 Fábrica: BIG PLAST Unidade: UN/1
 F1 F4

UN: R\$ 84,20 AV: R\$ 84,20 15: R\$ 85,96
 30: R\$ 87,67 45: R\$ 89,43 60: R\$ 91,22
 29 cm
 35 cm



VASO PL VB 35 S/BORDA ARGILA 7060-1
 Código: 37091 Fábrica: PAIOL Unidade: UN/1
 F1 F4

UN: R\$ 122,50 AV: R\$ 122,50 15: R\$ 125,05
 30: R\$ 127,55 45: R\$ 130,10 60: R\$ 132,70
 40 cm
 45 cm



VASO PL VB 45 S/BORDA 7061
 Código: 37092 Fábrica: PAIOL Unidade: UN/1
 F1 F4

UN: R\$ 15,47 AV: R\$ 15,47 15: R\$ 15,79
 30: R\$ 16,11 45: R\$ 16,43 60: R\$ 16,76
 17 cm
 22 cm



VASO PL VIME SINT N4 CORES 8006
 Código: 37216 Fábrica: PAIOL Unidade: UN/1
 F1 F4

UN: R\$ 7,54 AV: R\$ 7,54 15: R\$ 7,70
 30: R\$ 7,85 45: R\$ 8,01 60: R\$ 8,17
 10 cm
 15 cm



VASO PL VIOLETA QUAD CAFE 00140
 Código: 37148 Fábrica: PAIOL Unidade: UN/1
 F1 F4

UN: R\$ 13,07 AV: R\$ 13,07 15: R\$ 13,34
 30: R\$ 13,61 45: R\$ 13,88 60: R\$ 14,16



VASO PL VIOLETA RED FIO ARGILA 4569-1
 Código: 41753 Fábrica: PAIOL Unidade: UN/1
 F1 F4

UN: R\$ 17,62 AV: R\$ 17,62 15: R\$ 17,98
 30: R\$ 18,34 45: R\$ 18,71 60: R\$ 19,08
 8 cm
 15 cm



VASO PL VIOLETA RED MADEIRA ENVELHE 1460
 Código: 37110 Fábrica: PAIOL Unidade: UN/1
 F1 F4

UN: R\$ 11,02 AV: R\$ 11,02 15: R\$ 11,25
 30: R\$ 11,47 45: R\$ 11,70 60: R\$ 11,93
 20 cm
 25 cm
 7 lts



VASO PL VQ 25 QUAD PRETO 7L 583
 Código: 37703 Fábrica: BIG PLAST Unidade: UN/1
 F1 F4

UN: R\$ 27,23 AV: R\$ 27,23 15: R\$ 27,80
 30: R\$ 28,35 45: R\$ 28,92 60: R\$ 29,50
 30 cm
 35 cm
 20 lts



VASO PL VQ 35 QUAD PRETO 20L 586
 Código: 37702 Fábrica: BIG PLAST Unidade: UN/1
 F1 F4

UN: R\$ 3,92 AV: R\$ 3,92 15: R\$ 4,00
 30: R\$ 4,08 45: R\$ 4,16 60: R\$ 4,24
 10 cm



VASO PL 0 RED PRETO 08CM 300
 Código: 40713 Fábrica: PLASMARC Unidade: UN/1
 F1 F4

UN: R\$ 4,41 AV: R\$ 4,41 15: R\$ 4,50
 30: R\$ 4,59 45: R\$ 4,68 60: R\$ 4,77
 11 cm



VASO PL 1 QUAD PRETO 11CM 234
 Código: 40712 Fábrica: PLASMARC Unidade: UN/1
 F1 F4

UN: R\$ 132,19 AV: R\$ 132,19 15: R\$ 134,95
 30: R\$ 137,64 45: R\$ 140,40 60: R\$ 143,21
 50 cm
 58 cm
 90 lts



VASO PL 10 RED GIG PRETO 90LTS
 Código: 39640 Fábrica: NUTRIPLAN Unidade: UN/1
 F1 F4

UN: R\$ 2,55 AV: R\$ 2,55 15: R\$ 2,60
30: R\$ 2,65 45: R\$ 2,70 60: R\$ 2,76

11 cm



VASO PL 11CM C/PRATO 11CM PRETO 346

Código: Fábriça: Unidade:
40851 JOREAL UN/1
F1 F4

UN: R\$ 9,01 AV: R\$ 9,01 15: R\$ 9,20
30: R\$ 9,38 45: R\$ 9,57 60: R\$ 9,76

VASO PL 12LTS MARFIM 6408

Código: Fábriça: Unidade:
41481 KOZI PLAST UN/1
F1 F4



UN: R\$ 16,15 AV: R\$ 16,15 15: R\$ 16,48
30: R\$ 16,81 45: R\$ 17,15 60: R\$ 17,49

25cm
32cm
12,5Lts



VASO PL 12,5 LTS QUAD GDE PRETO 6701

Código: Fábriça: Unidade:
26767 INPLAST UN/1
F1 F4

UN: R\$ 4,64 AV: R\$ 4,64 15: R\$ 4,74
30: R\$ 4,83 45: R\$ 4,93 60: R\$ 5,03

15 cm
17 cm
1,8 lts



VASO PL 17 PRETO 1,8L 308

Código: Fábriça: Unidade:
37718 BIG PLAST UN/1
F1 F4

UN: R\$ 5,41 AV: R\$ 5,41 15: R\$ 5,52
30: R\$ 5,63 45: R\$ 5,74 60: R\$ 5,86

17 cm
20 cm
3,3 lts



VASO PL 20 PRETO 3,3L 316

Código: Fábriça: Unidade:
37717 BIG PLAST UN/1
F1 F4

UN: R\$ 8,80 AV: R\$ 8,80 15: R\$ 8,99
30: R\$ 9,17 45: R\$ 9,35 60: R\$ 9,54

20 cm
24 cm
6 lts



VASO PL 24 PRETO 6L 324

Código: Fábriça: Unidade:
37715 BIG PLAST UN/1
F1 F4

UN: R\$ 12,72 AV: R\$ 12,72 15: R\$ 12,98
30: R\$ 13,24 45: R\$ 13,51 60: R\$ 13,78

23 cm
27 cm
8,5 L



VASO PL 27 PRETO 8,5L 332

Código: Fábriça: Unidade:
37714 BIG PLAST UN/1
F1 F4

UN: R\$ 4,90 AV: R\$ 4,90 15: R\$ 5,00
30: R\$ 5,10 45: R\$ 5,20 60: R\$ 5,30

14 cm



VASO PL 3 QUAD PRETO 14CM 129

Código: Fábriça: Unidade:
40711 PLASMARC UN/1
F1 F4

UN: R\$ 14,57 AV: R\$ 14,57 15: R\$ 14,87
30: R\$ 15,17 45: R\$ 15,48 60: R\$ 15,78

26 cm
30 cm
11,5 lts



VASO PL 30 PRETO 11,5L 340

Código: Fábriça: Unidade:
37713 BIG PLAST UN/1
F1 F4

UN: R\$ 20,32 AV: R\$ 20,32 15: R\$ 20,74
30: R\$ 21,16 45: R\$ 21,58 60: R\$ 22,01

30 cm
35 cm
22 lts



VASO PL 35 PRETO 22L 348

Código: Fábriça: Unidade:
37710 BIG PLAST UN/1
F1 F4

UN: R\$ 9,21 AV: R\$ 9,21 15: R\$ 9,41
30: R\$ 9,59 45: R\$ 9,79 60: R\$ 9,98

5,5 L



VASO PL 5,5 LTS QUAD MED PTO 6700

Código: Fábriça: Unidade:
26762 INPLAST UN/1
F1 F4

UN: R\$ 9,21 AV: R\$ 9,21 15: R\$ 9,41
30: R\$ 9,59 45: R\$ 9,79 60: R\$ 9,98

5,5 L



VASO PL 5,5 LTS QUAD MED TERRACOTA 6718

Código: Fábriça: Unidade:
26765 INPLAST UN/1
F1 F4

UN: R\$ 9,21 AV: R\$ 9,21 15: R\$ 9,41
30: R\$ 9,59 45: R\$ 9,79 60: R\$ 9,98

5,5 L



VASO PL 5,5 LTS RED MED TERRACOTA 6712

Código: Fábriça: Unidade:
26764 INPLAST UN/1
F1 F4

UN: R\$ 22,85 AV: R\$ 274,17 15: R\$ 279,88
30: R\$ 285,48 45: R\$ 291,19 60: R\$ 297,01



VASSOURA PELO SINTETICO M9 522 12X1

Código: Fábriça: Unidade:
38416 N.HORIZONTE DZ/12
F1 F4

UN: R\$ 16,45 AV: R\$ 16,45 15: R\$ 16,79
30: R\$ 17,13 45: R\$ 17,47 60: R\$ 17,82



VASSOURA PIACAVA NYLON CECI C/CB 1293

Código: Fábriça: Unidade:
49806 CECI JOIA UN/1
F1 F4

UN: R\$ 14,24 AV: R\$ 14,24 15: R\$ 14,53
30: R\$ 14,82 45: R\$ 15,12 60: R\$ 15,42



VASSOURA PIACAVA NYLON JOIA C/CB UN 3241

Código: Fábriça: Unidade:
49805 CECI JOIA UN/1
F1 F4

UN: R\$ 24,47 AV: R\$ 24,47 15: R\$ 24,98
30: R\$ 25,48 45: R\$ 25,99 60: R\$ 26,51

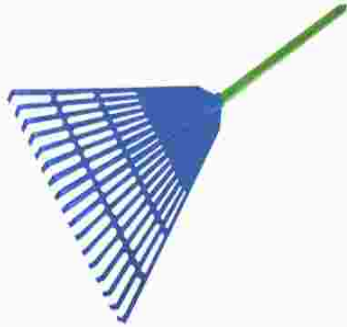

VASSOURA RASTELO PL AZUL P/GRAMA CB MAD

Código: Fábrika: Unidade:
32770 NUTRIPLAN UN/1
F1 F4

UN: R\$ 19,98 AV: R\$ 19,98 15: R\$ 20,39
30: R\$ 20,80 45: R\$ 21,22 60: R\$ 21,64



VASSOURA RASTELO PL P/GRAMA 46CM C/CB 80

Código: Fábrika: Unidade:
49807 EDS UN/1
F1 F4

UN: R\$ 24,47 AV: R\$ 24,47 15: R\$ 24,98
30: R\$ 25,48 45: R\$ 25,99 60: R\$ 26,51



VASSOURA RASTELO PL VERDE P/GRAMA CB MA

Código: Fábrika: Unidade:
18505 NUTRIPLAN UN/1
F1 F4

UN: R\$ 27,41 AV: R\$ 27,41 15: R\$ 27,98
30: R\$ 28,54 45: R\$ 29,11 60: R\$ 29,69



VASSOURA RASTELO PLAST P/GRAMA CB MAD

Código: Fábrika: Unidade:
48741 N.HORIZONTE UN/1
F1 F4

UN: R\$ 19,57 AV: R\$ 19,57 15: R\$ 19,98
30: R\$ 20,38 45: R\$ 20,79 60: R\$ 21,21

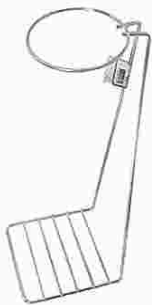

VELADOR CROM MED 18CM C/COADOR 426

Código: Fábrika: Unidade:
30756 ARAMINAS UN/1
F1 F4

UN: R\$ 12,72 AV: R\$ 12,72 15: R\$ 12,98
30: R\$ 13,24 45: R\$ 13,51 60: R\$ 13,78



VELADOR CROM MINI C/COADOR 15CM 722

Código: Fábrika: Unidade:
3490 ARAMINAS UN/1
F1 F4

UN: R\$ 13,70 AV: R\$ 13,70 15: R\$ 13,98
30: R\$ 14,26 45: R\$ 14,55 60: R\$ 14,84



VELADOR CROM 1 34CM 68

Código: Fábrika: Unidade:
24070 ARAMINAS UN/1
F1 F4

UN: R\$ 32,30 AV: R\$ 32,30 15: R\$ 32,98
30: R\$ 33,64 45: R\$ 34,31 60: R\$ 35,00

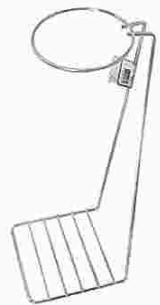

VELADOR CROM 2 GDE 48CM 69

Código: Fábrika: Unidade:
30922 ARAMINAS UN/1
F1 F4

UN: R\$ 7,82 AV: R\$ 7,82 15: R\$ 7,99
30: R\$ 8,15 45: R\$ 8,31 60: R\$ 8,48



VERMICULITA 1 LITRO

Código: Fábrika: Unidade:
48534 NOVATROPICAL PT/1
F1 F4

UN: R\$ 4,24 AV: R\$ 4,24 15: R\$ 4,33
30: R\$ 4,41 45: R\$ 4,50 60: R\$ 4,59



XICARA ACRIL CHA 180ML AZUL TIFFANY 1131

Código: Fábrika: Unidade:
49320 QUALYPLAS UN/1
F1 F4

UN: R\$ 4,28 AV: R\$ 51,41 15: R\$ 52,48
30: R\$ 53,53 45: R\$ 54,60 60: R\$ 55,69



XICARA VIDRO TRANSP 80ML 5CM 23339 12X1

Código: Fábrika: Unidade:
36748 MABEL CX/12
F1 F4

UN: R\$ 39,16 AV: R\$ 39,16 15: R\$ 39,97
30: R\$ 40,77 45: R\$ 41,59 60: R\$ 42,42



XICARAS CHA VID S/PIRES 6X1

Código: Fábrika: Unidade:
47420 BBC GLASS CJ/1
F1 F4