

UN: R\$ 0,85 AV: R\$ 42,73 15: R\$ 43,62  
30: R\$ 44,49 45: R\$ 45,38 60: R\$ 46,29



ABRACADEIRA ACO BORBOLETA ROSCA 1/2 50X1

Código: 51099 Fábrica: BESTFER Unidade: PT/50 F1 F4

UN: R\$ 0,86 AV: R\$ 43,18 15: R\$ 44,08  
30: R\$ 44,96 45: R\$ 45,86 60: R\$ 46,78



ABRACADEIRA ACO BORBOLETA ROSCA 3/4 50X1

Código: 51100 Fábrica: BESTFER Unidade: PT/50 F1 F4

UN: R\$ 9,97 AV: R\$ 9,97 15: R\$ 10,18  
30: R\$ 10,39 45: R\$ 10,59 60: R\$ 10,81



ABRACADEIRA METAL BORBOLETA 16/12/25 6X1

Código: 49562 Fábrica: ALIANCA Unidade: CJ/1 F1 F4

UN: R\$ 10,48 AV: R\$ 10,48 15: R\$ 10,70  
30: R\$ 10,92 45: R\$ 11,13 60: R\$ 11,36



ABRACADEIRA METAL P/M/G 6X1

Código: 44714 Fábrica: IMPERIO Unidade: CJ/1 F1 F4

UN: R\$ 0,07 AV: R\$ 6,59 15: R\$ 6,73  
30: R\$ 6,86 45: R\$ 7,00 60: R\$ 7,14



ABRACADEIRA NYLON 2,5X150MM PRETO 100X1

Código: 45904 Fábrica: WINMAX Unidade: PT/100 F1 F4

UN: R\$ 0,08 AV: R\$ 7,98 15: R\$ 8,14  
30: R\$ 8,31 45: R\$ 8,47 60: R\$ 8,64



ABRACADEIRA NYLON 2,5X200MM PRETO 100X1

Código: 49627 Fábrica: WINMAX Unidade: PT/100 F1 F4

UN: R\$ 0,16 AV: R\$ 15,58 15: R\$ 15,90  
30: R\$ 16,22 45: R\$ 16,54 60: R\$ 16,87



ABRACADEIRA NYLON 4,8X200MM PRETO 100X1

Código: 45530 Fábrica: WINMAX Unidade: PT/100 F1 F4

UN: R\$ 0,23 AV: R\$ 11,47 15: R\$ 11,71  
30: R\$ 11,94 45: R\$ 12,18 60: R\$ 12,43

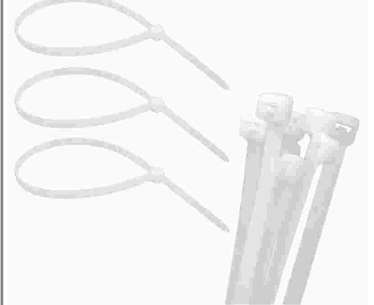

ABRACADEIRA NYLON 5X300MM BRANC 550 50X1

Código: 47625 Fábrica: PLANETA Unidade: PT/50 F1 F4

UN: R\$ 0,26 AV: R\$ 12,97 15: R\$ 13,24  
30: R\$ 13,50 45: R\$ 13,77 60: R\$ 14,05

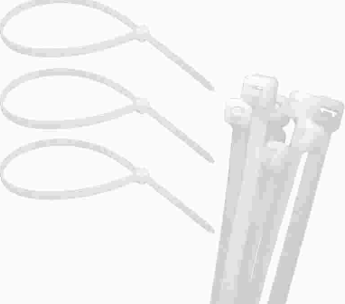

ABRACADEIRA NYLON 5X350MM BRANC 551 50X1

Código: 47624 Fábrica: PLANETA Unidade: PT/50 F1 F4

UN: R\$ 0,10 AV: R\$ 7,98 15: R\$ 8,14  
30: R\$ 8,31 45: R\$ 8,47 60: R\$ 8,64



ABRACADEIRA PLAST 2,5X100X150X200MM 80X1

Código: 45097 Fábrica: NYBC Unidade: PT/80 F1 F4

UN: R\$ 0,07 AV: R\$ 6,98 15: R\$ 7,12  
30: R\$ 7,27 45: R\$ 7,41 60: R\$ 7,56



ABRACADEIRA PLAST 3,6X150MM 9698 100X1

Código: 41601 Fábrica: EMILAR Unidade: PT/100 F1 F4

UN: R\$ 0,12 AV: R\$ 11,97 15: R\$ 12,22  
30: R\$ 12,46 45: R\$ 12,71 60: R\$ 12,97



ABRACADEIRA PLAST 3,6X200MM 100X1

Código: 45096 Fábrica: NYBC Unidade: PT/100 F1 F4

UN: R\$ 0,10 AV: R\$ 9,97 15: R\$ 10,18  
30: R\$ 10,39 45: R\$ 10,59 60: R\$ 10,81



ABRACADEIRA PLAST 3,6X200MM 465 100X1

Código: 41565 Fábrica: PLANETA Unidade: PT/100 F1 F4

UN: R\$ 7,99 AV: R\$ 7,99 15: R\$ 7,99  
30: R\$ 7,99 45: R\$ 7,99 60: R\$ 7,99



ACENDEADOR FOGAO CTL 3047

Código: 49631 Fábrica: WINMAX Unidade: UN/1 F1 F4

UN: R\$ 4,59 AV: R\$ 45,94 15: R\$ 45,94  
30: R\$ 45,94 45: R\$ 45,94 60: R\$ 45,94

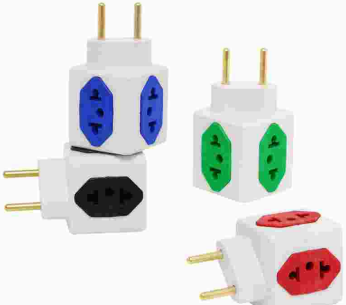

ADAPTADOR CUBO EF02 10X1

Código: 39383 Fábrica: GIROFLASH Unidade: PT/10 F1 F4

UN: R\$ 34,93 AV: R\$ 34,93 15: R\$ 35,66  
30: R\$ 36,38 45: R\$ 37,10 60: R\$ 37,84



ADAPTADOR DVI-CX VGA KP-AD108

Código: 47604 Fábrica: KNUP Unidade: UN/1 F1 F4

UN: R\$ 1,99 AV: R\$ 1,99 15: R\$ 2,03  
30: R\$ 2,07 45: R\$ 2,11 60: R\$ 2,15



ADAPTADOR PLAST TOMADA 20A UN

Código: 26675 Fábrica: GIRO FLASH Unidade: UN/1 F1 F4

UN: R\$ 2,60 AV: R\$ 64,89 15: R\$ 66,24  
30: R\$ 67,56 45: R\$ 68,91 60: R\$ 70,29



ADAPTADOR T BENJ 2PIN BOB ESP EF03 25X1

Código: 29067 Fábrica: GIROFLASH Unidade: PT/25 F1 F4

UN: R\$ 3,99 AV: R\$ 99,83 15: R\$ 101,91  
30: R\$ 103,95 45: R\$ 106,03 60: R\$ 108,15



ADAPTADOR T BENJ 2PIN 3ENT EF04 25X1

Código: 28775 Fábrica: GIROFLASH Unidade: PT/25 F1 F4

UN: R\$ 2,97 AV: R\$ 74,26 15: R\$ 75,81  
30: R\$ 77,32 45: R\$ 78,87 60: R\$ 80,45



ADAPTADOR T BENJ 2PIN 3ENT INV EF18 25X1

Código: 44514 Fábrica: GIROFLASH Unidade: PT/25 F1 F4

UN: R\$ 2,80 AV: R\$ 69,88 15: R\$ 71,33  
30: R\$ 72,76 45: R\$ 74,22 60: R\$ 75,70



ADAPTADOR T BENJ 2PIN 3ENT LAT EF01 25X1

Código: 28681 Fábrica: GIROFLASH Unidade: PT/25 F1 F4

UN: R\$ 2,91 AV: R\$ 72,78 15: R\$ 74,30  
30: R\$ 75,79 45: R\$ 77,30 60: R\$ 78,85



ADAPTADOR T BENJ 2PIN 3ENT PARAF 53 25X1

Código: 27974 Fábrica: GIROFLASH Unidade: PT/25 F1 F4

UN: R\$ 36,34 AV: R\$ 36,34 15: R\$ 37,10  
30: R\$ 37,84 45: R\$ 38,60 60: R\$ 39,37



ADAPTADOR TOMADA 2.1A USB CABO TPC 74508

Código: 44512 Fábrica: LETRON Unidade: UN/1 F1 F4

UN: R\$ 6,98 AV: R\$ 6,98 15: R\$ 7,12  
30: R\$ 7,27 45: R\$ 7,41 60: R\$ 7,56



ADAPTADOR 10A+ BOB ESPONJA KIT

Código: 40700 Fábrica: ELETRICAL Unidade: UN/1 F4

UN: R\$ 19,96 AV: R\$ 19,96 15: R\$ 20,37  
30: R\$ 20,78 45: R\$ 21,20 60: R\$ 21,62



ADAPTADOR 2P+T 10A BIV 111151

Código: 48014 Fábrica: IN-TECK Unidade: UN/1 F1 F4

UN: R\$ 3,98 AV: R\$ 3,98 15: R\$ 4,07  
30: R\$ 4,15 45: R\$ 4,23 60: R\$ 4,32



ADESIVO APLIQUE PEROLA PEQ 2060 CTL

Código: 32756 Fábrica: MEI CHEN Unidade: PT/1 F1 F4

UN: R\$ 3,98 AV: R\$ 3,98 15: R\$ 4,07  
30: R\$ 4,15 45: R\$ 4,23 60: R\$ 4,32



ADESIVO APLIQUE STRASS GDE 2059 CTL

Código: 40538 Fábrica: MEI CHEN Unidade: PT/1 F1 F4

UN: R\$ 3,98 AV: R\$ 3,98 15: R\$ 4,07  
30: R\$ 4,15 45: R\$ 4,23 60: R\$ 4,32

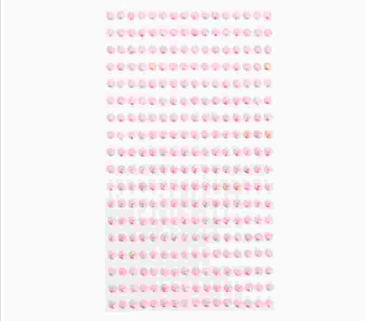

ADESIVO APLIQUE STRASS MED 2061 CTL

Código: 40540 Fábrica: MEI CHEN Unidade: PT/1 F1 F4

UN: R\$ 3,98 AV: R\$ 3,98 15: R\$ 4,07  
30: R\$ 4,15 45: R\$ 4,23 60: R\$ 4,32



ADESIVO APLIQUE STRASS MED 2062 CTL

Código: 40537 Fábrica: MEI CHEN Unidade: PT/1 F1 F4

UN: R\$ 3,98 AV: R\$ 3,98 15: R\$ 4,07  
30: R\$ 4,15 45: R\$ 4,23 60: R\$ 4,32

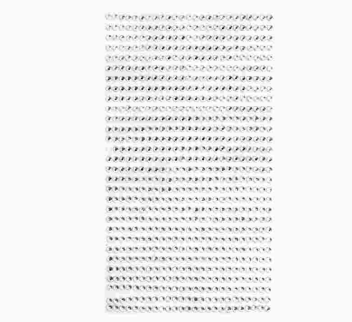

ADESIVO APLIQUE STRASS PEQ 057A CTL

Código: 40539 Fábrica: MEI CHEN Unidade: PT/1 F1 F4

UN: R\$ 3,98 AV: R\$ 3,98 15: R\$ 4,07  
30: R\$ 4,15 45: R\$ 4,23 60: R\$ 4,32

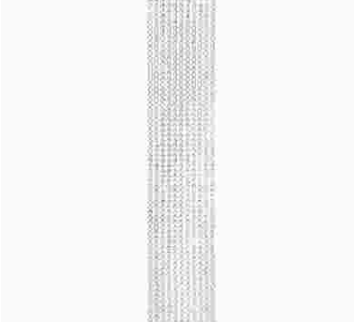

ADESIVO APLIQUE STRASS PEQ 2056 CTL

Código: 32753 Fábrica: MEI CHEN Unidade: PT/1 F1 F4

UN: R\$ 3,98 AV: R\$ 3,98 15: R\$ 4,07  
30: R\$ 4,15 45: R\$ 4,23 60: R\$ 4,32



ADESIVO APLIQUE STRASS 102X265MM CTL

Código: 37669 Fábrica: MEI CHEN Unidade: PT/1 F1 F4

UN: R\$ 26,62 AV: R\$ 159,73 15: R\$ 163,06  
30: R\$ 166,32 45: R\$ 169,65 60: R\$ 173,04



ADESIVO EPOXI ARALDITE HOBBY 16 GRS 6X1  
Código: Fábrica: Unidade:  
**42212** TEK BOND CX/6  
F1 F4

UN: R\$ 4,29 AV: R\$ 4,29 15: R\$ 4,38  
30: R\$ 4,47 45: R\$ 4,56 60: R\$ 4,65



ADESIVO PLAST GRUDA RATO 17X25CM L888  
Código: Fábrica: Unidade:  
**50955** HAI BRASIL UN/1  
F1 F4

UN: R\$ 39,93 AV: R\$ 39,93 15: R\$ 40,76  
30: R\$ 41,57 45: R\$ 42,40 60: R\$ 43,25



ADPADOR UBS 2.0 RJ45 USB LAN UR-01  
Código: Fábrica: Unidade:  
**47408** RR UN/1  
F1 F4

UN: R\$ 44,93 AV: R\$ 44,93 15: R\$ 45,86  
30: R\$ 46,78 45: R\$ 47,72 60: R\$ 48,67



ALICATE CRIMPAR CONECTOR RJ45 PADRAO CAT  
Código: Fábrica: Unidade:  
**44978** MB TOOLS UN/1  
F1 F4

UN: R\$ 24,95 AV: R\$ 24,95 15: R\$ 25,47  
30: R\$ 25,98 45: R\$ 26,50 60: R\$ 27,03



ALMOFADA RET 25X28CM FLAMENGO 11196  
Código: Fábrica: Unidade:  
**41108** BRASFOOT UN/1  
F1 F4

UN: R\$ 29,94 AV: R\$ 29,94 15: R\$ 30,57  
30: R\$ 31,18 45: R\$ 31,80 60: R\$ 32,44



ANTENA INTERNA P/TV DIGITAL HDTV/UHF/VHF  
Código: Fábrica: Unidade:  
**47411** HAI BRASIL UN/1  
F1 F4

UN: R\$ 0,38 AV: R\$ 37,93 15: R\$ 38,72  
30: R\$ 39,49 45: R\$ 40,28 60: R\$ 41,09  
1,5 cm



ANZOL BLACK CHINU N02 100X1  
Código: Fábrica: Unidade:  
**31008** MARINE CE/100  
F1 F4

UN: R\$ 0,39 AV: R\$ 38,93 15: R\$ 39,74  
30: R\$ 40,53 45: R\$ 41,34 60: R\$ 42,17  
1,6 cm



ANZOL BLACK CHINU N03 100X1  
Código: Fábrica: Unidade:  
**31009** MARINE CE/100  
F1 F4

UN: R\$ 0,40 AV: R\$ 39,93 15: R\$ 40,76  
30: R\$ 41,57 45: R\$ 42,40 60: R\$ 43,25  
1,7 cm



ANZOL BLACK CHINU N04 100X1  
Código: Fábrica: Unidade:  
**31010** MARINE CE/100  
F1 F4

UN: R\$ 0,42 AV: R\$ 41,92 15: R\$ 42,80  
30: R\$ 43,65 45: R\$ 44,53 60: R\$ 45,42  
1,8 cm



ANZOL BLACK CHINU N05 100X1  
Código: Fábrica: Unidade:  
**31011** MARINE CE/100  
F1 F4

UN: R\$ 0,44 AV: R\$ 43,92 15: R\$ 44,83  
30: R\$ 45,73 45: R\$ 46,65 60: R\$ 47,58  
2 cm



ANZOL BLACK CHINU N06 100X1  
Código: Fábrica: Unidade:  
**31012** MARINE CE/100  
F1 F4

UN: R\$ 0,50 AV: R\$ 49,91 15: R\$ 50,95  
30: R\$ 51,97 45: R\$ 53,01 60: R\$ 54,07  
2,2 cm



ANZOL BLACK CHINU N07 100X1  
Código: Fábrica: Unidade:  
**31013** MARINE CE/100  
F1 F4

UN: R\$ 0,55 AV: R\$ 54,90 15: R\$ 56,05  
30: R\$ 57,17 45: R\$ 58,31 60: R\$ 59,48  
2,5 cm



ANZOL BLACK CHINU N08 100X1  
Código: Fábrica: Unidade:  
**31014** MARINE CE/100  
F4

UN: R\$ 0,60 AV: R\$ 59,89 15: R\$ 61,14  
30: R\$ 62,36 45: R\$ 63,61 60: R\$ 64,88  
3 cm



ANZOL BLACK CHINU N09 100X1  
Código: Fábrica: Unidade:  
**31015** MARINE CE/100  
F1 F4

UN: R\$ 2,70 AV: R\$ 269,56 15: R\$ 275,17  
30: R\$ 280,68 45: R\$ 286,29 60: R\$ 292,02



ANZOL GARATEIA N02 TREBLE HOOK 100X1  
Código: Fábrica: Unidade:  
**43509** MARINE CE/100  
F1 F4

UN: R\$ 2,50 AV: R\$ 249,59 15: R\$ 254,79  
30: R\$ 259,89 45: R\$ 265,08 60: R\$ 270,39

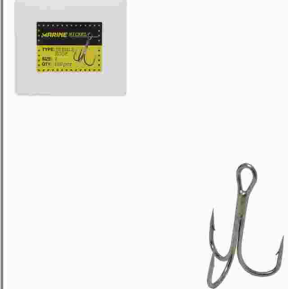

ANZOL GARATEIA N04 TREBLE HOOK 100X1  
Código: Fábrica: Unidade:  
**43510** MARINE CE/100  
F1 F4

UN: R\$ 2,50 AV: R\$ 249,59 15: R\$ 254,79  
30: R\$ 259,89 45: R\$ 265,08 60: R\$ 270,39



ANZOL GARATEIA N06 TREBLE HOOK 100X1

Código: Fábrica: Unidade:  
**43511** MARINE CE/100  
F1 F4

UN: R\$ 2,56 AV: R\$ 256,35 15: R\$ 261,69  
30: R\$ 266,92 45: R\$ 272,26 60: R\$ 277,71



ANZOL GARATEIA N10 TREBLE HOOK 100X1

Código: Fábrica: Unidade:  
**37697** MARINE CE/100  
F1 F4

UN: R\$ 2,30 AV: R\$ 229,62 15: R\$ 234,41  
30: R\$ 239,09 45: R\$ 243,88 60: R\$ 248,75



ANZOL GARATEIA N12 TREBLE HOOK 100X1

Código: Fábrica: Unidade:  
**37698** MARINE CE/100  
F1 F4

UN: R\$ 2,60 AV: R\$ 259,57 15: R\$ 264,98  
30: R\$ 270,28 45: R\$ 275,69 60: R\$ 281,20



ANZOL GARATEIA N18 TREBLE HOOK 100X1

Código: Fábrica: Unidade:  
**43507** MARINE CE/100  
F1 F4

UN: R\$ 0,33 AV: R\$ 32,94 15: R\$ 33,62  
30: R\$ 34,30 45: R\$ 34,98 60: R\$ 35,68

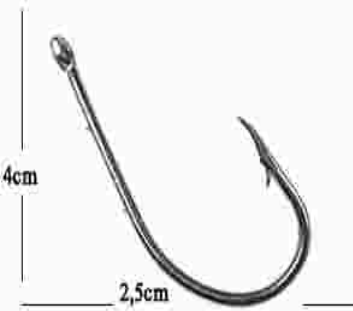

ANZOL PRATEADO N01 100X1

Código: Fábrica: Unidade:  
**10026** MARINE CE/100  
F4

UN: R\$ 0,31 AV: R\$ 30,94 15: R\$ 31,59  
30: R\$ 32,22 45: R\$ 32,86 60: R\$ 33,52



ANZOL PRATEADO N01/0 100X1

Código: Fábrica: Unidade:  
**30020** MARINE CE/100  
F4

UN: R\$ 0,25 AV: R\$ 24,95 15: R\$ 25,47  
30: R\$ 25,98 45: R\$ 26,50 60: R\$ 27,03



ANZOL PRATEADO N02 100X1

Código: Fábrica: Unidade:  
**10027** MARINE CE/100  
F4

UN: R\$ 0,40 AV: R\$ 39,93 15: R\$ 40,76  
30: R\$ 41,57 45: R\$ 42,40 60: R\$ 43,25



ANZOL PRATEADO N02/0 100X1

Código: Fábrica: Unidade:  
**30021** MARINE CE/100  
F4

UN: R\$ 0,50 AV: R\$ 49,91 15: R\$ 50,95  
30: R\$ 51,97 45: R\$ 53,01 60: R\$ 54,07



ANZOL PRATEADO N03/0 100X1

Código: Fábrica: Unidade:  
**30022** MARINE CE/100  
F4

UN: R\$ 0,26 AV: R\$ 25,95 15: R\$ 26,49  
30: R\$ 27,02 45: R\$ 27,56 60: R\$ 28,11



ANZOL PRATEADO N04 100X1

Código: Fábrica: Unidade:  
**10028** MARINE CE/100  
F4

UN: R\$ 0,53 AV: R\$ 53,17 15: R\$ 54,28  
30: R\$ 55,37 45: R\$ 56,48 60: R\$ 57,61



ANZOL PRATEADO N04/0 100X1

Código: Fábrica: Unidade:  
**30023** MARINE CE/100  
F4

UN: R\$ 0,26 AV: R\$ 25,95 15: R\$ 26,49  
30: R\$ 27,02 45: R\$ 27,56 60: R\$ 28,11



ANZOL PRATEADO N06 100X1

Código: Fábrica: Unidade:  
**10029** MARINE CE/100  
F4

UN: R\$ 0,26 AV: R\$ 25,95 15: R\$ 26,49  
30: R\$ 27,02 45: R\$ 27,56 60: R\$ 28,11



ANZOL PRATEADO N08 100X1

Código: Fábrica: Unidade:  
**10030** MARINE CE/100  
F4

UN: R\$ 0,26 AV: R\$ 25,95 15: R\$ 26,49  
30: R\$ 27,02 45: R\$ 27,56 60: R\$ 28,11

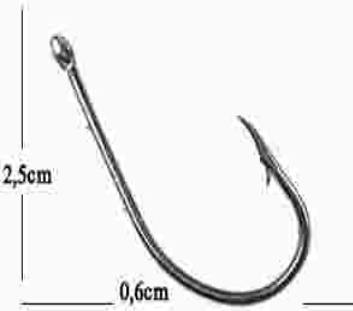

ANZOL PRATEADO N10 100X1

Código: Fábrica: Unidade:  
**8865** MARINE CE/100  
F1 F4

UN: R\$ 0,26 AV: R\$ 25,95 15: R\$ 26,49  
30: R\$ 27,02 45: R\$ 27,56 60: R\$ 28,11



ANZOL PRATEADO N12 100X1

Código: Fábrica: Unidade:  
**9488** MARINE CE/100  
F4

UN: R\$ 0,26 AV: R\$ 25,95 15: R\$ 26,49  
30: R\$ 27,02 45: R\$ 27,56 60: R\$ 28,11



ANZOL PRATEADO N14 100X1

Código: Fábrica: Unidade:  
**8866** MARINE CE/100  
F4

UN: R\$ 0,26 AV: R\$ 25,95 15: R\$ 26,49  
30: R\$ 27,02 45: R\$ 27,56 60: R\$ 28,11



ANZOL PRATEADO N16 100X1  
Código: 4240 Fábrica: MARINE Unidade: CE/100 F1 F4

UN: R\$ 0,25 AV: R\$ 19,96 15: R\$ 20,37  
30: R\$ 20,78 45: R\$ 21,20 60: R\$ 21,62



ANZOL PRATEADO N18 80X1  
Código: 48136 Fábrica: DJW Unidade: PT/80 F4

UN: R\$ 0,26 AV: R\$ 25,95 15: R\$ 26,49  
30: R\$ 27,02 45: R\$ 27,56 60: R\$ 28,11

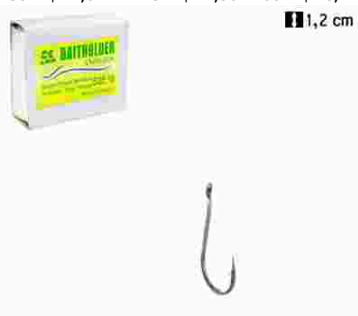

ANZOL PRATEADO N18 100X1  
Código: 31007 Fábrica: MARINE Unidade: CE/100 F4

UN: R\$ 0,24 AV: R\$ 23,95 15: R\$ 24,45  
30: R\$ 24,94 45: R\$ 25,44 60: R\$ 25,95



ANZOL PRATEADO N20 100X1  
Código: 13279 Fábrica: STRONG Unidade: CE/100 F4

UN: R\$ 0,30 AV: R\$ 23,95 15: R\$ 24,45  
30: R\$ 24,94 45: R\$ 25,44 60: R\$ 25,95



ANZOL PRATEADO N4/0 80X1  
Código: 48137 Fábrica: DJW Unidade: PT/80 F4

UN: R\$ 5,20 AV: R\$ 5,20 15: R\$ 5,31  
30: R\$ 5,42 45: R\$ 5,52 60: R\$ 5,64



APARADOR PLAST P/PORTA 10CM 7678 2X1  
Código: 47362 Fábrica: ALTIHOME Unidade: CR/1 F1 F4

UN: R\$ 5,39 AV: R\$ 5,39 15: R\$ 5,50  
30: R\$ 5,61 45: R\$ 5,73 60: R\$ 5,84

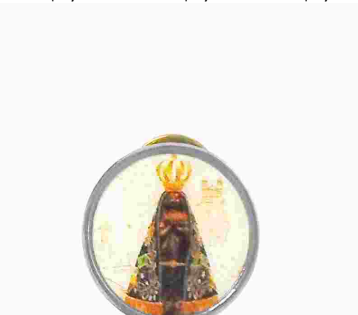

APLIQUE (BOTTON) METAL RELIGIOSO 9402  
Código: 35915 Fábrica: BAL Unidade: UN/1 F1 F4

UN: R\$ 3,48 AV: R\$ 3,48 15: R\$ 3,56  
30: R\$ 3,63 45: R\$ 3,70 60: R\$ 3,77



ARAME AMARRILHO COLOR 5MTS  
Código: 50865 Fábrica: NYBC Unidade: RL/1 F1 F4

UN: R\$ 6,98 AV: R\$ 6,98 15: R\$ 7,12  
30: R\$ 7,27 45: R\$ 7,41 60: R\$ 7,56



AREIA DECORATIVA AMARELO 750 GRS  
Código: 19941 Fábrica: NOVATROPICAL Unidade: PT/1 F1 F4

UN: R\$ 6,98 AV: R\$ 6,98 15: R\$ 7,12  
30: R\$ 7,27 45: R\$ 7,41 60: R\$ 7,56



AREIA DECORATIVA AZUL CLARO 750 GRS  
Código: 22883 Fábrica: NOVATROPICAL Unidade: PT/1 F1 F4

UN: R\$ 6,98 AV: R\$ 6,98 15: R\$ 7,12  
30: R\$ 7,27 45: R\$ 7,41 60: R\$ 7,56



AREIA DECORATIVA AZUL ESCURO 750 GRS  
Código: 19940 Fábrica: NOVATROPICAL Unidade: PT/1 F1 F4

UN: R\$ 6,98 AV: R\$ 6,98 15: R\$ 7,12  
30: R\$ 7,27 45: R\$ 7,41 60: R\$ 7,56



AREIA DECORATIVA BRANCO 750 GRS  
Código: 19937 Fábrica: NOVATROPICAL Unidade: PT/1 F1 F4

UN: R\$ 6,98 AV: R\$ 6,98 15: R\$ 7,12  
30: R\$ 7,27 45: R\$ 7,41 60: R\$ 7,56



AREIA DECORATIVA CREME 750 GRS  
Código: 34737 Fábrica: NOVATROPICAL Unidade: PT/1 F1 F4

UN: R\$ 6,98 AV: R\$ 6,98 15: R\$ 7,12  
30: R\$ 7,27 45: R\$ 7,41 60: R\$ 7,56



AREIA DECORATIVA LARANJA ESC 750 GRS  
Código: 34739 Fábrica: NOVATROPICAL Unidade: PT/1 F1 F4

UN: R\$ 6,98 AV: R\$ 6,98 15: R\$ 7,12  
30: R\$ 7,27 45: R\$ 7,41 60: R\$ 7,56



AREIA DECORATIVA LARANJA 700 GRS  
Código: 20112 Fábrica: NOVATROPICAL Unidade: PT/1 F1 F4

UN: R\$ 6,98 AV: R\$ 6,98 15: R\$ 7,12  
30: R\$ 7,27 45: R\$ 7,41 60: R\$ 7,56



AREIA DECORATIVA LILAS 750 GRS  
Código: 22093 Fábrica: NOVATROPICAL Unidade: PT/1 F1 F4

UN: R\$ 6,98 AV: R\$ 6,98 15: R\$ 7,12  
30: R\$ 7,27 45: R\$ 7,41 60: R\$ 7,56



AREIA DECORATIVA MISTA 750 GRS

Código: **22884** Fábrica: **NOVATROPICAL** Unidade: **PT/1 F1 F4**

UN: R\$ 6,98 AV: R\$ 6,98 15: R\$ 7,12  
30: R\$ 7,27 45: R\$ 7,41 60: R\$ 7,56



AREIA DECORATIVA OCRE 750 GRS

Código: **34738** Fábrica: **NOVATROPICAL** Unidade: **PT/1 F1 F4**

UN: R\$ 6,98 AV: R\$ 6,98 15: R\$ 7,12  
30: R\$ 7,27 45: R\$ 7,41 60: R\$ 7,56



AREIA DECORATIVA PRETA 700 GRS

Código: **22886** Fábrica: **NOVATROPICAL** Unidade: **PT/1 F1 F4**

UN: R\$ 6,35 AV: R\$ 6,35 15: R\$ 6,48  
30: R\$ 6,61 45: R\$ 6,74 60: R\$ 6,88



AREIA DECORATIVA PRETO 750 GRS

Código: **34747** Fábrica: **NOVATROPICAL** Unidade: **PT/1 F1 F4**

UN: R\$ 6,98 AV: R\$ 6,98 15: R\$ 7,12  
30: R\$ 7,27 45: R\$ 7,41 60: R\$ 7,56



AREIA DECORATIVA ROSA 750 GRS

Código: **19938** Fábrica: **NOVATROPICAL** Unidade: **PT/1 F1 F4**

UN: R\$ 6,98 AV: R\$ 6,98 15: R\$ 7,12  
30: R\$ 7,27 45: R\$ 7,41 60: R\$ 7,56



AREIA DECORATIVA VERDE CLARO 750 GRS

Código: **34741** Fábrica: **NOVATROPICAL** Unidade: **PT/1 F1 F4**

UN: R\$ 6,98 AV: R\$ 6,98 15: R\$ 7,12  
30: R\$ 7,27 45: R\$ 7,41 60: R\$ 7,56



AREIA DECORATIVA VERDE ESCURO 750 GRS

Código: **19921** Fábrica: **NOVATROPICAL** Unidade: **PT/1 F1 F4**

UN: R\$ 6,98 AV: R\$ 6,98 15: R\$ 7,12  
30: R\$ 7,27 45: R\$ 7,41 60: R\$ 7,56



AREIA DECORATIVA VERMELHO 750 GRS

Código: **19939** Fábrica: **NOVATROPICAL** Unidade: **PT/1 F1 F4**

UN: R\$ 109,81 AV: R\$ 109,81 15: R\$ 112,10  
30: R\$ 114,34 45: R\$ 116,63 60: R\$ 118,96



ARGILA EXPANDIDA N2 50LTS APROX 18KG

Código: **34594** Fábrica: **NOVATROPICAL** Unidade: **PT/1 F1 F4**

UN: R\$ 5,64 AV: R\$ 5,64 15: R\$ 5,76  
30: R\$ 5,87 45: R\$ 5,99 60: R\$ 6,11



ARGILA EXPANDIDA 500 GRS

Código: **45934** Fábrica: **NOVATROPICAL** Unidade: **PT/1 F1 F4**

UN: R\$ 7,98 AV: R\$ 7,98 15: R\$ 8,14  
30: R\$ 8,31 45: R\$ 8,47 60: R\$ 8,64



ARGILA MACIA 1 L

Código: **22664** Fábrica: **NOVATROPICAL** Unidade: **PT/1 F1 F4**

UN: R\$ 1,90 AV: R\$ 1,90 15: R\$ 1,94  
30: R\$ 1,98 45: R\$ 2,01 60: R\$ 2,06



ARGOLA C/CORRENTE P/CHAVEIRO 10UN

Código: **44721** Fábrica: **BBA** Unidade: **PT/1 F1 F4**

UN: R\$ 0,12 AV: R\$ 11,97 15: R\$ 12,22  
30: R\$ 12,46 45: R\$ 12,71 60: R\$ 12,97



ARGOLA CHAVEIRO N20 OURO C/CORRENT 100X1

Código: **50048** Fábrica: **NYBC** Unidade: **PT/100 F1 F4**

UN: R\$ 0,20 AV: R\$ 19,96 15: R\$ 20,37  
30: R\$ 20,78 45: R\$ 21,20 60: R\$ 21,62



ARGOLA CHAVEIRO N24 PRATA 100X1

Código: **50047** Fábrica: **NYBC** Unidade: **PT/100 F1 F4**

UN: R\$ 0,10 AV: R\$ 9,97 15: R\$ 10,18  
30: R\$ 10,39 45: R\$ 10,59 60: R\$ 10,81



ARGOLA CHAVEIRO 1/2 VOLTA 100X1

Código: **44335** Fábrica: **PLASTCIA** Unidade: **CE/100 F1 F4**

UN: R\$ 0,13 AV: R\$ 12,97 15: R\$ 13,24  
30: R\$ 13,50 45: R\$ 13,77 60: R\$ 14,05



ARGOLA CHAVEIRO 2 VOLTAS 100X1

Código: **44340** Fábrica: **PLASTCIA** Unidade: **CE/100 F1 F4**

UN: R\$ 0,19 AV: R\$ 18,96 15: R\$ 19,35  
30: R\$ 19,74 45: R\$ 20,14 60: R\$ 20,54



ARGOLA CHAVEIRO 20 MM C/CORRENTE 100X1  
Código: 51110 Fábrica: PLASTEC Unidade: PT/100  
F1 F4

UN: R\$ 0,30 AV: R\$ 30,45 15: R\$ 31,09  
30: R\$ 31,71 45: R\$ 32,34 60: R\$ 32,99



ARGOLA CHAVEIRO 25 MM C/CORRENTE 100X1  
Código: 50184 Fábrica: PLASTEC Unidade: PT/100  
F1 F4

UN: R\$ 3,10 AV: R\$ 3,10 15: R\$ 3,16  
30: R\$ 3,22 45: R\$ 3,29 60: R\$ 3,35



BACIA PLAST MANICURE 439  
Código: 40339 Fábrica: ARES PLAST Unidade: UN/1  
F1 F4

UN: R\$ 4,64 AV: R\$ 4,64 15: R\$ 4,79  
30: R\$ 4,94 45: R\$ 5,08 60: R\$ 5,24



BALANCA ANALOGICA DE FEIRA 0 A 5 KG 412  
Código: 29204 Fábrica: YING FA Unidade: CX/1  
F1 F4

UN: R\$ 19,99 AV: R\$ 19,99 15: R\$ 19,99  
30: R\$ 19,99 45: R\$ 19,99 60: R\$ 19,99



BALANCA DIG COZINHA PILHA 1 A 10KG 0012  
Código: 30466 Fábrica: GP6 Unidade: CX/1  
F1 F4

UN: R\$ 42,92 AV: R\$ 42,92 15: R\$ 43,82  
30: R\$ 44,69 45: R\$ 45,59 60: R\$ 46,50

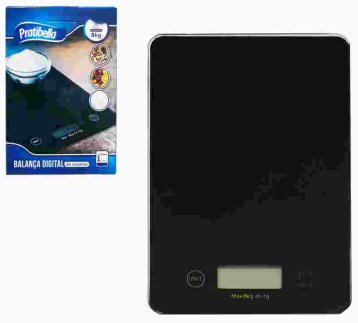

BALANCA DIGITAL COZINHA 1G A 8KG 023  
Código: 49438 Fábrica: PRATIBELLA Unidade: UN/1  
F1 F4

UN: R\$ 67,14 AV: R\$ 67,14 15: R\$ 68,54  
30: R\$ 69,91 45: R\$ 71,31 60: R\$ 72,74



BALANCA DIGITAL QUADR BATERIA 0A180 KG  
Código: 33044 Fábrica: RIOHOME Unidade: UN/1  
F1 F4

UN: R\$ 46,75 AV: R\$ 46,75 15: R\$ 47,72  
30: R\$ 48,67 45: R\$ 49,65 60: R\$ 50,64



BALANCA PRECISAO 12CM 0,1GR A 500GR 1052  
Código: 8723 Fábrica: WINMAX Unidade: CX/1  
F1 F4

UN: R\$ 0,48 AV: R\$ 11,97 15: R\$ 12,22  
30: R\$ 12,46 45: R\$ 12,71 60: R\$ 12,97



BALAO 5,0 ALUMINIO BRONZE 25X1  
Código: 44755 Fábrica: HAPPYDAY Unidade: PT/25  
F1 F4

UN: R\$ 0,48 AV: R\$ 11,97 15: R\$ 12,22  
30: R\$ 12,46 45: R\$ 12,71 60: R\$ 12,97



BALAO 5,0 ALUMINIO DOURADO 25X1  
Código: 44756 Fábrica: HAPPYDAY Unidade: PT/25  
F1 F4

UN: R\$ 0,48 AV: R\$ 11,97 15: R\$ 12,22  
30: R\$ 12,46 45: R\$ 12,71 60: R\$ 12,97



BALAO 5,0 ALUMINIO NATURAL 25X1  
Código: 44757 Fábrica: HAPPYDAY Unidade: PT/25  
F1 F4

UN: R\$ 0,24 AV: R\$ 11,97 15: R\$ 12,22  
30: R\$ 12,46 45: R\$ 12,71 60: R\$ 12,97



BALAO 5,0 RED LISO SORTIDO 50X1  
Código: 41837 Fábrica: HAPPYDAY Unidade: PT/50  
F1 F4

UN: R\$ 0,38 AV: R\$ 11,38 15: R\$ 11,62  
30: R\$ 11,85 45: R\$ 12,09 60: R\$ 12,33



BALAO 6,0 CORACAO LISO ROSA 30X1  
Código: 39191 Fábrica: HAPPY DAY Unidade: PT/30  
F1 F4

UN: R\$ 0,38 AV: R\$ 11,38 15: R\$ 11,62  
30: R\$ 11,85 45: R\$ 12,09 60: R\$ 12,33



BALAO 6,0 CORACAO LISO VERMELHO 30X1  
Código: 39192 Fábrica: HAPPY DAY Unidade: PT/30  
F1 F4

UN: R\$ 0,16 AV: R\$ 3,15 15: R\$ 3,21  
30: R\$ 3,27 45: R\$ 3,34 60: R\$ 3,41



BALAO 6,5 PERA LISO AMARELO 20X1  
Código: 36546 Fábrica: FOLIA Unidade: PT/20  
F1 F4

UN: R\$ 0,14 AV: R\$ 6,98 15: R\$ 7,12  
30: R\$ 7,27 45: R\$ 7,41 60: R\$ 7,56



BALAO 6,5 PERA LISO AMARELO 50X1  
Código: 4300 Fábrica: FOLIA Unidade: PT/50  
F1 F4

UN: R\$ 0,16 AV: R\$ 3,15 15: R\$ 3,21  
30: R\$ 3,27 45: R\$ 3,34 60: R\$ 3,41



BALAO 6,5 PERA LISO AZUL CLARO 20X1  
Código: 37375 Fábrica: FOLIA Unidade: PT/20 F1 F4

UN: R\$ 0,14 AV: R\$ 6,98 15: R\$ 7,12  
30: R\$ 7,27 45: R\$ 7,41 60: R\$ 7,56



BALAO 6,5 PERA LISO AZUL CLARO 50X1  
Código: 39551 Fábrica: FOLIA Unidade: PT/50 F1 F4

UN: R\$ 0,16 AV: R\$ 3,15 15: R\$ 3,21  
30: R\$ 3,27 45: R\$ 3,34 60: R\$ 3,41



BALAO 6,5 PERA LISO AZUL 20X1  
Código: 36545 Fábrica: FOLIA Unidade: PT/20 F1 F4

UN: R\$ 0,14 AV: R\$ 6,98 15: R\$ 7,12  
30: R\$ 7,27 45: R\$ 7,41 60: R\$ 7,56



BALAO 6,5 PERA LISO AZUL 50X1  
Código: 8726 Fábrica: FOLIA Unidade: PT/50 F1 F4

UN: R\$ 0,16 AV: R\$ 3,15 15: R\$ 3,21  
30: R\$ 3,27 45: R\$ 3,34 60: R\$ 3,41



BALAO 6,5 PERA LISO BRANCO 20X1  
Código: 36547 Fábrica: FOLIA Unidade: PT/20 F1 F4

UN: R\$ 0,14 AV: R\$ 6,98 15: R\$ 7,12  
30: R\$ 7,27 45: R\$ 7,41 60: R\$ 7,56



BALAO 6,5 PERA LISO BRANCO 50X1  
Código: 36541 Fábrica: FOLIA Unidade: PT/50 F1 F4

UN: R\$ 0,16 AV: R\$ 3,15 15: R\$ 3,21  
30: R\$ 3,27 45: R\$ 3,34 60: R\$ 3,41



BALAO 6,5 PERA LISO LARANJA 20X1  
Código: 36551 Fábrica: FOLIA Unidade: PT/20 F1 F4

UN: R\$ 0,14 AV: R\$ 6,98 15: R\$ 7,12  
30: R\$ 7,27 45: R\$ 7,41 60: R\$ 7,56



BALAO 6,5 PERA LISO LARANJA 50X1  
Código: 8729 Fábrica: FOLIA Unidade: PT/50 F1 F4

UN: R\$ 0,16 AV: R\$ 3,15 15: R\$ 3,21  
30: R\$ 3,27 45: R\$ 3,34 60: R\$ 3,41



BALAO 6,5 PERA LISO LILAS 20X1  
Código: 36554 Fábrica: FOLIA Unidade: PT/20 F1 F4

UN: R\$ 0,10 AV: R\$ 3,15 15: R\$ 3,21  
30: R\$ 3,27 45: R\$ 3,34 60: R\$ 3,41



BALAO 6,5 PERA LISO PRETO 20X1  
Código: 36550 Fábrica: FOLIA Unidade: PT/30 F1 F4

UN: R\$ 0,14 AV: R\$ 6,98 15: R\$ 7,12  
30: R\$ 7,27 45: R\$ 7,41 60: R\$ 7,56



BALAO 6,5 PERA LISO PRETO 50X1  
Código: 36543 Fábrica: FOLIA Unidade: PT/50 F1 F4

UN: R\$ 0,16 AV: R\$ 3,15 15: R\$ 3,21  
30: R\$ 3,27 45: R\$ 3,34 60: R\$ 3,41



BALAO 6,5 PERA LISO ROSA 20X1  
Código: 36548 Fábrica: FOLIA Unidade: PT/20 F1 F4

UN: R\$ 0,14 AV: R\$ 6,98 15: R\$ 7,12  
30: R\$ 7,27 45: R\$ 7,41 60: R\$ 7,56



BALAO 6,5 PERA LISO ROSA 50X1  
Código: 8731 Fábrica: FOLIA Unidade: PT/50 F1 F4

UN: R\$ 0,16 AV: R\$ 3,15 15: R\$ 3,21  
30: R\$ 3,27 45: R\$ 3,34 60: R\$ 3,41



BALAO 6,5 PERA LISO SORTIDO 20X1  
Código: 36553 Fábrica: FOLIA Unidade: PT/20 F1 F4

UN: R\$ 0,16 AV: R\$ 3,15 15: R\$ 3,21  
30: R\$ 3,27 45: R\$ 3,34 60: R\$ 3,41



BALAO 6,5 PERA LISO VERDE BANDEIRA 20X1  
Código: 36549 Fábrica: FOLIA Unidade: PT/20 F1 F4

UN: R\$ 0,14 AV: R\$ 6,98 15: R\$ 7,12  
30: R\$ 7,27 45: R\$ 7,41 60: R\$ 7,56



BALAO 6,5 PERA LISO VERDE BANDEIRA 50X1  
Código: 36542 Fábrica: FOLIA Unidade: PT/50 F1 F4

UN: R\$ 0,16 AV: R\$ 3,15 15: R\$ 3,21  
30: R\$ 3,27 45: R\$ 3,34 60: R\$ 3,41



BALAO 6,5 PERA LISO VERMELHO 20X1  
Código: 36552 Fábrica: FOLIA Unidade: PT/20  
F1 F4

UN: R\$ 0,14 AV: R\$ 6,98 15: R\$ 7,12  
30: R\$ 7,27 45: R\$ 7,41 60: R\$ 7,56



BALAO 6,5 PERA LISO VERMELHO 50X1  
Código: 8735 Fábrica: FOLIA Unidade: PT/50  
F1 F4

UN: R\$ 0,36 AV: R\$ 17,96 15: R\$ 18,34  
30: R\$ 18,70 45: R\$ 19,08 60: R\$ 19,46



BALAO 7,0 LISO DOURADO 50X1  
Código: 43720 Fábrica: FOLIA Unidade: PT/50  
F1 F4

UN: R\$ 0,15 AV: R\$ 7,28 15: R\$ 7,43  
30: R\$ 7,58 45: R\$ 7,73 60: R\$ 7,88



BALAO 7,0 PERA LISO AMARELO 50X1  
Código: 41006 Fábrica: FOLIA Unidade: PT/50  
F1 F4

UN: R\$ 0,15 AV: R\$ 7,28 15: R\$ 7,43  
30: R\$ 7,58 45: R\$ 7,73 60: R\$ 7,88

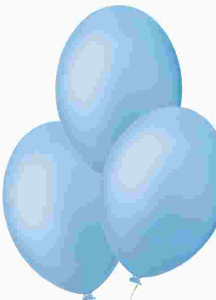

BALAO 7,0 PERA LISO AZUL CLARO 50X1  
Código: 41003 Fábrica: FOLIA Unidade: PT/50  
F1 F4

UN: R\$ 0,15 AV: R\$ 7,28 15: R\$ 7,43  
30: R\$ 7,58 45: R\$ 7,73 60: R\$ 7,88



BALAO 7,0 PERA LISO AZUL ESCURO 50X1  
Código: 41005 Fábrica: FOLIA Unidade: PT/50  
F1 F4

UN: R\$ 0,15 AV: R\$ 7,28 15: R\$ 7,43  
30: R\$ 7,58 45: R\$ 7,73 60: R\$ 7,88



BALAO 7,0 PERA LISO BRANCO 50X1  
Código: 40734 Fábrica: FOLIA Unidade: PT/50  
F1 F4

UN: R\$ 0,22 AV: R\$ 10,97 15: R\$ 11,20  
30: R\$ 11,43 45: R\$ 11,65 60: R\$ 11,89



BALAO 7,0 PERA LISO FELIZ ANI SORT 50X1  
Código: 32776 Fábrica: FOLIA Unidade: PT/50  
F1 F4

UN: R\$ 0,15 AV: R\$ 7,28 15: R\$ 7,43  
30: R\$ 7,58 45: R\$ 7,73 60: R\$ 7,88



BALAO 7,0 PERA LISO LARANJA 50X1  
Código: 41008 Fábrica: FOLIA Unidade: PT/50  
F1 F4

UN: R\$ 0,15 AV: R\$ 7,28 15: R\$ 7,43  
30: R\$ 7,58 45: R\$ 7,73 60: R\$ 7,88

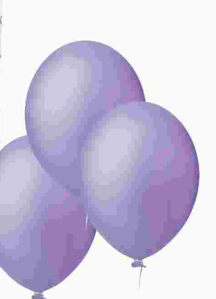

BALAO 7,0 PERA LISO LILAS 50X1  
Código: 40735 Fábrica: FOLIA Unidade: PT/50  
F1 F4

UN: R\$ 0,15 AV: R\$ 7,28 15: R\$ 7,43  
30: R\$ 7,58 45: R\$ 7,73 60: R\$ 7,88



BALAO 7,0 PERA LISO PINK 50X1  
Código: 41001 Fábrica: FOLIA Unidade: PT/50  
F1 F4

UN: R\$ 0,15 AV: R\$ 7,28 15: R\$ 7,43  
30: R\$ 7,58 45: R\$ 7,73 60: R\$ 7,88



BALAO 7,0 PERA LISO PRETO 50X1  
Código: 41004 Fábrica: FOLIA Unidade: PT/50  
F1 F4

UN: R\$ 0,15 AV: R\$ 7,28 15: R\$ 7,43  
30: R\$ 7,58 45: R\$ 7,73 60: R\$ 7,88



BALAO 7,0 PERA LISO ROSA 50X1  
Código: 41002 Fábrica: FOLIA Unidade: PT/50  
F1 F4

UN: R\$ 0,14 AV: R\$ 6,98 15: R\$ 7,12  
30: R\$ 7,27 45: R\$ 7,41 60: R\$ 7,56



BALAO 7,0 PERA LISO SORTIDO 50X1  
Código: 45274 Fábrica: FOLIA Unidade: PT/50  
F1 F4

UN: R\$ 0,15 AV: R\$ 7,28 15: R\$ 7,43  
30: R\$ 7,58 45: R\$ 7,73 60: R\$ 7,88



BALAO 7,0 PERA LISO VERDE BANDEIRA 50X1  
Código: 40736 Fábrica: FOLIA Unidade: PT/50  
F1 F4

UN: R\$ 0,15 AV: R\$ 7,28 15: R\$ 7,43  
30: R\$ 7,58 45: R\$ 7,73 60: R\$ 7,88



BALAO 7,0 PERA LISO VERMELHO 50X1  
Código: 41007 Fábrica: FOLIA Unidade: PT/50  
F1 F4

UN: R\$ 0,30 AV: R\$ 14,97 15: R\$ 15,28  
30: R\$ 15,58 45: R\$ 15,90 60: R\$ 16,21

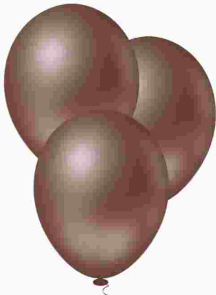

BALAO 8,0 LISO RED MARROM 50X1  
Código: Fábrika: Unidade:  
**29267** PIC PIC PT/50  
F1 F4

UN: R\$ 0,30 AV: R\$ 14,97 15: R\$ 15,28  
30: R\$ 15,58 45: R\$ 15,90 60: R\$ 16,21



BALAO 8,0 PERA LISO AMARELO OCRE 50X1  
Código: Fábrika: Unidade:  
**42367** HAPPY DAY PT/50  
F1 F4

UN: R\$ 0,30 AV: R\$ 14,97 15: R\$ 15,28  
30: R\$ 15,58 45: R\$ 15,90 60: R\$ 16,21



BALAO 8,0 PERA LISO AMARELO 50X1  
Código: Fábrika: Unidade:  
**42362** HAPPY DAY PT/50  
F1 F4

UN: R\$ 0,30 AV: R\$ 14,97 15: R\$ 15,28  
30: R\$ 15,58 45: R\$ 15,90 60: R\$ 16,21



BALAO 8,0 PERA LISO AZUL CELESTE 50X1  
Código: Fábrika: Unidade:  
**42371** HAPPY DAY PT/50  
F1 F4

UN: R\$ 0,30 AV: R\$ 14,97 15: R\$ 15,28  
30: R\$ 15,58 45: R\$ 15,90 60: R\$ 16,21



BALAO 8,0 PERA LISO AZUL CLA CANDY 50X1  
Código: Fábrika: Unidade:  
**42369** HAPPY DAY PT/50  
F1 F4

UN: R\$ 0,30 AV: R\$ 14,97 15: R\$ 15,28  
30: R\$ 15,58 45: R\$ 15,90 60: R\$ 16,21



BALAO 8,0 PERA LISO AZUL TIFANNY 50X1  
Código: Fábrika: Unidade:  
**42368** HAPPY DAY PT/50  
F1 F4

UN: R\$ 0,30 AV: R\$ 14,97 15: R\$ 15,28  
30: R\$ 15,58 45: R\$ 15,90 60: R\$ 16,21



BALAO 8,0 PERA LISO AZUL 50X1  
Código: Fábrika: Unidade:  
**42361** HAPPY DAY PT/50  
F1 F4

UN: R\$ 0,30 AV: R\$ 14,97 15: R\$ 15,28  
30: R\$ 15,58 45: R\$ 15,90 60: R\$ 16,21



BALAO 8,0 PERA LISO BEGE CANDY 50X1  
Código: Fábrika: Unidade:  
**42377** HAPPY DAY PT/50  
F1 F4

UN: R\$ 0,30 AV: R\$ 14,97 15: R\$ 15,28  
30: R\$ 15,58 45: R\$ 15,90 60: R\$ 16,21



BALAO 8,0 PERA LISO BRANCO 50X1  
Código: Fábrika: Unidade:  
**42378** HAPPY DAY PT/50  
F1 F4

UN: R\$ 0,30 AV: R\$ 14,97 15: R\$ 15,28  
30: R\$ 15,58 45: R\$ 15,90 60: R\$ 16,21

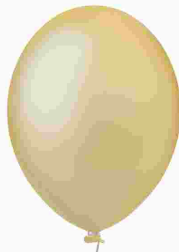

BALAO 8,0 PERA LISO CHAMPAGNE 50X1  
Código: Fábrika: Unidade:  
**42354** HAPPY DAY PT/50  
F1 F4

UN: R\$ 0,30 AV: R\$ 14,97 15: R\$ 15,28  
30: R\$ 15,58 45: R\$ 15,90 60: R\$ 16,21



BALAO 8,0 PERA LISO CORAL 50X1  
Código: Fábrika: Unidade:  
**42357** HAPPY DAY PT/50  
F1 F4

UN: R\$ 0,30 AV: R\$ 14,97 15: R\$ 15,28  
30: R\$ 15,58 45: R\$ 15,90 60: R\$ 16,21



BALAO 8,0 PERA LISO FUCSIA 50X1  
Código: Fábrika: Unidade:  
**42359** HAPPY DAY PT/50  
F1 F4

UN: R\$ 0,30 AV: R\$ 14,97 15: R\$ 15,28  
30: R\$ 15,58 45: R\$ 15,90 60: R\$ 16,21



BALAO 8,0 PERA LISO LARANJA 50X1  
Código: Fábrika: Unidade:  
**42374** HAPPY DAY PT/50  
F1 F4

UN: R\$ 0,29 AV: R\$ 14,48 15: R\$ 14,78  
30: R\$ 15,07 45: R\$ 15,38 60: R\$ 15,68



BALAO 8,0 PERA LISO LILAS CANDY 50X1  
Código: Fábrika: Unidade:  
**42360** HAPPY DAY PT/50  
F1 F4

UN: R\$ 0,30 AV: R\$ 14,97 15: R\$ 15,28  
30: R\$ 15,58 45: R\$ 15,90 60: R\$ 16,21



BALAO 8,0 PERA LISO MARFIM CANDY 50X1  
Código: Fábrika: Unidade:  
**42363** HAPPY DAY PT/50  
F1 F4

UN: R\$ 0,30 AV: R\$ 14,97 15: R\$ 15,28  
30: R\$ 15,58 45: R\$ 15,90 60: R\$ 16,21



BALAO 8,0 PERA LISO MARROM 50X1  
Código: Fábrika: Unidade:  
**42376** HAPPY DAY PT/50  
F1 F4

UN: R\$ 0,30 AV: R\$ 14,97 15: R\$ 15,28  
30: R\$ 15,58 45: R\$ 15,90 60: R\$ 16,21



BALAO 8,0 PERA LISO MARSALA 50X1  
Código: Fábrika: Unidade:  
**42379** HAPPY DAY PT/50  
F1 F4

UN: R\$ 0,30 AV: R\$ 14,97 15: R\$ 15,28  
30: R\$ 15,58 45: R\$ 15,90 60: R\$ 16,21



BALAO 8,0 PERA LISO PRETO 50X1  
Código: Fábrika: Unidade:  
**42366** HAPPY DAY PT/50  
F1 F4

UN: R\$ 0,30 AV: R\$ 14,97 15: R\$ 15,28  
30: R\$ 15,58 45: R\$ 15,90 60: R\$ 16,21



BALAO 8,0 PERA LISO ROSA 50X1  
Código: Fábrika: Unidade:  
**42365** HAPPY DAY PT/50  
F1 F4

UN: R\$ 0,30 AV: R\$ 14,97 15: R\$ 15,28  
30: R\$ 15,58 45: R\$ 15,90 60: R\$ 16,21



BALAO 8,0 PERA LISO ROSA BB CANDY 50X1  
Código: Fábrika: Unidade:  
**42364** HAPPY DAY PT/50  
F1 F4

UN: R\$ 0,30 AV: R\$ 14,97 15: R\$ 15,28  
30: R\$ 15,58 45: R\$ 15,90 60: R\$ 16,21



BALAO 8,0 PERA LISO ROSA PINK 50X1  
Código: Fábrika: Unidade:  
**42373** HAPPY DAY PT/50  
F1 F4

UN: R\$ 0,30 AV: R\$ 14,97 15: R\$ 15,28  
30: R\$ 15,58 45: R\$ 15,90 60: R\$ 16,21



BALAO 8,0 PERA LISO SORTIDO 50X1  
Código: Fábrika: Unidade:  
**42380** HAPPY DAY PT/50  
F1 F4

UN: R\$ 0,30 AV: R\$ 14,97 15: R\$ 15,28  
30: R\$ 15,58 45: R\$ 15,90 60: R\$ 16,21



BALAO 8,0 PERA LISO TERRA COTA 50X1  
Código: Fábrika: Unidade:  
**42356** HAPPY DAY PT/50  
F1 F4

UN: R\$ 0,30 AV: R\$ 14,97 15: R\$ 15,28  
30: R\$ 15,58 45: R\$ 15,90 60: R\$ 16,21



BALAO 8,0 PERA LISO UVA 50X1  
Código: Fábrika: Unidade:  
**42355** HAPPY DAY PT/50  
F1 F4

UN: R\$ 0,30 AV: R\$ 14,97 15: R\$ 15,28  
30: R\$ 15,58 45: R\$ 15,90 60: R\$ 16,21



BALAO 8,0 PERA LISO VERDE AGUA 50X1  
Código: Fábrika: Unidade:  
**42353** HAPPY DAY PT/50  
F1 F4

UN: R\$ 0,30 AV: R\$ 14,97 15: R\$ 15,28  
30: R\$ 15,58 45: R\$ 15,90 60: R\$ 16,21

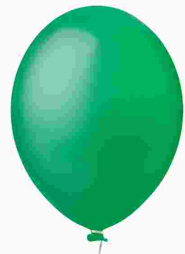

BALAO 8,0 PERA LISO VERDE BANDEIRA 50X1  
Código: Fábrika: Unidade:  
**42350** HAPPY DAY PT/50  
F1 F4

UN: R\$ 0,30 AV: R\$ 14,97 15: R\$ 15,28  
30: R\$ 15,58 45: R\$ 15,90 60: R\$ 16,21



BALAO 8,0 PERA LISO VERDE EUCALIPT 50X1  
Código: Fábrika: Unidade:  
**42349** HAPPY DAY PT/50  
F1 F4

UN: R\$ 0,30 AV: R\$ 14,97 15: R\$ 15,28  
30: R\$ 15,58 45: R\$ 15,90 60: R\$ 16,21

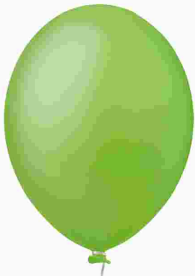

BALAO 8,0 PERA LISO VERDE LIMAO 50X1  
Código: Fábrika: Unidade:  
**42352** HAPPY DAY PT/50  
F1 F4

UN: R\$ 0,30 AV: R\$ 14,97 15: R\$ 15,28  
30: R\$ 15,58 45: R\$ 15,90 60: R\$ 16,21

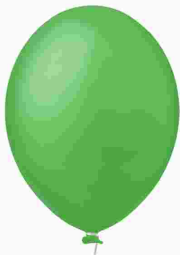

BALAO 8,0 PERA LISO VERDE 50X1  
Código: Fábrika: Unidade:  
**42351** HAPPY DAY PT/50  
F1 F4

UN: R\$ 0,30 AV: R\$ 14,97 15: R\$ 15,28  
30: R\$ 15,58 45: R\$ 15,90 60: R\$ 16,21



BALAO 8,0 PERA LISO VERMELHO 50X1  
Código: Fábrika: Unidade:  
**42372** HAPPY DAY PT/50  
F1 F4

UN: R\$ 0,30 AV: R\$ 14,97 15: R\$ 15,28  
30: R\$ 15,58 45: R\$ 15,90 60: R\$ 16,21



BALAO 8,0 PERA LISO VIOLETA 50X1  
Código: Fábrika: Unidade:  
**42370** HAPPY DAY PT/50  
F1 F4

UN: R\$ 0,40 AV: R\$ 9,97 15: R\$ 10,18  
30: R\$ 10,39 45: R\$ 10,59 60: R\$ 10,81

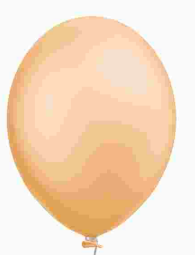

BALAO 8,0 PEROLIZADO OURO 25X1  
Código: Fábrika: Unidade:  
**44753** HAPPY DAY PT/25  
F1 F4

UN: R\$ 0,40 AV: R\$ 9,97 15: R\$ 10,18  
30: R\$ 10,39 45: R\$ 10,59 60: R\$ 10,81



BALAO 8,0 PEROLIZADO PRATA 25X1  
Código: Fábrika: Unidade:  
**44754** HAPPY DAY PT/25  
F1 F4

UN: R\$ 0,30 AV: R\$ 14,97 15: R\$ 15,28  
30: R\$ 15,58 45: R\$ 15,90 60: R\$ 16,21

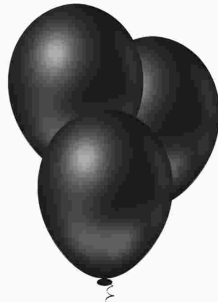

BALAO 8,0 RED LISO PRETO 50X1  
Código: Fábrika: Unidade:  
**50697** PICPIC PT/50  
F1 F4

UN: R\$ 0,34 AV: R\$ 16,96 15: R\$ 17,32  
30: R\$ 17,66 45: R\$ 18,02 60: R\$ 18,38



BALAO 9,0 PERA LISO VERDE 50X1  
Código: Fábrika: Unidade:  
**42835** HAPPY DAY PT/50  
F1 F4

UN: R\$ 0,78 AV: R\$ 19,62 15: R\$ 20,03  
30: R\$ 20,43 45: R\$ 20,84 60: R\$ 21,25

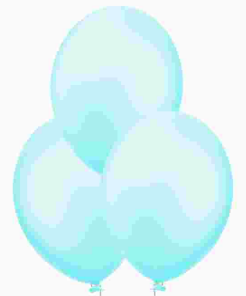

BALAO 9,0 PEROL CANDY AZUL CLARO 25X1  
Código: Fábrika: Unidade:  
**45918** HAPPY DAY PT/25  
F1 F4

UN: R\$ 0,78 AV: R\$ 19,62 15: R\$ 20,03  
30: R\$ 20,43 45: R\$ 20,84 60: R\$ 21,25



BALAO 9,0 PEROL CANDY BRANCO 25X1  
Código: Fábrika: Unidade:  
**45919** HAPPY DAY PT/25  
F1 F4

UN: R\$ 0,78 AV: R\$ 19,62 15: R\$ 20,03  
30: R\$ 20,43 45: R\$ 20,84 60: R\$ 21,25



BALAO 9,0 PEROL CANDY LILAS 25X1  
Código: Fábrika: Unidade:  
**45921** HAPPY DAY PT/25  
F1 F4

UN: R\$ 0,78 AV: R\$ 19,62 15: R\$ 20,03  
30: R\$ 20,43 45: R\$ 20,84 60: R\$ 21,25



BALAO 9,0 PEROL CANDY MARFIM 25X1  
Código: Fábrika: Unidade:  
**45920** HAPPY DAY PT/25  
F1 F4

UN: R\$ 0,78 AV: R\$ 19,62 15: R\$ 20,03  
30: R\$ 20,43 45: R\$ 20,84 60: R\$ 21,25



BALAO 9,0 PEROL CANDY OURO 25X1  
Código: Fábrika: Unidade:  
**45924** HAPPY DAY PT/25  
F1 F4

UN: R\$ 0,78 AV: R\$ 19,62 15: R\$ 20,03  
30: R\$ 20,43 45: R\$ 20,84 60: R\$ 21,25

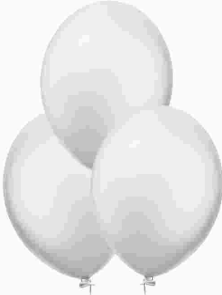

BALAO 9,0 PEROL CANDY PRATA 25X1  
Código: Fábrika: Unidade:  
**45925** HAPPY DAY PT/25  
F1 F4

UN: R\$ 0,78 AV: R\$ 19,62 15: R\$ 20,03  
30: R\$ 20,43 45: R\$ 20,84 60: R\$ 21,25



BALAO 9,0 PEROL CANDY ROSA BB 25X1  
Código: Fábrika: Unidade:  
**45922** HAPPY DAY PT/25  
F1 F4

UN: R\$ 0,78 AV: R\$ 19,62 15: R\$ 20,03  
30: R\$ 20,43 45: R\$ 20,84 60: R\$ 21,25



BALAO 9,0 PEROL CANDY SORT 25X1  
Código: Fábrika: Unidade:  
**45917** HAPPY DAY PT/25  
F1 F4

UN: R\$ 0,78 AV: R\$ 19,62 15: R\$ 20,03  
30: R\$ 20,43 45: R\$ 20,84 60: R\$ 21,25

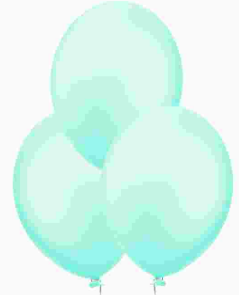

BALAO 9,0 PEROL CANDY VERDE AGUA 25X1  
Código: Fábrika: Unidade:  
**45923** HAPPY DAY PT/25  
F1 F4

UN: R\$ 1,04 AV: R\$ 25,95 15: R\$ 26,49  
30: R\$ 27,02 45: R\$ 27,56 60: R\$ 28,11



BALAO 9,0 RED ALUMINIO AMARELO MOS 25X1  
Código: Fábrika: Unidade:  
**38522** HAPPY DAY PT/25  
F1 F4

UN: R\$ 1,04 AV: R\$ 25,95 15: R\$ 26,49  
30: R\$ 27,02 45: R\$ 27,56 60: R\$ 28,11



BALAO 9,0 RED ALUMINIO AZUL MEIA N 25X1  
Código: Fábrika: Unidade:  
**38517** HAPPY DAY PT/25  
F1 F4

UN: R\$ 1,04 AV: R\$ 25,95 15: R\$ 26,49  
30: R\$ 27,02 45: R\$ 27,56 60: R\$ 28,11

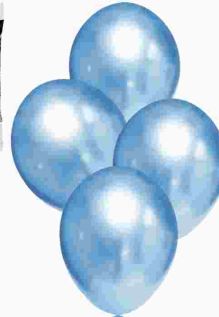

BALAO 9,0 RED ALUMINIO AZUL 25X1  
Código: Fábrika: Unidade:  
**37901** HAPPY DAY PT/25  
F1 F4

UN: R\$ 1,04 AV: R\$ 25,95 15: R\$ 26,49  
30: R\$ 27,02 45: R\$ 27,56 60: R\$ 28,11



BALAO 9,0 RED ALUMINIO BRONZE  
Código: Fábrika: Unidade:  
**37908** HAPPY DAY PT/25  
F1 F4

UN: R\$ 1,04 AV: R\$ 25,95 15: R\$ 26,49  
30: R\$ 27,02 45: R\$ 27,56 60: R\$ 28,11



BALAO 9,0 RED ALUMINIO DOURADO 25X1  
Código: 37909 Fábrica: HAPPY DAY Unidade: PT/25 F1 F4

UN: R\$ 1,04 AV: R\$ 25,95 15: R\$ 26,49  
30: R\$ 27,02 45: R\$ 27,56 60: R\$ 28,11



BALAO 9,0 RED ALUMINIO FUCSIA 25X1  
Código: 37906 Fábrica: HAPPY DAY Unidade: PT/25 F1 F4

UN: R\$ 1,04 AV: R\$ 25,95 15: R\$ 26,49  
30: R\$ 27,02 45: R\$ 27,56 60: R\$ 28,11



BALAO 9,0 RED ALUMINIO LILAS 25X1  
Código: 38518 Fábrica: HAPPY DAY Unidade: PT/25 F1 F4

UN: R\$ 1,04 AV: R\$ 25,95 15: R\$ 26,49  
30: R\$ 27,02 45: R\$ 27,56 60: R\$ 28,11

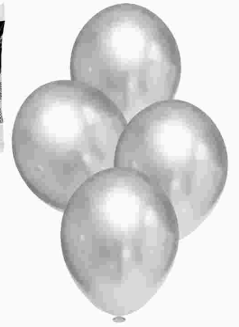

BALAO 9,0 RED ALUMINIO NATURAL 25X1  
Código: 37907 Fábrica: HAPPY DAY Unidade: PT/25 F1 F4

UN: R\$ 1,04 AV: R\$ 25,95 15: R\$ 26,49  
30: R\$ 27,02 45: R\$ 27,56 60: R\$ 28,11

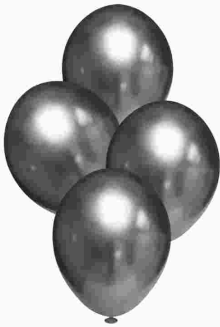

BALAO 9,0 RED ALUMINIO ONIX  
Código: 37913 Fábrica: HAPPY DAY Unidade: PT/25 F1 F4

UN: R\$ 1,04 AV: R\$ 25,95 15: R\$ 26,49  
30: R\$ 27,02 45: R\$ 27,56 60: R\$ 28,11



BALAO 9,0 RED ALUMINIO PINK 25X1  
Código: 37910 Fábrica: HAPPY DAY Unidade: PT/25 F1 F4

UN: R\$ 1,04 AV: R\$ 25,95 15: R\$ 26,49  
30: R\$ 27,02 45: R\$ 27,56 60: R\$ 28,11



BALAO 9,0 RED ALUMINIO PRATA 25X1  
Código: 50671 Fábrica: HAPPY DAY Unidade: PT/25 F1 F4

UN: R\$ 1,04 AV: R\$ 25,95 15: R\$ 26,49  
30: R\$ 27,02 45: R\$ 27,56 60: R\$ 28,11

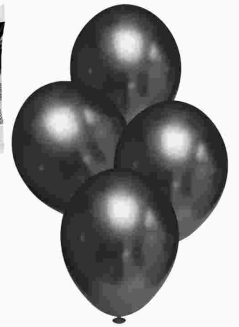

BALAO 9,0 RED ALUMINIO PRETO 25X1  
Código: 50670 Fábrica: HAPPY DAY Unidade: PT/25 F1 F4

UN: R\$ 1,04 AV: R\$ 25,95 15: R\$ 26,49  
30: R\$ 27,02 45: R\$ 27,56 60: R\$ 28,11

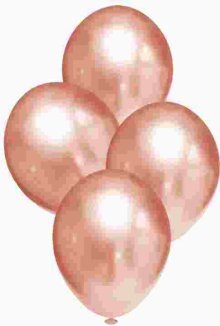

BALAO 9,0 RED ALUMINIO ROSE GOLD 25X1  
Código: 37914 Fábrica: HAPPY DAY Unidade: PT/25 F1 F4

UN: R\$ 1,04 AV: R\$ 25,95 15: R\$ 26,49  
30: R\$ 27,02 45: R\$ 27,56 60: R\$ 28,11



BALAO 9,0 RED ALUMINIO ROSE 25X1  
Código: 37905 Fábrica: HAPPY DAY Unidade: PT/25 F1 F4

UN: R\$ 1,04 AV: R\$ 25,95 15: R\$ 26,49  
30: R\$ 27,02 45: R\$ 27,56 60: R\$ 28,11



BALAO 9,0 RED ALUMINIO SORTIDO 25X1  
Código: 37902 Fábrica: HAPPY DAY Unidade: PT/25 F1 F4

UN: R\$ 1,04 AV: R\$ 25,95 15: R\$ 26,49  
30: R\$ 27,02 45: R\$ 27,56 60: R\$ 28,11



BALAO 9,0 RED ALUMINIO VERDE OCEAN 25X1  
Código: 38519 Fábrica: HAPPY DAY Unidade: PT/25 F1 F4

UN: R\$ 1,04 AV: R\$ 25,95 15: R\$ 26,49  
30: R\$ 27,02 45: R\$ 27,56 60: R\$ 28,11



BALAO 9,0 RED ALUMINIO VERDE 25X1  
Código: 37904 Fábrica: HAPPY DAY Unidade: PT/25 F1 F4

UN: R\$ 1,04 AV: R\$ 25,95 15: R\$ 26,49  
30: R\$ 27,02 45: R\$ 27,56 60: R\$ 28,11



BALAO 9,0 RED ALUMINIO VERMELHO 25X1  
Código: 37911 Fábrica: HAPPY DAY Unidade: PT/25 F1 F4

UN: R\$ 1,04 AV: R\$ 25,95 15: R\$ 26,49  
30: R\$ 27,02 45: R\$ 27,56 60: R\$ 28,11

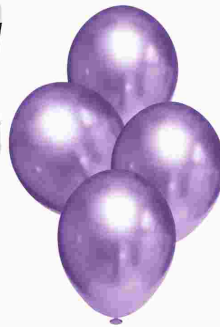

BALAO 9,0 RED ALUMINIO VIOLETA 25X1  
Código: 37903 Fábrica: HAPPY DAY Unidade: PT/25 F1 F4

UN: R\$ 0,32 AV: R\$ 15,96 15: R\$ 16,30  
30: R\$ 16,62 45: R\$ 16,96 60: R\$ 17,29

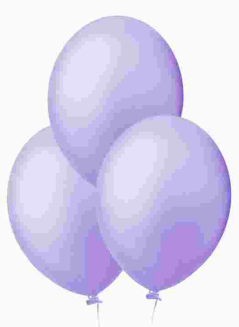

BALAO 9,0 RED LISO LILAS CANDY 50X1  
Código: 50111 Fábrica: HAPPY DAY Unidade: PT/50 F1 F4

UN: R\$ 0,32 AV: R\$ 15,96 15: R\$ 16,30  
30: R\$ 16,62 45: R\$ 16,96 60: R\$ 17,29



BALAO 9,0 RED LISO AMARELO  
Código: Fábrika: Unidade:  
**40621** HAPPY DAY PT/50  
F1 F4

UN: R\$ 0,32 AV: R\$ 15,96 15: R\$ 16,30  
30: R\$ 16,62 45: R\$ 16,96 60: R\$ 17,29

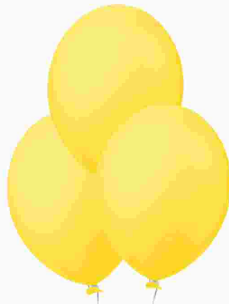

BALAO 9,0 RED LISO AMARELO 50X1  
Código: Fábrika: Unidade:  
**29280** FOLIA PT/50  
F1 F4

UN: R\$ 0,32 AV: R\$ 15,96 15: R\$ 16,30  
30: R\$ 16,62 45: R\$ 16,96 60: R\$ 17,29



BALAO 9,0 RED LISO AZUL  
Código: Fábrika: Unidade:  
**40622** HAPPY DAY PT/50  
F1 F4

UN: R\$ 0,32 AV: R\$ 15,96 15: R\$ 16,30  
30: R\$ 16,62 45: R\$ 16,96 60: R\$ 17,29



BALAO 9,0 RED LISO AZUL CLARO CAND 50X1  
Código: Fábrika: Unidade:  
**41013** HAPPY DAY PT/50  
F1 F4

UN: R\$ 0,32 AV: R\$ 15,96 15: R\$ 16,30  
30: R\$ 16,62 45: R\$ 16,96 60: R\$ 17,29

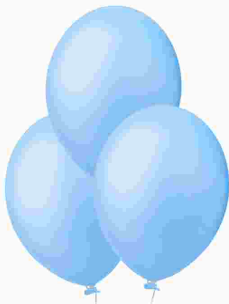

BALAO 9,0 RED LISO AZUL CLARO 50X1  
Código: Fábrika: Unidade:  
**31290** FOLIA PT/50  
F1 F4

UN: R\$ 0,32 AV: R\$ 15,96 15: R\$ 16,30  
30: R\$ 16,62 45: R\$ 16,96 60: R\$ 17,29

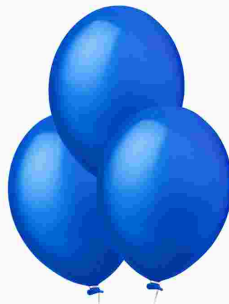

BALAO 9,0 RED LISO AZUL ESCURO 50X1  
Código: Fábrika: Unidade:  
**31289** FOLIA PT/50  
F1 F4

UN: R\$ 0,32 AV: R\$ 15,96 15: R\$ 16,30  
30: R\$ 16,62 45: R\$ 16,96 60: R\$ 17,29

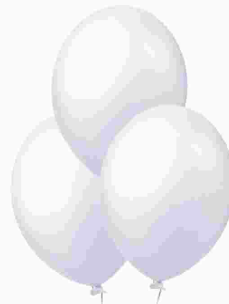

BALAO 9,0 RED LISO BRANCO 50X1  
Código: Fábrika: Unidade:  
**29285** FOLIA PT/50  
F1 F4

UN: R\$ 0,32 AV: R\$ 15,96 15: R\$ 16,30  
30: R\$ 16,62 45: R\$ 16,96 60: R\$ 17,29



BALAO 9,0 RED LISO BRANCO 50X1  
Código: Fábrika: Unidade:  
**41011** HAPPY DAY PT/50  
F1 F4

UN: R\$ 0,32 AV: R\$ 15,96 15: R\$ 16,30  
30: R\$ 16,62 45: R\$ 16,96 60: R\$ 17,29



BALAO 9,0 RED LISO LILAS 50X1  
Código: Fábrika: Unidade:  
**31291** FOLIA PT/50  
F1 F4

UN: R\$ 0,32 AV: R\$ 15,96 15: R\$ 16,30  
30: R\$ 16,62 45: R\$ 16,96 60: R\$ 17,29

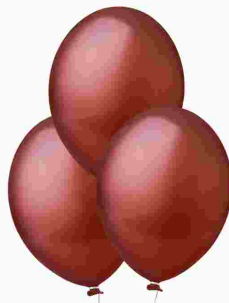

BALAO 9,0 RED LISO MARRON 50X1  
Código: Fábrika: Unidade:  
**29288** FOLIA PT/50  
F1 F4

UN: R\$ 0,32 AV: R\$ 15,96 15: R\$ 16,30  
30: R\$ 16,62 45: R\$ 16,96 60: R\$ 17,29



BALAO 9,0 RED LISO PRETO 50X1  
Código: Fábrika: Unidade:  
**29287** FOLIA PT/50  
F1 F4

UN: R\$ 0,32 AV: R\$ 15,96 15: R\$ 16,30  
30: R\$ 16,62 45: R\$ 16,96 60: R\$ 17,29



BALAO 9,0 RED LISO PRETO 50X1  
Código: Fábrika: Unidade:  
**40620** HAPPY DAY PT/50  
F1 F4

UN: R\$ 0,32 AV: R\$ 15,96 15: R\$ 16,30  
30: R\$ 16,62 45: R\$ 16,96 60: R\$ 17,29



BALAO 9,0 RED LISO ROSA 50X1  
Código: Fábrika: Unidade:  
**29281** FOLIA PT/50  
F1 F4

UN: R\$ 0,32 AV: R\$ 15,96 15: R\$ 16,30  
30: R\$ 16,62 45: R\$ 16,96 60: R\$ 17,29



BALAO 9,0 RED LISO SORTIDO 50X1  
Código: Fábrika: Unidade:  
**30033** FOLIA PT/50  
F1 F4

UN: R\$ 0,32 AV: R\$ 15,96 15: R\$ 16,30  
30: R\$ 16,62 45: R\$ 16,96 60: R\$ 17,29

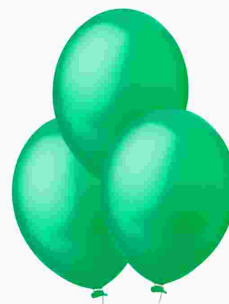

BALAO 9,0 RED LISO VERDE BANDEIRA 50X1  
Código: Fábrika: Unidade:  
**45916** FOLIA PT/50  
F1 F4

UN: R\$ 0,32 AV: R\$ 15,96 15: R\$ 16,30  
30: R\$ 16,62 45: R\$ 16,96 60: R\$ 17,29



BALAO 9,0 RED LISO VERDE ESCURO 50X1  
Código: Fábrika: Unidade:  
**29286** FOLIA PT/50  
F1 F4

UN: R\$ 0,32 AV: R\$ 15,96 15: R\$ 16,30  
30: R\$ 16,62 45: R\$ 16,96 60: R\$ 17,29



BALAO 9,0 RED LISO VERMELHO

Código: 31293 Fábrica: FOLIA Unidade: PT/50 F1 F4

UN: R\$ 0,50 AV: R\$ 14,97 15: R\$ 15,28  
30: R\$ 15,58 45: R\$ 15,90 60: R\$ 16,21



BALAO 9,0 RED NEON AMARELO 30X1

Código: 38521 Fábrica: HAPPY DAY Unidade: PT/30 F1 F4

UN: R\$ 0,60 AV: R\$ 14,97 15: R\$ 15,28  
30: R\$ 15,58 45: R\$ 15,90 60: R\$ 16,21

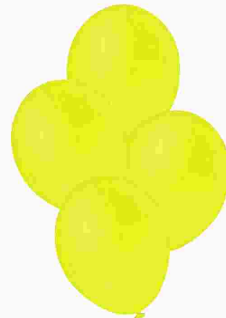

BALAO 9,0 RED NEON CITRUS AMARELO 25X1

Código: 46920 Fábrica: HAPPY DAY Unidade: PT/25 F1 F4

UN: R\$ 0,50 AV: R\$ 14,97 15: R\$ 15,28  
30: R\$ 15,58 45: R\$ 15,90 60: R\$ 16,21

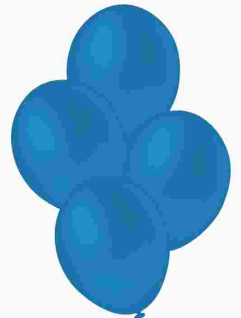

BALAO 9,0 RED NEON CITRUS AZUL 30X1

Código: 38520 Fábrica: HAPPY DAY Unidade: PT/30 F1 F4

UN: R\$ 0,50 AV: R\$ 14,97 15: R\$ 15,28  
30: R\$ 15,58 45: R\$ 15,90 60: R\$ 16,21

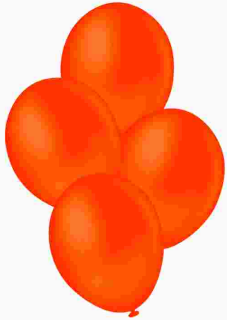

BALAO 9,0 RED NEON CITRUS LARANJA 30X1

Código: 38523 Fábrica: HAPPY DAY Unidade: PT/30 F1 F4

UN: R\$ 0,50 AV: R\$ 14,97 15: R\$ 15,28  
30: R\$ 15,58 45: R\$ 15,90 60: R\$ 16,21



BALAO 9,0 RED NEON CITRUS SORTIDO 30X1

Código: 38528 Fábrica: HAPPY DAY Unidade: PT/30 F1 F4

UN: R\$ 0,50 AV: R\$ 14,97 15: R\$ 15,28  
30: R\$ 15,58 45: R\$ 15,90 60: R\$ 16,21



BALAO 9,0 RED NEON CITRUS VERDE 30X1

Código: 38526 Fábrica: HAPPY DAY Unidade: PT/30 F1 F4

UN: R\$ 0,50 AV: R\$ 14,97 15: R\$ 15,28  
30: R\$ 15,58 45: R\$ 15,90 60: R\$ 16,21

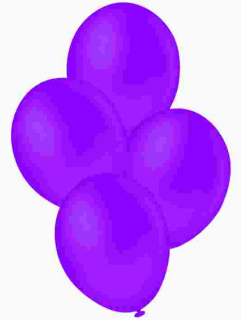

BALAO 9,0 RED NEON LILAS 30X1

Código: 38524 Fábrica: HAPPY DAY Unidade: PT/30 F1 F4

UN: R\$ 0,50 AV: R\$ 14,97 15: R\$ 15,28  
30: R\$ 15,58 45: R\$ 15,90 60: R\$ 16,21

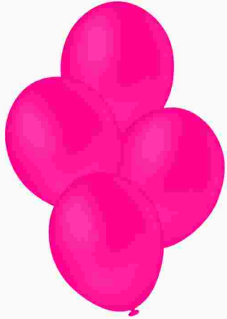

BALAO 9,0 RED NEON ROSA 30X1

Código: 38525 Fábrica: HAPPY DAY Unidade: PT/30 F1 F4

UN: R\$ 0,50 AV: R\$ 14,97 15: R\$ 15,28  
30: R\$ 15,58 45: R\$ 15,90 60: R\$ 16,21

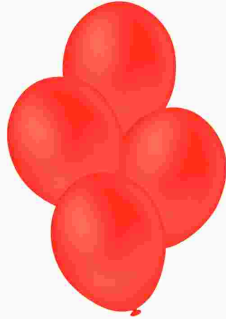

BALAO 9,0 RED NEON VERMELHO 30X1

Código: 38527 Fábrica: HAPPY DAY Unidade: PT/30 F1 F4

UN: R\$ 11,43 AV: R\$ 11,43 15: R\$ 11,67  
30: R\$ 11,90 45: R\$ 12,14 60: R\$ 12,38



BALAO BIG 250 LISO AMARELO

Código: 39197 Fábrica: HAPPY DAY Unidade: PT/1 F1 F4

UN: R\$ 11,43 AV: R\$ 11,43 15: R\$ 11,67  
30: R\$ 11,90 45: R\$ 12,14 60: R\$ 12,38



BALAO BIG 250 LISO AZUL

Código: 39199 Fábrica: HAPPY DAY Unidade: PT/1 F1 F4

UN: R\$ 11,43 AV: R\$ 11,43 15: R\$ 11,67  
30: R\$ 11,90 45: R\$ 12,14 60: R\$ 12,38



BALAO BIG 250 LISO AZULCLARO

Código: 39198 Fábrica: HAPPY DAY Unidade: PT/1 F1 F4

UN: R\$ 11,43 AV: R\$ 11,43 15: R\$ 11,67  
30: R\$ 11,90 45: R\$ 12,14 60: R\$ 12,38



BALAO BIG 250 LISO BEGE

Código: 39200 Fábrica: HAPPY DAY Unidade: PT/1 F1 F4

UN: R\$ 11,43 AV: R\$ 11,43 15: R\$ 11,67  
30: R\$ 11,90 45: R\$ 12,14 60: R\$ 12,38



BALAO BIG 250 LISO BRANCO

Código: 39196 Fábrica: HAPPY DAY Unidade: PT/1 F1 F4

UN: R\$ 11,43 AV: R\$ 11,43 15: R\$ 11,67  
30: R\$ 11,90 45: R\$ 12,14 60: R\$ 12,38



BALAO BIG 250 LISO CRISTAL

Código: 39201 Fábrica: HAPPY DAY Unidade: PT/1 F1 F4

UN: R\$ 11,43 AV: R\$ 11,43 15: R\$ 11,67  
30: R\$ 11,90 45: R\$ 12,14 60: R\$ 12,38



BALAO BIG 250 LISO LARANJA

Código: **39202** Fábrica: HAPPY DAY Unidade: PT/1 F1 F4

UN: R\$ 11,43 AV: R\$ 11,43 15: R\$ 11,67  
30: R\$ 11,90 45: R\$ 12,14 60: R\$ 12,38



BALAO BIG 250 LISO LILAS

Código: **39203** Fábrica: HAPPY DAY Unidade: PT/1 F1 F4

UN: R\$ 11,43 AV: R\$ 11,43 15: R\$ 11,67  
30: R\$ 11,90 45: R\$ 12,14 60: R\$ 12,38



BALAO BIG 250 LISO PRETO

Código: **39204** Fábrica: HAPPY DAY Unidade: PT/1 F1 F4

UN: R\$ 11,43 AV: R\$ 11,43 15: R\$ 11,67  
30: R\$ 11,90 45: R\$ 12,14 60: R\$ 12,38



BALAO BIG 250 LISO ROSA

Código: **39205** Fábrica: HAPPY DAY Unidade: PT/1 F1 F4

UN: R\$ 11,43 AV: R\$ 11,43 15: R\$ 11,67  
30: R\$ 11,90 45: R\$ 12,14 60: R\$ 12,38



BALAO BIG 250 LISO ROSA PINK

Código: **39207** Fábrica: HAPPY DAY Unidade: PT/1 F1 F4

UN: R\$ 11,43 AV: R\$ 11,43 15: R\$ 11,67  
30: R\$ 11,90 45: R\$ 12,14 60: R\$ 12,38



BALAO BIG 250 LISO VERDE

Código: **39206** Fábrica: HAPPY DAY Unidade: PT/1 F1 F4

UN: R\$ 11,43 AV: R\$ 11,43 15: R\$ 11,67  
30: R\$ 11,90 45: R\$ 12,14 60: R\$ 12,38



BALAO BIG 250 LISO VERMELHO

Código: **39208** Fábrica: HAPPY DAY Unidade: PT/1 F1 F4

UN: R\$ 1,98 AV: R\$ 9,88 15: R\$ 10,99  
30: R\$ 10,29 45: R\$ 10,50 60: R\$ 10,71



BALAO BUBLE 24 POLEGADAS 5X1

Código: **50334** Fábrica: BUBBLE Unidade: PT/5 F1 F4

UN: R\$ 2,00 AV: R\$ 19,96 15: R\$ 20,37  
30: R\$ 20,78 45: R\$ 21,20 60: R\$ 21,62



BALAO BUQUE CHA DE REVELACAO 10X1

Código: **37926** Fábrica: HAPPY DAY Unidade: PT/10 F1 F4

UN: R\$ 2,00 AV: R\$ 19,96 15: R\$ 20,37  
30: R\$ 20,78 45: R\$ 21,20 60: R\$ 21,62



BALAO BUQUE CORACAO 10X1

Código: **37936** Fábrica: HAPPY DAY Unidade: PT/10 F1 F4

UN: R\$ 2,00 AV: R\$ 19,96 15: R\$ 20,37  
30: R\$ 20,78 45: R\$ 21,20 60: R\$ 21,62



BALAO BUQUE FAZENDINHA 10X1

Código: **37927** Fábrica: HAPPY DAY Unidade: PT/10 F1 F4

UN: R\$ 19,99 AV: R\$ 19,99 15: R\$ 19,99  
30: R\$ 19,99 45: R\$ 19,99 60: R\$ 19,99



BALAO BUQUE FESTA KIT 14UN

Código: **48285** Fábrica: SOLIDER Unidade: PT/1 F1 F4

UN: R\$ 2,00 AV: R\$ 19,96 15: R\$ 20,37  
30: R\$ 20,78 45: R\$ 21,20 60: R\$ 21,62



BALAO BUQUE FIRE 10X1

Código: **37929** Fábrica: HAPPY DAY Unidade: PT/10 F1 F4

UN: R\$ 2,00 AV: R\$ 19,96 15: R\$ 20,37  
30: R\$ 20,78 45: R\$ 21,20 60: R\$ 21,62



BALAO BUQUE FUNDO DO MAR 10X1

Código: **37930** Fábrica: HAPPY DAY Unidade: PT/10 F1 F4

UN: R\$ 2,00 AV: R\$ 19,96 15: R\$ 20,37  
30: R\$ 20,78 45: R\$ 21,20 60: R\$ 21,62



BALAO BUQUE HALLOWEEN 10X1

Código: **37931** Fábrica: HAPPY DAY Unidade: PT/10 F1 F4

UN: R\$ 2,00 AV: R\$ 19,96 15: R\$ 20,37  
30: R\$ 20,78 45: R\$ 21,20 60: R\$ 21,62



BALAO BUQUE MEU PAPAÍ 10X1

Código: **37916** Fábrica: HAPPY DAY Unidade: PT/10 F1 F4

UN: R\$ 2,00 AV: R\$ 19,96 15: R\$ 20,37  
30: R\$ 20,78 45: R\$ 21,20 60: R\$ 21,62



BALAO BUQUE NATAL ALUMINIO 10X1

Código: 37932 Fábrica: HAPPY DAY Unidade: PT/10 F1 F4

UN: R\$ 2,00 AV: R\$ 19,96 15: R\$ 20,37  
30: R\$ 20,78 45: R\$ 21,20 60: R\$ 21,62



BALAO BUQUE NOVEMBRO AZUL 10X1

Código: 37934 Fábrica: HAPPY DAY Unidade: PT/10 F1 F4

UN: R\$ 2,00 AV: R\$ 19,96 15: R\$ 20,37  
30: R\$ 20,78 45: R\$ 21,20 60: R\$ 21,62



BALAO BUQUE SUPER HEROIS 10X1

Código: 37922 Fábrica: HAPPY DAY Unidade: PT/10 F1 F4

UN: R\$ 2,00 AV: R\$ 19,96 15: R\$ 20,37  
30: R\$ 20,78 45: R\$ 21,20 60: R\$ 21,62



BALAO BUQUE UNICORNIO 10X1

Código: 37918 Fábrica: HAPPY DAY Unidade: PT/10 F1 F4

UN: R\$ 0,28 AV: R\$ 13,97 15: R\$ 14,26  
30: R\$ 14,54 45: R\$ 14,83 60: R\$ 15,13



BALAO CANUDO/PALITO LISO 260 AMARELO 50X1

Código: 50692 Fábrica: SAOROQUE Unidade: PT/50 F1 F4

UN: R\$ 0,28 AV: R\$ 13,97 15: R\$ 14,26  
30: R\$ 14,54 45: R\$ 14,83 60: R\$ 15,13



BALAO CANUDO/PALITO LISO 260 AZUL 50X1

Código: 50695 Fábrica: SAOROQUE Unidade: PT/50 F1 F4

UN: R\$ 0,28 AV: R\$ 13,97 15: R\$ 14,26  
30: R\$ 14,54 45: R\$ 14,83 60: R\$ 15,13

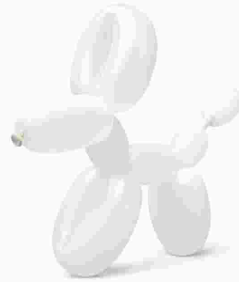

BALAO CANUDO/PALITO LISO 260 BRANCO 50X1

Código: 50690 Fábrica: SAOROQUE Unidade: PT/50 F1 F4

UN: R\$ 0,28 AV: R\$ 13,97 15: R\$ 14,26  
30: R\$ 14,54 45: R\$ 14,83 60: R\$ 15,13



BALAO CANUDO/PALITO LISO 260 LARANJ 50X1

Código: 50696 Fábrica: SAOROQUE Unidade: PT/50 F1 F4

UN: R\$ 0,28 AV: R\$ 13,97 15: R\$ 14,26  
30: R\$ 14,54 45: R\$ 14,83 60: R\$ 15,13



BALAO CANUDO/PALITO LISO 260 LARANJ 50X1

Código: 50694 Fábrica: SAOROQUE Unidade: PT/50 F1 F4

UN: R\$ 0,28 AV: R\$ 13,97 15: R\$ 14,26  
30: R\$ 14,54 45: R\$ 14,83 60: R\$ 15,13



BALAO CANUDO/PALITO LISO 260 SORT 50X1

Código: 41846 Fábrica: HAPPY/SAOROQ Unidade: PT/50 F1 F4

UN: R\$ 0,28 AV: R\$ 13,97 15: R\$ 14,26  
30: R\$ 14,54 45: R\$ 14,83 60: R\$ 15,13

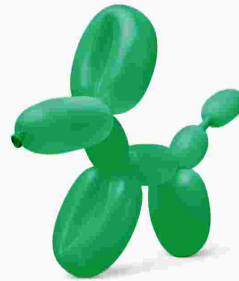

BALAO CANUDO/PALITO LISO 260 VERDE 50X1

Código: 50691 Fábrica: SAOROQUE Unidade: PT/50 F1 F4

UN: R\$ 0,28 AV: R\$ 13,97 15: R\$ 14,26  
30: R\$ 14,54 45: R\$ 14,83 60: R\$ 15,13

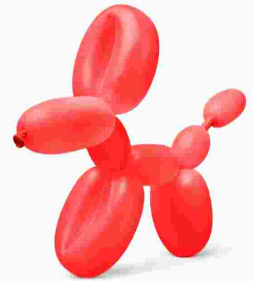

BALAO CANUDO/PALITO LISO 260 VERMEL 50X1

Código: 50693 Fábrica: SAOROQUE Unidade: PT/50 F1 F4

UN: R\$ 3,98 AV: R\$ 3,98 15: R\$ 4,07  
30: R\$ 4,15 45: R\$ 4,23 60: R\$ 4,32



BALAO PLAST METALIA 0 ESTRELA AZUL 40CM

Código: 40738 Fábrica: FEST WAY Unidade: UN/1 F1 F4

UN: R\$ 4,55 AV: R\$ 4,55 15: R\$ 4,65  
30: R\$ 4,74 45: R\$ 4,84 60: R\$ 4,93



BALAO PLAST METALIZ CORACAO ROSA 45CM

Código: 51035 Fábrica: FEST WAY Unidade: UN/1 F1 F4

UN: R\$ 7,98 AV: R\$ 7,98 15: R\$ 8,14  
30: R\$ 8,31 45: R\$ 8,47 60: R\$ 8,64



BALAO PLAST METALIZ OURO LETRA A 75CM

Código: 47543 Fábrica: FEST WAY Unidade: UN/1 F1 F4

UN: R\$ 7,98 AV: R\$ 7,98 15: R\$ 8,14  
30: R\$ 8,31 45: R\$ 8,47 60: R\$ 8,64



BALAO PLAST METALIZ OURO LETRA B 75CM

Código: 47544 Fábrica: FEST WAY Unidade: UN/1 F1 F4

UN: R\$ 7,98 AV: R\$ 7,98 15: R\$ 8,14  
30: R\$ 8,31 45: R\$ 8,47 60: R\$ 8,64



BALAO PLAST METALIZ OURO LETRA C 75CM

Código: 47545 Fábrica: FEST WAY Unidade: UN/1 F1 F4

UN: R\$ 7,98 AV: R\$ 7,98 15: R\$ 8,14  
30: R\$ 8,31 45: R\$ 8,47 60: R\$ 8,64



BALAO PLAST METALIZ OURO LETRA D 75CM

Código: 47546 Fábrica: FEST WAY Unidade: UN/1 F1 F4

UN: R\$ 7,98 AV: R\$ 7,98 15: R\$ 8,14  
30: R\$ 8,31 45: R\$ 8,47 60: R\$ 8,64



BALAO PLAST METALIZ OURO LETRA E 75CM

Código: 47547 Fábrica: FEST WAY Unidade: UN/1 F1 F4

UN: R\$ 7,98 AV: R\$ 7,98 15: R\$ 8,14  
30: R\$ 8,31 45: R\$ 8,47 60: R\$ 8,64



BALAO PLAST METALIZ OURO LETRA F 75CM

Código: 47548 Fábrica: FEST WAY Unidade: UN/1 F1 F4

UN: R\$ 7,98 AV: R\$ 7,98 15: R\$ 8,14  
30: R\$ 8,31 45: R\$ 8,47 60: R\$ 8,64



BALAO PLAST METALIZ OURO LETRA G 75CM

Código: 47549 Fábrica: FEST WAY Unidade: UN/1 F1 F4

UN: R\$ 7,98 AV: R\$ 7,98 15: R\$ 8,14  
30: R\$ 8,31 45: R\$ 8,47 60: R\$ 8,64



BALAO PLAST METALIZ OURO LETRA H 75CM

Código: 47550 Fábrica: FEST WAY Unidade: UN/1 F1 F4

UN: R\$ 7,98 AV: R\$ 7,98 15: R\$ 8,14  
30: R\$ 8,31 45: R\$ 8,47 60: R\$ 8,64



BALAO PLAST METALIZ OURO LETRA I 75CM

Código: 47551 Fábrica: FEST WAY Unidade: UN/1 F1 F4

UN: R\$ 7,98 AV: R\$ 7,98 15: R\$ 8,14  
30: R\$ 8,31 45: R\$ 8,47 60: R\$ 8,64



BALAO PLAST METALIZ OURO LETRA J 75CM

Código: 47552 Fábrica: FEST WAY Unidade: UN/1 F1 F4

UN: R\$ 7,98 AV: R\$ 7,98 15: R\$ 8,14  
30: R\$ 8,31 45: R\$ 8,47 60: R\$ 8,64



BALAO PLAST METALIZ OURO LETRA K 75CM

Código: 47553 Fábrica: FEST WAY Unidade: UN/1 F1 F4

UN: R\$ 7,98 AV: R\$ 7,98 15: R\$ 8,14  
30: R\$ 8,31 45: R\$ 8,47 60: R\$ 8,64



BALAO PLAST METALIZ OURO LETRA L 75CM

Código: 47554 Fábrica: FEST WAY Unidade: UN/1 F1 F4

UN: R\$ 7,98 AV: R\$ 7,98 15: R\$ 8,14  
30: R\$ 8,31 45: R\$ 8,47 60: R\$ 8,64



BALAO PLAST METALIZ OURO LETRA M 75CM

Código: 47555 Fábrica: FEST WAY Unidade: UN/1 F1 F4

UN: R\$ 7,98 AV: R\$ 7,98 15: R\$ 8,14  
30: R\$ 8,31 45: R\$ 8,47 60: R\$ 8,64



BALAO PLAST METALIZ OURO LETRA N 75CM

Código: 47556 Fábrica: FEST WAY Unidade: UN/1 F1 F4

UN: R\$ 7,98 AV: R\$ 7,98 15: R\$ 8,14  
30: R\$ 8,31 45: R\$ 8,47 60: R\$ 8,64



BALAO PLAST METALIZ OURO LETRA O 75CM

Código: 47557 Fábrica: FEST WAY Unidade: UN/1 F1 F4

UN: R\$ 7,98 AV: R\$ 7,98 15: R\$ 8,14  
30: R\$ 8,31 45: R\$ 8,47 60: R\$ 8,64



BALAO PLAST METALIZ OURO LETRA P 75CM

Código: 47558 Fábrica: FEST WAY Unidade: UN/1 F1 F4

UN: R\$ 7,98 AV: R\$ 7,98 15: R\$ 8,14  
30: R\$ 8,31 45: R\$ 8,47 60: R\$ 8,64



BALAO PLAST METALIZ OURO LETRA Q 75CM

Código: 47559 Fábrica: FEST WAY Unidade: UN/1 F1 F4

UN: R\$ 7,98 AV: R\$ 7,98 15: R\$ 8,14  
30: R\$ 8,31 45: R\$ 8,47 60: R\$ 8,64



BALAO PLAST METALIZ OURO LETRA R 75CM

Código: 47560 Fábrica: FEST WAY Unidade: UN/1 F1 F4

UN: R\$ 7,98 AV: R\$ 7,98 15: R\$ 8,14  
30: R\$ 8,31 45: R\$ 8,47 60: R\$ 8,64



BALAO PLAST METALIZ OURO LETRA S 75CM

Código: 47561 Fábrica: FEST WAY Unidade: UN/1 F1 F4

UN: R\$ 7,98 AV: R\$ 7,98 15: R\$ 8,14  
30: R\$ 8,31 45: R\$ 8,47 60: R\$ 8,64



BALAO PLAST METALIZ OURO LETRA T 75CM

Código: 47562 Fábrica: FEST WAY Unidade: UN/1 F1 F4

UN: R\$ 7,98 AV: R\$ 7,98 15: R\$ 8,14  
30: R\$ 8,31 45: R\$ 8,47 60: R\$ 8,64



BALAO PLAST METALIZ OURO LETRA U 75CM

Código: 47563 Fábrica: FEST WAY Unidade: UN/1 F1 F4

UN: R\$ 7,98 AV: R\$ 7,98 15: R\$ 8,14  
30: R\$ 8,31 45: R\$ 8,47 60: R\$ 8,64



BALAO PLAST METALIZ OURO LETRA V 75CM

Código: 47564 Fábrica: FEST WAY Unidade: UN/1 F1 F4

UN: R\$ 7,98 AV: R\$ 7,98 15: R\$ 8,14  
30: R\$ 8,31 45: R\$ 8,47 60: R\$ 8,64



BALAO PLAST METALIZ OURO LETRA W 75CM

Código: 47565 Fábrica: FEST WAY Unidade: UN/1 F1 F4

UN: R\$ 7,98 AV: R\$ 7,98 15: R\$ 8,14  
30: R\$ 8,31 45: R\$ 8,47 60: R\$ 8,64



BALAO PLAST METALIZ OURO LETRA X 75CM

Código: 47566 Fábrica: FEST WAY Unidade: UN/1 F1 F4

UN: R\$ 7,98 AV: R\$ 7,98 15: R\$ 8,14  
30: R\$ 8,31 45: R\$ 8,47 60: R\$ 8,64



BALAO PLAST METALIZ OURO LETRA Y 75CM

Código: 47567 Fábrica: FEST WAY Unidade: UN/1 F1 F4

UN: R\$ 7,98 AV: R\$ 7,98 15: R\$ 8,14  
30: R\$ 8,31 45: R\$ 8,47 60: R\$ 8,64



BALAO PLAST METALIZ OURO LETRA Z 75CM

Código: 47568 Fábrica: FEST WAY Unidade: UN/1 F1 F4

UN: R\$ 7,98 AV: R\$ 7,98 15: R\$ 8,14  
30: R\$ 8,31 45: R\$ 8,47 60: R\$ 8,64

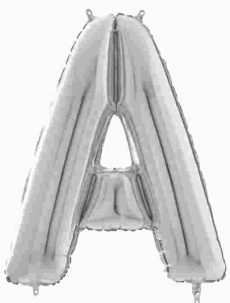

BALAO PLAST METALIZ PRATA LETRA A 75CM

Código: 47517 Fábrica: FEST WAY Unidade: UN/1 F1 F4

UN: R\$ 7,98 AV: R\$ 7,98 15: R\$ 8,14  
30: R\$ 8,31 45: R\$ 8,47 60: R\$ 8,64



BALAO PLAST METALIZ PRATA LETRA B 75CM

Código: 47518 Fábrica: FEST WAY Unidade: UN/1 F1 F4

UN: R\$ 7,98 AV: R\$ 7,98 15: R\$ 8,14  
30: R\$ 8,31 45: R\$ 8,47 60: R\$ 8,64

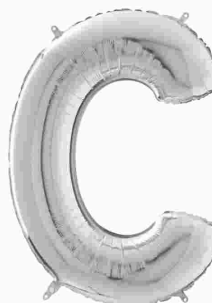

BALAO PLAST METALIZ PRATA LETRA C 75CM

Código: 47519 Fábrica: FEST WAY Unidade: UN/1 F1 F4

UN: R\$ 7,98 AV: R\$ 7,98 15: R\$ 8,14  
30: R\$ 8,31 45: R\$ 8,47 60: R\$ 8,64



BALAO PLAST METALIZ PRATA LETRA D 75CM

Código: 47520 Fábrica: FEST WAY Unidade: UN/1 F1 F4

UN: R\$ 7,98 AV: R\$ 7,98 15: R\$ 8,14  
30: R\$ 8,31 45: R\$ 8,47 60: R\$ 8,64



BALAO PLAST METALIZ PRATA LETRA E 75CM

Código: 47521 Fábrica: FEST WAY Unidade: UN/1 F1 F4

UN: R\$ 7,98 AV: R\$ 7,98 15: R\$ 8,14  
30: R\$ 8,31 45: R\$ 8,47 60: R\$ 8,64



BALAO PLAST METALIZ PRATA LETRA F 75CM

Código: 47522 Fábrica: FEST WAY Unidade: UN/1 F1 F4

UN: R\$ 7,98 AV: R\$ 7,98 15: R\$ 8,14  
30: R\$ 8,31 45: R\$ 8,47 60: R\$ 8,64

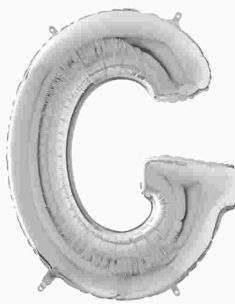

BALAO PLAST METALIZ PRATA LETRA G 75CM

Código: 47523 Fábrica: FEST WAY Unidade: UN/1 F1 F4

UN: R\$ 7,98 AV: R\$ 7,98 15: R\$ 8,14  
30: R\$ 8,31 45: R\$ 8,47 60: R\$ 8,64

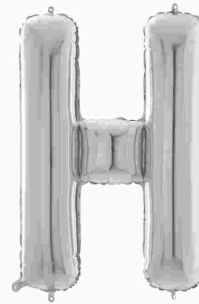

BALAO PLAST METALIZ PRATA LETRA H 75CM

Código: 47524 Fábrica: FEST WAY Unidade: UN/1 F1 F4

UN: R\$ 7,98 AV: R\$ 7,98 15: R\$ 8,14  
30: R\$ 8,31 45: R\$ 8,47 60: R\$ 8,64



BALAO PLAST METALIZ PRATA LETRA I 75CM

Código: Fábrica: Unidade:  
**47525** FEST WAY UN/1  
F1 F4

UN: R\$ 7,98 AV: R\$ 7,98 15: R\$ 8,14  
30: R\$ 8,31 45: R\$ 8,47 60: R\$ 8,64

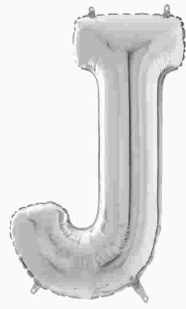

BALAO PLAST METALIZ PRATA LETRA J 75CM

Código: Fábrica: Unidade:  
**47526** FEST WAY UN/1  
F1 F4

UN: R\$ 7,98 AV: R\$ 7,98 15: R\$ 8,14  
30: R\$ 8,31 45: R\$ 8,47 60: R\$ 8,64



BALAO PLAST METALIZ PRATA LETRA K 75CM

Código: Fábrica: Unidade:  
**47527** FEST WAY UN/1  
F1 F4

UN: R\$ 7,98 AV: R\$ 7,98 15: R\$ 8,14  
30: R\$ 8,31 45: R\$ 8,47 60: R\$ 8,64



BALAO PLAST METALIZ PRATA LETRA L 75CM

Código: Fábrica: Unidade:  
**47528** FEST WAY UN/1  
F1 F4

UN: R\$ 7,98 AV: R\$ 7,98 15: R\$ 8,14  
30: R\$ 8,31 45: R\$ 8,47 60: R\$ 8,64

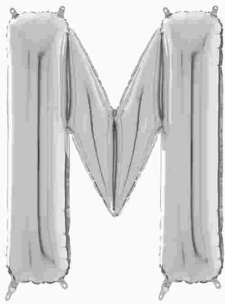

BALAO PLAST METALIZ PRATA LETRA M 75CM

Código: Fábrica: Unidade:  
**47529** FEST WAY UN/1  
F1 F4

UN: R\$ 7,98 AV: R\$ 7,98 15: R\$ 8,14  
30: R\$ 8,31 45: R\$ 8,47 60: R\$ 8,64

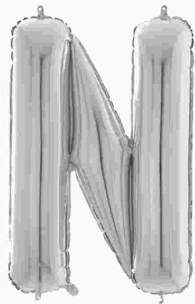

BALAO PLAST METALIZ PRATA LETRA N 75CM

Código: Fábrica: Unidade:  
**47530** FEST WAY UN/1  
F1 F4

UN: R\$ 7,98 AV: R\$ 7,98 15: R\$ 8,14  
30: R\$ 8,31 45: R\$ 8,47 60: R\$ 8,64

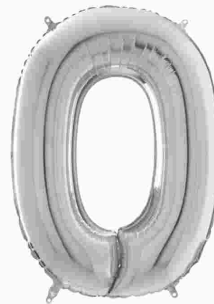

BALAO PLAST METALIZ PRATA LETRA O 75CM

Código: Fábrica: Unidade:  
**47531** FEST WAY UN/1  
F1 F4

UN: R\$ 7,98 AV: R\$ 7,98 15: R\$ 8,14  
30: R\$ 8,31 45: R\$ 8,47 60: R\$ 8,64



BALAO PLAST METALIZ PRATA LETRA P 75CM

Código: Fábrica: Unidade:  
**47532** FEST WAY UN/1  
F1 F4

UN: R\$ 7,98 AV: R\$ 7,98 15: R\$ 8,14  
30: R\$ 8,31 45: R\$ 8,47 60: R\$ 8,64

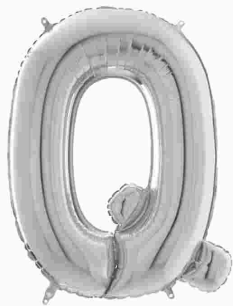

BALAO PLAST METALIZ PRATA LETRA Q 75CM

Código: Fábrica: Unidade:  
**47533** FEST WAY UN/1  
F1 F4

UN: R\$ 7,98 AV: R\$ 7,98 15: R\$ 8,14  
30: R\$ 8,31 45: R\$ 8,47 60: R\$ 8,64

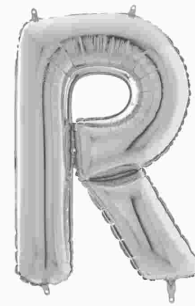

BALAO PLAST METALIZ PRATA LETRA R 75CM

Código: Fábrica: Unidade:  
**47534** FEST WAY UN/1  
F1 F4

UN: R\$ 7,98 AV: R\$ 7,98 15: R\$ 8,14  
30: R\$ 8,31 45: R\$ 8,47 60: R\$ 8,64

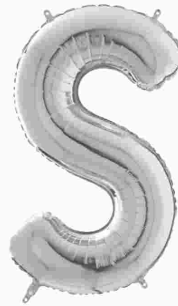

BALAO PLAST METALIZ PRATA LETRA S 75CM

Código: Fábrica: Unidade:  
**47535** FEST WAY UN/1  
F1 F4

UN: R\$ 7,98 AV: R\$ 7,98 15: R\$ 8,14  
30: R\$ 8,31 45: R\$ 8,47 60: R\$ 8,64



BALAO PLAST METALIZ PRATA LETRA T 75CM

Código: Fábrica: Unidade:  
**47536** FEST WAY UN/1  
F1 F4

UN: R\$ 7,98 AV: R\$ 7,98 15: R\$ 8,14  
30: R\$ 8,31 45: R\$ 8,47 60: R\$ 8,64

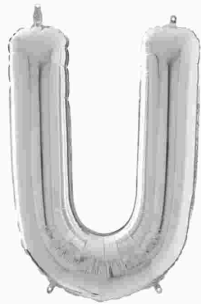

BALAO PLAST METALIZ PRATA LETRA U 75CM

Código: Fábrica: Unidade:  
**47537** FEST WAY UN/1  
F1 F4

UN: R\$ 7,98 AV: R\$ 7,98 15: R\$ 8,14  
30: R\$ 8,31 45: R\$ 8,47 60: R\$ 8,64

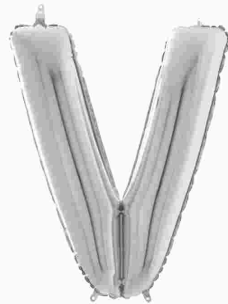

BALAO PLAST METALIZ PRATA LETRA V 75CM

Código: Fábrica: Unidade:  
**47538** FEST WAY UN/1  
F1 F4

UN: R\$ 7,98 AV: R\$ 7,98 15: R\$ 8,14  
30: R\$ 8,31 45: R\$ 8,47 60: R\$ 8,64

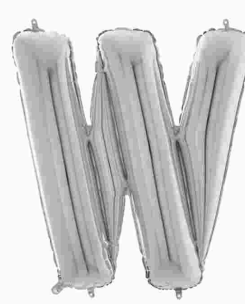

BALAO PLAST METALIZ PRATA LETRA W 75CM

Código: Fábrica: Unidade:  
**47539** FEST WAY UN/1  
F1 F4

UN: R\$ 7,98 AV: R\$ 7,98 15: R\$ 8,14  
30: R\$ 8,31 45: R\$ 8,47 60: R\$ 8,64

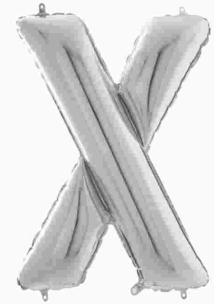

BALAO PLAST METALIZ PRATA LETRA X 75CM

Código: Fábrica: Unidade:  
**47540** FEST WAY UN/1  
F1 F4

UN: R\$ 7,98 AV: R\$ 7,98 15: R\$ 8,14  
30: R\$ 8,31 45: R\$ 8,47 60: R\$ 8,64



BALAO PLAST METALIZ PRATA LETRA Y 75CM  
Código: Fábrika: Unidade:  
**47541** FEST WAY UN/1  
F1 F4

UN: R\$ 7,98 AV: R\$ 7,98 15: R\$ 8,14  
30: R\$ 8,31 45: R\$ 8,47 60: R\$ 8,64



BALAO PLAST METALIZ PRATA LETRA Z 75CM  
Código: Fábrika: Unidade:  
**47542** FEST WAY UN/1  
F1 F4

UN: R\$ 3,98 AV: R\$ 3,98 15: R\$ 4,07  
30: R\$ 4,15 45: R\$ 4,23 60: R\$ 4,32

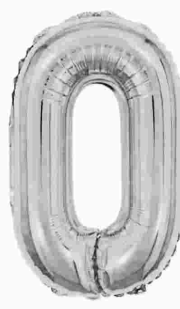

BALAO PLAST METALIZ O LISO PRATA 40CM  
Código: Fábrika: Unidade:  
**40763** FEST WAY UN/1  
F1 F4

UN: R\$ 3,98 AV: R\$ 3,98 15: R\$ 4,07  
30: R\$ 4,15 45: R\$ 4,23 60: R\$ 4,32



BALAO PLAST METALIZ 1 AZUL ESTRELA 40CM  
Código: Fábrika: Unidade:  
**40764** FEST WAY UN/1  
F1 F4

UN: R\$ 3,98 AV: R\$ 3,98 15: R\$ 4,07  
30: R\$ 4,15 45: R\$ 4,23 60: R\$ 4,32



BALAO PLAST METALIZ 1 LISO PRATA 40CM  
Código: Fábrika: Unidade:  
**40766** FEST WAY UN/1  
F1 F4

UN: R\$ 3,98 AV: R\$ 3,98 15: R\$ 4,07  
30: R\$ 4,15 45: R\$ 4,23 60: R\$ 4,32



BALAO PLAST METALIZ 2 CORACAO ROSA 40CM  
Código: Fábrika: Unidade:  
**41585** FEST WAY UN/1  
F1 F4

UN: R\$ 3,98 AV: R\$ 3,98 15: R\$ 4,07  
30: R\$ 4,15 45: R\$ 4,23 60: R\$ 4,32



BALAO PLAST METALIZ 2 ESTRELA AZUL 40CM  
Código: Fábrika: Unidade:  
**41586** FEST WAY UN/1  
F1 F4

UN: R\$ 3,98 AV: R\$ 3,98 15: R\$ 4,07  
30: R\$ 4,15 45: R\$ 4,23 60: R\$ 4,32



BALAO PLAST METALIZ 3 CORACAO ROSA 40CM  
Código: Fábrika: Unidade:  
**41570** FEST WAY UN/1  
F1 F4

UN: R\$ 3,98 AV: R\$ 3,98 15: R\$ 4,07  
30: R\$ 4,15 45: R\$ 4,23 60: R\$ 4,32



BALAO PLAST METALIZ 3 ESTRELA AZUL 44CM  
Código: Fábrika: Unidade:  
**40767** FEST WAY UN/1  
F1 F4

UN: R\$ 3,98 AV: R\$ 3,98 15: R\$ 4,07  
30: R\$ 4,15 45: R\$ 4,23 60: R\$ 4,32



BALAO PLAST METALIZ 3 LISO DOURADO 40CM  
Código: Fábrika: Unidade:  
**41596** FEST WAY UN/1  
F1 F4

UN: R\$ 3,98 AV: R\$ 3,98 15: R\$ 4,07  
30: R\$ 4,15 45: R\$ 4,23 60: R\$ 4,32



BALAO PLAST METALIZ 4 ESTRELA AZUL 44CM  
Código: Fábrika: Unidade:  
**41571** FEST WAY UN/1  
F1 F4

UN: R\$ 3,98 AV: R\$ 3,98 15: R\$ 4,07  
30: R\$ 4,15 45: R\$ 4,23 60: R\$ 4,32



BALAO PLAST METALIZ 4 LISO PRATA 40CM  
Código: Fábrika: Unidade:  
**41573** FEST WAY UN/1  
F1 F4

UN: R\$ 3,98 AV: R\$ 3,98 15: R\$ 4,07  
30: R\$ 4,15 45: R\$ 4,23 60: R\$ 4,32



BALAO PLAST METALIZ 5 CORACAO ROSA 40CM  
Código: Fábrika: Unidade:  
**41576** FEST WAY UN/1  
F1 F4

UN: R\$ 3,98 AV: R\$ 3,98 15: R\$ 4,07  
30: R\$ 4,15 45: R\$ 4,23 60: R\$ 4,32



BALAO PLAST METALIZ 5 ESTRELA AZUL 40CM  
Código: Fábrika: Unidade:  
**41577** FEST WAY UN/1  
F1 F4

UN: R\$ 3,98 AV: R\$ 3,98 15: R\$ 4,07  
30: R\$ 4,15 45: R\$ 4,23 60: R\$ 4,32



BALAO PLAST METALIZ 5 LISO DOURADO 40CM  
Código: Fábrika: Unidade:  
**41575** FEST WAY UN/1  
F1 F4

UN: R\$ 3,98 AV: R\$ 3,98 15: R\$ 4,07  
30: R\$ 4,15 45: R\$ 4,23 60: R\$ 4,32



BALAO PLAST METALIZ 5 LISO PRATA 40CM  
Código: Fábrika: Unidade:  
**41574** FEST WAY UN/1  
F1 F4

UN: R\$ 3,98 AV: R\$ 3,98 15: R\$ 4,07  
30: R\$ 4,15 45: R\$ 4,23 60: R\$ 4,32



BALAO PLAST METALIZ 6 CORACAO ROSA 40CM  
Código: 41579 Fábrica: FEST WAY Unidade: UN/1  
F1 F4

UN: R\$ 3,98 AV: R\$ 3,98 15: R\$ 4,07  
30: R\$ 4,15 45: R\$ 4,23 60: R\$ 4,32



BALAO PLAST METALIZ 6 ESTRELA AZUL 40CM  
Código: 41578 Fábrica: FEST WAY Unidade: UN/1  
F1 F4

UN: R\$ 3,98 AV: R\$ 3,98 15: R\$ 4,07  
30: R\$ 4,15 45: R\$ 4,23 60: R\$ 4,32



BALAO PLAST METALIZ 6 LISO DOURADO 40CM  
Código: 41595 Fábrica: FEST WAY Unidade: UN/1  
F1 F4

UN: R\$ 3,98 AV: R\$ 3,98 15: R\$ 4,07  
30: R\$ 4,15 45: R\$ 4,23 60: R\$ 4,32



BALAO PLAST METALIZ 6 LISO PRATA 40CM  
Código: 41580 Fábrica: FEST WAY Unidade: UN/1  
F1 F4

UN: R\$ 3,98 AV: R\$ 3,98 15: R\$ 4,07  
30: R\$ 4,15 45: R\$ 4,23 60: R\$ 4,32



BALAO PLAST METALIZ 7 CORACAO ROSA 40CM  
Código: 41584 Fábrica: FEST WAY Unidade: UN/1  
F1 F4

UN: R\$ 3,98 AV: R\$ 3,98 15: R\$ 4,07  
30: R\$ 4,15 45: R\$ 4,23 60: R\$ 4,32



BALAO PLAST METALIZ 7 ESTRELA AZUL 40CM  
Código: 41583 Fábrica: FEST WAY Unidade: UN/1  
F1 F4

UN: R\$ 3,98 AV: R\$ 3,98 15: R\$ 4,07  
30: R\$ 4,15 45: R\$ 4,23 60: R\$ 4,32



BALAO PLAST METALIZ 7 LISO DOURADO 40CM  
Código: 41582 Fábrica: FEST WAY Unidade: UN/1  
F1 F4

UN: R\$ 3,98 AV: R\$ 3,98 15: R\$ 4,07  
30: R\$ 4,15 45: R\$ 4,23 60: R\$ 4,32



BALAO PLAST METALIZ 7 LISO PRATA 40CM  
Código: 41581 Fábrica: FEST WAY Unidade: UN/1  
F1 F4

UN: R\$ 3,98 AV: R\$ 3,98 15: R\$ 4,07  
30: R\$ 4,15 45: R\$ 4,23 60: R\$ 4,32



BALAO PLAST METALIZ 8 CORACAO ROSA 40CM  
Código: 41594 Fábrica: FEST WAY Unidade: UN/1  
F1 F4

UN: R\$ 3,98 AV: R\$ 3,98 15: R\$ 4,07  
30: R\$ 4,15 45: R\$ 4,23 60: R\$ 4,32



BALAO PLAST METALIZ 8 ESTRELA AZUL 40CM  
Código: 41592 Fábrica: FEST WAY Unidade: UN/1  
F1 F4

UN: R\$ 3,98 AV: R\$ 3,98 15: R\$ 4,07  
30: R\$ 4,15 45: R\$ 4,23 60: R\$ 4,32



BALAO PLAST METALIZ 8 LISO DOURADO 40CM  
Código: 41593 Fábrica: FEST WAY Unidade: UN/1  
F1 F4

UN: R\$ 3,98 AV: R\$ 3,98 15: R\$ 4,07  
30: R\$ 4,15 45: R\$ 4,23 60: R\$ 4,32



BALAO PLAST METALIZ 9 CORACAO ROSA 40CM  
Código: 41590 Fábrica: FEST WAY Unidade: UN/1  
F1 F4

UN: R\$ 3,98 AV: R\$ 3,98 15: R\$ 4,07  
30: R\$ 4,15 45: R\$ 4,23 60: R\$ 4,32



BALAO PLAST METALIZ 9 ESTRELA AZUL 40CM  
Código: 41591 Fábrica: FEST WAY Unidade: UN/1  
F1 F4

UN: R\$ 3,98 AV: R\$ 3,98 15: R\$ 4,07  
30: R\$ 4,15 45: R\$ 4,23 60: R\$ 4,32



BALAO PLAST METALIZ 9 LISO DOURADO 40CM  
Código: 41589 Fábrica: FEST WAY Unidade: UN/1  
F1 F4

UN: R\$ 3,98 AV: R\$ 3,98 15: R\$ 4,07  
30: R\$ 4,15 45: R\$ 4,23 60: R\$ 4,32



BALAO PLAST METALIZ 9 LISO PRATA 40CM  
Código: 41588 Fábrica: FEST WAY Unidade: UN/1  
F1 F4

UN: R\$ 3,98 AV: R\$ 3,98 15: R\$ 4,07  
30: R\$ 4,15 45: R\$ 4,23 60: R\$ 4,32



BALAO PLAST METALIZA 0 CORACAO ROSA 40CM  
Código: 40762 Fábrica: FEST WAY Unidade: UN/1  
F1 F4

UN: R\$ 4,11 AV: R\$ 4,11 15: R\$ 4,20  
30: R\$ 4,28 45: R\$ 4,37 60: R\$ 4,46



BALAO PLAST P/FESTA BOLA 42X46CM 263  
Código: Fábrica: Unidade:  
**34784** AGUIA BRANCA PT/1  
F1 F4

UN: R\$ 16,14 AV: R\$ 16,14 15: R\$ 16,48  
30: R\$ 16,81 45: R\$ 17,15 60: R\$ 17,49



BALAO PLAST P/FESTA DINOSSAUROS 466 5X1  
Código: Fábrica: Unidade:  
**37325** AGUIA BRANCA UN/1  
F1 F4

UN: R\$ 24,46 AV: R\$ 24,46 15: R\$ 24,97  
30: R\$ 25,47 45: R\$ 25,98 60: R\$ 26,50



BALAO PLAST P/FESTA FELIZ ANIVERSAR 655  
Código: Fábrica: Unidade:  
**37327** AGUIA BRANCA UN/1  
F1 F4

UN: R\$ 4,24 AV: R\$ 254,59 15: R\$ 259,90  
30: R\$ 265,09 45: R\$ 270,40 60: R\$ 275,80



BALAO PLAST P/FESTA LETRAS DOUR/PRA 30X1  
Código: Fábrica: Unidade:  
**37346** AGUIA BRANCA UN/60  
F1 F4

UN: R\$ 7,09 AV: R\$ 7,09 15: R\$ 7,24  
30: R\$ 7,38 45: R\$ 7,53 60: R\$ 7,68



BALAO PLAST P/FESTA UNICORNIO 461  
Código: Fábrica: Unidade:  
**37328** AGUIA BRANCA UN/1  
F1 F4

UN: R\$ 1,41 AV: R\$ 16,96 15: R\$ 17,32  
30: R\$ 17,66 45: R\$ 18,02 60: R\$ 18,38



BALAO 11 CORACAO LISO BRANCO 12X1  
Código: Fábrica: Unidade:  
**39193** HAPPY DAY PT/12  
F1 F4

UN: R\$ 1,41 AV: R\$ 16,96 15: R\$ 17,32  
30: R\$ 17,66 45: R\$ 18,02 60: R\$ 18,38



BALAO 11 CORACAO LISO ROSA 12X1  
Código: Fábrica: Unidade:  
**39194** HAPPY DAY PT/12  
F1 F4

UN: R\$ 1,41 AV: R\$ 16,96 15: R\$ 17,32  
30: R\$ 17,66 45: R\$ 18,02 60: R\$ 18,38



BALAO 11 CORACAO LISO VERMELHO 12X1  
Código: Fábrica: Unidade:  
**39195** HAPPY DAY PT/12  
F1 F4

UN: R\$ 0,46 AV: R\$ 22,86 15: R\$ 23,34  
30: R\$ 23,81 45: R\$ 24,28 60: R\$ 24,77



BALAO 11 PERA LISO CRISTAL 50X1  
Código: Fábrica: Unidade:  
**42326** HAPPY DAY PT/50  
F1 F4

UN: R\$ 0,46 AV: R\$ 22,86 15: R\$ 23,34  
30: R\$ 23,81 45: R\$ 24,28 60: R\$ 24,77



BALAO 11 PERA LISO VERDE AGUA 50X1  
Código: Fábrica: Unidade:  
**42332** HAPPY DAY PT/50  
F1 F4

UN: R\$ 0,46 AV: R\$ 22,86 15: R\$ 23,34  
30: R\$ 23,81 45: R\$ 24,28 60: R\$ 24,77



BALAO 11 PERA LISO AMARELO 50X1  
Código: Fábrica: Unidade:  
**42341** HAPPY DAY PT/50  
F1 F4

UN: R\$ 0,46 AV: R\$ 22,86 15: R\$ 23,34  
30: R\$ 23,81 45: R\$ 24,28 60: R\$ 24,77



BALAO 11 PERA LISO AZUL ARTICO 50X1  
Código: Fábrica: Unidade:  
**42314** HAPPY DAY PT/50  
F1 F4

UN: R\$ 0,46 AV: R\$ 22,86 15: R\$ 23,34  
30: R\$ 23,81 45: R\$ 24,28 60: R\$ 24,77



BALAO 11 PERA LISO AZUL CELESTE 50X1  
Código: Fábrica: Unidade:  
**42313** HAPPY DAY PT/50  
F1 F4

UN: R\$ 0,46 AV: R\$ 22,86 15: R\$ 23,34  
30: R\$ 23,81 45: R\$ 24,28 60: R\$ 24,77



BALAO 11 PERA LISO AZUL CLARO 50X1  
Código: Fábrica: Unidade:  
**42315** HAPPY DAY PT/50  
F1 F4

UN: R\$ 0,46 AV: R\$ 22,86 15: R\$ 23,34  
30: R\$ 23,81 45: R\$ 24,28 60: R\$ 24,77



BALAO 11 PERA LISO AZUL ESCURO 50X1  
Código: Fábrica: Unidade:  
**42311** HAPPY DAY PT/50  
F1 F4

UN: R\$ 0,46 AV: R\$ 22,86 15: R\$ 23,34  
30: R\$ 23,81 45: R\$ 24,28 60: R\$ 24,77



BALAO 11 PERA LISO AZUL TIFFANY 50X1  
Código: Fábrica: Unidade:  
**42316** HAPPY DAY PT/50  
F1 F4

UN: R\$ 0,46 AV: R\$ 22,86 15: R\$ 23,34  
30: R\$ 23,81 45: R\$ 24,28 60: R\$ 24,77



BALAO 11 PERA LISO BRANCO 50X1  
Código: Fábrika: Unidade:  
**42337** HAPPY DAY PT/50  
F1 F4

UN: R\$ 0,46 AV: R\$ 22,86 15: R\$ 23,34  
30: R\$ 23,81 45: R\$ 24,28 60: R\$ 24,77

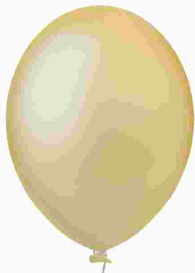

BALAO 11 PERA LISO CHAMPAGNE 50X1  
Código: Fábrika: Unidade:  
**42338** HAPPY DAY PT/50  
F1 F4

UN: R\$ 0,46 AV: R\$ 22,86 15: R\$ 23,34  
30: R\$ 23,81 45: R\$ 24,28 60: R\$ 24,77



BALAO 11 PERA LISO CORAL 50X1  
Código: Fábrika: Unidade:  
**42325** HAPPY DAY PT/50  
F1 F4

UN: R\$ 0,46 AV: R\$ 22,86 15: R\$ 23,34  
30: R\$ 23,81 45: R\$ 24,28 60: R\$ 24,77



BALAO 11 PERA LISO LARANJA 50X1  
Código: Fábrika: Unidade:  
**42324** HAPPY DAY PT/50  
F1 F4

UN: R\$ 0,46 AV: R\$ 22,86 15: R\$ 23,34  
30: R\$ 23,81 45: R\$ 24,28 60: R\$ 24,77



BALAO 11 PERA LISO LILAS 50X1  
Código: Fábrika: Unidade:  
**42339** HAPPY DAY PT/50  
F1 F4

UN: R\$ 0,46 AV: R\$ 22,86 15: R\$ 23,34  
30: R\$ 23,81 45: R\$ 24,28 60: R\$ 24,77



BALAO 11 PERA LISO MARROM 50X1  
Código: Fábrika: Unidade:  
**42333** HAPPY DAY PT/50  
F1 F4

UN: R\$ 0,46 AV: R\$ 22,86 15: R\$ 23,34  
30: R\$ 23,81 45: R\$ 24,28 60: R\$ 24,77



BALAO 11 PERA LISO MARSALA 50X1  
Código: Fábrika: Unidade:  
**42321** HAPPY DAY PT/50  
F1 F4

UN: R\$ 0,46 AV: R\$ 22,86 15: R\$ 23,34  
30: R\$ 23,81 45: R\$ 24,28 60: R\$ 24,77



BALAO 11 PERA LISO PRETO 50X1  
Código: Fábrika: Unidade:  
**42317** HAPPY DAY PT/50  
F1 F4

UN: R\$ 0,46 AV: R\$ 22,86 15: R\$ 23,34  
30: R\$ 23,81 45: R\$ 24,28 60: R\$ 24,77



BALAO 11 PERA LISO ROSA BEBE 50X1  
Código: Fábrika: Unidade:  
**42329** HAPPY DAY PT/50  
F1 F4

UN: R\$ 0,46 AV: R\$ 22,86 15: R\$ 23,34  
30: R\$ 23,81 45: R\$ 24,28 60: R\$ 24,77



BALAO 11 PERA LISO ROSA PINK 50X1  
Código: Fábrika: Unidade:  
**42327** HAPPY DAY PT/50  
F1 F4

UN: R\$ 0,46 AV: R\$ 22,86 15: R\$ 23,34  
30: R\$ 23,81 45: R\$ 24,28 60: R\$ 24,77



BALAO 11 PERA LISO ROSA 50X1  
Código: Fábrika: Unidade:  
**42322** HAPPY DAY PT/50  
F1 F4

UN: R\$ 0,46 AV: R\$ 22,86 15: R\$ 23,34  
30: R\$ 23,81 45: R\$ 24,28 60: R\$ 24,77



BALAO 11 PERA LISO SORTIDO 50X1  
Código: Fábrika: Unidade:  
**42343** HAPPY DAY PT/50  
F1 F4

UN: R\$ 0,46 AV: R\$ 22,86 15: R\$ 23,34  
30: R\$ 23,81 45: R\$ 24,28 60: R\$ 24,77

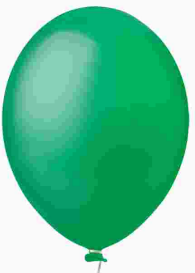

BALAO 11 PERA LISO VERDE BANDEIRA 50X1  
Código: Fábrika: Unidade:  
**42340** HAPPY DAY PT/50  
F1 F4

UN: R\$ 0,46 AV: R\$ 22,86 15: R\$ 23,34  
30: R\$ 23,81 45: R\$ 24,28 60: R\$ 24,77



BALAO 11 PERA LISO VERDE LIMAO 50X1  
Código: Fábrika: Unidade:  
**42331** HAPPY DAY PT/50  
F1 F4

UN: R\$ 0,46 AV: R\$ 22,86 15: R\$ 23,34  
30: R\$ 23,81 45: R\$ 24,28 60: R\$ 24,77



BALAO 11 PERA LISO VERDE 50X1  
Código: Fábrika: Unidade:  
**42330** HAPPY DAY PT/50  
F1 F4

UN: R\$ 0,46 AV: R\$ 22,86 15: R\$ 23,34  
30: R\$ 23,81 45: R\$ 24,28 60: R\$ 24,77



BALAO 11 PERA LISO VERMELHO PAIXAO 50X1  
Código: Fábrika: Unidade:  
**42323** HAPPY DAY PT/50  
F1 F4

UN: R\$ 0,46 AV: R\$ 22,86 15: R\$ 23,34  
30: R\$ 23,81 45: R\$ 24,28 60: R\$ 24,77



BALAO 11 PERA LISO VERMELHO 50X1

Código: **42335** Fábrica: **HAPPY DAY** Unidade: **PT/50 F1 F4**

UN: R\$ 0,46 AV: R\$ 22,86 15: R\$ 23,34  
30: R\$ 23,81 45: R\$ 24,28 60: R\$ 24,77

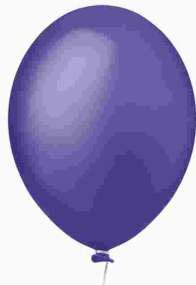

BALAO 11 PERA LISO VIOLETA 50X1

Código: **42342** Fábrica: **HAPPY DAY** Unidade: **PT/50 F1 F4**

UN: R\$ 0,72 AV: R\$ 17,96 15: R\$ 18,34  
30: R\$ 18,70 45: R\$ 19,08 60: R\$ 19,46



BALAO 11 SAFARI SORTIDO 25X1

Código: **42834** Fábrica: **HAPPY DAY** Unidade: **PT/25 F1 F4**

UN: R\$ 2,00 AV: R\$ 19,96 15: R\$ 20,37  
30: R\$ 20,78 45: R\$ 21,20 60: R\$ 21,62



BALAO 16 RED PEROLIZADO CANDY SORT 10X1

Código: **42836** Fábrica: **HAPPY DAY** Unidade: **PT/10 F1 F4**

UN: R\$ 2,23 AV: R\$ 22,26 15: R\$ 22,73  
30: R\$ 23,18 45: R\$ 23,65 60: R\$ 24,12



BALAO 16 RED LISO AMARELO 10X1

Código: **41000** Fábrica: **HAPPY DAY** Unidade: **PT/10 F1 F4**

UN: R\$ 2,30 AV: R\$ 22,95 15: R\$ 23,43  
30: R\$ 23,90 45: R\$ 24,38 60: R\$ 24,87



BALAO 16 RED LISO AZUL CLARO 10X1

Código: **40724** Fábrica: **HAPPY DAY** Unidade: **PT/10 F1 F4**

UN: R\$ 2,30 AV: R\$ 22,95 15: R\$ 23,43  
30: R\$ 23,90 45: R\$ 24,38 60: R\$ 24,87



BALAO 16 RED LISO AZUL 10X1

Código: **40722** Fábrica: **HAPPY DAY** Unidade: **PT/10 F1 F4**

UN: R\$ 2,30 AV: R\$ 22,95 15: R\$ 23,43  
30: R\$ 23,90 45: R\$ 24,38 60: R\$ 24,87



BALAO 16 RED LISO BEGE 10X1

Código: **40732** Fábrica: **HAPPY DAY** Unidade: **PT/10 F1 F4**

UN: R\$ 2,30 AV: R\$ 22,95 15: R\$ 23,43  
30: R\$ 23,90 45: R\$ 24,38 60: R\$ 24,87

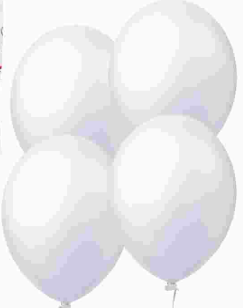

BALAO 16 RED LISO BRANCO 10X1

Código: **40721** Fábrica: **HAPPY DAY** Unidade: **PT/10 F1 F4**

UN: R\$ 2,30 AV: R\$ 22,95 15: R\$ 23,43  
30: R\$ 23,90 45: R\$ 24,38 60: R\$ 24,87

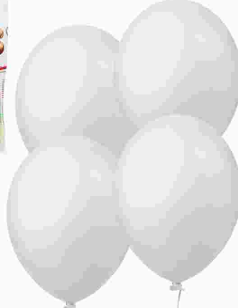

BALAO 16 RED LISO CINZA 10X1

Código: **40729** Fábrica: **HAPPY DAY** Unidade: **PT/10 F1 F4**

UN: R\$ 2,30 AV: R\$ 22,95 15: R\$ 23,43  
30: R\$ 23,90 45: R\$ 24,38 60: R\$ 24,87



BALAO 16 RED LISO CRISTAL 10X1

Código: **40731** Fábrica: **HAPPY DAY** Unidade: **PT/10 F1 F4**

UN: R\$ 2,30 AV: R\$ 22,95 15: R\$ 23,43  
30: R\$ 23,90 45: R\$ 24,38 60: R\$ 24,87

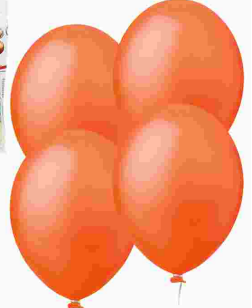

BALAO 16 RED LISO LARANJA 10X1

Código: **40728** Fábrica: **HAPPY DAY** Unidade: **PT/10 F1 F4**

UN: R\$ 2,30 AV: R\$ 22,95 15: R\$ 23,43  
30: R\$ 23,90 45: R\$ 24,38 60: R\$ 24,87



BALAO 16 RED LISO LILAS 10X1

Código: **40730** Fábrica: **HAPPY DAY** Unidade: **PT/10 F1 F4**

UN: R\$ 2,30 AV: R\$ 22,95 15: R\$ 23,43  
30: R\$ 23,90 45: R\$ 24,38 60: R\$ 24,87



BALAO 16 RED LISO PINK 10X1

Código: **40725** Fábrica: **HAPPY DAY** Unidade: **PT/10 F1 F4**

UN: R\$ 2,30 AV: R\$ 22,95 15: R\$ 23,43  
30: R\$ 23,90 45: R\$ 24,38 60: R\$ 24,87



BALAO 16 RED LISO PRETO 10X1

Código: **40723** Fábrica: **HAPPY DAY** Unidade: **PT/10 F1 F4**

UN: R\$ 2,30 AV: R\$ 22,95 15: R\$ 23,43  
30: R\$ 23,90 45: R\$ 24,38 60: R\$ 24,87

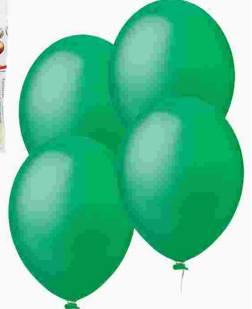

BALAO 16 RED LISO VERDE BANDEIRA 10X1

Código: **40726** Fábrica: **HAPPY DAY** Unidade: **PT/10 F1 F4**

UN: R\$ 2,30 AV: R\$ 22,95 15: R\$ 23,43  
30: R\$ 23,90 45: R\$ 24,38 60: R\$ 24,87



BALAO 16 RED LISO VERDE EUCALIPTO 10X1  
Código: Fábrika: Unidade:  
**40727** HAPPY DAY PT/10  
F1 F4

UN: R\$ 2,30 AV: R\$ 22,95 15: R\$ 23,43  
30: R\$ 23,90 45: R\$ 24,38 60: R\$ 24,87



BALAO 16 RED LISO VERMELHO 10X1  
Código: Fábrika: Unidade:  
**40733** HAPPY DAY PT/10  
F1 F4

UN: R\$ 5,98 AV: R\$ 5,98 15: R\$ 6,11  
30: R\$ 6,23 45: R\$ 6,35 60: R\$ 6,48



BANDEIRINHA PAPEL SEDA FESTA JUNINA 10MT  
Código: Fábrika: Unidade:  
**22503** ROMANA PT/1  
F1 F4

UN: R\$ 29,94 AV: R\$ 29,94 15: R\$ 30,57  
30: R\$ 31,18 45: R\$ 31,80 60: R\$ 32,44



BANDEJA RET MELAMINE 44,5X29,5CM 9951  
Código: Fábrika: Unidade:  
**49863** KEY UN/1  
F1 F4

UN: R\$ 47,91 AV: R\$ 47,91 15: R\$ 48,91  
30: R\$ 49,89 45: R\$ 50,89 60: R\$ 51,91



BANHEIRA PRATICA 20 LTS C/ESG ROSA 3738  
Código: Fábrika: Unidade:  
**18650** TRITEC UN/1  
F1 F4

UN: R\$ 9,97 AV: R\$ 9,97 15: R\$ 10,18  
30: R\$ 10,39 45: R\$ 10,59 60: R\$ 10,81



BARALHO PLASTIFICADO 1001 2X1 ESTOJO  
Código: Fábrika: Unidade:  
**21875** COPAG CX/1  
F1 F4

UN: R\$ 10,82 AV: R\$ 129,78 15: R\$ 132,49  
30: R\$ 135,14 45: R\$ 137,84 60: R\$ 140,60



BARALHO 54 CARTAS 12X1 (O MESMO 139)  
Código: Fábrika: Unidade:  
**7438** COPAG CX/12  
F1 F4

UN: R\$ 204,67 AV: R\$ 204,67 15: R\$ 208,94  
30: R\$ 213,11 45: R\$ 217,38 60: R\$ 221,72



BARRACA CAMPING 3 LUGARES SAN VALENTIN  
Código: Fábrika: Unidade:  
**48080** KALA UN/1  
F1 F4

UN: R\$ 193,68 AV: R\$ 193,68 15: R\$ 197,71  
30: R\$ 201,67 45: R\$ 205,70 60: R\$ 209,82



BARRACA DE CAMPING 2 LUGARES  
Código: Fábrika: Unidade:  
**32358** ANTARES UN/1  
F1 F4

UN: R\$ 289,53 AV: R\$ 289,53 15: R\$ 295,56  
30: R\$ 301,47 45: R\$ 307,50 60: R\$ 313,65



BARRACA DE CAMPING 3 LUGARES  
Código: Fábrika: Unidade:  
**32359** ANTARES UN/1  
F1 F4

UN: R\$ 339,45 AV: R\$ 339,45 15: R\$ 346,52  
30: R\$ 353,45 45: R\$ 360,52 60: R\$ 367,73



BARRACA DE CAMPING 4 LUGARES  
Código: Fábrika: Unidade:  
**32360** ANTARES UN/1  
F1 F4

UN: R\$ 1,55 AV: R\$ 7,74 15: R\$ 7,90  
30: R\$ 8,06 45: R\$ 8,22 60: R\$ 8,38



BATERIA 3 V LITHIUM 2032 CR2032C 5X1  
Código: Fábrika: Unidade:  
**44292** ALFACELL CR/5  
F1 F4

UN: R\$ 2,39 AV: R\$ 11,97 15: R\$ 12,22  
30: R\$ 12,46 45: R\$ 12,71 60: R\$ 12,97



BATERIA 3 V LITIO 2016 5X1  
Código: Fábrika: Unidade:  
**22511** ALFACELL CT/5  
F1 F4

UN: R\$ 2,50 AV: R\$ 12,48 15: R\$ 12,74  
30: R\$ 12,99 45: R\$ 13,25 60: R\$ 13,52



BATERIA 3 V LITIO 2025 5X1  
Código: Fábrika: Unidade:  
**15177** ALFACELL CR/5  
F1 F4

UN: R\$ 1,58 AV: R\$ 7,88 15: R\$ 8,04  
30: R\$ 8,20 45: R\$ 8,37 60: R\$ 8,53



BATERIA 3 V 1220 LITHIUM 40MAH 5X1  
Código: Fábrika: Unidade:  
**44281** ALFACELL CR/5  
F1 F4

UN: R\$ 14,97 AV: R\$ 14,97 15: R\$ 15,28  
30: R\$ 15,58 45: R\$ 15,90 60: R\$ 16,21



BATERIA 9 V ALCALINA 6LR61/1B CTL  
Código: Fábrika: Unidade:  
**42403** ALFACELL CR/1  
F1 F4

UN: R\$ 5,78 AV: R\$ 5,78 15: R\$ 5,90  
30: R\$ 6,02 45: R\$ 6,14 60: R\$ 6,26



BATERIA 9 V 6F22/1B CTL  
Código: 29372 Fábrica: ALFACELL Unidade: CR/1 F1 F4

UN: R\$ 4,33 AV: R\$ 51,91 15: R\$ 52,99  
30: R\$ 54,05 45: R\$ 55,13 60: R\$ 56,23



BATERIA 9 V 6F22/1SC 12X1  
Código: 47903 Fábrica: ALFACELL Unidade: CX/12 F1 F4

UN: R\$ 0,60 AV: R\$ 29,94 15: R\$ 30,57  
30: R\$ 31,18 45: R\$ 31,80 60: R\$ 32,44

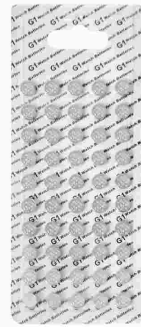

BATERIA G01 SR621/364/164/1,5V 50X1  
Código: 20624 Fábrica: RDE Unidade: PT/50 F1 F4

UN: R\$ 1,30 AV: R\$ 12,97 15: R\$ 13,24  
30: R\$ 13,50 45: R\$ 13,77 60: R\$ 14,05



BATERIA G04 377/177 SR626W 1,55V 10X1  
Código: 29370 Fábrica: ALFACELL Unidade: CR/10 F1 F4

UN: R\$ 0,60 AV: R\$ 29,94 15: R\$ 30,57  
30: R\$ 31,18 45: R\$ 31,80 60: R\$ 32,44



BATERIA G10 LR1130/379 REL AQUA 50X1  
Código: 6494 Fábrica: AG Unidade: CT/50 F1 F4

UN: R\$ 2,49 AV: R\$ 4,98 15: R\$ 5,09  
30: R\$ 5,19 45: R\$ 5,29 60: R\$ 5,40



BATERIA G13 LR44 LASER/TAMAGUCHI 1,5V 5X1  
Código: 41186 Fábrica: ALFACELL Unidade: CR/2 F1 F4

UN: R\$ 0,60 AV: R\$ 29,94 15: R\$ 30,57  
30: R\$ 31,18 45: R\$ 31,80 60: R\$ 32,44



BATERIA G13 LR44 LASER/TAMAGUCHI 1,5V 5X1  
Código: 25027 Fábrica: NR Unidade: CT/50 F1 F4

UN: R\$ 19,96 AV: R\$ 19,96 15: R\$ 20,37  
30: R\$ 20,78 45: R\$ 21,20 60: R\$ 21,62



BATERIA TELEFONE S/FIO 600MAH MO-U120  
Código: 5689 Fábrica: MOX Unidade: UN/1 F1 F4

UN: R\$ 2,99 AV: R\$ 14,97 15: R\$ 15,28  
30: R\$ 15,58 45: R\$ 15,90 60: R\$ 16,21



BATERIA 12 V ALCALINA 23A 5X1  
Código: 43250 Fábrica: ALFACELL Unidade: CR/5 F1 F4

UN: R\$ 1,50 AV: R\$ 14,97 15: R\$ 15,28  
30: R\$ 15,58 45: R\$ 15,90 60: R\$ 16,21



BATERIA 364/164/SR621SW 1,55V 10X1  
Código: 41187 Fábrica: ALFACELL Unidade: CR/10 F1 F4

UN: R\$ 2,00 AV: R\$ 19,96 15: R\$ 20,37  
30: R\$ 20,78 45: R\$ 21,20 60: R\$ 21,62



BATERIA 371 SR920SW 1,55V RELOGIO 10X1  
Código: 41188 Fábrica: ALFACELL Unidade: CR/10 F1 F4

UN: R\$ 9,49 AV: R\$ 9,49 15: R\$ 9,49  
30: R\$ 9,49 45: R\$ 9,49 60: R\$ 9,49



BICO EXTENSOR P/TORNEIRA CTL 5253  
Código: 43271 Fábrica: MEGAGIFT Unidade: CT/1 F1 F4

UN: R\$ 0,03 AV: R\$ 1,35 15: R\$ 1,38  
30: R\$ 1,40 45: R\$ 1,43 60: R\$ 1,46

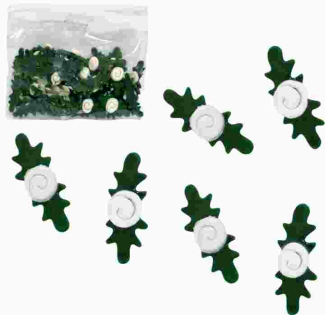

BISCUIT ROCOCO SIMPLS BRANCO 50X1  
Código: 37757 Fábrica: MINAS BRILHO Unidade: PT/50 F1 F4

UN: R\$ 0,03 AV: R\$ 1,35 15: R\$ 1,38  
30: R\$ 1,40 45: R\$ 1,43 60: R\$ 1,46



BISCUIT ROCOCO SIMPLS DOURADO 50X1  
Código: 37758 Fábrica: MINAS BRILHO Unidade: PT/50 F1 F4

UN: R\$ 0,03 AV: R\$ 1,35 15: R\$ 1,38  
30: R\$ 1,40 45: R\$ 1,43 60: R\$ 1,46



BISCUIT ROCOCO SIMPLS LARANJA 50X1  
Código: 37759 Fábrica: MINAS BRILHO Unidade: PT/50 F1 F4

UN: R\$ 0,03 AV: R\$ 1,35 15: R\$ 1,38  
30: R\$ 1,40 45: R\$ 1,43 60: R\$ 1,46



BISCUIT ROCOCO SIMPLS PRATA 50X1  
Código: 37761 Fábrica: MINAS BRILHO Unidade: PT/50 F1 F4

UN: R\$ 0,03 AV: R\$ 1,35 15: R\$ 1,38  
30: R\$ 1,40 45: R\$ 1,43 60: R\$ 1,46

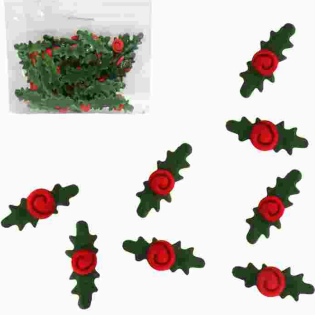

BISCUIT ROCOCO SIMPLES VERMELHO 50X1

Código: 37764 Fábrica: MINAS BRILHO Unidade: PT/50 F1 F4

UN: R\$ 0,34 AV: R\$ 33,80 15: R\$ 34,50  
30: R\$ 35,19 45: R\$ 35,89 60: R\$ 36,61



BOIA PESCA A-1 B.D 100X1

Código: 47684 Fábrica: AAL Unidade: CE/100 F1 F4

UN: R\$ 0,34 AV: R\$ 34,44 15: R\$ 35,16  
30: R\$ 35,87 45: R\$ 36,58 60: R\$ 37,31



BOIA PESCA A-2 B.D 100X1

Código: 47685 Fábrica: AAL Unidade: CE/100 F1 F4

UN: R\$ 0,48 AV: R\$ 47,91 15: R\$ 48,91  
30: R\$ 49,89 45: R\$ 50,89 60: R\$ 51,91



BOIA PESCA A-3 B.D 100X1

Código: 33213 Fábrica: AAL Unidade: CE/100 F1 F4

UN: R\$ 0,59 AV: R\$ 58,66 15: R\$ 59,88  
30: R\$ 61,08 45: R\$ 62,30 60: R\$ 63,54



BOIA PESCA A-4 B.D 100X1

Código: 33214 Fábrica: AAL Unidade: CE/100 F1 F4

UN: R\$ 0,70 AV: R\$ 69,88 15: R\$ 71,33  
30: R\$ 72,76 45: R\$ 74,22 60: R\$ 75,70



BOIA PESCA A-5 B.D 100X1

Código: 33215 Fábrica: AAL Unidade: CE/100 F1 F4

UN: R\$ 1,00 AV: R\$ 99,83 15: R\$ 101,91  
30: R\$ 103,95 45: R\$ 106,03 60: R\$ 108,15



BOIA PESCA A-6 B.D 100X1

Código: 33216 Fábrica: AAL Unidade: CE/100 F1 F4

UN: R\$ 0,75 AV: R\$ 17,96 15: R\$ 18,34  
30: R\$ 18,70 45: R\$ 19,08 60: R\$ 19,46



BOLINHA AQUA BIO GEL CRESCE NA AGUA 24X1

Código: 20312 Fábrica: CHENSON Unidade: PT/24 F1 F4

UN: R\$ 169,72 AV: R\$ 169,72 15: R\$ 173,25  
30: R\$ 176,72 45: R\$ 180,25 60: R\$ 183,86



BOLSA FEM COURO SINT AMAYRA CAFE 3123-2

Código: 42471 Fábrica: AMAYRA Unidade: UN/1 F1 F4

UN: R\$ 59,89 AV: R\$ 59,89 15: R\$ 61,14  
30: R\$ 62,36 45: R\$ 63,61 60: R\$ 64,88



BOLSA LONA ESPORTES MED GDES MARCAS

Código: 45875 Fábrica: FMM Unidade: UN/1 F1 F4

UN: R\$ 67,88 AV: R\$ 67,88 15: R\$ 69,30  
30: R\$ 70,68 45: R\$ 72,09 60: R\$ 73,54



BOLSA LONA VIAGEM GDE C/TELA 4003

Código: 5467 Fábrica: LITA Unidade: UN/1 F1 F4

UN: R\$ 68,88 AV: R\$ 68,88 15: R\$ 70,31  
30: R\$ 71,72 45: R\$ 73,16 60: R\$ 74,62



BOLSA LONA VIAGEM GG 4001

Código: 17044 Fábrica: LITA Unidade: UN/1 F1 F4

UN: R\$ 58,90 AV: R\$ 58,90 15: R\$ 60,12  
30: R\$ 61,33 45: R\$ 62,55 60: R\$ 63,80



BOLSA LONA VIAGEM MED 4007

Código: 5468 Fábrica: LITA Unidade: UN/1 F1 F4

UN: R\$ 41,92 AV: R\$ 41,92 15: R\$ 42,80  
30: R\$ 43,65 45: R\$ 44,53 60: R\$ 45,42



BOLSA LONA VIAGEM PEQ 4009

Código: 2055 Fábrica: LITA Unidade: UN/1 F1 F4

UN: R\$ 71,87 AV: R\$ 71,87 15: R\$ 73,37  
30: R\$ 74,84 45: R\$ 76,34 60: R\$ 77,86



BOLSA TIRACOLO BAG 19X14X6,5CM 0073

Código: 42477 Fábrica: MORMAII Unidade: UN/1 F1 F4

UN: R\$ 18,96 AV: R\$ 18,96 15: R\$ 19,35  
30: R\$ 19,74 45: R\$ 20,14 60: R\$ 20,54



BOLSA TRANSVERSAL COURINO GDES MARCAS

Código: 38065 Fábrica: CJL Unidade: UN/1 F1 F4

UN: R\$ 226,03 AV: R\$ 226,03 15: R\$ 230,74  
30: R\$ 235,35 45: R\$ 240,06 60: R\$ 244,86



BOLSA VIAGEM POLIESTER WILSON 021  
Código: 343679 Fábrica: WILSON Unidade: UN/1 F1 F4

UN: R\$ 15,72 AV: R\$ 15,72 15: R\$ 16,05  
30: R\$ 16,37 45: R\$ 16,70 60: R\$ 17,03



BOMBA AR MANUAL BOLA BICICLETA 30CM 719  
Código: 34058 Fábrica: COSTAVERDE Unidade: UN/1 F1 F4

UN: R\$ 26,51 AV: R\$ 26,51 15: R\$ 27,06  
30: R\$ 27,60 45: R\$ 28,15 60: R\$ 28,72



BOMBA AR MANUAL BOLA BICICLETA 56CM 717  
Código: 36444 Fábrica: COSTAVERDE Unidade: UN/1 F1 F4

UN: R\$ 28,94 AV: R\$ 28,94 15: R\$ 29,55  
30: R\$ 30,14 45: R\$ 30,74 60: R\$ 31,36



BOMBA AR MANUAL DUPLA ACAO 20CM 6 BICOS  
Código: 48342 Fábrica: CONVOY SPORT Unidade: UN/1 F1 F4

UN: R\$ 12,53 AV: R\$ 12,53 15: R\$ 12,79  
30: R\$ 13,05 45: R\$ 13,31 60: R\$ 13,57

14 cm



BOMBA AR MANUAL P/ENCHER BOLA 20CM C/ACE  
Código: 34815 Fábrica: KYRIOS Unidade: UN/1 F1 F4

UN: R\$ 12,97 AV: R\$ 12,97 15: R\$ 13,24  
30: R\$ 13,50 45: R\$ 13,77 60: R\$ 14,05



BOMBA AR MANUAL P/ENCHER BOLA 22 CM MA31  
Código: 23756 Fábrica: JK Unidade: UN/1 F1 F4

UN: R\$ 11,97 AV: R\$ 11,97 15: R\$ 12,22  
30: R\$ 12,46 45: R\$ 12,71 60: R\$ 12,97



BOMBA AR MANUAL P/ENCHER BOLA 28CM 43026  
Código: 47292 Fábrica: IMPORIENTE Unidade: UN/1 F1 F4

UN: R\$ 46,91 AV: R\$ 46,91 15: R\$ 47,89  
30: R\$ 48,85 45: R\$ 49,83 60: R\$ 50,82



BOMBA DE AR MANUAL SAC AZUL T-U  
Código: 37397 Fábrica: PENALTY Unidade: UN/1 F1 F4

UN: R\$ 6,48 AV: R\$ 6,48 15: R\$ 6,61  
30: R\$ 6,75 45: R\$ 6,88 60: R\$ 7,02



BOMBA DE AR MANUAL 16,5CM HM704  
Código: 27043 Fábrica: HOME&MORE Unidade: UN/1 F1 F4

UN: R\$ 172,71 AV: R\$ 172,71 15: R\$ 176,31  
30: R\$ 179,84 45: R\$ 183,43 60: R\$ 187,10



BOMBA ELETRICA P/BALAO 1472  
Código: 49243 Fábrica: HAI BRASIL Unidade: UN/1 F1 F4

UN: R\$ 56,90 AV: R\$ 56,90 15: R\$ 58,08  
30: R\$ 59,25 45: R\$ 60,43 60: R\$ 61,64



BOMBA P/ENCHER BOLA DUPLA ACAO METAL  
Código: 22582 Fábrica: OFF SIDE Unidade: UN/1 F1 F4

UN: R\$ 19,96 AV: R\$ 19,96 15: R\$ 20,37  
30: R\$ 20,78 45: R\$ 21,20 60: R\$ 21,62



BONE ABA CURVA GDES MARCAS  
Código: 21832 Fábrica: CJL Unidade: UN/1 F1 F4

UN: R\$ 28,99 AV: R\$ 28,99 15: R\$ 28,99  
30: R\$ 28,99 45: R\$ 28,99 60: R\$ 28,99



BONE MEIA TELA COUNTRY C/BOTTON MET 1064  
Código: 36852 Fábrica: GLX Unidade: UN/1 F1 F4

UN: R\$ 29,99 AV: R\$ 29,99 15: R\$ 29,99  
30: R\$ 29,99 45: R\$ 29,99 60: R\$ 29,99



BONE MEIA TELA COUNTRY C/BOTTON MET12033  
Código: 44473 Fábrica: GLX Unidade: UN/1 F1 F4

UN: R\$ 29,94 AV: R\$ 29,94 15: R\$ 30,57  
30: R\$ 31,18 45: R\$ 31,80 60: R\$ 32,44



BONE MEIA TELA TRUCKER COUNTRY BORD12041  
Código: 44474 Fábrica: GLX Unidade: UN/1 F1 F4

UN: R\$ 29,99 AV: R\$ 29,99 15: R\$ 29,99  
30: R\$ 29,99 45: R\$ 29,99 60: R\$ 29,99



BONE MEIA TELA TRUCKER COUNTRY CAMUFLADO  
Código: 44472 Fábrica: GLX Unidade: UN/1 F1 F4

UN: R\$ 27,99 AV: R\$ 27,99 15: R\$ 27,99  
30: R\$ 27,99 45: R\$ 27,99 60: R\$ 27,99



BONE MEIA TELA TRUCKER COUNTRY COUR12015

Código: Fábrica: Unidade:  
**44475** GLX UN/1  
F1 F4

UN: R\$ 28,99 AV: R\$ 28,99 15: R\$ 28,99  
30: R\$ 28,99 45: R\$ 28,99 60: R\$ 28,99



BONE MEIA TELA TRUCKER GOSPEL BORDA 1600

Código: Fábrica: Unidade:  
**44471** GLX UN/1  
F1 F4

UN: R\$ 7,99 AV: R\$ 7,99 15: R\$ 7,99  
30: R\$ 7,99 45: R\$ 7,99 60: R\$ 7,99



BONE TEC TEL ATLET

Código: Fábrica: Unidade:  
**17989** CJL UN/1  
F1 F4

UN: R\$ 4,33 AV: R\$ 103,83 15: R\$ 106,00  
30: R\$ 108,12 45: R\$ 110,28 60: R\$ 112,48

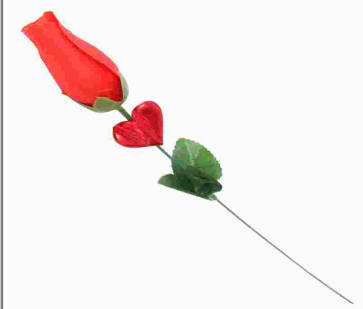

BOTAO ROSA VERMELHO CORACAO 3931 24X1

Código: Fábrica: Unidade:  
**49582** WINMAX PT/24  
F1 F4

UN: R\$ 3,68 AV: R\$ 88,36 15: R\$ 90,20  
30: R\$ 92,00 45: R\$ 93,84 60: R\$ 95,72



BOTAO ROSA VERMELHO CORACAO 3932 24X1

Código: Fábrica: Unidade:  
**36567** WINMAX PT/24  
F1 F4

UN: R\$ 4,73 AV: R\$ 179,70 15: R\$ 183,45  
30: R\$ 187,11 45: R\$ 190,86 60: R\$ 194,67



BOTAO ROSA VERMELHO LOVE 3933 38X1

Código: Fábrica: Unidade:  
**49584** WINMAX CX/38  
F1 F4

UN: R\$ 10,50 AV: R\$ 125,95 15: R\$ 128,57  
30: R\$ 131,14 45: R\$ 133,77 60: R\$ 136,44



BOTAO ROSA VERMELHO URSINHO 3936 12X1

Código: Fábrica: Unidade:  
**49583** WINMAX PT/12  
F1 F4

UN: R\$ 9,98 AV: R\$ 19,96 15: R\$ 20,37  
30: R\$ 20,78 45: R\$ 21,20 60: R\$ 21,62

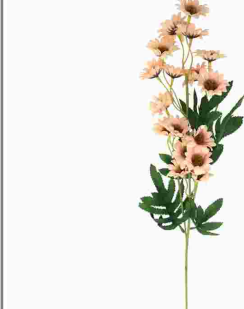

BOUQUET MINI MARGARIDA 3886 2X1

Código: Fábrica: Unidade:  
**41392** H8 RL/2  
F1 F4

UN: R\$ 4,49 AV: R\$ 4,49 15: R\$ 4,49  
30: R\$ 4,49 45: R\$ 4,49 60: R\$ 4,49



BOUQUET 4 FLORES CERJEIRA 55108 UN

Código: Fábrica: Unidade:  
**49572** ALMEGA UN/1  
F1 F4

UN: R\$ 4,49 AV: R\$ 4,49 15: R\$ 4,49  
30: R\$ 4,49 45: R\$ 4,49 60: R\$ 4,49



BOUQUET 4 FLORES COPO DE LEITE 55101 UN

Código: Fábrica: Unidade:  
**49577** ALMEGA UN/1  
F1 F4

UN: R\$ 4,49 AV: R\$ 4,49 15: R\$ 4,49  
30: R\$ 4,49 45: R\$ 4,49 60: R\$ 4,49

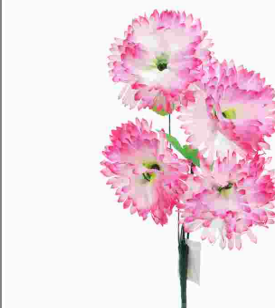

BOUQUET 4 FLORES CRAVO 55112 UN

Código: Fábrica: Unidade:  
**49578** ALMEGA UN/1  
F1 F4

UN: R\$ 4,49 AV: R\$ 4,49 15: R\$ 4,49  
30: R\$ 4,49 45: R\$ 4,49 60: R\$ 4,49

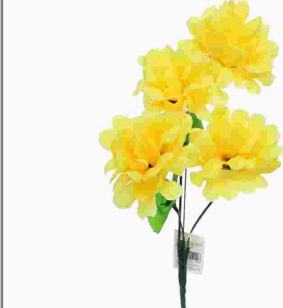

BOUQUET 4 FLORES CRISANTEMO 55111 UN

Código: Fábrica: Unidade:  
**49571** ALMEGA UN/1  
F1 F4

UN: R\$ 4,66 AV: R\$ 4,66 15: R\$ 4,76  
30: R\$ 4,85 45: R\$ 4,95 60: R\$ 5,05



BOUQUET 4 FLORES DALIA 55113 UN

Código: Fábrica: Unidade:  
**49570** ALMEGA UN/1  
F1 F4

UN: R\$ 4,49 AV: R\$ 4,49 15: R\$ 4,49  
30: R\$ 4,49 45: R\$ 4,49 60: R\$ 4,49



BOUQUET 4 FLORES GIRASSOL 55107 UN

Código: Fábrica: Unidade:  
**49576** ALMEGA UN/1  
F1 F4

UN: R\$ 4,49 AV: R\$ 4,49 15: R\$ 4,49  
30: R\$ 4,49 45: R\$ 4,49 60: R\$ 4,49

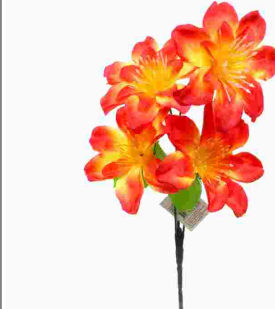

BOUQUET 4 FLORES MAGNOLIA 55106 UN

Código: Fábrica: Unidade:  
**49575** ALMEGA UN/1  
F1 F4

UN: R\$ 4,49 AV: R\$ 4,49 15: R\$ 4,49  
30: R\$ 4,49 45: R\$ 4,49 60: R\$ 4,49



BOUQUET 4 FLORES MARGARIDA 55102 UN

Código: Fábrica: Unidade:  
**49574** ALMEGA UN/1  
F1 F4

UN: R\$ 4,49 AV: R\$ 4,49 15: R\$ 4,49  
30: R\$ 4,49 45: R\$ 4,49 60: R\$ 4,49



BOUQUET 4 FLORES ROSA 55104 UN

Código: Fábrica: Unidade:  
**49573** ALMEGA UN/1  
F1 F4

UN: R\$ 9,07 AV: R\$ 108,82 15: R\$ 111,08  
30: R\$ 113,30 45: R\$ 115,57 60: R\$ 117,88



BOUQUET 5 FLORES DALIA TULE 933044 12X1

Código: Fábrica: Unidade:  
**22005** BELLA FLOR C//12  
F1 F4

UN: R\$ 8,98 AV: R\$ 35,93 15: R\$ 36,68  
30: R\$ 37,41 45: R\$ 38,16 60: R\$ 38,93



BOUQUET 5 FLORES GERBERA 212884 4X1

Código: Fábrica: Unidade:  
**41099** BELLA FLOR C//4  
F1 F4

UN: R\$ 7,98 AV: R\$ 15,96 15: R\$ 16,30  
30: R\$ 16,62 45: R\$ 16,96 60: R\$ 17,29



BOUQUET 5 FLORES GIRASSOL 911384 2X1

Código: Fábrica: Unidade:  
**41101** BELLA FLOR C//2  
F1 F4

UN: R\$ 7,98 AV: R\$ 15,96 15: R\$ 16,30  
30: R\$ 16,62 45: R\$ 16,96 60: R\$ 17,29



BOUQUET 5 FLORES MAGNOLIA 213084 2X1

Código: Fábrica: Unidade:  
**41102** BELLA FLOR PT/2  
F1 F4

UN: R\$ 4,25 AV: R\$ 50,97 15: R\$ 52,03  
30: R\$ 53,07 45: R\$ 54,13 60: R\$ 55,21

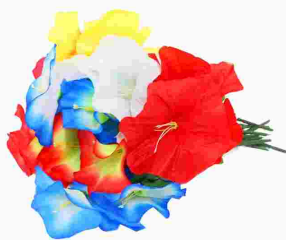

BOUQUET 5 FLORES 20191 12X1

Código: Fábrica: Unidade:  
**49564** ALIANCA PT/12  
F1 F4

UN: R\$ 4,25 AV: R\$ 50,97 15: R\$ 52,03  
30: R\$ 53,07 45: R\$ 54,13 60: R\$ 55,21



BOUQUET 5 FLORES 20193 12X1

Código: Fábrica: Unidade:  
**49565** ALIANCA PT/12  
F1 F4

UN: R\$ 4,25 AV: R\$ 50,97 15: R\$ 52,03  
30: R\$ 53,07 45: R\$ 54,13 60: R\$ 55,21



BOUQUET 5 FLORES 20194 12X1

Código: Fábrica: Unidade:  
**49566** ALIANCA PT/12  
F1 F4

UN: R\$ 0,07 AV: R\$ 6,79 15: R\$ 6,93  
30: R\$ 7,07 45: R\$ 7,21 60: R\$ 7,35



BUCHA PAREDE 6MM 100X1 5889

Código: Fábrica: Unidade:  
**38207** IDEA PT/100  
F1 F4

UN: R\$ 0,08 AV: R\$ 7,79 15: R\$ 7,95  
30: R\$ 8,11 45: R\$ 8,27 60: R\$ 8,44



BUCHA PAREDE 8MM 100X1 5885

Código: Fábrica: Unidade:  
**38206** IDEA PT/100  
F1 F4

UN: R\$ 5,99 AV: R\$ 5,99 15: R\$ 5,99  
30: R\$ 5,99 45: R\$ 5,99 60: R\$ 5,99



CABO AUDIO P2 1,5 MTS 117/962

Código: Fábrica: Unidade:  
**35977** WINMAX UN/1  
F1 F4

UN: R\$ 7,19 AV: R\$ 7,19 15: R\$ 7,34  
30: R\$ 7,49 45: R\$ 7,63 60: R\$ 7,79

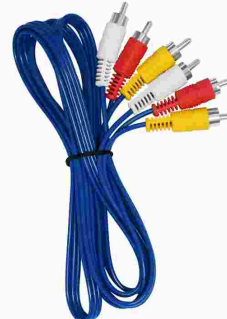

CABO AUDIO RCA2 X RCA2 1,5 MTS 1118

Código: Fábrica: Unidade:  
**40925** WINMAX UN/1  
F1 F4

UN: R\$ 17,97 AV: R\$ 17,97 15: R\$ 18,35  
30: R\$ 18,71 45: R\$ 19,09 60: R\$ 19,47



CABO CARR CELULAR USB V8 2M 1000AH

Código: Fábrica: Unidade:  
**40687** PMCELL UN/1  
F4

UN: R\$ 26,95 AV: R\$ 26,95 15: R\$ 27,51  
30: R\$ 28,06 45: R\$ 28,62 60: R\$ 29,19



CABO CARR TPC IPHONE 1,2M 30W BCO 155CI

Código: Fábrica: Unidade:  
**48448** MAKETECH UN/1  
F1 F4

UN: R\$ 13,18 AV: R\$ 13,18 15: R\$ 13,45  
30: R\$ 13,72 45: R\$ 14,00 60: R\$ 14,28



CABO CARR TRANSM DADOS USB 1M V8 5900

Código: Fábrica: Unidade:  
**41566** INOVA PT/1  
F1 F4

UN: R\$ 20,96 AV: R\$ 20,96 15: R\$ 21,39  
30: R\$ 21,82 45: R\$ 22,26 60: R\$ 22,70



CABO CARR TRANSM DADOS 1M TP C D88 74608

Código: Fábrica: Unidade:  
**43310** LETRON UN/1  
F1 F4

UN: R\$ 12,97 AV: R\$ 12,97 15: R\$ 13,24  
30: R\$ 13,50 45: R\$ 13,77 60: R\$ 14,05



CABO CARR TRANSM DADOS 1M V8 X03-1/02-1

Código: Fábrika: Unidade:  
**41039** HMASTON/GOLD UN/1  
F1 F4

UN: R\$ 11,97 AV: R\$ 11,97 15: R\$ 12,22  
30: R\$ 12,46 45: R\$ 12,71 60: R\$ 12,97



CABO CARR TRANSM DADOS 1M V8 8721

Código: Fábrika: Unidade:  
**36931** INOVA UN/1  
F1 F4

UN: R\$ 11,97 AV: R\$ 11,97 15: R\$ 12,22  
30: R\$ 12,46 45: R\$ 12,71 60: R\$ 12,97



CABO CARREG USB TPC 1,10M 2.4 6007/06

Código: Fábrika: Unidade:  
**48578** INOV/MAKETEC UN/1  
F1 F4

UN: R\$ 0,18 AV: R\$ 17,96 15: R\$ 18,34  
30: R\$ 18,70 45: R\$ 19,08 60: R\$ 19,46

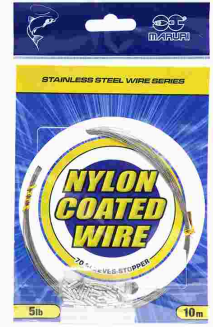

CABO DE ACO 10MTS 05 LIBRAS

Código: Fábrika: Unidade:  
**41867** MARINE CE/100  
F4

UN: R\$ 0,19 AV: R\$ 18,96 15: R\$ 19,35  
30: R\$ 19,74 45: R\$ 20,14 60: R\$ 20,54



CABO DE ACO 10MTS 20 LIBRAS

Código: Fábrika: Unidade:  
**41868** MARINE CE/100  
F4

UN: R\$ 0,20 AV: R\$ 19,96 15: R\$ 20,37  
30: R\$ 20,78 45: R\$ 21,20 60: R\$ 21,62



CABO DE ACO 10MTS 30 LIBRAS

Código: Fábrika: Unidade:  
**41870** MARINE CE/100  
F4

UN: R\$ 0,22 AV: R\$ 21,95 15: R\$ 22,41  
30: R\$ 22,86 45: R\$ 23,32 60: R\$ 23,78



CABO DE ACO 10MTS 40 LIBRAS

Código: Fábrika: Unidade:  
**41871** MARINE CE/100  
F4

UN: R\$ 0,25 AV: R\$ 24,95 15: R\$ 25,47  
30: R\$ 25,98 45: R\$ 26,50 60: R\$ 27,03



CABO DE ACO 10MTS 60 LIBRAS

Código: Fábrika: Unidade:  
**41873** MARINE CE/100  
F4

UN: R\$ 0,30 AV: R\$ 29,94 15: R\$ 30,57  
30: R\$ 31,18 45: R\$ 31,80 60: R\$ 32,44

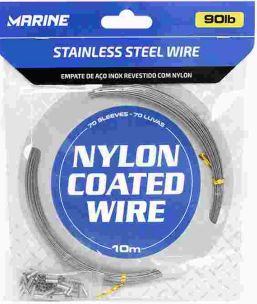

CABO DE ACO 10MTS 90 LIBRAS

Código: Fábrika: Unidade:  
**41875** MARINE CE/100  
F4

UN: R\$ 59,89 AV: R\$ 59,89 15: R\$ 61,14  
30: R\$ 62,36 45: R\$ 63,61 60: R\$ 64,88



CABO ENXERTO CHUPETA BATERIA 1000AMP 135

Código: Fábrika: Unidade:  
**31763** AIH/NAPOLES UN/1  
F1 F4

UN: R\$ 2,32 AV: R\$ 23,24 15: R\$ 23,73  
30: R\$ 24,20 45: R\$ 24,69 60: R\$ 25,18



CABO EXTENSOR CHIBIU 1,0 M PLAST 10X1

Código: Fábrika: Unidade:  
**441** TOKELASTICOS PT/10  
F1 F4

UN: R\$ 3,69 AV: R\$ 36,93 15: R\$ 37,70  
30: R\$ 38,45 45: R\$ 39,22 60: R\$ 40,01



CABO EXTENSOR CHIBIU 1,5 M PLAST 10X1

Código: Fábrika: Unidade:  
**1613** MB PT/10  
F1 F4

UN: R\$ 6,37 AV: R\$ 63,75 15: R\$ 65,08  
30: R\$ 66,38 45: R\$ 67,71 60: R\$ 69,06



CABO EXTENSOR CHIBIU 2,0 M METAL 10X1

Código: Fábrika: Unidade:  
**18644** WINMAX PT/10  
F1 F4

UN: R\$ 4,29 AV: R\$ 42,92 15: R\$ 43,82  
30: R\$ 44,69 45: R\$ 45,59 60: R\$ 46,50



CABO EXTENSOR CHIBIU 2,0 M PLAST 10X1

Código: Fábrika: Unidade:  
**1656** MB PT/10  
F1 F4

UN: R\$ 5,99 AV: R\$ 59,89 15: R\$ 61,14  
30: R\$ 62,36 45: R\$ 63,61 60: R\$ 64,88



CABO EXTENSOR CHIBIU 3,0 M PLAST 10X1

Código: Fábrika: Unidade:  
**24576** MB PT/10  
F1 F4

UN: R\$ 6,49 AV: R\$ 64,89 15: R\$ 66,24  
30: R\$ 67,56 45: R\$ 68,91 60: R\$ 70,29



CABO EXTENSOR CHIBIU 4,0 M PLAST 10X1

Código: Fábrika: Unidade:  
**24577** TOKELASTICOS PT/10  
F1 F4

UN: R\$ 13,97 AV: R\$ 13,97 15: R\$ 14,26  
30: R\$ 14,54 45: R\$ 14,83 60: R\$ 15,13



CABO HDMI 1,8MTS ENTRADA SAIDA HDMI 9367  
Código: Fábrica: Unidade:  
**26792** IDEA UN/1  
F1 F4

UN: R\$ 50,92 AV: R\$ 50,92 15: R\$ 51,98  
30: R\$ 53,02 45: R\$ 54,08 60: R\$ 55,16



CABO P/REBOQUE 4MTSX10MM 6345  
Código: Fábrica: Unidade:  
**40073** IDEA UN/1  
F1 F4

UN: R\$ 5,98 AV: R\$ 5,98 15: R\$ 6,11  
30: R\$ 6,23 45: R\$ 6,35 60: R\$ 6,48



CABO RCA DVD AUDIO VIDEO 1,5 MTS CTL 37  
Código: Fábrica: Unidade:  
**41559** ENCARTE UTIL UN/1  
F1 F4

UN: R\$ 5,09 AV: R\$ 5,09 15: R\$ 5,20  
30: R\$ 5,30 45: R\$ 5,41 60: R\$ 5,52



CABO RCA DVD AUDIO VIDEO 1,5 MTS 12232  
Código: Fábrica: Unidade:  
**22087** YF COMERCIAL UN/1  
F1 F4

UN: R\$ 4,98 AV: R\$ 4,98 15: R\$ 5,09  
30: R\$ 5,19 45: R\$ 5,29 60: R\$ 5,40



CABO RCA DVD AUDIO VIDEO 1,5 MTS 2338  
Código: Fábrica: Unidade:  
**41103** CALIMAX UN/1  
F1 F4

UN: R\$ 5,11 AV: R\$ 5,11 15: R\$ 5,22  
30: R\$ 5,32 45: R\$ 5,43 60: R\$ 5,54



CABO RCA DVD AUDIO VIDEO 1,5 MTS 963  
Código: Fábrica: Unidade:  
**27956** LIVSTAR UN/1  
F1 F4

UN: R\$ 4,99 AV: R\$ 4,99 15: R\$ 5,10  
30: R\$ 5,20 45: R\$ 5,30 60: R\$ 5,41



CADARCO 1,10MTS CORES P/TENIS PAR 56766  
Código: Fábrica: Unidade:  
**40812** BLESSED CR/1  
F1 F4

UN: R\$ 4,25 AV: R\$ 51,02 15: R\$ 52,08  
30: R\$ 53,12 45: R\$ 54,19 60: R\$ 55,27

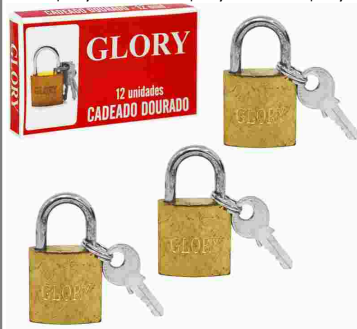

CADEADO 25 MM EMB IND 12X1  
Código: Fábrica: Unidade:  
**10533** HOSSI/GLORY CX/12  
F1 F4

UN: R\$ 5,48 AV: R\$ 5,48 15: R\$ 5,60  
30: R\$ 5,71 45: R\$ 5,82 60: R\$ 5,94



CADEADO 30 MM C/3 CHAVES EMB IND  
Código: Fábrica: Unidade:  
**43082** FELE UN/1  
F1 F4

UN: R\$ 5,78 AV: R\$ 5,78 15: R\$ 5,90  
30: R\$ 6,02 45: R\$ 6,14 60: R\$ 6,26



CADEADO 32 MM C/3 CHAVES EMB IND  
Código: Fábrica: Unidade:  
**45181** FELE UN/1  
F1 F4

UN: R\$ 14,14 AV: R\$ 84,85 15: R\$ 86,62  
30: R\$ 88,35 45: R\$ 90,12 60: R\$ 91,92



CADEADO 32 MM C/3 CHAVES EMB IND 263 6X1  
Código: Fábrica: Unidade:  
**47827** D.C.B CX/6  
F1 F4

UN: R\$ 5,98 AV: R\$ 5,98 15: R\$ 6,11  
30: R\$ 6,23 45: R\$ 6,35 60: R\$ 6,48



CADEADO 35 MM C/3 CHAVES EMB IND  
Código: Fábrica: Unidade:  
**43258** FELE UN/1  
F1 F4

UN: R\$ 6,28 AV: R\$ 6,28 15: R\$ 6,41  
30: R\$ 6,54 45: R\$ 6,67 60: R\$ 6,80



CADEADO 38 MM C/3 CHAVES EMB IND  
Código: Fábrica: Unidade:  
**35265** GLORY UN/1  
F1 F4

UN: R\$ 16,18 AV: R\$ 97,09 15: R\$ 99,12  
30: R\$ 101,10 45: R\$ 103,12 60: R\$ 105,18

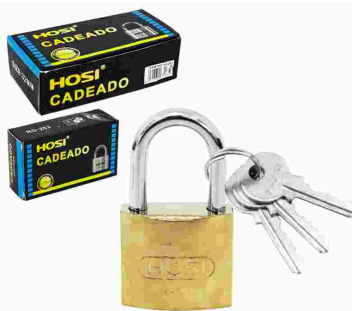

CADEADO 38 MM C/3 CHAVES EMB IND 264 6X1  
Código: Fábrica: Unidade:  
**47777** D.C.B CX/6  
F1 F4

UN: R\$ 6,48 AV: R\$ 6,48 15: R\$ 6,61  
30: R\$ 6,75 45: R\$ 6,88 60: R\$ 7,02



CADEADO 40 MM C/3 CHAVES EMB IND  
Código: Fábrica: Unidade:  
**38116** FELE UN/1  
F1 F4

UN: R\$ 28,26 AV: R\$ 169,55 15: R\$ 173,08  
30: R\$ 176,54 45: R\$ 180,07 60: R\$ 183,67



CADEADO 50 MM C/3 CHAVES EMB IND 265 6X1  
Código: Fábrica: Unidade:  
**47784** D.C.B CX/6  
F1 F4

UN: R\$ 8,99 AV: R\$ 8,99 15: R\$ 9,17  
30: R\$ 9,36 45: R\$ 9,54 60: R\$ 9,73



CADEADO 60 MM UN  
Código: Fábrika: Unidade:  
**35267** GLORY UN/1  
F1 F4

UN: R\$ 42,63 AV: R\$ 255,79 15: R\$ 261,12  
30: R\$ 266,34 45: R\$ 271,67 60: R\$ 277,10



CADEADO 63 MM C/3 CHAVES EMB IND 266 6X1  
Código: Fábrika: Unidade:  
**47835** D.C.B CX/6  
F1 F4

UN: R\$ 13,97 AV: R\$ 13,97 15: R\$ 14,26  
30: R\$ 14,54 45: R\$ 14,83 60: R\$ 15,13



CAIXA ACRILICO 19X18CM CORCAO AZUL  
Código: Fábrika: Unidade:  
**50337** QUALYPLAS UN/1  
F1 F4

UN: R\$ 13,97 AV: R\$ 13,97 15: R\$ 14,26  
30: R\$ 14,54 45: R\$ 14,83 60: R\$ 15,13

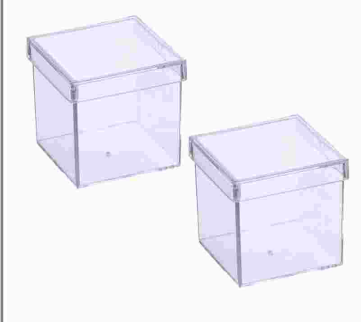

CAIXA ACRILICO 19X18CM CORCAO TRANSP  
Código: Fábrika: Unidade:  
**50336** QUALYPLAS UN/1  
F1 F4

UN: R\$ 1,40 AV: R\$ 13,97 15: R\$ 14,26  
30: R\$ 14,54 45: R\$ 14,83 60: R\$ 15,13

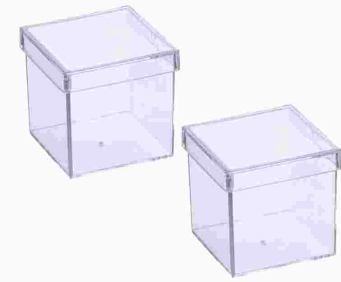

CAIXA ACRILICO 4X4 INCOLOR 1343 10X1  
Código: Fábrika: Unidade:  
**50250** MHP PT/10  
F1 F4

UN: R\$ 5,57 AV: R\$ 66,89 15: R\$ 68,29  
30: R\$ 69,65 45: R\$ 71,05 60: R\$ 72,47



CALCINHA AD MALHA 200 G ESTAMP 12X1  
Código: Fábrika: Unidade:  
**33637** LELE LULU PT/12  
F1 F4

UN: R\$ 5,57 AV: R\$ 66,89 15: R\$ 68,29  
30: R\$ 69,65 45: R\$ 71,05 60: R\$ 72,47



CALCINHA AD MALHA 200 GG ESTAMP 12X1  
Código: Fábrika: Unidade:  
**35705** LELE LULU PT/12  
F1 F4

UN: R\$ 5,57 AV: R\$ 66,89 15: R\$ 68,29  
30: R\$ 69,65 45: R\$ 71,05 60: R\$ 72,47



CALCINHA AD MALHA 200 M ESTAMP 12X1  
Código: Fábrika: Unidade:  
**33636** LELE LULU PT/12  
F1 F4

UN: R\$ 5,57 AV: R\$ 66,89 15: R\$ 68,29  
30: R\$ 69,65 45: R\$ 71,05 60: R\$ 72,47



CALCINHA AD MALHA 200 P ESTAMP 12X1  
Código: Fábrika: Unidade:  
**33635** LELE LULU PT/12  
F1 F4

UN: R\$ 5,57 AV: R\$ 66,89 15: R\$ 68,29  
30: R\$ 69,65 45: R\$ 71,05 60: R\$ 72,47



CALCINHA AD MALHA 200.1 G LISA 12X1  
Código: Fábrika: Unidade:  
**36324** LELE LULU PT/12  
F1 F4

UN: R\$ 5,57 AV: R\$ 66,89 15: R\$ 68,29  
30: R\$ 69,65 45: R\$ 71,05 60: R\$ 72,47



CALCINHA AD MALHA 200.1 GG LISA 12X1  
Código: Fábrika: Unidade:  
**36325** LELE LULU PT/12  
F1 F4

UN: R\$ 5,57 AV: R\$ 66,89 15: R\$ 68,29  
30: R\$ 69,65 45: R\$ 71,05 60: R\$ 72,47



CALCINHA AD MALHA 200.1 M LISA 12X1  
Código: Fábrika: Unidade:  
**36323** LELE LULU PT/12  
F1 F4

UN: R\$ 5,57 AV: R\$ 66,89 15: R\$ 68,29  
30: R\$ 69,65 45: R\$ 71,05 60: R\$ 72,47



CALCINHA AD MALHA 200.1 P LISA 12X1  
Código: Fábrika: Unidade:  
**36322** LELE LULU PT/12  
F1 F4

UN: R\$ 6,57 AV: R\$ 78,87 15: R\$ 80,52  
30: R\$ 82,13 45: R\$ 83,77 60: R\$ 85,45



CALCINHA INF COTTON 205 G ESTAMP 12X1  
Código: Fábrika: Unidade:  
**29544** LELE LULU PT/12  
F1 F4

UN: R\$ 6,57 AV: R\$ 78,87 15: R\$ 80,52  
30: R\$ 82,13 45: R\$ 83,77 60: R\$ 85,45



CALCINHA INF COTTON 205 G LISO 12X1  
Código: Fábrika: Unidade:  
**36328** LELE LULU PT/12  
F1 F4

UN: R\$ 6,57 AV: R\$ 78,87 15: R\$ 80,52  
30: R\$ 82,13 45: R\$ 83,77 60: R\$ 85,45



CALCINHA INF COTTON 205 GG ESTAMP 12X1  
Código: Fábrika: Unidade:  
**35703** LELE LULU PT/12  
F1 F4

UN: R\$ 6,57 AV: R\$ 78,87 15: R\$ 80,52  
30: R\$ 82,13 45: R\$ 83,77 60: R\$ 85,45



CALCINHA INF COTTON 205 GG LISA 12X1

Código: Fábrika: Unidade:  
**36329** LELE LULU PT/12  
F1 F4

UN: R\$ 6,57 AV: R\$ 78,87 15: R\$ 80,52  
30: R\$ 82,13 45: R\$ 83,77 60: R\$ 85,45



CALCINHA INF COTTON 205 M LISA 12X1

Código: Fábrika: Unidade:  
**36327** LELE LULU PT/12  
F1 F4

UN: R\$ 6,57 AV: R\$ 78,87 15: R\$ 80,52  
30: R\$ 82,13 45: R\$ 83,77 60: R\$ 85,45



CALCINHA INF COTTON 205 P ESTAMP 12X1

Código: Fábrika: Unidade:  
**29542** LELE LULU PT/12  
F1 F4

UN: R\$ 6,57 AV: R\$ 78,87 15: R\$ 80,52  
30: R\$ 82,13 45: R\$ 83,77 60: R\$ 85,45



CALCINHA INF COTTON 205 P LISA 12X1

Código: Fábrika: Unidade:  
**36326** LELE LULU PT/12  
F1 F4

UN: R\$ 5,13 AV: R\$ 61,60 15: R\$ 62,88  
30: R\$ 64,14 45: R\$ 65,43 60: R\$ 66,73



CALCINHA INF MALHA 207 GG ESTAMP 12X1

Código: Fábrika: Unidade:  
**35704** LELE LULU PT/12  
F1 F4

UN: R\$ 5,13 AV: R\$ 61,60 15: R\$ 62,88  
30: R\$ 64,14 45: R\$ 65,43 60: R\$ 66,73



CALCINHA INF MALHA 207 M ESTAMP 12X1

Código: Fábrika: Unidade:  
**7836** LELE LULU PT/12  
F1 F4

UN: R\$ 5,13 AV: R\$ 61,60 15: R\$ 62,88  
30: R\$ 64,14 45: R\$ 65,43 60: R\$ 66,73



CALCINHA INF MALHA 207 P ESTAMP 12X1

Código: Fábrika: Unidade:  
**7835** LELE LULU PT/12  
F1 F4

UN: R\$ 5,13 AV: R\$ 61,60 15: R\$ 62,88  
30: R\$ 64,14 45: R\$ 65,43 60: R\$ 66,73



CALCINHA INF MALHA 207.1 G LISA 12X1

Código: Fábrika: Unidade:  
**36318** LELE LULU PT/12  
F1 F4

UN: R\$ 5,13 AV: R\$ 61,60 15: R\$ 62,88  
30: R\$ 64,14 45: R\$ 65,43 60: R\$ 66,73



CALCINHA INF MALHA 207.1 GG LISA 12X1

Código: Fábrika: Unidade:  
**36319** LELE LULU PT/12  
F1 F4

UN: R\$ 5,13 AV: R\$ 61,60 15: R\$ 62,88  
30: R\$ 64,14 45: R\$ 65,43 60: R\$ 66,73



CALCINHA INF MALHA 207.1 M LISA 12X1

Código: Fábrika: Unidade:  
**36317** LELE LULU PT/12  
F1 F4

UN: R\$ 5,13 AV: R\$ 61,60 15: R\$ 62,88  
30: R\$ 64,14 45: R\$ 65,43 60: R\$ 66,73



CALCINHA INF MALHA 207.1 P LISA 12X1

Código: Fábrika: Unidade:  
**36316** LELE LULU PT/12  
F1 F4

UN: R\$ 8,54 AV: R\$ 51,22 15: R\$ 52,29  
30: R\$ 53,33 45: R\$ 54,40 60: R\$ 55,49



CALCOLA MALHA 201 G ESTAMP 6X1

Código: Fábrika: Unidade:  
**22011** LELE LULU PT/6  
F1 F4

UN: R\$ 8,54 AV: R\$ 51,22 15: R\$ 52,29  
30: R\$ 53,33 45: R\$ 54,40 60: R\$ 55,49



CALCOLA MALHA 201 GG ESTAMP 6X1

Código: Fábrika: Unidade:  
**22012** LELE LULU PT/6  
F1 F4

UN: R\$ 8,54 AV: R\$ 51,22 15: R\$ 52,29  
30: R\$ 53,33 45: R\$ 54,40 60: R\$ 55,49



CALCOLA MALHA 201 M ESTAMP 6X1

Código: Fábrika: Unidade:  
**22010** LELE LULU PT/6  
F1 F4

UN: R\$ 20,97 AV: R\$ 20,97 15: R\$ 21,40  
30: R\$ 21,83 45: R\$ 22,27 60: R\$ 22,71



CAMISA ATLETICO SIMPLES

Código: Fábrika: Unidade:  
**26170** CJL UN/1  
F4

UN: R\$ 49,91 AV: R\$ 49,91 15: R\$ 50,95  
30: R\$ 51,97 45: R\$ 53,01 60: R\$ 54,07



CAMPANHIA 32 MUSICAS ALCANCE 100MTS 1142

Código: Fábrika: Unidade:  
**40920** WINMAX UN/1  
F1 F4

UN: R\$ 16,50 AV: R\$ 16,50 15: R\$ 16,85  
30: R\$ 17,18 45: R\$ 17,53 60: R\$ 17,88



CANELEIRA ADULTO G 37028G

Código: Fábrica: Unidade:  
**48338** CONVOY SPORT UN/1  
F1 F4

UN: R\$ 16,50 AV: R\$ 16,50 15: R\$ 16,85  
30: R\$ 17,18 45: R\$ 17,53 60: R\$ 17,88



CANELEIRA ADULTO G 37030G

Código: Fábrica: Unidade:  
**48339** CONVOY SPORT UN/1  
F1 F4

UN: R\$ 18,35 AV: R\$ 18,35 15: R\$ 18,73  
30: R\$ 19,11 45: R\$ 19,49 60: R\$ 19,88



CANELEIRA ADULTO M 37028M

Código: Fábrica: Unidade:  
**48336** CONVOY SPORT UN/1  
F1 F4

UN: R\$ 16,12 AV: R\$ 16,12 15: R\$ 16,46  
30: R\$ 16,79 45: R\$ 17,13 60: R\$ 17,47



CANELEIRA ADULTO M 37030M

Código: Fábrica: Unidade:  
**48337** CONVOY SPORT UN/1  
F1 F4

UN: R\$ 16,12 AV: R\$ 16,12 15: R\$ 16,46  
30: R\$ 16,79 45: R\$ 17,13 60: R\$ 17,47



CANELEIRA ADULTO P 37028P

Código: Fábrica: Unidade:  
**48334** CONVOY SPORT UN/1  
F1 F4

UN: R\$ 16,12 AV: R\$ 16,12 15: R\$ 16,46  
30: R\$ 16,79 45: R\$ 17,13 60: R\$ 17,47



CANELEIRA ADULTO P 37030P

Código: Fábrica: Unidade:  
**48335** CONVOY SPORT UN/1  
F1 F4

UN: R\$ 31,94 AV: R\$ 31,94 15: R\$ 32,60  
30: R\$ 33,26 45: R\$ 33,92 60: R\$ 34,60



CANELEIRA INFANT C/TORNOZELEIRA CRISTAL

Código: Fábrica: Unidade:  
**22584** OFF SIDE UN/1  
F1 F4

UN: R\$ 3,49 AV: R\$ 3,49 15: R\$ 3,57  
30: R\$ 3,64 45: R\$ 3,71 60: R\$ 3,79



CANETA MARCA CD/DVD 7682 UN

Código: Fábrica: Unidade:  
**21579** YIN'S PAPER UN/1  
F1 F4

UN: R\$ 1,76 AV: R\$ 10,53 15: R\$ 10,75  
30: R\$ 10,97 45: R\$ 11,19 60: R\$ 11,41



CANTONEIRA FERRO REFORCO CANTO 6,5CM 6X1

Código: Fábrica: Unidade:  
**51101** BESTFER PT/6  
F1 F4

UN: R\$ 26,95 AV: R\$ 26,95 15: R\$ 27,51  
30: R\$ 28,06 45: R\$ 28,62 60: R\$ 29,19



CAPA CHUVA INF PVC CAPUZ UNISSEX 10A 31A

Código: Fábrica: Unidade:  
**22978** HIMEB UN/1  
F1 F4

UN: R\$ 24,95 AV: R\$ 24,95 15: R\$ 25,47  
30: R\$ 25,98 45: R\$ 26,50 60: R\$ 27,03



CAPA CHUVA INF PVC CAPUZ UNISSEX 6A 195A

Código: Fábrica: Unidade:  
**36450** HIMEB UN/1  
F1 F4

UN: R\$ 5,29 AV: R\$ 5,29 15: R\$ 5,40  
30: R\$ 5,51 45: R\$ 5,62 60: R\$ 5,73



CAPA CHUVA PLAST ADULTO 3057

Código: Fábrica: Unidade:  
**40772** KEY UN/1  
F1 F4

UN: R\$ 5,99 AV: R\$ 5,99 15: R\$ 6,12  
30: R\$ 6,24 45: R\$ 6,36 60: R\$ 6,49



CAPA CHUVA PLAST ADULTO 4978

Código: Fábrica: Unidade:  
**40771** KEY UN/1  
F1 F4

UN: R\$ 9,88 AV: R\$ 9,88 15: R\$ 10,09  
30: R\$ 10,29 45: R\$ 10,50 60: R\$ 10,71



CAPA CHUVA PLAST ADULTO 9210

Código: Fábrica: Unidade:  
**40769** KEY UN/1  
F1 F4

UN: R\$ 5,49 AV: R\$ 5,49 15: R\$ 5,61  
30: R\$ 5,72 45: R\$ 5,83 60: R\$ 5,95



CAPA CHUVA PLAST ADULTO 9517

Código: Fábrica: Unidade:  
**40770** KEY UN/1  
F1 F4

UN: R\$ 9,09 AV: R\$ 9,09 15: R\$ 9,27  
30: R\$ 9,46 45: R\$ 9,65 60: R\$ 9,84



CAPA PLAST IMPERMEAVEL P/CELULAR 1024

Código: Fábrica: Unidade:  
**38222** AGUIABRANCA UN/1  
F1 F4

UN: R\$ 4,98 AV: R\$ 4,98 15: R\$ 5,09  
30: R\$ 5,19 45: R\$ 5,29 60: R\$ 5,40



CAPA P/MAQUINA DIGITAL HA2005  
Código: Fábrika: Unidade:  
**14555** HAI BRASIL UN/1  
F1 F4

UN: R\$ 24,91 AV: R\$ 24,91 15: R\$ 25,43  
30: R\$ 25,94 45: R\$ 26,46 60: R\$ 26,99



CARREGADOR CELULAR TPC 1.5A XC-CP-C  
Código: Fábrika: Unidade:  
**44300** X-CELL UN/1  
F1 F4

UN: R\$ 11,83 AV: R\$ 11,83 15: R\$ 12,08  
30: R\$ 12,32 45: R\$ 12,57 60: R\$ 12,82



CARREGADOR CELULAR V8 1A BIVOLT  
Código: Fábrika: Unidade:  
**48894** DOTCELL UN/1  
F1 F4

UN: R\$ 23,06 AV: R\$ 23,06 15: R\$ 23,54  
30: R\$ 24,01 45: R\$ 24,49 60: R\$ 24,98



CARREGADOR CELULAR V8 1.5A XC-V8  
Código: Fábrika: Unidade:  
**44303** X-CELL UN/1  
F1 F4

UN: R\$ 49,91 AV: R\$ 49,91 15: R\$ 50,95  
30: R\$ 51,97 45: R\$ 53,01 60: R\$ 54,07



CARREGADOR PILHA AA/AAA/9V BIVOLT  
Código: Fábrika: Unidade:  
**23664** INOVA UN/1  
F1 F4

UN: R\$ 10,97 AV: R\$ 10,97 15: R\$ 11,20  
30: R\$ 11,43 45: R\$ 11,65 60: R\$ 11,89



CARREGADOR USB CELULAR UNIV DIGITAL 7003  
Código: Fábrika: Unidade:  
**25013** INOVA UN/1  
F1 F4

UN: R\$ 27,46 AV: R\$ 27,46 15: R\$ 28,03  
30: R\$ 28,59 45: R\$ 29,16 60: R\$ 29,74



CARREGADOR 1 USB C/FIO IPHO 12W 2,4A 191  
Código: Fábrika: Unidade:  
**48453** MAKETECH UN/1  
F1 F4

UN: R\$ 27,46 AV: R\$ 27,46 15: R\$ 28,03  
30: R\$ 28,59 45: R\$ 29,16 60: R\$ 29,74



CARREGADOR 1 USB C/FIO TPC 12W/2,4A 19C  
Código: Fábrika: Unidade:  
**48451** MAKETECH UN/1  
F1 F4

UN: R\$ 8,98 AV: R\$ 8,98 15: R\$ 9,16  
30: R\$ 9,35 45: R\$ 9,53 60: R\$ 9,72



CARREGADOR 1 USB C/FIO TPC 3.1A 8201  
Código: Fábrika: Unidade:  
**50154** INOVA UN/1  
F1 F4

UN: R\$ 13,97 AV: R\$ 13,97 15: R\$ 14,26  
30: R\$ 14,54 45: R\$ 14,83 60: R\$ 15,13



CARREGADOR 1 USB C/FIO V8 8112/8293  
Código: Fábrika: Unidade:  
**36060** INOVA UN/1  
F1 F4

UN: R\$ 24,95 AV: R\$ 24,95 15: R\$ 25,47  
30: R\$ 25,98 45: R\$ 26,50 60: R\$ 27,03



CARREGADOR 1 USB S/FIO 12W 2,4A BC 19  
Código: Fábrika: Unidade:  
**48449** MAKETECH UN/1  
F1 F4

UN: R\$ 32,20 AV: R\$ 32,20 15: R\$ 32,87  
30: R\$ 33,53 45: R\$ 34,20 60: R\$ 34,88



CARREGADOR 1 USB V8 C/FIO 2.1A 74507  
Código: Fábrika: Unidade:  
**48178** LETRON UN/1  
F1 F4

UN: R\$ 30,94 AV: R\$ 30,94 15: R\$ 31,59  
30: R\$ 32,22 45: R\$ 32,86 60: R\$ 33,52



CARREGADOR 2 USB C/FIO IPHONE 2,4A 1091  
Código: Fábrika: Unidade:  
**48454** MAKET/KNUP UN/1  
F1 F4

UN: R\$ 10,97 AV: R\$ 10,97 15: R\$ 11,20  
30: R\$ 11,43 45: R\$ 11,65 60: R\$ 11,89



CARREGADOR 2 USB C/FIO TPC 3.1A 395/9015  
Código: Fábrika: Unidade:  
**41246** INOVA UN/1  
F1 F4

UN: R\$ 17,47 AV: R\$ 17,47 15: R\$ 17,84  
30: R\$ 18,19 45: R\$ 18,56 60: R\$ 18,93



CARREGADOR 2 USB C/FIO TPC 5.1A 373/9059  
Código: Fábrika: Unidade:  
**48438** KAPB/LELONG UN/1  
F1 F4

UN: R\$ 24,95 AV: R\$ 24,95 15: R\$ 25,47  
30: R\$ 25,98 45: R\$ 26,50 60: R\$ 27,03



CARREGADOR 2 USB C/FIO V8 3.1A CA26/34  
Código: Fábrika: Unidade:  
**45156** INOVA/GOLD UN/1  
F1 F4

UN: R\$ 12,97 AV: R\$ 12,97 15: R\$ 13,24  
30: R\$ 13,50 45: R\$ 13,77 60: R\$ 14,05



CARREGADOR 2 USB C/FIO V8 4.8A 5223  
Código: 35331 Fábrica: INOVA Unidade: UN/1 F1 F4

UN: R\$ 26,95 AV: R\$ 26,95 15: R\$ 27,51  
30: R\$ 28,06 45: R\$ 28,62 60: R\$ 29,19



CARREGADOR 2 USB C/FIO V8 5.1A 233  
Código: 47939 Fábrica: LELONG Unidade: UN/1 F1 F4

UN: R\$ 15,96 AV: R\$ 15,96 15: R\$ 16,30  
30: R\$ 16,62 45: R\$ 16,96 60: R\$ 17,29



CARREGADOR 2 USB C/FIO V8 5.1A 9059/373  
Código: 48439 Fábrica: KAPBOM Unidade: UN/1 F1 F4

UN: R\$ 22,95 AV: R\$ 22,95 15: R\$ 23,43  
30: R\$ 23,90 45: R\$ 24,38 60: R\$ 24,87



CARREGADOR 2 USB S/FIO 12W 2,4A BC 109  
Código: 48452 Fábrica: MAKETECH Unidade: UN/1 F1 F4

UN: R\$ 29,94 AV: R\$ 29,94 15: R\$ 30,57  
30: R\$ 31,18 45: R\$ 31,80 60: R\$ 32,44



CARREGADOR 3 USB C/FIO TPC 5.1A 3250  
Código: 38756 Fábrica: INOVA Unidade: UN/1 F1 F4

UN: R\$ 44,92 AV: R\$ 44,92 15: R\$ 45,85  
30: R\$ 46,77 45: R\$ 47,71 60: R\$ 48,66



CARTÃO MEMÓRIA 16 GB  
Código: 49120 Fábrica: SANDISK Unidade: UN/1 F4

UN: R\$ 6,99 AV: R\$ 6,99 15: R\$ 7,13  
30: R\$ 7,28 45: R\$ 7,42 60: R\$ 7,57



CARTEIRA INF C/ZIPER CRUZ  
Código: 26710 Fábrica: NEW CELL Unidade: UN/1 F1 F4

UN: R\$ 3,98 AV: R\$ 3,98 15: R\$ 4,07  
30: R\$ 4,15 45: R\$ 4,23 60: R\$ 4,32



CARTEIRA SLIM TP COURO PORTA CARTAO/CNH  
Código: 41525 Fábrica: 3G Unidade: UN/1 F1 F4

UN: R\$ 13,97 AV: R\$ 13,97 15: R\$ 14,26  
30: R\$ 14,54 45: R\$ 14,83 60: R\$ 15,13



CARTEIRA TP COURO S/CX  
Código: 28815 Fábrica: CJL Unidade: UN/1 F1 F4

UN: R\$ 18,99 AV: R\$ 18,99 15: R\$ 18,99  
30: R\$ 18,99 45: R\$ 18,99 60: R\$ 18,99



CHAPEU AD BUCKET POLIESTER APL REF 9172  
Código: 41824 Fábrica: GLX Unidade: UN/1 F1 F4

UN: R\$ 29,42 AV: R\$ 29,42 15: R\$ 30,04  
30: R\$ 30,64 45: R\$ 31,25 60: R\$ 31,87



CHAPEU MASC FED 3906  
Código: 38341 Fábrica: IDEA Unidade: UN/1 F1 F4

UN: R\$ 6,99 AV: R\$ 6,99 15: R\$ 7,13  
30: R\$ 7,28 45: R\$ 7,42 60: R\$ 7,57



CHAPEU PAGODEIRO MALANDRINHO XADREZ  
Código: 38672 Fábrica: CJL Unidade: UN/1 F1 F4

UN: R\$ 6,99 AV: R\$ 6,99 15: R\$ 7,13  
30: R\$ 7,28 45: R\$ 7,42 60: R\$ 7,57



CHAPEU PAGODEIRO MALANDRINHO 38467-004  
Código: 38676 Fábrica: CJL Unidade: UN/1 F1 F4

UN: R\$ 23,95 AV: R\$ 23,95 15: R\$ 24,45  
30: R\$ 24,94 45: R\$ 25,44 60: R\$ 25,95



CHAPEU PALHA ANA RAI0 SIMPLES 675  
Código: 35370 Fábrica: KOPAL Unidade: UN/1 F1 F4

UN: R\$ 23,95 AV: R\$ 23,95 15: R\$ 24,45  
30: R\$ 24,94 45: R\$ 25,44 60: R\$ 25,95



CHAPEU PALHA BARUC 756  
Código: 50887 Fábrica: SAMIA Unidade: UN/1 F1 F4

UN: R\$ 5,28 AV: R\$ 5,28 15: R\$ 5,39  
30: R\$ 5,50 45: R\$ 5,61 60: R\$ 5,72



CHAPEU PALHA BONECA 621  
Código: 44456 Fábrica: KOPAL Unidade: UN/1 F1 F4

11 cm

UN: R\$ 18,96 AV: R\$ 18,96 15: R\$ 19,35  
30: R\$ 19,74 45: R\$ 20,14 60: R\$ 20,54



CHAPEU PALHA BRASÍLIA/PEROLA SIMPLES 731

Código: Fábrika: Unidade:  
**22507** SAMIA UN/1  
F1 F4

UN: R\$ 16,81 AV: R\$ 16,81 15: R\$ 17,16  
30: R\$ 17,51 45: R\$ 17,86 60: R\$ 18,21

29 cm



CHAPEU PALHA C/ RENDA FITA 700

Código: Fábrika: Unidade:  
**35031** SAMIA UN/1  
F1 F4

UN: R\$ 19,99 AV: R\$ 19,99 15: R\$ 19,99  
30: R\$ 19,99 45: R\$ 19,99 60: R\$ 19,99



CHAPEU PALHA COWBOY C/CORDAO NATURA 7508

Código: Fábrika: Unidade:  
**44478** GLX UN/1  
F1 F4

UN: R\$ 26,36 AV: R\$ 26,36 15: R\$ 26,91  
30: R\$ 27,45 45: R\$ 27,99 60: R\$ 28,55



CHAPEU PALHA COWBOY PANTANEIRO 772

Código: Fábrika: Unidade:  
**50888** SAMIA UN/1  
F1 F4

UN: R\$ 17,12 AV: R\$ 17,12 15: R\$ 17,48  
30: R\$ 17,83 45: R\$ 18,19 60: R\$ 18,55



CHAPEU PALHA C/RENDA TRANÇA 720

Código: Fábrika: Unidade:  
**17903** SAMIA UN/1  
F1 F4

UN: R\$ 8,99 AV: R\$ 8,99 15: R\$ 8,99  
30: R\$ 8,99 45: R\$ 8,99 60: R\$ 8,99



CHAPEU PALHA DESFIADO CARAVANA 715

Código: Fábrika: Unidade:  
**11435** SAMIA UN/1  
F1 F4

UN: R\$ 13,40 AV: R\$ 13,40 15: R\$ 13,68  
30: R\$ 13,95 45: R\$ 14,23 60: R\$ 14,51



CHAPEU PALHA DESFIADO CRISTAL 719

Código: Fábrika: Unidade:  
**44458** SAMIA UN/1  
F1 F4

UN: R\$ 18,36 AV: R\$ 18,36 15: R\$ 18,74  
30: R\$ 19,12 45: R\$ 19,50 60: R\$ 19,89

31 cm



CHAPEU PALHA ESTAMPADO C/TRANCAS 711

Código: Fábrika: Unidade:  
**35030** SAMIA UN/1  
F1 F4

UN: R\$ 17,12 AV: R\$ 17,12 15: R\$ 17,48  
30: R\$ 17,83 45: R\$ 18,19 60: R\$ 18,55



CHAPEU PALHA ESTAMPADO S/TRANCA 701

Código: Fábrika: Unidade:  
**44459** SAMIA UN/1  
F1 F4

UN: R\$ 18,96 AV: R\$ 18,96 15: R\$ 19,35  
30: R\$ 19,74 45: R\$ 20,14 60: R\$ 20,54



CHAPEU PALHA FEM VAZADO C/CORDINHA 504M

Código: Fábrika: Unidade:  
**44489** GLX UN/1  
F1 F4

UN: R\$ 11,97 AV: R\$ 11,97 15: R\$ 12,22  
30: R\$ 12,46 45: R\$ 12,71 60: R\$ 12,97

22 cm



CHAPEU PALHA FOFAO 622

Código: Fábrika: Unidade:  
**44457** KOPAL UN/1  
F1 F4

UN: R\$ 33,66 AV: R\$ 33,66 15: R\$ 34,36  
30: R\$ 35,04 45: R\$ 35,75 60: R\$ 36,46

63 cm



CHAPEU PALHA GIGANTE MEXICANO 734/0093

Código: Fábrika: Unidade:  
**20043** MAZA UN/1  
F1 F4

UN: R\$ 24,03 AV: R\$ 24,03 15: R\$ 24,53  
30: R\$ 25,02 45: R\$ 25,52 60: R\$ 26,03

40 cm



CHAPEU PALHA GIGANTINHO 733

Código: Fábrika: Unidade:  
**35032** SAMIA UN/1  
F1 F4

UN: R\$ 14,97 AV: R\$ 14,97 15: R\$ 15,28  
30: R\$ 15,58 45: R\$ 15,90 60: R\$ 16,21



CHAPEU PALHA MALANDRINHO 624/724

Código: Fábrika: Unidade:  
**22148** KOPAL UN/1  
F1 F4

UN: R\$ 2,59 AV: R\$ 2,59 15: R\$ 2,64  
30: R\$ 2,69 45: R\$ 2,75 60: R\$ 2,80

7 cm



CHAPEU PALHA MINIATURA 602

Código: Fábrika: Unidade:  
**44455** KOPAL UN/1  
F1 F4

UN: R\$ 26,36 AV: R\$ 26,36 15: R\$ 26,91  
30: R\$ 27,45 45: R\$ 27,99 60: R\$ 28,55



CHAPEU PALHA PANAMA PANTANEIRO 794

Código: Fábrika: Unidade:  
**50889** SAMIA UN/1  
F1 F4

UN: R\$ 18,96 AV: R\$ 18,96 15: R\$ 19,35  
30: R\$ 19,74 45: R\$ 20,14 60: R\$ 20,54



CHAPEU PALHA PANAMA SIMPLES 641

Código: Fábrika: Unidade:  
**22505** KOPAL UN/1  
F1 F4

UN: R\$ 18,96 AV: R\$ 18,96 15: R\$ 19,35  
30: R\$ 19,74 45: R\$ 20,14 60: R\$ 20,54  
■ 35 cm



CHAPEU PALHA PANAMA VENTILAD 740/640

Código: Fábrika: Unidade:  
**22508** SAMIA/KOPAL UN/1  
F1 F4

UN: R\$ 26,36 AV: R\$ 26,36 15: R\$ 26,91  
30: R\$ 27,45 45: R\$ 27,99 60: R\$ 28,55



CHAPEU PALHA PANTANEIRO KARANDA GROS 764

Código: Fábrika: Unidade:  
**40144** SAMIA UN/1  
F1 F4

UN: R\$ 31,25 AV: R\$ 31,25 15: R\$ 31,90  
30: R\$ 32,54 45: R\$ 33,19 60: R\$ 33,85  
■ 39 cm



CHAPEU PALHA PEROLA DUPLO 745

Código: Fábrika: Unidade:  
**35033** SAMIA UN/1  
F1 F4

UN: R\$ 18,96 AV: R\$ 18,96 15: R\$ 19,35  
30: R\$ 19,74 45: R\$ 20,14 60: R\$ 20,54



CHAPEU PALHA SERTANEJO G S/CORDINHA 504

Código: Fábrika: Unidade:  
**44495** GLX UN/1  
F1 F4

UN: R\$ 18,96 AV: R\$ 18,96 15: R\$ 19,35  
30: R\$ 19,74 45: R\$ 20,14 60: R\$ 20,54



CHAPEU PALHA SERTANEJO M S/CORDINHA 3184

Código: Fábrika: Unidade:  
**44494** GLX UN/1  
F1 F4

UN: R\$ 18,96 AV: R\$ 18,96 15: R\$ 19,35  
30: R\$ 19,74 45: R\$ 20,14 60: R\$ 20,54



CHAPEU PALHA SERTANEJO P C/CORDINHA 504

Código: Fábrika: Unidade:  
**44490** GLX UN/1  
F1 F4

UN: R\$ 24,03 AV: R\$ 24,03 15: R\$ 24,53  
30: R\$ 25,02 45: R\$ 25,52 60: R\$ 26,03  
■ 31 cm



CHAPEU PALHA SOCIAL SIMPLES 746

Código: Fábrika: Unidade:  
**21822** SAMIA UN/1  
F1 F4

UN: R\$ 21,64 AV: R\$ 21,64 15: R\$ 22,09  
30: R\$ 22,53 45: R\$ 22,98 60: R\$ 23,44  
■ 31 cm



CHAPEU PALHA SOCIAL VENTILADO 748

Código: Fábrika: Unidade:  
**41810** SAMIA UN/1  
F1 F4

UN: R\$ 23,95 AV: R\$ 23,95 15: R\$ 24,45  
30: R\$ 24,94 45: R\$ 25,44 60: R\$ 25,95



CHAPEU PALHA TROPEIRO AZTECA 752

Código: Fábrika: Unidade:  
**50886** SAMIA UN/1  
F1 F4

UN: R\$ 18,96 AV: R\$ 18,96 15: R\$ 19,35  
30: R\$ 19,74 45: R\$ 20,14 60: R\$ 20,54



CHAPEU PALHA TROPEIRO TEXANO SIMPLES 632

Código: Fábrika: Unidade:  
**22509** KOPAL UN/1  
F1 F4

UN: R\$ 15,97 AV: R\$ 15,97 15: R\$ 16,31  
30: R\$ 16,63 45: R\$ 16,97 60: R\$ 17,31



CHAPEU PANAMA 04-10

Código: Fábrika: Unidade:  
**36834** GLX UN/1  
F1 F4

UN: R\$ 21,95 AV: R\$ 21,95 15: R\$ 22,41  
30: R\$ 22,86 45: R\$ 23,32 60: R\$ 23,78



CHAPEU PESCADOR CAMUFLADO 7030-2

Código: Fábrika: Unidade:  
**29434** GLX UN/1  
F1 F4

UN: R\$ 13,97 AV: R\$ 13,97 15: R\$ 14,26  
30: R\$ 14,54 45: R\$ 14,83 60: R\$ 15,13



CHAPEU PESCADOR INFANTIL COLOR 9180

Código: Fábrika: Unidade:  
**41818** GLX UN/1  
F1 F4

UN: R\$ 21,95 AV: R\$ 21,95 15: R\$ 22,41  
30: R\$ 22,86 45: R\$ 23,32 60: R\$ 23,78



CHAPEU PESCADOR LISO COLOR 7032

Código: Fábrika: Unidade:  
**40487** GLX UN/1  
F1 F4

UN: R\$ 23,95 AV: R\$ 23,95 15: R\$ 24,45  
30: R\$ 24,94 45: R\$ 25,44 60: R\$ 25,95



CHAPEU PESCADOR LISO C/TELA 0431

Código: Fábrika: Unidade:  
**49870** IDEA UN/1  
F1 F4

UN: R\$ 39,93 AV: R\$ 39,93 15: R\$ 40,76  
30: R\$ 41,57 45: R\$ 42,40 60: R\$ 43,25



CHAPEU SERTANEJO COUNTRY

Código: Fábrika: Unidade:  
**28039** SERTANEJO UN/1  
F1 F4

UN: R\$ 19,96 AV: R\$ 19,96 15: R\$ 20,37  
30: R\$ 20,78 45: R\$ 21,20 60: R\$ 21,62



CHAPEU TURISTA BRASIL/COPA

Código: Fábrika: Unidade:  
**40657** CJL UN/1  
F1 F4

UN: R\$ 15,99 AV: R\$ 15,99 15: R\$ 15,99  
30: R\$ 15,99 45: R\$ 15,99 60: R\$ 15,99



CHAPEU TURISTA CORES/CAMUFLADO 7030

Código: Fábrika: Unidade:  
**22152** GLX UN/1  
F1 F4

UN: R\$ 1,08 AV: R\$ 12,98 15: R\$ 13,25  
30: R\$ 13,51 45: R\$ 13,78 60: R\$ 14,06



CHAVEIRO ACRILICO SORT DEC 671 12X1

Código: Fábrika: Unidade:  
**23671** NOVA AMIZADE PT/12  
F1 F4

UN: R\$ 6,55 AV: R\$ 104,83 15: R\$ 107,02  
30: R\$ 109,16 45: R\$ 111,34 60: R\$ 113,57



CHAVEIRO BOLAS SINUCA MINI 3862 16X1

Código: Fábrika: Unidade:  
**49645** WINMAX CX/16  
F1 F4

UN: R\$ 9,05 AV: R\$ 144,77 15: R\$ 147,78  
30: R\$ 150,74 45: R\$ 153,75 60: R\$ 156,83



CHAVEIRO BOLAS SINUCA PEQ 3861 16X1

Código: Fábrika: Unidade:  
**15903** WINMAX CX/16  
F1 F4

UN: R\$ 3,59 AV: R\$ 43,13 15: R\$ 44,03  
30: R\$ 44,91 45: R\$ 45,81 60: R\$ 46,72  
109 cm



CHAVEIRO BONECA C/TRANCAS MED 12X1

Código: Fábrika: Unidade:  
**33353** CSL DZ/12  
F1 F4

UN: R\$ 4,98 AV: R\$ 4,98 15: R\$ 5,09  
30: R\$ 5,19 45: R\$ 5,29 60: R\$ 5,40



CHAVEIRO C/CORDAO ATLET 1339

Código: Fábrika: Unidade:  
**39798** MILENO UN/1  
F1 F4

UN: R\$ 3,97 AV: R\$ 23,84 15: R\$ 24,34  
30: R\$ 24,83 45: R\$ 25,32 60: R\$ 25,83



CHAVEIRO C/CORDAO ATLET 673 6X1

Código: Fábrika: Unidade:  
**25969** NOVIDADE PT/6  
F1 F4

UN: R\$ 4,98 AV: R\$ 4,98 15: R\$ 5,09  
30: R\$ 5,19 45: R\$ 5,29 60: R\$ 5,40



CHAVEIRO C/CORDAO COLOR 1339

Código: Fábrika: Unidade:  
**39801** MILENO UN/1  
F1 F4

UN: R\$ 4,98 AV: R\$ 4,98 15: R\$ 5,09  
30: R\$ 5,19 45: R\$ 5,29 60: R\$ 5,40



CHAVEIRO C/CORDAO CRUZE 1339

Código: Fábrika: Unidade:  
**39799** MILENO UN/1  
F1 F4

UN: R\$ 3,97 AV: R\$ 23,84 15: R\$ 24,34  
30: R\$ 24,83 45: R\$ 25,32 60: R\$ 25,83



CHAVEIRO C/CORDAO CRUZE 673 6X1

Código: Fábrika: Unidade:  
**25968** NOVIDADE PT/6  
F1 F4

UN: R\$ 12,40 AV: R\$ 12,40 15: R\$ 12,66  
30: R\$ 12,91 45: R\$ 13,17 60: R\$ 13,43



CHAVEIRO METAL ABRIDOR GARRAFA 5295

Código: Fábrika: Unidade:  
**49119** BAL UN/1  
F1 F4

UN: R\$ 10,97 AV: R\$ 10,97 15: R\$ 11,20  
30: R\$ 11,43 45: R\$ 11,65 60: R\$ 11,89



CHAVEIRO METAL ALGEMAS 4679

Código: Fábrika: Unidade:  
**30593** BAL UN/1  
F1 F4

UN: R\$ 24,95 AV: R\$ 24,95 15: R\$ 25,47  
30: R\$ 25,98 45: R\$ 26,50 60: R\$ 27,03



CHAVEIRO METAL AMORTECEDOR 8909

Código: Fábrika: Unidade:  
**35008** BAL UN/1  
F1 F4

UN: R\$ 4,79 AV: R\$ 47,91 15: R\$ 48,91  
30: R\$ 49,89 45: R\$ 50,89 60: R\$ 51,91  
108 cm



CHAVEIRO METAL ANZOL A907 10X1

Código: Fábrika: Unidade:  
**32574** YING FA PT/10  
F1 F4

UN: R\$ 3,99 AV: R\$ 47,91 15: R\$ 48,91  
30: R\$ 49,89 45: R\$ 50,89 60: R\$ 51,91



CHAVEIRO METAL ARGOLA ANZOL 12X1

Código: Fábrica: Unidade:  
**25853** SQ PT/12  
F1 F4

UN: R\$ 23,95 AV: R\$ 23,95 15: R\$ 24,45  
30: R\$ 24,94 45: R\$ 25,44 60: R\$ 25,95



CHAVEIRO METAL BALA FUZIL 8223

Código: Fábrica: Unidade:  
**30601** BAL UN/1  
F1 F4

UN: R\$ 9,97 AV: R\$ 9,97 15: R\$ 10,18  
30: R\$ 10,39 45: R\$ 10,59 60: R\$ 10,81



CHAVEIRO METAL BIBLIA 764/763

Código: Fábrica: Unidade:  
**30608** BAL UN/1  
F1 F4

UN: R\$ 16,96 AV: R\$ 16,96 15: R\$ 17,32  
30: R\$ 17,66 45: R\$ 18,02 60: R\$ 18,38



CHAVEIRO METAL BOLA ATLET 8152

Código: Fábrica: Unidade:  
**30607** BAL UN/1  
F1 F4

UN: R\$ 14,97 AV: R\$ 14,97 15: R\$ 15,28  
30: R\$ 15,58 45: R\$ 15,90 60: R\$ 16,21



CHAVEIRO METAL CAO ARTICULADO 8610

Código: Fábrica: Unidade:  
**30579** BAL UN/1  
F1 F4

UN: R\$ 7,98 AV: R\$ 7,98 15: R\$ 8,14  
30: R\$ 8,31 45: R\$ 8,47 60: R\$ 8,64



CHAVEIRO METAL CAO BEAGLE 8676

Código: Fábrica: Unidade:  
**30582** BAL UN/1  
F1 F4

UN: R\$ 7,98 AV: R\$ 7,98 15: R\$ 8,14  
30: R\$ 8,31 45: R\$ 8,47 60: R\$ 8,64



CHAVEIRO METAL CAO DASCHUND 8672

Código: Fábrica: Unidade:  
**30580** BAL UN/1  
F1 F4

UN: R\$ 7,98 AV: R\$ 7,98 15: R\$ 8,14  
30: R\$ 8,31 45: R\$ 8,47 60: R\$ 8,64



CHAVEIRO METAL CAO LABRADOR 8658

Código: Fábrica: Unidade:  
**30588** BAL UN/1  
F1 F4

UN: R\$ 7,98 AV: R\$ 7,98 15: R\$ 8,14  
30: R\$ 8,31 45: R\$ 8,47 60: R\$ 8,64



CHAVEIRO METAL CAO LHASA APSO 8655

Código: Fábrica: Unidade:  
**30583** BAL UN/1  
F1 F4

UN: R\$ 7,98 AV: R\$ 7,98 15: R\$ 8,14  
30: R\$ 8,31 45: R\$ 8,47 60: R\$ 8,64



CHAVEIRO METAL CAO MALTES 8656

Código: Fábrica: Unidade:  
**30655** BAL UN/1  
F1 F4

UN: R\$ 7,98 AV: R\$ 7,98 15: R\$ 8,14  
30: R\$ 8,31 45: R\$ 8,47 60: R\$ 8,64



CHAVEIRO METAL CAO PINSCHER 8660

Código: Fábrica: Unidade:  
**30584** BAL UN/1  
F1 F4

UN: R\$ 7,98 AV: R\$ 7,98 15: R\$ 8,14  
30: R\$ 8,31 45: R\$ 8,47 60: R\$ 8,64



CHAVEIRO METAL CAO POODLE 8677/8177

Código: Fábrica: Unidade:  
**30581** BAL UN/1  
F1 F4

UN: R\$ 7,98 AV: R\$ 7,98 15: R\$ 8,14  
30: R\$ 8,31 45: R\$ 8,47 60: R\$ 8,64



CHAVEIRO METAL CAO YORKSHIRE 8673

Código: Fábrica: Unidade:  
**30586** BAL UN/1  
F1 F4

UN: R\$ 9,34 AV: R\$ 9,34 15: R\$ 9,53  
30: R\$ 9,72 45: R\$ 9,91 60: R\$ 10,11



CHAVEIRO METAL CHAPEU N S APARECID 10031

Código: Fábrica: Unidade:  
**40813** BAL UN/1  
F1 F4

UN: R\$ 8,11 AV: R\$ 8,11 15: R\$ 8,28  
30: R\$ 8,44 45: R\$ 8,61 60: R\$ 8,78



CHAVEIRO METAL CHUTEIRA BRASIL 8450

Código: Fábrica: Unidade:  
**30889** BAL UN/1  
F1 F4

UN: R\$ 11,33 AV: R\$ 11,33 15: R\$ 11,57  
30: R\$ 11,80 45: R\$ 12,04 60: R\$ 12,28



CHAVEIRO METAL COUNTRY BERRANTE 10033

Código: Fábrica: Unidade:  
**30618** BAL UN/1  
F1 F4

UN: R\$ 7,42 AV: R\$ 7,42 15: R\$ 7,57  
30: R\$ 7,72 45: R\$ 7,88 60: R\$ 8,04



CHAVEIRO METAL COUNTRY BOTA VAQUEJA 6157  
Código: Fábrica: Unidade:  
**30620** BAL UN/1  
F1 F4

UN: R\$ 11,97 AV: R\$ 11,97 15: R\$ 12,22  
30: R\$ 12,46 45: R\$ 12,71 60: R\$ 12,97



CHAVEIRO METAL COUNTRY BOTA 3776  
Código: Fábrica: Unidade:  
**30619** BAL UN/1  
F1 F4

UN: R\$ 18,96 AV: R\$ 18,96 15: R\$ 19,35  
30: R\$ 19,74 45: R\$ 20,14 60: R\$ 20,54



CHAVEIRO METAL COUNTRY CAVALO MOSQU 3667  
Código: Fábrica: Unidade:  
**30703** BAL UN/1  
F1 F4

UN: R\$ 13,97 AV: R\$ 13,97 15: R\$ 14,26  
30: R\$ 14,54 45: R\$ 14,83 60: R\$ 15,13



CHAVEIRO METAL COUNTRY CAVALO 6178  
Código: Fábrica: Unidade:  
**30457** BAL UN/1  
F1 F4

UN: R\$ 13,67 AV: R\$ 13,67 15: R\$ 13,95  
30: R\$ 14,23 45: R\$ 14,52 60: R\$ 14,81



CHAVEIRO METAL COUNTRY CELA CAVALO 9015  
Código: Fábrica: Unidade:  
**31673** BAL UN/1  
F1 F4

UN: R\$ 22,95 AV: R\$ 22,95 15: R\$ 23,43  
30: R\$ 23,90 45: R\$ 24,38 60: R\$ 24,87



CHAVEIRO METAL COUNTRY CHAPEU GDE 2830  
Código: Fábrica: Unidade:  
**35007** BAL UN/1  
F1 F4

UN: R\$ 8,98 AV: R\$ 8,98 15: R\$ 9,16  
30: R\$ 9,35 45: R\$ 9,53 60: R\$ 9,72



CHAVEIRO METAL COUNTRY ESPORA 12529  
Código: Fábrica: Unidade:  
**30415** BAL UN/1  
F1 F4

UN: R\$ 17,96 AV: R\$ 17,96 15: R\$ 18,34  
30: R\$ 18,70 45: R\$ 19,08 60: R\$ 19,46



CHAVEIRO METAL COUNTRY FERRAD CAVAL 4867  
Código: Fábrica: Unidade:  
**30416** BAL UN/1  
F1 F4

UN: R\$ 10,97 AV: R\$ 10,97 15: R\$ 11,20  
30: R\$ 11,43 45: R\$ 11,65 60: R\$ 11,89



CHAVEIRO METAL COUNTRY FERRADURA 3623  
Código: Fábrica: Unidade:  
**30417** BAL UN/1  
F1 F4

UN: R\$ 34,93 AV: R\$ 34,93 15: R\$ 35,66  
30: R\$ 36,38 45: R\$ 37,10 60: R\$ 37,84



CHAVEIRO METAL CRUCIFIXO 12769  
Código: Fábrica: Unidade:  
**35921** BAL UN/1  
F1 F4

UN: R\$ 15,96 AV: R\$ 15,96 15: R\$ 16,30  
30: R\$ 16,62 45: R\$ 16,96 60: R\$ 17,29



CHAVEIRO METAL CRUCIFIXO 139555  
Código: Fábrica: Unidade:  
**40043** BAL UN/1  
F1 F4

UN: R\$ 19,96 AV: R\$ 19,96 15: R\$ 20,37  
30: R\$ 20,78 45: R\$ 21,20 60: R\$ 21,62



CHAVEIRO METAL DIVINO ESPIRITO STO 39261  
Código: Fábrica: Unidade:  
**35920** BAL UN/1  
F1 F4

UN: R\$ 10,97 AV: R\$ 10,97 15: R\$ 11,20  
30: R\$ 11,43 45: R\$ 11,65 60: R\$ 11,89



CHAVEIRO METAL EMOJI 8611  
Código: Fábrica: Unidade:  
**30610** BAL UN/1  
F1 F4

UN: R\$ 10,97 AV: R\$ 10,97 15: R\$ 11,20  
30: R\$ 11,43 45: R\$ 11,65 60: R\$ 11,89



CHAVEIRO METAL ESCUDO FE 30107  
Código: Fábrica: Unidade:  
**30589** BAL UN/1  
F1 F4

UN: R\$ 10,42 AV: R\$ 10,42 15: R\$ 10,64  
30: R\$ 10,85 45: R\$ 11,07 60: R\$ 11,29



CHAVEIRO METAL GATO ARTICULADO 9455  
Código: Fábrica: Unidade:  
**41393** BAL UN/1  
F1 F4

UN: R\$ 7,98 AV: R\$ 7,98 15: R\$ 8,14  
30: R\$ 8,31 45: R\$ 8,47 60: R\$ 8,64



CHAVEIRO METAL GATO MEU BICHANO 8675  
Código: Fábrica: Unidade:  
**30590** BAL UN/1  
F1 F4

UN: R\$ 7,98 AV: R\$ 7,98 15: R\$ 8,14  
30: R\$ 8,31 45: R\$ 8,47 60: R\$ 8,64



CHAVEIRO METAL GATO SIAMES 8674

Código: Fábrika: Unidade:  
**30587** BAL UN/1  
F1 F4

UN: R\$ 7,98 AV: R\$ 7,98 15: R\$ 8,14  
30: R\$ 8,31 45: R\$ 8,47 60: R\$ 8,64



CHAVEIRO METAL GATO 6148

Código: Fábrika: Unidade:  
**30604** BAL UN/1  
F1 F4

UN: R\$ 18,96 AV: R\$ 18,96 15: R\$ 19,35  
30: R\$ 19,74 45: R\$ 20,14 60: R\$ 20,54



CHAVEIRO METAL GROSSO 4670

Código: Fábrika: Unidade:  
**30615** BAL UN/1  
F1 F4

UN: R\$ 16,96 AV: R\$ 16,96 15: R\$ 17,32  
30: R\$ 17,66 45: R\$ 18,02 60: R\$ 18,38



CHAVEIRO METAL GUITARRA 4860

Código: Fábrika: Unidade:  
**30598** BAL UN/1  
F1 F4

UN: R\$ 5,99 AV: R\$ 5,99 15: R\$ 6,12  
30: R\$ 6,24 45: R\$ 6,36 60: R\$ 6,49



CHAVEIRO METAL IMAGEM JESUS QUAD 4250

Código: Fábrika: Unidade:  
**30609** BAL UN/1  
F1 F4

UN: R\$ 10,97 AV: R\$ 10,97 15: R\$ 11,20  
30: R\$ 11,43 45: R\$ 11,65 60: R\$ 11,89



CHAVEIRO METAL IMAGEM JESUS RED 6231

Código: Fábrika: Unidade:  
**30627** BAL UN/1  
F1 F4

UN: R\$ 16,56 AV: R\$ 16,56 15: R\$ 16,91  
30: R\$ 17,25 45: R\$ 17,59 60: R\$ 17,94



CHAVEIRO METAL IMAGEM N S APAREC 13188

Código: Fábrika: Unidade:  
**30702** BAL UN/1  
F1 F4

UN: R\$ 9,31 AV: R\$ 9,31 15: R\$ 9,50  
30: R\$ 9,69 45: R\$ 9,88 60: R\$ 10,08



CHAVEIRO METAL IMAGEM N S APAREC 10054

Código: Fábrika: Unidade:  
**39923** BAL UN/1  
F1 F4

UN: R\$ 12,73 AV: R\$ 12,73 15: R\$ 12,99  
30: R\$ 13,25 45: R\$ 13,52 60: R\$ 13,79



CHAVEIRO METAL IMAGEM N S APARECID 10061

Código: Fábrika: Unidade:  
**42566** BAL UN/1  
F1 F4

UN: R\$ 15,96 AV: R\$ 15,96 15: R\$ 16,30  
30: R\$ 16,62 45: R\$ 16,96 60: R\$ 17,29



CHAVEIRO METAL IMAGEM N S APARECID 10096

Código: Fábrika: Unidade:  
**40046** BAL UN/1  
F1 F4

UN: R\$ 16,47 AV: R\$ 16,47 15: R\$ 16,82  
30: R\$ 17,15 45: R\$ 17,50 60: R\$ 17,85



CHAVEIRO METAL IMAGEM N S APARECID 5287

Código: Fábrika: Unidade:  
**40041** BAL UN/1  
F1 F4

UN: R\$ 12,73 AV: R\$ 12,73 15: R\$ 12,99  
30: R\$ 13,25 45: R\$ 13,52 60: R\$ 13,79



CHAVEIRO METAL IMAGEM N S APARECID 9909

Código: Fábrika: Unidade:  
**48433** BAL UN/1  
F1 F4

UN: R\$ 11,97 AV: R\$ 11,97 15: R\$ 12,22  
30: R\$ 12,46 45: R\$ 12,71 60: R\$ 12,97



CHAVEIRO METAL IMAGEM N S APARECIDA 9188

Código: Fábrika: Unidade:  
**33097** BAL UN/1  
F1 F4

UN: R\$ 8,99 AV: R\$ 8,99 15: R\$ 9,17  
30: R\$ 9,36 45: R\$ 9,54 60: R\$ 9,73



CHAVEIRO METAL IMAGEM N S APARECIDA 9247

Código: Fábrika: Unidade:  
**40042** BAL UN/1  
F1 F4

UN: R\$ 4,99 AV: R\$ 4,99 15: R\$ 5,10  
30: R\$ 5,20 45: R\$ 5,30 60: R\$ 5,41



CHAVEIRO METAL LEME 12748

Código: Fábrika: Unidade:  
**31405** BAL UN/1  
F1 F4

UN: R\$ 9,97 AV: R\$ 9,97 15: R\$ 10,18  
30: R\$ 10,39 45: R\$ 10,59 60: R\$ 10,81



CHAVEIRO METAL MACONARIA 8832/130013

Código: Fábrika: Unidade:  
**30628** BAL UN/1  
F1 F4

UN: R\$ 15,96 AV: R\$ 15,96 15: R\$ 16,30  
30: R\$ 16,62 45: R\$ 16,96 60: R\$ 17,29



CHAVEIRO METAL MANGALARGA MARCHADOR 8183

Código: Fábrica: Unidade:  
**30414** BAL UN/1  
F1 F4

UN: R\$ 13,97 AV: R\$ 13,97 15: R\$ 14,26  
30: R\$ 14,54 45: R\$ 14,83 60: R\$ 15,13



CHAVEIRO METAL MARCAS CARROS VW 9284

Código: Fábrica: Unidade:  
**35767** BAL UN/1  
F1 F4

UN: R\$ 15,96 AV: R\$ 15,96 15: R\$ 16,30  
30: R\$ 16,62 45: R\$ 16,96 60: R\$ 17,29



CHAVEIRO METAL PISTAO E BIELA 13422

Código: Fábrica: Unidade:  
**30626** BAL UN/1  
F1 F4

UN: R\$ 6,47 AV: R\$ 6,47 15: R\$ 6,60  
30: R\$ 6,74 45: R\$ 6,87 60: R\$ 7,01



CHAVEIRO METAL PLACA FRASES 13

Código: Fábrica: Unidade:  
**35916** BAL UN/1  
F1 F4

UN: R\$ 7,58 AV: R\$ 7,58 15: R\$ 7,74  
30: R\$ 7,89 45: R\$ 8,05 60: R\$ 8,21



CHAVEIRO METAL PLACA RES I LOVE BH 9941

Código: Fábrica: Unidade:  
**43080** BAL UN/1  
F1 F4

UN: R\$ 6,98 AV: R\$ 6,98 15: R\$ 7,12  
30: R\$ 7,27 45: R\$ 7,41 60: R\$ 7,56



CHAVEIRO METAL PROFISSAO ADMINISTRACAO

Código: Fábrica: Unidade:  
**36064** BAL UN/1  
F1 F4

UN: R\$ 6,44 AV: R\$ 6,44 15: R\$ 6,57  
30: R\$ 6,71 45: R\$ 6,84 60: R\$ 6,98



CHAVEIRO METAL PROFISSAO ARQUIT URBANISMO

Código: Fábrica: Unidade:  
**36080** BAL UN/1  
F1 F4

UN: R\$ 6,44 AV: R\$ 6,44 15: R\$ 6,57  
30: R\$ 6,71 45: R\$ 6,84 60: R\$ 6,98



CHAVEIRO METAL PROFISSAO CHEFF 13

Código: Fábrica: Unidade:  
**36067** BAL UN/1  
F1 F4

UN: R\$ 6,44 AV: R\$ 6,44 15: R\$ 6,57  
30: R\$ 6,71 45: R\$ 6,84 60: R\$ 6,98



CHAVEIRO METAL PROFISSAO CIENCIAS CONTAB

Código: Fábrica: Unidade:  
**36078** BAL UN/1  
F1 F4

UN: R\$ 6,98 AV: R\$ 6,98 15: R\$ 7,12  
30: R\$ 7,27 45: R\$ 7,41 60: R\$ 7,56



CHAVEIRO METAL PROFISSAO DIREITO 13

Código: Fábrica: Unidade:  
**36071** BAL UN/1  
F1 F4

UN: R\$ 6,44 AV: R\$ 6,44 15: R\$ 6,57  
30: R\$ 6,71 45: R\$ 6,84 60: R\$ 6,98



CHAVEIRO METAL PROFISSAO EDUCACAO FISICA

Código: Fábrica: Unidade:  
**36072** BAL UN/1  
F1 F4

UN: R\$ 6,98 AV: R\$ 6,98 15: R\$ 7,12  
30: R\$ 7,27 45: R\$ 7,41 60: R\$ 7,56



CHAVEIRO METAL PROFISSAO ENFERMAGEM 13

Código: Fábrica: Unidade:  
**36070** BAL UN/1  
F1 F4

UN: R\$ 6,44 AV: R\$ 6,44 15: R\$ 6,57  
30: R\$ 6,71 45: R\$ 6,84 60: R\$ 6,98



CHAVEIRO METAL PROFISSAO ENGENH MECANICA

Código: Fábrica: Unidade:  
**36079** BAL UN/1  
F1 F4

UN: R\$ 6,44 AV: R\$ 6,44 15: R\$ 6,57  
30: R\$ 6,71 45: R\$ 6,84 60: R\$ 6,98



CHAVEIRO METAL PROFISSAO ENGENHAR CIVIL

Código: Fábrica: Unidade:  
**36065** BAL UN/1  
F1 F4

UN: R\$ 6,98 AV: R\$ 6,98 15: R\$ 7,12  
30: R\$ 7,27 45: R\$ 7,41 60: R\$ 7,56



CHAVEIRO METAL PROFISSAO FARMACIA 13

Código: Fábrica: Unidade:  
**36074** BAL UN/1  
F1 F4

UN: R\$ 6,98 AV: R\$ 6,98 15: R\$ 7,12  
30: R\$ 7,27 45: R\$ 7,41 60: R\$ 7,56



CHAVEIRO METAL PROFISSAO FISIOTERAPIA 13

Código: Fábrica: Unidade:  
**36077** BAL UN/1  
F1 F4

UN: R\$ 6,44 AV: R\$ 6,44 15: R\$ 6,57  
30: R\$ 6,71 45: R\$ 6,84 60: R\$ 6,98



CHAVEIRO METAL PROFISSAO MED VETERINARIA  
Código: Fábrika: Unidade:  
**36069** BAL UN/1  
F1 F4

UN: R\$ 6,98 AV: R\$ 6,98 15: R\$ 7,12  
30: R\$ 7,27 45: R\$ 7,41 60: R\$ 7,56



CHAVEIRO METAL PROFISSAO MEDICINA 13  
Código: Fábrika: Unidade:  
**36075** BAL UN/1  
F1 F4

UN: R\$ 6,44 AV: R\$ 6,44 15: R\$ 6,57  
30: R\$ 6,71 45: R\$ 6,84 60: R\$ 6,98



CHAVEIRO METAL PROFISSAO NUTRICA0 13  
Código: Fábrika: Unidade:  
**36063** BAL UN/1  
F1 F4

UN: R\$ 6,98 AV: R\$ 6,98 15: R\$ 7,12  
30: R\$ 7,27 45: R\$ 7,41 60: R\$ 7,56



CHAVEIRO METAL PROFISSAO ODONTOLOGIA 13  
Código: Fábrika: Unidade:  
**36076** BAL UN/1  
F1 F4

UN: R\$ 6,98 AV: R\$ 6,98 15: R\$ 7,12  
30: R\$ 7,27 45: R\$ 7,41 60: R\$ 7,56



CHAVEIRO METAL PROFISSAO PEDAGOGIA 13  
Código: Fábrika: Unidade:  
**36073** BAL UN/1  
F1 F4

UN: R\$ 6,44 AV: R\$ 6,44 15: R\$ 6,57  
30: R\$ 6,71 45: R\$ 6,84 60: R\$ 6,98



CHAVEIRO METAL PROFISSAO POLICE 13  
Código: Fábrika: Unidade:  
**36066** BAL UN/1  
F1 F4

UN: R\$ 6,98 AV: R\$ 6,98 15: R\$ 7,12  
30: R\$ 7,27 45: R\$ 7,41 60: R\$ 7,56



CHAVEIRO METAL PROFISSAO PSICOLOGIA 13  
Código: Fábrika: Unidade:  
**36068** BAL UN/1  
F1 F4

UN: R\$ 16,96 AV: R\$ 16,96 15: R\$ 17,32  
30: R\$ 17,66 45: R\$ 18,02 60: R\$ 18,38



CHAVEIRO METAL REVOLVER MAGNUM 6235  
Código: Fábrika: Unidade:  
**30592** BAL UN/1  
F1 F4

UN: R\$ 17,96 AV: R\$ 17,96 15: R\$ 18,34  
30: R\$ 18,70 45: R\$ 19,08 60: R\$ 19,46



CHAVEIRO METAL REVOLVER 38 8942  
Código: Fábrika: Unidade:  
**30591** BAL UN/1  
F1 F4

UN: R\$ 7,98 AV: R\$ 7,98 15: R\$ 8,14  
30: R\$ 8,31 45: R\$ 8,47 60: R\$ 8,64



CHAVEIRO METAL RODA CHUMBO 941  
Código: Fábrika: Unidade:  
**39323** BAL UN/1  
F1 F4

UN: R\$ 8,99 AV: R\$ 8,99 15: R\$ 9,17  
30: R\$ 9,36 45: R\$ 9,54 60: R\$ 9,73



CHAVEIRO METAL SANTO ANJO AZUL 9288  
Código: Fábrika: Unidade:  
**40044** BAL UN/1  
F1 F4

UN: R\$ 8,99 AV: R\$ 8,99 15: R\$ 9,17  
30: R\$ 9,36 45: R\$ 9,54 60: R\$ 9,73



CHAVEIRO METAL SANTO ANJO ROSA 9288  
Código: Fábrika: Unidade:  
**40045** BAL UN/1  
F1 F4

UN: R\$ 17,96 AV: R\$ 17,96 15: R\$ 18,34  
30: R\$ 18,70 45: R\$ 19,08 60: R\$ 19,46



CHAVEIRO METAL SAO JORGE 92110  
Código: Fábrika: Unidade:  
**33152** BAL UN/1  
F1 F4

UN: R\$ 6,44 AV: R\$ 6,44 15: R\$ 6,57  
30: R\$ 6,71 45: R\$ 6,84 60: R\$ 6,98



CHAVEIRO METAL SIGNOS AQUARIO 17  
Código: Fábrika: Unidade:  
**35912** BAL UN/1  
F1 F4

UN: R\$ 6,44 AV: R\$ 6,44 15: R\$ 6,57  
30: R\$ 6,71 45: R\$ 6,84 60: R\$ 6,98



CHAVEIRO METAL SIGNOS CANCER 17  
Código: Fábrika: Unidade:  
**35905** BAL UN/1  
F1 F4

UN: R\$ 6,44 AV: R\$ 6,44 15: R\$ 6,57  
30: R\$ 6,71 45: R\$ 6,84 60: R\$ 6,98



CHAVEIRO METAL SIGNOS ESCORPIAO 17  
Código: Fábrika: Unidade:  
**35909** BAL UN/1  
F1 F4

UN: R\$ 6,44 AV: R\$ 6,44 15: R\$ 6,57  
30: R\$ 6,71 45: R\$ 6,84 60: R\$ 6,98



CHAVEIRO METAL SIGNOS GEMEOS 17  
Código: Fábrica: Unidade:  
**35904** BAL UN/1  
F1 F4

UN: R\$ 6,44 AV: R\$ 6,44 15: R\$ 6,57  
30: R\$ 6,71 45: R\$ 6,84 60: R\$ 6,98



CHAVEIRO METAL SIGNOS LEO 17  
Código: Fábrica: Unidade:  
**35906** BAL UN/1  
F1 F4

UN: R\$ 6,44 AV: R\$ 6,44 15: R\$ 6,57  
30: R\$ 6,71 45: R\$ 6,84 60: R\$ 6,98



CHAVEIRO METAL SIGNOS LIBRA 17  
Código: Fábrica: Unidade:  
**35908** BAL UN/1  
F1 F4

UN: R\$ 6,44 AV: R\$ 6,44 15: R\$ 6,57  
30: R\$ 6,71 45: R\$ 6,84 60: R\$ 6,98



CHAVEIRO METAL SIGNOS PEIXES 17  
Código: Fábrica: Unidade:  
**35913** BAL UN/1  
F1 F4

UN: R\$ 6,44 AV: R\$ 6,44 15: R\$ 6,57  
30: R\$ 6,71 45: R\$ 6,84 60: R\$ 6,98



CHAVEIRO METAL SIGNOS TOURO 17  
Código: Fábrica: Unidade:  
**35903** BAL UN/1  
F1 F4

UN: R\$ 29,94 AV: R\$ 29,94 15: R\$ 30,57  
30: R\$ 31,18 45: R\$ 31,80 60: R\$ 32,44



CHAVEIRO METAL TURBINA CARRO 8834  
Código: Fábrica: Unidade:  
**30621** BAL UN/1  
F1 F4

UN: R\$ 9,97 AV: R\$ 9,97 15: R\$ 10,18  
30: R\$ 10,39 45: R\$ 10,59 60: R\$ 10,81



CHAVEIRO METAL VAZADO 4966  
Código: Fábrica: Unidade:  
**30616** BAL UN/1  
F1 F4

UN: R\$ 6,44 AV: R\$ 6,44 15: R\$ 6,57  
30: R\$ 6,71 45: R\$ 6,84 60: R\$ 6,98



CHAVEIRO METAL VERS BIBLICOS RED 1095  
Código: Fábrica: Unidade:  
**30623** BAL UN/1  
F1 F4

UN: R\$ 4,99 AV: R\$ 4,99 15: R\$ 5,10  
30: R\$ 5,20 45: R\$ 5,30 60: R\$ 5,41



CHAVEIRO METAL VERS BIBLICOS 1096  
Código: Fábrica: Unidade:  
**30617** BAL UN/1  
F1 F4

UN: R\$ 1,99 AV: R\$ 23,84 15: R\$ 24,34  
30: R\$ 24,83 45: R\$ 25,32 60: R\$ 25,83



CHAVEIRO MINI LANTERNA 1 LED 3858 12X1  
Código: Fábrica: Unidade:  
**49614** WINMAX DZ/12  
F1 F4

UN: R\$ 2,66 AV: R\$ 31,94 15: R\$ 32,60  
30: R\$ 33,26 45: R\$ 33,92 60: R\$ 34,60



CHAVEIRO MOSQUETAO METAL MALER 908 12X1  
Código: Fábrica: Unidade:  
**20911** YING FA DZ/12  
F1 F4

UN: R\$ 1,20 AV: R\$ 11,98 15: R\$ 12,23  
30: R\$ 12,48 45: R\$ 12,72 60: R\$ 12,98



CHAVEIRO PLAST BRASIL 10X1  
Código: Fábrica: Unidade:  
**37642** KEY CHAIN PT/10  
F1 F4

UN: R\$ 3,49 AV: R\$ 3,49 15: R\$ 3,57  
30: R\$ 3,64 45: R\$ 3,71 60: R\$ 3,79



CHAVEIRO PLAST NARUTO GDE  
Código: Fábrica: Unidade:  
**37643** KEY CHAIN UN/1  
F4

UN: R\$ 1,20 AV: R\$ 11,98 15: R\$ 12,23  
30: R\$ 12,48 45: R\$ 12,72 60: R\$ 12,98



CHAVEIRO PLAST PANDA KEY GHAIN 10X1  
Código: Fábrica: Unidade:  
**37649** KEY CHAIN PT/10  
F1 F4

UN: R\$ 1,20 AV: R\$ 11,98 15: R\$ 12,23  
30: R\$ 12,48 45: R\$ 12,72 60: R\$ 12,98



CHAVEIRO PLAST SAPO 10X1  
Código: Fábrica: Unidade:  
**37641** KEY CHAIN PT/10  
F1 F4

UN: R\$ 0,99 AV: R\$ 0,99 15: R\$ 1,01  
30: R\$ 1,03 45: R\$ 1,05 60: R\$ 1,07



CHAVEIRO UN  
Código: Fábrica: Unidade:  
**42344** BAL UN/1  
F1 F4

UN: R\$ 8,32 AV: R\$ 99,83 15: R\$ 101,91  
30: R\$ 103,95 45: R\$ 106,03 60: R\$ 108,15



CHINELO AD MASC BCO QUIK 34A44 841 12X1

Código: Fábrika: Unidade:  
**29132** PIATA PT/12  
F1 F4

UN: R\$ 13,28 AV: R\$ 13,28 15: R\$ 13,56  
30: R\$ 13,83 45: R\$ 14,10 60: R\$ 14,39



CHINELO ANATOMIC SURF 37/38 PRETO 25122

Código: Fábrika: Unidade:  
**37798** IPANEMA UN/1  
F1 F4

UN: R\$ 13,28 AV: R\$ 13,28 15: R\$ 13,56  
30: R\$ 13,83 45: R\$ 14,10 60: R\$ 14,39



CHINELO ANATOMIC SURF 39/40 AZUL 25122

Código: Fábrika: Unidade:  
**37795** IPANEMA UN/1  
F1 F4

UN: R\$ 13,28 AV: R\$ 13,28 15: R\$ 13,56  
30: R\$ 13,83 45: R\$ 14,10 60: R\$ 14,39



CHINELO ANATOMIC SURF 39/40 PRETO 25122

Código: Fábrika: Unidade:  
**37799** IPANEMA UN/1  
F1 F4

UN: R\$ 13,28 AV: R\$ 13,28 15: R\$ 13,56  
30: R\$ 13,83 45: R\$ 14,10 60: R\$ 14,39



CHINELO ANATOMIC SURF 41/42 AZUL 25122

Código: Fábrika: Unidade:  
**37796** IPANEMA UN/1  
F1 F4

UN: R\$ 13,28 AV: R\$ 13,28 15: R\$ 13,56  
30: R\$ 13,83 45: R\$ 14,10 60: R\$ 14,39



CHINELO ANATOMIC SURF 41/42 PRETO 25122

Código: Fábrika: Unidade:  
**37800** IPANEMA UN/1  
F1 F4

UN: R\$ 13,28 AV: R\$ 13,28 15: R\$ 13,56  
30: R\$ 13,83 45: R\$ 14,10 60: R\$ 14,39



CHINELO ANATOMIC SURF 43/44 AZUL 25122

Código: Fábrika: Unidade:  
**37797** IPANEMA UN/1  
F1 F4

UN: R\$ 13,28 AV: R\$ 13,28 15: R\$ 13,56  
30: R\$ 13,83 45: R\$ 14,10 60: R\$ 14,39



CHINELO ANATOMIC SURF 43/44 PRETO 25122

Código: Fábrika: Unidade:  
**37801** IPANEMA UN/1  
F1 F4

UN: R\$ 199,67 AV: R\$ 199,67 15: R\$ 203,83  
30: R\$ 207,91 45: R\$ 212,06 60: R\$ 216,31



CHUMBADA ARROZINHO 1 KG

Código: Fábrika: Unidade:  
**50001** FALCAO KG/1  
F1 F4

UN: R\$ 59,89 AV: R\$ 59,89 15: R\$ 61,14  
30: R\$ 62,36 45: R\$ 63,61 60: R\$ 64,88



CHUMBADA OLIVA N 00 1 KG

Código: Fábrika: Unidade:  
**13621** FALCAO KG/1  
F1 F4

UN: R\$ 49,91 AV: R\$ 49,91 15: R\$ 50,95  
30: R\$ 51,97 45: R\$ 53,01 60: R\$ 54,07



CHUMBADA OLIVA N 01 1 KG

Código: Fábrika: Unidade:  
**13612** FALCAO KG/1  
F1 F4

UN: R\$ 49,91 AV: R\$ 49,91 15: R\$ 50,95  
30: R\$ 51,97 45: R\$ 53,01 60: R\$ 54,07



CHUMBADA OLIVA N 02 1 KG

Código: Fábrika: Unidade:  
**13613** FALCAO KG/1  
F1 F4

UN: R\$ 49,91 AV: R\$ 49,91 15: R\$ 50,95  
30: R\$ 51,97 45: R\$ 53,01 60: R\$ 54,07



CHUMBADA OLIVA N 03 1 KG

Código: Fábrika: Unidade:  
**13614** FALCAO KG/1  
F1 F4

UN: R\$ 49,91 AV: R\$ 49,91 15: R\$ 50,95  
30: R\$ 51,97 45: R\$ 53,01 60: R\$ 54,07



CHUMBADA OLIVA N 04 1 KG

Código: Fábrika: Unidade:  
**13615** FALCAO KG/1  
F1 F4

UN: R\$ 49,91 AV: R\$ 49,91 15: R\$ 50,95  
30: R\$ 51,97 45: R\$ 53,01 60: R\$ 54,07



CHUMBADA OLIVA N 05 1 KG

Código: Fábrika: Unidade:  
**13617** FALCAO KG/1  
F1 F4

UN: R\$ 49,91 AV: R\$ 49,91 15: R\$ 50,95  
30: R\$ 51,97 45: R\$ 53,01 60: R\$ 54,07



CHUMBADA OLIVA N 06 1 KG

Código: Fábrika: Unidade:  
**13618** FALCAO KG/1  
F1 F4

UN: R\$ 49,91 AV: R\$ 49,91 15: R\$ 50,95  
30: R\$ 51,97 45: R\$ 53,01 60: R\$ 54,07



CHUMBADA OLIVA N 07 1 KG

Código: Fábrika: Unidade:  
**13619** FALCAO KG/1  
F1 F4

UN: R\$ 49,91 AV: R\$ 49,91 15: R\$ 50,95  
30: R\$ 51,97 45: R\$ 53,01 60: R\$ 54,07



CHUMBADA OLIVA N 08 1 KG

Código: Fábrika: Unidade:  
**13620** FALCAO KG/1  
F1 F4

UN: R\$ 0,10 AV: R\$ 12,97 15: R\$ 13,24  
30: R\$ 13,50 45: R\$ 13,77 60: R\$ 14,05



CHUMBINHO 5.5 DIABOLO 125X1

Código: Fábrika: Unidade:  
**28954** FALCAO CX/125  
F1 F4

UN: R\$ 2,41 AV: R\$ 28,94 15: R\$ 29,55  
30: R\$ 30,14 45: R\$ 30,74 60: R\$ 31,36



CHUVEIRINHO P/TORNEIRA 1022 12X1

Código: Fábrika: Unidade:  
**28868** JWC/MARINI DZ/12  
F1 F4

UN: R\$ 20,96 AV: R\$ 20,96 15: R\$ 21,39  
30: R\$ 21,82 45: R\$ 22,26 60: R\$ 22,70



CINTO COURO SINT CATRACA METALIC 8613/17

Código: Fábrika: Unidade:  
**44484** GLX UN/1  
F1 F4

UN: R\$ 20,96 AV: R\$ 20,96 15: R\$ 21,39  
30: R\$ 21,82 45: R\$ 22,26 60: R\$ 22,70



CINTO COURO SINT FIVELA METALICA 8006

Código: Fábrika: Unidade:  
**44486** GLX UN/1  
F1 F4

UN: R\$ 20,96 AV: R\$ 20,96 15: R\$ 21,39  
30: R\$ 21,82 45: R\$ 22,26 60: R\$ 22,70



CINTO POLIESTER CATRACA METALICA 8605

Código: Fábrika: Unidade:  
**44481** GLX UN/1  
F1 F4

UN: R\$ 20,96 AV: R\$ 20,96 15: R\$ 21,39  
30: R\$ 21,82 45: R\$ 22,26 60: R\$ 22,70

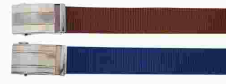

CINTO POLIESTER CATRACA METALICA 8611

Código: Fábrika: Unidade:  
**44483** GLX UN/1  
F1 F4

UN: R\$ 18,96 AV: R\$ 18,96 15: R\$ 19,35  
30: R\$ 19,74 45: R\$ 20,14 60: R\$ 20,54

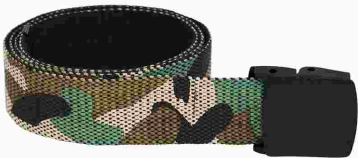

CINTO POLIESTER FIV PLAST CAMUFL 1223 UN

Código: Fábrika: Unidade:  
**50000** GLX UN/1  
F1 F4

UN: R\$ 15,96 AV: R\$ 15,96 15: R\$ 16,30  
30: R\$ 16,62 45: R\$ 16,96 60: R\$ 17,29



CINTO POLIESTER FIVELA METALICA 8609

Código: Fábrika: Unidade:  
**44482** GLX UN/1  
F1 F4

UN: R\$ 14,14 AV: R\$ 169,72 15: R\$ 173,25  
30: R\$ 176,72 45: R\$ 180,25 60: R\$ 183,86



CINTO RASPA COURO SEM COSTURA 12X1

Código: Fábrika: Unidade:  
**17712** CJL PT/12  
F1 F4

UN: R\$ 17,96 AV: R\$ 17,96 15: R\$ 18,34  
30: R\$ 18,70 45: R\$ 19,08 60: R\$ 19,46



CINTO SOCIAL C/CX

Código: Fábrika: Unidade:  
**17131** STREETMAN UN/1  
F1 F4

UN: R\$ 10,85 AV: R\$ 10,85 15: R\$ 11,08  
30: R\$ 11,30 45: R\$ 11,53 60: R\$ 11,76



COFRE GESSO DEC PORCO GDE

Código: Fábrika: Unidade:  
**50166** ASJ UN/1  
F1 F4

UN: R\$ 6,98 AV: R\$ 6,98 15: R\$ 7,12  
30: R\$ 7,27 45: R\$ 7,41 60: R\$ 7,56



COFRE MADEIRA 15CM BOTAFO

Código: Fábrika: Unidade:  
**42263** FEG UN/1  
F1 F4

UN: R\$ 6,98 AV: R\$ 6,98 15: R\$ 7,12  
30: R\$ 7,27 45: R\$ 7,41 60: R\$ 7,56



COFRE MADEIRA 15CM INF FEM

Código: Fábrika: Unidade:  
**36720** FEG UN/1  
F1 F4

UN: R\$ 6,98 AV: R\$ 6,98 15: R\$ 7,12  
30: R\$ 7,27 45: R\$ 7,41 60: R\$ 7,56



COFRE MADEIRA 15CM TIME SANTOS

Código: Fábrika: Unidade:  
**44104** FEG UN/1  
F1 F4

UN: R\$ 6,98 AV: R\$ 6,98 15: R\$ 7,12  
30: R\$ 7,27 45: R\$ 7,41 60: R\$ 7,56



COFRE MADEIRA 15CM VASC

Código: Fábrika: Unidade:  
**42265** FEG UN/1  
F1 F4

UN: R\$ 6,68 AV: R\$ 6,68 15: R\$ 6,82  
30: R\$ 6,95 45: R\$ 7,09 60: R\$ 7,24



COFRE PLAST BOTAJO MED 9298

Código: Fábrika: Unidade:  
**37371** PLASTSANDRI UN/1  
F1 F4

UN: R\$ 16,47 AV: R\$ 16,47 15: R\$ 16,82  
30: R\$ 17,15 45: R\$ 17,50 60: R\$ 17,85



COIFA DE CAMBIO ACESS VEICULOS YT-5

Código: Fábrika: Unidade:  
**33022** HAI BRASIL CR/1  
F1 F4

UN: R\$ 10,97 AV: R\$ 10,97 15: R\$ 11,20  
30: R\$ 11,43 45: R\$ 11,65 60: R\$ 11,89



COLA ADESIVA DE CONTATO 30 GRS 41 CTL

Código: Fábrika: Unidade:  
**49522** FORTCONTACTO UN/1  
F1 F4

UN: R\$ 5,98 AV: R\$ 5,98 15: R\$ 6,11  
30: R\$ 6,23 45: R\$ 6,35 60: R\$ 6,48



COLA ADESIVO INSTANT 5 GRS CTL UN

Código: Fábrika: Unidade:  
**45282** 7 BOND UN/1  
F1 F4

UN: R\$ 6,98 AV: R\$ 6,98 15: R\$ 7,12  
30: R\$ 7,27 45: R\$ 7,41 60: R\$ 7,56



COLA ADESIVO INSTANT 17 GRS UN

Código: Fábrika: Unidade:  
**46173** 7 BOND UN/1  
F1 F4

UN: R\$ 8,78 AV: R\$ 87,85 15: R\$ 89,68  
30: R\$ 91,47 45: R\$ 93,30 60: R\$ 95,17



COLA ADESIVO INSTANT 20 GRS 200 10X1

Código: Fábrika: Unidade:  
**38183** 7 BOND CX/10  
F1 F4

UN: R\$ 7,23 AV: R\$ 72,30 15: R\$ 73,81  
30: R\$ 75,29 45: R\$ 76,79 60: R\$ 78,33



COLA ADESIVO INSTANT 20 GRS 40329 10X1

Código: Fábrika: Unidade:  
**48583** REND BOND CX/10  
F1 F4

UN: R\$ 28,95 AV: R\$ 289,53 15: R\$ 295,56  
30: R\$ 301,47 45: R\$ 307,50 60: R\$ 313,65



COLA ADESIVO INSTANT 100 GRS 793 10X1

Código: Fábrika: Unidade:  
**44356** 7 BOND CX/10  
F1 F4

UN: R\$ 12,98 AV: R\$ 129,78 15: R\$ 132,49  
30: R\$ 135,14 45: R\$ 137,84 60: R\$ 140,60



COLA EPOXI BICOMP EXT FORT 16GR CTL 10X1

Código: Fábrika: Unidade:  
**44357** 7 BOND CX/10  
F1 F4

UN: R\$ 5,98 AV: R\$ 5,98 15: R\$ 6,11  
30: R\$ 6,23 45: R\$ 6,35 60: R\$ 6,48

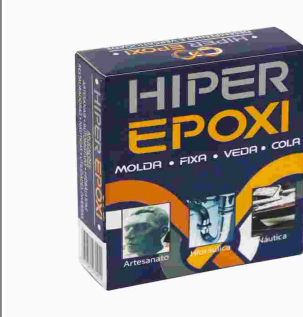

COLA HIPER EPOXI 50 GRS (TIPO DUREPOXI)

Código: Fábrika: Unidade:  
**34754** HIPER EPOXI UN/1  
F1 F4

UN: R\$ 9,97 AV: R\$ 9,97 15: R\$ 10,18  
30: R\$ 10,39 45: R\$ 10,59 60: R\$ 10,81



COLA HIPER EPOXI 100 GRS (TIPO DUREPOXI)

Código: Fábrika: Unidade:  
**7807** HIPER EPOXI UN/1  
F1 F4

UN: R\$ 59,89 AV: R\$ 59,89 15: R\$ 61,14  
30: R\$ 62,36 45: R\$ 63,61 60: R\$ 64,88



CONJ 6 XICARAS CAFE C/PIRES ACR CRISTAL

Código: Fábrika: Unidade:  
**50338** QUALYPLAS CX/1  
F1 F4

UN: R\$ 19,96 AV: R\$ 19,96 15: R\$ 20,37  
30: R\$ 20,78 45: R\$ 21,20 60: R\$ 21,62



CONJUNTO TESOURA INOX CB PLAST 8208 4X1

Código: Fábrika: Unidade:  
**43583** IDEA UN/1  
F1 F4

UN: R\$ 7,98 AV: R\$ 7,98 15: R\$ 8,14  
30: R\$ 8,31 45: R\$ 8,47 60: R\$ 8,64



CONTROLE REMOTO TV GRADIENTE 8114/29A

Código: Fábrika: Unidade:  
**24222** HAI BRASIL UN/1  
F1 F4

UN: R\$ 7,98 AV: R\$ 7,98 15: R\$ 8,14  
30: R\$ 8,31 45: R\$ 8,47 60: R\$ 8,64



CONTROLE REMOTO TV MITSUBISHI 8122

Código: Fábrika: Unidade:  
**17544** HAI BRASIL UN/1  
F1 F4

UN: R\$ 7,98 AV: R\$ 7,98 15: R\$ 8,14  
30: R\$ 8,31 45: R\$ 8,47 60: R\$ 8,64



CONTROLE REMOTO TV MITSUBISHI HA-053A  
Código: Fábrika: Unidade:  
**21600** IMPORTADO UN/1  
F1 F4

UN: R\$ 7,98 AV: R\$ 7,98 15: R\$ 8,14  
30: R\$ 8,31 45: R\$ 8,47 60: R\$ 8,64



CONTROLE REMOTO TV SHARP 8126/7122/3112  
Código: Fábrika: Unidade:  
**24226** IDEA UN/1  
F1 F4

UN: R\$ 5,85 AV: R\$ 5,85 15: R\$ 5,97  
30: R\$ 6,09 45: R\$ 6,21 60: R\$ 6,34



CORANTE LIQ 50 ML AMARELO  
Código: Fábrika: Unidade:  
**50741** TEK BOND UN/1  
F1 F4

UN: R\$ 5,85 AV: R\$ 5,85 15: R\$ 5,97  
30: R\$ 6,09 45: R\$ 6,21 60: R\$ 6,34



CORANTE LIQ 50 ML AZUL  
Código: Fábrika: Unidade:  
**50740** TEK BOND UN/1  
F1 F4

UN: R\$ 5,85 AV: R\$ 5,85 15: R\$ 5,97  
30: R\$ 6,09 45: R\$ 6,21 60: R\$ 6,34



CORANTE LIQ 50 ML BRANCO  
Código: Fábrika: Unidade:  
**50738** TEK BOND UN/1  
F1 F4

UN: R\$ 5,85 AV: R\$ 5,85 15: R\$ 5,97  
30: R\$ 6,09 45: R\$ 6,21 60: R\$ 6,34



CORANTE LIQ 50 ML LARANJA  
Código: Fábrika: Unidade:  
**50745** TEK BOND UN/1  
F1 F4

UN: R\$ 5,85 AV: R\$ 5,85 15: R\$ 5,97  
30: R\$ 6,09 45: R\$ 6,21 60: R\$ 6,34



CORANTE LIQ 50 ML MARROM  
Código: Fábrika: Unidade:  
**50747** TEK BOND UN/1  
F1 F4

UN: R\$ 5,85 AV: R\$ 5,85 15: R\$ 5,97  
30: R\$ 6,09 45: R\$ 6,21 60: R\$ 6,34



CORANTE LIQ 50 ML OCRE  
Código: Fábrika: Unidade:  
**50746** TEK BOND UN/1  
F1 F4

UN: R\$ 5,85 AV: R\$ 5,85 15: R\$ 5,97  
30: R\$ 6,09 45: R\$ 6,21 60: R\$ 6,34



CORANTE LIQ 50 ML PRETO  
Código: Fábrika: Unidade:  
**50739** TEK BOND UN/1  
F1 F4

UN: R\$ 5,85 AV: R\$ 5,85 15: R\$ 5,97  
30: R\$ 6,09 45: R\$ 6,21 60: R\$ 6,34



CORANTE LIQ 50 ML VERDE  
Código: Fábrika: Unidade:  
**50743** TEK BOND UN/1  
F1 F4

UN: R\$ 5,85 AV: R\$ 5,85 15: R\$ 5,97  
30: R\$ 6,09 45: R\$ 6,21 60: R\$ 6,34



CORANTE LIQ 50 ML VERMELHO  
Código: Fábrika: Unidade:  
**50742** TEK BOND UN/1  
F1 F4

UN: R\$ 5,85 AV: R\$ 5,85 15: R\$ 5,97  
30: R\$ 6,09 45: R\$ 6,21 60: R\$ 6,34



CORANTE LIQ 50 ML VIOLETA  
Código: Fábrika: Unidade:  
**50744** TEK BOND UN/1  
F1 F4

UN: R\$ 2,91 AV: R\$ 69,88 15: R\$ 71,33  
30: R\$ 72,76 45: R\$ 74,22 60: R\$ 75,70



CORDA ACO VIOLAO 1 MI R-501-201 24X1  
Código: Fábrika: Unidade:  
**37353** ROUXINOL PT/24  
F1 F4

UN: R\$ 3,12 AV: R\$ 74,87 15: R\$ 76,43  
30: R\$ 77,96 45: R\$ 79,52 60: R\$ 81,11



CORDA ACO VIOLAO 2 SI R-502 24X1  
Código: Fábrika: Unidade:  
**37354** ROUXINOL PT/24  
F1 F4

UN: R\$ 4,37 AV: R\$ 52,42 15: R\$ 53,51  
30: R\$ 54,58 45: R\$ 55,67 60: R\$ 56,78



CORDA ACO VIOLAO 3 SOL R-503 12X1  
Código: Fábrika: Unidade:  
**36271** ROUXINOL PT/12  
F1 F4

UN: R\$ 127,79 AV: R\$ 127,79 15: R\$ 130,45  
30: R\$ 133,06 45: R\$ 135,72 60: R\$ 138,43



CORTADOR ELETRICO DE ISOPOR USB 110V  
Código: Fábrika: Unidade:  
**50203** VONDER UN/1  
F1 F4

UN: R\$ 2,58 AV: R\$ 30,94 15: R\$ 31,59  
30: R\$ 32,22 45: R\$ 32,86 60: R\$ 33,52



CORTADOR UNHA DISCO C/CORRENTE 398 12X1

Código: Fábrika: Unidade:  
**39983** PLANETA CR/12  
F1 F4

UN: R\$ 1,50 AV: R\$ 17,96 15: R\$ 18,34  
30: R\$ 18,70 45: R\$ 19,08 60: R\$ 19,46



CORTADOR UNHA PEQ C/CORRENTE CTL 07 12X1

Código: Fábrika: Unidade:  
**50789** HOME&MORE CR/12  
F1 F4

UN: R\$ 11,31 AV: R\$ 33,94 15: R\$ 34,64  
30: R\$ 35,34 45: R\$ 36,04 60: R\$ 36,76



CUECA AD ALGODAO C/ELAST N01 G 3X1

Código: Fábrika: Unidade:  
**22472** NAWES PT/3  
F1 F4

UN: R\$ 11,31 AV: R\$ 33,94 15: R\$ 34,64  
30: R\$ 35,34 45: R\$ 36,04 60: R\$ 36,76



CUECA AD ALGODAO C/ELAST N01 GG 3X1

Código: Fábrika: Unidade:  
**28164** NAWES PT/3  
F1 F4

UN: R\$ 11,31 AV: R\$ 33,94 15: R\$ 34,64  
30: R\$ 35,34 45: R\$ 36,04 60: R\$ 36,76



CUECA AD ALGODAO C/ELAST N01 M 3X1

Código: Fábrika: Unidade:  
**18843** NAWES PT/3  
F1 F4

UN: R\$ 11,31 AV: R\$ 33,94 15: R\$ 34,64  
30: R\$ 35,34 45: R\$ 36,04 60: R\$ 36,76



CUECA AD ALGODAO C/ELAST N01/2/59 P 3X1

Código: Fábrika: Unidade:  
**18844** NAWES PT/3  
F1 F4

UN: R\$ 10,87 AV: R\$ 32,60 15: R\$ 33,28  
30: R\$ 33,94 45: R\$ 34,62 60: R\$ 35,31



CUECA AD ALGODAO N02 G 3X1

Código: Fábrika: Unidade:  
**20352** NAWES PT/3  
F1 F4

UN: R\$ 10,87 AV: R\$ 32,60 15: R\$ 33,28  
30: R\$ 33,94 45: R\$ 34,62 60: R\$ 35,31



CUECA AD ALGODAO N02 GG 3X1

Código: Fábrika: Unidade:  
**25051** NAWES PT/3  
F1 F4

UN: R\$ 10,87 AV: R\$ 32,60 15: R\$ 33,28  
30: R\$ 33,94 45: R\$ 34,62 60: R\$ 35,31



CUECA AD ALGODAO N02 M 3X1

Código: Fábrika: Unidade:  
**20353** NAWES PT/3  
F1 F4

UN: R\$ 10,87 AV: R\$ 32,60 15: R\$ 33,28  
30: R\$ 33,94 45: R\$ 34,62 60: R\$ 35,31



CUECA AD ALGODAO N02 P 3X1

Código: Fábrika: Unidade:  
**6918** NAWES PT/3  
F1 F4

UN: R\$ 14,56 AV: R\$ 174,72 15: R\$ 178,36  
30: R\$ 181,93 45: R\$ 185,57 60: R\$ 189,28



CUECA AD BOXER ALGODAO LISO N15 G 12X1

Código: Fábrika: Unidade:  
**39720** NAWES PT/12  
F1 F4

UN: R\$ 14,56 AV: R\$ 174,72 15: R\$ 178,36  
30: R\$ 181,93 45: R\$ 185,57 60: R\$ 189,28



CUECA AD BOXER ALGODAO LISO N15 GG 12X1

Código: Fábrika: Unidade:  
**39721** NAWES PT/12  
F1 F4

UN: R\$ 14,56 AV: R\$ 174,72 15: R\$ 178,36  
30: R\$ 181,93 45: R\$ 185,57 60: R\$ 189,28



CUECA AD BOXER ALGODAO LISO N15 M 12X1

Código: Fábrika: Unidade:  
**39719** NAWES PT/12  
F1 F4

UN: R\$ 14,56 AV: R\$ 174,72 15: R\$ 178,36  
30: R\$ 181,93 45: R\$ 185,57 60: R\$ 189,28



CUECA AD BOXER ALGODAO LISO N15 P 12X1

Código: Fábrika: Unidade:  
**39718** NAWES PT/12  
F1 F4

UN: R\$ 20,89 AV: R\$ 41,78 15: R\$ 42,65  
30: R\$ 43,51 45: R\$ 44,38 60: R\$ 45,26



CUECA AD BOXER ALGODAO LISO N27 GG 2X1

Código: Fábrika: Unidade:  
**39717** NAWES PT/2  
F1 F4

UN: R\$ 14,56 AV: R\$ 174,72 15: R\$ 178,36  
30: R\$ 181,93 45: R\$ 185,57 60: R\$ 189,28



CUECA AD BOXER ALGODAO LISTR N15 G 12X1

Código: Fábrika: Unidade:  
**39724** NAWES PT/12  
F1 F4

UN: R\$ 14,56 AV: R\$ 174,72 15: R\$ 178,36  
30: R\$ 181,93 45: R\$ 185,57 60: R\$ 189,28



CUECA AD BOXER ALGODAO LISTR N15 GG 12X1  
Código: Fábrika: Unidade:  
**39725** NAWES PT/12  
F1 F4

UN: R\$ 14,56 AV: R\$ 174,72 15: R\$ 178,36  
30: R\$ 181,93 45: R\$ 185,57 60: R\$ 189,28



CUECA AD BOXER ALGODAO LISTR N15 M 12X1  
Código: Fábrika: Unidade:  
**39723** NAWES PT/12  
F1 F4

UN: R\$ 14,56 AV: R\$ 174,72 15: R\$ 178,36  
30: R\$ 181,93 45: R\$ 185,57 60: R\$ 189,28



CUECA AD BOXER ALGODAO LISTR N15 P 12X1  
Código: Fábrika: Unidade:  
**39722** NAWES PT/12  
F1 F4

UN: R\$ 19,96 AV: R\$ 39,93 15: R\$ 40,76  
30: R\$ 41,57 45: R\$ 42,40 60: R\$ 43,25



CUECA AD BOXER ALGODAO N27 G 2X1  
Código: Fábrika: Unidade:  
**39716** NAWES PT/2  
F1 F4

UN: R\$ 19,96 AV: R\$ 39,93 15: R\$ 40,76  
30: R\$ 41,57 45: R\$ 42,40 60: R\$ 43,25



CUECA AD BOXER ALGODAO N27 M 2X1  
Código: Fábrika: Unidade:  
**39715** NAWES PT/2  
F1 F4

UN: R\$ 19,96 AV: R\$ 39,93 15: R\$ 40,76  
30: R\$ 41,57 45: R\$ 42,40 60: R\$ 43,25



CUECA AD BOXER ALGODAO N27 P 2X1  
Código: Fábrika: Unidade:  
**39714** NAWES PT/2  
F1 F4

UN: R\$ 10,78 AV: R\$ 10,78 15: R\$ 11,01  
30: R\$ 11,23 45: R\$ 11,45 60: R\$ 11,68



CUECA AD BOXER ALGODAO P 030/007  
Código: Fábrika: Unidade:  
**20350** KELLPS/MACHY UN/1  
F1 F4

UN: R\$ 11,23 AV: R\$ 11,23 15: R\$ 11,47  
30: R\$ 11,70 45: R\$ 11,93 60: R\$ 12,17



CUECA AD BOXER MICROFIBRA G 019  
Código: Fábrika: Unidade:  
**29103** SOMOS PT/1  
F1 F4

UN: R\$ 11,23 AV: R\$ 11,23 15: R\$ 11,47  
30: R\$ 11,70 45: R\$ 11,93 60: R\$ 12,17



CUECA AD BOXER MICROFIBRA M ESPEC MARCA  
Código: Fábrika: Unidade:  
**29100** CJL PT/1  
F1 F4

UN: R\$ 6,16 AV: R\$ 73,88 15: R\$ 75,42  
30: R\$ 76,93 45: R\$ 78,47 60: R\$ 80,04



CUECA AD BOXER UNICO 90%POL/10%ELAS 12X1  
Código: Fábrika: Unidade:  
**32646** VI-MAIS PT/12  
F1 F4

UN: R\$ 15,28 AV: R\$ 15,28 15: R\$ 15,59  
30: R\$ 15,91 45: R\$ 16,22 60: R\$ 16,55



CUECA AD SAMBA CANCAO P 053  
Código: Fábrika: Unidade:  
**12585** MACHY UN/1  
F1 F4

UN: R\$ 8,18 AV: R\$ 8,18 15: R\$ 8,35  
30: R\$ 8,51 45: R\$ 8,68 60: R\$ 8,86



CUECA AD SLIP P ALGODAO/MFIBRA  
Código: Fábrika: Unidade:  
**15690** GUERRIER UN/1  
F1 F4

UN: R\$ 7,91 AV: R\$ 23,74 15: R\$ 24,24  
30: R\$ 24,72 45: R\$ 25,22 60: R\$ 25,72



CUECA INF ALGODAO C/ELAST M 58/08 3X1  
Código: Fábrika: Unidade:  
**12586** KELLPS/SOMOS PT/3  
F1 F4

UN: R\$ 7,91 AV: R\$ 23,74 15: R\$ 24,24  
30: R\$ 24,72 45: R\$ 25,22 60: R\$ 25,72



CUECA INF ALGODAO C/ELAST N03 G 3X1  
Código: Fábrika: Unidade:  
**18209** NAWES PT/3  
F1 F4

UN: R\$ 7,91 AV: R\$ 23,74 15: R\$ 24,24  
30: R\$ 24,72 45: R\$ 25,22 60: R\$ 25,72



CUECA INF ALGODAO C/ELAST N03 M 3X1  
Código: Fábrika: Unidade:  
**51079** NAWES PT/3  
F1 F4

UN: R\$ 7,91 AV: R\$ 23,74 15: R\$ 24,24  
30: R\$ 24,72 45: R\$ 25,22 60: R\$ 25,72



CUECA INF ALGODAO C/ELAST N03 P 3X1  
Código: Fábrika: Unidade:  
**5917** NAWES PT/3  
F1 F4

UN: R\$ 7,73 AV: R\$ 23,19 15: R\$ 23,68  
30: R\$ 24,15 45: R\$ 24,63 60: R\$ 25,13



CUECA INF ALGODAO N04 G 3X1  
Código: 18839 Fábrica: NAWES Unidade: PT/3 F1 F4

UN: R\$ 7,73 AV: R\$ 23,19 15: R\$ 23,68  
30: R\$ 24,15 45: R\$ 24,63 60: R\$ 25,13



CUECA INF ALGODAO N04 M 3X1  
Código: 18841 Fábrica: NAWES Unidade: PT/3 F1 F4

UN: R\$ 7,73 AV: R\$ 23,19 15: R\$ 23,68  
30: R\$ 24,15 45: R\$ 24,63 60: R\$ 25,13



CUECA INF ALGODAO N04 P 3X1  
Código: 18207 Fábrica: NAWES Unidade: PT/3 F1 F4

UN: R\$ 11,65 AV: R\$ 139,77 15: R\$ 142,68  
30: R\$ 145,53 45: R\$ 148,44 60: R\$ 151,41



CUECA INF BOXER ALGODAO LISO N16 G 12X1  
Código: 39730 Fábrica: NAWES Unidade: PT/12 F1 F4

UN: R\$ 11,65 AV: R\$ 139,77 15: R\$ 142,68  
30: R\$ 145,53 45: R\$ 148,44 60: R\$ 151,41



CUECA INF BOXER ALGODAO LISO N16 GG 12X1  
Código: 39731 Fábrica: NAWES Unidade: PT/12 F1 F4

UN: R\$ 11,65 AV: R\$ 139,77 15: R\$ 142,68  
30: R\$ 145,53 45: R\$ 148,44 60: R\$ 151,41



CUECA INF BOXER ALGODAO LISO N16 M 12X1  
Código: 39729 Fábrica: NAWES Unidade: PT/12 F1 F4

UN: R\$ 11,65 AV: R\$ 139,77 15: R\$ 142,68  
30: R\$ 145,53 45: R\$ 148,44 60: R\$ 151,41



CUECA INF BOXER ALGODAO LISO N16 P 12X1  
Código: 39728 Fábrica: NAWES Unidade: PT/12 F1 F4

UN: R\$ 11,65 AV: R\$ 139,77 15: R\$ 142,68  
30: R\$ 145,53 45: R\$ 148,44 60: R\$ 151,41



CUECA INF BOXER ALGODAO LISTR N16 G 12X1  
Código: 39734 Fábrica: NAWES Unidade: PT/12 F1 F4

UN: R\$ 11,65 AV: R\$ 139,77 15: R\$ 142,68  
30: R\$ 145,53 45: R\$ 148,44 60: R\$ 151,41



CUECA INF BOXER ALGODAO LISTR N16 P 12X1  
Código: 39732 Fábrica: NAWES Unidade: PT/12 F1 F4

UN: R\$ 4,36 AV: R\$ 13,08 15: R\$ 13,35  
30: R\$ 13,62 45: R\$ 13,89 60: R\$ 14,17



CUECA JUVENIL ALGODAO C/ELAST G 021 3X1  
Código: 20386 Fábrica: SOMOS Unidade: PT/3 F1 F4

UN: R\$ 4,36 AV: R\$ 13,08 15: R\$ 13,35  
30: R\$ 13,62 45: R\$ 13,89 60: R\$ 14,17



CUECA JUVENIL ALGODAO C/ELAST M 021 3X1  
Código: 20385 Fábrica: SOMOS Unidade: PT/3 F1 F4

UN: R\$ 6,16 AV: R\$ 18,47 15: R\$ 18,86  
30: R\$ 19,23 45: R\$ 19,62 60: R\$ 20,01



CUECA JUVENIL ALGODAO C/ELAST N14 G 3X1  
Código: 39726 Fábrica: NAWES Unidade: PT/3 F1 F4

UN: R\$ 4,36 AV: R\$ 13,08 15: R\$ 13,35  
30: R\$ 13,62 45: R\$ 13,89 60: R\$ 14,17



CUECA JUVENIL ALGODAO C/ELAST P 021 3X1  
Código: 20384 Fábrica: SOMOS Unidade: PT/3 F1 F4

UN: R\$ 7,19 AV: R\$ 7,19 15: R\$ 7,34  
30: R\$ 7,49 45: R\$ 7,63 60: R\$ 7,79



CUECA JUVENIL BOXER ALG/MF N13 G  
Código: 26142 Fábrica: NAWES Unidade: UN/1 F1 F4

UN: R\$ 7,19 AV: R\$ 7,19 15: R\$ 7,34  
30: R\$ 7,49 45: R\$ 7,63 60: R\$ 7,79



CUECA JUVENIL BOXER N13 M ALG/MF  
Código: 32882 Fábrica: NAWES Unidade: UN/1 F1 F4

UN: R\$ 7,19 AV: R\$ 7,19 15: R\$ 7,34  
30: R\$ 7,49 45: R\$ 7,63 60: R\$ 7,79



CUECA JUVENIL BOXER N13 P/PP ALG/MF  
Código: 32883 Fábrica: NAWES Unidade: UN/1 F1 F4

UN: R\$ 106,33 AV: R\$ 106,33 15: R\$ 108,54  
30: R\$ 110,72 45: R\$ 112,93 60: R\$ 115,19



CX SOM PORT MULT USB BLUE RAD AM/FM 1105

Código: Fábrica: Unidade:  
**39707** WINMAX CX/1  
F1 F4

UN: R\$ 106,33 AV: R\$ 106,33 15: R\$ 108,54  
30: R\$ 110,72 45: R\$ 112,93 60: R\$ 115,19



CX SOM PORT MULT USB BLUE RAD AM/FM 1106

Código: Fábrica: Unidade:  
**39708** WINMAX CX/1  
F1 F4

UN: R\$ 2743,10 AV: R\$ 2743,10 15: R\$ 2800,25  
30: R\$ 2856,26 45: R\$ 2913,38 60: R\$ 2971,65



CX SOM PORTATIL LED CONTROL REMOT 2000W

Código: Fábrica: Unidade:  
**43400** LETRON UN/1  
F1 F4

UN: R\$ 4,16 AV: R\$ 49,91 15: R\$ 50,95  
30: R\$ 51,97 45: R\$ 53,01 60: R\$ 54,07



DEDEIRA VIOLAO COLOR D98 12X1

Código: Fábrica: Unidade:  
**24410** ROUXINOL PT/12  
F1 F4

UN: R\$ 10,97 AV: R\$ 10,97 15: R\$ 11,20  
30: R\$ 11,43 45: R\$ 11,65 60: R\$ 11,89



DESENGRIPANTE SPRAY 300 ML 150 GRS

Código: Fábrica: Unidade:  
**15753** LUB FAST UN/1  
F1 F4

UN: R\$ 9,47 AV: R\$ 9,47 15: R\$ 9,67  
30: R\$ 9,87 45: R\$ 10,06 60: R\$ 10,26



DESENTUPIDOR DE TUBULACAO 1,5 MT 5693

Código: Fábrica: Unidade:  
**32403** IDEA UN/1  
F1 F4

UN: R\$ 8,98 AV: R\$ 8,98 15: R\$ 9,16  
30: R\$ 9,35 45: R\$ 9,53 60: R\$ 9,72



DESENTUPIDOR INOX TUBULACAO 1,23MTS 1001

Código: Fábrica: Unidade:  
**44735** WINCY UN/1  
F1 F4

UN: R\$ 2,15 AV: R\$ 107,33 15: R\$ 109,56  
30: R\$ 111,76 45: R\$ 113,99 60: R\$ 116,27



ENCASTOR C/CHUMBADA 20X19 50X1

Código: Fábrica: Unidade:  
**27235** ENTRE RIOS PT/50  
F1 F4

UN: R\$ 1,62 AV: R\$ 81,04 15: R\$ 82,73  
30: R\$ 84,38 45: R\$ 86,07 60: R\$ 87,79



ENCASTOR C/CHUMBADA 22X17 50X1

Código: Fábrica: Unidade:  
**39382** ENTRE RIOS PT/50  
F1 F4

UN: R\$ 1,00 AV: R\$ 49,91 15: R\$ 50,95  
30: R\$ 51,97 45: R\$ 53,01 60: R\$ 54,07



ENCASTOR C/CHUMBADA 24 50X1

Código: Fábrica: Unidade:  
**27236** CF PT/50  
F4

UN: R\$ 1,19 AV: R\$ 119,43 15: R\$ 121,92  
30: R\$ 124,36 45: R\$ 126,84 60: R\$ 129,38



ENCASTOR C/CHUMBADA 24X15 100X1

Código: Fábrica: Unidade:  
**10895** ENTRE RIOS CE/100  
F1 F4

UN: R\$ 1,00 AV: R\$ 99,83 15: R\$ 101,91  
30: R\$ 103,95 45: R\$ 106,03 60: R\$ 108,15



ENCASTOR C/CHUMBADA 26X13 100X1

Código: Fábrica: Unidade:  
**27237** ENTRE RIOS CE/100  
F1 F4

UN: R\$ 0,84 AV: R\$ 83,72 15: R\$ 85,46  
30: R\$ 87,17 45: R\$ 88,91 60: R\$ 90,69



ENCASTOR C/CHUMBADA 28X11 100X1

Código: Fábrica: Unidade:  
**27238** ENTRE RIOS CE/100  
F1 F4

UN: R\$ 0,75 AV: R\$ 75,14 15: R\$ 76,71  
30: R\$ 78,24 45: R\$ 79,80 60: R\$ 81,40



ENCASTOR C/CHUMBADA 30X06 100X1

Código: Fábrica: Unidade:  
**27239** ENTRE RIOS CE/100  
F1 F4

UN: R\$ 0,69 AV: R\$ 69,49 15: R\$ 70,94  
30: R\$ 72,36 45: R\$ 73,80 60: R\$ 75,28



ENCASTOR C/CHUMBADA 32X06 100X1

Código: Fábrica: Unidade:  
**27240** ENTRE RIOS CE/100  
F1 F4

UN: R\$ 0,55 AV: R\$ 54,90 15: R\$ 56,05  
30: R\$ 57,17 45: R\$ 58,31 60: R\$ 59,48

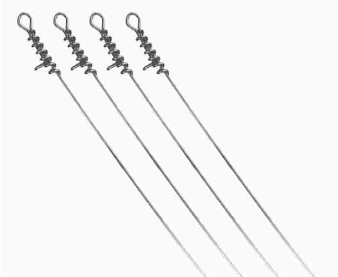

ENCASTOR C/MOLA 18X25 100X1

Código: Fábrica: Unidade:  
**45161** CF CE/100  
F1 F4

UN: R\$ 0,50 AV: R\$ 49,91 15: R\$ 50,95  
30: R\$ 51,97 45: R\$ 53,01 60: R\$ 54,07



ENCASTOR C/MOLA 20X07 100X1

Código: **45160** Fábrica: CF Unidade: CE/100 F1 F4

UN: R\$ 0,32 AV: R\$ 31,95 15: R\$ 32,61  
30: R\$ 33,27 45: R\$ 33,93 60: R\$ 34,61



ENCASTOR C/MOLA 20X10 100X1

Código: **13624** Fábrica: CF Unidade: CE/100 F4

UN: R\$ 0,38 AV: R\$ 37,94 15: R\$ 38,73  
30: R\$ 39,50 45: R\$ 40,29 60: R\$ 41,10



ENCASTOR C/MOLA 20X15 100X1

Código: **13623** Fábrica: CF Unidade: CE/100 F4

UN: R\$ 0,45 AV: R\$ 44,92 15: R\$ 45,85  
30: R\$ 46,77 45: R\$ 47,71 60: R\$ 48,66



ENCASTOR C/MOLA 22X07 100X1

Código: **10888** Fábrica: CF Unidade: CE/100 F4

UN: R\$ 0,45 AV: R\$ 44,92 15: R\$ 45,85  
30: R\$ 46,77 45: R\$ 47,71 60: R\$ 48,66



ENCASTOR C/MOLA 22X10 100X1

Código: **10889** Fábrica: ENTRE RIOS Unidade: CE/100 F4

UN: R\$ 0,45 AV: R\$ 44,92 15: R\$ 45,85  
30: R\$ 46,77 45: R\$ 47,71 60: R\$ 48,66



ENCASTOR C/MOLA 22X15 100X1

Código: **34567** Fábrica: CF Unidade: CE/100 F4

UN: R\$ 0,40 AV: R\$ 39,93 15: R\$ 40,76  
30: R\$ 41,57 45: R\$ 42,40 60: R\$ 43,25



ENCASTOR C/MOLA 22X20 100X1

Código: **43953** Fábrica: CF Unidade: CE/100 F4

UN: R\$ 0,20 AV: R\$ 19,97 15: R\$ 20,38  
30: R\$ 20,79 45: R\$ 21,21 60: R\$ 21,63



ENCASTOR C/MOLA 24X05 100X1

Código: **10890** Fábrica: CF Unidade: CE/100 F4

UN: R\$ 0,25 AV: R\$ 24,95 15: R\$ 25,47  
30: R\$ 25,98 45: R\$ 26,50 60: R\$ 27,03



ENCASTOR C/MOLA 24X07 100X1

Código: **10885** Fábrica: ENTRE RIOS Unidade: CE/100 F4

UN: R\$ 0,44 AV: R\$ 43,92 15: R\$ 44,83  
30: R\$ 45,73 45: R\$ 46,65 60: R\$ 47,58



ENCASTOR C/MOLA 24X10 100X1

Código: **10886** Fábrica: ENTRE RIOS Unidade: CE/100 F1 F4

UN: R\$ 0,27 AV: R\$ 26,71 15: R\$ 27,26  
30: R\$ 27,81 45: R\$ 28,37 60: R\$ 28,93

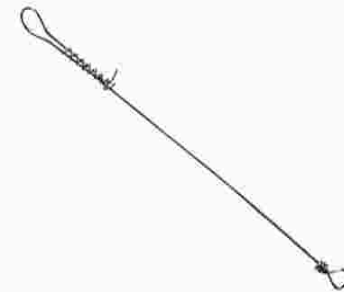

ENCASTOR C/MOLA 26X05 100X1

Código: **30710** Fábrica: ENTRE RIOS Unidade: CE/100 F1 F4

UN: R\$ 0,30 AV: R\$ 29,94 15: R\$ 30,57  
30: R\$ 31,18 45: R\$ 31,80 60: R\$ 32,44



ENCASTOR C/MOLA 26X07 100X1

Código: **13622** Fábrica: ENTRE RIOS Unidade: CE/100 F1 F4

UN: R\$ 0,25 AV: R\$ 24,95 15: R\$ 25,47  
30: R\$ 25,98 45: R\$ 26,50 60: R\$ 27,03



ENCASTOR C/MOLA 28X03 100X1

Código: **10893** Fábrica: CF Unidade: CE/100 F1 F4

UN: R\$ 0,22 AV: R\$ 21,96 15: R\$ 22,42  
30: R\$ 22,87 45: R\$ 23,33 60: R\$ 23,79



ENCASTOR C/MOLA 28X05 100X1

Código: **10892** Fábrica: CF Unidade: CE/100 F4

UN: R\$ 0,25 AV: R\$ 24,83 15: R\$ 25,35  
30: R\$ 25,85 45: R\$ 26,37 60: R\$ 26,90



ENCASTOR C/MOLA 28X07 100X1

Código: **10894** Fábrica: ENTRE RIOS Unidade: CE/100 F1 F4

UN: R\$ 10,48 AV: R\$ 10,48 15: R\$ 10,70  
30: R\$ 10,92 45: R\$ 11,13 60: R\$ 11,36



ENCORDOAMENTO ACO CAVAQUINHO R-51

Código: **37351** Fábrica: ROUXINOL Unidade: PT/1 F1 F4

UN: R\$ 26,95 AV: R\$ 26,95 15: R\$ 27,51  
30: R\$ 28,06 45: R\$ 28,62 60: R\$ 29,19



ENCORDAMENTO ACO GUITARRA ELETRICA R-80  
Código: 36455 Fábrica: ROUXINOL Unidade: UN/1  
F1 F4

UN: R\$ 34,93 AV: R\$ 34,93 15: R\$ 35,66  
30: R\$ 36,38 45: R\$ 37,10 60: R\$ 37,84



ENCORDAMENTO ACO VIOLA R-52  
Código: 20610 Fábrica: ROUXINOL Unidade: PT/1  
F1 F4

UN: R\$ 32,95 AV: R\$ 32,95 15: R\$ 33,63  
30: R\$ 34,31 45: R\$ 34,99 60: R\$ 35,69



ENCORDAMENTO ACO VIOLAO R-20  
Código: 37350 Fábrica: ROUXINOL Unidade: PT/1  
F1 F4

UN: R\$ 36,93 AV: R\$ 36,93 15: R\$ 37,70  
30: R\$ 38,45 45: R\$ 39,22 60: R\$ 40,01



ENCORDAMENTO ACO VIOLAO R-50  
Código: 20609 Fábrica: ROUXINOL Unidade: PT/1  
F1 F4

UN: R\$ 29,94 AV: R\$ 29,94 15: R\$ 30,57  
30: R\$ 31,18 45: R\$ 31,80 60: R\$ 32,44



ENCORDAMENTO ACO VIOLAO R-70  
Código: 37352 Fábrica: ROUXINOL Unidade: PT/1  
F1 F4

UN: R\$ 2,30 AV: R\$ 13,80 15: R\$ 14,09  
30: R\$ 14,37 45: R\$ 14,65 60: R\$ 14,95  
14 cm



ENFEITE DECORATIVO SAPO 4CM 15477 6X1  
Código: 38296 Fábrica: SATYAM Unidade: CX/6  
F1 F4

UN: R\$ 2,42 AV: R\$ 2,42 15: R\$ 2,47  
30: R\$ 2,52 45: R\$ 2,57 60: R\$ 2,62



ENFEITE RESINA C/CX 83708 BATISMO  
Código: 15481 Fábrica: AIH Unidade: CX/1  
F1 F4

UN: R\$ 2,20 AV: R\$ 2,20 15: R\$ 2,24  
30: R\$ 2,29 45: R\$ 2,33 60: R\$ 2,38  
105 cm  
105 cm



ENFEITE RESINA C/CX 84016 C/PORTA JOIA  
Código: 15451 Fábrica: AIH Unidade: CX/1  
F1 F4

UN: R\$ 2,65 AV: R\$ 2,65 15: R\$ 2,70  
30: R\$ 2,75 45: R\$ 2,81 60: R\$ 2,87  
10 cm  
08 cm



ENFEITE RESINA C/CX 84083 BEBE LEVADO  
Código: 15018 Fábrica: AIH Unidade: CX/1  
F1 F4

UN: R\$ 2,05 AV: R\$ 2,05 15: R\$ 2,09  
30: R\$ 2,13 45: R\$ 2,17 60: R\$ 2,22  
10 cm  
5,5 cm



ENFEITE RESINA C/CX 84129 BEBE SENT BOLA  
Código: 15495 Fábrica: AIH Unidade: CX/1  
F1 F4

UN: R\$ 0,48 AV: R\$ 47,92 15: R\$ 48,92  
30: R\$ 49,90 45: R\$ 50,90 60: R\$ 51,92

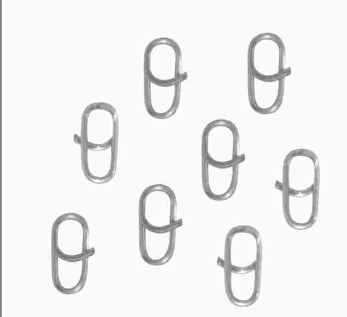

ENGATE RAPIDO SNAP P/ISCA ARTIFICIAL100X1  
Código: 40269 Fábrica: CF Unidade: CE/100  
F4

UN: R\$ 47,47 AV: R\$ 47,47 15: R\$ 48,46  
30: R\$ 49,43 45: R\$ 50,42 60: R\$ 51,43



ESPELHO AUMENTO MESA DUPLO 16,7X19CM 041  
Código: 49389 Fábrica: RIOHOME Unidade: UN/1  
F1 F4

UN: R\$ 1,94 AV: R\$ 69,87 15: R\$ 71,32  
30: R\$ 72,75 45: R\$ 74,21 60: R\$ 75,69

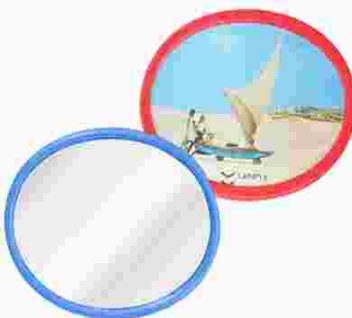

ESPELHO BOLSO OVAL PLAST 3702 36X1  
Código: 30168 Fábrica: LANDHS Unidade: CX/36  
F1 F4

UN: R\$ 1,75 AV: R\$ 62,89 15: R\$ 64,20  
30: R\$ 65,48 45: R\$ 66,79 60: R\$ 68,13



ESPELHO BOLSO REDONDO PLAST 3602 36X1  
Código: 9391 Fábrica: LANDHS Unidade: CX/36  
F1 F4

UN: R\$ 2,38 AV: R\$ 2,38 15: R\$ 2,43  
30: R\$ 2,47 45: R\$ 2,52 60: R\$ 2,57



ESPELHO EMOLDURADO INF C/QUEBRA CABECA  
Código: 24798 Fábrica: HAI BRASIL Unidade: UN/1  
F1 F4

UN: R\$ 3,19 AV: R\$ 3,19 15: R\$ 3,26  
30: R\$ 3,33 45: R\$ 3,39 60: R\$ 3,46



ESPELHO EMOLDURADO 0062  
Código: 24796 Fábrica: HAI BRASIL Unidade: UN/1  
F1 F4

UN: R\$ 4,33 AV: R\$ 25,96 15: R\$ 26,50  
30: R\$ 27,03 45: R\$ 27,57 60: R\$ 28,12



ESPELHO MOLDURA COLOR 10 6X1

Código: **19370** Fábrica: LANDHS/BUDEP Unidade: PT/6 F1 F4

UN: R\$ 3,66 AV: R\$ 43,92 15: R\$ 44,83  
30: R\$ 45,73 45: R\$ 46,65 60: R\$ 47,58



18 cm  
13,5 cm

ESPELHO MOLDURA N 12 12X1

Código: **17995** Fábrica: BUDEPLAST Unidade: DZ/12 F1 F4

UN: R\$ 6,32 AV: R\$ 37,93 15: R\$ 38,72  
30: R\$ 39,49 45: R\$ 40,28 60: R\$ 41,09



ESPELHO MOLDURA N 14 6X1

Código: **19093** Fábrica: BUDEPLAST Unidade: PT/6 F1 F4

UN: R\$ 6,24 AV: R\$ 74,87 15: R\$ 76,43  
30: R\$ 77,96 45: R\$ 79,52 60: R\$ 81,11



ESPELHO MOLDURA N 14 12X1

Código: **14334** Fábrica: BUDEPLAST Unidade: DZ/12 F1 F4

UN: R\$ 9,48 AV: R\$ 56,90 15: R\$ 58,08  
30: R\$ 59,25 45: R\$ 60,43 60: R\$ 61,64



ESPELHO MOLDURA N 16 6X1

Código: **19085** Fábrica: BUDEPLAST Unidade: PT/6 F1 F4

UN: R\$ 7,49 AV: R\$ 89,85 15: R\$ 91,72  
30: R\$ 93,55 45: R\$ 95,42 60: R\$ 97,33

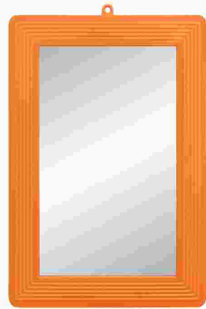

ESPELHO MOLDURA N 16 12X1

Código: **14335** Fábrica: BUDEPLAST Unidade: DZ/12 F1 F4

UN: R\$ 11,65 AV: R\$ 69,88 15: R\$ 71,33  
30: R\$ 72,76 45: R\$ 74,22 60: R\$ 75,70



ESPELHO MOLDURA N 18 6X1

Código: **3054** Fábrica: BUDEPLAST Unidade: PT/6 F1 F4

UN: R\$ 9,98 AV: R\$ 119,80 15: R\$ 122,29  
30: R\$ 124,74 45: R\$ 127,23 60: R\$ 129,78



25 cm  
18 cm

ESPELHO MOLDURA N 18 12X1

Código: **14336** Fábrica: BUDEPLAST Unidade: DZ/12 F1 F4

UN: R\$ 13,31 AV: R\$ 79,86 15: R\$ 81,53  
30: R\$ 83,16 45: R\$ 84,82 60: R\$ 86,52



ESPELHO MOLDURA N 20 6X1

Código: **3051** Fábrica: BUDEPLAST Unidade: PT/6 F1 F4

UN: R\$ 12,48 AV: R\$ 149,75 15: R\$ 152,87  
30: R\$ 155,93 45: R\$ 159,05 60: R\$ 162,23



31 cm  
21 cm

ESPELHO MOLDURA N 20 12X1

Código: **14337** Fábrica: BUDEPLAST Unidade: DZ/12 F1 F4

UN: R\$ 5,98 AV: R\$ 5,98 15: R\$ 6,11  
30: R\$ 6,23 45: R\$ 6,35 60: R\$ 6,48



ESTOPA COR EXTRA 200 GRS 1512

Código: **48284** Fábrica: POLIUM Unidade: PT/1 F1 F4

UN: R\$ 28,94 AV: R\$ 28,94 15: R\$ 29,55  
30: R\$ 30,14 45: R\$ 30,74 60: R\$ 31,36



EXTENSAO 3 MTS 3 ENTRADAS RED 32508A

Código: **26594** Fábrica: LIDER PLUS Unidade: UN/1 F1 F4

UN: R\$ 28,94 AV: R\$ 28,94 15: R\$ 29,55  
30: R\$ 30,14 45: R\$ 30,74 60: R\$ 31,36



EXTENSAO 3 MTS 3 ENTRADAS 3 PINOS 32640

Código: **46003** Fábrica: LIDER PLUS Unidade: UN/1 F1 F4

UN: R\$ 17,96 AV: R\$ 17,96 15: R\$ 18,34  
30: R\$ 18,70 45: R\$ 19,08 60: R\$ 19,46



EXTENSAO 3 MTS 3 ENTRADAS 32652

Código: **25895** Fábrica: LIDER PLUS Unidade: UN/1 F1 F4

UN: R\$ 29,94 AV: R\$ 29,94 15: R\$ 30,57  
30: R\$ 31,18 45: R\$ 31,80 60: R\$ 32,44



EXTENSAO 5 MTS 3 ENTRADAS RED 32509A

Código: **17785** Fábrica: LIDER PLUS Unidade: UN/1 F1 F4

UN: R\$ 22,95 AV: R\$ 22,95 15: R\$ 23,43  
30: R\$ 23,90 45: R\$ 24,38 60: R\$ 24,87



EXTENSAO 5 MTS 3 ENTRADAS 32654

Código: **25896** Fábrica: LIDER PLUS Unidade: UN/1 F1 F4

UN: R\$ 28,94 AV: R\$ 28,94 15: R\$ 29,55  
30: R\$ 30,14 45: R\$ 30,74 60: R\$ 31,36



EXTENSÃO 10 MTS 3 ENTRADAS 32656  
Código: Fábrika: Unidade:  
**25897** LIDER PLUS UN/1  
F1 F4

UN: R\$ 5,98 AV: R\$ 5,98 15: R\$ 6,11  
30: R\$ 6,23 45: R\$ 6,35 60: R\$ 6,48



FERRAMEN PONTEIRO CONCRETO 30CM 9307 2X1  
Código: Fábrika: Unidade:  
**42394** IDEA UN/1  
F1 F4

UN: R\$ 28,94 AV: R\$ 28,94 15: R\$ 29,55  
30: R\$ 30,14 45: R\$ 30,74 60: R\$ 31,36



FERRAMENTA ALICATE BICO FINO 1020  
Código: Fábrika: Unidade:  
**48065** FERTAK UN/1  
F1 F4

UN: R\$ 24,95 AV: R\$ 24,95 15: R\$ 25,47  
30: R\$ 25,98 45: R\$ 26,50 60: R\$ 27,03



FERRAMENTA ALICATE BIJOUTERIA 5" BR  
Código: Fábrika: Unidade:  
**45083** NYBC UN/1  
F1 F4

UN: R\$ 28,94 AV: R\$ 28,94 15: R\$ 29,55  
30: R\$ 30,14 45: R\$ 30,74 60: R\$ 31,36



FERRAMENTA ALICATE BIJOUTERIAS 5" BJ  
Código: Fábrika: Unidade:  
**45084** NYBC UN/1  
F1 F4

UN: R\$ 20,96 AV: R\$ 20,96 15: R\$ 21,39  
30: R\$ 21,82 45: R\$ 22,26 60: R\$ 22,70



FERRAMENTA ALICATE CORTE BIJOU 4,5" 421  
Código: Fábrika: Unidade:  
**46873** PLANETA UN/1  
F1 F4

UN: R\$ 20,96 AV: R\$ 20,96 15: R\$ 21,39  
30: R\$ 21,82 45: R\$ 22,26 60: R\$ 22,70



FERRAMENTA ALICATE CORTE BIJOU 4,5" 422  
Código: Fábrika: Unidade:  
**46874** PLANETA UN/1  
F1 F4

UN: R\$ 31,94 AV: R\$ 31,94 15: R\$ 32,60  
30: R\$ 33,26 45: R\$ 33,92 60: R\$ 34,60



FERRAMENTA ALICATE ILHOS 6" 150MM  
Código: Fábrika: Unidade:  
**45081** NYBC UN/1  
F1 F4

UN: R\$ 29,95 AV: R\$ 29,95 15: R\$ 30,58  
30: R\$ 31,19 45: R\$ 31,81 60: R\$ 32,45



FERRAMENTA ALICATE PRESSAO 10" 4566  
Código: Fábrika: Unidade:  
**2866** IDEA UN/1  
F1 F4

UN: R\$ 17,47 AV: R\$ 17,47 15: R\$ 17,84  
30: R\$ 18,19 45: R\$ 18,56 60: R\$ 18,93



FERRAMENTA ALICATE UNIVERSAL 5" 9733  
Código: Fábrika: Unidade:  
**38210** IDEA UN/1  
F1 F4

UN: R\$ 11,24 AV: R\$ 11,24 15: R\$ 11,48  
30: R\$ 11,71 45: R\$ 11,94 60: R\$ 12,18



FERRAMENTA ALICATE UNIVERSAL 8" 4030  
Código: Fábrika: Unidade:  
**50144** GP6 CR/1  
F1 F4

UN: R\$ 49,91 AV: R\$ 49,91 15: R\$ 50,95  
30: R\$ 51,97 45: R\$ 53,01 60: R\$ 54,07



FERRAMENTA ALICATE VAZADOR 9" 210MM  
Código: Fábrika: Unidade:  
**45082** NYBC UN/1  
F1 F4

UN: R\$ 23,46 AV: R\$ 23,46 15: R\$ 23,95  
30: R\$ 24,43 45: R\$ 24,92 60: R\$ 25,42



FERRAMENTA ALICATE 4,5" BICO/CORT/UN 3X1  
Código: Fábrika: Unidade:  
**50143** GP6 CJ/1  
F1 F4

UN: R\$ 14,14 AV: R\$ 14,14 15: R\$ 14,43  
30: R\$ 14,72 45: R\$ 15,01 60: R\$ 15,32



FERRAMENTA ALICATE 6" BICO FINO ACO 511  
Código: Fábrika: Unidade:  
**29205** PLANETA UN/1  
F1 F4

UN: R\$ 19,47 AV: R\$ 19,47 15: R\$ 19,87  
30: R\$ 20,27 45: R\$ 20,68 60: R\$ 21,09



FERRAMENTA ALICATE 6" CORTE DIAGONAL3017  
Código: Fábrika: Unidade:  
**34789** FBG UN/1  
F1 F4

UN: R\$ 7,99 AV: R\$ 7,99 15: R\$ 8,15  
30: R\$ 8,32 45: R\$ 8,48 60: R\$ 8,65



FERRAMENTA ARAME GALVANIZADO 4X1  
Código: Fábrika: Unidade:  
**33440** MAXPING CT/1  
F1 F4

UN: R\$ 5,68 AV: R\$ 5,68 15: R\$ 5,80  
30: R\$ 5,92 45: R\$ 6,03 60: R\$ 6,15

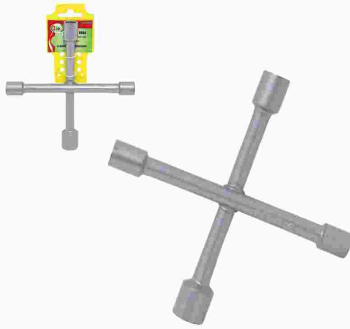

FERRAMENTA CHAVE COMBINADA 10 BOCAS 446

Código: Fábrica: Unidade:  
**46872** PLANETA CT/1  
F1 F4

UN: R\$ 19,47 AV: R\$ 19,47 15: R\$ 19,87  
30: R\$ 20,27 45: R\$ 20,68 60: R\$ 21,09

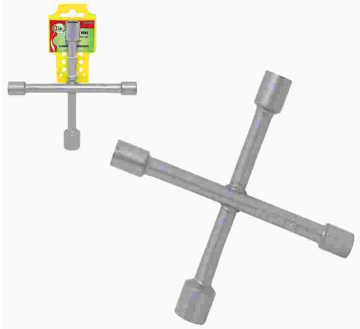

FERRAMENTA CHAVE RODA MINI 12X13X14MM

Código: Fábrica: Unidade:  
**40069** IDEA UN/1  
F1 F4

UN: R\$ 7,98 AV: R\$ 7,98 15: R\$ 8,14  
30: R\$ 8,31 45: R\$ 8,47 60: R\$ 8,64



FERRAMENTA CHAVE TESTE C/PLUG 10 FUSIVEL

Código: Fábrica: Unidade:  
**2853** IDEA CR/1  
F1 F4

UN: R\$ 30,95 AV: R\$ 30,95 15: R\$ 31,60  
30: R\$ 32,23 45: R\$ 32,87 60: R\$ 33,53

Altura: 32 cm



FERRAMENTA MARTELO G CB MADEIRA MT50

Código: Fábrica: Unidade:  
**27416** YING FA UN/1  
F1 F4

UN: R\$ 22,43 AV: R\$ 22,43 15: R\$ 22,90  
30: R\$ 23,36 45: R\$ 23,83 60: R\$ 24,30



FERRAMENTA MULTIMETRO ANALOGICO 270

Código: Fábrica: Unidade:  
**8349** AGUIA BRANCA UN/1  
F1 F4

UN: R\$ 33,95 AV: R\$ 33,95 15: R\$ 34,65  
30: R\$ 35,35 45: R\$ 36,05 60: R\$ 36,77



FERRAMENTA MULTIMETRO DIGITAL CTL 6200

Código: Fábrica: Unidade:  
**38214** IDEA UN/1  
F1 F4

UN: R\$ 9,65 AV: R\$ 9,65 15: R\$ 9,86  
30: R\$ 10,05 45: R\$ 10,25 60: R\$ 10,46



FERRAMENTA TRENA 5 MTS 24MM EMB 60017

Código: Fábrica: Unidade:  
**25016** GP6 UN/1  
F1 F4

UN: R\$ 13,97 AV: R\$ 13,97 15: R\$ 14,26  
30: R\$ 14,54 45: R\$ 14,83 60: R\$ 15,13



FERRAMENTA TRENA 7,5 MTS KD129

Código: Fábrica: Unidade:  
**22432** YING FA UN/1  
F1 F4

UN: R\$ 6,84 AV: R\$ 6,84 15: R\$ 6,98  
30: R\$ 7,12 45: R\$ 7,26 60: R\$ 7,41



FERRAMENTA 6 CHAVES PRECISAO 71601

Código: Fábrica: Unidade:  
**2871** ALMEGA UN/1  
F1 F4

UN: R\$ 31,94 AV: R\$ 31,94 15: R\$ 32,60  
30: R\$ 33,26 45: R\$ 33,92 60: R\$ 34,60



FERRO SOLDA 30W 127V G12

Código: Fábrica: Unidade:  
**41133** WESTERN UN/1  
F1 F4

UN: R\$ 38,93 AV: R\$ 38,93 15: R\$ 39,74  
30: R\$ 40,53 45: R\$ 41,34 60: R\$ 42,17



FILTRO LINHA 1 MT 4 TOMADAS 3 PINO 33044

Código: Fábrica: Unidade:  
**50085** LIDER PLUS UN/1  
F1 F4

UN: R\$ 39,93 AV: R\$ 39,93 15: R\$ 40,76  
30: R\$ 41,57 45: R\$ 42,40 60: R\$ 43,25



FILTRO LINHA 1 MT 5 TOMADAS 3 PIN 33045

Código: Fábrica: Unidade:  
**50086** LIDER PLUS UN/1  
F1 F4

UN: R\$ 42,92 AV: R\$ 42,92 15: R\$ 43,82  
30: R\$ 44,69 45: R\$ 45,59 60: R\$ 46,50



FILTRO LINHA 1 MT 6 TOMADAS 3 PIN 33046

Código: Fábrica: Unidade:  
**50087** LIDER PLUS UN/1  
F1 F4

UN: R\$ 4,22 AV: R\$ 4,22 15: R\$ 4,31  
30: R\$ 4,40 45: R\$ 4,49 60: R\$ 4,58



FIO DE SILICONE 0.5MM 10MTS 528801

Código: Fábrica: Unidade:  
**48550** KIT RL/1  
F1 F4

UN: R\$ 4,36 AV: R\$ 4,36 15: R\$ 4,45  
30: R\$ 4,54 45: R\$ 4,63 60: R\$ 4,73



FIO DE SILICONE 0.7MM 10MTS 309327

Código: Fábrica: Unidade:  
**48551** KIT RL/1  
F1 F4

UN: R\$ 4,84 AV: R\$ 4,84 15: R\$ 4,94  
30: R\$ 5,04 45: R\$ 5,14 60: R\$ 5,25



FIO DE SILICONE 1.0MM 10MTS 528803

Código: Fábrica: Unidade:  
**48552** KIT RL/1  
F1 F4

UN: R\$ 0,45 AV: R\$ 26,96 15: R\$ 27,52  
30: R\$ 28,07 45: R\$ 28,63 60: R\$ 29,20



FIO P/DECORAR UNHA 5117A 60X1

Código: Fábrika: Unidade:  
**27677** Y888 CX/60  
F1 F4

UN: R\$ 2,44 AV: R\$ 24,42 15: R\$ 24,93  
30: R\$ 25,43 45: R\$ 25,94 60: R\$ 26,46



FITA ISOLANTE 17MMX5MTS ANTI CHAMA10X1

Código: Fábrika: Unidade:  
**36465** BESTFER PT/10  
F1 F4

UN: R\$ 3,98 AV: R\$ 3,98 15: R\$ 4,07  
30: R\$ 4,15 45: R\$ 4,23 60: R\$ 4,32



FITA ISOLANTE 18MMX10MTS ANTICHAMA 0012

Código: Fábrika: Unidade:  
**44311** ALLTAPE PT/1  
F1 F4

UN: R\$ 7,48 AV: R\$ 7,48 15: R\$ 7,63  
30: R\$ 7,79 45: R\$ 7,94 60: R\$ 8,10



FITA ISOLANTE 18MMX20MTS ANTICHAMA 0013

Código: Fábrika: Unidade:  
**44312** ALLTAPE UN/1  
F1 F4

UN: R\$ 2,50 AV: R\$ 24,95 15: R\$ 25,47  
30: R\$ 25,98 45: R\$ 26,50 60: R\$ 27,03



FITA ISOLANTE 18MMX5MTS ANTI CHAMA 10X1

Código: Fábrika: Unidade:  
**48682** PLANETA PT/10  
F1 F4

UN: R\$ 1,89 AV: R\$ 1,89 15: R\$ 1,89  
30: R\$ 1,89 45: R\$ 1,89 60: R\$ 1,89



FITA ISOLANTE 18MMX5MTS ANTICHAMA 0011

Código: Fábrika: Unidade:  
**49892** ALLTAPE UN/1  
F1 F4

UN: R\$ 5,49 AV: R\$ 54,90 15: R\$ 56,05  
30: R\$ 57,17 45: R\$ 58,31 60: R\$ 59,48



FITA ISOLANTE 19MMX10MTS 10X1

Código: Fábrika: Unidade:  
**48643** TEK BOND PT/10  
F1 F4

UN: R\$ 9,38 AV: R\$ 93,84 15: R\$ 95,79  
30: R\$ 97,71 45: R\$ 99,66 60: R\$ 101,66



FITA ISOLANTE 19MMX20MTS 10X1

Código: Fábrika: Unidade:  
**48644** TEK BOND PT/10  
F1 F4

UN: R\$ 2,95 AV: R\$ 29,45 15: R\$ 30,07  
30: R\$ 30,67 45: R\$ 31,28 60: R\$ 31,91



FITA ISOLANTE 19MMX5MTS 10X1

Código: Fábrika: Unidade:  
**48642** TEK BOND PT/10  
F1 F4

UN: R\$ 1,59 AV: R\$ 1,59 15: R\$ 1,62  
30: R\$ 1,65 45: R\$ 1,69 60: R\$ 1,72



FITA VEDA ROSCA 12MMX10MTS NA CX

Código: Fábrika: Unidade:  
**50748** TEK BOND UN/1  
F1 F4

UN: R\$ 1,94 AV: R\$ 1,94 15: R\$ 1,98  
30: R\$ 2,02 45: R\$ 2,06 60: R\$ 2,10



FITA VEDA ROSCA 18MMX10MTS NA CX

Código: Fábrika: Unidade:  
**50749** TEK BOND UN/1  
F1 F4

UN: R\$ 2,99 AV: R\$ 2,99 15: R\$ 3,05  
30: R\$ 3,11 45: R\$ 3,17 60: R\$ 3,23



FITA VEDA ROSCA 18MMX50MTS NA CX

Código: Fábrika: Unidade:  
**50784** VEDALAR UN/1  
F1 F4

UN: R\$ 0,19 AV: R\$ 2,90 15: R\$ 2,96  
30: R\$ 3,01 45: R\$ 3,08 60: R\$ 3,14



FIXA CABO MIGUELAO 8MM GF16 15X1

Código: Fábrika: Unidade:  
**39784** GIRIFLASH PT/15  
F1 F4

UN: R\$ 11,97 AV: R\$ 11,97 15: R\$ 12,22  
30: R\$ 12,46 45: R\$ 12,71 60: R\$ 12,97



FLOR ARTIF BOUQUET ANTURIO 7 BOTOES18974

Código: Fábrika: Unidade:  
**36921** MABEL UN/1  
F1 F4

UN: R\$ 27,91 AV: R\$ 27,91 15: R\$ 28,49  
30: R\$ 29,06 45: R\$ 29,64 60: R\$ 30,23

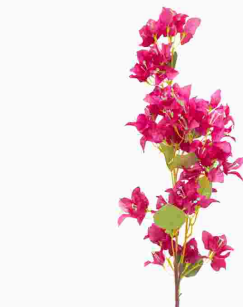

FLOR BOUGAINVILLEA RASP 98CM 11045

Código: Fábrika: Unidade:  
**48200** VIVA FLOR UN/1  
F1 F4

UN: R\$ 23,75 AV: R\$ 23,75 15: R\$ 24,25  
30: R\$ 24,73 45: R\$ 25,23 60: R\$ 25,73

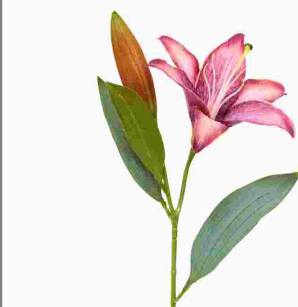

FLOR LIRIO 2 FLORES 50CM 11324/11304

Código: Fábrika: Unidade:  
**48202** VIVA FLOR UN/1  
F1 F4

UN: R\$ 19,96 AV: R\$ 19,96 15: R\$ 20,37  
30: R\$ 20,78 45: R\$ 21,20 60: R\$ 21,62



FLOR ORQUIDEA 7 BOTOES 95CM 13083

Código: Fábrika: Unidade:  
**48198** VIVA FLOR UN/1  
F1 F4

UN: R\$ 19,96 AV: R\$ 19,96 15: R\$ 20,37  
30: R\$ 20,78 45: R\$ 21,20 60: R\$ 21,62



FLOR RANUNCULO 5 BOTOES 11378

Código: Fábrika: Unidade:  
**48196** VIVA FLOR UN/1  
F1 F4

UN: R\$ 2,35 AV: R\$ 2,35 15: R\$ 2,35  
30: R\$ 2,35 45: R\$ 2,35 60: R\$ 2,35



FLOR ROSA 1 BOTAO 55114 UN

Código: Fábrika: Unidade:  
**23144** ALMEGA UN/1  
F1 F4

UN: R\$ 15,96 AV: R\$ 15,96 15: R\$ 16,30  
30: R\$ 16,62 45: R\$ 16,96 60: R\$ 17,29



FLUTUADOR P/PISCINA ESPAGUETE 160X6CM

Código: Fábrika: Unidade:  
**48070** BEL UN/1  
F1 F4

UN: R\$ 42,92 AV: R\$ 42,92 15: R\$ 43,82  
30: R\$ 44,69 45: R\$ 45,59 60: R\$ 46,50



FONE HEADSET ARCO C/MICROFONE 2059

Código: Fábrika: Unidade:  
**35342** INOVA UN/1  
F1 F4

UN: R\$ 199,67 AV: R\$ 199,67 15: R\$ 203,83  
30: R\$ 207,91 45: R\$ 212,06 60: R\$ 216,31



FONE OUVIDO BLUETOOTH DC-BL1200

Código: Fábrika: Unidade:  
**50295** DOTCELL UN/1  
F1 F4

UN: R\$ 39,93 AV: R\$ 39,93 15: R\$ 40,76  
30: R\$ 41,57 45: R\$ 42,40 60: R\$ 43,25



FONE OUVIDO BLUETOOTH ESPORTIVO KA-S6

Código: Fábrika: Unidade:  
**40213** KAPBOM UN/1  
F1 F4

UN: R\$ 13,26 AV: R\$ 13,26 15: R\$ 13,54  
30: R\$ 13,81 45: R\$ 14,08 60: R\$ 14,36



FONE OUVIDO C/MICROFONE PRETO F50

Código: Fábrika: Unidade:  
**48893** DOTCELL UN/1  
F1 F4

UN: R\$ 7,49 AV: R\$ 7,49 15: R\$ 7,64  
30: R\$ 7,80 45: R\$ 7,95 60: R\$ 8,11



FONE OUVIDO C/MICROFONE SAQUINH 1031/241

Código: Fábrika: Unidade:  
**29791** INOVA UN/1  
F1 F4

UN: R\$ 16,32 AV: R\$ 16,32 15: R\$ 16,66  
30: R\$ 17,00 45: R\$ 17,34 60: R\$ 17,68



FONE OUVIDO C/MICROFONE VERMELHO F35

Código: Fábrika: Unidade:  
**48596** DOTCELL UN/1  
F1 F4

UN: R\$ 11,97 AV: R\$ 11,97 15: R\$ 12,22  
30: R\$ 12,46 45: R\$ 12,71 60: R\$ 12,97



FONE OUVIDO C/MICROFONE 2172/73/78/2069

Código: Fábrika: Unidade:  
**21269** INOVA UN/1  
F1 F4

UN: R\$ 9,97 AV: R\$ 9,97 15: R\$ 10,18  
30: R\$ 10,39 45: R\$ 10,59 60: R\$ 10,81



FONE OUVIDO C/MICROFONE 2318/9828/58

Código: Fábrika: Unidade:  
**47938** INOVA UN/1  
F1 F4

UN: R\$ 9,97 AV: R\$ 9,97 15: R\$ 10,18  
30: R\$ 10,39 45: R\$ 10,59 60: R\$ 10,81



FONE OUVIDO C/MICROFONE 6758/9851

Código: Fábrika: Unidade:  
**48440** INOVA UN/1  
F1 F4

UN: R\$ 11,97 AV: R\$ 11,97 15: R\$ 12,22  
30: R\$ 12,46 45: R\$ 12,71 60: R\$ 12,97



FONE OUVIDO C/MICROFONE 8659

Código: Fábrika: Unidade:  
**47393** INOVA UN/1  
F1 F4

UN: R\$ 11,97 AV: R\$ 11,97 15: R\$ 12,22  
30: R\$ 12,46 45: R\$ 12,71 60: R\$ 12,97



FONE OUVIDO C/MICROFONE 9919/17/20/254

Código: Fábrika: Unidade:  
**35610** INOVA UN/1  
F1 F4

UN: R\$ 44,92 AV: R\$ 44,92 15: R\$ 45,85  
30: R\$ 46,77 45: R\$ 47,71 60: R\$ 48,66



FONE OUVIDO HEADPHONE USB MICROF HP20

Código: Fábrika: Unidade:  
**48891** MOX UN/1  
F1 F4

UN: R\$ 118,80 AV: R\$ 118,80 15: R\$ 121,27  
30: R\$ 123,70 45: R\$ 126,17 60: R\$ 128,70



FONE OUVIDO HEADSET USB MICROF EMBUTIDO

Código: **47174** Fábrica: **LETRON** Unidade: **UN/1**  
**F1 F4**

UN: R\$ 18,32 AV: R\$ 18,32 15: R\$ 18,70  
30: R\$ 19,08 45: R\$ 19,46 60: R\$ 19,85



FONE OUVIDO P2 C/MICROFONE BRANCO 047B

Código: **48575** Fábrica: **MAKETECH** Unidade: **UN/1**  
**F1 F4**

UN: R\$ 18,32 AV: R\$ 18,32 15: R\$ 18,70  
30: R\$ 19,08 45: R\$ 19,46 60: R\$ 19,85



FONE OUVIDO P2 C/MICROFONE PRETO 047P

Código: **48576** Fábrica: **MAKETECH** Unidade: **UN/1**  
**F1 F4**

UN: R\$ 0,06 AV: R\$ 59,89 15: R\$ 61,14  
30: R\$ 62,36 45: R\$ 63,61 60: R\$ 64,88



FORMINHA PAPEL N 0 BCA 10X100

Código: **30090** Fábrica: **PEL PLAST** Unidade: **MI/1000**  
**F1 F4**

UN: R\$ 0,03 AV: R\$ 32,94 15: R\$ 33,62  
30: R\$ 34,30 45: R\$ 34,98 60: R\$ 35,68



FORMINHA PAPEL N 3 AZUL CLARO 10X100

Código: **8709** Fábrica: **PEL PLAST** Unidade: **MI/1000**  
**F1 F4**

UN: R\$ 0,03 AV: R\$ 32,94 15: R\$ 33,62  
30: R\$ 34,30 45: R\$ 34,98 60: R\$ 35,68



FORMINHA PAPEL N 3 BCA 10X100

Código: **16086** Fábrica: **PEL PLAST** Unidade: **MI/1000**  
**F1 F4**

UN: R\$ 0,03 AV: R\$ 32,94 15: R\$ 33,62  
30: R\$ 34,30 45: R\$ 34,98 60: R\$ 35,68



FORMINHA PAPEL N 3 ROSA 10X100

Código: **9719** Fábrica: **PEL PLAST** Unidade: **MI/1000**  
**F1 F4**

UN: R\$ 0,02 AV: R\$ 18,96 15: R\$ 19,35  
30: R\$ 19,74 45: R\$ 20,14 60: R\$ 20,54



FORMINHA PAPEL N 5 AZUL CLARO 10X100

Código: **10049** Fábrica: **PEL PLAST** Unidade: **MI/1000**  
**F1 F4**

UN: R\$ 0,02 AV: R\$ 18,96 15: R\$ 19,35  
30: R\$ 19,74 45: R\$ 20,14 60: R\$ 20,54



FORMINHA PAPEL N 5 BCA 10X100

Código: **10047** Fábrica: **PEL PLAST** Unidade: **MI/1000**  
**F1 F4**

UN: R\$ 0,02 AV: R\$ 18,96 15: R\$ 19,35  
30: R\$ 19,74 45: R\$ 20,14 60: R\$ 20,54



FORMINHA PAPEL N 5 LILAS 10X100

Código: **25061** Fábrica: **PEL PLAST** Unidade: **MI/1000**  
**F1 F4**

UN: R\$ 0,02 AV: R\$ 18,96 15: R\$ 19,35  
30: R\$ 19,74 45: R\$ 20,14 60: R\$ 20,54



FORMINHA PAPEL N 5 ROSA 10X100

Código: **10048** Fábrica: **PEL PLAST** Unidade: **MI/1000**  
**F1 F4**

UN: R\$ 0,01 AV: R\$ 13,97 15: R\$ 14,26  
30: R\$ 14,54 45: R\$ 14,83 60: R\$ 15,13



FORMINHA PAPEL N 6 AZUL CLARO 10X100

Código: **10050** Fábrica: **PEL PLAST** Unidade: **MI/1000**  
**F1 F4**

UN: R\$ 0,01 AV: R\$ 13,97 15: R\$ 14,26  
30: R\$ 14,54 45: R\$ 14,83 60: R\$ 15,13



FORMINHA PAPEL N 6 BCA 10X100

Código: **10052** Fábrica: **PEL PLAST** Unidade: **MI/1000**  
**F1 F4**

UN: R\$ 0,01 AV: R\$ 13,97 15: R\$ 14,26  
30: R\$ 14,54 45: R\$ 14,83 60: R\$ 15,13



FORMINHA PAPEL N 6 LILAS 10X100

Código: **25062** Fábrica: **PEL PLAST** Unidade: **MI/1000**  
**F1 F4**

UN: R\$ 13,97 AV: R\$ 13,97 15: R\$ 14,26  
30: R\$ 14,54 45: R\$ 14,83 60: R\$ 15,13



FORMINHA PAPEL N 6 ROSA 10X100

Código: **10051** Fábrica: **PEL PLAST** Unidade: **MI/1**  
**F1 F4**

UN: R\$ 0,01 AV: R\$ 13,97 15: R\$ 14,26  
30: R\$ 14,54 45: R\$ 14,83 60: R\$ 15,13



FORMINHA PAPEL N 6 SORTIDO 10X100

Código: **50794** Fábrica: **PEL PLAST** Unidade: **MI/1000**  
**F1 F4**

UN: R\$ 0,01 AV: R\$ 13,97 15: R\$ 14,26  
30: R\$ 14,54 45: R\$ 14,83 60: R\$ 15,13



FORMINHA PAPEL N 6 VERMELHO 10X100  
Código: Fábrica: Unidade:  
**50768** PELPLAST MI/1000  
F1 F4

UN: R\$ 35,86 AV: R\$ 35,86 15: R\$ 36,61  
30: R\$ 37,34 45: R\$ 38,09 60: R\$ 38,85



FORTELECEDOR DE MAOS FERRO PLAST 37057  
Código: Fábrica: Unidade:  
**48341** CONVOY SPORT UN/1  
F1 F4

UN: R\$ 10,54 AV: R\$ 10,54 15: R\$ 10,76  
30: R\$ 10,98 45: R\$ 11,20 60: R\$ 11,42



FORTELECEDOR DE MAOS 37060  
Código: Fábrica: Unidade:  
**48340** CONVOY SPORT UN/1  
F1 F4

UN: R\$ 6,98 AV: R\$ 6,98 15: R\$ 7,12  
30: R\$ 7,27 45: R\$ 7,41 60: R\$ 7,56



FUSIVEL AUTOMOTIVO 6-24 VOLT 15 PCS 1333  
Código: Fábrica: Unidade:  
**49561** ALIANCA CR/1  
F1 F4

UN: R\$ 2,77 AV: R\$ 5,54 15: R\$ 5,66  
30: R\$ 5,77 45: R\$ 5,89 60: R\$ 6,00



GANCHO PLAST 4CM EMOJI 7036-C CTL 3X1  
Código: Fábrica: Unidade:  
**38457** FENIMA CR/2  
F1 F4

UN: R\$ 1,85 AV: R\$ 5,54 15: R\$ 5,66  
30: R\$ 5,77 45: R\$ 5,89 60: R\$ 6,00



GANCHO PLAST 4CM 7036-D CTL 3X1  
Código: Fábrica: Unidade:  
**38454** FENIMA CR/3  
F1 F4

UN: R\$ 1,85 AV: R\$ 5,54 15: R\$ 5,66  
30: R\$ 5,77 45: R\$ 5,89 60: R\$ 6,00



GANCHO PLAST 5CM 7200 CTL 3X1  
Código: Fábrica: Unidade:  
**38455** FENIMA CR/3  
F1 F4

UN: R\$ 7,98 AV: R\$ 7,98 15: R\$ 8,14  
30: R\$ 8,31 45: R\$ 8,47 60: R\$ 8,64



GRAFITE EM PO 25 GRS FORT FITE  
Código: Fábrica: Unidade:  
**38883** FORT FITE UN/1  
F1 F4

UN: R\$ 0,50 AV: R\$ 11,98 15: R\$ 12,23  
30: R\$ 12,48 45: R\$ 12,72 60: R\$ 12,98

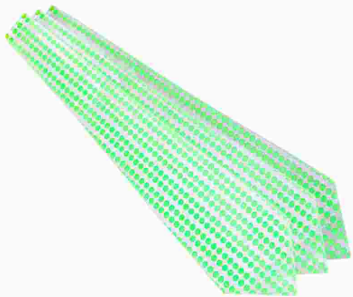

GRAVATA COLOR P/FESTAS 13681 24X1  
Código: Fábrica: Unidade:  
**40307** IMP PT/24  
F4

UN: R\$ 19,96 AV: R\$ 19,96 15: R\$ 20,37  
30: R\$ 20,78 45: R\$ 21,20 60: R\$ 21,62



GUARDA CHUVA 8 V MINI CB CURV MAN 1300  
Código: Fábrica: Unidade:  
**14086** ELITE UN/1  
F1 F4

UN: R\$ 17,99 AV: R\$ 17,99 15: R\$ 17,99  
30: R\$ 17,99 45: R\$ 17,99 60: R\$ 17,99



GUARDA CHUVA 8 V MINI CB RETO MAN 1295  
Código: Fábrica: Unidade:  
**12056** ELITE UN/1  
F1 F4

UN: R\$ 25,99 AV: R\$ 25,99 15: R\$ 25,99  
30: R\$ 25,99 45: R\$ 25,99 60: R\$ 25,99



GUARDA CHUVA 8V GIG CB RETO AUT 1220A-3  
Código: Fábrica: Unidade:  
**17676** RISOVIT UN/1  
F1 F4

UN: R\$ 26,95 AV: R\$ 26,95 15: R\$ 27,51  
30: R\$ 28,06 45: R\$ 28,62 60: R\$ 29,19



GUARDA CHUVA 8V LONG CB CURVO AUT 12203  
Código: Fábrica: Unidade:  
**17651** HIMEB UN/1  
F1 F4

UN: R\$ 24,99 AV: R\$ 24,99 15: R\$ 24,99  
30: R\$ 24,99 45: R\$ 24,99 60: R\$ 24,99



GUARDA CHUVA 8V MED CB CURVO AUT 1241  
Código: Fábrica: Unidade:  
**14095** ELITE UN/1  
F1 F4

UN: R\$ 26,95 AV: R\$ 26,95 15: R\$ 27,51  
30: R\$ 28,06 45: R\$ 28,62 60: R\$ 29,19



GUARDA CHUVA 8V MED CB CURVO AUT 2250  
Código: Fábrica: Unidade:  
**17666** HIMEB UN/1  
F1 F4

UN: R\$ 22,95 AV: R\$ 22,95 15: R\$ 23,43  
30: R\$ 23,90 45: R\$ 24,38 60: R\$ 24,87



GUARDA CHUVA 8V MINI CB CURVO MAN 3930  
Código: Fábrica: Unidade:  
**23002** HIMEB UN/1  
F1 F4

UN: R\$ 19,99 AV: R\$ 19,99 15: R\$ 19,99  
30: R\$ 19,99 45: R\$ 19,99 60: R\$ 19,99



GUARDA CHUVA 8V MINI CB RETO MAN 3950  
Código: 13271 Fábrica: HIMEB Unidade: UN/1  
F1 F4

UN: R\$ 16,47 AV: R\$ 16,47 15: R\$ 16,82  
30: R\$ 17,15 45: R\$ 17,50 60: R\$ 17,85



GUARDA CHUVA 8V MINI CB RETO MAN 903.3  
Código: 14092 Fábrica: MIZPA Unidade: UN/1  
F1 F4

UN: R\$ 42,92 AV: R\$ 42,92 15: R\$ 43,82  
30: R\$ 44,69 45: R\$ 45,59 60: R\$ 46,50



GUARDA CHUVA GIG BASTAO AUT G07/17/587  
Código: 12058 Fábrica: CHL Unidade: UN/1  
F1 F4

UN: R\$ 13,99 AV: R\$ 13,99 15: R\$ 13,99  
30: R\$ 13,99 45: R\$ 13,99 60: R\$ 13,99



GUARDA CHUVA INF 1070AB  
Código: 23004 Fábrica: JL Unidade: UN/1  
F1 F4

UN: R\$ 18,96 AV: R\$ 18,96 15: R\$ 19,35  
30: R\$ 19,74 45: R\$ 20,14 60: R\$ 20,54



GUARDA CHUVA INF 8V CB CURVO AUT 50001  
Código: 21990 Fábrica: CASITA Unidade: UN/1  
F1 F4

UN: R\$ 39,93 AV: R\$ 39,93 15: R\$ 40,76  
30: R\$ 41,57 45: R\$ 42,40 60: R\$ 43,25



GUARDA CHUVA 10V GIG 3 DOBRA MAN 3750FIT  
Código: 31681 Fábrica: HIMEB Unidade: UN/1  
F1 F4

UN: R\$ 0,93 AV: R\$ 46,39 15: R\$ 47,35  
30: R\$ 48,30 45: R\$ 49,27 60: R\$ 50,25



IMA 6X2MM RED PRATA CTL 14878-09 50X1  
Código: 48544 Fábrica: KIT Unidade: CR/50  
F1 F4

UN: R\$ 2,35 AV: R\$ 2,35 15: R\$ 2,40  
30: R\$ 2,44 45: R\$ 2,49 60: R\$ 2,54



IMA DE GELADEIRA 3428 ANIMAIS VAR. PQ  
Código: 18110 Fábrica: BRASLU Unidade: UN/1  
F1 F4

UN: R\$ 1,72 AV: R\$ 1,72 15: R\$ 1,75  
30: R\$ 1,79 45: R\$ 1,82 60: R\$ 1,86



IMA DE GELADEIRA 7216 BIC. AQUATICOS PQ  
Código: 18109 Fábrica: BRASLU Unidade: UN/1  
F1 F4

UN: R\$ 0,24 AV: R\$ 24,05 15: R\$ 24,55  
30: R\$ 25,04 45: R\$ 25,54 60: R\$ 26,06



IMA 10X3MM RED PRETO CTL 14878-03 100X1  
Código: 48545 Fábrica: KIT Unidade: CR/100  
F1 F4

UN: R\$ 0,26 AV: R\$ 26,49 15: R\$ 27,04  
30: R\$ 27,58 45: R\$ 28,13 60: R\$ 28,69



IMA 12X3MM RED PRETO CTL 14878-04 100X1  
Código: 48546 Fábrica: KIT Unidade: CR/100  
F1 F4

UN: R\$ 2,30 AV: R\$ 22,95 15: R\$ 23,43  
30: R\$ 23,90 45: R\$ 24,38 60: R\$ 24,87



IMA 15MM BLISTER 10X1  
Código: 48274 Fábrica: STALO Unidade: PT/10  
F1 F4

UN: R\$ 0,42 AV: R\$ 21,09 15: R\$ 21,53  
30: R\$ 21,96 45: R\$ 22,40 60: R\$ 22,84



IMA 15X3MM RED PRETO CTL 14878-05 50X1  
Código: 48547 Fábrica: KIT Unidade: CR/50  
F1 F4

UN: R\$ 0,45 AV: R\$ 22,31 15: R\$ 22,78  
30: R\$ 23,23 45: R\$ 23,70 60: R\$ 24,17



IMA 18X3MM RED PRETO CTL 14878-06 50X1  
Código: 48548 Fábrica: KIT Unidade: CR/50  
F1 F4

UN: R\$ 6,49 AV: R\$ 77,88 15: R\$ 79,50  
30: R\$ 81,09 45: R\$ 82,71 60: R\$ 84,36



IMA 2X8MMX1MT 20X1  
Código: 43399 Fábrica: DJW Unidade: CT/12  
F1 F4

UN: R\$ 0,50 AV: R\$ 24,80 15: R\$ 25,32  
30: R\$ 25,82 45: R\$ 26,34 60: R\$ 26,87



IMA 20X3MM RED PRETO CTL 14878-07 50X1  
Código: 48549 Fábrica: KIT Unidade: CR/50  
F1 F4

UN: R\$ 3,51 AV: R\$ 3,51 15: R\$ 3,59  
30: R\$ 3,66 45: R\$ 3,73 60: R\$ 3,81



INTERRUPTOR 2 TECLAS C/ PLACA REF 1347

Código: Fábrica: Unidade:  
**7820** BLACK BULL UN/1  
F1 F4

UN: R\$ 3,29 AV: R\$ 32,94 15: R\$ 33,62  
30: R\$ 34,30 45: R\$ 34,98 60: R\$ 35,68



ISQUEIRO COLOR DUCK 10X1

Código: Fábrica: Unidade:  
**37667** DUCK CT/10  
F1 F4

UN: R\$ 6,98 AV: R\$ 6,98 15: R\$ 7,12  
30: R\$ 7,27 45: R\$ 7,41 60: R\$ 7,56



KIT AGULHA BICO ENCHER BOLA 5PCS 3813

Código: Fábrica: Unidade:  
**40935** WINMAX CR/1  
F1 F4

UN: R\$ 4,88 AV: R\$ 4,88 15: R\$ 4,98  
30: R\$ 5,08 45: R\$ 5,19 60: R\$ 5,29



KIT DE REPAROS P/PNEU DE BICICLETA 3266

Código: Fábrica: Unidade:  
**34057** SQ CR/1  
F1 F4

UN: R\$ 149,75 AV: R\$ 149,75 15: R\$ 152,87  
30: R\$ 155,93 45: R\$ 159,05 60: R\$ 162,23

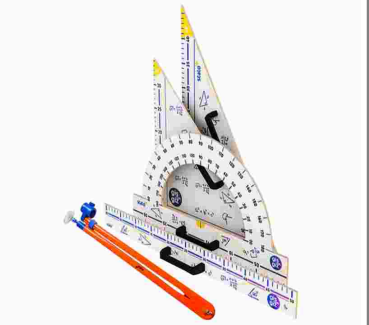

KIT INSTRUMENTO GEOMETRICO MDF PROF 4765

Código: Fábrica: Unidade:  
**49489** STALO UN/1  
F1 F4

UN: R\$ 5,09 AV: R\$ 5,09 15: R\$ 5,20  
30: R\$ 5,30 45: R\$ 5,41 60: R\$ 5,52



KIT REPARO PNEU DE BICICLETA 7X1 CTL 759

Código: Fábrica: Unidade:  
**37324** AGUIA BRANCA UN/1  
F1 F4

UN: R\$ 11,50 AV: R\$ 11,50 15: R\$ 11,74  
30: R\$ 11,98 45: R\$ 12,22 60: R\$ 12,46



KIT REPARO PNEU S/CAMERA 6X1 CTL HM60

Código: Fábrica: Unidade:  
**49478** HOME&MORE CR/1  
F1 F4

UN: R\$ 6,98 AV: R\$ 6,98 15: R\$ 7,12  
30: R\$ 7,27 45: R\$ 7,41 60: R\$ 7,56



LAMPADA BULBO LED 9W BIV 6500K BCA FRIA

Código: Fábrica: Unidade:  
**47386** TASHIBRA UN/1  
F1 F4

UN: R\$ 9,97 AV: R\$ 9,97 15: R\$ 10,18  
30: R\$ 10,39 45: R\$ 10,59 60: R\$ 10,81



LAMPADA BULBO LED 20W BIV 6500K BCA FRIA

Código: Fábrica: Unidade:  
**47385** TECHLUZ UN/1  
F1 F4

UN: R\$ 15,96 AV: R\$ 15,96 15: R\$ 16,30  
30: R\$ 16,62 45: R\$ 16,96 60: R\$ 17,29



LAMPADA BULBO LED 30W BIV 6500K BCA FRIA

Código: Fábrica: Unidade:  
**47384** TECHLUZ/KIAN UN/1  
F1 F4

UN: R\$ 29,94 AV: R\$ 29,94 15: R\$ 30,57  
30: R\$ 31,18 45: R\$ 31,80 60: R\$ 32,44



LAMPADA BULBO LED 50W BIV 6500K BCA FRIA

Código: Fábrica: Unidade:  
**47383** TECHLUZ/AVAN UN/1  
F1 F4

UN: R\$ 36,94 AV: R\$ 36,94 15: R\$ 37,71  
30: R\$ 38,46 45: R\$ 39,23 60: R\$ 40,02



LANTERNA 1 LED FLASHLIGHT USB REC 1237

Código: Fábrica: Unidade:  
**40937** AGUIA BRANCA UN/1  
F1 F4

UN: R\$ 36,94 AV: R\$ 36,94 15: R\$ 37,71  
30: R\$ 38,46 45: R\$ 39,23 60: R\$ 40,02



LANTERNA 1 LED FLASHLIGHT USB REC 1268

Código: Fábrica: Unidade:  
**40938** AGUIA BRANCA UN/1  
F1 F4

UN: R\$ 22,43 AV: R\$ 22,43 15: R\$ 22,90  
30: R\$ 23,36 45: R\$ 23,83 60: R\$ 24,30



LANTERNA 1 LED 0.5W SS-850-1 314 RECARR

Código: Fábrica: Unidade:  
**33165** WINMAX UN/1  
F1 F4

UN: R\$ 18,96 AV: R\$ 18,96 15: R\$ 19,35  
30: R\$ 19,74 45: R\$ 20,14 60: R\$ 20,54



LANTERNA 1 LED 1W RECARREGAVEL BIV 4014

Código: Fábrica: Unidade:  
**50141** GP6 UN/1  
F1 F4

UN: R\$ 20,23 AV: R\$ 20,23 15: R\$ 20,65  
30: R\$ 21,06 45: R\$ 21,48 60: R\$ 21,91



LANTERNA 1 LED 1W RECARREGAVEL BIV 4015

Código: Fábrica: Unidade:  
**50142** GP6 UN/1  
F1 F4

UN: R\$ 58,91 AV: R\$ 58,91 15: R\$ 60,13  
30: R\$ 61,34 45: R\$ 62,56 60: R\$ 63,81



LANTERNA 1 LED 5W 24CM EXC PILHA ZW-443  
Código: Fábrica: Unidade:  
**36443** AGUIA BRANCA UN/1  
F1 F4

UN: R\$ 75,88 AV: R\$ 75,88 15: R\$ 77,46  
30: R\$ 79,01 45: R\$ 80,59 60: R\$ 82,20



LANTERNA 1 LED 8000W VEIC POLICIAL RECA  
Código: Fábrica: Unidade:  
**40863** WINMAX UN/1  
F1 F4

UN: R\$ 10,97 AV: R\$ 10,97 15: R\$ 11,20  
30: R\$ 11,43 45: R\$ 11,65 60: R\$ 11,89



LANTERNA 2 LED BC/VM BICICLETA 158 2X1  
Código: Fábrica: Unidade:  
**37287** AGUIA BRANCA UN/1  
F1 F4

UN: R\$ 29,94 AV: R\$ 29,94 15: R\$ 30,57  
30: R\$ 31,18 45: R\$ 31,80 60: R\$ 32,44



LANTERNA 2 LED MAN PORTATIL 1536/900  
Código: Fábrica: Unidade:  
**33649** AGUIA BRANCA UN/1  
F1 F4

UN: R\$ 1,99 AV: R\$ 1,99 15: R\$ 2,03  
30: R\$ 2,07 45: R\$ 2,11 60: R\$ 2,15



LANTERNA CHAVEIRO PLAST 1 LED 658  
Código: Fábrica: Unidade:  
**49981** VIPIMPORT UN/1  
F1 F4

UN: R\$ 9,17 AV: R\$ 109,99 15: R\$ 112,29  
30: R\$ 114,53 45: R\$ 116,82 60: R\$ 119,16



LANTERNA FORM INTERRUPTOR PILHA 166 12X1  
Código: Fábrica: Unidade:  
**34787** AGUIA BRANCA CX/12  
F1 F4

UN: R\$ 49,92 AV: R\$ 49,92 15: R\$ 50,96  
30: R\$ 51,98 45: R\$ 53,02 60: R\$ 54,08



LANTERNA USB BICICLETA C/BUZINA RECAR 11  
Código: Fábrica: Unidade:  
**40862** WINMAX UN/1  
F1 F4

UN: R\$ 21,67 AV: R\$ 21,67 15: R\$ 22,12  
30: R\$ 22,56 45: R\$ 23,01 60: R\$ 23,47



LANTERNA 1 LED 0,5W 14CM RECARR 3383  
Código: Fábrica: Unidade:  
**37076** SQ UN/1  
F1 F4

UN: R\$ 36,71 AV: R\$ 36,71 15: R\$ 37,48  
30: R\$ 38,23 45: R\$ 38,99 60: R\$ 39,77



LANTERNA 1 LED 2W CABECA RECAR 4196  
Código: Fábrica: Unidade:  
**49756** SQ UN/1  
F1 F4

UN: R\$ 8,98 AV: R\$ 26,95 15: R\$ 27,51  
30: R\$ 28,06 45: R\$ 28,62 60: R\$ 29,19



LENCO MASCULINO PREMIER P/BOLSO 2405 3X1  
Código: Fábrica: Unidade:  
**2097** PREMIER CX/3  
F1 F4

UN: R\$ 12,98 AV: R\$ 129,78 15: R\$ 132,49  
30: R\$ 135,14 45: R\$ 137,84 60: R\$ 140,60



LINHA NYLON PESCA 4,0 100M 0,33MM 10X1  
Código: Fábrica: Unidade:  
**30578** MAX FORCE CX/10  
F4

UN: R\$ 13,98 AV: R\$ 139,77 15: R\$ 142,68  
30: R\$ 145,53 45: R\$ 148,44 60: R\$ 151,41



LINHA NYLON PESCA 5,0 100M 0,37MM 10X1  
Código: Fábrica: Unidade:  
**19153** MAX FORCE CX/10  
F4

UN: R\$ 16,97 AV: R\$ 169,72 15: R\$ 173,25  
30: R\$ 176,72 45: R\$ 180,25 60: R\$ 183,86



LINHA NYLON PESCA 8 100M 0,47MM 10X1  
Código: Fábrica: Unidade:  
**44375** MAX FORCE CX/10  
F4

UN: R\$ 4,31 AV: R\$ 4,31 15: R\$ 4,40  
30: R\$ 4,49 45: R\$ 4,58 60: R\$ 4,67



LINHA NYLON PESCA 0,20MM 100M  
Código: Fábrica: Unidade:  
**43327** DOURADO RL/1  
F1 F4

UN: R\$ 4,74 AV: R\$ 4,74 15: R\$ 4,84  
30: R\$ 4,94 45: R\$ 5,04 60: R\$ 5,14



LINHA NYLON PESCA 0,25MM DOURADO 100M  
Código: Fábrica: Unidade:  
**47840** DOURADO RL/1  
F1 F4

UN: R\$ 7,59 AV: R\$ 7,59 15: R\$ 7,75  
30: R\$ 7,90 45: R\$ 8,06 60: R\$ 8,22



LINHA NYLON PESCA 0.3MM 200M  
Código: Fábrica: Unidade:  
**50045** NYBC RL/1  
F1 F4

UN: R\$ 5,39 AV: R\$ 5,39 15: R\$ 5,50  
30: R\$ 5,61 45: R\$ 5,73 60: R\$ 5,84



LINHA NYLON PESCA 0,30MM DOURADO 100M  
Código: Fábrika: Unidade:  
**47841** DOURADO RL/1  
F1 F4

UN: R\$ 6,24 AV: R\$ 6,24 15: R\$ 6,37  
30: R\$ 6,50 45: R\$ 6,63 60: R\$ 6,76



LINHA NYLON PESCA 0,35 DOURADO 100M  
Código: Fábrika: Unidade:  
**47842** DOURADO RL/1  
F1 F4

UN: R\$ 4,98 AV: R\$ 4,98 15: R\$ 5,09  
30: R\$ 5,19 45: R\$ 5,29 60: R\$ 5,40



LINHA NYLON PESCA 0.35MM 100M R-101  
Código: Fábrika: Unidade:  
**50042** NYBC RL/1  
F1 F4

UN: R\$ 31,94 AV: R\$ 31,94 15: R\$ 32,60  
30: R\$ 33,26 45: R\$ 33,92 60: R\$ 34,60



LINHA NYLON PESCA 0,35MM 800M 35-R-101  
Código: Fábrika: Unidade:  
**45091** NYBC RL/1  
F1 F4

UN: R\$ 5,24 AV: R\$ 5,24 15: R\$ 5,35  
30: R\$ 5,46 45: R\$ 5,57 60: R\$ 5,68



LINHA NYLON PESCA 0.4MM 100M  
Código: Fábrika: Unidade:  
**50041** NYBC RL/1  
F1 F4

UN: R\$ 5,48 AV: R\$ 5,48 15: R\$ 5,60  
30: R\$ 5,71 45: R\$ 5,82 60: R\$ 5,94



LINHA NYLON PESCA 0.45MM 100M  
Código: Fábrika: Unidade:  
**50043** NYBC RL/1  
F1 F4

UN: R\$ 5,98 AV: R\$ 5,98 15: R\$ 6,11  
30: R\$ 6,23 45: R\$ 6,35 60: R\$ 6,48



LINHA NYLON PESCA 0.5MM 100M  
Código: Fábrika: Unidade:  
**50044** NYBC RL/1  
F1 F4

UN: R\$ 20,97 AV: R\$ 209,65 15: R\$ 214,02  
30: R\$ 218,30 45: R\$ 222,67 60: R\$ 227,12



LINHA NYLON PESCA 10 100M 0,52MM 10X1  
Código: Fábrika: Unidade:  
**34077** MAX FORCE CX/10  
F4

UN: R\$ 23,96 AV: R\$ 239,61 15: R\$ 244,60  
30: R\$ 249,49 45: R\$ 254,48 60: R\$ 259,57



LINHA NYLON PESCA 14 100M 0,62MM 10X1  
Código: Fábrika: Unidade:  
**34078** MAX FORCE CX/10  
F4

UN: R\$ 40,93 AV: R\$ 409,33 15: R\$ 417,86  
30: R\$ 426,22 45: R\$ 434,74 60: R\$ 443,44



LINHA NYLON PESCA 30 100M 0,92MM 10X1  
Código: Fábrika: Unidade:  
**44105** MAX FORCE CX/10  
F4

UN: R\$ 7,48 AV: R\$ 7,48 15: R\$ 7,63  
30: R\$ 7,79 45: R\$ 7,94 60: R\$ 8,10



LINHA NYLON PESCA 30MMX100M 1547  
Código: Fábrika: Unidade:  
**41535** ELITE UN/1  
F1 F4

UN: R\$ 7,98 AV: R\$ 7,98 15: R\$ 8,14  
30: R\$ 8,31 45: R\$ 8,47 60: R\$ 8,64



LINHA NYLON PESCA 40 100M  
Código: Fábrika: Unidade:  
**47843** FBG RL/1  
F1 F4

UN: R\$ 16,97 AV: R\$ 169,72 15: R\$ 173,25  
30: R\$ 176,72 45: R\$ 180,25 60: R\$ 183,86



LINHA NYLON PESCA 5,5 100M 0,40MM 10X1  
Código: Fábrika: Unidade:  
**19148** MAX FORCE CX/10  
F4

UN: R\$ 15,97 AV: R\$ 159,73 15: R\$ 163,06  
30: R\$ 166,32 45: R\$ 169,65 60: R\$ 173,04



LINHA NYLON PESCA 6 MAX 100M 0,43MM 10X1  
Código: Fábrika: Unidade:  
**38944** MAX FORCE CX/10  
F4

UN: R\$ 3,48 AV: R\$ 3,48 15: R\$ 3,56  
30: R\$ 3,63 45: R\$ 3,70 60: R\$ 3,77



LINHA NYLON 0.20MM 100M 608020  
Código: Fábrika: Unidade:  
**48538** KIT RL/1  
F1 F4

UN: R\$ 4,34 AV: R\$ 4,34 15: R\$ 4,43  
30: R\$ 4,52 45: R\$ 4,61 60: R\$ 4,70

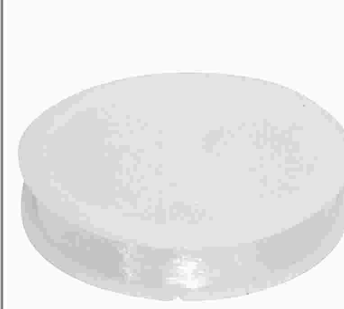

LINHA NYLON 0.25MM 100M 608025  
Código: Fábrika: Unidade:  
**48539** KIT RL/1  
F1 F4

UN: R\$ 4,93 AV: R\$ 4,93 15: R\$ 5,03  
30: R\$ 5,14 45: R\$ 5,24 60: R\$ 5,34

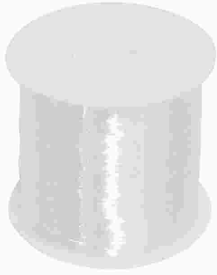

LINHA NYLON 0.30MM 100M 608030  
Código: Fábrika: Unidade:  
**48540** KIT RL/1  
F1 F4

UN: R\$ 6,80 AV: R\$ 6,80 15: R\$ 6,94  
30: R\$ 7,08 45: R\$ 7,22 60: R\$ 7,37



LINHA NYLON 0.35MM 100M 608035  
Código: Fábrika: Unidade:  
**48541** KIT RL/1  
F1 F4

UN: R\$ 8,24 AV: R\$ 8,24 15: R\$ 8,41  
30: R\$ 8,58 45: R\$ 8,75 60: R\$ 8,92



LINHA NYLON 0.40MM 100M 608040  
Código: Fábrika: Unidade:  
**48542** KIT RL/1  
F1 F4

UN: R\$ 74,87 AV: R\$ 74,87 15: R\$ 76,43  
30: R\$ 77,96 45: R\$ 79,52 60: R\$ 81,11



LUMINARIA SOLAR C/SENSOR DE PRESENCIA  
Código: Fábrika: Unidade:  
**44280** ALFACELL UN/1  
F1 F4

UN: R\$ 4,98 AV: R\$ 4,98 15: R\$ 5,09  
30: R\$ 5,19 45: R\$ 5,29 60: R\$ 5,40



LUPA 50MM LENTE OPTICA RX 5  
Código: Fábrika: Unidade:  
**49396** CLASSE UN/1  
F1 F4

UN: R\$ 7,45 AV: R\$ 7,45 15: R\$ 7,60  
30: R\$ 7,76 45: R\$ 7,91 60: R\$ 8,07



LUPA 60MM 10003  
Código: Fábrika: Unidade:  
**46733** WIN PAPER UN/1  
F1 F4

UN: R\$ 8,59 AV: R\$ 8,59 15: R\$ 8,77  
30: R\$ 8,94 45: R\$ 9,12 60: R\$ 9,30



LUPA 75MM 10002  
Código: Fábrika: Unidade:  
**24140** WIN PAPER UN/1  
F1 F4

UN: R\$ 12,97 AV: R\$ 12,97 15: R\$ 13,24  
30: R\$ 13,50 45: R\$ 13,77 60: R\$ 14,05



LUPA 100MM 10001  
Código: Fábrika: Unidade:  
**24141** WIN PAPER UN/1  
F1 F4

UN: R\$ 6,48 AV: R\$ 6,48 15: R\$ 6,61  
30: R\$ 6,75 45: R\$ 6,88 60: R\$ 7,02



LUPA 60MM FUY-31  
Código: Fábrika: Unidade:  
**31766** FUTURO UN/1  
F1 F4

13 cm

UN: R\$ 2,75 AV: R\$ 32,99 15: R\$ 32,99  
30: R\$ 32,99 45: R\$ 32,99 60: R\$ 32,99



LUVA ADULTO LISA 13 12 PARES  
Código: Fábrika: Unidade:  
**14152** HSD PT/12  
F1 F4

UN: R\$ 2,50 AV: R\$ 29,99 15: R\$ 29,99  
30: R\$ 29,99 45: R\$ 29,99 60: R\$ 29,99



LUVA ADULTO MESCLADA 12 12 PARES  
Código: Fábrika: Unidade:  
**22147** HSD PT/12  
F1 F4

UN: R\$ 12,99 AV: R\$ 12,99 15: R\$ 12,99  
30: R\$ 12,99 45: R\$ 12,99 60: R\$ 12,99



LUVA LA AD LISTRADA YX1301T  
Código: Fábrika: Unidade:  
**44479** DOTAD UN/1  
F1 F4

UN: R\$ 18,99 AV: R\$ 18,99 15: R\$ 18,99  
30: R\$ 18,99 45: R\$ 18,99 60: R\$ 18,99



LUVA LA AD TOUCH VINTAGE PIGMEN YX1307EM  
Código: Fábrika: Unidade:  
**44480** DOTAD UN/1  
F1 F4

CORES

UN: R\$ 11,77 AV: R\$ 11,77 15: R\$ 12,02  
30: R\$ 12,26 45: R\$ 12,50 60: R\$ 12,75



LUVA LA AD UNISSEX YX1349TRI  
Código: Fábrika: Unidade:  
**44462** DOTAD UN/1  
F1 F4

UN: R\$ 10,99 AV: R\$ 10,99 15: R\$ 10,99  
30: R\$ 10,99 45: R\$ 10,99 60: R\$ 10,99



LUVA LA ADULTO TRAD ESTAMPADA 3005  
Código: Fábrika: Unidade:  
**44476** GLX UN/1  
F1 F4

UN: R\$ 6,99 AV: R\$ 6,99 15: R\$ 6,99  
30: R\$ 6,99 45: R\$ 6,99 60: R\$ 6,99



LUVA LA INF DEDO VAZADO YX0201-1  
Código: Fábrika: Unidade:  
**44465** DOTAD UN/1  
F1 F4

UN: R\$ 9,98 AV: R\$ 99,83 15: R\$ 101,91  
30: R\$ 103,95 45: R\$ 106,03 60: R\$ 108,15



LUVA LA INFANTIL BICHINHO G 3059 10X1  
Código: Fábrica: Unidade:  
**41827** GLX PT/10  
F1 F4

UN: R\$ 9,98 AV: R\$ 99,83 15: R\$ 101,91  
30: R\$ 103,95 45: R\$ 106,03 60: R\$ 108,15



LUVA LA INFANTIL BICHINHO M 3059 10X1  
Código: Fábrica: Unidade:  
**41825** GLX PT/10  
F1 F4

UN: R\$ 9,00 AV: R\$ 89,99 15: R\$ 89,99  
30: R\$ 89,99 45: R\$ 89,99 60: R\$ 89,99



LUVA LA INFANTIL BICHINHO P 3059 10X1  
Código: Fábrica: Unidade:  
**41826** GLX PT/10  
F1 F4

UN: R\$ 9,97 AV: R\$ 9,97 15: R\$ 10,18  
30: R\$ 10,39 45: R\$ 10,59 60: R\$ 10,81



LUVA LA INFANTIL LUXO P/FRIO 828  
Código: Fábrica: Unidade:  
**6689** RIO MASTER UN/1  
F1 F4

UN: R\$ 3,78 AV: R\$ 3,78 15: R\$ 3,86  
30: R\$ 3,94 45: R\$ 4,02 60: R\$ 4,10



LUVA LATEX MULTI USO AZUL G/9 UN  
Código: Fábrica: Unidade:  
**50824** VOLK BRASIL UN/1  
F1 F4

UN: R\$ 3,78 AV: R\$ 3,78 15: R\$ 3,86  
30: R\$ 3,94 45: R\$ 4,02 60: R\$ 4,10



LUVA LATEX MULTI USO AZUL P/7 UN  
Código: Fábrica: Unidade:  
**50825** VOLK BRASIL UN/1  
F1 F4

UN: R\$ 8,29 AV: R\$ 8,29 15: R\$ 8,46  
30: R\$ 8,63 45: R\$ 8,80 60: R\$ 8,98



LUVA LATEX P M G  
Código: Fábrica: Unidade:  
**41678** IMBAT UN/1  
F1 F4

UN: R\$ 3,78 AV: R\$ 3,78 15: R\$ 3,86  
30: R\$ 3,94 45: R\$ 4,02 60: R\$ 4,10



LUVA LATEX SLIM AMARELA M/8 38828 UN  
Código: Fábrica: Unidade:  
**30328** NOBRE UN/1  
F1 F4

UN: R\$ 3,78 AV: R\$ 3,78 15: R\$ 3,86  
30: R\$ 3,94 45: R\$ 4,02 60: R\$ 4,10



LUVA LATEX SLIM AMARELA P 38827 UN  
Código: Fábrica: Unidade:  
**44096** NOBRE UN/1  
F1 F4

UN: R\$ 3,78 AV: R\$ 3,78 15: R\$ 3,86  
30: R\$ 3,94 45: R\$ 4,02 60: R\$ 4,10



LUVA LATEX SLIM VERDE P/7 37972 UN  
Código: Fábrica: Unidade:  
**47824** NOBRE UN/1  
F1 F4

UN: R\$ 34,99 AV: R\$ 34,99 15: R\$ 34,99  
30: R\$ 34,99 45: R\$ 34,99 60: R\$ 34,99



LUVA MOTOQUEIRO EMBORRACHADA 0127  
Código: Fábrica: Unidade:  
**44498** LURS UN/1  
F1 F4

UN: R\$ 25,99 AV: R\$ 25,99 15: R\$ 25,99  
30: R\$ 25,99 45: R\$ 25,99 60: R\$ 25,99



LUVA MOTOQUEIRO POLIESTER PS0140EM  
Código: Fábrica: Unidade:  
**44464** DOTAD UN/1  
F1 F4

UN: R\$ 23,95 AV: R\$ 23,95 15: R\$ 24,45  
30: R\$ 24,94 45: R\$ 25,44 60: R\$ 25,95



LUVA MOTOQUEIRO POLIESTER PS2310-SP  
Código: Fábrica: Unidade:  
**44463** DOTAD UN/1  
F1 F4

UN: R\$ 15,97 AV: R\$ 15,97 15: R\$ 16,31  
30: R\$ 16,63 45: R\$ 16,97 60: R\$ 17,31



LUVA P/NOTEBOOK C/ZIPER 11 DINA NINA  
Código: Fábrica: Unidade:  
**17754** MAXIMA UN/1  
F1 F4

UN: R\$ 16,47 AV: R\$ 16,47 15: R\$ 16,82  
30: R\$ 17,15 45: R\$ 17,50 60: R\$ 17,85



LUVA P/NOTEBOOK C/ZIPER 14 DINA NINA  
Código: Fábrica: Unidade:  
**25669** MAXIMA UN/1  
F1 F4

UN: R\$ 16,47 AV: R\$ 16,47 15: R\$ 16,82  
30: R\$ 17,15 45: R\$ 17,50 60: R\$ 17,85



LUVA P/NOTEBOOK C/ZIPER 15,6 DINA NINA  
Código: Fábrica: Unidade:  
**7056** MAXIMA UN/1  
F1 F4

UN: R\$ 4,16 AV: R\$ 49,91 15: R\$ 50,95  
30: R\$ 51,97 45: R\$ 53,01 60: R\$ 54,07



LUVA TRICOTADA LEVE BRANCA 12 PARES

Código: 38667 Fábrica: IMBAT Unidade: PT/12 F1 F4

UN: R\$ 2,99 AV: R\$ 35,88 15: R\$ 35,88  
30: R\$ 35,88 45: R\$ 35,88 60: R\$ 35,88

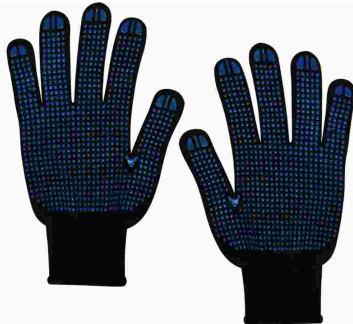

LUVA TRICOTADA LEVE PRETA PIG 763 12PARE

Código: 41937 Fábrica: IMBAT Unidade: PT/12 F1 F4

UN: R\$ 5,98 AV: R\$ 5,98 15: R\$ 6,11  
30: R\$ 6,23 45: R\$ 6,35 60: R\$ 6,48

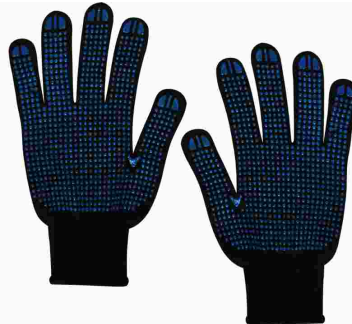

LUVA TRICOTADA PRETA C/PIGMENTADA 1 PAR

Código: 41760 Fábrica: IMBAT Unidade: UN/1 F1 F4

UN: R\$ 4,99 AV: R\$ 59,89 15: R\$ 61,14  
30: R\$ 62,36 45: R\$ 63,61 60: R\$ 64,88

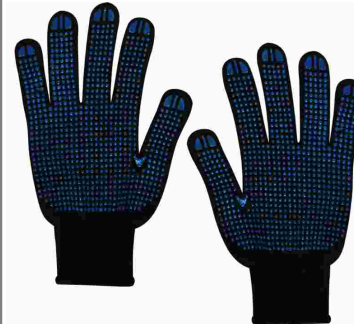

LUVA TRICOTADA PRETA PIG 762 12 PARES

Código: 38669 Fábrica: IMBAT Unidade: PT/12 F1 F4

UN: R\$ 298,52 AV: R\$ 298,52 15: R\$ 304,74  
30: R\$ 310,84 45: R\$ 317,05 60: R\$ 323,39



MALA VIAGEM AEROP AZUL GDE 27"

Código: 33667 Fábrica: VIAGGIO Unidade: UN/1 F1 F4

UN: R\$ 209,66 AV: R\$ 209,66 15: R\$ 214,03  
30: R\$ 218,31 45: R\$ 222,68 60: R\$ 227,13



MALA VIAGEM AEROP AZUL PEQ 19"

Código: 33661 Fábrica: VIAGGIO Unidade: UN/1 F1 F4

UN: R\$ 699,99 AV: R\$ 699,99 15: R\$ 699,99  
30: R\$ 699,99 45: R\$ 699,99 60: R\$ 699,99



MALA VIAGEM AEROP AZUL 19/23/27" 3X1

Código: 48520 Fábrica: VIAGGIO Unidade: CJ/1 F1 F4

UN: R\$ 299,51 AV: R\$ 299,51 15: R\$ 305,75  
30: R\$ 311,86 45: R\$ 318,10 60: R\$ 324,46



MALA VIAGEM AEROP LARANJ 19" ABS360° 10H

Código: 37693 Fábrica: WILSON Unidade: UN/1 F1 F4

UN: R\$ 298,52 AV: R\$ 298,52 15: R\$ 304,74  
30: R\$ 310,84 45: R\$ 317,05 60: R\$ 323,39



MALA VIAGEM AEROP MARRON GDE 27"

Código: 48601 Fábrica: VIAGGIO Unidade: UN/1 F1 F4

UN: R\$ 253,72 AV: R\$ 253,72 15: R\$ 259,01  
30: R\$ 264,19 45: R\$ 269,47 60: R\$ 274,86



MALA VIAGEM AEROP MARRON MED 23"

Código: 48600 Fábrica: VIAGGIO Unidade: UN/1 F1 F4

UN: R\$ 209,66 AV: R\$ 209,66 15: R\$ 214,03  
30: R\$ 218,31 45: R\$ 222,68 60: R\$ 227,13



MALA VIAGEM AEROP MARRON PEQ 19"

Código: 48602 Fábrica: VIAGGIO Unidade: UN/1 F1 F4

UN: R\$ 699,99 AV: R\$ 699,99 15: R\$ 699,99  
30: R\$ 699,99 45: R\$ 699,99 60: R\$ 699,99



MALA VIAGEM AEROP MARRON 19/23/27" 3X1

Código: 42573 Fábrica: VIAGGIO Unidade: CJ/1 F1 F4

UN: R\$ 898,55 AV: R\$ 898,55 15: R\$ 917,27  
30: R\$ 935,62 45: R\$ 954,33 60: R\$ 973,41



MALA VIAGEM AEROP PRETA 19/23/27" 3X1

Código: 43665 Fábrica: MALAS MUNDI Unidade: CJ/1 F1 F4

UN: R\$ 699,99 AV: R\$ 699,99 15: R\$ 699,99  
30: R\$ 699,99 45: R\$ 699,99 60: R\$ 699,99



MALA VIAGEM AEROP PRETA 19/23/27" 3X1

Código: 40340 Fábrica: VIAGGIO Unidade: CJ/1 F1 F4

UN: R\$ 289,54 AV: R\$ 289,54 15: R\$ 295,57  
30: R\$ 301,48 45: R\$ 307,51 60: R\$ 313,66



MALA VIAGEM AEROP PRETO GDE 27"

Código: 33665 Fábrica: VIAGGIO Unidade: UN/1 F1 F4

UN: R\$ 253,72 AV: R\$ 253,72 15: R\$ 259,01  
30: R\$ 264,19 45: R\$ 269,47 60: R\$ 274,86



MALA VIAGEM AEROP PRETO MED 23"

Código: 33662 Fábrica: VAGGIO Unidade: UN/1 F1 F4

UN: R\$ 209,66 AV: R\$ 209,66 15: R\$ 214,03  
30: R\$ 218,31 45: R\$ 222,68 60: R\$ 227,13



MALA VIAGEM AEROP PRETO PEQ 19"

Código: 33659 Fábrica: VAGGIO Unidade: UN/1 F1 F4

UN: R\$ 499,19 AV: R\$ 499,19 15: R\$ 509,59  
30: R\$ 519,78 45: R\$ 530,18 60: R\$ 540,78



MALA VIAGEM AEROP PRETO 19/23" 2X1

Código: 38257 Fábrica: SPEXPRESS Unidade: CJ/1 F1 F4

UN: R\$ 49,91 AV: R\$ 49,91 15: R\$ 50,95  
30: R\$ 51,97 45: R\$ 53,01 60: R\$ 54,07



MANETE JOGOS USB 203Z

Código: 42195 Fábrica: INOVA Unidade: UN/1 F1 F4

UN: R\$ 4,98 AV: R\$ 4,98 15: R\$ 5,09  
30: R\$ 5,19 45: R\$ 5,29 60: R\$ 5,40



MANGUEIRA DE BOMBA ENCHER PNEU 50CM 1359

Código: 30685 Fábrica: BESTFER Unidade: UN/1 F1 F4

UN: R\$ 11,97 AV: R\$ 11,97 15: R\$ 12,22  
30: R\$ 12,46 45: R\$ 12,71 60: R\$ 12,97



MANGUITO (MANGA PROTECAO SOLAR P/BRACOS)

Código: 31765 Fábrica: CJL Unidade: UN/1 F1 F4

UN: R\$ 3,83 AV: R\$ 22,96 15: R\$ 23,44  
30: R\$ 23,91 45: R\$ 24,39 60: R\$ 24,88



MAOZINHA COCA COCA PLAST COLOR 12X1

Código: 39696 Fábrica: ITALY'S Unidade: PT/6 F1 F4

UN: R\$ 43,83 AV: R\$ 43,83 15: R\$ 44,74  
30: R\$ 45,64 45: R\$ 46,55 60: R\$ 47,48



MASSA P/BISCUIT 1 KG NATURAL

Código: 50385 Fábrica: POLYCOL Unidade: PT/1 F1 F4

UN: R\$ 3,98 AV: R\$ 3,98 15: R\$ 4,07  
30: R\$ 4,15 45: R\$ 4,23 60: R\$ 4,32



MEIA AEROBICA DEFENDER ALGODAO 5246

Código: 35470 Fábrica: APOLLO Unidade: UN/1 F1 F4

UN: R\$ 3,93 AV: R\$ 11,79 15: R\$ 12,04  
30: R\$ 12,28 45: R\$ 12,52 60: R\$ 12,77



MEIA AEROBICA DEFENDER ALGODAO 5246 3X1

Código: 35467 Fábrica: APOLLO Unidade: PT/3 F1 F4

UN: R\$ 5,71 AV: R\$ 5,71 15: R\$ 5,83  
30: R\$ 5,95 45: R\$ 6,07 60: R\$ 6,19



MEIA AEROBICA FEM 33A38 850

Código: 32723 Fábrica: APOLLO Unidade: UN/1 F1 F4

UN: R\$ 9,98 AV: R\$ 9,98 15: R\$ 10,19  
30: R\$ 10,40 45: R\$ 10,60 60: R\$ 10,82



MEIA CALÇA GEOMETRICA 17468

Código: 40683 Fábrica: ACTIONWEAR Unidade: UN/1 F1 F4

UN: R\$ 19,96 AV: R\$ 19,96 15: R\$ 20,37  
30: R\$ 20,78 45: R\$ 21,20 60: R\$ 21,62



MEIA CANO CURTO PRO BIKE NO LIMITS 5161

Código: 32719 Fábrica: FLINDERS Unidade: UN/1 F1 F4

UN: R\$ 3,49 AV: R\$ 3,49 15: R\$ 3,57  
30: R\$ 3,64 45: R\$ 3,71 60: R\$ 3,79



MEIA ESPORTIVA JUVENIL 546

Código: 15908 Fábrica: APOLLO Unidade: UN/1 F1 F4

UN: R\$ 5,99 AV: R\$ 5,99 15: R\$ 6,12  
30: R\$ 6,24 45: R\$ 6,36 60: R\$ 6,49



MEIA FEMININA FINA 3/4 POA

Código: 15801 Fábrica: ACTIONWEAR Unidade: UN/1 F1 F4

UN: R\$ 0,83 AV: R\$ 9,99 15: R\$ 9,99  
30: R\$ 9,99 45: R\$ 9,99 60: R\$ 9,99



MEIA INF SOCIAL STILLO KIDS 403 12X1

Código: 10691 Fábrica: STILLO Unidade: DZ/12 F1 F4

UN: R\$ 4,16 AV: R\$ 49,91 15: R\$ 50,95  
30: R\$ 51,97 45: R\$ 53,01 60: R\$ 54,07



MEIA INFANTIL DEC FEM P/M/G 881 12X1

Código: 32720 Fábrica: APOLLO Unidade: PT/12 F1 F4

UN: R\$ 4,16 AV: R\$ 49,91 15: R\$ 50,95  
30: R\$ 51,97 45: R\$ 53,01 60: R\$ 54,07



MEIA INFANTIL DEC MASC P/M/G 874 12X1

Código: Fábrika: Unidade:  
**32721** APOLLO PT/12  
F1 F4

UN: R\$ 3,85 AV: R\$ 11,55 15: R\$ 11,79  
30: R\$ 12,03 45: R\$ 12,27 60: R\$ 12,51



MEIA MASC DEFENDER ALGODAO 5215 3X1

Código: Fábrika: Unidade:  
**35466** APOLLO PT/3  
F1 F4

UN: R\$ 3,78 AV: R\$ 3,78 15: R\$ 3,86  
30: R\$ 3,94 45: R\$ 4,02 60: R\$ 4,10



MEIA MASC DEFENDER ALGODAO 5215/5314

Código: Fábrika: Unidade:  
**35471** APOLLO UN/1  
F1 F4

UN: R\$ 4,87 AV: R\$ 4,87 15: R\$ 4,97  
30: R\$ 5,07 45: R\$ 5,17 60: R\$ 5,28



MEIA MASC INV ALGODAO 584

Código: Fábrika: Unidade:  
**33904** APOLLO UN/1  
F1 F4

UN: R\$ 3,44 AV: R\$ 3,44 15: R\$ 3,52  
30: R\$ 3,59 45: R\$ 3,66 60: R\$ 3,73



MEIA MASC INV DEFENDER ALGODAO 5222

Código: Fábrika: Unidade:  
**35469** APOLLO UN/1  
F1 F4

UN: R\$ 3,44 AV: R\$ 10,33 15: R\$ 10,55  
30: R\$ 10,76 45: R\$ 10,97 60: R\$ 11,19



MEIA MASC INV DEFENDER ALGODAO 5222 3X1

Código: Fábrika: Unidade:  
**35468** APOLLO PT/3  
F1 F4

UN: R\$ 4,48 AV: R\$ 4,48 15: R\$ 4,58  
30: R\$ 4,67 45: R\$ 4,76 60: R\$ 4,86



MEIA SAPATILHA FEM ALGODAO 607

Código: Fábrika: Unidade:  
**27819** APOLLO UN/1  
F1 F4

UN: R\$ 5,32 AV: R\$ 15,96 15: R\$ 16,30  
30: R\$ 16,62 45: R\$ 16,96 60: R\$ 17,29



MEIA SAPATILHA FEM C/ELASTANO 5024 3X1

Código: Fábrika: Unidade:  
**15802** APOLLO PT/3  
F1 F4

UN: R\$ 4,16 AV: R\$ 49,91 15: R\$ 50,95  
30: R\$ 51,97 45: R\$ 53,01 60: R\$ 54,07



MEIA SAPATILHA FEM INF 27A34 5055 12X1

Código: Fábrika: Unidade:  
**32725** APOLLO PT/12  
F1 F4

UN: R\$ 3,15 AV: R\$ 3,15 15: R\$ 3,21  
30: R\$ 3,27 45: R\$ 3,34 60: R\$ 3,41



MEIA SAPATILHA FEM JUVENIL 0089

Código: Fábrika: Unidade:  
**22160** APOLLO UN/1  
F1 F4

UN: R\$ 1,09 AV: R\$ 1,09 15: R\$ 1,11  
30: R\$ 1,13 45: R\$ 1,16 60: R\$ 1,18



MEIA SAPATILHA FEM MEIA FINA PEZINHO

Código: Fábrika: Unidade:  
**1798** CRUZEIRO UN/1  
F1 F4

UN: R\$ 7,28 AV: R\$ 7,28 15: R\$ 7,43  
30: R\$ 7,58 45: R\$ 7,73 60: R\$ 7,88



MEIA SAPATILHA MASC FITN 38A43 5086

Código: Fábrika: Unidade:  
**45276** APOLLO UN/1  
F1 F4

UN: R\$ 4,16 AV: R\$ 49,91 15: R\$ 50,95  
30: R\$ 51,97 45: R\$ 53,01 60: R\$ 54,07



MEIA SAPATILHA MASC INF 31A34 5062 12X1

Código: Fábrika: Unidade:  
**32724** APOLLO PT/12  
F1 F4

UN: R\$ 4,98 AV: R\$ 4,98 15: R\$ 5,09  
30: R\$ 5,19 45: R\$ 5,29 60: R\$ 5,40



MEIA SAPATILHA MASC INV ALGODAO 553

Código: Fábrika: Unidade:  
**24551** APOLLO UN/1  
F1 F4

UN: R\$ 4,66 AV: R\$ 27,95 15: R\$ 28,53  
30: R\$ 29,10 45: R\$ 29,68 60: R\$ 30,27



MEIA SAPATILHA MASC INVISIVEL 5284 6X1

Código: Fábrika: Unidade:  
**45277** APOLLO PT/6  
F1 F4

UN: R\$ 4,86 AV: R\$ 14,57 15: R\$ 14,87  
30: R\$ 15,17 45: R\$ 15,47 60: R\$ 15,78



MEIA SAPATILHA MASC INVISIVEL 997 3X1

Código: Fábrika: Unidade:  
**15803** APOLLO PT/3  
F1 F4

UN: R\$ 8,98 AV: R\$ 8,98 15: R\$ 9,16  
30: R\$ 9,35 45: R\$ 9,53 60: R\$ 9,72



MEIA SAPATILHA MASC NO LIMITS 38A43 5192

Código: Fábrika: Unidade:  
**32722** FLINDERS UN/1  
F1 F4

UN: R\$ 7,49 AV: R\$ 89,85 15: R\$ 91,72  
30: R\$ 93,55 45: R\$ 95,42 60: R\$ 97,33



MEIA SOCIAL MASC 5109 12X1

Código: Fábrika: Unidade:  
**128** APOLLO PT/12  
F1 F4

UN: R\$ 4,48 AV: R\$ 4,48 15: R\$ 4,58  
30: R\$ 4,67 45: R\$ 4,76 60: R\$ 4,86



MEIA SOQUETE FEM ALGODAO 34A39 539

Código: Fábrika: Unidade:  
**33488** APOLLO UN/1  
F1 F4

UN: R\$ 25,95 AV: R\$ 25,95 15: R\$ 26,49  
30: R\$ 27,02 45: R\$ 27,56 60: R\$ 28,11



MICROFONE C/FIO DINAMICO NA CX 969M

Código: Fábrika: Unidade:  
**13527** IDEA UN/1  
F1 F4

UN: R\$ 7,95 AV: R\$ 7,95 15: R\$ 7,95  
30: R\$ 7,95 45: R\$ 7,95 60: R\$ 7,95



MOCHILA SACO PISCINA (PORTA CHUTEIRA)

Código: Fábrika: Unidade:  
**44334** WEAREEYES UN/1  
F1 F4

UN: R\$ 15,96 AV: R\$ 15,96 15: R\$ 16,30  
30: R\$ 16,62 45: R\$ 16,96 60: R\$ 17,29



MOCHILA SACO PISCINA (PORTA CHUTEIRA)

Código: Fábrika: Unidade:  
**22145** CJL UN/1  
F1 F4

UN: R\$ 53,90 AV: R\$ 53,90 15: R\$ 55,03  
30: R\$ 56,13 45: R\$ 57,25 60: R\$ 58,39



MOLINETE BH200 1 ROL

Código: Fábrika: Unidade:  
**5759** TAUÉ CX/1  
F4

UN: R\$ 4,98 AV: R\$ 4,98 15: R\$ 5,09  
30: R\$ 5,19 45: R\$ 5,29 60: R\$ 5,40



MUNHEQUEIRA 12 CM 10614

Código: Fábrika: Unidade:  
**44522** NICOBEM UN/1  
F1 F4

UN: R\$ 81,87 AV: R\$ 81,87 15: R\$ 83,57  
30: R\$ 85,25 45: R\$ 86,95 60: R\$ 88,69



MURAL C/8 PORTA RET 10X15+1 20X25 MAD 09

Código: Fábrika: Unidade:  
**35182** MM QUADROS UN/1  
F1 F4

UN: R\$ 4,79 AV: R\$ 4,79 15: R\$ 4,79  
30: R\$ 4,79 45: R\$ 4,79 60: R\$ 4,79



NAFTALINA 50 GRS APROX 30 BOLAS

Código: Fábrika: Unidade:  
**49341** SANILAR PT/1  
F1 F4

UN: R\$ 30,95 AV: R\$ 30,95 15: R\$ 31,60  
30: R\$ 32,23 45: R\$ 32,87 60: R\$ 33,53



NAVALHETE PROF DOURADA

Código: Fábrika: Unidade:  
**40751** OSTRICH UN/1  
F1 F4

UN: R\$ 17,77 AV: R\$ 17,77 15: R\$ 18,14  
30: R\$ 18,50 45: R\$ 18,87 60: R\$ 19,25



NECESSAIRE C/DIVISORIAS 19000

Código: Fábrika: Unidade:  
**36839** GLX UN/1  
F1 F4

UN: R\$ 15,31 AV: R\$ 15,31 15: R\$ 15,62  
30: R\$ 15,94 45: R\$ 16,26 60: R\$ 16,58



NECESSAIRE ESTAMPADA OVAL 19002

Código: Fábrika: Unidade:  
**37770** FELE UN/1  
F1 F4

UN: R\$ 13,99 AV: R\$ 13,99 15: R\$ 13,99  
30: R\$ 13,99 45: R\$ 13,99 60: R\$ 13,99



NECESSAIRE ESTAMPADA QUAD 19002

Código: Fábrika: Unidade:  
**37755** FELE UN/1  
F1 F4

UN: R\$ 11,98 AV: R\$ 11,98 15: R\$ 12,23  
30: R\$ 12,48 45: R\$ 12,72 60: R\$ 12,98



OCULOS ESPORTIVO

Código: Fábrika: Unidade:  
**25525** CJL UN/1  
F1 F4

UN: R\$ 12,48 AV: R\$ 12,48 15: R\$ 12,74  
30: R\$ 12,99 45: R\$ 13,25 60: R\$ 13,52



OCULOS GRAU 0,25

Código: Fábrika: Unidade:  
**26391** CJL UN/1  
F4

UN: R\$ 12,48 AV: R\$ 12,48 15: R\$ 12,74  
30: R\$ 12,99 45: R\$ 13,25 60: R\$ 13,52



OCULOS GRAU 0,50

Código: 26734 Fábrica: CJL Unidade: UN/1 F4

UN: R\$ 12,48 AV: R\$ 12,48 15: R\$ 12,74  
30: R\$ 12,99 45: R\$ 13,25 60: R\$ 13,52



OCULOS GRAU 0,75

Código: 26192 Fábrica: CJL Unidade: UN/1 F4

UN: R\$ 12,48 AV: R\$ 12,48 15: R\$ 12,74  
30: R\$ 12,99 45: R\$ 13,25 60: R\$ 13,52



OCULOS GRAU 1,00

Código: 25528 Fábrica: CJL Unidade: UN/1 F4

UN: R\$ 12,48 AV: R\$ 12,48 15: R\$ 12,74  
30: R\$ 12,99 45: R\$ 13,25 60: R\$ 13,52



OCULOS GRAU 1,25

Código: 26003 Fábrica: CJL Unidade: UN/1 F4

UN: R\$ 12,48 AV: R\$ 12,48 15: R\$ 12,74  
30: R\$ 12,99 45: R\$ 13,25 60: R\$ 13,52



OCULOS GRAU 1,50

Código: 25995 Fábrica: CJL Unidade: UN/1 F4

UN: R\$ 12,48 AV: R\$ 12,48 15: R\$ 12,74  
30: R\$ 12,99 45: R\$ 13,25 60: R\$ 13,52



OCULOS GRAU 1,75

Código: 26004 Fábrica: CJL Unidade: UN/1 F4

UN: R\$ 12,48 AV: R\$ 12,48 15: R\$ 12,74  
30: R\$ 12,99 45: R\$ 13,25 60: R\$ 13,52



OCULOS GRAU 2,00

Código: 25996 Fábrica: CJL Unidade: UN/1 F4

UN: R\$ 12,48 AV: R\$ 12,48 15: R\$ 12,74  
30: R\$ 12,99 45: R\$ 13,25 60: R\$ 13,52



OCULOS GRAU 2,25

Código: 25997 Fábrica: CJL Unidade: UN/1 F4

UN: R\$ 12,48 AV: R\$ 12,48 15: R\$ 12,74  
30: R\$ 12,99 45: R\$ 13,25 60: R\$ 13,52



OCULOS GRAU 2,50

Código: 25998 Fábrica: CJL Unidade: UN/1 F4

UN: R\$ 12,48 AV: R\$ 12,48 15: R\$ 12,74  
30: R\$ 12,99 45: R\$ 13,25 60: R\$ 13,52



OCULOS GRAU 2,75

Código: 25999 Fábrica: CJL Unidade: UN/1 F4

UN: R\$ 12,48 AV: R\$ 12,48 15: R\$ 12,74  
30: R\$ 12,99 45: R\$ 13,25 60: R\$ 13,52



OCULOS GRAU 3,00

Código: 26000 Fábrica: CJL Unidade: UN/1 F4

UN: R\$ 12,48 AV: R\$ 12,48 15: R\$ 12,74  
30: R\$ 12,99 45: R\$ 13,25 60: R\$ 13,52



OCULOS GRAU 3,25

Código: 29659 Fábrica: CJL Unidade: UN/1 F4

UN: R\$ 12,48 AV: R\$ 12,48 15: R\$ 12,74  
30: R\$ 12,99 45: R\$ 13,25 60: R\$ 13,52



OCULOS GRAU 3,50

Código: 26392 Fábrica: CJL Unidade: UN/1 F4

UN: R\$ 12,48 AV: R\$ 12,48 15: R\$ 12,74  
30: R\$ 12,99 45: R\$ 13,25 60: R\$ 13,52



OCULOS GRAU 3,75

Código: 29646 Fábrica: CJL Unidade: UN/1 F4

UN: R\$ 12,48 AV: R\$ 12,48 15: R\$ 12,74  
30: R\$ 12,99 45: R\$ 13,25 60: R\$ 13,52



OCULOS GRAU 4,00

Código: 26393 Fábrica: CJL Unidade: UN/1 F4

UN: R\$ 12,48 AV: R\$ 12,48 15: R\$ 12,74  
30: R\$ 12,99 45: R\$ 13,25 60: R\$ 13,52



OCULOS GRAU 4,50

Código: 50884 Fábrica: CJL Unidade: UN/1 F4

UN: R\$ 12,48 AV: R\$ 12,48 15: R\$ 12,74  
30: R\$ 12,99 45: R\$ 13,25 60: R\$ 13,52



OCULOS GRAU 5,00

Código: Fábrika: Unidade:  
**50885** CJL UN/1  
F4

UN: R\$ 15,96 AV: R\$ 15,96 15: R\$ 16,30  
30: R\$ 16,62 45: R\$ 16,96 60: R\$ 17,29



OCULOS INF P/MERGULHO C/ACESSORIOS 3665

Código: Fábrika: Unidade:  
**42876** FIRST UN/1  
F1 F4

UN: R\$ 6,98 AV: R\$ 6,98 15: R\$ 7,12  
30: R\$ 7,27 45: R\$ 7,41 60: R\$ 7,56



OCULOS INFANTIL P/ NATACAO 16X5,2CM 0679

Código: Fábrika: Unidade:  
**10024** SUPER99 UN/1  
F1 F4

UN: R\$ 11,98 AV: R\$ 11,98 15: R\$ 12,23  
30: R\$ 12,48 45: R\$ 12,72 60: R\$ 12,98



OCULOS OAKL

Código: Fábrika: Unidade:  
**28018** CJL UN/1  
F1 F4

UN: R\$ 7,98 AV: R\$ 7,98 15: R\$ 8,14  
30: R\$ 8,31 45: R\$ 8,47 60: R\$ 8,64



OCULOS SOL AD PURPLE DEGRADE FUME 8218

Código: Fábrika: Unidade:  
**41507** SPECTRE UN/1  
F1 F4

UN: R\$ 7,98 AV: R\$ 7,98 15: R\$ 8,14  
30: R\$ 8,31 45: R\$ 8,47 60: R\$ 8,64



OCULOS SOL INF LILAS BCO ROSA MY1621

Código: Fábrika: Unidade:  
**41498** SPECTRE UN/1  
F1 F4

UN: R\$ 7,98 AV: R\$ 7,98 15: R\$ 8,14  
30: R\$ 8,31 45: R\$ 8,47 60: R\$ 8,64



OCULOS SOL INF PTO VERMELHO MY1611

Código: Fábrika: Unidade:  
**41499** SPECTRE UN/1  
F1 F4

UN: R\$ 7,98 AV: R\$ 7,98 15: R\$ 8,14  
30: R\$ 8,31 45: R\$ 8,47 60: R\$ 8,64



OCULOS SOL INF ROSA FUME MSL108

Código: Fábrika: Unidade:  
**41497** SPECTRE UN/1  
F1 F4

UN: R\$ 7,98 AV: R\$ 7,98 15: R\$ 8,14  
30: R\$ 8,31 45: R\$ 8,47 60: R\$ 8,64



OCULOS SOL INF ROSA FUME SRK039

Código: Fábrika: Unidade:  
**41496** SPECTRE UN/1  
F1 F4

UN: R\$ 11,98 AV: R\$ 11,98 15: R\$ 12,23  
30: R\$ 12,48 45: R\$ 12,72 60: R\$ 12,98



OCULOS TIPO DIOR 02

Código: Fábrika: Unidade:  
**33142** CRUZESOUZA UN/1  
F4

UN: R\$ 11,98 AV: R\$ 11,98 15: R\$ 12,23  
30: R\$ 12,48 45: R\$ 12,72 60: R\$ 12,98



OCULOS TIPO RAY BAN

Código: Fábrika: Unidade:  
**32371** CRUZESOUZA UN/1  
F4

UN: R\$ 11,98 AV: R\$ 11,98 15: R\$ 12,23  
30: R\$ 12,48 45: R\$ 12,72 60: R\$ 12,98



OCULOS TIPO RAY BAN AVIADOR COLOR 19

Código: Fábrika: Unidade:  
**33140** CRUZESOUZA UN/1  
F4

UN: R\$ 11,98 AV: R\$ 11,98 15: R\$ 12,23  
30: R\$ 12,48 45: R\$ 12,72 60: R\$ 12,98



OCULOS TIPO RAY BAN AVIADOR PEQ

Código: Fábrika: Unidade:  
**32502** CRUZESOUZA UN/1  
F1 F4

UN: R\$ 11,98 AV: R\$ 11,98 15: R\$ 12,23  
30: R\$ 12,48 45: R\$ 12,72 60: R\$ 12,98



OCULOS TIPO RAY BAN ESPELHADO

Código: Fábrika: Unidade:  
**32366** CRUZESOUZA UN/1  
F4

UN: R\$ 11,98 AV: R\$ 11,98 15: R\$ 12,23  
30: R\$ 12,48 45: R\$ 12,72 60: R\$ 12,98



OCULOS TIPO RAY BAN ESPELHADO PRATA CAMU

Código: Fábrika: Unidade:  
**32522** CRUZESOUZA UN/1  
F4

UN: R\$ 4,42 AV: R\$ 4,42 15: R\$ 4,52  
30: R\$ 4,61 45: R\$ 4,70 60: R\$ 4,79



OLEO DE MAQUINA MULTI USO 90 ML

Código: Fábrika: Unidade:  
**19551** NOVOIL UN/1  
F1 F4

UN: R\$ 0,03 AV: R\$ 3,48 15: R\$ 3,56  
30: R\$ 3,63 45: R\$ 3,70 60: R\$ 3,77

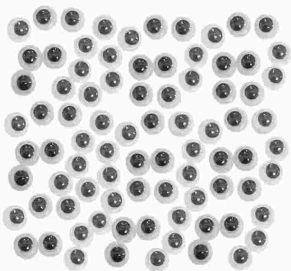

OLHINHOS C/PUPILA MOVEIS 03MM 100X1  
Código: 47631 Fábrica: ABE Unidade: PT/100  
F1 F4

UN: R\$ 0,04 AV: R\$ 3,98 15: R\$ 4,07  
30: R\$ 4,15 45: R\$ 4,23 60: R\$ 4,32

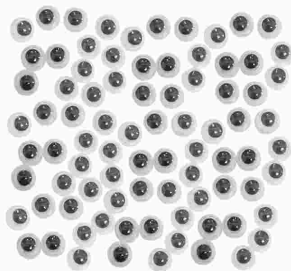

OLHINHOS C/PUPILA MOVEIS 04MM 100X1  
Código: 50053 Fábrica: NYBC Unidade: PT/100  
F1 F4

UN: R\$ 0,05 AV: R\$ 4,92 15: R\$ 5,02  
30: R\$ 5,13 45: R\$ 5,23 60: R\$ 5,33



OLHINHOS C/PUPILA MOVEIS 05MM 100X1  
Código: 42879 Fábrica: ABE Unidade: PT/100  
F1 F4

UN: R\$ 0,05 AV: R\$ 4,98 15: R\$ 5,09  
30: R\$ 5,19 45: R\$ 5,29 60: R\$ 5,40

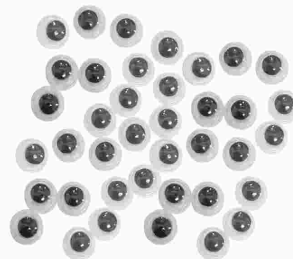

OLHINHOS C/PUPILA MOVEIS 06MM 100X1  
Código: 45134 Fábrica: NYBC Unidade: PT/100  
F1 F4

UN: R\$ 0,05 AV: R\$ 5,48 15: R\$ 5,60  
30: R\$ 5,71 45: R\$ 5,82 60: R\$ 5,94



OLHINHOS C/PUPILA MOVEIS 07MM 100X1  
Código: 45135 Fábrica: ABE Unidade: PT/100  
F1 F4

UN: R\$ 0,06 AV: R\$ 6,48 15: R\$ 6,61  
30: R\$ 6,75 45: R\$ 6,88 60: R\$ 7,02



OLHINHOS C/PUPILA MOVEIS 08MM 100X1  
Código: 46792 Fábrica: NYBC Unidade: PT/100  
F1 F4

UN: R\$ 0,09 AV: R\$ 8,98 15: R\$ 9,16  
30: R\$ 9,35 45: R\$ 9,53 60: R\$ 9,72



OLHINHOS C/PUPILA MOVEIS 10MM 100X1  
Código: 45136 Fábrica: ABE Unidade: PT/100  
F1 F4

UN: R\$ 0,12 AV: R\$ 12,27 15: R\$ 12,53  
30: R\$ 12,78 45: R\$ 13,03 60: R\$ 13,29



OLHINHOS C/PUPILA MOVEIS 12MM 100X1  
Código: 45137 Fábrica: ABE Unidade: PT/100  
F1 F4

UN: R\$ 0,22 AV: R\$ 21,87 15: R\$ 22,32  
30: R\$ 22,77 45: R\$ 23,22 60: R\$ 23,69

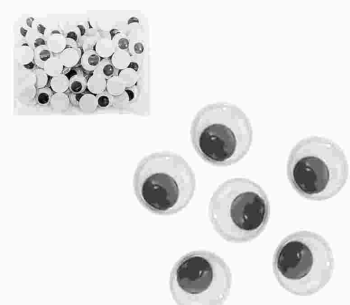

OLHINHOS C/PUPILA MOVEIS 20MM 100X1  
Código: 50386 Fábrica: ABE Unidade: PT/100  
F1 F4

UN: R\$ 4,98 AV: R\$ 4,98 15: R\$ 5,09  
30: R\$ 5,19 45: R\$ 5,29 60: R\$ 5,40



ORATORIO MDF 8X18CM 469  
Código: 45984 Fábrica: R A ARTESANA Unidade: UN/1  
F1 F4

UN: R\$ 47,92 AV: R\$ 47,92 15: R\$ 48,92  
30: R\$ 49,90 45: R\$ 50,90 60: R\$ 51,92

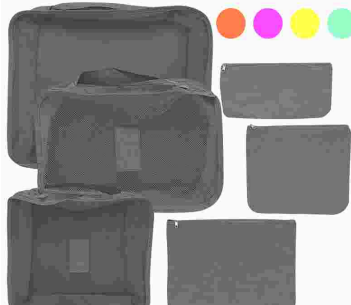

ORGANIZADOR DE MALA KIT 6 PCS 74002  
Código: 37085 Fábrica: ROCIE Unidade: KT/1  
F1 F4

UN: R\$ 8,49 AV: R\$ 8,49 15: R\$ 8,66  
30: R\$ 8,84 45: R\$ 9,01 60: R\$ 9,19



ORGANIZADOR PLAST (PORTA CONTROLE) 389  
Código: 36335 Fábrica: FUTURO Unidade: UN/1  
F1 F4

UN: R\$ 1,66 AV: R\$ 19,96 15: R\$ 20,37  
30: R\$ 20,78 45: R\$ 21,20 60: R\$ 21,62



PALHETA COLOR P-96 12X1  
Código: 37355 Fábrica: ROUXINOL Unidade: PT/12  
F1 F4

UN: R\$ 249,59 AV: R\$ 249,59 15: R\$ 254,79  
30: R\$ 259,89 45: R\$ 265,08 60: R\$ 270,39



PARAFUSADEIRA ARTICULADA 4V EMB ACRILIC  
Código: 42479 Fábrica: MICHELIN Unidade: UN/1  
F1 F4

UN: R\$ 289,53 AV: R\$ 289,53 15: R\$ 295,56  
30: R\$ 301,47 45: R\$ 307,50 60: R\$ 313,65



PARAFUSADEIRA IMPAC 12V LITI 2VEL MALETA  
Código: 42478 Fábrica: MULTILASER Unidade: UN/1  
F1 F4

UN: R\$ 3,98 AV: R\$ 3,98 15: R\$ 4,07  
30: R\$ 4,15 45: R\$ 4,23 60: R\$ 4,32



PEDRA DECORATIVA VERDE CLARO 750 GRS  
Código: 34745 Fábrica: NOVATROPICAL Unidade: PT/1  
F1 F4

UN: R\$ 3,29 AV: R\$ 3,29 15: R\$ 3,36  
30: R\$ 3,43 45: R\$ 3,50 60: R\$ 3,57

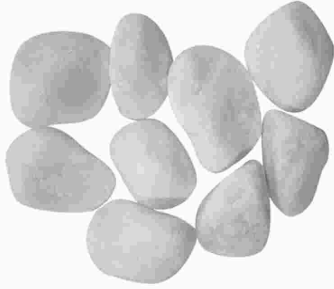

PEDRA SEIXO BRANCO 4 APROX 1 KG

Código: Fábrika: Unidade:  
**34749** ANGEL PEDRAS PT/1  
F1 F4

UN: R\$ 11,98 AV: R\$ 23,95 15: R\$ 24,45  
30: R\$ 24,94 45: R\$ 25,44 60: R\$ 25,95



PILHA ALCALINA GDE D BLISTER LR202B 2X1

Código: Fábrika: Unidade:  
**47475** ALFACELL CR/2  
F1 F4

UN: R\$ 9,98 AV: R\$ 9,98 15: R\$ 10,19  
30: R\$ 10,40 45: R\$ 10,60 60: R\$ 10,82



PILHA ALCALINA GDE D UN

Código: Fábrika: Unidade:  
**28693** ALFACELL 'U/1  
F1 F4

UN: R\$ 9,34 AV: R\$ 18,67 15: R\$ 19,06  
30: R\$ 19,44 45: R\$ 19,83 60: R\$ 20,23



PILHA ALCALINA MED TPO C BLISTE LR14 2X1

Código: Fábrika: Unidade:  
**28692** ALFACELL CR/2  
F1 F4

UN: R\$ 0,13 AV: R\$ 0,13 15: R\$ 0,13  
30: R\$ 0,13 45: R\$ 0,14 60: R\$ 0,14



PILHA ALCALINA PALITO AAA UN

Código: Fábrika: Unidade:  
**19019** ALFACELL UN/1  
F1 F4

UN: R\$ 2,74 AV: R\$ 5,48 15: R\$ 5,60  
30: R\$ 5,71 45: R\$ 5,82 60: R\$ 5,94



PILHA ALCALINA PALITO BLIST AAA 1.5V 2X1

Código: Fábrika: Unidade:  
**21666** ALFACELL/ELG CR/2  
F1 F4

UN: R\$ 2,50 AV: R\$ 74,87 15: R\$ 76,43  
30: R\$ 77,96 45: R\$ 79,52 60: R\$ 81,11



PILHA ALCALINA PALITO 1.5V AAA LR03 15X2

Código: Fábrika: Unidade:  
**46651** ALFACELL CX/30  
F1 F4

UN: R\$ 2,74 AV: R\$ 10,97 15: R\$ 11,20  
30: R\$ 11,43 45: R\$ 11,65 60: R\$ 11,89



PILHA ALCALINA PEQ AA 1.5V LR6/4 CTL 4X1

Código: Fábrika: Unidade:  
**19645** ALFACELL CR/4  
F1 F4

UN: R\$ 5,66 AV: R\$ 84,85 15: R\$ 86,62  
30: R\$ 88,35 45: R\$ 90,12 60: R\$ 91,92



PILHA ALCALINA PEQ 1.5V AA LR6 15X2

Código: Fábrika: Unidade:  
**47295** ALFACELL CX/15  
F1 F4

UN: R\$ 3,98 AV: R\$ 3,98 15: R\$ 4,07  
30: R\$ 4,15 45: R\$ 4,23 60: R\$ 4,32



PILHA ALCALINA 23AC (BATERIA 12 V) CTL

Código: Fábrika: Unidade:  
**47766** ALFACELL UN/1  
F1 F4

UN: R\$ 5,49 AV: R\$ 10,97 15: R\$ 11,20  
30: R\$ 11,43 45: R\$ 11,65 60: R\$ 11,89



PILHA COMUM GDE D 1.5V R20P/2SC 2X1

Código: Fábrika: Unidade:  
**50675** ALFACELL PT/2  
F1 F4

UN: R\$ 3,49 AV: R\$ 6,98 15: R\$ 7,12  
30: R\$ 7,27 45: R\$ 7,41 60: R\$ 7,56



PILHA COMUM MED C 1.5 R14P/2SC 2X1

Código: Fábrika: Unidade:  
**50676** ALFACELL PT/2  
F1 F4

UN: R\$ 0,55 AV: R\$ 32,94 15: R\$ 33,62  
30: R\$ 34,30 45: R\$ 34,98 60: R\$ 35,68



PILHA LONGA DUR PALITO 1.5V AAA RX4 15X4

Código: Fábrika: Unidade:  
**28654** RELINX CX/60  
F1 F4

UN: R\$ 0,67 AV: R\$ 39,93 15: R\$ 40,76  
30: R\$ 41,57 45: R\$ 42,40 60: R\$ 43,25



PILHA LONGA DUR PEQ 1.5V AA RX-3 15X4

Código: Fábrika: Unidade:  
**31768** RELINX CX/60  
F1 F4

UN: R\$ 5,98 AV: R\$ 5,98 15: R\$ 6,11  
30: R\$ 6,23 45: R\$ 6,35 60: R\$ 6,48



PILHA MED C UN

Código: Fábrika: Unidade:  
**42932** ALFACELL CR/1  
F1 F4

UN: R\$ 8,23 AV: R\$ 32,94 15: R\$ 33,62  
30: R\$ 34,30 45: R\$ 34,98 60: R\$ 35,68



PILHA PALITO AAA RECARREGAVEL 4X1

Código: Fábrika: Unidade:  
**19648** KNUP CR/4  
F1 F4

UN: R\$ 8,48 AV: R\$ 16,96 15: R\$ 17,32  
30: R\$ 17,66 45: R\$ 18,02 60: R\$ 18,38



PILHA PALITO AAA 1200MAH RECARR CTL 2X1  
Código: Fábriça: Unidade:  
**21669** ALFACELL CR/2  
F1 F4

UN: R\$ 2,37 AV: R\$ 9,48 15: R\$ 9,68  
30: R\$ 9,88 45: R\$ 10,07 60: R\$ 10,28



PILHA PALITO ALCALINA AAA 1.5V LR03 4X1  
Código: Fábriça: Unidade:  
**21797** ALFACELL CR/4  
F1 F4

UN: R\$ 1,15 AV: R\$ 4,59 15: R\$ 4,69  
30: R\$ 4,78 45: R\$ 4,88 60: R\$ 4,98



PILHA PALITO COMUM AAA 1.5V R03P/4B 4X1  
Código: Fábriça: Unidade:  
**50673** ALFACELL CR/4  
F1 F4

UN: R\$ 0,57 AV: R\$ 33,94 15: R\$ 34,64  
30: R\$ 35,34 45: R\$ 36,04 60: R\$ 36,76



PILHA PALITO 1.5V AAA R03 15X4  
Código: Fábriça: Unidade:  
**29374** FUTURO CX/60  
F1 F4

UN: R\$ 1,95 AV: R\$ 29,20 15: R\$ 29,81  
30: R\$ 30,41 45: R\$ 31,02 60: R\$ 31,64



PILHA PALITO 1.5V AAA R03P/2SG 15X2  
Código: Fábriça: Unidade:  
**50964** ALFACELL CX/15  
F1 F4

UN: R\$ 0,93 AV: R\$ 37,08 15: R\$ 37,85  
30: R\$ 38,61 45: R\$ 39,38 60: R\$ 40,17



PILHA PALITO 1.5V AAA R03P/4SGT 10X4  
Código: Fábriça: Unidade:  
**46606** ALFACELL CX/40  
F1 F4

UN: R\$ 9,98 AV: R\$ 19,96 15: R\$ 20,37  
30: R\$ 20,78 45: R\$ 21,20 60: R\$ 21,62



PILHA PEQ AA 1800MAH RECAR 2007 CTL 2X1  
Código: Fábriça: Unidade:  
**46241** ALFACELL CR/2  
F1 F4

UN: R\$ 10,58 AV: R\$ 21,17 15: R\$ 21,61  
30: R\$ 22,04 45: R\$ 22,48 60: R\$ 22,93



PILHA PEQ AA 2300MAH RECAR 2013 CTL 2X1  
Código: Fábriça: Unidade:  
**47293** ALFACELL CR/2  
F1 F4

UN: R\$ 1,30 AV: R\$ 5,19 15: R\$ 5,30  
30: R\$ 5,41 45: R\$ 5,51 60: R\$ 5,62



PILHA PEQ COMUM AA 1.5V R6P/4B 4X1  
Código: Fábriça: Unidade:  
**50674** ALFACELL CR/4  
F1 F4

UN: R\$ 4,69 AV: R\$ 46,92 15: R\$ 47,90  
30: R\$ 48,86 45: R\$ 49,84 60: R\$ 50,83



PILHA PEQ 1.5V AA R6P/4SGT 10X4  
Código: Fábriça: Unidade:  
**49922** ALFACELL CX/10  
F1 F4

UN: R\$ 3,99 AV: R\$ 39,93 15: R\$ 40,76  
30: R\$ 41,57 45: R\$ 42,40 60: R\$ 43,25

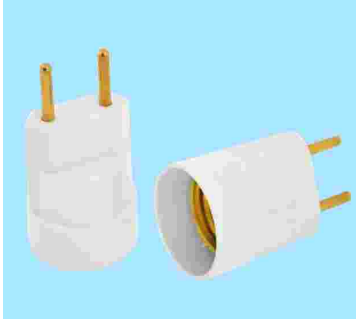

PINO PORTA LAMPADA BRANCO EF06 10X1  
Código: Fábriça: Unidade:  
**49220** GIROFLASH PT/10  
F1 F4

UN: R\$ 0,21 AV: R\$ 21,22 15: R\$ 21,66  
30: R\$ 22,09 45: R\$ 22,53 60: R\$ 22,98



PINO P/RELOGIO PULSO ACQUA 100X1  
Código: Fábriça: Unidade:  
**19989** RDE CE/100  
F1 F4

UN: R\$ 269,56 AV: R\$ 269,56 15: R\$ 275,17  
30: R\$ 280,68 45: R\$ 286,29 60: R\$ 292,02



PISTOLA LAVADORA DE ALTA PRESSAO  
Código: Fábriça: Unidade:  
**39172** HAI BRASIL UN/1  
F1 F4

UN: R\$ 8,78 AV: R\$ 43,92 15: R\$ 44,83  
30: R\$ 45,73 45: R\$ 46,65 60: R\$ 47,58

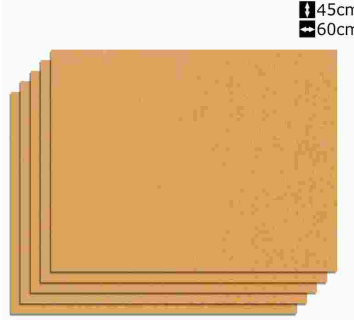

PLACA CORTICA 45X60X1MM 606 5X1  
Código: Fábriça: Unidade:  
**45600** CORTIARTE PT/5  
F1 F4

UN: R\$ 9,48 AV: R\$ 9,48 15: R\$ 9,68  
30: R\$ 9,88 45: R\$ 10,07 60: R\$ 10,28



PLACA DEC 3MM 20X30CM MDF BAR B1  
Código: Fábriça: Unidade:  
**36396** P A SOUZA UN/1  
F1 F4

UN: R\$ 9,97 AV: R\$ 9,97 15: R\$ 10,18  
30: R\$ 10,39 45: R\$ 10,59 60: R\$ 10,81



PLACA DEC 3MM 20X30CM MDF FRASES F1  
Código: Fábriça: Unidade:  
**36393** P A SOUZA UN/1  
F1 F4

UN: R\$ 9,48 AV: R\$ 9,48 15: R\$ 9,68  
30: R\$ 9,88 45: R\$ 10,07 60: R\$ 10,28

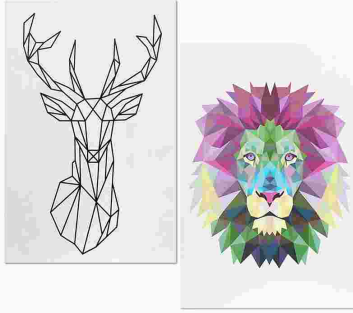

PLACA DEC 3MM 20X30CM MDF GEOMETRICO G1  
Código: Fábrika: Unidade:  
**36395** P A SOUZA UN/1  
F1 F4

UN: R\$ 9,48 AV: R\$ 9,48 15: R\$ 9,68  
30: R\$ 9,88 45: R\$ 10,07 60: R\$ 10,28



PLACA DEC 3MM 20X30CM MDF INFANTIL I1  
Código: Fábrika: Unidade:  
**36397** P A SOUZA UN/1  
F1 F4

UN: R\$ 9,48 AV: R\$ 9,48 15: R\$ 9,68  
30: R\$ 9,88 45: R\$ 10,07 60: R\$ 10,28

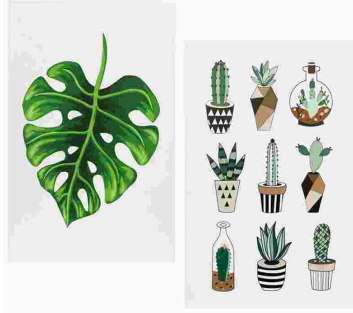

PLACA DEC 3MM 20X30CM MDF TROPICAL T1  
Código: Fábrika: Unidade:  
**36394** P A SOUZA UN/1  
F1 F4

UN: R\$ 16,67 AV: R\$ 16,67 15: R\$ 17,02  
30: R\$ 17,36 45: R\$ 17,71 60: R\$ 18,06



PLACA DEC 3MM 20X30CM MOLD BAR B3  
Código: Fábrika: Unidade:  
**45648** P A SOUZA UN/1  
F1 F4

UN: R\$ 16,67 AV: R\$ 16,67 15: R\$ 17,02  
30: R\$ 17,36 45: R\$ 17,71 60: R\$ 18,06



PLACA DEC 3MM 20X30CM MOLD FRASES F3  
Código: Fábrika: Unidade:  
**45650** P A SOUZA UN/1  
F1 F4

UN: R\$ 16,67 AV: R\$ 16,67 15: R\$ 17,02  
30: R\$ 17,36 45: R\$ 17,71 60: R\$ 18,06

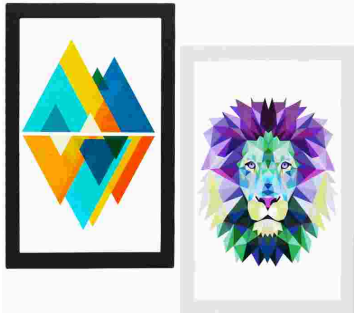

PLACA DEC 3MM 20X30CM MOLD GEOMETRICO G3  
Código: Fábrika: Unidade:  
**45654** P A SOUZA UN/1  
F1 F4

UN: R\$ 16,67 AV: R\$ 16,67 15: R\$ 17,02  
30: R\$ 17,36 45: R\$ 17,71 60: R\$ 18,06



PLACA DEC 3MM 20X30CM MOLD INFANTIL I3  
Código: Fábrika: Unidade:  
**45652** P A SOUZA UN/1  
F1 F4

UN: R\$ 16,67 AV: R\$ 16,67 15: R\$ 17,02  
30: R\$ 17,36 45: R\$ 17,71 60: R\$ 18,06



PLACA DEC 3MM 20X30CM MOLD TROPICAL T3  
Código: Fábrika: Unidade:  
**45656** P A SOUZA UN/1  
F1 F4

UN: R\$ 24,26 AV: R\$ 24,26 15: R\$ 24,77  
30: R\$ 25,26 45: R\$ 25,77 60: R\$ 26,28



PLACA DEC 3MM 20X30CM MOLD/VID BAR B5  
Código: Fábrika: Unidade:  
**45649** P A SOUZA UN/1  
F1 F4

UN: R\$ 24,26 AV: R\$ 24,26 15: R\$ 24,77  
30: R\$ 25,26 45: R\$ 25,77 60: R\$ 26,28



PLACA DEC 3MM 20X30CM MOLD/VID FRASES F5  
Código: Fábrika: Unidade:  
**45651** P A SOUZA UN/1  
F1 F4

UN: R\$ 24,26 AV: R\$ 24,26 15: R\$ 24,77  
30: R\$ 25,26 45: R\$ 25,77 60: R\$ 26,28

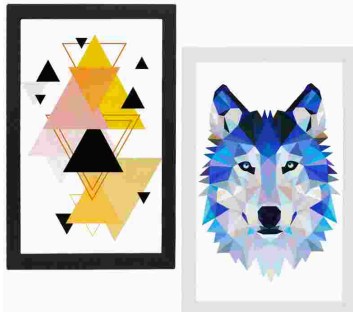

PLACA DEC 3MM 20X30CM MOLD/VID GEOMET G5  
Código: Fábrika: Unidade:  
**45655** P A SOUZA UN/1  
F1 F4

UN: R\$ 24,26 AV: R\$ 24,26 15: R\$ 24,77  
30: R\$ 25,26 45: R\$ 25,77 60: R\$ 26,28



PLACA DEC 3MM 20X30CM MOLD/VID INFANT I5  
Código: Fábrika: Unidade:  
**45653** P A SOUZA UN/1  
F1 F4

UN: R\$ 24,26 AV: R\$ 24,26 15: R\$ 24,77  
30: R\$ 25,26 45: R\$ 25,77 60: R\$ 26,28



PLACA DEC 3MM 20X30CM MOLD/VID TROPIC T5  
Código: Fábrika: Unidade:  
**45657** P A SOUZA UN/1  
F1 F4

UN: R\$ 14,97 AV: R\$ 14,97 15: R\$ 15,28  
30: R\$ 15,58 45: R\$ 15,90 60: R\$ 16,21



PLACA DECORATIVA JACK DANIELS 29X19CM  
Código: Fábrika: Unidade:  
**41745** DEBIASI UN/1  
F1 F4

UN: R\$ 11,98 AV: R\$ 11,98 15: R\$ 12,23  
30: R\$ 12,48 45: R\$ 12,72 60: R\$ 12,98



POCHETE COURINO AMASSA 2 DIV PRETA 13036  
Código: Fábrika: Unidade:  
**40503** GLX UN/1  
F1 F4

UN: R\$ 17,96 AV: R\$ 17,96 15: R\$ 18,34  
30: R\$ 18,70 45: R\$ 19,08 60: R\$ 19,46



POCHETE LONA 3 DIVISOES  
Código: Fábrika: Unidade:  
**11926** CJL UN/1  
F1 F4

UN: R\$ 11,98 AV: R\$ 11,98 15: R\$ 12,23  
30: R\$ 12,48 45: R\$ 12,72 60: R\$ 12,98



POCHETE SUEDE COLOR 2 DIVISOES 13018

Código: Fábrica: Unidade:  
**40492** GLX UN/1  
F1 F4

UN: R\$ 2,99 AV: R\$ 2,99 15: R\$ 3,05  
30: R\$ 3,11 45: R\$ 3,17 60: R\$ 3,23



POMPOM BOLA 20MM AMARELO 10X1

Código: Fábrica: Unidade:  
**50197** BB PT/1  
F1 F4

UN: R\$ 2,99 AV: R\$ 2,99 15: R\$ 3,05  
30: R\$ 3,11 45: R\$ 3,17 60: R\$ 3,23



POMPOM BOLA 20MM BRANCO 10X1

Código: Fábrica: Unidade:  
**45226** BB PT/1  
F1 F4

UN: R\$ 2,99 AV: R\$ 2,99 15: R\$ 3,05  
30: R\$ 3,11 45: R\$ 3,17 60: R\$ 3,23



POMPOM BOLA 20MM LILAS 10X1

Código: Fábrica: Unidade:  
**50201** BB PT/1  
F1 F4

UN: R\$ 2,99 AV: R\$ 2,99 15: R\$ 3,05  
30: R\$ 3,11 45: R\$ 3,17 60: R\$ 3,23



POMPOM BOLA 20MM PRETO 10X1

Código: Fábrica: Unidade:  
**50198** BB PT/1  
F1 F4

UN: R\$ 2,99 AV: R\$ 2,99 15: R\$ 3,05  
30: R\$ 3,11 45: R\$ 3,17 60: R\$ 3,23



POMPOM BOLA 20MM VERDE 10X1

Código: Fábrica: Unidade:  
**50199** BB PT/1  
F1 F4

UN: R\$ 2,99 AV: R\$ 2,99 15: R\$ 3,05  
30: R\$ 3,11 45: R\$ 3,17 60: R\$ 3,23



POMPOM BOLA 20MM VERMELHO 10X1

Código: Fábrica: Unidade:  
**50200** BB PT/1  
F1 F4

UN: R\$ 0,30 AV: R\$ 29,95 15: R\$ 30,58  
30: R\$ 31,19 45: R\$ 31,81 60: R\$ 32,45



PONTA P/TACO DE BILHAR 10MM CX 100X1

Código: Fábrica: Unidade:  
**36492** BLESSED CX/100  
F1 F4

UN: R\$ 0,62 AV: R\$ 7,49 15: R\$ 7,64  
30: R\$ 7,80 45: R\$ 7,95 60: R\$ 8,11

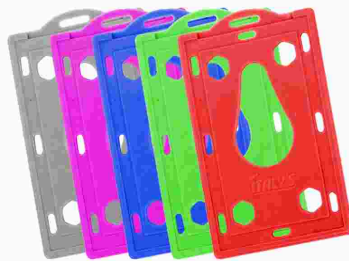

PORTA CARTAO CRED PLAST RIGIDO 12X1

Código: Fábrica: Unidade:  
**21046** ITALY'S DZ/12  
F1 F4

UN: R\$ 4,89 AV: R\$ 4,89 15: R\$ 4,99  
30: R\$ 5,09 45: R\$ 5,20 60: R\$ 5,30



PORTA ESCOVA PLAST C/ SABONETEIRA 0339

Código: Fábrica: Unidade:  
**41030** MARILU UN/1  
F1 F4

UN: R\$ 7,98 AV: R\$ 7,98 15: R\$ 8,14  
30: R\$ 8,31 45: R\$ 8,47 60: R\$ 8,64



PORTA MOEDAS BALCAO MC035

Código: Fábrica: Unidade:  
**18517** BUDEPLAST UN/1  
F1 F4

UN: R\$ 3,99 AV: R\$ 3,99 15: R\$ 4,08  
30: R\$ 4,16 45: R\$ 4,24 60: R\$ 4,33



PORTA MOEDAS DE BOLSO MB033

Código: Fábrica: Unidade:  
**33059** BUDEPLAST UN/1  
F1 F4

UN: R\$ 4,99 AV: R\$ 4,99 15: R\$ 5,10  
30: R\$ 5,20 45: R\$ 5,30 60: R\$ 5,41



PORTA MOEDAS DE PERUEIRO MP034

Código: Fábrica: Unidade:  
**33060** BUDEPLAST UN/1  
F1 F4

UN: R\$ 49,91 AV: R\$ 49,91 15: R\$ 50,95  
30: R\$ 51,97 45: R\$ 53,01 60: R\$ 54,07



PORTA RET AGUA 10X15CM FORMATURA 2335

Código: Fábrica: Unidade:  
**39047** BRASFOOT UN/1  
F1 F4

UN: R\$ 6,78 AV: R\$ 6,78 15: R\$ 6,92  
30: R\$ 7,06 45: R\$ 7,20 60: R\$ 7,34



PORTA RET MAD 10X15CM ACET 46 MOD 115

Código: Fábrica: Unidade:  
**13849** P A SOUZA UN/1  
F1 F4

UN: R\$ 6,78 AV: R\$ 6,78 15: R\$ 6,92  
30: R\$ 7,06 45: R\$ 7,20 60: R\$ 7,34



PORTA RET MAD 10X15CM ACET 50 MOD 116

Código: Fábrica: Unidade:  
**8828** P A SOUZA UN/1  
F1 F4

UN: R\$ 6,78 AV: R\$ 6,78 15: R\$ 6,92  
30: R\$ 7,06 45: R\$ 7,20 60: R\$ 7,34



PORTA RET MAD 10X15CM ACET 65 MOD 010  
Código: Fábrica: Unidade:  
**6482** P A SOUZA UN/1  
F1 F4

UN: R\$ 6,78 AV: R\$ 6,78 15: R\$ 6,92  
30: R\$ 7,06 45: R\$ 7,20 60: R\$ 7,34



PORTA RET MAD 10X15CM ACET 1015  
Código: Fábrica: Unidade:  
**40979** SANTA RITA UN/1  
F1 F4

UN: R\$ 6,78 AV: R\$ 6,78 15: R\$ 6,92  
30: R\$ 7,06 45: R\$ 7,20 60: R\$ 7,34



PORTA RET MAD 10X15CM ACET 146 MOD 020  
Código: Fábrica: Unidade:  
**8822** P A SOUZA UN/1  
F1 F4

UN: R\$ 9,97 AV: R\$ 9,97 15: R\$ 10,18  
30: R\$ 10,39 45: R\$ 10,59 60: R\$ 10,81

CORES



PORTA RET MAD 10X15CM RUSTIC ACET 005  
Código: Fábrica: Unidade:  
**45763** MOLDULAC UN/1  
F1 F4

UN: R\$ 8,99 AV: R\$ 8,99 15: R\$ 8,99  
30: R\$ 8,99 45: R\$ 8,99 60: R\$ 8,99



PORTA RET MAD 10X15CM VIDRO EXTRA LUXO  
Código: Fábrica: Unidade:  
**48746** SANTA RITA UN/1  
F1 F4

UN: R\$ 8,88 AV: R\$ 8,88 15: R\$ 9,06  
30: R\$ 9,24 45: R\$ 9,43 60: R\$ 9,62



PORTA RET MAD 10X15CM VIDRO 101 MOD 010  
Código: Fábrica: Unidade:  
**22768** P A SOUZA UN/1  
F1 F4

UN: R\$ 8,88 AV: R\$ 8,88 15: R\$ 9,06  
30: R\$ 9,24 45: R\$ 9,43 60: R\$ 9,62



PORTA RET MAD 10X15CM VIDRO 106 MOD 115  
Código: Fábrica: Unidade:  
**22263** P A SOUZA UN/1  
F1 F4

UN: R\$ 8,88 AV: R\$ 8,88 15: R\$ 9,06  
30: R\$ 9,24 45: R\$ 9,43 60: R\$ 9,62



PORTA RET MAD 10X15CM VIDRO 111 MOD 116  
Código: Fábrica: Unidade:  
**15943** P A SOUZA UN/1  
F1 F4

UN: R\$ 14,38 AV: R\$ 14,38 15: R\$ 14,68  
30: R\$ 14,97 45: R\$ 15,27 60: R\$ 15,57



PORTA RET MAD 10X15CM VIDRO 126 MOD 080  
Código: Fábrica: Unidade:  
**45710** P A SOUZA UN/1  
F1 F4

UN: R\$ 8,88 AV: R\$ 8,88 15: R\$ 9,06  
30: R\$ 9,24 45: R\$ 9,43 60: R\$ 9,62



PORTA RET MAD 10X15CM VIDRO 186 MOD 020  
Código: Fábrica: Unidade:  
**15941** P A SOUZA UN/1  
F1 F4

UN: R\$ 6,74 AV: R\$ 6,74 15: R\$ 6,88  
30: R\$ 7,02 45: R\$ 7,16 60: R\$ 7,30

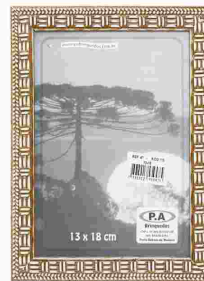

PORTA RET MAD 13X18CM ACET 47 MOD 115  
Código: Fábrica: Unidade:  
**7745** P A SOUZA UN/1  
F1 F4

UN: R\$ 6,74 AV: R\$ 6,74 15: R\$ 6,88  
30: R\$ 7,02 45: R\$ 7,16 60: R\$ 7,30

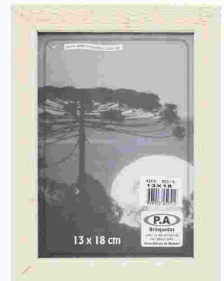

PORTA RET MAD 13X18CM ACET 51 MOD 116  
Código: Fábrica: Unidade:  
**17552** P A SOUZA UN/1  
F1 F4

UN: R\$ 6,74 AV: R\$ 6,74 15: R\$ 6,88  
30: R\$ 7,02 45: R\$ 7,16 60: R\$ 7,30



PORTA RET MAD 13X18CM ACET 147 MOD 020  
Código: Fábrica: Unidade:  
**18519** P A SOUZA UN/1  
F1 F4

UN: R\$ 13,85 AV: R\$ 13,85 15: R\$ 14,14  
30: R\$ 14,42 45: R\$ 14,71 60: R\$ 15,00



PORTA RET MAD 13X18CM ACET 152 MOD 141  
Código: Fábrica: Unidade:  
**45715** P A SOUZA UN/1  
F1 F4

UN: R\$ 10,63 AV: R\$ 10,63 15: R\$ 10,85  
30: R\$ 11,07 45: R\$ 11,29 60: R\$ 11,52



PORTA RET MAD 13X18CM ACET 157 MOD 133  
Código: Fábrica: Unidade:  
**45693** P A SOUZA UN/1  
F1 F4

UN: R\$ 13,83 AV: R\$ 13,83 15: R\$ 14,12  
30: R\$ 14,40 45: R\$ 14,69 60: R\$ 14,98



PORTA RET MAD 13X18CM ACET 162 MOD 167  
Código: Fábrica: Unidade:  
**45700** P A SOUZA UN/1  
F1 F4

UN: R\$ 12,97 AV: R\$ 12,97 15: R\$ 13,24  
30: R\$ 13,50 45: R\$ 13,77 60: R\$ 14,05



PORTA RET MAD 13X18CM VIDRO EXTRA LUXO  
Código: 48747 Fábrica: SANTA RITA Unidade: UN/1 F1 F4

UN: R\$ 9,93 AV: R\$ 9,93 15: R\$ 10,14  
30: R\$ 10,34 45: R\$ 10,55 60: R\$ 10,76



PORTA RET MAD 13X18CM VIDRO 102 MOD 010  
Código: 35227 Fábrica: P A SOUZA Unidade: UN/1 F1 F4

UN: R\$ 9,93 AV: R\$ 9,93 15: R\$ 10,14  
30: R\$ 10,34 45: R\$ 10,55 60: R\$ 10,76



PORTA RET MAD 13X18CM VIDRO 107 MOD 115  
Código: 35229 Fábrica: P A SOUZA Unidade: UN/1 F1 F4

UN: R\$ 9,93 AV: R\$ 9,93 15: R\$ 10,14  
30: R\$ 10,34 45: R\$ 10,55 60: R\$ 10,76



PORTA RET MAD 13X18CM VIDRO 112 MOD 116  
Código: 35228 Fábrica: P A SOUZA Unidade: UN/1 F1 F4

UN: R\$ 13,97 AV: R\$ 13,97 15: R\$ 14,26  
30: R\$ 14,54 45: R\$ 14,83 60: R\$ 15,13

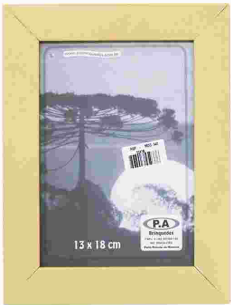

PORTA RET MAD 13X18CM VIDRO 117 MOD 040  
Código: 45686 Fábrica: P A SOUZA Unidade: UN/1 F1 F4

UN: R\$ 13,97 AV: R\$ 13,97 15: R\$ 14,26  
30: R\$ 14,54 45: R\$ 14,83 60: R\$ 15,13

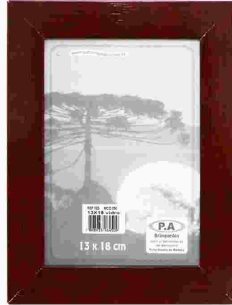

PORTA RET MAD 13X18CM VIDRO 122 MOD 050  
Código: 45691 Fábrica: P A SOUZA Unidade: UN/1 F1 F4

UN: R\$ 16,84 AV: R\$ 16,84 15: R\$ 17,19  
30: R\$ 17,54 45: R\$ 17,89 60: R\$ 18,25

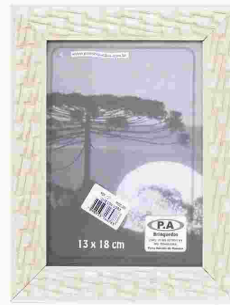

PORTA RET MAD 13X18CM VIDRO 127 MOD 080  
Código: 45711 Fábrica: P A SOUZA Unidade: UN/1 F1 F4

UN: R\$ 13,97 AV: R\$ 13,97 15: R\$ 14,26  
30: R\$ 14,54 45: R\$ 14,83 60: R\$ 15,13



PORTA RET MAD 13X18CM VIDRO 177 MOD 133  
Código: 45696 Fábrica: P A SOUZA Unidade: UN/1 F1 F4

UN: R\$ 16,84 AV: R\$ 16,84 15: R\$ 17,19  
30: R\$ 17,54 45: R\$ 17,89 60: R\$ 18,25



PORTA RET MAD 13X18CM VIDRO 182 MOD 167  
Código: 45703 Fábrica: P A SOUZA Unidade: UN/1 F1 F4

UN: R\$ 9,93 AV: R\$ 9,93 15: R\$ 10,14  
30: R\$ 10,34 45: R\$ 10,55 60: R\$ 10,76



PORTA RET MAD 13X18CM VIDRO 187 MOD 020  
Código: 16456 Fábrica: P A SOUZA Unidade: UN/1 F1 F4

UN: R\$ 16,84 AV: R\$ 16,84 15: R\$ 17,19  
30: R\$ 17,54 45: R\$ 17,89 60: R\$ 18,25



PORTA RET MAD 13X18CM VIDRO 192 MOD 141  
Código: 45683 Fábrica: P A SOUZA Unidade: UN/1 F1 F4

UN: R\$ 15,95 AV: R\$ 15,95 15: R\$ 16,29  
30: R\$ 16,61 45: R\$ 16,94 60: R\$ 17,28



PORTA RET MAD 15X21CM RUSTIC ACET 005  
Código: 45764 Fábrica: MOLDULAC Unidade: UN/1 F1 F4

UN: R\$ 14,97 AV: R\$ 14,97 15: R\$ 15,28  
30: R\$ 15,58 45: R\$ 15,90 60: R\$ 16,21



PORTA RET MAD 15X21CM VIDRO EXTRA LUXO  
Código: 48748 Fábrica: SANTA RITA Unidade: UN/1 F1 F4

UN: R\$ 11,97 AV: R\$ 11,97 15: R\$ 12,22  
30: R\$ 12,46 45: R\$ 12,71 60: R\$ 12,97



PORTA RET MAD 20X25CM ACET  
Código: 48749 Fábrica: SANTA RITA Unidade: UN/1 F1 F4

UN: R\$ 17,32 AV: R\$ 17,32 15: R\$ 17,68  
30: R\$ 18,04 45: R\$ 18,40 60: R\$ 18,77



PORTA RET MAD 20X25CM ACET 44 MOD 050  
Código: 45664 Fábrica: P A SOUZA Unidade: UN/1 F1 F4

UN: R\$ 10,43 AV: R\$ 10,43 15: R\$ 10,65  
30: R\$ 10,86 45: R\$ 11,08 60: R\$ 11,30

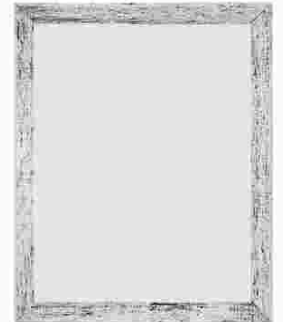

PORTA RET MAD 20X25CM ACET 49 MOD 115  
Código: 8824 Fábrica: P A SOUZA Unidade: UN/1 F1 F4

UN: R\$ 19,96 AV: R\$ 19,96 15: R\$ 20,37  
30: R\$ 20,78 45: R\$ 21,20 60: R\$ 21,62

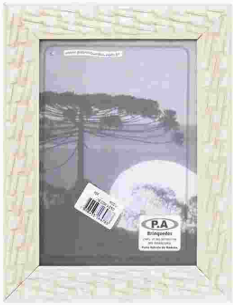

PORTA RET MAD 20X25CM ACET 57 MOD 080  
Código: Fábrica: Unidade:  
**45709** P A SOUZA UN/1  
F1 F4

UN: R\$ 10,43 AV: R\$ 10,43 15: R\$ 10,65  
30: R\$ 10,86 45: R\$ 11,08 60: R\$ 11,30



PORTA RET MAD 20X25CM ACET 68 MOD 010  
Código: Fábrica: Unidade:  
**14933** P A SOUZA UN/1  
F1 F4

UN: R\$ 10,43 AV: R\$ 10,43 15: R\$ 10,65  
30: R\$ 10,86 45: R\$ 11,08 60: R\$ 11,30



PORTA RET MAD 20X25CM ACET 149 MOD 020  
Código: Fábrica: Unidade:  
**7747** P A SOUZA UN/1  
F1 F4

UN: R\$ 19,96 AV: R\$ 19,96 15: R\$ 20,37  
30: R\$ 20,78 45: R\$ 21,20 60: R\$ 21,62



PORTA RET MAD 20X25CM ACET 154 MOD 141  
Código: Fábrica: Unidade:  
**45717** P A SOUZA UN/1  
F1 F4

UN: R\$ 17,32 AV: R\$ 17,32 15: R\$ 17,68  
30: R\$ 18,04 45: R\$ 18,40 60: R\$ 18,77



PORTA RET MAD 20X25CM ACET 159 MOD 133  
Código: Fábrica: Unidade:  
**45695** P A SOUZA UN/1  
F1 F4

UN: R\$ 19,96 AV: R\$ 19,96 15: R\$ 20,37  
30: R\$ 20,78 45: R\$ 21,20 60: R\$ 21,62

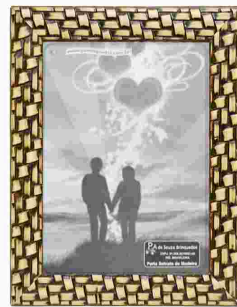

PORTA RET MAD 20X25CM ACET 164 MOD 167  
Código: Fábrica: Unidade:  
**45702** P A SOUZA UN/1  
F1 F4

UN: R\$ 21,95 AV: R\$ 21,95 15: R\$ 22,41  
30: R\$ 22,86 45: R\$ 23,32 60: R\$ 23,78



PORTA RET MAD 20X25CM RUSTIC ACET 005  
Código: Fábrica: Unidade:  
**45765** MOLDULAC UN/1  
F1 F4

UN: R\$ 15,38 AV: R\$ 15,38 15: R\$ 15,70  
30: R\$ 16,01 45: R\$ 16,33 60: R\$ 16,66



PORTA RET MAD 20X25CM VIDRO 104 MOD 010  
Código: Fábrica: Unidade:  
**23462** P A SOUZA UN/1  
F1 F4

UN: R\$ 15,38 AV: R\$ 15,38 15: R\$ 15,70  
30: R\$ 16,01 45: R\$ 16,33 60: R\$ 16,66



PORTA RET MAD 20X25CM VIDRO 109 MOD 115  
Código: Fábrica: Unidade:  
**22770** P A SOUZA UN/1  
F1 F4

UN: R\$ 15,38 AV: R\$ 15,38 15: R\$ 15,70  
30: R\$ 16,01 45: R\$ 16,33 60: R\$ 16,66

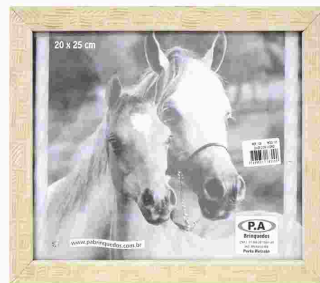

PORTA RET MAD 20X25CM VIDRO 114 MOD 116  
Código: Fábrica: Unidade:  
**23463** P A SOUZA UN/1  
F1 F4

UN: R\$ 20,57 AV: R\$ 20,57 15: R\$ 21,00  
30: R\$ 21,42 45: R\$ 21,84 60: R\$ 22,28



PORTA RET MAD 20X25CM VIDRO 124 MOD 050  
Código: Fábrica: Unidade:  
**45663** P A SOUZA UN/1  
F1 F4

UN: R\$ 24,26 AV: R\$ 24,26 15: R\$ 24,77  
30: R\$ 25,26 45: R\$ 25,77 60: R\$ 26,28

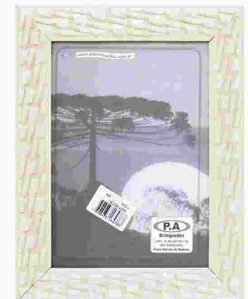

PORTA RET MAD 20X25CM VIDRO 129 MOD 080  
Código: Fábrica: Unidade:  
**45713** P A SOUZA UN/1  
F1 F4

UN: R\$ 20,57 AV: R\$ 20,57 15: R\$ 21,00  
30: R\$ 21,42 45: R\$ 21,84 60: R\$ 22,28



PORTA RET MAD 20X25CM VIDRO 179 MOD 133  
Código: Fábrica: Unidade:  
**45698** P A SOUZA UN/1  
F1 F4

UN: R\$ 24,16 AV: R\$ 24,16 15: R\$ 24,66  
30: R\$ 25,16 45: R\$ 25,66 60: R\$ 26,17

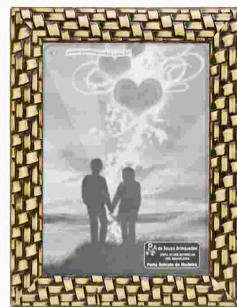

PORTA RET MAD 20X25CM VIDRO 184 MOD 167  
Código: Fábrica: Unidade:  
**45705** P A SOUZA UN/1  
F1 F4

UN: R\$ 15,38 AV: R\$ 15,38 15: R\$ 15,70  
30: R\$ 16,01 45: R\$ 16,33 60: R\$ 16,66



PORTA RET MAD 20X25CM VIDRO 189/6 MOD20  
Código: Fábrica: Unidade:  
**22265** P A SOUZA UN/1  
F1 F4

UN: R\$ 24,16 AV: R\$ 24,16 15: R\$ 24,66  
30: R\$ 25,16 45: R\$ 25,66 60: R\$ 26,17



PORTA RET MAD 20X25CM VIDRO 194 MOD 141  
Código: Fábrica: Unidade:  
**45685** P A SOUZA UN/1  
F1 F4

UN: R\$ 11,97 AV: R\$ 11,97 15: R\$ 12,22  
30: R\$ 12,46 45: R\$ 12,71 60: R\$ 12,97

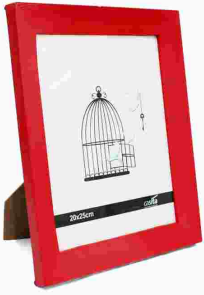

PORTA RET MAD 20X25CM VIDRO 25035  
Código: Fábrika: Unidade:  
**50215** CASITA UN/1  
F1 F4

UN: R\$ 20,57 AV: R\$ 20,57 15: R\$ 21,00  
30: R\$ 21,42 45: R\$ 21,84 60: R\$ 22,28



PORTA RET MAD 20X25CM VIDRO119 MOD 040  
Código: Fábrika: Unidade:  
**45662** P A SOUZA UN/1  
F1 F4

UN: R\$ 13,97 AV: R\$ 13,97 15: R\$ 14,26  
30: R\$ 14,54 45: R\$ 14,83 60: R\$ 15,13



PORTA RET MAD 20X30CM ACET  
Código: Fábrika: Unidade:  
**48750** SANTA RITA UN/1  
F1 F4

UN: R\$ 22,95 AV: R\$ 22,95 15: R\$ 23,43  
30: R\$ 23,90 45: R\$ 24,38 60: R\$ 24,87

CORES

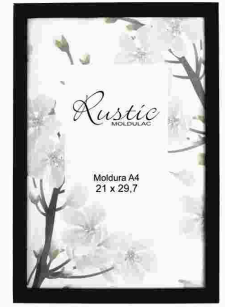

PORTA RET MAD 21X30CM RUSTIC ACET 005  
Código: Fábrika: Unidade:  
**45766** MOLDULAC UN/1  
F1 F4

UN: R\$ 36,93 AV: R\$ 36,93 15: R\$ 37,70  
30: R\$ 38,45 45: R\$ 39,22 60: R\$ 40,01



CORES



PORTA RET MAD 30X40CM RUSTIC ACET 005  
Código: Fábrika: Unidade:  
**45767** MOLDULAC UN/1  
F1 F4

UN: R\$ 8,99 AV: R\$ 8,99 15: R\$ 9,17  
30: R\$ 9,36 45: R\$ 9,54 60: R\$ 9,73



PORTA RET PLAST VD 10X15CM BIKE 9110  
Código: Fábrika: Unidade:  
**25928** YING FA UN/1  
F1 F4

UN: R\$ 7,49 AV: R\$ 7,49 15: R\$ 7,64  
30: R\$ 7,80 45: R\$ 7,95 60: R\$ 8,11

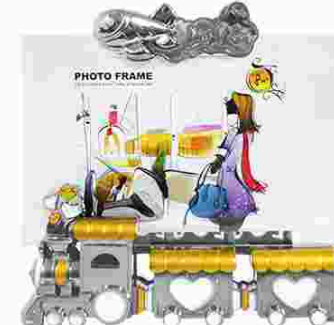

PORTA RET PLAST VD 10X15CM TREM 9084  
Código: Fábrika: Unidade:  
**28234** YING FA UN/1  
F1 F4

UN: R\$ 44,92 AV: R\$ 44,92 15: R\$ 45,85  
30: R\$ 46,77 45: R\$ 47,71 60: R\$ 48,66



PORTA RETRATO VIDRO 10X10 DUPLO VC 11633  
Código: Fábrika: Unidade:  
**41152** BRASFOOT CJ/1  
F1 F4

UN: R\$ 39,93 AV: R\$ 39,93 15: R\$ 40,76  
30: R\$ 41,57 45: R\$ 42,40 60: R\$ 43,25



PORTA RETRATO VIDRO 10X15 ATLETICO 2673  
Código: Fábrika: Unidade:  
**39131** BRASFOOT UN/1  
F1 F4

UN: R\$ 39,93 AV: R\$ 39,93 15: R\$ 40,76  
30: R\$ 41,57 45: R\$ 42,40 60: R\$ 43,25



PORTA RETRATO VIDRO 10X15 CRUZEIRO 2674  
Código: Fábrika: Unidade:  
**39132** BRASFOOT UN/1  
F1 F4

UN: R\$ 32,94 AV: R\$ 32,94 15: R\$ 33,62  
30: R\$ 34,30 45: R\$ 34,98 60: R\$ 35,68



PORTA RETRATO VIDRO 10X15 MAE 11627  
Código: Fábrika: Unidade:  
**41153** BRASFOOT UN/1  
F1 F4

UN: R\$ 0,30 AV: R\$ 0,30 15: R\$ 0,31  
30: R\$ 0,31 45: R\$ 0,32 60: R\$ 0,32

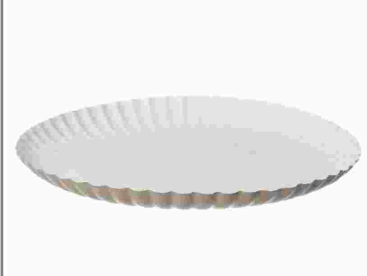

PRATO DE PAPELAO N 02 15CM UN  
Código: Fábrika: Unidade:  
**50387** PITPRATOS UN/1  
F1 F4

UN: R\$ 0,35 AV: R\$ 0,35 15: R\$ 0,36  
30: R\$ 0,36 45: R\$ 0,37 60: R\$ 0,38



PRATO DE PAPELAO N 03 17,5CM UN  
Código: Fábrika: Unidade:  
**49860** PITPRATOS UN/1  
F1 F4

UN: R\$ 0,79 AV: R\$ 0,79 15: R\$ 0,81  
30: R\$ 0,82 45: R\$ 0,84 60: R\$ 0,85



PRATO DE PAPELAO N 06 25CM UN  
Código: Fábrika: Unidade:  
**49861** PITPRATOS UN/1  
F1 F4

UN: R\$ 1,19 AV: R\$ 1,19 15: R\$ 1,21  
30: R\$ 1,24 45: R\$ 1,26 60: R\$ 1,29



PRATO DE PAPELAO N 09 32CM UN  
Código: Fábrika: Unidade:  
**49862** PITPRATOS UN/1  
F1 F4

UN: R\$ 1,49 AV: R\$ 1,49 15: R\$ 1,52  
30: R\$ 1,55 45: R\$ 1,58 60: R\$ 1,61



PRATO DE PAPELAO N12 UN  
Código: Fábrika: Unidade:  
**47741** PITPRATOS UN/1  
F1 F4

UN: R\$ 5,99 AV: R\$ 59,89 15: R\$ 61,14  
30: R\$ 62,36 45: R\$ 63,61 60: R\$ 64,88

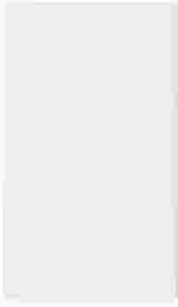

PROTECTOR ACRILICO RIGIDO DUT 10X1  
Código: Fábrica: Unidade:  
**30483** MP PT/10  
F1 F4

UN: R\$ 5,98 AV: R\$ 5,98 15: R\$ 6,11  
30: R\$ 6,23 45: R\$ 6,35 60: R\$ 6,48



PROTECTOR DE RALO PVC 185X185MM 127  
Código: Fábrica: Unidade:  
**41830** LIDER PLUS UN/1  
F1 F4

UN: R\$ 14,78 AV: R\$ 14,78 15: R\$ 15,08  
30: R\$ 15,39 45: R\$ 15,69 60: R\$ 16,01



PROTECTOR PORTA 80CM NAPA PRETO 80-12  
Código: Fábrica: Unidade:  
**41816** SECULLUS UN/1  
F1 F4

UN: R\$ 0,69 AV: R\$ 34,44 15: R\$ 35,16  
30: R\$ 35,87 45: R\$ 36,58 60: R\$ 37,31

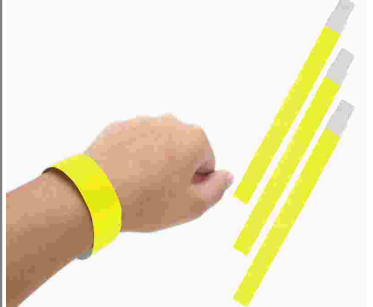

PULSEIRA IDENTIFICACAO TYVEK AMAREL 50X1  
Código: Fábrica: Unidade:  
**42282** MAXI BANDS PT/50  
F1 F4

UN: R\$ 0,69 AV: R\$ 34,44 15: R\$ 35,16  
30: R\$ 35,87 45: R\$ 36,58 60: R\$ 37,31



PULSEIRA IDENTIFICACAO TYVEK LARANJ 50X1  
Código: Fábrica: Unidade:  
**42284** MAXI BANDS PT/50  
F1 F4

UN: R\$ 0,69 AV: R\$ 34,44 15: R\$ 35,16  
30: R\$ 35,87 45: R\$ 36,58 60: R\$ 37,31

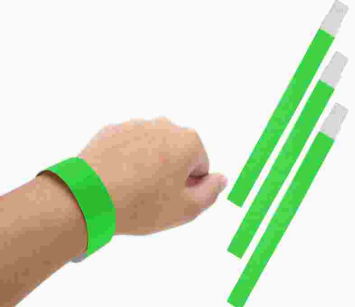

PULSEIRA IDENTIFICACAO TYVEK VERDE 50X1  
Código: Fábrica: Unidade:  
**42285** MAXI BANDS PT/50  
F1 F4

UN: R\$ 0,69 AV: R\$ 34,44 15: R\$ 35,16  
30: R\$ 35,87 45: R\$ 36,58 60: R\$ 37,31

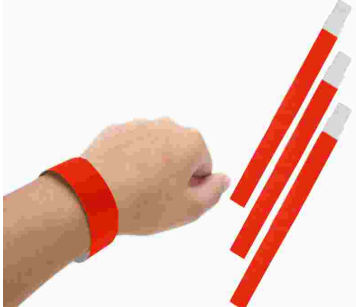

PULSEIRA IDENTIFICACAO TYVEK VERMEL 50X1  
Código: Fábrica: Unidade:  
**42286** MAXI BANDS PT/50  
F1 F4

UN: R\$ 1,00 AV: R\$ 11,97 15: R\$ 12,22  
30: R\$ 12,46 45: R\$ 12,71 60: R\$ 12,97



PULSEIRA OLODUM FINA 1373 12X1  
Código: Fábrica: Unidade:  
**33283** NOVIDADE PT/12  
F1 F4

UN: R\$ 2,00 AV: R\$ 23,95 15: R\$ 24,45  
30: R\$ 24,94 45: R\$ 25,44 60: R\$ 25,95



PULSEIRA OLODUM GROSSA 1117 12X1  
Código: Fábrica: Unidade:  
**33285** NOVIDADE PT/12  
F1 F4

UN: R\$ 2,50 AV: R\$ 12,48 15: R\$ 12,74  
30: R\$ 12,99 45: R\$ 13,25 60: R\$ 13,52



PULSEIRA RELOGIO TP COURO 16MM MARR 5X1  
Código: Fábrica: Unidade:  
**37640** GENCLAS PT/5  
F4

UN: R\$ 2,50 AV: R\$ 12,48 15: R\$ 12,74  
30: R\$ 12,99 45: R\$ 13,25 60: R\$ 13,52



PULSEIRA RELOGIO TP COURO 18MM PTO 5X1  
Código: Fábrica: Unidade:  
**37635** GENCLAS PT/5  
F1 F4

UN: R\$ 2,50 AV: R\$ 12,48 15: R\$ 12,74  
30: R\$ 12,99 45: R\$ 13,25 60: R\$ 13,52



PULSEIRA RELOGIO TP COURO 20MM MARR 5X1  
Código: Fábrica: Unidade:  
**37637** GENCLAS PT/5  
F4

UN: R\$ 2,50 AV: R\$ 12,48 15: R\$ 12,74  
30: R\$ 12,99 45: R\$ 13,25 60: R\$ 13,52



PULSEIRA RELOGIO TP COURO 20MM PTO 5X1  
Código: Fábrica: Unidade:  
**37636** GENCLAS PT/5  
F1 F4

UN: R\$ 2,50 AV: R\$ 12,48 15: R\$ 12,74  
30: R\$ 12,99 45: R\$ 13,25 60: R\$ 13,52



PULSEIRA RELOGIO TP COURO 22MM MARR 5X1  
Código: Fábrica: Unidade:  
**37639** GENCLAS PT/5  
F4

UN: R\$ 2,50 AV: R\$ 12,48 15: R\$ 12,74  
30: R\$ 12,99 45: R\$ 13,25 60: R\$ 13,52



PULSEIRA RELOGIO TP COURO 22MM PTO 5X1  
Código: Fábrica: Unidade:  
**37638** GENCLAS PT/5  
F1 F4

UN: R\$ 12,97 AV: R\$ 12,97 15: R\$ 13,24  
30: R\$ 13,50 45: R\$ 13,77 60: R\$ 14,05



PULSEIRA SILICONE P/MONTAR C/MALET 12X40  
Código: Fábrica: Unidade:  
**34467** NOVIDADE KI/1  
F1 F4

UN: R\$ 39,93 AV: R\$ 39,93 15: R\$ 40,76  
30: R\$ 41,57 45: R\$ 42,40 60: R\$ 43,25  
11 47 cm  
12 31 cm



QUADRO CAIXA PORTA ROLHA 28X44CM 2844

Código: Fábrica: Unidade:  
**40980** SANTA RITA UN/1  
F1 F4

UN: R\$ 6,98 AV: R\$ 6,98 15: R\$ 7,12  
30: R\$ 7,27 45: R\$ 7,41 60: R\$ 7,56



QUADRO MADEIRA 20X20CM 2020

Código: Fábrica: Unidade:  
**48751** SANTA RITA UN/1  
F1 F4

UN: R\$ 4,69 AV: R\$ 4,69 15: R\$ 4,79  
30: R\$ 4,89 45: R\$ 4,98 60: R\$ 5,08  
11 20 cm  
12 30 cm



QUADRO PLAST P/ FIXAR 20X30CM 52597

Código: Fábrica: Unidade:  
**32628** 20 COMERCIAL UN/1  
F1 F4

UN: R\$ 8,99 AV: R\$ 8,99 15: R\$ 9,17  
30: R\$ 9,36 45: R\$ 9,54 60: R\$ 9,73  
11 25 cm  
12 52 cm



QUADRO PLAST P/ FIXAR 25X52CM 52601

Código: Fábrica: Unidade:  
**32631** 20 COMERCIAL UN/1  
F1 F4

UN: R\$ 7,39 AV: R\$ 7,39 15: R\$ 7,54  
30: R\$ 7,69 45: R\$ 7,85 60: R\$ 8,00  
11 37 cm  
12 26 cm



QUADRO PLAST P/ FIXAR 26X37CM 52598

Código: Fábrica: Unidade:  
**32629** 20 COMERCIAL UN/1  
F1 F4

UN: R\$ 9,78 AV: R\$ 9,78 15: R\$ 9,99  
30: R\$ 10,19 45: R\$ 10,39 60: R\$ 10,60  
11 38 cm  
12 38 cm



QUADRO PLAST P/ FIXAR 38X38CM 52599

Código: Fábrica: Unidade:  
**32630** 20 COMERCIAL UN/1  
F1 F4

UN: R\$ 10,58 AV: R\$ 10,58 15: R\$ 10,80  
30: R\$ 11,02 45: R\$ 11,24 60: R\$ 11,46  
11 38 cm  
12 48 cm



QUADRO PLAST P/ FIXAR 38X48CM 52600

Código: Fábrica: Unidade:  
**32632** 20 COMERCIAL UN/1  
F1 F4

UN: R\$ 6,98 AV: R\$ 6,98 15: R\$ 7,12  
30: R\$ 7,27 45: R\$ 7,41 60: R\$ 7,56



QUADRO PLAST P/QUADRO HORARIO OF UN

Código: Fábrica: Unidade:  
**47029** ACP UN/1  
F1 F4

UN: R\$ 6,99 AV: R\$ 69,88 15: R\$ 71,33  
30: R\$ 72,76 45: R\$ 74,22 60: R\$ 75,70



QUADRO PLAST P/QUADRO HORARIO OF 10X1

Código: Fábrica: Unidade:  
**41789** MP PT/10  
F1 F4

UN: R\$ 6,98 AV: R\$ 6,98 15: R\$ 7,12  
30: R\$ 7,27 45: R\$ 7,41 60: R\$ 7,56



QUADRO VERDE (LOUSA) 25X39CM 2539

Código: Fábrica: Unidade:  
**40978** SANTA RITA UN/1  
F1 F4

UN: R\$ 23,56 AV: R\$ 23,56 15: R\$ 24,05  
30: R\$ 24,53 45: R\$ 25,02 60: R\$ 25,53  
11 30 cm  
12 40 cm

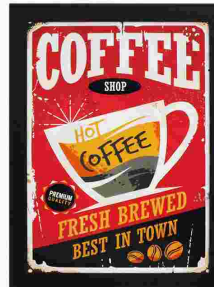

QUADRO 30X40 MOLD VINTAGE QDVT-022

Código: Fábrica: Unidade:  
**35189** MM QUADROS UN/1  
F1 F4

UN: R\$ 41,35 AV: R\$ 41,35 15: R\$ 42,22  
30: R\$ 43,06 45: R\$ 43,92 60: R\$ 44,80  
11 50 cm  
12 70 cm



QUADRO 50X70CM RESIN MOLD 2,5CM ANIMAL

Código: Fábrica: Unidade:  
**40791** MM QUADROS UN/1  
F1 F4

UN: R\$ 41,35 AV: R\$ 41,35 15: R\$ 42,22  
30: R\$ 43,06 45: R\$ 43,92 60: R\$ 44,80  
11 50 cm  
12 70 cm



QUADRO 50X70CM RESIN MOLD 2,5CM FLORAL

Código: Fábrica: Unidade:  
**40792** MM QUADROS UN/1  
F1 F4

UN: R\$ 41,35 AV: R\$ 41,35 15: R\$ 42,22  
30: R\$ 43,06 45: R\$ 43,92 60: R\$ 44,80  
11 50 cm  
12 70 cm



QUADRO 50X70CM RESIN MOLD 2,5CM PAISAGEM

Código: Fábrica: Unidade:  
**40790** MM QUADROS UN/1  
F1 F4

UN: R\$ 0,15 AV: R\$ 10,97 15: R\$ 11,20  
30: R\$ 11,43 45: R\$ 11,65 60: R\$ 11,89



RABICO MEIA LISO COLOR 3,5CM 2551 12X6

Código: Fábrica: Unidade:  
**28034** MISS FRANCE PT/72  
F1 F4

UN: R\$ 0,12 AV: R\$ 9,97 15: R\$ 10,18  
30: R\$ 10,39 45: R\$ 10,59 60: R\$ 10,81



RABICO MEIA LISO COLOR 3,5CM 2575 80X1

Código: Fábrica: Unidade:  
**50960** MISS FRANCE PT/80  
F1 F4

UN: R\$ 0,28 AV: R\$ 19,96 15: R\$ 20,37  
30: R\$ 20,78 45: R\$ 21,20 60: R\$ 21,62



RABICO MEIA LISO PRETO MED 4801 12X6  
Código: Fábrika: Unidade:  
**32221** HAI BRASIL PT/72  
F1 F4

UN: R\$ 0,12 AV: R\$ 9,97 15: R\$ 10,18  
30: R\$ 10,39 45: R\$ 10,59 60: R\$ 10,81



RABICO MEIA LISO PRETO 3,5CM 2582 80X1  
Código: Fábrika: Unidade:  
**50961** MISS FRANCE PT/80  
F1 F4

UN: R\$ 0,07 AV: R\$ 1,40 15: R\$ 1,43  
30: R\$ 1,46 45: R\$ 1,48 60: R\$ 1,51

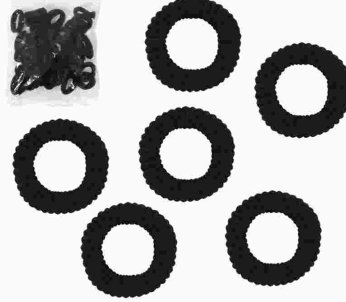

RABICO PP PRETO 20X1  
Código: Fábrika: Unidade:  
**22454** KM PT/20  
F1 F4

UN: R\$ 0,91 AV: R\$ 10,97 15: R\$ 11,20  
30: R\$ 11,43 45: R\$ 11,65 60: R\$ 11,89



RABICO SILICONE PRETO C/100 12X1 4325  
Código: Fábrika: Unidade:  
**49757** SQ CT/12  
F1 F4

UN: R\$ 65,89 AV: R\$ 65,89 15: R\$ 67,27  
30: R\$ 68,61 45: R\$ 69,98 60: R\$ 71,38



RADIO MICROFONE USB C/LUZ 1308  
Código: Fábrika: Unidade:  
**33671** AGUIABRANCA CX/1  
F1 F4

UN: R\$ 24,99 AV: R\$ 24,99 15: R\$ 24,99  
30: R\$ 24,99 45: R\$ 24,99 60: R\$ 24,99



RAQUETE MATA MOSQUITOS RECARREG 110/220V  
Código: Fábrika: Unidade:  
**27980** PRO UN/1  
F1 F4

UN: R\$ 5,89 AV: R\$ 58,90 15: R\$ 60,12  
30: R\$ 61,33 45: R\$ 62,55 60: R\$ 63,80



RECEPTACULO PORCELANA EMBORR NF16 10X1  
Código: Fábrika: Unidade:  
**44379** GIROFLASH PT/10  
F1 F4

UN: R\$ 16,96 AV: R\$ 16,96 15: R\$ 17,32  
30: R\$ 17,66 45: R\$ 18,02 60: R\$ 18,38



RELOGIO PAREDE CASINHA 21X25CM  
Código: Fábrika: Unidade:  
**47901** YINS UN/1  
F1 F4

UN: R\$ 25,95 AV: R\$ 25,95 15: R\$ 26,49  
30: R\$ 27,02 45: R\$ 27,56 60: R\$ 28,11



RELOGIO PAREDE OCTO PILHA CAFE PTO 07  
Código: Fábrika: Unidade:  
**32427** GAMA UN/1  
F1 F4

UN: R\$ 25,95 AV: R\$ 25,95 15: R\$ 26,49  
30: R\$ 27,02 45: R\$ 27,56 60: R\$ 28,11



RELOGIO PAREDE OCTO PILHA CARROS BCO 07  
Código: Fábrika: Unidade:  
**44453** GAMA UN/1  
F1 F4

UN: R\$ 25,95 AV: R\$ 25,95 15: R\$ 26,49  
30: R\$ 27,02 45: R\$ 27,56 60: R\$ 28,11



RELOGIO PAREDE OCTO PILHA CARROS PTO 07  
Código: Fábrika: Unidade:  
**36206** GAMA UN/1  
F1 F4

UN: R\$ 25,95 AV: R\$ 25,95 15: R\$ 26,49  
30: R\$ 27,02 45: R\$ 27,56 60: R\$ 28,11



RELOGIO PAREDE OCTO PILHA CORUJA PTO 07  
Código: Fábrika: Unidade:  
**44454** GAMA UN/1  
F1 F4

UN: R\$ 25,95 AV: R\$ 25,95 15: R\$ 26,49  
30: R\$ 27,02 45: R\$ 27,56 60: R\$ 28,11



RELOGIO PAREDE OCTO PILHA FILIPENSES BCO  
Código: Fábrika: Unidade:  
**46542** GAMA UN/1  
F1 F4

UN: R\$ 25,95 AV: R\$ 25,95 15: R\$ 26,49  
30: R\$ 27,02 45: R\$ 27,56 60: R\$ 28,11



RELOGIO PAREDE OCTO PILHA FILIPENSES PTO  
Código: Fábrika: Unidade:  
**32431** GAMA UN/1  
F1 F4

UN: R\$ 25,95 AV: R\$ 25,95 15: R\$ 26,49  
30: R\$ 27,02 45: R\$ 27,56 60: R\$ 28,11



RELOGIO PAREDE OCTO PILHA FRUTAS PTO 007  
Código: Fábrika: Unidade:  
**32425** GAMA UN/1  
F1 F4

UN: R\$ 25,95 AV: R\$ 25,95 15: R\$ 26,49  
30: R\$ 27,02 45: R\$ 27,56 60: R\$ 28,11



RELOGIO PAREDE OCTO PILHA GALINHA PTO 07  
Código: Fábrika: Unidade:  
**49282** GAMA UN/1  
F1 F4

UN: R\$ 25,95 AV: R\$ 25,95 15: R\$ 26,49  
30: R\$ 27,02 45: R\$ 27,56 60: R\$ 28,11



RELOGIO PAREDE OCTO PILHA MAMAE 1 PHR007

Código: Fábrika: Unidade:  
**34902** GAMA UN/1  
F1 F4

UN: R\$ 25,95 AV: R\$ 25,95 15: R\$ 26,49  
30: R\$ 27,02 45: R\$ 27,56 60: R\$ 28,11



RELOGIO PAREDE OCTO PILHA MAMAE 2 PTO 07

Código: Fábrika: Unidade:  
**49281** GAMA UN/1  
F1 F4

UN: R\$ 25,95 AV: R\$ 25,95 15: R\$ 26,49  
30: R\$ 27,02 45: R\$ 27,56 60: R\$ 28,11



RELOGIO PAREDE OCTO PILHA PET DOG BCO 07

Código: Fábrika: Unidade:  
**44452** GAMA UN/1  
F1 F4

UN: R\$ 25,95 AV: R\$ 25,95 15: R\$ 26,49  
30: R\$ 27,02 45: R\$ 27,56 60: R\$ 28,11



RELOGIO PAREDE OCTO PILHA PET DOG PTO 07

Código: Fábrika: Unidade:  
**33434** GAMA UN/1  
F1 F4

UN: R\$ 25,95 AV: R\$ 25,95 15: R\$ 26,49  
30: R\$ 27,02 45: R\$ 27,56 60: R\$ 28,11



RELOGIO PAREDE OCTO PILHA SALMOS BCO 07

Código: Fábrika: Unidade:  
**44451** GAMA UN/1  
F1 F4

UN: R\$ 25,95 AV: R\$ 25,95 15: R\$ 26,49  
30: R\$ 27,02 45: R\$ 27,56 60: R\$ 28,11



RELOGIO PAREDE RED PILHA DEC BCO AMAR 03

Código: Fábrika: Unidade:  
**41679** OMEGA UN/1  
F1 F4

UN: R\$ 25,95 AV: R\$ 25,95 15: R\$ 26,49  
30: R\$ 27,02 45: R\$ 27,56 60: R\$ 28,11



RELOGIO PAREDE RED PILHA DEC BCO AZUL 03

Código: Fábrika: Unidade:  
**43840** OMEGA UN/1  
F1 F4

UN: R\$ 25,95 AV: R\$ 25,95 15: R\$ 26,49  
30: R\$ 27,02 45: R\$ 27,56 60: R\$ 28,11



RELOGIO PAREDE RED PILHA DESIGNER PHR 03

Código: Fábrika: Unidade:  
**32435** OMEGA UN/1  
F1 F4

UN: R\$ 25,95 AV: R\$ 25,95 15: R\$ 26,49  
30: R\$ 27,02 45: R\$ 27,56 60: R\$ 28,11



RELOGIO PAREDE RED PILHA FRUTAS BCO 03

Código: Fábrika: Unidade:  
**33433** OMEGA UN/1  
F1 F4

UN: R\$ 25,95 AV: R\$ 25,95 15: R\$ 26,49  
30: R\$ 27,02 45: R\$ 27,56 60: R\$ 28,11



RELOGIO PAREDE RED PILHA FRUTAS PTO 03

Código: Fábrika: Unidade:  
**46808** OMEGA UN/1  
F1 F4

UN: R\$ 25,95 AV: R\$ 25,95 15: R\$ 26,49  
30: R\$ 27,02 45: R\$ 27,56 60: R\$ 28,11



RELOGIO PAREDE RED PILHA JESUS BCO 03

Código: Fábrika: Unidade:  
**44449** OMEGA UN/1  
F1 F4

UN: R\$ 25,95 AV: R\$ 25,95 15: R\$ 26,49  
30: R\$ 27,02 45: R\$ 27,56 60: R\$ 28,11



RELOGIO PAREDE RED PILHA LONDON PHR 03

Código: Fábrika: Unidade:  
**32434** OMEGA UN/1  
F1 F4

UN: R\$ 25,95 AV: R\$ 25,95 15: R\$ 26,49  
30: R\$ 27,02 45: R\$ 27,56 60: R\$ 28,11



RELOGIO PAREDE RED PILHA MAMAE 1 BCO 03

Código: Fábrika: Unidade:  
**44448** OMEGA UN/1  
F1 F4

UN: R\$ 25,95 AV: R\$ 25,95 15: R\$ 26,49  
30: R\$ 27,02 45: R\$ 27,56 60: R\$ 28,11



RELOGIO PAREDE RED PILHA MAMAE 1 PTO 03

Código: Fábrika: Unidade:  
**34903** OMEGA UN/1  
F1 F4

UN: R\$ 25,95 AV: R\$ 25,95 15: R\$ 26,49  
30: R\$ 27,02 45: R\$ 27,56 60: R\$ 28,11



RELOGIO PAREDE RED PILHA MAMAE 2 BCO 03

Código: Fábrika: Unidade:  
**38086** OMEGA UN/1  
F1 F4

UN: R\$ 25,95 AV: R\$ 25,95 15: R\$ 26,49  
30: R\$ 27,02 45: R\$ 27,56 60: R\$ 28,11



RELOGIO PAREDE RED PILHA MAMAE 2 PTO 03

Código: Fábrika: Unidade:  
**34904** OMEGA UN/1  
F1 F4

UN: R\$ 25,95 AV: R\$ 25,95 15: R\$ 26,49  
30: R\$ 27,02 45: R\$ 27,56 60: R\$ 28,11

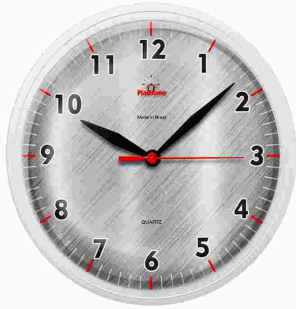

RELOGIO PAREDE RED PILHA MODERNO BCO 03  
Código: Fábrika: Unidade:  
**32429** OMEGA UN/1  
F1 F4

UN: R\$ 25,95 AV: R\$ 25,95 15: R\$ 26,49  
30: R\$ 27,02 45: R\$ 27,56 60: R\$ 28,11

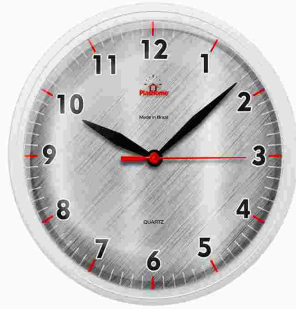

RELOGIO PAREDE RED PILHA MODERNO PTO 03  
Código: Fábrika: Unidade:  
**39711** OMEGA UN/1  
F1 F4

UN: R\$ 25,95 AV: R\$ 25,95 15: R\$ 26,49  
30: R\$ 27,02 45: R\$ 27,56 60: R\$ 28,11



RELOGIO PAREDE RED PILHA N S APAREC BCO3  
Código: Fábrika: Unidade:  
**32432** OMEGA UN/1  
F1 F4

UN: R\$ 25,95 AV: R\$ 25,95 15: R\$ 26,49  
30: R\$ 27,02 45: R\$ 27,56 60: R\$ 28,11



RELOGIO PAREDE RED PILHA NATUREZA BCO 03  
Código: Fábrika: Unidade:  
**32428** OMEGA UN/1  
F1 F4

UN: R\$ 25,95 AV: R\$ 25,95 15: R\$ 26,49  
30: R\$ 27,02 45: R\$ 27,56 60: R\$ 28,11



RELOGIO PAREDE RED PILHA PARIS BCO 03  
Código: Fábrika: Unidade:  
**38083** OMEGA UN/1  
F1 F4

UN: R\$ 25,95 AV: R\$ 25,95 15: R\$ 26,49  
30: R\$ 27,02 45: R\$ 27,56 60: R\$ 28,11



RELOGIO PAREDE RED PILHA PARIS PTO 03  
Código: Fábrika: Unidade:  
**37840** OMEGA UN/1  
F1 F4

UN: R\$ 25,95 AV: R\$ 25,95 15: R\$ 26,49  
30: R\$ 27,02 45: R\$ 27,56 60: R\$ 28,11



RELOGIO PAREDE RED PILHA PTO PTO 03  
Código: Fábrika: Unidade:  
**34901** OMEGA UN/1  
F1 F4

UN: R\$ 25,95 AV: R\$ 25,95 15: R\$ 26,49  
30: R\$ 27,02 45: R\$ 27,56 60: R\$ 28,11



RELOGIO PAREDE RED PILHA TACA MUN BCO 03  
Código: Fábrika: Unidade:  
**39713** OMEGA UN/1  
F1 F4

UN: R\$ 25,95 AV: R\$ 25,95 15: R\$ 26,49  
30: R\$ 27,02 45: R\$ 27,56 60: R\$ 28,11



RELOGIO PAREDE RED PILHA VACA PTO 03  
Código: Fábrika: Unidade:  
**32424** OMEGA UN/1  
F1 F4

UN: R\$ 17,96 AV: R\$ 17,96 15: R\$ 18,34  
30: R\$ 18,70 45: R\$ 19,08 60: R\$ 19,46



RELOGIO PAREDE RED SOFT EUCATEX 30 CM  
Código: Fábrika: Unidade:  
**40981** SANTA RITA UN/1  
F1 F4

UN: R\$ 32,94 AV: R\$ 32,94 15: R\$ 33,62  
30: R\$ 34,30 45: R\$ 34,98 60: R\$ 35,68

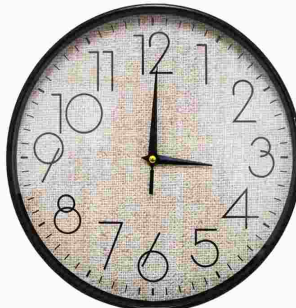

RELOGIO PAREDE RED 30CM PILHA AA 164  
Código: Fábrika: Unidade:  
**50228** FUTURO UN/1  
F1 F4

UN: R\$ 79,86 AV: R\$ 79,86 15: R\$ 81,53  
30: R\$ 83,16 45: R\$ 84,82 60: R\$ 86,52



RELOGIO PAREDE 2010 PILHA MUSICAL  
Código: Fábrika: Unidade:  
**26561** YING FA UN/1  
F1 F4

UN: R\$ 29,95 AV: R\$ 29,95 15: R\$ 30,58  
30: R\$ 31,19 45: R\$ 31,81 60: R\$ 32,45



RELOGIO PULSO AQUA GRANDE  
Código: Fábrika: Unidade:  
**3616** AQUA UN/1  
F4

UN: R\$ 29,95 AV: R\$ 29,95 15: R\$ 30,58  
30: R\$ 31,19 45: R\$ 31,81 60: R\$ 32,45



RELOGIO PULSO AQUA PEQUENO  
Código: Fábrika: Unidade:  
**25160** AQUA UN/1  
F4

UN: R\$ 29,94 AV: R\$ 29,94 15: R\$ 30,57  
30: R\$ 31,18 45: R\$ 31,80 60: R\$ 32,44



RELOGIO PULSO DIGITAL EMBORR SPORT  
Código: Fábrika: Unidade:  
**21589** NR UN/1  
F4

UN: R\$ 11,98 AV: R\$ 11,98 15: R\$ 12,23  
30: R\$ 12,48 45: R\$ 12,72 60: R\$ 12,98



RELOGIO PULSO EMB DIGITAL COLOR FEM  
Código: Fábrika: Unidade:  
**40748** FELE UN/1  
F1 F4

UN: R\$ 29,95 AV: R\$ 29,95 15: R\$ 30,58  
30: R\$ 31,19 45: R\$ 31,81 60: R\$ 32,45



RELOGIO PULSO EMBORRACHADO CASIO

Código: 23434 Fábrica: CASIO Unidade: UN/1 F4

UN: R\$ 29,95 AV: R\$ 29,95 15: R\$ 30,58  
30: R\$ 31,19 45: R\$ 31,81 60: R\$ 32,45



RELOGIO PULSO FEM METAL

Código: 27325 Fábrica: NR Unidade: UN/1 F1 F4

UN: R\$ 13,97 AV: R\$ 13,97 15: R\$ 14,26  
30: R\$ 14,54 45: R\$ 14,83 60: R\$ 15,13



RELOGIO PULSO METAL CASIO DOURADO

Código: 35010 Fábrica: CASIO Unidade: UN/1 F1 F4

UN: R\$ 19,96 AV: R\$ 19,96 15: R\$ 20,37  
30: R\$ 20,78 45: R\$ 21,20 60: R\$ 21,62



RELOGIO PULSO METAL CASIO GRAFITE

Código: 41269 Fábrica: CASIO Unidade: UN/1 F4

UN: R\$ 13,97 AV: R\$ 13,97 15: R\$ 14,26  
30: R\$ 14,54 45: R\$ 14,83 60: R\$ 15,13



RELOGIO PULSO METAL CASIO PRATA

Código: 35009 Fábrica: CASIO Unidade: UN/1 F4

UN: R\$ 13,97 AV: R\$ 13,97 15: R\$ 14,26  
30: R\$ 14,54 45: R\$ 14,83 60: R\$ 15,13



RELOGIO PULSO METAL CASIO ROSE GOLD

Código: 41270 Fábrica: CASIO Unidade: UN/1 F4

UN: R\$ 11,98 AV: R\$ 11,98 15: R\$ 12,23  
30: R\$ 12,48 45: R\$ 12,72 60: R\$ 12,98



RELOGIO PULSO METAL FEMININO

Código: 40744 Fábrica: FELE Unidade: UN/1 F1 F4

UN: R\$ 11,98 AV: R\$ 11,98 15: R\$ 12,23  
30: R\$ 12,48 45: R\$ 12,72 60: R\$ 12,98



RELOGIO PULSO METAL MASCULINO

Código: 40745 Fábrica: FELE Unidade: UN/1 F1 F4

UN: R\$ 33,94 AV: R\$ 33,94 15: R\$ 34,64  
30: R\$ 35,34 45: R\$ 36,04 60: R\$ 36,76



RELOGIO PULSO PULSEIRA METAL DOURADO

Código: 23440 Fábrica: SP Unidade: UN/1 F1 F4

UN: R\$ 10,98 AV: R\$ 10,98 15: R\$ 11,21  
30: R\$ 11,44 45: R\$ 11,66 60: R\$ 11,90



RELOGIO PULSO SILICONE COLOR FEM

Código: 40749 Fábrica: FELE Unidade: UN/1 F1 F4

UN: R\$ 10,48 AV: R\$ 10,48 15: R\$ 10,70  
30: R\$ 10,92 45: R\$ 11,13 60: R\$ 11,36



RELOGIO PULSO SILICONE DIGITAL

Código: 40743 Fábrica: FELE Unidade: UN/1 F1 F4

UN: R\$ 11,98 AV: R\$ 11,98 15: R\$ 12,23  
30: R\$ 12,48 45: R\$ 12,72 60: R\$ 12,98



RELOGIO PULSO SILICONE MASC

Código: 40750 Fábrica: FELE Unidade: UN/1 F1 F4

UN: R\$ 11,98 AV: R\$ 11,98 15: R\$ 12,23  
30: R\$ 12,48 45: R\$ 12,72 60: R\$ 12,98



RELOGIO PULSO TP COURO FEM

Código: 40746 Fábrica: FELE Unidade: UN/1 F1 F4

UN: R\$ 1,72 AV: R\$ 8,62 15: R\$ 8,80  
30: R\$ 8,97 45: R\$ 9,15 60: R\$ 9,33



ROLHA CONICA 19X23X19MM 94 5X1

Código: 45630 Fábrica: CORTIARTE Unidade: PT/5 F1 F4

UN: R\$ 1,56 AV: R\$ 77,87 15: R\$ 79,49  
30: R\$ 81,08 45: R\$ 82,70 60: R\$ 84,35



ROLHA CONICA 19X23X19MM 94 50X1

Código: 49133 Fábrica: CORTIARTE Unidade: PT/50 F1 F4

UN: R\$ 0,04 AV: R\$ 17,96 15: R\$ 18,34  
30: R\$ 18,70 45: R\$ 19,08 60: R\$ 19,46



SACO PLAST BOB 20X30CM PICOTADO 500X1

Código: 44364 Fábrica: ECO ROLL Unidade: RL/500 F1 F4

UN: R\$ 0,05 AV: R\$ 24,95 15: R\$ 25,47  
30: R\$ 25,98 45: R\$ 26,50 60: R\$ 27,03



SACO PLAST BOB 30X30CM PICOTADO 500X1 5K  
Código: Fábrica: Unidade:  
**44759** VERTEX RL/500  
F1 F4

UN: R\$ 0,14 AV: R\$ 57,61 15: R\$ 58,81  
30: R\$ 59,98 45: R\$ 61,18 60: R\$ 62,41



SACO PLAST BOB 40X60CM PICOTADO 400X1  
Código: Fábrica: Unidade:  
**44368** ECO ROLL PT/400  
F1 F4

UN: R\$ 0,85 AV: R\$ 42,58 15: R\$ 43,47  
30: R\$ 44,34 45: R\$ 45,23 60: R\$ 46,13



SACO PLAST LIXO AZUL 59X62CM 30L 50X1  
Código: Fábrica: Unidade:  
**50102** VERTEX PT/50  
F1 F4

UN: R\$ 0,15 AV: R\$ 14,97 15: R\$ 15,28  
30: R\$ 15,58 45: R\$ 15,90 60: R\$ 16,21



SACO PLAST LIXO PTO 39CMX58CM 15L 100X1  
Código: Fábrica: Unidade:  
**50844** POLIFILME RL/100  
F1 F4

UN: R\$ 0,28 AV: R\$ 13,97 15: R\$ 14,26  
30: R\$ 14,54 45: R\$ 14,83 60: R\$ 15,13



SACO PLAST LIXO PTO 59X62CM 30L 50X1  
Código: Fábrica: Unidade:  
**50830** POLIFILME RL/50  
F1 F4

UN: R\$ 0,47 AV: R\$ 13,97 15: R\$ 14,26  
30: R\$ 14,54 45: R\$ 14,83 60: R\$ 15,13



SACO PLAST LIXO PTO 63CMX80CM 50L 30X1  
Código: Fábrica: Unidade:  
**50832** POLIFILME RL/30  
F1 F4

UN: R\$ 0,78 AV: R\$ 13,97 15: R\$ 14,26  
30: R\$ 14,54 45: R\$ 14,83 60: R\$ 15,13



SACO PLAST LIXO PTO 75CMX105CM 100L 18X1  
Código: Fábrica: Unidade:  
**50831** POLIFILME RL/18  
F1 F4

UN: R\$ 1,28 AV: R\$ 31,94 15: R\$ 32,60  
30: R\$ 33,26 45: R\$ 33,92 60: R\$ 34,60



SACO PLAST LIXO PTO 75CMX1,05M 100L 25X1  
Código: Fábrica: Unidade:  
**44363** VERTEX RL/25  
F1 F4

UN: R\$ 0,31 AV: R\$ 2,50 15: R\$ 2,55  
30: R\$ 2,60 45: R\$ 2,65 60: R\$ 2,70

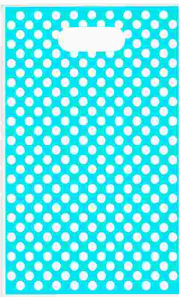

SACOLA PLAST PRES 16X25CM BOLIN AZUL 8X1  
Código: Fábrica: Unidade:  
**39570** VMP PT/8  
F1 F4

UN: R\$ 0,31 AV: R\$ 2,50 15: R\$ 2,55  
30: R\$ 2,60 45: R\$ 2,65 60: R\$ 2,70

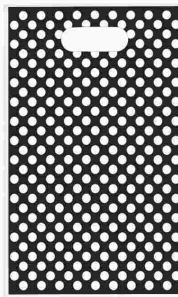

SACOLA PLAST PRES 16X25CM BOLIN PRET 8X1  
Código: Fábrica: Unidade:  
**39569** VMP PT/8  
F1 F4

UN: R\$ 0,31 AV: R\$ 2,50 15: R\$ 2,55  
30: R\$ 2,60 45: R\$ 2,65 60: R\$ 2,70



SACOLA PLAST PRES 16X25CM BOLIN ROSA 8X1  
Código: Fábrica: Unidade:  
**39568** VMP PT/8  
F1 F4

UN: R\$ 0,31 AV: R\$ 2,50 15: R\$ 2,55  
30: R\$ 2,60 45: R\$ 2,65 60: R\$ 2,70

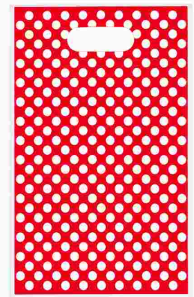

SACOLA PLAST PRES 16X25CM BOLIN VERM 8X1  
Código: Fábrica: Unidade:  
**39567** VMP PT/8  
F1 F4

UN: R\$ 0,31 AV: R\$ 2,50 15: R\$ 2,55  
30: R\$ 2,60 45: R\$ 2,65 60: R\$ 2,70

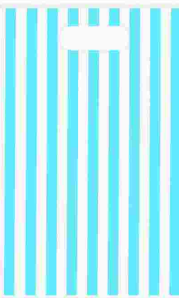

SACOLA PLAST PRES 16X25CM LISTR AZUL 8X1  
Código: Fábrica: Unidade:  
**39572** VMP PT/8  
F1 F4

UN: R\$ 0,31 AV: R\$ 2,50 15: R\$ 2,55  
30: R\$ 2,60 45: R\$ 2,65 60: R\$ 2,70



SACOLA PLAST PRES 16X25CM LISTR ROSA 8X1  
Código: Fábrica: Unidade:  
**39565** VMP PT/8  
F1 F4

UN: R\$ 0,31 AV: R\$ 2,50 15: R\$ 2,55  
30: R\$ 2,60 45: R\$ 2,65 60: R\$ 2,70

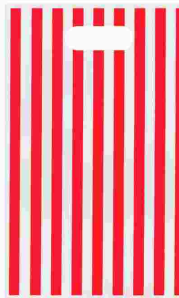

SACOLA PLAST PRES 16X25CM LISTR VERM 8X1  
Código: Fábrica: Unidade:  
**39564** VMP PT/8  
F1 F4

UN: R\$ 69,88 AV: R\$ 69,88 15: R\$ 71,33  
30: R\$ 72,76 45: R\$ 74,22 60: R\$ 75,70

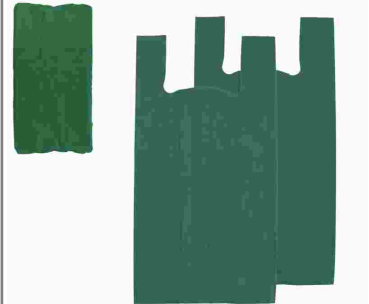

SACOLA PLAST RECIC 30X40CM P VERDE 3KG  
Código: Fábrica: Unidade:  
**47257** MAXIPLASTICO PT/1  
F1 F4

UN: R\$ 114,81 AV: R\$ 114,81 15: R\$ 117,20  
30: R\$ 119,54 45: R\$ 121,93 60: R\$ 124,37

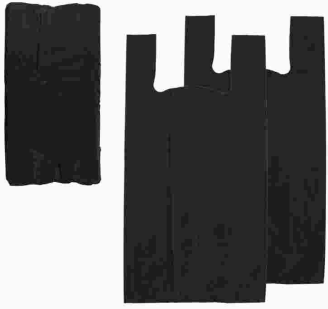

SACOLA PLAST RECIC 40X50CM M PRETA 5KG

Código: 44605 Fábrica: MAXIPLASTICO Unidade: PT/1 F1 F4

UN: R\$ 119,80 AV: R\$ 119,80 15: R\$ 122,29  
30: R\$ 124,74 45: R\$ 127,23 60: R\$ 129,78

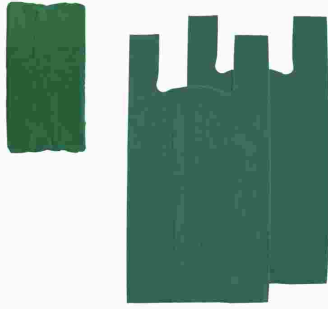

SACOLA PLAST RECIC 40X50CM M VERDE 5KG

Código: 44608 Fábrica: MAXIPLASTICO Unidade: PT/1 F1 F4

UN: R\$ 119,80 AV: R\$ 119,80 15: R\$ 122,29  
30: R\$ 124,74 45: R\$ 127,23 60: R\$ 129,78



SACOLA PLAST RECIC 50X60CM G VERDE 5KG

Código: 44609 Fábrica: MAXIPLASTICO Unidade: PT/1 F1 F4

UN: R\$ 119,80 AV: R\$ 119,80 15: R\$ 122,29  
30: R\$ 124,74 45: R\$ 127,23 60: R\$ 129,78



SACOLA PLAST RECIC 60X75CM GG VERDE 5KG

Código: 44610 Fábrica: MAXIPLASTICO Unidade: PT/1 F1 F4

UN: R\$ 119,80 AV: R\$ 119,80 15: R\$ 122,29  
30: R\$ 124,74 45: R\$ 127,23 60: R\$ 129,78



SACOLA PLAST RECIC 80X100CM XG VERDE 5KG

Código: 44611 Fábrica: MAXIPLASTICO Unidade: PT/1 F1 F4

UN: R\$ 44,92 AV: R\$ 44,92 15: R\$ 45,85  
30: R\$ 46,77 45: R\$ 47,71 60: R\$ 48,66

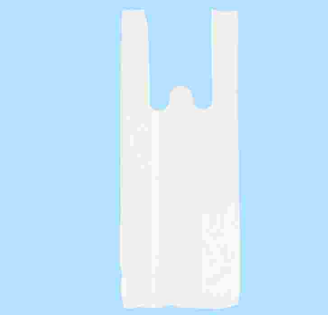

SACOLA PLAST 25X35CM BRANCA 1000X1

Código: 47373 Fábrica: PACK-FORT Unidade: PT/1 F1 F4

UN: R\$ 29,70 AV: R\$ 29,70 15: R\$ 30,32  
30: R\$ 30,93 45: R\$ 31,55 60: R\$ 32,18



SOMBRINHA 8V DUP GIG CB CURV MAN 401.1

Código: 17656 Fábrica: MIZPA Unidade: UN/1 F1 F4

UN: R\$ 29,70 AV: R\$ 29,70 15: R\$ 30,32  
30: R\$ 30,93 45: R\$ 31,55 60: R\$ 32,18



SOMBRINHA 8V DUP GIG CB RETO MAN 403.3

Código: 17649 Fábrica: MIZPA Unidade: UN/1 F1 F4

UN: R\$ 19,99 AV: R\$ 19,99 15: R\$ 19,99  
30: R\$ 19,99 45: R\$ 19,99 60: R\$ 19,99



SOMBRINHA 8V INF C/APITO AUT 5169-CD

Código: 24724 Fábrica: RISOVIT Unidade: UN/1 F1 F4

UN: R\$ 28,94 AV: R\$ 28,94 15: R\$ 29,55  
30: R\$ 30,14 45: R\$ 30,74 60: R\$ 31,36



SOMBRINHA 8V LONG XAD CB RET AU 1223-A3

Código: 17662 Fábrica: HIMEB Unidade: UN/1 F1 F4

UN: R\$ 54,19 AV: R\$ 54,19 15: R\$ 55,32  
30: R\$ 56,43 45: R\$ 57,56 60: R\$ 58,71



SOMBRINHA 8V LONGA CB CURV MAD AUT AZUL

Código: 46902 Fábrica: MIZPA Unidade: UN/1 F1 F4

UN: R\$ 54,19 AV: R\$ 54,19 15: R\$ 55,32  
30: R\$ 56,43 45: R\$ 57,56 60: R\$ 58,71



SOMBRINHA 8V LONGA CB CURV MAD AUT ROSA

Código: 46905 Fábrica: MIZPA Unidade: UN/1 F1 F4

UN: R\$ 54,19 AV: R\$ 54,19 15: R\$ 55,32  
30: R\$ 56,43 45: R\$ 57,56 60: R\$ 58,71



SOMBRINHA 8V LONGA CB CURV MAD AUT VERD

Código: 46903 Fábrica: MIZPA Unidade: UN/1 F1 F4

UN: R\$ 54,19 AV: R\$ 54,19 15: R\$ 55,32  
30: R\$ 56,43 45: R\$ 57,56 60: R\$ 58,71



SOMBRINHA 8V LONGA CB CURV MAD AUT VERM

Código: 46904 Fábrica: MIZPA Unidade: UN/1 F1 F4

UN: R\$ 23,72 AV: R\$ 23,72 15: R\$ 24,22  
30: R\$ 24,70 45: R\$ 25,19 60: R\$ 25,70



SOMBRINHA 8V LONGA TRANSP AUT 50008

Código: 50133 Fábrica: CASITA Unidade: UN/1 F1 F4

UN: R\$ 39,93 AV: R\$ 39,93 15: R\$ 40,76  
30: R\$ 41,57 45: R\$ 42,40 60: R\$ 43,25



SOMBRINHA 8V MED NEON CB CURVO AUT

Código: 41069 Fábrica: M.BRILHANTE Unidade: UN/1 F1 F4

UN: R\$ 26,95 AV: R\$ 26,95 15: R\$ 27,51  
30: R\$ 28,06 45: R\$ 28,62 60: R\$ 29,19



SOMBRINHA 8V MINI DUPLA FACE MAN 3154H  
Código: 45863 Fábrica: HIMEB Unidade: UN/1 F1 F4

UN: R\$ 24,95 AV: R\$ 24,95 15: R\$ 25,47  
30: R\$ 25,98 45: R\$ 26,50 60: R\$ 27,03



SOMBRINHA 8V MINI DUPLA FACE MAN 3954Y  
Código: 45864 Fábrica: LURS Unidade: UN/1 F1 F4

UN: R\$ 24,95 AV: R\$ 24,95 15: R\$ 25,47  
30: R\$ 25,98 45: R\$ 26,50 60: R\$ 27,03



SOMBRINHA 8V MINI MAN C/BOLSA 13265/565  
Código: 23592 Fábrica: ELITE Unidade: UN/1 F1 F4

UN: R\$ 15,99 AV: R\$ 15,99 15: R\$ 15,99  
30: R\$ 15,99 45: R\$ 15,99 60: R\$ 15,99



SOMBRINHA 8V MINI MAN 3959  
Código: 24537 Fábrica: RISОВI/HIMEB Unidade: UN/1 F1 F4

UN: R\$ 19,96 AV: R\$ 19,96 15: R\$ 20,37  
30: R\$ 20,78 45: R\$ 21,20 60: R\$ 21,62



SOMBRINHA 8V MINI MAN 908.8  
Código: 14096 Fábrica: MIZPA Unidade: UN/1 F1 F4

UN: R\$ 19,96 AV: R\$ 19,96 15: R\$ 20,37  
30: R\$ 20,78 45: R\$ 21,20 60: R\$ 21,62



SOMBRINHA 8V MINI MAN 909.9  
Código: 14088 Fábrica: MIZPA Unidade: UN/1 F1 F4

UN: R\$ 19,96 AV: R\$ 19,96 15: R\$ 20,37  
30: R\$ 20,78 45: R\$ 21,20 60: R\$ 21,62



SOMBRINHA 8V MINI MAN 916.6  
Código: 14101 Fábrica: MIZPA Unidade: UN/1 F1 F4

UN: R\$ 19,96 AV: R\$ 19,96 15: R\$ 20,37  
30: R\$ 20,78 45: R\$ 21,20 60: R\$ 21,62



SOMBRINHA 8V MINI MAN 917.7  
Código: 12057 Fábrica: MIZPA Unidade: UN/1 F1 F4

UN: R\$ 18,99 AV: R\$ 18,99 15: R\$ 18,99  
30: R\$ 18,99 45: R\$ 18,99 60: R\$ 18,99



SOMBRINHA 8V MINI XADREZ 3953  
Código: 13329 Fábrica: HIMEB Unidade: UN/1 F1 F4

UN: R\$ 16,99 AV: R\$ 16,99 15: R\$ 16,99  
30: R\$ 16,99 45: R\$ 16,99 60: R\$ 16,99



SOMBRINHA INF MONSTER HIGH 14436  
Código: 34554 Fábrica: BRIZI Unidade: UN/1 F1 F4

UN: R\$ 49,91 AV: R\$ 49,91 15: R\$ 50,95  
30: R\$ 51,97 45: R\$ 53,01 60: R\$ 54,07



SOMBRINHA 10V GIG 2 DOBRAS MAN 3789  
Código: 34036 Fábrica: HIMEB Unidade: UN/1 F1 F4

UN: R\$ 34,99 AV: R\$ 34,99 15: R\$ 34,99  
30: R\$ 34,99 45: R\$ 34,99 60: R\$ 34,99



SOMBRINHA 10V GIG 3 DOBRAS MAN 3750S  
Código: 45861 Fábrica: LURS Unidade: UN/1 F1 F4

UN: R\$ 39,93 AV: R\$ 39,93 15: R\$ 40,76  
30: R\$ 41,57 45: R\$ 42,40 60: R\$ 43,25



SOMBRINHA 10V GIG 3 DOBRAS MAN 3750X  
Código: 34076 Fábrica: LURS Unidade: UN/1 F1 F4

UN: R\$ 25,46 AV: R\$ 25,46 15: R\$ 25,99  
30: R\$ 26,51 45: R\$ 27,04 60: R\$ 27,58



SOMBRINHA 16V LONGA CETIM AUT 50005  
Código: 24601 Fábrica: CASITA Unidade: UN/1 F1 F4

UN: R\$ 22,99 AV: R\$ 22,99 15: R\$ 22,99  
30: R\$ 22,99 45: R\$ 22,99 60: R\$ 22,99



SOMBRINHA 16V LONGA CETIM AUT 5088-16  
Código: 12084 Fábrica: RISOVIT Unidade: UN/1 F1 F4

UN: R\$ 29,45 AV: R\$ 29,45 15: R\$ 30,07  
30: R\$ 30,67 45: R\$ 31,28 60: R\$ 31,91



SOMBRINHA 16V LONGA CETIM AUT 5088-16G  
Código: 45747 Fábrica: HIMEB Unidade: UN/1 F1 F4

UN: R\$ 29,99 AV: R\$ 29,99 15: R\$ 29,99  
30: R\$ 29,99 45: R\$ 29,99 60: R\$ 29,99



SOMBRINHA 16V LONGA FORRO DUPLO 1816  
Código: Fábrika: Unidade:  
**28825** RISOVIT UN/1  
F1 F4

UN: R\$ 15,99 AV: R\$ 15,99 15: R\$ 15,99  
30: R\$ 15,99 45: R\$ 15,99 60: R\$ 15,99



SOMBRINHA 7V MINI C/CAPA 50014  
Código: Fábrika: Unidade:  
**14750** CASITA UN/1  
F1 F4

UN: R\$ 18,65 AV: R\$ 18,65 15: R\$ 19,04  
30: R\$ 19,42 45: R\$ 19,81 60: R\$ 20,20



SOMBRINHA 8V MINI ESTAMP MAN 1290  
Código: Fábrika: Unidade:  
**14089** ELITE UN/1  
F1 F4

UN: R\$ 16,96 AV: R\$ 16,96 15: R\$ 17,32  
30: R\$ 17,66 45: R\$ 18,02 60: R\$ 18,38



SOQUETE 3 MTS C/RABICHO PRETO CTL 32150  
Código: Fábrika: Unidade:  
**31023** LIDER PLUS UN/1  
F1 F4

UN: R\$ 21,95 AV: R\$ 21,95 15: R\$ 22,41  
30: R\$ 22,86 45: R\$ 23,32 60: R\$ 23,78



SOQUETE 5 MTS C/RABICHO PRETO CTL 32151  
Código: Fábrika: Unidade:  
**31024** LIDER PLUS UN/1  
F1 F4

UN: R\$ 4,28 AV: R\$ 42,83 15: R\$ 43,72  
30: R\$ 44,60 45: R\$ 45,49 60: R\$ 46,40



SOQUETE C/RABICHO EF10 10X1  
Código: Fábrika: Unidade:  
**39385** GIROFLASH PT/10  
F1 F4

UN: R\$ 33,94 AV: R\$ 33,94 15: R\$ 34,64  
30: R\$ 35,34 45: R\$ 36,04 60: R\$ 36,76



SOQUETE 10 MTS C/RABICHO PRETO CTL 32152  
Código: Fábrika: Unidade:  
**31025** LIDER PLUS UN/1  
F1 F4

UN: R\$ 99,83 AV: R\$ 99,83 15: R\$ 101,91  
30: R\$ 103,95 45: R\$ 106,03 60: R\$ 108,15



SUPORTE CELULAR VEIC CLIPE DE MOLA 30  
Código: Fábrika: Unidade:  
**50296** DOTCELL UN/1  
F1 F4

UN: R\$ 39,93 AV: R\$ 39,93 15: R\$ 40,76  
30: R\$ 41,57 45: R\$ 42,40 60: R\$ 43,25



SUPORTE GUIDAO MOTO C/CAPA CEL 8678  
Código: Fábrika: Unidade:  
**35343** INOVA UN/1  
F1 F4

UN: R\$ 35,94 AV: R\$ 35,94 15: R\$ 36,69  
30: R\$ 37,43 45: R\$ 38,17 60: R\$ 38,94



SUPORTE MOVEL P/CELULAR ZM-16  
Código: Fábrika: Unidade:  
**38235** INOVA UN/1  
F1 F4

UN: R\$ 10,18 AV: R\$ 10,18 15: R\$ 10,40  
30: R\$ 10,60 45: R\$ 10,82 60: R\$ 11,03



SUPORTE MOVEL P/CELULAR 7056  
Código: Fábrika: Unidade:  
**40808** BLESSED UN/1  
F1 F4

UN: R\$ 0,60 AV: R\$ 59,89 15: R\$ 61,14  
30: R\$ 62,36 45: R\$ 63,61 60: R\$ 64,88



SUPORTE PEGA BALAO 33CM CRISTAL 100X1  
Código: Fábrika: Unidade:  
**48599** KLFESTAS PT/100  
F1 F4

UN: R\$ 6,04 AV: R\$ 6,04 15: R\$ 6,17  
30: R\$ 6,29 45: R\$ 6,42 60: R\$ 6,54



SUPORTE PLAST C/VENTOSA P/CELULAR 1083  
Código: Fábrika: Unidade:  
**38223** AGUIABRANCA UN/1  
F1 F4

UN: R\$ 12,98 AV: R\$ 12,98 15: R\$ 13,25  
30: R\$ 13,51 45: R\$ 13,78 60: R\$ 14,06



SUPORTE PLAST DE BICICLETA P/CELULAR 771  
Código: Fábrika: Unidade:  
**36447** AGUIABRANCA UN/1  
F1 F4

UN: R\$ 0,30 AV: R\$ 29,94 15: R\$ 30,57  
30: R\$ 31,18 45: R\$ 31,80 60: R\$ 32,44



TAMPA PLAST 28MM GARRAFA PET AZUL 100X1  
Código: Fábrika: Unidade:  
**50850** ARBRA PT/100  
F1 F4

UN: R\$ 0,30 AV: R\$ 29,94 15: R\$ 30,57  
30: R\$ 31,18 45: R\$ 31,80 60: R\$ 32,44



TAMPA PLAST 28MM GARRAFA PET BRANC 100X1  
Código: Fábrika: Unidade:  
**50847** ARBRA PT/100  
F1 F4

UN: R\$ 6,01 AV: R\$ 72,13 15: R\$ 73,64  
30: R\$ 75,11 45: R\$ 76,61 60: R\$ 78,14



TANGA AD COTTON 202 G LISA 12X1

Código: **22014** Fábrica: LELE LULU Unidade: PT/12 F1 F4

UN: R\$ 6,01 AV: R\$ 72,13 15: R\$ 73,64  
30: R\$ 75,11 45: R\$ 76,61 60: R\$ 78,14



TANGA AD COTTON 202 M 12X1

Código: **22013** Fábrica: LELE LULU Unidade: PT/12 F1 F4

UN: R\$ 6,01 AV: R\$ 72,13 15: R\$ 73,64  
30: R\$ 75,11 45: R\$ 76,61 60: R\$ 78,14



TANGA AD COTTON 202 P LISA 12X1

Código: **22015** Fábrica: LELE LULU Unidade: PT/12 F1 F4

UN: R\$ 8,31 AV: R\$ 99,74 15: R\$ 101,82  
30: R\$ 103,85 45: R\$ 105,93 60: R\$ 108,05



TANGA AD COTTON 210 G EXP EST 12X1

Código: **37334** Fábrica: LELE LULU Unidade: PT/12 F1 F4

UN: R\$ 8,31 AV: R\$ 99,74 15: R\$ 101,82  
30: R\$ 103,85 45: R\$ 105,93 60: R\$ 108,05



TANGA AD COTTON 210 P 12X1

Código: **29545** Fábrica: LELE LULU Unidade: PT/12 F1 F4

UN: R\$ 8,31 AV: R\$ 99,74 15: R\$ 101,82  
30: R\$ 103,85 45: R\$ 105,93 60: R\$ 108,05



TANGA AD COTTON 210 GG EXP EST 12X1

Código: **37335** Fábrica: LELE LULU Unidade: PT/12 F1 F4

UN: R\$ 8,31 AV: R\$ 99,74 15: R\$ 101,82  
30: R\$ 103,85 45: R\$ 105,93 60: R\$ 108,05



TANGA AD COTTON 210.1 GG EXP LISO 12X1

Código: **29548** Fábrica: LELE LULU Unidade: PT/12 F1 F4

UN: R\$ 8,31 AV: R\$ 99,74 15: R\$ 101,82  
30: R\$ 103,85 45: R\$ 105,93 60: R\$ 108,05



TANGA AD COTTON 210.1 M EXP LISO 12X1

Código: **29546** Fábrica: LELE LULU Unidade: PT/12 F1 F4

UN: R\$ 8,32 AV: R\$ 99,83 15: R\$ 101,91  
30: R\$ 103,95 45: R\$ 106,03 60: R\$ 108,15



TANGA AD COTTON 210.1 P EXP LISO 12X1

Código: **40739** Fábrica: LELE LULU Unidade: PT/12 F1 F4

UN: R\$ 5,92 AV: R\$ 70,99 15: R\$ 72,47  
30: R\$ 73,91 45: R\$ 75,39 60: R\$ 76,90



TANGA AD MICROFIBRA 210 G LISA 12X1

Código: **36321** Fábrica: LELE LULU Unidade: PT/12 F1 F4

UN: R\$ 5,92 AV: R\$ 70,99 15: R\$ 72,47  
30: R\$ 73,91 45: R\$ 75,39 60: R\$ 76,90



TANGA AD MICROFIBRA 210 M LISA 12X1

Código: **36320** Fábrica: LELE LULU Unidade: PT/12 F1 F4

UN: R\$ 5,92 AV: R\$ 70,99 15: R\$ 72,47  
30: R\$ 73,91 45: R\$ 75,39 60: R\$ 76,90



TANGA AD MICROFIBRA 210 P LISA 12X1

Código: **38494** Fábrica: LELE LULU Unidade: PT/12 F1 F4

UN: R\$ 5,92 AV: R\$ 70,99 15: R\$ 72,47  
30: R\$ 73,91 45: R\$ 75,39 60: R\$ 76,90



TANGA AD MICROFIBRA 210 G EST 12X1

Código: **32685** Fábrica: LELE LULU Unidade: PT/12 F1 F4

UN: R\$ 5,92 AV: R\$ 70,99 15: R\$ 72,47  
30: R\$ 73,91 45: R\$ 75,39 60: R\$ 76,90



TANGA AD MICROFIBRA 210 GG EST 12X1

Código: **32686** Fábrica: LELE LULU Unidade: PT/12 F1 F4

UN: R\$ 5,92 AV: R\$ 70,99 15: R\$ 72,47  
30: R\$ 73,91 45: R\$ 75,39 60: R\$ 76,90



TANGA AD MICROFIBRA 210 M EST 12X1

Código: **32684** Fábrica: LELE LULU Unidade: PT/12 F1 F4

UN: R\$ 5,92 AV: R\$ 70,99 15: R\$ 72,47  
30: R\$ 73,91 45: R\$ 75,39 60: R\$ 76,90



TANGA AD MICROFIBRA 210 P EST 12X1

Código: **32683** Fábrica: LELE LULU Unidade: PT/12 F1 F4

UN: R\$ 6,70 AV: R\$ 80,37 15: R\$ 82,05  
30: R\$ 83,69 45: R\$ 85,36 60: R\$ 87,07



TANGAO AD COTTON 203 G ESTAMP 12X1

Código: 32681 Fábrica: LELE LULU Unidade: PT/12 F1 F4

UN: R\$ 6,70 AV: R\$ 80,37 15: R\$ 82,05  
30: R\$ 83,69 45: R\$ 85,36 60: R\$ 87,07



TANGAO AD COTTON 203 GG 12X1

Código: 32682 Fábrica: LELE LULU Unidade: PT/12 F1 F4

UN: R\$ 6,70 AV: R\$ 80,37 15: R\$ 82,05  
30: R\$ 83,69 45: R\$ 85,36 60: R\$ 87,07



TANGAO AD COTTON 203 M ESTAMP 12X1

Código: 32680 Fábrica: LELE LULU Unidade: PT/12 F1 F4

UN: R\$ 9,98 AV: R\$ 119,81 15: R\$ 122,30  
30: R\$ 124,75 45: R\$ 127,25 60: R\$ 129,79



TANGAO AD COTTON 211 GG EXP ESTAMP 12X1

Código: 32679 Fábrica: LELE LULU Unidade: PT/12 F1 F4

UN: R\$ 9,98 AV: R\$ 119,81 15: R\$ 122,30  
30: R\$ 124,75 45: R\$ 127,25 60: R\$ 129,79



TANGAO AD COTTON 211.1 G EXP LISO 12X1

Código: 37331 Fábrica: LELE LULU Unidade: PT/12 F1 F4

UN: R\$ 9,98 AV: R\$ 119,81 15: R\$ 122,30  
30: R\$ 124,75 45: R\$ 127,25 60: R\$ 129,79



TANGAO AD COTTON 211.1 GG EXP LISO 12X1

Código: 37330 Fábrica: LELE LULU Unidade: PT/12 F1 F4

UN: R\$ 9,98 AV: R\$ 119,81 15: R\$ 122,30  
30: R\$ 124,75 45: R\$ 127,25 60: R\$ 129,79



TANGAO AD COTTON 211.1 M EXP LISO 12X1

Código: 37332 Fábrica: LELE LULU Unidade: PT/12 F1 F4

UN: R\$ 9,98 AV: R\$ 119,81 15: R\$ 122,30  
30: R\$ 124,75 45: R\$ 127,25 60: R\$ 129,79



TANGAO AD COTTON 211.2 G ESTAMP 12X1

Código: 32678 Fábrica: LELE LULU Unidade: PT/12 F1 F4

UN: R\$ 9,98 AV: R\$ 119,81 15: R\$ 122,30  
30: R\$ 124,75 45: R\$ 127,25 60: R\$ 129,79



TANGAO AD COTTON 211.2 GG ESTAMP 12X1

Código: 39704 Fábrica: LELE LULU Unidade: PT/12 F1 F4

UN: R\$ 9,98 AV: R\$ 119,81 15: R\$ 122,30  
30: R\$ 124,75 45: R\$ 127,25 60: R\$ 129,79



TANGAO AD COTTON 211.2 M ESTAMP 12X1

Código: 39702 Fábrica: LELE LULU Unidade: PT/12 F1 F4

UN: R\$ 13,48 AV: R\$ 13,48 15: R\$ 13,76  
30: R\$ 14,03 45: R\$ 14,32 60: R\$ 14,60

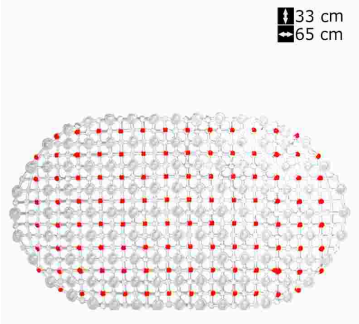

TAPETE ANTID C/VENTOSA 65CM 1111

Código: 44516 Fábrica: NICOBEM Unidade: UN/1 F1 F4

UN: R\$ 12,97 AV: R\$ 12,97 15: R\$ 13,24  
30: R\$ 13,50 45: R\$ 13,77 60: R\$ 14,05

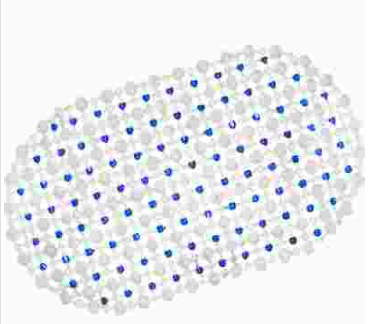

TAPETE ANTID MASSAGEADOR 34X64CM 0080

Código: 25340 Fábrica: TALBERG Unidade: UN/1 F1 F4

UN: R\$ 62,45 AV: R\$ 62,45 15: R\$ 63,75  
30: R\$ 65,03 45: R\$ 66,33 60: R\$ 67,65



TAPETE ANTID 70CM 582

Código: 46435 Fábrica: HOME Unidade: UN/1 F1 F4

UN: R\$ 34,94 AV: R\$ 34,94 15: R\$ 35,67  
30: R\$ 36,39 45: R\$ 37,11 60: R\$ 37,86



TAPETE CARPETE AUTOMOTIVO C/4 PCS 5772

Código: 25449 Fábrica: YING FA Unidade: UN/1 F1 F4

UN: R\$ 0,30 AV: R\$ 17,97 15: R\$ 18,35  
30: R\$ 18,71 45: R\$ 19,09 60: R\$ 19,47



TATUAGEM SORTIDA 20X3 MY19-6

Código: 27808 Fábrica: MB YOUSSEF Unidade: PT/60 F1 F4

UN: R\$ 69,88 AV: R\$ 69,88 15: R\$ 71,33  
30: R\$ 72,76 45: R\$ 74,22 60: R\$ 75,70



TELEFONE C/FIO KXT102

Código: 14622 Fábrica: HAI BRASIL Unidade: UN/1 F1 F4

UN: R\$ 12,97 AV: R\$ 12,97 15: R\$ 13,24  
30: R\$ 13,50 45: R\$ 13,77 60: R\$ 14,05



TESOURA ACO INOX CABO PP EMB GRANDE

Código: Fábrica: Unidade:  
**14676** LYKE UN/1  
F1 F4

UN: R\$ 16,57 AV: R\$ 16,57 15: R\$ 16,92  
30: R\$ 17,26 45: R\$ 17,60 60: R\$ 17,95

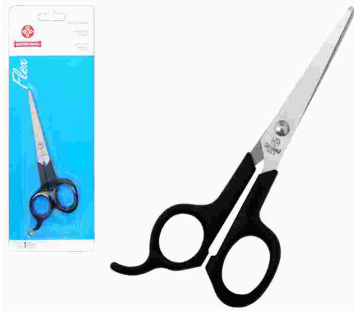

TESOURA INOX BARBEIRO 3,8'' 163-5

Código: Fábrica: Unidade:  
**14439** MUNDIAL UN/1  
F1 F4

UN: R\$ 27,42 AV: R\$ 27,42 15: R\$ 27,99  
30: R\$ 28,55 45: R\$ 29,12 60: R\$ 29,70



TESOURA INOX BARBEIRO 7,5'' 163-7

Código: Fábrica: Unidade:  
**14440** MUNDIAL UN/1  
F1 F4

UN: R\$ 10,48 AV: R\$ 10,48 15: R\$ 10,70  
30: R\$ 10,92 45: R\$ 11,13 60: R\$ 11,36



TESOURA INOX CB EMB 25CM 10'' CTL 707

Código: Fábrica: Unidade:  
**49612** WINMAX UN/1  
F1 F4

UN: R\$ 4,58 AV: R\$ 4,58 15: R\$ 4,68  
30: R\$ 4,77 45: R\$ 4,87 60: R\$ 4,96



TESOURA INOX MULTIUSO 19 CM 7,5'' 2085

Código: Fábrica: Unidade:  
**50140** GP6 CR/1  
F1 F4

UN: R\$ 5,48 AV: R\$ 5,48 15: R\$ 5,60  
30: R\$ 5,71 45: R\$ 5,82 60: R\$ 5,94



TESOURA INOX MULTIUSO 20 CM ALFA 671

Código: Fábrica: Unidade:  
**48679** PLANETA UN/1  
F1 F4

UN: R\$ 5,48 AV: R\$ 5,48 15: R\$ 5,60  
30: R\$ 5,71 45: R\$ 5,82 60: R\$ 5,94



TESOURA INOX MULTIUSO 20 CM 8'' 2087

Código: Fábrica: Unidade:  
**50139** GP6 CR/1  
F1 F4

UN: R\$ 4,78 AV: R\$ 4,78 15: R\$ 4,88  
30: R\$ 4,98 45: R\$ 5,08 60: R\$ 5,18



TESOURA INOX MULTIUSO 5 1/2 ALFA 669

Código: Fábrica: Unidade:  
**47991** PLANETA UN/1  
F1 F4

UN: R\$ 6,98 AV: R\$ 6,98 15: R\$ 7,12  
30: R\$ 7,27 45: R\$ 7,41 60: R\$ 7,56



TESOURA INOX P/COSTURA 24CM 9,5'' 4224

Código: Fábrica: Unidade:  
**41083** IDEA UN/1  
F1 F4

UN: R\$ 49,91 AV: R\$ 49,91 15: R\$ 50,95  
30: R\$ 51,97 45: R\$ 53,01 60: R\$ 54,07



TESOURA INOX P/COSTURA 8'' 2534

Código: Fábrica: Unidade:  
**43396** SEKICH UN/1  
F1 F4

UN: R\$ 7,98 AV: R\$ 7,98 15: R\$ 8,14  
30: R\$ 8,31 45: R\$ 8,47 60: R\$ 8,64



TESOURA INOX P/UNHAS CURVA CTL 1235

Código: Fábrica: Unidade:  
**37870** SEKICH CR/1  
F1 F4

UN: R\$ 7,98 AV: R\$ 7,98 15: R\$ 8,14  
30: R\$ 8,31 45: R\$ 8,47 60: R\$ 8,64



TESOURA INOX P/UNHAS RETA CTL 1234

Código: Fábrica: Unidade:  
**8896** SEKICH CR/1  
F1 F4

UN: R\$ 4,78 AV: R\$ 4,78 15: R\$ 4,88  
30: R\$ 4,98 45: R\$ 5,08 60: R\$ 5,18



TESOURA INOX USO GERAL 14 CM CTL HA55

Código: Fábrica: Unidade:  
**30637** HAI BRASIL UN/1  
F1 F4

UN: R\$ 4,99 AV: R\$ 4,99 15: R\$ 4,99  
30: R\$ 4,99 45: R\$ 4,99 60: R\$ 4,99



TESOURA INOX USO GERAL 17 CM 6,5'' CTL

Código: Fábrica: Unidade:  
**39246** ALIANCA UN/1  
F1 F4

UN: R\$ 6,48 AV: R\$ 6,48 15: R\$ 6,61  
30: R\$ 6,75 45: R\$ 6,88 60: R\$ 7,02



TESOURA INOX USO GERAL 19 CM CTL HA75

Código: Fábrica: Unidade:  
**30636** HAI BRASIL UN/1  
F1 F4

UN: R\$ 9,58 AV: R\$ 9,58 15: R\$ 9,78  
30: R\$ 9,98 45: R\$ 10,18 60: R\$ 10,38



TESOURA INOX USO GERAL 21 CM CTL 2102

Código: Fábrica: Unidade:  
**29923** BRW UN/1  
F1 F4

UN: R\$ 14,38 AV: R\$ 14,38 15: R\$ 14,68  
30: R\$ 14,97 45: R\$ 15,27 60: R\$ 15,57



TESOURA INOX 13CM ZIG ZAG CTL 22542

Código: 48404 Fábrica: ACRILEX Unidade: CR/1 F1 F4

UN: R\$ 3,88 AV: R\$ 3,88 15: R\$ 3,96  
30: R\$ 4,04 45: R\$ 4,12 60: R\$ 4,21



TESOURA INOX 13CM 5" CTL 147-23

Código: 44766 Fábrica: NICOBEM Unidade: UN/1 F1 F4

UN: R\$ 4,14 AV: R\$ 4,14 15: R\$ 4,23  
30: R\$ 4,31 45: R\$ 4,40 60: R\$ 4,49



TESOURA INOX 14 CM 5,5" CTL 147-40

Código: 44765 Fábrica: NICOBEM Unidade: UN/1 F1 F4

UN: R\$ 5,28 AV: R\$ 5,28 15: R\$ 5,39  
30: R\$ 5,50 45: R\$ 5,61 60: R\$ 5,72



TESOURA INOX 17CM 7" 7239

Código: 43584 Fábrica: IDEA Unidade: CR/1 F1 F4

UN: R\$ 8,57 AV: R\$ 8,57 15: R\$ 8,74  
30: R\$ 8,92 45: R\$ 9,10 60: R\$ 9,28



TESOURA MULTI-USO CB PRETO 17 CM 864

Código: 41905 Fábrica: LYKE Unidade: UN/1 F1 F4

UN: R\$ 64,89 AV: R\$ 64,89 15: R\$ 66,24  
30: R\$ 67,56 45: R\$ 68,91 60: R\$ 70,29



TESOURA PICOTAR INOX 23CM ZIG ZAG 9"

Código: 45076 Fábrica: NYBC Unidade: UN/1 F1 F4

UN: R\$ 4,82 AV: R\$ 28,94 15: R\$ 29,55  
30: R\$ 30,14 45: R\$ 30,74 60: R\$ 31,36



TINTOL 45 GRS AMARELO CANARIO 2 6X1

Código: 12785 Fábrica: TUPY Unidade: PT/6 F1 F4

UN: R\$ 4,82 AV: R\$ 28,94 15: R\$ 29,55  
30: R\$ 30,14 45: R\$ 30,74 60: R\$ 31,36



TINTOL 45 GRS AZUL INDIGO 22 6X1

Código: 12777 Fábrica: TUPY Unidade: PT/6 F1 F4

UN: R\$ 4,82 AV: R\$ 28,94 15: R\$ 29,55  
30: R\$ 30,14 45: R\$ 30,74 60: R\$ 31,36



TINTOL 45 GRS AZUL MARINHO 23 6X1

Código: 12776 Fábrica: TUPY Unidade: PT/6 F1 F4

UN: R\$ 4,49 AV: R\$ 26,93 15: R\$ 27,49  
30: R\$ 28,04 45: R\$ 28,60 60: R\$ 29,17



TINTOL 45 GRS AZUL TURQUESA 13 6X1

Código: 39340 Fábrica: GUARANY Unidade: PT/6 F1 F4

UN: R\$ 4,82 AV: R\$ 28,94 15: R\$ 29,55  
30: R\$ 30,14 45: R\$ 30,74 60: R\$ 31,36



TINTOL 45 GRS AZUL TURQUESA 21 6X1

Código: 12778 Fábrica: TUPY Unidade: PT/6 F1 F4

UN: R\$ 4,49 AV: R\$ 26,93 15: R\$ 27,49  
30: R\$ 28,04 45: R\$ 28,60 60: R\$ 29,17



TINTOL 45 GRS AZUL 17 6X1

Código: 39339 Fábrica: GUARANY Unidade: PT/6 F1 F4

UN: R\$ 4,82 AV: R\$ 28,94 15: R\$ 29,55  
30: R\$ 30,14 45: R\$ 30,74 60: R\$ 31,36



TINTOL 45 GRS BEGE 30 6X1

Código: 12773 Fábrica: TUPY Unidade: PT/6 F1 F4

UN: R\$ 4,82 AV: R\$ 28,94 15: R\$ 29,55  
30: R\$ 30,14 45: R\$ 30,74 60: R\$ 31,36



TINTOL 45 GRS BORDO 16 6X1

Código: 12780 Fábrica: TUPY Unidade: PT/6 F1 F4

UN: R\$ 4,82 AV: R\$ 28,94 15: R\$ 29,55  
30: R\$ 30,14 45: R\$ 30,74 60: R\$ 31,36



TINTOL 45 GRS CINZA 34 6X1

Código: 12771 Fábrica: TUPY Unidade: PT/6 F1 F4

UN: R\$ 4,82 AV: R\$ 28,94 15: R\$ 29,55  
30: R\$ 30,14 45: R\$ 30,74 60: R\$ 31,36



TINTOL 45 GRS LARANJA CALIFORNIA 06 6X1

Código: 20568 Fábrica: TUPY Unidade: PT/6 F1 F4

UN: R\$ 4,82 AV: R\$ 28,94 15: R\$ 29,55  
30: R\$ 30,14 45: R\$ 30,74 60: R\$ 31,36



TINTOL 45 GRS LILAS 18 6X1

Código: Fábrika: Unidade:  
**20564** TUPY PT/6  
F1 F4

UN: R\$ 4,49 AV: R\$ 26,93 15: R\$ 27,49  
30: R\$ 28,04 45: R\$ 28,60 60: R\$ 29,17



TINTOL 45 GRS MARROM 27 6X1

Código: Fábrika: Unidade:  
**39341** GUARANY PT/6  
F1 F4

UN: R\$ 4,82 AV: R\$ 28,94 15: R\$ 29,55  
30: R\$ 30,14 45: R\$ 30,74 60: R\$ 31,36



TINTOL 45 GRS MARROM 32 6X1

Código: Fábrika: Unidade:  
**12772** TUPY PT/6  
F1 F4

UN: R\$ 4,82 AV: R\$ 28,94 15: R\$ 29,55  
30: R\$ 30,14 45: R\$ 30,74 60: R\$ 31,36



TINTOL 45 GRS PINK 13 6X1

Código: Fábrika: Unidade:  
**12782** TUPY PT/6  
F1 F4

UN: R\$ 4,82 AV: R\$ 28,94 15: R\$ 29,55  
30: R\$ 30,14 45: R\$ 30,74 60: R\$ 31,36



TINTOL 45 GRS PRETO 36 6X1

Código: Fábrika: Unidade:  
**12319** TUPY PT/6  
F1 F4

UN: R\$ 4,82 AV: R\$ 28,94 15: R\$ 29,55  
30: R\$ 30,14 45: R\$ 30,74 60: R\$ 31,36



TINTOL 45 GRS ROSA 9 6X1

Código: Fábrika: Unidade:  
**12783** TUPY PT/6  
F1 F4

UN: R\$ 4,82 AV: R\$ 28,94 15: R\$ 29,55  
30: R\$ 30,14 45: R\$ 30,74 60: R\$ 31,36



TINTOL 45 GRS ROXO 19 6X1

Código: Fábrika: Unidade:  
**20005** TUPY PT/6  
F1 F4

UN: R\$ 499,19 AV: R\$ 499,19 15: R\$ 509,59  
30: R\$ 519,78 45: R\$ 530,18 60: R\$ 540,78



TINTOL 45 GRS SORT C/EXPOSITOR 102X1

Código: Fábrika: Unidade:  
**31368** TUPY EX/1  
F1 F4

UN: R\$ 4,82 AV: R\$ 28,94 15: R\$ 29,55  
30: R\$ 30,14 45: R\$ 30,74 60: R\$ 31,36



TINTOL 45 GRS VERDE PRIMAVERA 26 6X1

Código: Fábrika: Unidade:  
**20566** TUPY PT/6  
F1 F4

UN: R\$ 4,82 AV: R\$ 28,94 15: R\$ 29,55  
30: R\$ 30,14 45: R\$ 30,74 60: R\$ 31,36



TINTOL 45 GRS VERDE 28 6X1

Código: Fábrika: Unidade:  
**12774** TUPY PT/6  
F1 F4

UN: R\$ 4,82 AV: R\$ 28,94 15: R\$ 29,55  
30: R\$ 30,14 45: R\$ 30,74 60: R\$ 31,36



TINTOL 45 GRS VERMELHO 15 6X1

Código: Fábrika: Unidade:  
**12781** TUPY PT/6  
F1 F4

UN: R\$ 1,61 AV: R\$ 19,29 15: R\$ 19,69  
30: R\$ 20,08 45: R\$ 20,49 60: R\$ 20,90



TIRA CHINELO SLIM 25/26 SORT 12X1

Código: Fábrika: Unidade:  
**27529** BRASILEIRINH DZ/12  
F1 F4

UN: R\$ 1,61 AV: R\$ 16,07 15: R\$ 16,41  
30: R\$ 16,74 45: R\$ 17,07 60: R\$ 17,41



TIRA CHINELO SLIM 29/30 SORT 10X1

Código: Fábrika: Unidade:  
**31348** BRASILEIRINH PT/10  
F1 F4

UN: R\$ 1,61 AV: R\$ 16,07 15: R\$ 16,41  
30: R\$ 16,74 45: R\$ 17,07 60: R\$ 17,41

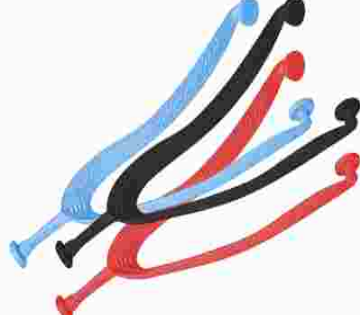

TIRA CHINELO SLIM 31/32 SORT 10X1

Código: Fábrika: Unidade:  
**31846** BRASILEIRINH PT/10  
F1 F4

UN: R\$ 1,61 AV: R\$ 16,07 15: R\$ 16,41  
30: R\$ 16,74 45: R\$ 17,07 60: R\$ 17,41



TIRA CHINELO SLIM 33/34 PRETO 10X1

Código: Fábrika: Unidade:  
**39821** BRASILEIRINH PT/10  
F1 F4

UN: R\$ 1,61 AV: R\$ 16,07 15: R\$ 16,41  
30: R\$ 16,74 45: R\$ 17,07 60: R\$ 17,41

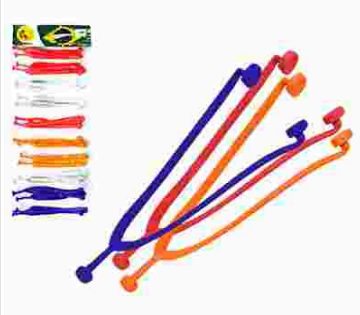

TIRA CHINELO SLIM 33/34 SORT 10X1

Código: Fábrika: Unidade:  
**28158** BRASILEIRINH PT/10  
F1 F4

UN: R\$ 1,61 AV: R\$ 16,07 15: R\$ 16,41  
30: R\$ 16,74 45: R\$ 17,07 60: R\$ 17,41



TIRA CHINELO SLIM 35/36 DOURADO 10X1

Código: 25197 Fábrica: BRASILEIRINH Unidade: PT/10 F1 F4

UN: R\$ 1,61 AV: R\$ 16,07 15: R\$ 16,41  
30: R\$ 16,74 45: R\$ 17,07 60: R\$ 17,41



TIRA CHINELO SLIM 35/36 PRETO 10X1

Código: 25167 Fábrica: BRASILEIRINH Unidade: PT/10 F1 F4

UN: R\$ 1,61 AV: R\$ 19,29 15: R\$ 19,69  
30: R\$ 20,08 45: R\$ 20,49 60: R\$ 20,90



TIRA CHINELO TRAD 25/26 LILAS 12X1

Código: 27485 Fábrica: BRASILEIRINH Unidade: DZ/12 F1 F4

UN: R\$ 1,61 AV: R\$ 16,07 15: R\$ 16,41  
30: R\$ 16,74 45: R\$ 17,07 60: R\$ 17,41

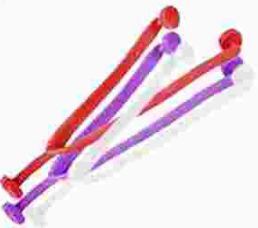

TIRA CHINELO TRAD 25/26 SORT 10X1

Código: 31400 Fábrica: BRASILEIRINH Unidade: PT/10 F1 F4

UN: R\$ 1,93 AV: R\$ 19,29 15: R\$ 19,69  
30: R\$ 20,08 45: R\$ 20,49 60: R\$ 20,90



TIRA CHINELO TRAD 27/28 SORT 10X1

Código: 27490 Fábrica: BRASILEIRINH Unidade: PT/10 F1 F4

UN: R\$ 1,61 AV: R\$ 16,07 15: R\$ 16,41  
30: R\$ 16,74 45: R\$ 17,07 60: R\$ 17,41



TIRA CHINELO TRAD 29/30 SORT 10X1

Código: 28169 Fábrica: BRASILEIRINH Unidade: PT/10 F1 F4

UN: R\$ 1,61 AV: R\$ 16,07 15: R\$ 16,41  
30: R\$ 16,74 45: R\$ 17,07 60: R\$ 17,41



TIRA CHINELO TRAD 33/34 AZUL 10X1

Código: 24966 Fábrica: BRASILEIRINH Unidade: PT/10 F1 F4

UN: R\$ 1,61 AV: R\$ 16,07 15: R\$ 16,41  
30: R\$ 16,74 45: R\$ 17,07 60: R\$ 17,41

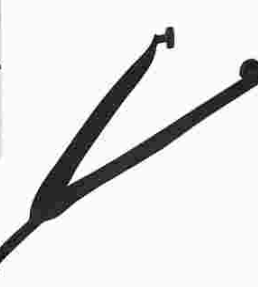

TIRA CHINELO TRAD 33/34 PRETO 10X1

Código: 25074 Fábrica: BRASILEIRINH Unidade: PT/10 F1 F4

UN: R\$ 1,61 AV: R\$ 16,07 15: R\$ 16,41  
30: R\$ 16,74 45: R\$ 17,07 60: R\$ 17,41

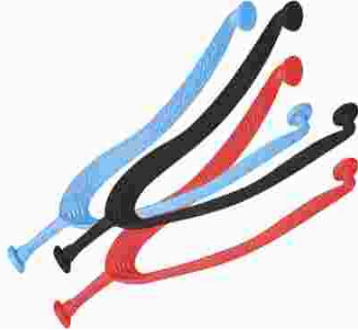

TIRA CHINELO TRAD 33/34 SORT 10X1

Código: 28171 Fábrica: BRASILEIRINH Unidade: PT/10 F1 F4

UN: R\$ 1,61 AV: R\$ 16,07 15: R\$ 16,41  
30: R\$ 16,74 45: R\$ 17,07 60: R\$ 17,41

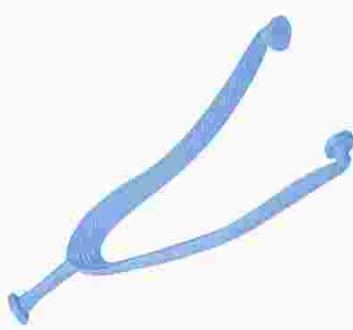

TIRA CHINELO TRAD 35/36 AZUL 10X1

Código: 25145 Fábrica: BRASILEIRINH Unidade: PT/10 F1 F4

UN: R\$ 2,07 AV: R\$ 20,72 15: R\$ 21,15  
30: R\$ 21,57 45: R\$ 22,00 60: R\$ 22,44



TIRA CHINELO TRAD 35/36 BRANCO 10X1

Código: 25102 Fábrica: BRASILEIRINH Unidade: PT/10 F1 F4

UN: R\$ 1,61 AV: R\$ 16,07 15: R\$ 16,41  
30: R\$ 16,74 45: R\$ 17,07 60: R\$ 17,41



TIRA CHINELO TRAD 35/36 PRETO 10X1

Código: 25025 Fábrica: BRASILEIRINH Unidade: PT/10 F1 F4

UN: R\$ 1,61 AV: R\$ 16,07 15: R\$ 16,41  
30: R\$ 16,74 45: R\$ 17,07 60: R\$ 17,41



TIRA CHINELO TRAD 37/38 PRETO 10X1

Código: 25026 Fábrica: BRASILEIRINH Unidade: PT/10 F1 F4

UN: R\$ 1,61 AV: R\$ 16,07 15: R\$ 16,41  
30: R\$ 16,74 45: R\$ 17,07 60: R\$ 17,41

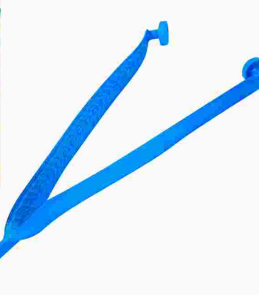

TIRA CHINELO TRAD 39/40 AZUL 10X1

Código: 30670 Fábrica: BRASILEIRINH Unidade: PT/10 F1 F4

UN: R\$ 1,61 AV: R\$ 16,07 15: R\$ 16,41  
30: R\$ 16,74 45: R\$ 17,07 60: R\$ 17,41



TIRA CHINELO TRAD 39/40 PRETO 10X1

Código: 25084 Fábrica: BRASILEIRINH Unidade: PT/10 F1 F4

UN: R\$ 1,61 AV: R\$ 16,07 15: R\$ 16,41  
30: R\$ 16,74 45: R\$ 17,07 60: R\$ 17,41



TIRA CHINELO TRAD 41/42 AZUL 10X1

Código: 25058 Fábrica: BRASILEIRINH Unidade: PT/10 F1 F4

UN: R\$ 1,61 AV: R\$ 16,07 15: R\$ 16,41  
30: R\$ 16,74 45: R\$ 17,07 60: R\$ 17,41



TIRA CHINELO TRAD 41/42 PRETO 10X1  
Código: 34988 Fábrica: BRASILEIRINH Unidade: PT/10  
F1 F4

UN: R\$ 1,61 AV: R\$ 16,07 15: R\$ 16,41  
30: R\$ 16,74 45: R\$ 17,07 60: R\$ 17,41

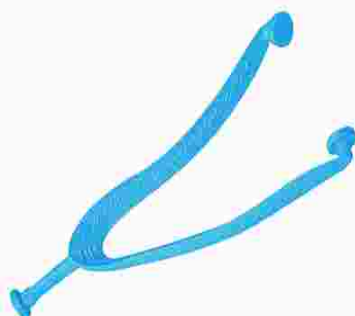

TIRA CHINELO TRAD 43/44 AZUL 10X1  
Código: 28092 Fábrica: BRASILEIRINH Unidade: PT/10  
F1 F4

UN: R\$ 1,61 AV: R\$ 16,07 15: R\$ 16,41  
30: R\$ 16,74 45: R\$ 17,07 60: R\$ 17,41



TIRA CHINELO TRAD 43/44 PRETO 10X1  
Código: 30640 Fábrica: BRASILEIRINH Unidade: PT/10  
F1 F4

UN: R\$ 2,99 AV: R\$ 29,94 15: R\$ 30,57  
30: R\$ 31,18 45: R\$ 31,80 60: R\$ 32,44



TOMADA EXTERNA 10X1  
Código: 36947 Fábrica: AMOF Unidade: PT/10  
F1 F4

UN: R\$ 3,49 AV: R\$ 34,93 15: R\$ 35,66  
30: R\$ 36,38 45: R\$ 37,10 60: R\$ 37,84



TOMADA PINO FEMEA 10A 2PIN EF08 10X1  
Código: 36948 Fábrica: GIROFLASH Unidade: PT/10  
F1 F4

UN: R\$ 7,36 AV: R\$ 73,63 15: R\$ 75,17  
30: R\$ 76,67 45: R\$ 78,20 60: R\$ 79,77



TOMADA QUADRUPLA GF12 10X1  
Código: 39386 Fábrica: GIROFLASH Unidade: PT/10  
F1 F4

UN: R\$ 12,99 AV: R\$ 12,99 15: R\$ 12,99  
30: R\$ 12,99 45: R\$ 12,99 60: R\$ 12,99



TOUCA AD LISA PRETA MZ5100AQ  
Código: 44565 Fábrica: DOTAD Unidade: UN/1  
F1 F4

UN: R\$ 9,99 AV: R\$ 9,99 15: R\$ 9,99  
30: R\$ 9,99 45: R\$ 9,99 60: R\$ 9,99



TOUCA AD LISA PRETA MZ5150  
Código: 44564 Fábrica: DOTAD Unidade: UN/1  
F1 F4

UN: R\$ 17,47 AV: R\$ 17,47 15: R\$ 17,84  
30: R\$ 18,19 45: R\$ 18,56 60: R\$ 18,93



TOUCA AD SPORTS FORRO DUPLO MZ5107G-1  
Código: 44563 Fábrica: DOTAD Unidade: UN/1  
F1 F4

UN: R\$ 14,99 AV: R\$ 14,99 15: R\$ 14,99  
30: R\$ 14,99 45: R\$ 14,99 60: R\$ 14,99



TOUCA INVERNO LISTRADO SPORTS MZ5109CD  
Código: 44461 Fábrica: DOTAD Unidade: UN/1  
F1 F4

UN: R\$ 16,96 AV: R\$ 16,96 15: R\$ 17,32  
30: R\$ 17,66 45: R\$ 18,02 60: R\$ 18,38



TOUCA LA AD LISA C/DOBRA 2139  
Código: 14151 Fábrica: GLX Unidade: UN/1  
F1 F4

UN: R\$ 22,95 AV: R\$ 22,95 15: R\$ 23,43  
30: R\$ 23,90 45: R\$ 24,38 60: R\$ 24,87



TOUCA LA AD LISTRADA GROSSA S/DOBRA 2170  
Código: 14150 Fábrica: GLX Unidade: UN/1  
F1 F4

UN: R\$ 20,96 AV: R\$ 20,96 15: R\$ 21,39  
30: R\$ 21,82 45: R\$ 22,26 60: R\$ 22,70



TOUCA LA AD MOLETON SILKADA 2117  
Código: 42221 Fábrica: PITYY Unidade: UN/1  
F1 F4

UN: R\$ 15,99 AV: R\$ 15,99 15: R\$ 15,99  
30: R\$ 15,99 45: R\$ 15,99 60: R\$ 15,99



TOUCA LA AD S/DOBRA 2134M  
Código: 36824 Fábrica: GLX Unidade: UN/1  
F1 F4

UN: R\$ 6,75 AV: R\$ 6,75 15: R\$ 6,75  
30: R\$ 6,75 45: R\$ 6,75 60: R\$ 6,75



TOUCA LA AD TRAD FEM (GORRO) 3195  
Código: 41819 Fábrica: GLX Unidade: UN/1  
F1 F4

UN: R\$ 6,75 AV: R\$ 6,75 15: R\$ 6,75  
30: R\$ 6,75 45: R\$ 6,75 60: R\$ 6,75



TOUCA LA AD TRAD FEM (GORRO) 3197  
Código: 41820 Fábrica: GLX Unidade: UN/1  
F1 F4

UN: R\$ 23,95 AV: R\$ 23,95 15: R\$ 24,45  
30: R\$ 24,94 45: R\$ 25,44 60: R\$ 25,95



TOUCA LA INF F.DUPL0 BICHIN C/OLHOS 109  
Código: Fábrika: Unidade:  
**18059** LURS UN/1  
F1 F4

UN: R\$ 27,99 AV: R\$ 27,99 15: R\$ 27,99  
30: R\$ 27,99 45: R\$ 27,99 60: R\$ 27,99



TOUCA LA INF F.DUPL0 C/POMPOM 0867  
Código: Fábrika: Unidade:  
**17657** LURS UN/1  
F1 F4

UN: R\$ 9,98 AV: R\$ 9,98 15: R\$ 10,19  
30: R\$ 10,40 45: R\$ 10,60 60: R\$ 10,82



TOUCA LA INFANTIL 6106  
Código: Fábrika: Unidade:  
**36829** GLX UN/1  
F1 F4

UN: R\$ 16,96 AV: R\$ 16,96 15: R\$ 17,32  
30: R\$ 17,66 45: R\$ 18,02 60: R\$ 18,38



TOUCA NINJA MOTOQUEIRO  
Código: Fábrika: Unidade:  
**27124** DOTAD UN/1  
F1 F4

UN: R\$ 20,67 AV: R\$ 20,67 15: R\$ 21,10  
30: R\$ 21,52 45: R\$ 21,95 60: R\$ 22,39



TRAVA ANTI FURTO P/BIKE 5009  
Código: Fábrika: Unidade:  
**40349** RED STAR UN/1  
F1 F4

UN: R\$ 42,92 AV: R\$ 42,92 15: R\$ 43,82  
30: R\$ 44,69 45: R\$ 45,59 60: R\$ 46,50



TUBO LATEX (GARROTE) 200 15 MTS  
Código: Fábrika: Unidade:  
**825** UMUARAMA PT/1  
F1 F4

UN: R\$ 64,89 AV: R\$ 64,89 15: R\$ 66,24  
30: R\$ 67,56 45: R\$ 68,91 60: R\$ 70,29



TUBO LATEX (GARROTE) 201 15 MTS  
Código: Fábrika: Unidade:  
**824** UMUARAMA PT/1  
F1 F4

UN: R\$ 84,85 AV: R\$ 84,85 15: R\$ 86,62  
30: R\$ 88,35 45: R\$ 90,12 60: R\$ 91,92



TUBO LATEX (GARROTE) 203 15 MTS  
Código: Fábrika: Unidade:  
**369** UMUARAMA PT/1  
F1 F4

UN: R\$ 59,89 AV: R\$ 59,89 15: R\$ 61,14  
30: R\$ 62,36 45: R\$ 63,61 60: R\$ 64,88  
110 cm

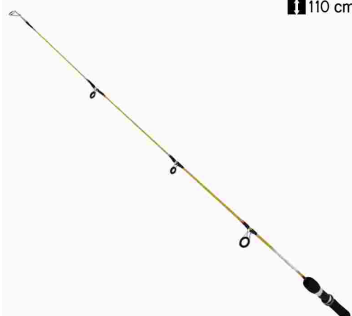

VARA PESCA 1,10 MTS  
Código: Fábrika: Unidade:  
**4884** WMF UN/1  
F4

UN: R\$ 52,91 AV: R\$ 52,91 15: R\$ 54,01  
30: R\$ 55,09 45: R\$ 56,19 60: R\$ 57,31



VARA PESCA 1,20 MTS  
Código: Fábrika: Unidade:  
**30024** TAUE UN/1  
F4

UN: R\$ 78,37 AV: R\$ 78,37 15: R\$ 80,01  
30: R\$ 81,61 45: R\$ 83,24 60: R\$ 84,90



VARA PESCA 1,60 M TAUE  
Código: Fábrika: Unidade:  
**27772** TAUE UN/1  
F4

UN: R\$ 86,26 AV: R\$ 86,26 15: R\$ 88,06  
30: R\$ 89,82 45: R\$ 91,62 60: R\$ 93,45



VARA PESCA 1,65 MTS  
Código: Fábrika: Unidade:  
**27098** SOL UN/1  
F4

UN: R\$ 0,36 AV: R\$ 1,78 15: R\$ 1,81  
30: R\$ 1,85 45: R\$ 1,89 60: R\$ 1,93



VEDANTE 1/2 PLAST (BUCHA TORNEIRA) 5X1  
Código: Fábrika: Unidade:  
**49740** NOVA ERA PT/5  
F1 F4

UN: R\$ 0,36 AV: R\$ 1,78 15: R\$ 1,81  
30: R\$ 1,85 45: R\$ 1,89 60: R\$ 1,93



VEDANTE 3/4 PLAST (BUCHA TORNEIRA) 5X1  
Código: Fábrika: Unidade:  
**49741** NOVA MARCA PT/5  
F1 F4

UN: R\$ 0,40 AV: R\$ 79,86 15: R\$ 81,53  
30: R\$ 83,16 45: R\$ 84,82 60: R\$ 86,52



VEDANTE 3/4 SILIC (BUCHA TORNEIRA) 200X1  
Código: Fábrika: Unidade:  
**32894** UNO PLASTIC PT/200  
F1 F4

UN: R\$ 0,90 AV: R\$ 4,48 15: R\$ 4,58  
30: R\$ 4,67 45: R\$ 4,76 60: R\$ 4,86

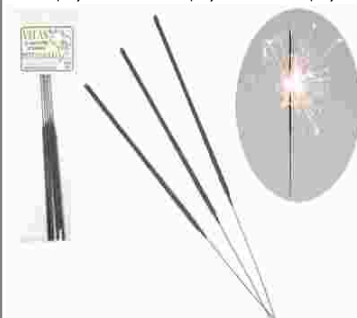

VELA ANIV MAGICA ESTRELA 5X1  
Código: Fábrika: Unidade:  
**19366** BRASILEIRINH PT/5  
F1 F4

UN: R\$ 2,62 AV: R\$ 26,21 15: R\$ 26,75  
30: R\$ 27,29 45: R\$ 27,83 60: R\$ 28,39



VELA ANIV MED C/GLITER 7 AZUL 10X1

Código: 28026 Fábrica: BRASILEIRINH Unidade: PT/10 F1 F4

UN: R\$ 2,62 AV: R\$ 26,21 15: R\$ 26,75  
30: R\$ 27,29 45: R\$ 27,83 60: R\$ 28,39



VELA ANIV MED C/GLITER 7 BCA 10X1

Código: 28027 Fábrica: BRASILEIRINH Unidade: PT/10 F1 F4

UN: R\$ 2,62 AV: R\$ 26,21 15: R\$ 26,75  
30: R\$ 27,29 45: R\$ 27,83 60: R\$ 28,39



VELA ANIV MED C/GLITER 7 ROSA 10X1

Código: 28028 Fábrica: BRASILEIRINH Unidade: PT/10 F1 F4

UN: R\$ 2,36 AV: R\$ 389,37 15: R\$ 397,48  
30: R\$ 405,43 45: R\$ 413,54 60: R\$ 421,81

Altura: 06 cm



VELA ANIV MED C/GLITER KIT 165 C/EXPOSIT

Código: 27649 Fábrica: BRASILEIRINH Unidade: KT/165 F1 F4

UN: R\$ 2,62 AV: R\$ 26,21 15: R\$ 26,75  
30: R\$ 27,29 45: R\$ 27,83 60: R\$ 28,39



VELA ANIV MED C/GLITER 0 AZUL 10X1

Código: 27982 Fábrica: BRASILEIRINH Unidade: PT/10 F1 F4

UN: R\$ 2,62 AV: R\$ 26,21 15: R\$ 26,75  
30: R\$ 27,29 45: R\$ 27,83 60: R\$ 28,39



VELA ANIV MED C/GLITER 0 BCA 10X1

Código: 27992 Fábrica: BRASILEIRINH Unidade: PT/10 F1 F4

UN: R\$ 2,62 AV: R\$ 26,21 15: R\$ 26,75  
30: R\$ 27,29 45: R\$ 27,83 60: R\$ 28,39



VELA ANIV MED C/GLITER 0 ROSA 10X1

Código: 28002 Fábrica: BRASILEIRINH Unidade: PT/10 F1 F4

UN: R\$ 2,62 AV: R\$ 26,21 15: R\$ 26,75  
30: R\$ 27,29 45: R\$ 27,83 60: R\$ 28,39



VELA ANIV MED C/GLITER 1 AZUL 10X1

Código: 27983 Fábrica: BRASILEIRINH Unidade: PT/10 F1 F4

UN: R\$ 2,62 AV: R\$ 26,21 15: R\$ 26,75  
30: R\$ 27,29 45: R\$ 27,83 60: R\$ 28,39



VELA ANIV MED C/GLITER 1 BCA 10X1

Código: 27993 Fábrica: BRASILEIRINH Unidade: PT/10 F1 F4

UN: R\$ 2,62 AV: R\$ 26,21 15: R\$ 26,75  
30: R\$ 27,29 45: R\$ 27,83 60: R\$ 28,39



VELA ANIV MED C/GLITER 1 ROSA 10X1

Código: 28003 Fábrica: BRASILEIRINH Unidade: PT/10 F1 F4

UN: R\$ 2,62 AV: R\$ 26,21 15: R\$ 26,75  
30: R\$ 27,29 45: R\$ 27,83 60: R\$ 28,39



VELA ANIV MED C/GLITER 2 AZUL 10X1

Código: 27984 Fábrica: BRASILEIRINH Unidade: PT/10 F1 F4

UN: R\$ 2,62 AV: R\$ 26,21 15: R\$ 26,75  
30: R\$ 27,29 45: R\$ 27,83 60: R\$ 28,39



VELA ANIV MED C/GLITER 2 BCA 10X1

Código: 27994 Fábrica: BRASILEIRINH Unidade: PT/10 F1 F4

UN: R\$ 2,62 AV: R\$ 26,21 15: R\$ 26,75  
30: R\$ 27,29 45: R\$ 27,83 60: R\$ 28,39



VELA ANIV MED C/GLITER 2 ROSA 10X1

Código: 28004 Fábrica: BRASILEIRINH Unidade: PT/10 F1 F4

UN: R\$ 2,62 AV: R\$ 26,21 15: R\$ 26,75  
30: R\$ 27,29 45: R\$ 27,83 60: R\$ 28,39



VELA ANIV MED C/GLITER 3 AZUL 10X1

Código: 27985 Fábrica: BRASILEIRINH Unidade: PT/10 F1 F4

UN: R\$ 2,62 AV: R\$ 26,21 15: R\$ 26,75  
30: R\$ 27,29 45: R\$ 27,83 60: R\$ 28,39



VELA ANIV MED C/GLITER 3 BCA 10X1

Código: 27995 Fábrica: BRASILEIRINH Unidade: PT/10 F1 F4

UN: R\$ 2,62 AV: R\$ 26,21 15: R\$ 26,75  
30: R\$ 27,29 45: R\$ 27,83 60: R\$ 28,39



VELA ANIV MED C/GLITER 3 ROSA 10X1

Código: 28005 Fábrica: BRASILEIRINH Unidade: PT/10 F1 F4

UN: R\$ 2,62 AV: R\$ 26,21 15: R\$ 26,75  
30: R\$ 27,29 45: R\$ 27,83 60: R\$ 28,39



VELA ANIV MED C/GLITER 4 AZUL 10X1

Código: 27986 Fábrica: BRASILEIRINH Unidade: PT/10 F1 F4

UN: R\$ 2,62 AV: R\$ 26,21 15: R\$ 26,75  
30: R\$ 27,29 45: R\$ 27,83 60: R\$ 28,39



VELA ANIV MED C/GLITER 4 BCA 10X1

Código: 27996 Fábrica: BRASILEIRINH Unidade: PT/10 F1 F4

UN: R\$ 2,62 AV: R\$ 26,21 15: R\$ 26,75  
30: R\$ 27,29 45: R\$ 27,83 60: R\$ 28,39



VELA ANIV MED C/GLITER 4 ROSA 10X1

Código: 28006 Fábrica: BRASILEIRINH Unidade: PT/10 F1 F4

UN: R\$ 2,62 AV: R\$ 26,21 15: R\$ 26,75  
30: R\$ 27,29 45: R\$ 27,83 60: R\$ 28,39



VELA ANIV MED C/GLITER 5 AZUL 10X1

Código: 27987 Fábrica: BRASILEIRINH Unidade: PT/10 F1 F4

UN: R\$ 2,62 AV: R\$ 26,21 15: R\$ 26,75  
30: R\$ 27,29 45: R\$ 27,83 60: R\$ 28,39



VELA ANIV MED C/GLITER 5 BCA 10X1

Código: 27997 Fábrica: BRASILEIRINH Unidade: PT/10 F1 F4

UN: R\$ 2,62 AV: R\$ 26,21 15: R\$ 26,75  
30: R\$ 27,29 45: R\$ 27,83 60: R\$ 28,39



VELA ANIV MED C/GLITER 5 ROSA 10X1

Código: 28007 Fábrica: BRASILEIRINH Unidade: PT/10 F1 F4

UN: R\$ 2,62 AV: R\$ 26,21 15: R\$ 26,75  
30: R\$ 27,29 45: R\$ 27,83 60: R\$ 28,39



VELA ANIV MED C/GLITER 6 AZUL 10X1

Código: 27988 Fábrica: BRASILEIRINH Unidade: PT/10 F1 F4

UN: R\$ 2,62 AV: R\$ 26,21 15: R\$ 26,75  
30: R\$ 27,29 45: R\$ 27,83 60: R\$ 28,39



VELA ANIV MED C/GLITER 6 BCA 10X1

Código: 27998 Fábrica: BRASILEIRINH Unidade: PT/10 F1 F4

UN: R\$ 2,62 AV: R\$ 26,21 15: R\$ 26,75  
30: R\$ 27,29 45: R\$ 27,83 60: R\$ 28,39



VELA ANIV MED C/GLITER 6 ROSA 10X1

Código: 28008 Fábrica: BRASILEIRINH Unidade: PT/10 F1 F4

UN: R\$ 2,62 AV: R\$ 26,21 15: R\$ 26,75  
30: R\$ 27,29 45: R\$ 27,83 60: R\$ 28,39



VELA ANIV MED C/GLITER 7 AZUL 10X1

Código: 27989 Fábrica: BRASILEIRINH Unidade: PT/10 F1 F4

UN: R\$ 2,62 AV: R\$ 26,21 15: R\$ 26,75  
30: R\$ 27,29 45: R\$ 27,83 60: R\$ 28,39



VELA ANIV MED C/GLITER 7 BCA 10X1

Código: 27999 Fábrica: BRASILEIRINH Unidade: PT/10 F1 F4

UN: R\$ 2,62 AV: R\$ 26,21 15: R\$ 26,75  
30: R\$ 27,29 45: R\$ 27,83 60: R\$ 28,39



VELA ANIV MED C/GLITER 7 ROSA 10X1

Código: 28009 Fábrica: BRASILEIRINH Unidade: PT/10 F1 F4

UN: R\$ 2,62 AV: R\$ 26,21 15: R\$ 26,75  
30: R\$ 27,29 45: R\$ 27,83 60: R\$ 28,39



VELA ANIV MED C/GLITER 8 AZUL 10X1

Código: 27990 Fábrica: BRASILEIRINH Unidade: PT/10 F1 F4

UN: R\$ 2,62 AV: R\$ 26,21 15: R\$ 26,75  
30: R\$ 27,29 45: R\$ 27,83 60: R\$ 28,39



VELA ANIV MED C/GLITER 8 BCA 10X1

Código: 28000 Fábrica: BRASILEIRINH Unidade: PT/10 F1 F4

UN: R\$ 2,62 AV: R\$ 26,21 15: R\$ 26,75  
30: R\$ 27,29 45: R\$ 27,83 60: R\$ 28,39



VELA ANIV MED C/GLITER 8 ROSA 10X1

Código: 28010 Fábrica: BRASILEIRINH Unidade: PT/10 F1 F4

UN: R\$ 2,62 AV: R\$ 26,21 15: R\$ 26,75  
30: R\$ 27,29 45: R\$ 27,83 60: R\$ 28,39



VELA ANIV MED C/GLITER 9 AZUL 10X1

Código: 27991 Fábrica: BRASILEIRINH Unidade: PT/10 F1 F4

UN: R\$ 2,62 AV: R\$ 26,21 15: R\$ 26,75  
30: R\$ 27,29 45: R\$ 27,83 60: R\$ 28,39



VELA ANIV MED C/GLITER 9 BCA 10X1

Código: Fábrika: Unidade:  
**28001** BRASILEIRINH PT/10  
F1 F4

UN: R\$ 2,62 AV: R\$ 26,21 15: R\$ 26,75  
30: R\$ 27,29 45: R\$ 27,83 60: R\$ 28,39



VELA ANIV MED C/GLITER 9 ROSA 10X1

Código: Fábrika: Unidade:  
**28011** BRASILEIRINH PT/10  
F1 F4

UN: R\$ 6,48 AV: R\$ 6,48 15: R\$ 6,61  
30: R\$ 6,75 45: R\$ 6,88 60: R\$ 7,02



VELA FONTE LUMINOSA (VULCAO)

Código: Fábrika: Unidade:  
**27606** BRASILEIRINH PT/1  
F1 F4

UN: R\$ 12,06 AV: R\$ 144,76 15: R\$ 147,77  
30: R\$ 150,73 45: R\$ 153,74 60: R\$ 156,82



VELA P/FILTRO CRISTAL C/CARVAO ATIV 12X1

Código: Fábrika: Unidade:  
**26517** MINERAL DZ/12  
F1 F4

UN: R\$ 9,15 AV: R\$ 109,81 15: R\$ 112,10  
30: R\$ 114,34 45: R\$ 116,63 60: R\$ 118,96



VELA P/FILTRO CRISTAL 69 12X1

Código: Fábrika: Unidade:  
**8044** MINERAL DZ/12  
F1 F4

UN: R\$ 9,97 AV: R\$ 9,97 15: R\$ 10,18  
30: R\$ 10,39 45: R\$ 10,59 60: R\$ 10,81



VELA P/FILTRO UN

Código: Fábrika: Unidade:  
**49393** MINERAL UN/1  
F1 F4

UN: R\$ 8,49 AV: R\$ 8,49 15: R\$ 8,66  
30: R\$ 8,84 45: R\$ 9,01 60: R\$ 9,19



VENTILADOR MINI USB 14 CM 98

Código: Fábrika: Unidade:  
**37045** INOVA UN/1  
F1 F4

UN: R\$ 219,64 AV: R\$ 219,64 15: R\$ 224,21  
30: R\$ 228,70 45: R\$ 233,27 60: R\$ 237,94



VENTILADOR PEDESTAL 127V C/LUZ 3001A

Código: Fábrika: Unidade:  
**30661** FUTURO CX/1  
F1 F4