

UN: R\$ 2,05 AV: R\$ 20,53 15: R\$ 20,96
30: R\$ 21,38 45: R\$ 21,81 60: R\$ 22,24



ADESIVO GDE MORANGUINHO 10X1

Código: Fábrika: Unidade:
46744 STICKERS PT/10
F1 F4

UN: R\$ 2,05 AV: R\$ 20,53 15: R\$ 20,96
30: R\$ 21,38 45: R\$ 21,81 60: R\$ 22,24



ADESIVO GDE RELEVO BEN 10 10X1

Código: Fábrika: Unidade:
37278 STICKERS PT/10
F1 F4

UN: R\$ 2,05 AV: R\$ 20,53 15: R\$ 20,96
30: R\$ 21,38 45: R\$ 21,81 60: R\$ 22,24



ADESIVO GDE RELEVO BETTY BOOP 10X1

Código: Fábrika: Unidade:
37274 STICKERS PT/10
F1 F4

UN: R\$ 2,05 AV: R\$ 20,53 15: R\$ 20,96
30: R\$ 21,38 45: R\$ 21,81 60: R\$ 22,24



ADESIVO GDE RELEVO GATA MARIE 10X1

Código: Fábrika: Unidade:
37272 STICKERS PT/10
F1 F4

UN: R\$ 2,05 AV: R\$ 20,53 15: R\$ 20,96
30: R\$ 21,38 45: R\$ 21,81 60: R\$ 22,24



ADESIVO GDE RELEVO HELLO KITTY 10X1

Código: Fábrika: Unidade:
37275 STICKERS PT/10
F1 F4

UN: R\$ 2,05 AV: R\$ 20,53 15: R\$ 20,96
30: R\$ 21,38 45: R\$ 21,81 60: R\$ 22,24



ADESIVO GDE RELEVO JOLIE 10X1

Código: Fábrika: Unidade:
37281 STICKERS PT/10
F1 F4

UN: R\$ 2,05 AV: R\$ 20,53 15: R\$ 20,96
30: R\$ 21,38 45: R\$ 21,81 60: R\$ 22,24



ADESIVO GDE RELEVO MORANGUINHO 10X1

Código: Fábrika: Unidade:
37273 STICKERS PT/10
F1 F4

UN: R\$ 2,05 AV: R\$ 20,53 15: R\$ 20,96
30: R\$ 21,38 45: R\$ 21,81 60: R\$ 22,24



ADESIVO GDE RELEVO PALMEIRAS 10X1

Código: Fábrika: Unidade:
44252 STICKERS PT/10
F1 F4

UN: R\$ 2,05 AV: R\$ 20,53 15: R\$ 20,96
30: R\$ 21,38 45: R\$ 21,81 60: R\$ 22,24



ADESIVO GDE RELEVO PUCCA 10X1

Código: Fábrika: Unidade:
37277 STICKERS PT/10
F1 F4

UN: R\$ 2,05 AV: R\$ 20,53 15: R\$ 20,96
30: R\$ 21,38 45: R\$ 21,81 60: R\$ 22,24



ADESIVO GDE RELEVO SAO PAULO 10X1

Código: Fábrika: Unidade:
37279 STICKERS PT/10
F1 F4

UN: R\$ 2,05 AV: R\$ 20,53 15: R\$ 20,96
30: R\$ 21,38 45: R\$ 21,81 60: R\$ 22,24



ADESIVO GDE RELEVO SORTIDO 10X1

Código: Fábrika: Unidade:
40709 STICKERS PT/10
F1 F4

UN: R\$ 2,05 AV: R\$ 20,53 15: R\$ 20,96
30: R\$ 21,38 45: R\$ 21,81 60: R\$ 22,24



ADESIVO GDE RELEVO VASCO 10X1

Código: Fábrika: Unidade:
37280 STICKERS PT/10
F1 F4

UN: R\$ 3,08 AV: R\$ 30,81 15: R\$ 31,45
30: R\$ 32,08 45: R\$ 32,72 60: R\$ 33,37



ADESIVO GIGANTE BARBIE 10X1

Código: Fábrika: Unidade:
37851 STICKERS PT/10
F1 F4

UN: R\$ 1,71 AV: R\$ 20,53 15: R\$ 20,96
30: R\$ 21,38 45: R\$ 21,81 60: R\$ 22,24



ADESIVO GRANDE BORBOLETAS 12X1

Código: Fábrika: Unidade:
36429 STICKERS DZ/12
F4

UN: R\$ 1,71 AV: R\$ 20,53 15: R\$ 20,96
30: R\$ 21,38 45: R\$ 21,81 60: R\$ 22,24



ADESIVO GRANDE HELLO KITTY 12X1

Código: Fábrika: Unidade:
37266 STICKERS DZ/12
F1 F4

UN: R\$ 1,71 AV: R\$ 20,53 15: R\$ 20,96
30: R\$ 21,38 45: R\$ 21,81 60: R\$ 22,24



ADESIVO GRANDE NUMEROS 12X1

Código: Fábrika: Unidade:
29715 STICKERS DZ/12
F1 F4

UN: R\$ 1,71 AV: R\$ 20,53 15: R\$ 20,96
30: R\$ 21,38 45: R\$ 21,81 60: R\$ 22,24



ADESIVO GRANDE PIU PIU 12X1

Código: Fábrika: Unidade:
20769 STICKERS DZ/12
F4

UN: R\$ 1,71 AV: R\$ 20,53 15: R\$ 20,96
30: R\$ 21,38 45: R\$ 21,81 60: R\$ 22,24



ADESIVO GRANDE SMURFS 12X1

Código: Fábrika: Unidade:
37267 STICKERS DZ/12
F1 F4

UN: R\$ 1,71 AV: R\$ 20,53 15: R\$ 20,96
30: R\$ 21,38 45: R\$ 21,81 60: R\$ 22,24



ADESIVO GRANDE SNOOPY 12X1

Código: Fábrika: Unidade:
18179 STICKERS DZ/12
F1 F4

UN: R\$ 1,71 AV: R\$ 20,53 15: R\$ 20,96
30: R\$ 21,38 45: R\$ 21,81 60: R\$ 22,24



ADESIVO GRANDE SORTIDO 12X1

Código: Fábrika: Unidade:
20606 STICKERS DZ/12
F1 F4

UN: R\$ 1,71 AV: R\$ 20,53 15: R\$ 20,96
30: R\$ 21,38 45: R\$ 21,81 60: R\$ 22,24



ADESIVO GRANDE SUPER PODEROSAS 12X1

Código: Fábrika: Unidade:
37269 STICKERS DZ/12
F1 F4

UN: R\$ 1,71 AV: R\$ 20,53 15: R\$ 20,96
30: R\$ 21,38 45: R\$ 21,81 60: R\$ 22,24



ADESIVO GRANDE TURMA DA MONICA 12X1

Código: Fábrika: Unidade:
29664 STICKERS DZ/12
F1 F4

UN: R\$ 1,54 AV: R\$ 15,40 15: R\$ 15,72
30: R\$ 16,03 45: R\$ 16,35 60: R\$ 16,68



ADESIVO MED BRASIL 10X1

Código: Fábrika: Unidade:
51072 STICKERS PT/10
F1 F4

UN: R\$ 1,54 AV: R\$ 15,40 15: R\$ 15,72
30: R\$ 16,03 45: R\$ 16,35 60: R\$ 16,68



ADESIVO MED RELEVTO SORTIDO 10X1

Código: Fábrika: Unidade:
47212 STICKERS PT/10
F1 F4

UN: R\$ 0,34 AV: R\$ 4,10 15: R\$ 4,18
30: R\$ 4,27 45: R\$ 4,35 60: R\$ 4,44



ADESIVO P BAHIA 12X1

Código: Fábrika: Unidade:
22034 STICKERS DZ/12
F1 F4

UN: R\$ 0,34 AV: R\$ 4,10 15: R\$ 4,18
30: R\$ 4,27 45: R\$ 4,35 60: R\$ 4,44



ADESIVO P BARBIE 12X1

Código: Fábrika: Unidade:
22025 STICKERS DZ/12
F1 F4

UN: R\$ 0,34 AV: R\$ 4,10 15: R\$ 4,18
30: R\$ 4,27 45: R\$ 4,35 60: R\$ 4,44



ADESIVO P BARNEY E SEUS AMIGOS 12X1

Código: Fábrika: Unidade:
46737 STICKERS DZ/12
F1 F4

UN: R\$ 0,34 AV: R\$ 4,10 15: R\$ 4,18
30: R\$ 4,27 45: R\$ 4,35 60: R\$ 4,44



ADESIVO P BAT MAN 12X1

Código: Fábrika: Unidade:
25021 STICKERS DZ/12
F1 F4

UN: R\$ 0,34 AV: R\$ 4,10 15: R\$ 4,18
30: R\$ 4,27 45: R\$ 4,35 60: R\$ 4,44



ADESIVO P BORBOLETAS 12X1

Código: Fábrika: Unidade:
24028 STICKERS DZ/12
F1 F4

UN: R\$ 0,34 AV: R\$ 4,10 15: R\$ 4,18
30: R\$ 4,27 45: R\$ 4,35 60: R\$ 4,44



ADESIVO P CARROS 12X1

Código: Fábrika: Unidade:
18175 STICKERS DZ/12
F1 F4

UN: R\$ 0,34 AV: R\$ 4,10 15: R\$ 4,18
30: R\$ 4,27 45: R\$ 4,35 60: R\$ 4,44



ADESIVO P COCORICO 12X1

Código: Fábrika: Unidade:
25721 STICKERS DZ/12
F4

UN: R\$ 0,34 AV: R\$ 4,10 15: R\$ 4,18
30: R\$ 4,27 45: R\$ 4,35 60: R\$ 4,44



ADESIVO P CORACAO 12X1

Código: Fábrika: Unidade:
22028 STICKERS DZ/12
F1 F4

UN: R\$ 0,34 AV: R\$ 4,10 15: R\$ 4,18
30: R\$ 4,27 45: R\$ 4,35 60: R\$ 4,44



ADESIVO P CORINTHIANS 12X1
Código: Fábrica: Unidade:
51080 STICKERS DZ/12
F1 F4

UN: R\$ 0,34 AV: R\$ 4,10 15: R\$ 4,18
30: R\$ 4,27 45: R\$ 4,35 60: R\$ 4,44



ADESIVO P CORUJAS 12X1
Código: Fábrica: Unidade:
34866 STICKERS DZ/12
F1 F4

UN: R\$ 0,34 AV: R\$ 4,10 15: R\$ 4,18
30: R\$ 4,27 45: R\$ 4,35 60: R\$ 4,44



ADESIVO P CRUZEIRO 12X1
Código: Fábrica: Unidade:
24853 STICKERS DZ/12
F1 F4

UN: R\$ 0,34 AV: R\$ 4,10 15: R\$ 4,18
30: R\$ 4,27 45: R\$ 4,35 60: R\$ 4,44



ADESIVO P DINOSSAUROS 12X1
Código: Fábrica: Unidade:
50427 STICKERS DZ/12
F1 F4

UN: R\$ 0,34 AV: R\$ 4,10 15: R\$ 4,18
30: R\$ 4,27 45: R\$ 4,35 60: R\$ 4,44



ADESIVO P DRAGON BALL Z 12X1
Código: Fábrica: Unidade:
4536 STICKERS DZ/12
F1 F4

UN: R\$ 0,34 AV: R\$ 4,10 15: R\$ 4,18
30: R\$ 4,27 45: R\$ 4,35 60: R\$ 4,44



ADESIVO P ESTRELAS BRILHA NO ESCURO 12X1
Código: Fábrica: Unidade:
22030 STICKERS DZ/12
F4

UN: R\$ 0,34 AV: R\$ 4,10 15: R\$ 4,18
30: R\$ 4,27 45: R\$ 4,35 60: R\$ 4,44



ADESIVO P GARFIELD 12X1
Código: Fábrica: Unidade:
16431 STICKERS DZ/12
F1 F4

UN: R\$ 0,34 AV: R\$ 4,10 15: R\$ 4,18
30: R\$ 4,27 45: R\$ 4,35 60: R\$ 4,44



ADESIVO P GASPARZINHO 12X1
Código: Fábrica: Unidade:
51112 STICKERS DZ/12
F4

UN: R\$ 0,34 AV: R\$ 4,10 15: R\$ 4,18
30: R\$ 4,27 45: R\$ 4,35 60: R\$ 4,44



ADESIVO P HELLO KITT 12X1
Código: Fábrica: Unidade:
22036 STICKERS DZ/12
F1 F4

UN: R\$ 0,34 AV: R\$ 4,10 15: R\$ 4,18
30: R\$ 4,27 45: R\$ 4,35 60: R\$ 4,44



ADESIVO P LETRAS 12X1
Código: Fábrica: Unidade:
7354 STICKERS DZ/12
F1 F4

UN: R\$ 0,34 AV: R\$ 4,10 15: R\$ 4,18
30: R\$ 4,27 45: R\$ 4,35 60: R\$ 4,44



ADESIVO P NARUTO 12X1
Código: Fábrica: Unidade:
51114 STICKERS DZ/12
F4

UN: R\$ 0,34 AV: R\$ 4,10 15: R\$ 4,18
30: R\$ 4,27 45: R\$ 4,35 60: R\$ 4,44



ADESIVO P NATAL 12X1
Código: Fábrica: Unidade:
37231 STICKERS DZ/12
F1 F4

UN: R\$ 0,34 AV: R\$ 4,10 15: R\$ 4,18
30: R\$ 4,27 45: R\$ 4,35 60: R\$ 4,44



ADESIVO P NUMEROS 12X1
Código: Fábrica: Unidade:
4758 STICKERS DZ/12
F4

UN: R\$ 0,34 AV: R\$ 4,10 15: R\$ 4,18
30: R\$ 4,27 45: R\$ 4,35 60: R\$ 4,44



ADESIVO P OS INCRIVEIS 12X1
Código: Fábrica: Unidade:
25724 STICKERS DZ/12
F1 F4

UN: R\$ 0,34 AV: R\$ 4,10 15: R\$ 4,18
30: R\$ 4,27 45: R\$ 4,35 60: R\$ 4,44



ADESIVO P PALMEIRAS 12X1
Código: Fábrica: Unidade:
37229 STICKERS DZ/12
F1 F4

UN: R\$ 0,34 AV: R\$ 4,10 15: R\$ 4,18
30: R\$ 4,27 45: R\$ 4,35 60: R\$ 4,44



ADESIVO P PIU PIU 12X1
Código: Fábrica: Unidade:
24029 STICKERS DZ/12
F1 F4

UN: R\$ 0,34 AV: R\$ 4,10 15: R\$ 4,18
30: R\$ 4,27 45: R\$ 4,35 60: R\$ 4,44



ADESIVO P POKEMON 12X1

Código: Fábrika: Unidade:
30531 STICKERS DZ/12
F1 F4

UN: R\$ 0,34 AV: R\$ 4,10 15: R\$ 4,18
30: R\$ 4,27 45: R\$ 4,35 60: R\$ 4,44



ADESIVO P POWER RANGERS 12X1

Código: Fábrika: Unidade:
22029 STICKERS DZ/12
F1 F4

UN: R\$ 0,34 AV: R\$ 4,10 15: R\$ 4,18
30: R\$ 4,27 45: R\$ 4,35 60: R\$ 4,44



ADESIVO P PRINCESAS 12X1

Código: Fábrika: Unidade:
18181 STICKERS DZ/12
F1 F4

UN: R\$ 0,34 AV: R\$ 4,10 15: R\$ 4,18
30: R\$ 4,27 45: R\$ 4,35 60: R\$ 4,44



ADESIVO P SAO PAUL 12X1

Código: Fábrika: Unidade:
37230 STICKERS DZ/12
F1 F4

UN: R\$ 0,34 AV: R\$ 4,10 15: R\$ 4,18
30: R\$ 4,27 45: R\$ 4,35 60: R\$ 4,44



ADESIVO P SCOOBY DOO 12X1

Código: Fábrika: Unidade:
24851 STICKERS DZ/12
F4

UN: R\$ 0,34 AV: R\$ 4,10 15: R\$ 4,18
30: R\$ 4,27 45: R\$ 4,35 60: R\$ 4,44



ADESIVO P SMILINGUIDO 12X1

Código: Fábrika: Unidade:
22031 STICKERS DZ/12
F4

UN: R\$ 0,34 AV: R\$ 4,10 15: R\$ 4,18
30: R\$ 4,27 45: R\$ 4,35 60: R\$ 4,44



ADESIVO P SORTIDO 12X1

Código: Fábrika: Unidade:
3806 STICKERS DZ/12
F1 F4

UN: R\$ 0,34 AV: R\$ 4,10 15: R\$ 4,18
30: R\$ 4,27 45: R\$ 4,35 60: R\$ 4,44



ADESIVO P SPIDERMAN 12X1

Código: Fábrika: Unidade:
22033 STICKERS DZ/12
F4

UN: R\$ 0,34 AV: R\$ 4,10 15: R\$ 4,18
30: R\$ 4,27 45: R\$ 4,35 60: R\$ 4,44



ADESIVO P SUPER MARIO 12X1

Código: Fábrika: Unidade:
18180 STICKERS DZ/12
F1 F4

UN: R\$ 0,34 AV: R\$ 4,10 15: R\$ 4,18
30: R\$ 4,27 45: R\$ 4,35 60: R\$ 4,44



ADESIVO P SUPER PODEROSAS 12X1

Código: Fábrika: Unidade:
18174 STICKERS DZ/12
F1 F4

UN: R\$ 0,34 AV: R\$ 4,10 15: R\$ 4,18
30: R\$ 4,27 45: R\$ 4,35 60: R\$ 4,44



ADESIVO P YU GI OH 12X1

Código: Fábrika: Unidade:
51113 STICKERS DZ/12
F4

UN: R\$ 2,16 AV: R\$ 2,16 15: R\$ 2,20
30: R\$ 2,25 45: R\$ 2,29 60: R\$ 2,34



ADESIVO PAREDE WALL STICKER P DECORATIVO

Código: Fábrika: Unidade:
16429 HAI BRASIL UN/1
F1 F4

UN: R\$ 1,54 AV: R\$ 15,40 15: R\$ 15,72
30: R\$ 16,03 45: R\$ 16,35 60: R\$ 16,68



ADESIVO PEQ RELEVO BEN 10 10X1

Código: Fábrika: Unidade:
46103 STICKERS PT/10
F1 F4

UN: R\$ 1,54 AV: R\$ 15,40 15: R\$ 15,72
30: R\$ 16,03 45: R\$ 16,35 60: R\$ 16,68



ADESIVO PEQ RELEVO BETY BOOP 10X1

Código: Fábrika: Unidade:
46093 STICKERS PT/10
F1 F4

UN: R\$ 1,54 AV: R\$ 15,40 15: R\$ 15,72
30: R\$ 16,03 45: R\$ 16,35 60: R\$ 16,68



ADESIVO PEQ RELEVO HELLO KITTY 10X1

Código: Fábrika: Unidade:
46104 STICKERS PT/10
F1 F4

UN: R\$ 1,54 AV: R\$ 15,40 15: R\$ 15,72
30: R\$ 16,03 45: R\$ 16,35 60: R\$ 16,68



ADESIVO PEQ RELEVO JOLIE 10X1

Código: Fábrika: Unidade:
46101 STICKERS PT/10
F1 F4

UN: R\$ 1,54 AV: R\$ 15,40 15: R\$ 15,72
30: R\$ 16,03 45: R\$ 16,35 60: R\$ 16,68



ADESIVO PEQ RELEVO MICKEY MINNIE 10X1

Código: Fábrika: Unidade:
47213 STICKERS PT/10
F1 F4

UN: R\$ 24,64 AV: R\$ 24,64 15: R\$ 25,16
30: R\$ 25,66 45: R\$ 26,17 60: R\$ 26,70



AGENDA PERMAN DIARI 15X21CM 406PGS 6102

Código: Fábrika: Unidade:
42633 CIRCULO UN/1
F1 F4

UN: R\$ 25,67 AV: R\$ 25,67 15: R\$ 26,20
30: R\$ 26,73 45: R\$ 27,26 60: R\$ 27,81

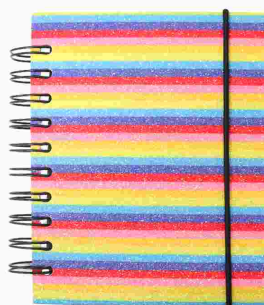

AGENDA PERMAN ESP COR 11X15CM 176FL 2005

Código: Fábrika: Unidade:
43756 WIN PAPER UN/1
F1 F4

UN: R\$ 25,67 AV: R\$ 25,67 15: R\$ 26,20
30: R\$ 26,73 45: R\$ 27,26 60: R\$ 27,81



AGENDA PERMAN ESP GLI 11X15CM 176FL 2006

Código: Fábrika: Unidade:
43760 WIN PAPER UN/1
F1 F4

UN: R\$ 25,67 AV: R\$ 25,67 15: R\$ 26,20
30: R\$ 26,73 45: R\$ 27,26 60: R\$ 27,81



AGENDA PERMAN ESP MAR 11X15CM 176FL 2004

Código: Fábrika: Unidade:
43755 WIN PAPER UN/1
F1 F4

UN: R\$ 21,56 AV: R\$ 21,56 15: R\$ 22,01
30: R\$ 22,45 45: R\$ 22,90 60: R\$ 23,36



AGENDA PERMAN ESP 11X15CM 176FL 2001

Código: Fábrika: Unidade:
43757 WIN PAPER UN/1
F1 F4

UN: R\$ 21,56 AV: R\$ 21,56 15: R\$ 22,01
30: R\$ 22,45 45: R\$ 22,90 60: R\$ 23,36



AGENDA PERMAN ESP 11X15CM 176FL 2002

Código: Fábrika: Unidade:
43759 WIN PAPER UN/1
F1 F4

UN: R\$ 25,67 AV: R\$ 25,67 15: R\$ 26,20
30: R\$ 26,73 45: R\$ 27,26 60: R\$ 27,81



AGENDA PERMAN ESP 11X15CM 320PAG 10046

Código: Fábrika: Unidade:
42815 WIN PAPER UN/1
F1 F4

UN: R\$ 25,67 AV: R\$ 25,67 15: R\$ 26,20
30: R\$ 26,73 45: R\$ 27,26 60: R\$ 27,81



AGENDA PERMAN ESP 11X15CM 352 PAG 1021

Código: Fábrika: Unidade:
43777 WIN PAPER UN/1
F1 F4

UN: R\$ 25,67 AV: R\$ 25,67 15: R\$ 26,20
30: R\$ 26,73 45: R\$ 27,26 60: R\$ 27,81



AGENDA PERMAN ESP 15X11CM 320PAG 10002

Código: Fábrika: Unidade:
43812 WIN PAPER UN/1
F1 F4

UN: R\$ 35,94 AV: R\$ 35,94 15: R\$ 36,69
30: R\$ 37,42 45: R\$ 38,17 60: R\$ 38,94



AGENDA PERMAN ESP 15X21CM 160FL 2007

Código: Fábrika: Unidade:
43761 WIN PAPER UN/1
F1 F4

UN: R\$ 35,94 AV: R\$ 35,94 15: R\$ 36,69
30: R\$ 37,42 45: R\$ 38,17 60: R\$ 38,94

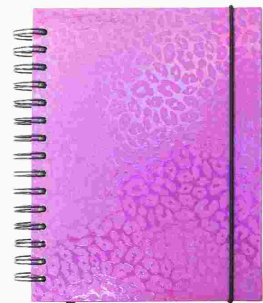

AGENDA PERMAN ESP 15X21CM 160FL 2009

Código: Fábrika: Unidade:
43762 WIN PAPER UN/1
F1 F4

UN: R\$ 30,81 AV: R\$ 30,81 15: R\$ 31,45
30: R\$ 32,08 45: R\$ 32,72 60: R\$ 33,37



AGENDA PERMAN ESP 15X21CM 320 PAG 52344

Código: Fábrika: Unidade:
42939 WIN PAPER UN/1
F1 F4

UN: R\$ 32,86 AV: R\$ 32,86 15: R\$ 33,54
30: R\$ 34,22 45: R\$ 34,90 60: R\$ 35,60



AGENDA PERMAN ESP 15X21CM 320PAG 10005

Código: Fábrika: Unidade:
43763 WIN PAPER UN/1
F1 F4

UN: R\$ 30,81 AV: R\$ 30,81 15: R\$ 31,45
30: R\$ 32,08 45: R\$ 32,72 60: R\$ 33,37



AGENDA PERMAN ESPIR 15X21CM 320PAG 1006

Código: Fábrika: Unidade:
42816 WINPAPER UN/1
F1 F4

UN: R\$ 14,37 AV: R\$ 14,37 15: R\$ 14,67
30: R\$ 14,96 45: R\$ 15,26 60: R\$ 15,57



AGENDA PERMAN INF 17X11,8CM 64PAG 1487

Código: Fábrika: Unidade:
42817 WIN PAPER UN/1
F1 F4

UN: R\$ 30,81 AV: R\$ 30,81 15: R\$ 31,45
30: R\$ 32,08 45: R\$ 32,72 60: R\$ 33,37



AGENDA PERMAN SOCIAL 15X21CM 320PAG 1015
Código: Fábrica: Unidade:
15905 WINPAPER UN/1
F1 F4

UN: R\$ 22,59 AV: R\$ 22,59 15: R\$ 23,06
30: R\$ 23,52 45: R\$ 23,99 60: R\$ 24,47



AGENDA PERMANENTE 14X20CM 122FLS
Código: Fábrica: Unidade:
41330 ARTS GRAF UN/1
F1 F4

UN: R\$ 29,78 AV: R\$ 29,78 15: R\$ 30,40
30: R\$ 31,01 45: R\$ 31,63 60: R\$ 32,26



AGENDA PERMANENTE 15X21CM 320 PGS 50010
Código: Fábrica: Unidade:
48386 WIN PAPER UN/1
F1 F4

UN: R\$ 20,53 AV: R\$ 20,53 15: R\$ 20,96
30: R\$ 21,38 45: R\$ 21,81 60: R\$ 22,24



AGENDA PLANNER 10,5X15CM 320PAG 5004
Código: Fábrica: Unidade:
43531 WIN PAPER UN/1
F1 F4

UN: R\$ 8,21 AV: R\$ 8,21 15: R\$ 8,38
30: R\$ 8,55 45: R\$ 8,72 60: R\$ 8,89

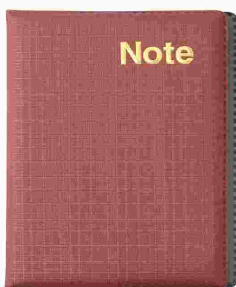

AGENDA TELEFONIC 14X10CM COURO SINT 101
Código: Fábrica: Unidade:
43780 WIN PAPER UN/1
F1 F4

UN: R\$ 35,94 AV: R\$ 35,94 15: R\$ 36,69
30: R\$ 37,42 45: R\$ 38,17 60: R\$ 38,94



AGENDA 2025 EXECUTIVA 15X21CM ESP 320 PG
Código: Fábrica: Unidade:
48398 WIN PAPER UN/1
F1 F4

UN: R\$ 30,81 AV: R\$ 30,81 15: R\$ 31,45
30: R\$ 32,08 45: R\$ 32,72 60: R\$ 33,37



AGENDA 2025 13,2X20CM 328PAG C/HORAS
Código: Fábrica: Unidade:
42404 NOVO OLHAR UN/1
F1 F4

UN: R\$ 101,69 AV: R\$ 101,69 15: R\$ 103,81
30: R\$ 105,89 45: R\$ 108,01 60: R\$ 110,17

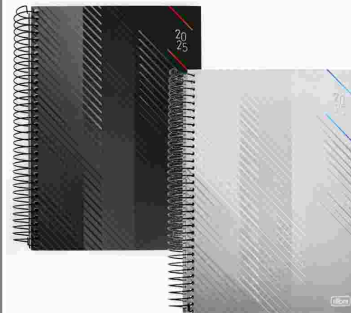

AGENDA 2025 20X27CM ESP 200 FOLHAS
Código: Fábrica: Unidade:
49244 TILIBRA UN/1
F1 F4

UN: R\$ 29,28 AV: R\$ 29,28 15: R\$ 29,89
30: R\$ 30,48 45: R\$ 31,09 60: R\$ 31,71



AGENDA 2026 1307X18,7XM 168 PGS
Código: Fábrica: Unidade:
29796 RIO MASTER UN/1
F1 F4

UN: R\$ 0,24 AV: R\$ 9,75 15: R\$ 9,95
30: R\$ 10,15 45: R\$ 10,35 60: R\$ 10,56
5 cm



ALFABETO E NUMEROS EVA 5CM AMARELO 40X1
Código: Fábrica: Unidade:
38589 BRASILPAPERS PT/40
F1 F4

UN: R\$ 0,24 AV: R\$ 9,75 15: R\$ 9,95
30: R\$ 10,15 45: R\$ 10,35 60: R\$ 10,56
5 cm



ALFABETO E NUMEROS EVA 5CM BRANCO 40X1
Código: Fábrica: Unidade:
38590 BRASILPAPERS PT/40
F1 F4

UN: R\$ 0,24 AV: R\$ 9,75 15: R\$ 9,95
30: R\$ 10,15 45: R\$ 10,35 60: R\$ 10,56
5 cm



ALFABETO E NUMEROS EVA 5CM PRETO 40X1
Código: Fábrica: Unidade:
38595 BRASILPAPERS PT/40
F1 F4

UN: R\$ 0,24 AV: R\$ 9,75 15: R\$ 9,95
30: R\$ 10,15 45: R\$ 10,35 60: R\$ 10,56
5 cm

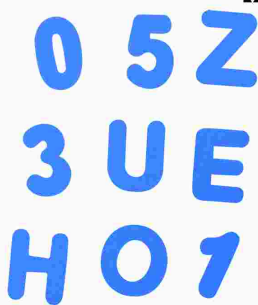

ALFABETO E NUMEROS EVA 5CM ROSA 40X1
Código: Fábrica: Unidade:
38593 BRASILPAPERS PT/40
F1 F4

UN: R\$ 0,24 AV: R\$ 9,75 15: R\$ 9,95
30: R\$ 10,15 45: R\$ 10,35 60: R\$ 10,56
5 cm



ALFABETO E NUMEROS EVA 5CM SORTIDO 40X1
Código: Fábrica: Unidade:
38594 BRASILPAPERS PT/40
F1 F4

UN: R\$ 0,24 AV: R\$ 9,75 15: R\$ 9,95
30: R\$ 10,15 45: R\$ 10,35 60: R\$ 10,56
5 cm

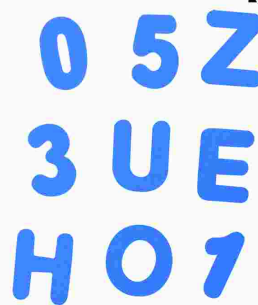

ALFABETO E NUMEROS EVA 5CM VERDE 40X1
Código: Fábrica: Unidade:
38592 BRASILPAPERS PT/40
F1 F4

UN: R\$ 0,97 AV: R\$ 9,75 15: R\$ 9,95
30: R\$ 10,15 45: R\$ 10,35 60: R\$ 10,56
13 cm



ALFABETO EVA 13CM LETRA A AMARELO 10X1
Código: Fábrica: Unidade:
38623 BRASILPAPERS PT/10
F4

UN: R\$ 0,97 AV: R\$ 9,75 15: R\$ 9,95
30: R\$ 10,15 45: R\$ 10,35 60: R\$ 10,56
13 cm



ALFABETO EVA 13CM LETRA A AZUL 10X1
Código: 38737 Fábrica: BRASILPAPERS Unidade: PT/10 F4

UN: R\$ 0,97 AV: R\$ 9,75 15: R\$ 9,95
30: R\$ 10,15 45: R\$ 10,35 60: R\$ 10,56
13 cm



ALFABETO EVA 13CM LETRA A BRANCO 10X1
Código: 38710 Fábrica: BRASILPAPERS Unidade: PT/10 F4

UN: R\$ 0,97 AV: R\$ 9,75 15: R\$ 9,95
30: R\$ 10,15 45: R\$ 10,35 60: R\$ 10,56
13 cm



ALFABETO EVA 13CM LETRA A PRETO 10X1
Código: 38633 Fábrica: BRASILPAPERS Unidade: PT/10 F4

UN: R\$ 0,97 AV: R\$ 9,75 15: R\$ 9,95
30: R\$ 10,15 45: R\$ 10,35 60: R\$ 10,56
13 cm



ALFABETO EVA 13CM LETRA A ROSA 10X1
Código: 38596 Fábrica: BRASILPAPERS Unidade: PT/10 F4

UN: R\$ 0,97 AV: R\$ 9,75 15: R\$ 9,95
30: R\$ 10,15 45: R\$ 10,35 60: R\$ 10,56
13 cm

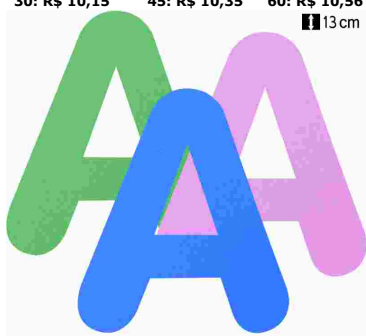

ALFABETO EVA 13CM LETRA A SORTIDO 10X1
Código: 38821 Fábrica: BRASILPAPERS Unidade: PT/10 F4

UN: R\$ 0,97 AV: R\$ 9,75 15: R\$ 9,95
30: R\$ 10,15 45: R\$ 10,35 60: R\$ 10,56
13 cm



ALFABETO EVA 13CM LETRA A VERDE 10X1
Código: 38767 Fábrica: BRASILPAPERS Unidade: PT/10 F4

UN: R\$ 0,97 AV: R\$ 9,75 15: R\$ 9,95
30: R\$ 10,15 45: R\$ 10,35 60: R\$ 10,56
13 cm



ALFABETO EVA 13CM LETRA A VERMELHO 10X1
Código: 38794 Fábrica: BRASILPAPERS Unidade: PT/10 F4

UN: R\$ 0,97 AV: R\$ 9,75 15: R\$ 9,95
30: R\$ 10,15 45: R\$ 10,35 60: R\$ 10,56
13 cm



ALFABETO EVA 13CM LETRA B AMARELO 10X1
Código: 38709 Fábrica: BRASILPAPERS Unidade: PT/10 F4

UN: R\$ 0,97 AV: R\$ 9,75 15: R\$ 9,95
30: R\$ 10,15 45: R\$ 10,35 60: R\$ 10,56
13 cm



ALFABETO EVA 13CM LETRA B AZUL 10X1
Código: 38738 Fábrica: BRASILPAPERS Unidade: PT/10 F4

UN: R\$ 0,97 AV: R\$ 9,75 15: R\$ 9,95
30: R\$ 10,15 45: R\$ 10,35 60: R\$ 10,56
13 cm



ALFABETO EVA 13CM LETRA B BRANCO 10X1
Código: 38711 Fábrica: BRASILPAPERS Unidade: PT/10 F4

UN: R\$ 0,97 AV: R\$ 9,75 15: R\$ 9,95
30: R\$ 10,15 45: R\$ 10,35 60: R\$ 10,56
13 cm



ALFABETO EVA 13CM LETRA B PRETO 10X1
Código: 38634 Fábrica: BRASILPAPERS Unidade: PT/10 F4

UN: R\$ 0,97 AV: R\$ 9,75 15: R\$ 9,95
30: R\$ 10,15 45: R\$ 10,35 60: R\$ 10,56
13 cm



ALFABETO EVA 13CM LETRA B VERDE 10X1
Código: 38768 Fábrica: BRASILPAPERS Unidade: PT/10 F4

UN: R\$ 0,97 AV: R\$ 9,75 15: R\$ 9,95
30: R\$ 10,15 45: R\$ 10,35 60: R\$ 10,56
13 cm



ALFABETO EVA 13CM LETRA B VERMELHO 10X1
Código: 38795 Fábrica: BRASILPAPERS Unidade: PT/10 F4

UN: R\$ 0,97 AV: R\$ 9,75 15: R\$ 9,95
30: R\$ 10,15 45: R\$ 10,35 60: R\$ 10,56
13 cm



ALFABETO EVA 13CM LETRA C AMARELO 10X1
Código: 38682 Fábrica: BRASILPAPERS Unidade: PT/10 F4

UN: R\$ 0,97 AV: R\$ 9,75 15: R\$ 9,95
30: R\$ 10,15 45: R\$ 10,35 60: R\$ 10,56
13 cm



ALFABETO EVA 13CM LETRA Ç AMARELO 10X1
Código: 38697 Fábrica: BRASILPAPERS Unidade: PT/10 F4

UN: R\$ 0,97 AV: R\$ 9,75 15: R\$ 9,95
30: R\$ 10,15 45: R\$ 10,35 60: R\$ 10,56
13 cm



ALFABETO EVA 13CM LETRA C AZUL 10X1
Código: 38739 Fábrica: BRASILPAPERS Unidade: PT/10 F4

UN: R\$ 0,97 AV: R\$ 9,75 15: R\$ 9,95
30: R\$ 10,15 45: R\$ 10,35 60: R\$ 10,56
13 cm



ALFABETO EVA 13CM LETRA Ç AZUL 10X1
Código: 38766 Fábrica: BRASILPAPERS Unidade: PT/10 F4

UN: R\$ 0,97 AV: R\$ 9,75 15: R\$ 9,95
30: R\$ 10,15 45: R\$ 10,35 60: R\$ 10,56
13 cm



ALFABETO EVA 13CM LETRA C BRANCO 10X1
Código: 38712 Fábrica: BRASILPAPERS Unidade: PT/10 F4

UN: R\$ 0,97 AV: R\$ 9,75 15: R\$ 9,95
30: R\$ 10,15 45: R\$ 10,35 60: R\$ 10,56
13 cm



ALFABETO EVA 13CM LETRA Ç BRANCO 10X1
Código: 38736 Fábrica: BRASILPAPERS Unidade: PT/10 F4

UN: R\$ 0,97 AV: R\$ 9,75 15: R\$ 9,95
30: R\$ 10,15 45: R\$ 10,35 60: R\$ 10,56
13 cm



ALFABETO EVA 13CM LETRA C PRETO 10X1
Código: 38639 Fábrica: BRASILPAPERS Unidade: PT/10 F4

UN: R\$ 0,97 AV: R\$ 9,75 15: R\$ 9,95
30: R\$ 10,15 45: R\$ 10,35 60: R\$ 10,56
13 cm



ALFABETO EVA 13CM LETRA Ç PRETO 10X1
Código: 38702 Fábrica: BRASILPAPERS Unidade: PT/10 F4

UN: R\$ 0,97 AV: R\$ 9,75 15: R\$ 9,95
30: R\$ 10,15 45: R\$ 10,35 60: R\$ 10,56
13 cm



ALFABETO EVA 13CM LETRA C ROSA 10X1
Código: 38598 Fábrica: BRASILPAPERS Unidade: PT/10 F4

UN: R\$ 0,97 AV: R\$ 9,75 15: R\$ 9,95
30: R\$ 10,15 45: R\$ 10,35 60: R\$ 10,56
13 cm



ALFABETO EVA 13CM LETRA Ç ROSA 10X1
Código: 38622 Fábrica: BRASILPAPERS Unidade: PT/10 F4

UN: R\$ 0,97 AV: R\$ 9,75 15: R\$ 9,95
30: R\$ 10,15 45: R\$ 10,35 60: R\$ 10,56
13 cm



ALFABETO EVA 13CM LETRA C VERDE 10X1
Código: 38769 Fábrica: BRASILPAPERS Unidade: PT/10 F4

UN: R\$ 0,97 AV: R\$ 9,75 15: R\$ 9,95
30: R\$ 10,15 45: R\$ 10,35 60: R\$ 10,56
13 cm



ALFABETO EVA 13CM LETRA Ç VERDE 10X1
Código: 38793 Fábrica: BRASILPAPERS Unidade: PT/10 F4

UN: R\$ 0,97 AV: R\$ 9,75 15: R\$ 9,95
30: R\$ 10,15 45: R\$ 10,35 60: R\$ 10,56
13 cm

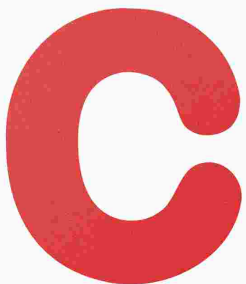

ALFABETO EVA 13CM LETRA C VERMELHO 10X1
Código: 38796 Fábrica: BRASILPAPERS Unidade: PT/10 F4

UN: R\$ 0,97 AV: R\$ 9,75 15: R\$ 9,95
30: R\$ 10,15 45: R\$ 10,35 60: R\$ 10,56
13 cm



ALFABETO EVA 13CM LETRA D AMARELO 10X1
Código: 38624 Fábrica: BRASILPAPERS Unidade: PT/10 F4

UN: R\$ 0,97 AV: R\$ 9,75 15: R\$ 9,95
30: R\$ 10,15 45: R\$ 10,35 60: R\$ 10,56
13 cm



ALFABETO EVA 13CM LETRA D AZUL 10X1
Código: 38740 Fábrica: BRASILPAPERS Unidade: PT/10 F4

UN: R\$ 0,97 AV: R\$ 9,75 15: R\$ 9,95
30: R\$ 10,15 45: R\$ 10,35 60: R\$ 10,56
13 cm



ALFABETO EVA 13CM LETRA D BRANCO 10X1
Código: 38713 Fábrica: BRASILPAPERS Unidade: PT/10 F4

UN: R\$ 0,97 AV: R\$ 9,75 15: R\$ 9,95
30: R\$ 10,15 45: R\$ 10,35 60: R\$ 10,56
13 cm



ALFABETO EVA 13CM LETRA D PRETO 10X1
Código: 38636 Fábrica: BRASILPAPERS Unidade: PT/10 F4

UN: R\$ 0,97 AV: R\$ 9,75 15: R\$ 9,95
30: R\$ 10,15 45: R\$ 10,35 60: R\$ 10,56
13 cm



ALFABETO EVA 13CM LETRA D ROSA 10X1
Código: 38599 Fábrica: BRASILPAPERS Unidade: PT/10 F4

UN: R\$ 0,97 AV: R\$ 9,75 15: R\$ 9,95
30: R\$ 10,15 45: R\$ 10,35 60: R\$ 10,56
13 cm



ALFABETO EVA 13CM LETRA D VERDE 10X1
Código: 38770 Fábrica: BRASILPAPERS Unidade: PT/10 F4

UN: R\$ 0,97 AV: R\$ 9,75 15: R\$ 9,95
30: R\$ 10,15 45: R\$ 10,35 60: R\$ 10,56
13cm



ALFABETO EVA 13CM LETRA D VERMELHO 10X1
Código: 38797 Fábrica: BRASILPAPERS Unidade: PT/10 F4

UN: R\$ 0,97 AV: R\$ 9,75 15: R\$ 9,95
30: R\$ 10,15 45: R\$ 10,35 60: R\$ 10,56
13cm



ALFABETO EVA 13CM LETRA E AMARELO 10X1
Código: 38683 Fábrica: BRASILPAPERS Unidade: PT/10 F4

UN: R\$ 0,97 AV: R\$ 9,75 15: R\$ 9,95
30: R\$ 10,15 45: R\$ 10,35 60: R\$ 10,56
13cm



ALFABETO EVA 13CM LETRA E AZUL 10X1
Código: 38741 Fábrica: BRASILPAPERS Unidade: PT/10 F4

UN: R\$ 0,97 AV: R\$ 9,75 15: R\$ 9,95
30: R\$ 10,15 45: R\$ 10,35 60: R\$ 10,56
13cm



ALFABETO EVA 13CM LETRA E BRANCO 10X1
Código: 38714 Fábrica: BRASILPAPERS Unidade: PT/10 F4

UN: R\$ 0,97 AV: R\$ 9,75 15: R\$ 9,95
30: R\$ 10,15 45: R\$ 10,35 60: R\$ 10,56
13cm



ALFABETO EVA 13CM LETRA E ROSA 10X1
Código: 38600 Fábrica: BRASILPAPERS Unidade: PT/10 F4

UN: R\$ 0,97 AV: R\$ 9,75 15: R\$ 9,95
30: R\$ 10,15 45: R\$ 10,35 60: R\$ 10,56
13cm



ALFABETO EVA 13CM LETRA E SORTIDO 10X1
Código: 38825 Fábrica: BRASILPAPERS Unidade: PT/10 F4

UN: R\$ 0,97 AV: R\$ 9,75 15: R\$ 9,95
30: R\$ 10,15 45: R\$ 10,35 60: R\$ 10,56
13cm



ALFABETO EVA 13CM LETRA E VERDE 10X1
Código: 38771 Fábrica: BRASILPAPERS Unidade: PT/10 F4

UN: R\$ 0,97 AV: R\$ 9,75 15: R\$ 9,95
30: R\$ 10,15 45: R\$ 10,35 60: R\$ 10,56
13cm



ALFABETO EVA 13CM LETRA E VERMELHO 10X1
Código: 38798 Fábrica: BRASILPAPERS Unidade: PT/10 F4

UN: R\$ 0,97 AV: R\$ 9,75 15: R\$ 9,95
30: R\$ 10,15 45: R\$ 10,35 60: R\$ 10,56
13cm



ALFABETO EVA 13CM LETRA F AMARELO 10X1
Código: 38625 Fábrica: BRASILPAPERS Unidade: PT/10 F4

UN: R\$ 0,97 AV: R\$ 9,75 15: R\$ 9,95
30: R\$ 10,15 45: R\$ 10,35 60: R\$ 10,56
13cm



ALFABETO EVA 13CM LETRA F AZUL 10X1
Código: 38742 Fábrica: BRASILPAPERS Unidade: PT/10 F4

UN: R\$ 0,97 AV: R\$ 9,75 15: R\$ 9,95
30: R\$ 10,15 45: R\$ 10,35 60: R\$ 10,56
13cm



ALFABETO EVA 13CM LETRA F BRANCO 10X1
Código: 38715 Fábrica: BRASILPAPERS Unidade: PT/10 F4

UN: R\$ 0,97 AV: R\$ 9,75 15: R\$ 9,95
30: R\$ 10,15 45: R\$ 10,35 60: R\$ 10,56
13cm



ALFABETO EVA 13CM LETRA F PRETO 10X1
Código: 38640 Fábrica: BRASILPAPERS Unidade: PT/10 F4

UN: R\$ 0,97 AV: R\$ 9,75 15: R\$ 9,95
30: R\$ 10,15 45: R\$ 10,35 60: R\$ 10,56
13cm



ALFABETO EVA 13CM LETRA F ROSA 10X1
Código: 38601 Fábrica: BRASILPAPERS Unidade: PT/10 F4

UN: R\$ 0,97 AV: R\$ 9,75 15: R\$ 9,95
30: R\$ 10,15 45: R\$ 10,35 60: R\$ 10,56
13cm



ALFABETO EVA 13CM LETRA F VERDE 10X1
Código: 38777 Fábrica: BRASILPAPERS Unidade: PT/10 F4

UN: R\$ 0,97 AV: R\$ 9,75 15: R\$ 9,95
30: R\$ 10,15 45: R\$ 10,35 60: R\$ 10,56
13cm



ALFABETO EVA 13CM LETRA F VERMELHO 10X1
Código: 38799 Fábrica: BRASILPAPERS Unidade: PT/10 F4

UN: R\$ 0,97 AV: R\$ 9,75 15: R\$ 9,95
30: R\$ 10,15 45: R\$ 10,35 60: R\$ 10,56
13cm

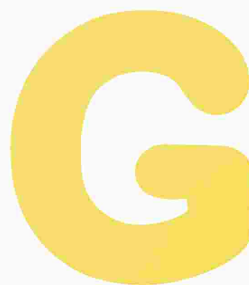

ALFABETO EVA 13CM LETRA G AMARELO 10X1
Código: 38626 Fábrica: BRASILPAPERS Unidade: PT/10 F4

UN: R\$ 0,97 AV: R\$ 9,75 15: R\$ 9,95
30: R\$ 10,15 45: R\$ 10,35 60: R\$ 10,56
13 cm



ALFABETO EVA 13CM LETRA G AZUL 10X1
Código: 38743 Fábrica: BRASILPAPERS Unidade: PT/10 F4

UN: R\$ 0,97 AV: R\$ 9,75 15: R\$ 9,95
30: R\$ 10,15 45: R\$ 10,35 60: R\$ 10,56
13 cm



ALFABETO EVA 13CM LETRA G BRANCO 10X1
Código: 38716 Fábrica: BRASILPAPERS Unidade: PT/10 F4

UN: R\$ 0,97 AV: R\$ 9,75 15: R\$ 9,95
30: R\$ 10,15 45: R\$ 10,35 60: R\$ 10,56
13 cm



ALFABETO EVA 13CM LETRA G PRETO 10X1
Código: 38641 Fábrica: BRASILPAPERS Unidade: PT/10 F4

UN: R\$ 0,97 AV: R\$ 9,75 15: R\$ 9,95
30: R\$ 10,15 45: R\$ 10,35 60: R\$ 10,56
13 cm



ALFABETO EVA 13CM LETRA G ROSA 10X1
Código: 38602 Fábrica: BRASILPAPERS Unidade: PT/10 F4

UN: R\$ 0,97 AV: R\$ 9,75 15: R\$ 9,95
30: R\$ 10,15 45: R\$ 10,35 60: R\$ 10,56
13 cm



ALFABETO EVA 13CM LETRA G VERDE 10X1
Código: 38772 Fábrica: BRASILPAPERS Unidade: PT/10 F4

UN: R\$ 0,97 AV: R\$ 9,75 15: R\$ 9,95
30: R\$ 10,15 45: R\$ 10,35 60: R\$ 10,56
13 cm



ALFABETO EVA 13CM LETRA G VERMELHO 10X1
Código: 38800 Fábrica: BRASILPAPERS Unidade: PT/10 F4

UN: R\$ 0,97 AV: R\$ 9,75 15: R\$ 9,95
30: R\$ 10,15 45: R\$ 10,35 60: R\$ 10,56
13 cm



ALFABETO EVA 13CM LETRA H AMARELO 10X1
Código: 38684 Fábrica: BRASILPAPERS Unidade: PT/10 F4

UN: R\$ 0,97 AV: R\$ 9,75 15: R\$ 9,95
30: R\$ 10,15 45: R\$ 10,35 60: R\$ 10,56
13 cm



ALFABETO EVA 13CM LETRA H AZUL 10X1
Código: 38744 Fábrica: BRASILPAPERS Unidade: PT/10 F4

UN: R\$ 0,97 AV: R\$ 9,75 15: R\$ 9,95
30: R\$ 10,15 45: R\$ 10,35 60: R\$ 10,56
13 cm



ALFABETO EVA 13CM LETRA H BRANCO 10X1
Código: 38717 Fábrica: BRASILPAPERS Unidade: PT/10 F4

UN: R\$ 0,97 AV: R\$ 9,75 15: R\$ 9,95
30: R\$ 10,15 45: R\$ 10,35 60: R\$ 10,56
13 cm

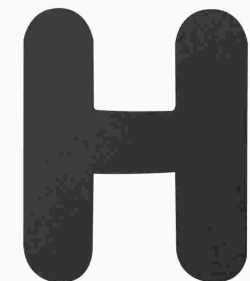

ALFABETO EVA 13CM LETRA H PRETO 10X1
Código: 38704 Fábrica: BRASILPAPERS Unidade: PT/10 F4

UN: R\$ 0,97 AV: R\$ 9,75 15: R\$ 9,95
30: R\$ 10,15 45: R\$ 10,35 60: R\$ 10,56
13 cm



ALFABETO EVA 13CM LETRA H ROSA 10X1
Código: 38603 Fábrica: BRASILPAPERS Unidade: PT/10 F4

UN: R\$ 0,97 AV: R\$ 9,75 15: R\$ 9,95
30: R\$ 10,15 45: R\$ 10,35 60: R\$ 10,56
13 cm



ALFABETO EVA 13CM LETRA H VERDE 10X1
Código: 38773 Fábrica: BRASILPAPERS Unidade: PT/10 F4

UN: R\$ 0,97 AV: R\$ 9,75 15: R\$ 9,95
30: R\$ 10,15 45: R\$ 10,35 60: R\$ 10,56
13 cm



ALFABETO EVA 13CM LETRA H VERMELHO 10X1
Código: 38801 Fábrica: BRASILPAPERS Unidade: PT/10 F4

UN: R\$ 0,97 AV: R\$ 9,75 15: R\$ 9,95
30: R\$ 10,15 45: R\$ 10,35 60: R\$ 10,56
13 cm



ALFABETO EVA 13CM LETRA I AMARELO 10X1
Código: 38685 Fábrica: BRASILPAPERS Unidade: PT/10 F4

UN: R\$ 0,97 AV: R\$ 9,75 15: R\$ 9,95
30: R\$ 10,15 45: R\$ 10,35 60: R\$ 10,56
13 cm



ALFABETO EVA 13CM LETRA I AZUL 10X1
Código: 38745 Fábrica: BRASILPAPERS Unidade: PT/10 F4

UN: R\$ 0,97 AV: R\$ 9,75 15: R\$ 9,95
30: R\$ 10,15 45: R\$ 10,35 60: R\$ 10,56
13 cm



ALFABETO EVA 13CM LETRA I BRANCO 10X1
Código: 38718 Fábrica: BRASILPAPERS Unidade: PT/10 F4

UN: R\$ 0,97 AV: R\$ 9,75 15: R\$ 9,95
30: R\$ 10,15 45: R\$ 10,35 60: R\$ 10,56
13 cm



ALFABETO EVA 13CM LETRA I PRETO 10X1
Código: 38637 Fábrica: BRASILPAPERS Unidade: PT/10 F4

UN: R\$ 0,97 AV: R\$ 9,75 15: R\$ 9,95
30: R\$ 10,15 45: R\$ 10,35 60: R\$ 10,56
13 cm



ALFABETO EVA 13CM LETRA I ROSA 10X1
Código: 38604 Fábrica: BRASILPAPERS Unidade: PT/10 F4

UN: R\$ 0,97 AV: R\$ 9,75 15: R\$ 9,95
30: R\$ 10,15 45: R\$ 10,35 60: R\$ 10,56
13 cm

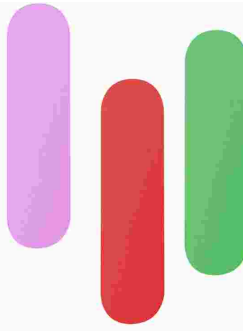

ALFABETO EVA 13CM LETRA I SORTIDO 10X1
Código: 38829 Fábrica: BRASILPAPERS Unidade: PT/10 F4

UN: R\$ 0,97 AV: R\$ 9,75 15: R\$ 9,95
30: R\$ 10,15 45: R\$ 10,35 60: R\$ 10,56
13 cm



ALFABETO EVA 13CM LETRA I VERDE 10X1
Código: 38774 Fábrica: BRASILPAPERS Unidade: PT/10 F4

UN: R\$ 0,97 AV: R\$ 9,75 15: R\$ 9,95
30: R\$ 10,15 45: R\$ 10,35 60: R\$ 10,56
13 cm



ALFABETO EVA 13CM LETRA I VERMELHO 10X1
Código: 38806 Fábrica: BRASILPAPERS Unidade: PT/10 F4

UN: R\$ 0,97 AV: R\$ 9,75 15: R\$ 9,95
30: R\$ 10,15 45: R\$ 10,35 60: R\$ 10,56
13 cm



ALFABETO EVA 13CM LETRA J AMARELO 10X1
Código: 38627 Fábrica: BRASILPAPERS Unidade: PT/10 F4

UN: R\$ 0,97 AV: R\$ 9,75 15: R\$ 9,95
30: R\$ 10,15 45: R\$ 10,35 60: R\$ 10,56
13 cm



ALFABETO EVA 13CM LETRA J AZUL 10X1
Código: 38746 Fábrica: BRASILPAPERS Unidade: PT/10 F4

UN: R\$ 0,97 AV: R\$ 9,75 15: R\$ 9,95
30: R\$ 10,15 45: R\$ 10,35 60: R\$ 10,56
13 cm



ALFABETO EVA 13CM LETRA J BRANCO 10X1
Código: 38719 Fábrica: BRASILPAPERS Unidade: PT/10 F4

UN: R\$ 0,97 AV: R\$ 9,75 15: R\$ 9,95
30: R\$ 10,15 45: R\$ 10,35 60: R\$ 10,56
13 cm

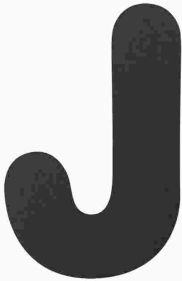

ALFABETO EVA 13CM LETRA J PRETO 10X1
Código: 38642 Fábrica: BRASILPAPERS Unidade: PT/10 F4

UN: R\$ 0,97 AV: R\$ 9,75 15: R\$ 9,95
30: R\$ 10,15 45: R\$ 10,35 60: R\$ 10,56
13 cm



ALFABETO EVA 13CM LETRA J ROSA 10X1
Código: 38605 Fábrica: BRASILPAPERS Unidade: PT/10 F4

UN: R\$ 0,97 AV: R\$ 9,75 15: R\$ 9,95
30: R\$ 10,15 45: R\$ 10,35 60: R\$ 10,56
13 cm



ALFABETO EVA 13CM LETRA J VERDE 10X1
Código: 38775 Fábrica: BRASILPAPERS Unidade: PT/10 F4

UN: R\$ 0,97 AV: R\$ 9,75 15: R\$ 9,95
30: R\$ 10,15 45: R\$ 10,35 60: R\$ 10,56
13 cm



ALFABETO EVA 13CM LETRA J VERMELHO 10X1
Código: 38802 Fábrica: BRASILPAPERS Unidade: PT/10 F4

UN: R\$ 0,97 AV: R\$ 9,75 15: R\$ 9,95
30: R\$ 10,15 45: R\$ 10,35 60: R\$ 10,56
13 cm

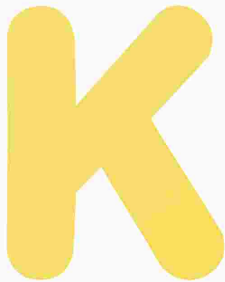

ALFABETO EVA 13CM LETRA K AMARELO 10X1
Código: 38686 Fábrica: BRASILPAPERS Unidade: PT/10 F4

UN: R\$ 0,97 AV: R\$ 9,75 15: R\$ 9,95
30: R\$ 10,15 45: R\$ 10,35 60: R\$ 10,56
13 cm

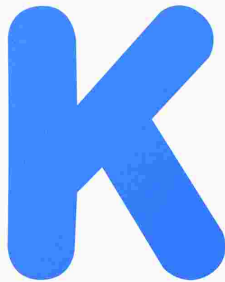

ALFABETO EVA 13CM LETRA K AZUL 10X1
Código: 38747 Fábrica: BRASILPAPERS Unidade: PT/10 F4

UN: R\$ 0,97 AV: R\$ 9,75 15: R\$ 9,95
30: R\$ 10,15 45: R\$ 10,35 60: R\$ 10,56
13 cm



ALFABETO EVA 13CM LETRA K BRANCO 10X1
Código: 38720 Fábrica: BRASILPAPERS Unidade: PT/10 F4

UN: R\$ 0,97 AV: R\$ 9,75 15: R\$ 9,95
30: R\$ 10,15 45: R\$ 10,35 60: R\$ 10,56
13 cm

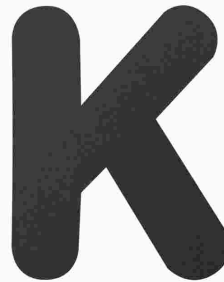

ALFABETO EVA 13CM LETRA K PRETO 10X1
Código: 38698 Fábrica: BRASILPAPERS Unidade: PT/10 F4

UN: R\$ 0,97 AV: R\$ 9,75 15: R\$ 9,95
30: R\$ 10,15 45: R\$ 10,35 60: R\$ 10,56
13 cm



ALFABETO EVA 13CM LETRA K ROSA 10X1
Código: 38606 Fábrica: BRASILPAPERS Unidade: PT/10 F4

UN: R\$ 0,97 AV: R\$ 9,75 15: R\$ 9,95
30: R\$ 10,15 45: R\$ 10,35 60: R\$ 10,56
13 cm



ALFABETO EVA 13CM LETRA K SORTIDO 10X1
Código: 38831 Fábrica: BRASILPAPERS Unidade: PT/10 F4

UN: R\$ 0,97 AV: R\$ 9,75 15: R\$ 9,95
30: R\$ 10,15 45: R\$ 10,35 60: R\$ 10,56
13 cm

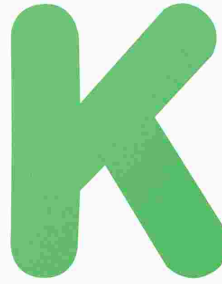

ALFABETO EVA 13CM LETRA K VERDE 10X1
Código: 38776 Fábrica: BRASILPAPERS Unidade: PT/10 F4

UN: R\$ 0,97 AV: R\$ 9,75 15: R\$ 9,95
30: R\$ 10,15 45: R\$ 10,35 60: R\$ 10,56
13 cm

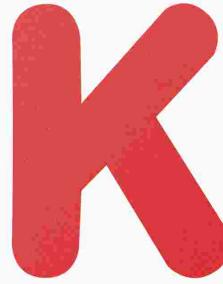

ALFABETO EVA 13CM LETRA K VERMELHO 10X1
Código: 38803 Fábrica: BRASILPAPERS Unidade: PT/10 F4

UN: R\$ 0,97 AV: R\$ 9,75 15: R\$ 9,95
30: R\$ 10,15 45: R\$ 10,35 60: R\$ 10,56
13 cm

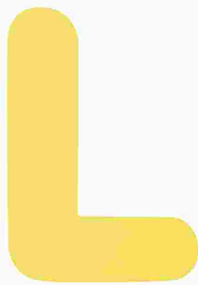

ALFABETO EVA 13CM LETRA L AMARELO 10X1
Código: 38628 Fábrica: BRASILPAPERS Unidade: PT/10 F4

UN: R\$ 0,97 AV: R\$ 9,75 15: R\$ 9,95
30: R\$ 10,15 45: R\$ 10,35 60: R\$ 10,56
13 cm



ALFABETO EVA 13CM LETRA L AZUL 10X1
Código: 38748 Fábrica: BRASILPAPERS Unidade: PT/10 F4

UN: R\$ 0,97 AV: R\$ 9,75 15: R\$ 9,95
30: R\$ 10,15 45: R\$ 10,35 60: R\$ 10,56
13 cm



ALFABETO EVA 13CM LETRA L BRANCO 10X1
Código: 38721 Fábrica: BRASILPAPERS Unidade: PT/10 F4

UN: R\$ 0,97 AV: R\$ 9,75 15: R\$ 9,95
30: R\$ 10,15 45: R\$ 10,35 60: R\$ 10,56
13 cm



ALFABETO EVA 13CM LETRA L PRETO 10X1
Código: 38643 Fábrica: BRASILPAPERS Unidade: PT/10 F4

UN: R\$ 0,97 AV: R\$ 9,75 15: R\$ 9,95
30: R\$ 10,15 45: R\$ 10,35 60: R\$ 10,56
13 cm

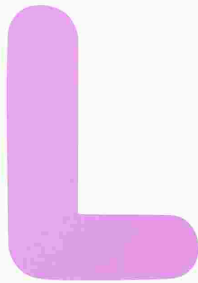

ALFABETO EVA 13CM LETRA L ROSA 10X1
Código: 38607 Fábrica: BRASILPAPERS Unidade: PT/10 F4

UN: R\$ 0,97 AV: R\$ 9,75 15: R\$ 9,95
30: R\$ 10,15 45: R\$ 10,35 60: R\$ 10,56
13 cm



ALFABETO EVA 13CM LETRA L VERDE 10X1
Código: 38778 Fábrica: BRASILPAPERS Unidade: PT/10 F4

UN: R\$ 0,97 AV: R\$ 9,75 15: R\$ 9,95
30: R\$ 10,15 45: R\$ 10,35 60: R\$ 10,56
13 cm



ALFABETO EVA 13CM LETRA L VERMELHO 10X1
Código: 38804 Fábrica: BRASILPAPERS Unidade: PT/10 F4

UN: R\$ 0,97 AV: R\$ 9,75 15: R\$ 9,95
30: R\$ 10,15 45: R\$ 10,35 60: R\$ 10,56
13 cm



ALFABETO EVA 13CM LETRA M AMARELO 10X1
Código: 38629 Fábrica: BRASILPAPERS Unidade: PT/10 F4

UN: R\$ 0,97 AV: R\$ 9,75 15: R\$ 9,95
30: R\$ 10,15 45: R\$ 10,35 60: R\$ 10,56
13 cm



ALFABETO EVA 13CM LETRA M AZUL 10X1
Código: 38749 Fábrica: BRASILPAPERS Unidade: PT/10 F4

UN: R\$ 0,97 AV: R\$ 9,75 15: R\$ 9,95
30: R\$ 10,15 45: R\$ 10,35 60: R\$ 10,56
13 cm



ALFABETO EVA 13CM LETRA M BRANCO 10X1
Código: 38722 Fábrica: BRASILPAPERS Unidade: PT/10 F4

UN: R\$ 0,97 AV: R\$ 9,75 15: R\$ 9,95
30: R\$ 10,15 45: R\$ 10,35 60: R\$ 10,56
13 cm



ALFABETO EVA 13CM LETRA M PRETO 10X1
Código: 38638 Fábrica: BRASILPAPERS Unidade: PT/10 F4

UN: R\$ 0,97 AV: R\$ 9,75 15: R\$ 9,95
30: R\$ 10,15 45: R\$ 10,35 60: R\$ 10,56
13 cm



ALFABETO EVA 13CM LETRA M ROSA 10X1
Código: 38608 Fábrica: BRASILPAPERS Unidade: PT/10 F4

UN: R\$ 0,97 AV: R\$ 9,75 15: R\$ 9,95
30: R\$ 10,15 45: R\$ 10,35 60: R\$ 10,56
13 cm



ALFABETO EVA 13CM LETRA M VERDE 10X1

Código: 38779 Fábrica: BRASILPAPERS Unidade: PT/10 F4

UN: R\$ 0,97 AV: R\$ 9,75 15: R\$ 9,95
30: R\$ 10,15 45: R\$ 10,35 60: R\$ 10,56
13 cm



ALFABETO EVA 13CM LETRA M VERMELHO 10X1

Código: 38805 Fábrica: BRASILPAPERS Unidade: PT/10 F4

UN: R\$ 0,97 AV: R\$ 9,75 15: R\$ 9,95
30: R\$ 10,15 45: R\$ 10,35 60: R\$ 10,56
13 cm



ALFABETO EVA 13CM LETRA N AMARELO 10X1

Código: 38687 Fábrica: BRASILPAPERS Unidade: PT/10 F4

UN: R\$ 0,97 AV: R\$ 9,75 15: R\$ 9,95
30: R\$ 10,15 45: R\$ 10,35 60: R\$ 10,56
13 cm

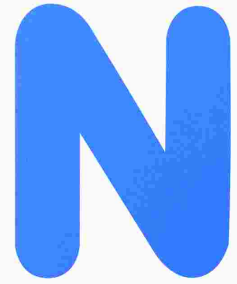

ALFABETO EVA 13CM LETRA N AZUL 10X1

Código: 38750 Fábrica: BRASILPAPERS Unidade: PT/10 F4

UN: R\$ 0,97 AV: R\$ 9,75 15: R\$ 9,95
30: R\$ 10,15 45: R\$ 10,35 60: R\$ 10,56
13 cm



ALFABETO EVA 13CM LETRA N BRANCO 10X1

Código: 38723 Fábrica: BRASILPAPERS Unidade: PT/10 F4

UN: R\$ 0,97 AV: R\$ 9,75 15: R\$ 9,95
30: R\$ 10,15 45: R\$ 10,35 60: R\$ 10,56
13 cm

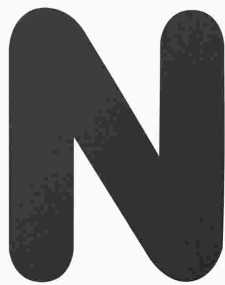

ALFABETO EVA 13CM LETRA N PRETO 10X1

Código: 38699 Fábrica: BRASILPAPERS Unidade: PT/10 F4

UN: R\$ 0,97 AV: R\$ 9,75 15: R\$ 9,95
30: R\$ 10,15 45: R\$ 10,35 60: R\$ 10,56
13 cm



ALFABETO EVA 13CM LETRA N ROSA 10X1

Código: 38609 Fábrica: BRASILPAPERS Unidade: PT/10 F4

UN: R\$ 0,97 AV: R\$ 9,75 15: R\$ 9,95
30: R\$ 10,15 45: R\$ 10,35 60: R\$ 10,56
13 cm

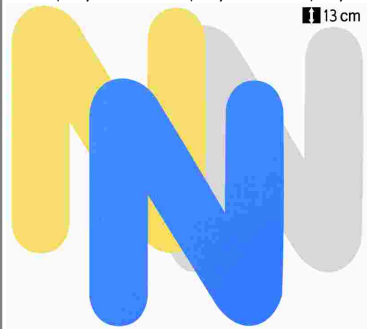

ALFABETO EVA 13CM LETRA N SORTIDO 10X1

Código: 38834 Fábrica: BRASILPAPERS Unidade: PT/10 F4

UN: R\$ 0,97 AV: R\$ 9,75 15: R\$ 9,95
30: R\$ 10,15 45: R\$ 10,35 60: R\$ 10,56
13 cm



ALFABETO EVA 13CM LETRA N VERDE 10X1

Código: 38780 Fábrica: BRASILPAPERS Unidade: PT/10 F4

UN: R\$ 0,97 AV: R\$ 9,75 15: R\$ 9,95
30: R\$ 10,15 45: R\$ 10,35 60: R\$ 10,56
13 cm



ALFABETO EVA 13CM LETRA N VERMELHO 10X1

Código: 38807 Fábrica: BRASILPAPERS Unidade: PT/10 F4

UN: R\$ 0,97 AV: R\$ 9,75 15: R\$ 9,95
30: R\$ 10,15 45: R\$ 10,35 60: R\$ 10,56
13 cm

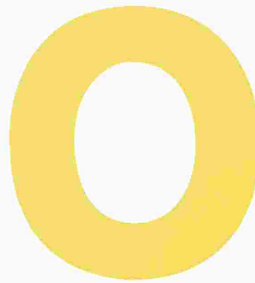

ALFABETO EVA 13CM LETRA O AMARELO 10X1

Código: 38688 Fábrica: BRASILPAPERS Unidade: PT/10 F4

UN: R\$ 0,97 AV: R\$ 9,75 15: R\$ 9,95
30: R\$ 10,15 45: R\$ 10,35 60: R\$ 10,56
13 cm

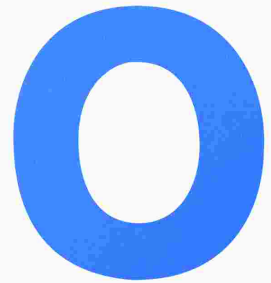

ALFABETO EVA 13CM LETRA O AZUL 10X1

Código: 38751 Fábrica: BRASILPAPERS Unidade: PT/10 F4

UN: R\$ 0,97 AV: R\$ 9,75 15: R\$ 9,95
30: R\$ 10,15 45: R\$ 10,35 60: R\$ 10,56
13 cm



ALFABETO EVA 13CM LETRA O BRANCO 10X1

Código: 38724 Fábrica: BRASILPAPERS Unidade: PT/10 F4

UN: R\$ 0,97 AV: R\$ 9,75 15: R\$ 9,95
30: R\$ 10,15 45: R\$ 10,35 60: R\$ 10,56
13 cm

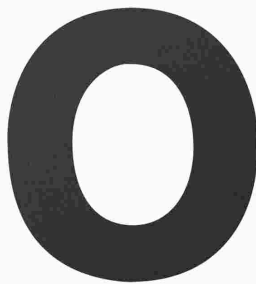

ALFABETO EVA 13CM LETRA O PRETO 10X1

Código: 38644 Fábrica: BRASILPAPERS Unidade: PT/10 F4

UN: R\$ 0,97 AV: R\$ 9,75 15: R\$ 9,95
30: R\$ 10,15 45: R\$ 10,35 60: R\$ 10,56
13 cm



ALFABETO EVA 13CM LETRA O ROSA 10X1

Código: 38610 Fábrica: BRASILPAPERS Unidade: PT/10 F4

UN: R\$ 0,97 AV: R\$ 9,75 15: R\$ 9,95
30: R\$ 10,15 45: R\$ 10,35 60: R\$ 10,56
13 cm

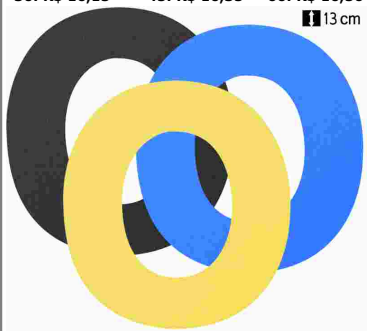

ALFABETO EVA 13CM LETRA O SORTIDO 10X1

Código: 38835 Fábrica: BRASILPAPERS Unidade: PT/10 F4

UN: R\$ 0,97 AV: R\$ 9,75 15: R\$ 9,95
30: R\$ 10,15 45: R\$ 10,35 60: R\$ 10,56
13 cm

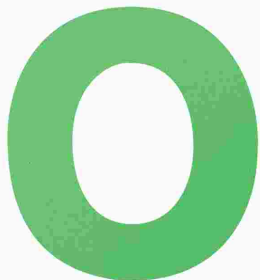

ALFABETO EVA 13CM LETRA O VERDE 10X1

Código: 38781 Fábrica: BRASILPAPERS Unidade: PT/10 F4

UN: R\$ 0,97 AV: R\$ 9,75 15: R\$ 9,95
30: R\$ 10,15 45: R\$ 10,35 60: R\$ 10,56
13 cm

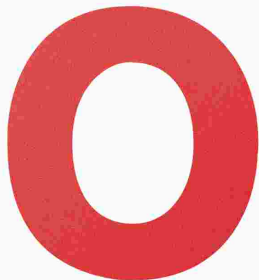

ALFABETO EVA 13CM LETRA O VERMELHO 10X1

Código: 38808 Fábrica: BRASILPAPERS Unidade: PT/10 F4

UN: R\$ 0,97 AV: R\$ 9,75 15: R\$ 9,95
30: R\$ 10,15 45: R\$ 10,35 60: R\$ 10,56
13 cm



ALFABETO EVA 13CM LETRA P AMARELO 10X1

Código: 38630 Fábrica: BRASILPAPERS Unidade: PT/10 F4

UN: R\$ 0,97 AV: R\$ 9,75 15: R\$ 9,95
30: R\$ 10,15 45: R\$ 10,35 60: R\$ 10,56
13 cm



ALFABETO EVA 13CM LETRA P AZUL 10X1

Código: 38752 Fábrica: BRASILPAPERS Unidade: PT/10 F4

UN: R\$ 0,97 AV: R\$ 9,75 15: R\$ 9,95
30: R\$ 10,15 45: R\$ 10,35 60: R\$ 10,56
13 cm



ALFABETO EVA 13CM LETRA P BRANCO 10X1

Código: 38725 Fábrica: BRASILPAPERS Unidade: PT/10 F4

UN: R\$ 0,97 AV: R\$ 9,75 15: R\$ 9,95
30: R\$ 10,15 45: R\$ 10,35 60: R\$ 10,56
13 cm



ALFABETO EVA 13CM LETRA P PRETO 10X1

Código: 38645 Fábrica: BRASILPAPERS Unidade: PT/10 F4

UN: R\$ 0,97 AV: R\$ 9,75 15: R\$ 9,95
30: R\$ 10,15 45: R\$ 10,35 60: R\$ 10,56
13 cm



ALFABETO EVA 13CM LETRA P ROSA 10X1

Código: 38611 Fábrica: BRASILPAPERS Unidade: PT/10 F4

UN: R\$ 0,97 AV: R\$ 9,75 15: R\$ 9,95
30: R\$ 10,15 45: R\$ 10,35 60: R\$ 10,56
13 cm



ALFABETO EVA 13CM LETRA P VERDE 10X1

Código: 38782 Fábrica: BRASILPAPERS Unidade: PT/10 F4

UN: R\$ 0,97 AV: R\$ 9,75 15: R\$ 9,95
30: R\$ 10,15 45: R\$ 10,35 60: R\$ 10,56
13 cm



ALFABETO EVA 13CM LETRA P VERMELHO 10X1

Código: 38809 Fábrica: BRASILPAPERS Unidade: PT/10 F4

UN: R\$ 0,97 AV: R\$ 9,75 15: R\$ 9,95
30: R\$ 10,15 45: R\$ 10,35 60: R\$ 10,56
13 cm



ALFABETO EVA 13CM LETRA Q AMARELO 10X1

Código: 38689 Fábrica: BRASILPAPERS Unidade: PT/10 F4

UN: R\$ 0,97 AV: R\$ 9,75 15: R\$ 9,95
30: R\$ 10,15 45: R\$ 10,35 60: R\$ 10,56
13 cm

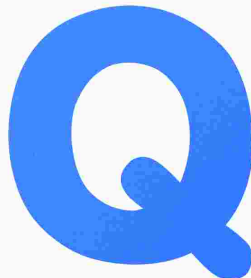

ALFABETO EVA 13CM LETRA Q AZUL 10X1

Código: 38753 Fábrica: BRASILPAPERS Unidade: PT/10 F4

UN: R\$ 0,97 AV: R\$ 9,75 15: R\$ 9,95
30: R\$ 10,15 45: R\$ 10,35 60: R\$ 10,56
13 cm



ALFABETO EVA 13CM LETRA Q BRANCO 10X1

Código: 38726 Fábrica: BRASILPAPERS Unidade: PT/10 F4

UN: R\$ 0,97 AV: R\$ 9,75 15: R\$ 9,95
30: R\$ 10,15 45: R\$ 10,35 60: R\$ 10,56
13 cm



ALFABETO EVA 13CM LETRA Q PRETO 10X1

Código: 38706 Fábrica: BRASILPAPERS Unidade: PT/10 F4

UN: R\$ 0,97 AV: R\$ 9,75 15: R\$ 9,95
30: R\$ 10,15 45: R\$ 10,35 60: R\$ 10,56
13 cm



ALFABETO EVA 13CM LETRA Q ROSA 10X1

Código: 38612 Fábrica: BRASILPAPERS Unidade: PT/10 F4

UN: R\$ 0,97 AV: R\$ 9,75 15: R\$ 9,95
30: R\$ 10,15 45: R\$ 10,35 60: R\$ 10,56
13 cm



ALFABETO EVA 13CM LETRA Q VERDE 10X1

Código: 38783 Fábrica: BRASILPAPERS Unidade: PT/10 F4

UN: R\$ 0,97 AV: R\$ 9,75 15: R\$ 9,95
30: R\$ 10,15 45: R\$ 10,35 60: R\$ 10,56
13 cm

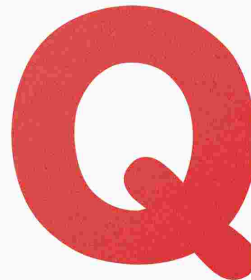

ALFABETO EVA 13CM LETRA Q VERMELHO 10X1

Código: 38810 Fábrica: BRASILPAPERS Unidade: PT/10 F4

UN: R\$ 0,97 AV: R\$ 9,75 15: R\$ 9,95
30: R\$ 10,15 45: R\$ 10,35 60: R\$ 10,56
13 cm



ALFABETO EVA 13CM LETRA R AMARELO 10X1

Código: 38631 Fábrica: BRASILPAPERS Unidade: PT/10 F4

UN: R\$ 0,97 AV: R\$ 9,75 15: R\$ 9,95
30: R\$ 10,15 45: R\$ 10,35 60: R\$ 10,56
13 cm

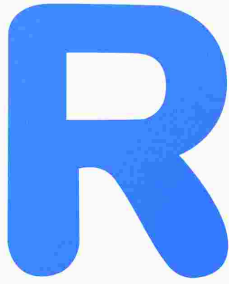

ALFABETO EVA 13CM LETRA R AZUL 10X1

Código: 38754 Fábrica: BRASILPAPERS Unidade: PT/10 F4

UN: R\$ 0,97 AV: R\$ 9,75 15: R\$ 9,95
30: R\$ 10,15 45: R\$ 10,35 60: R\$ 10,56
13 cm



ALFABETO EVA 13CM LETRA R BRANCO 10X1

Código: 38727 Fábrica: BRASILPAPERS Unidade: PT/10 F4

UN: R\$ 0,97 AV: R\$ 9,75 15: R\$ 9,95
30: R\$ 10,15 45: R\$ 10,35 60: R\$ 10,56
13 cm



ALFABETO EVA 13CM LETRA R PRETO 10X1

Código: 38646 Fábrica: BRASILPAPERS Unidade: PT/10 F4

UN: R\$ 0,97 AV: R\$ 9,75 15: R\$ 9,95
30: R\$ 10,15 45: R\$ 10,35 60: R\$ 10,56
13 cm



ALFABETO EVA 13CM LETRA R ROSA 10X1

Código: 38613 Fábrica: BRASILPAPERS Unidade: PT/10 F4

UN: R\$ 0,97 AV: R\$ 9,75 15: R\$ 9,95
30: R\$ 10,15 45: R\$ 10,35 60: R\$ 10,56
13 cm



ALFABETO EVA 13CM LETRA R VERDE 10X1

Código: 38784 Fábrica: BRASILPAPERS Unidade: PT/10 F4

UN: R\$ 0,97 AV: R\$ 9,75 15: R\$ 9,95
30: R\$ 10,15 45: R\$ 10,35 60: R\$ 10,56
13 cm



ALFABETO EVA 13CM LETRA R VERMELHO 10X1

Código: 38811 Fábrica: BRASILPAPERS Unidade: PT/10 F4

UN: R\$ 0,97 AV: R\$ 9,75 15: R\$ 9,95
30: R\$ 10,15 45: R\$ 10,35 60: R\$ 10,56
13 cm



ALFABETO EVA 13CM LETRA S AMARELO 10X1

Código: 38632 Fábrica: BRASILPAPERS Unidade: PT/10 F4

UN: R\$ 0,97 AV: R\$ 9,75 15: R\$ 9,95
30: R\$ 10,15 45: R\$ 10,35 60: R\$ 10,56
13 cm



ALFABETO EVA 13CM LETRA S AZUL 10X1

Código: 38758 Fábrica: BRASILPAPERS Unidade: PT/10 F4

UN: R\$ 0,97 AV: R\$ 9,75 15: R\$ 9,95
30: R\$ 10,15 45: R\$ 10,35 60: R\$ 10,56
13 cm



ALFABETO EVA 13CM LETRA S BRANCO 10X1

Código: 38728 Fábrica: BRASILPAPERS Unidade: PT/10 F4

UN: R\$ 0,97 AV: R\$ 9,75 15: R\$ 9,95
30: R\$ 10,15 45: R\$ 10,35 60: R\$ 10,56
13 cm



ALFABETO EVA 13CM LETRA S PRETO 10X1

Código: 38647 Fábrica: BRASILPAPERS Unidade: PT/10 F4

UN: R\$ 0,97 AV: R\$ 9,75 15: R\$ 9,95
30: R\$ 10,15 45: R\$ 10,35 60: R\$ 10,56
13 cm



ALFABETO EVA 13CM LETRA S ROSA 10X1

Código: 38614 Fábrica: BRASILPAPERS Unidade: PT/10 F4

UN: R\$ 0,97 AV: R\$ 9,75 15: R\$ 9,95
30: R\$ 10,15 45: R\$ 10,35 60: R\$ 10,56
13 cm



ALFABETO EVA 13CM LETRA S VERDE 10X1

Código: 38785 Fábrica: BRASILPAPERS Unidade: PT/10 F4

UN: R\$ 0,97 AV: R\$ 9,75 15: R\$ 9,95
30: R\$ 10,15 45: R\$ 10,35 60: R\$ 10,56
13 cm



ALFABETO EVA 13CM LETRA S VERMELHO 10X1

Código: 38812 Fábrica: BRASILPAPERS Unidade: PT/10 F4

UN: R\$ 0,97 AV: R\$ 9,75 15: R\$ 9,95
30: R\$ 10,15 45: R\$ 10,35 60: R\$ 10,56
13 cm



ALFABETO EVA 13CM LETRA T AMARELO 10X1

Código: 38690 Fábrica: BRASILPAPERS Unidade: PT/10 F4

UN: R\$ 0,97 AV: R\$ 9,75 15: R\$ 9,95
30: R\$ 10,15 45: R\$ 10,35 60: R\$ 10,56
13 cm

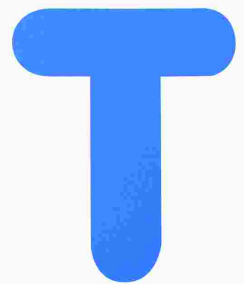

ALFABETO EVA 13CM LETRA T AZUL 10X1

Código: 38759 Fábrica: BRASILPAPERS Unidade: PT/10 F4

UN: R\$ 0,97 AV: R\$ 9,75 15: R\$ 9,95
30: R\$ 10,15 45: R\$ 10,35 60: R\$ 10,56
13 cm

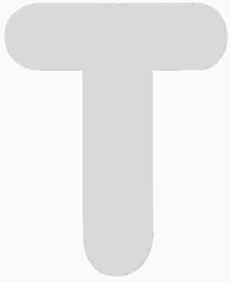

ALFABETO EVA 13CM LETRA T BRANCO 10X1
Código: 38729 Fábrica: BRASILPAPERS Unidade: PT/10 F4

UN: R\$ 0,97 AV: R\$ 9,75 15: R\$ 9,95
30: R\$ 10,15 45: R\$ 10,35 60: R\$ 10,56
13 cm

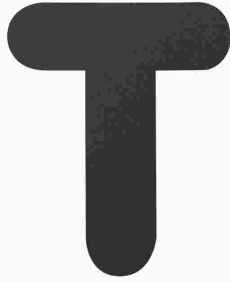

ALFABETO EVA 13CM LETRA T PRETO 10X1
Código: 38703 Fábrica: BRASILPAPERS Unidade: PT/10 F4

UN: R\$ 0,97 AV: R\$ 9,75 15: R\$ 9,95
30: R\$ 10,15 45: R\$ 10,35 60: R\$ 10,56
13 cm



ALFABETO EVA 13CM LETRA T ROSA 10X1
Código: 38615 Fábrica: BRASILPAPERS Unidade: PT/10 F4

UN: R\$ 0,97 AV: R\$ 9,75 15: R\$ 9,95
30: R\$ 10,15 45: R\$ 10,35 60: R\$ 10,56
13 cm

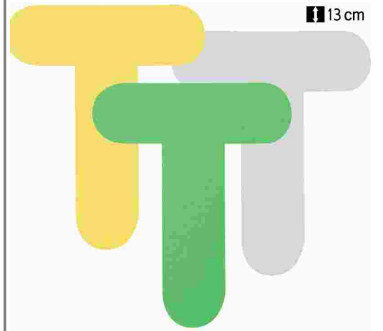

ALFABETO EVA 13CM LETRA T SORTIDO 10X1
Código: 38840 Fábrica: BRASILPAPERS Unidade: PT/10 F4

UN: R\$ 0,97 AV: R\$ 9,75 15: R\$ 9,95
30: R\$ 10,15 45: R\$ 10,35 60: R\$ 10,56
13 cm

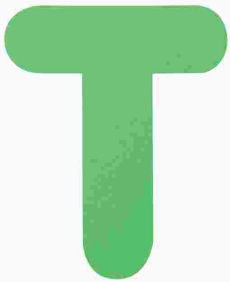

ALFABETO EVA 13CM LETRA T VERDE 10X1
Código: 38786 Fábrica: BRASILPAPERS Unidade: PT/10 F4

UN: R\$ 0,97 AV: R\$ 9,75 15: R\$ 9,95
30: R\$ 10,15 45: R\$ 10,35 60: R\$ 10,56
13 cm

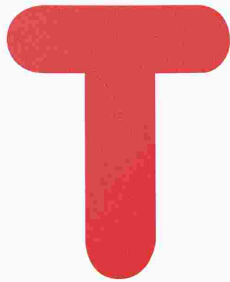

ALFABETO EVA 13CM LETRA T VERMELHO 10X1
Código: 38813 Fábrica: BRASILPAPERS Unidade: PT/10 F4

UN: R\$ 0,97 AV: R\$ 9,75 15: R\$ 9,95
30: R\$ 10,15 45: R\$ 10,35 60: R\$ 10,56
13 cm

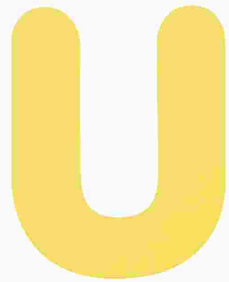

ALFABETO EVA 13CM LETRA U AMARELO 10X1
Código: 38691 Fábrica: BRASILPAPERS Unidade: PT/10 F4

UN: R\$ 0,97 AV: R\$ 9,75 15: R\$ 9,95
30: R\$ 10,15 45: R\$ 10,35 60: R\$ 10,56
13 cm

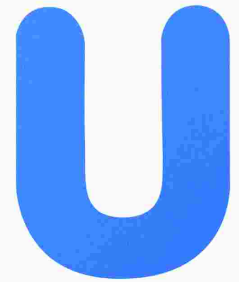

ALFABETO EVA 13CM LETRA U AZUL 10X1
Código: 38760 Fábrica: BRASILPAPERS Unidade: PT/10 F4

UN: R\$ 0,97 AV: R\$ 9,75 15: R\$ 9,95
30: R\$ 10,15 45: R\$ 10,35 60: R\$ 10,56
13 cm



ALFABETO EVA 13CM LETRA U BRANCO 10X1
Código: 38730 Fábrica: BRASILPAPERS Unidade: PT/10 F4

UN: R\$ 0,97 AV: R\$ 9,75 15: R\$ 9,95
30: R\$ 10,15 45: R\$ 10,35 60: R\$ 10,56
13 cm

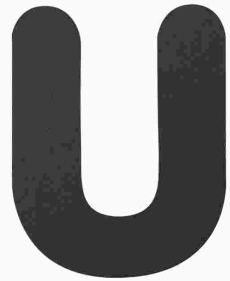

ALFABETO EVA 13CM LETRA U PRETO 10X1
Código: 38648 Fábrica: BRASILPAPERS Unidade: PT/10 F4

UN: R\$ 0,97 AV: R\$ 9,75 15: R\$ 9,95
30: R\$ 10,15 45: R\$ 10,35 60: R\$ 10,56
13 cm



ALFABETO EVA 13CM LETRA U ROSA 10X1
Código: 38616 Fábrica: BRASILPAPERS Unidade: PT/10 F4

UN: R\$ 0,97 AV: R\$ 9,75 15: R\$ 9,95
30: R\$ 10,15 45: R\$ 10,35 60: R\$ 10,56
13 cm

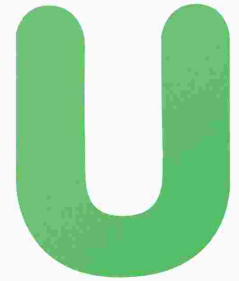

ALFABETO EVA 13CM LETRA U VERDE 10X1
Código: 38787 Fábrica: BRASILPAPERS Unidade: PT/10 F4

UN: R\$ 0,97 AV: R\$ 9,75 15: R\$ 9,95
30: R\$ 10,15 45: R\$ 10,35 60: R\$ 10,56
13 cm



ALFABETO EVA 13CM LETRA U VERMELHO 10X1
Código: 38814 Fábrica: BRASILPAPERS Unidade: PT/10 F4

UN: R\$ 0,97 AV: R\$ 9,75 15: R\$ 9,95
30: R\$ 10,15 45: R\$ 10,35 60: R\$ 10,56
13 cm



ALFABETO EVA 13CM LETRA V AMARELO 10X1
Código: 38692 Fábrica: BRASILPAPERS Unidade: PT/10 F4

UN: R\$ 0,97 AV: R\$ 9,75 15: R\$ 9,95
30: R\$ 10,15 45: R\$ 10,35 60: R\$ 10,56
13 cm



ALFABETO EVA 13CM LETRA V AZUL 10X1
Código: 38761 Fábrica: BRASILPAPERS Unidade: PT/10 F4

UN: R\$ 0,97 AV: R\$ 9,75 15: R\$ 9,95
30: R\$ 10,15 45: R\$ 10,35 60: R\$ 10,56
13 cm



ALFABETO EVA 13CM LETRA V BRANCO 10X1
Código: 38731 Fábrica: BRASILPAPERS Unidade: PT/10 F4

UN: R\$ 0,97 AV: R\$ 9,75 15: R\$ 9,95
30: R\$ 10,15 45: R\$ 10,35 60: R\$ 10,56
13 cm



ALFABETO EVA 13CM LETRA V PRETO 10X1
Código: 38707 Fábrica: BRASILPAPERS Unidade: PT/10 F4

UN: R\$ 0,97 AV: R\$ 9,75 15: R\$ 9,95
30: R\$ 10,15 45: R\$ 10,35 60: R\$ 10,56
13 cm



ALFABETO EVA 13CM LETRA V VERDE 10X1
Código: 38788 Fábrica: BRASILPAPERS Unidade: PT/10 F4

UN: R\$ 0,97 AV: R\$ 9,75 15: R\$ 9,95
30: R\$ 10,15 45: R\$ 10,35 60: R\$ 10,56
13 cm



ALFABETO EVA 13CM LETRA V VERMELHO 10X1
Código: 38815 Fábrica: BRASILPAPERS Unidade: PT/10 F4

UN: R\$ 0,97 AV: R\$ 9,75 15: R\$ 9,95
30: R\$ 10,15 45: R\$ 10,35 60: R\$ 10,56
13 cm



ALFABETO EVA 13CM LETRA W AMARELO 10X1
Código: 38693 Fábrica: BRASILPAPERS Unidade: PT/10 F4

UN: R\$ 0,97 AV: R\$ 9,75 15: R\$ 9,95
30: R\$ 10,15 45: R\$ 10,35 60: R\$ 10,56
13 cm



ALFABETO EVA 13CM LETRA W AZUL 10X1
Código: 38762 Fábrica: BRASILPAPERS Unidade: PT/10 F4

UN: R\$ 0,97 AV: R\$ 9,75 15: R\$ 9,95
30: R\$ 10,15 45: R\$ 10,35 60: R\$ 10,56
13 cm



ALFABETO EVA 13CM LETRA W BRANCO 10X1
Código: 38732 Fábrica: BRASILPAPERS Unidade: PT/10 F4

UN: R\$ 0,97 AV: R\$ 9,75 15: R\$ 9,95
30: R\$ 10,15 45: R\$ 10,35 60: R\$ 10,56
13 cm



ALFABETO EVA 13CM LETRA W PRETO 10X1
Código: 38708 Fábrica: BRASILPAPERS Unidade: PT/10 F4

UN: R\$ 0,97 AV: R\$ 9,75 15: R\$ 9,95
30: R\$ 10,15 45: R\$ 10,35 60: R\$ 10,56
13 cm



ALFABETO EVA 13CM LETRA W ROSA 10X1
Código: 38618 Fábrica: BRASILPAPERS Unidade: PT/10 F4

UN: R\$ 0,97 AV: R\$ 9,75 15: R\$ 9,95
30: R\$ 10,15 45: R\$ 10,35 60: R\$ 10,56
13 cm



ALFABETO EVA 13CM LETRA W VERDE 10X1
Código: 38792 Fábrica: BRASILPAPERS Unidade: PT/10 F4

UN: R\$ 0,97 AV: R\$ 9,75 15: R\$ 9,95
30: R\$ 10,15 45: R\$ 10,35 60: R\$ 10,56
13 cm



ALFABETO EVA 13CM LETRA X AMARELO 10X1
Código: 38694 Fábrica: BRASILPAPERS Unidade: PT/10 F4

UN: R\$ 0,97 AV: R\$ 9,75 15: R\$ 9,95
30: R\$ 10,15 45: R\$ 10,35 60: R\$ 10,56
13 cm



ALFABETO EVA 13CM LETRA X AZUL 10X1
Código: 38763 Fábrica: BRASILPAPERS Unidade: PT/10 F4

UN: R\$ 0,97 AV: R\$ 9,75 15: R\$ 9,95
30: R\$ 10,15 45: R\$ 10,35 60: R\$ 10,56
13 cm



ALFABETO EVA 13CM LETRA X BRANCO 10X1
Código: 38733 Fábrica: BRASILPAPERS Unidade: PT/10 F4

UN: R\$ 0,97 AV: R\$ 9,75 15: R\$ 9,95
30: R\$ 10,15 45: R\$ 10,35 60: R\$ 10,56
13 cm

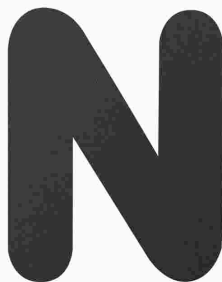

ALFABETO EVA 13CM LETRA X PRETO 10X1
Código: 38700 Fábrica: BRASILPAPERS Unidade: PT/10 F4

UN: R\$ 0,97 AV: R\$ 9,75 15: R\$ 9,95
30: R\$ 10,15 45: R\$ 10,35 60: R\$ 10,56
13 cm



ALFABETO EVA 13CM LETRA X ROSA 10X1
Código: 38619 Fábrica: BRASILPAPERS Unidade: PT/10 F4

UN: R\$ 0,97 AV: R\$ 9,75 15: R\$ 9,95
30: R\$ 10,15 45: R\$ 10,35 60: R\$ 10,56
13 cm



ALFABETO EVA 13CM LETRA X VERDE 10X1
Código: 38789 Fábrica: BRASILPAPERS Unidade: PT/10 F4

UN: R\$ 0,97 AV: R\$ 9,75 15: R\$ 9,95
30: R\$ 10,15 45: R\$ 10,35 60: R\$ 10,56
13 cm



ALFABETO EVA 13CM LETRA X VERMELHO 10X1
Código: 38816 Fábrica: BRASILPAPERS Unidade: PT/10 F4

UN: R\$ 0,97 AV: R\$ 9,75 15: R\$ 9,95
30: R\$ 10,15 45: R\$ 10,35 60: R\$ 10,56
13 cm



ALFABETO EVA 13CM LETRA Y AMARELO 10X1
Código: 38695 Fábrica: BRASILPAPERS Unidade: PT/10 F4

UN: R\$ 0,97 AV: R\$ 9,75 15: R\$ 9,95
30: R\$ 10,15 45: R\$ 10,35 60: R\$ 10,56
13 cm



ALFABETO EVA 13CM LETRA Y AZUL 10X1
Código: 38764 Fábrica: BRASILPAPERS Unidade: PT/10 F4

UN: R\$ 0,97 AV: R\$ 9,75 15: R\$ 9,95
30: R\$ 10,15 45: R\$ 10,35 60: R\$ 10,56
13 cm



ALFABETO EVA 13CM LETRA Y BRANCO 10X1
Código: 38734 Fábrica: BRASILPAPERS Unidade: PT/10 F4

UN: R\$ 0,97 AV: R\$ 9,75 15: R\$ 9,95
30: R\$ 10,15 45: R\$ 10,35 60: R\$ 10,56
13 cm



ALFABETO EVA 13CM LETRA Y PRETO 10X1
Código: 38705 Fábrica: BRASILPAPERS Unidade: PT/10 F4

UN: R\$ 0,97 AV: R\$ 9,75 15: R\$ 9,95
30: R\$ 10,15 45: R\$ 10,35 60: R\$ 10,56
13 cm



ALFABETO EVA 13CM LETRA Y VERDE 10X1
Código: 38790 Fábrica: BRASILPAPERS Unidade: PT/10 F4

UN: R\$ 0,97 AV: R\$ 9,75 15: R\$ 9,95
30: R\$ 10,15 45: R\$ 10,35 60: R\$ 10,56
13 cm



ALFABETO EVA 13CM LETRA Y VERMELHO 10X1
Código: 38819 Fábrica: BRASILPAPERS Unidade: PT/10 F4

UN: R\$ 0,97 AV: R\$ 9,75 15: R\$ 9,95
30: R\$ 10,15 45: R\$ 10,35 60: R\$ 10,56
13 cm



ALFABETO EVA 13CM LETRA Z AMARELO 10X1
Código: 38696 Fábrica: BRASILPAPERS Unidade: PT/10 F4

UN: R\$ 0,97 AV: R\$ 9,75 15: R\$ 9,95
30: R\$ 10,15 45: R\$ 10,35 60: R\$ 10,56
13 cm



ALFABETO EVA 13CM LETRA Z AZUL 10X1
Código: 38765 Fábrica: BRASILPAPERS Unidade: PT/10 F4

UN: R\$ 0,97 AV: R\$ 9,75 15: R\$ 9,95
30: R\$ 10,15 45: R\$ 10,35 60: R\$ 10,56
13 cm



ALFABETO EVA 13CM LETRA Z BRANCO 10X1
Código: 38735 Fábrica: BRASILPAPERS Unidade: PT/10 F4

UN: R\$ 0,97 AV: R\$ 9,75 15: R\$ 9,95
30: R\$ 10,15 45: R\$ 10,35 60: R\$ 10,56
13 cm



ALFABETO EVA 13CM LETRA Z PRETO 10X1
Código: 38701 Fábrica: BRASILPAPERS Unidade: PT/10 F4

UN: R\$ 0,97 AV: R\$ 9,75 15: R\$ 9,95
30: R\$ 10,15 45: R\$ 10,35 60: R\$ 10,56
13 cm



ALFABETO EVA 13CM LETRA Z ROSA 10X1
Código: 38621 Fábrica: BRASILPAPERS Unidade: PT/10 F4

UN: R\$ 0,97 AV: R\$ 9,75 15: R\$ 9,95
30: R\$ 10,15 45: R\$ 10,35 60: R\$ 10,56
13 cm



ALFABETO EVA 13CM LETRA Z SORTIDO 10X1
Código: 38846 Fábrica: BRASILPAPERS Unidade: PT/10 F4

UN: R\$ 0,97 AV: R\$ 9,75 15: R\$ 9,95
30: R\$ 10,15 45: R\$ 10,35 60: R\$ 10,56
13 cm



ALFABETO EVA 13CM LETRA Z VERDE 10X1
Código: 38791 Fábrica: BRASILPAPERS Unidade: PT/10 F4

UN: R\$ 0,97 AV: R\$ 9,75 15: R\$ 9,95
30: R\$ 10,15 45: R\$ 10,35 60: R\$ 10,56
13 cm



ALFABETO EVA 13CM LETRA Z VERMELHO 10X1
Código: 38817 Fábrica: BRASILPAPERS Unidade: PT/10 F4

UN: R\$ 7,52 AV: R\$ 7,52 15: R\$ 7,68
30: R\$ 7,83 45: R\$ 7,99 60: R\$ 8,15



ALMOFADA CARIMBO N3 S/TINTA 105X64MM 168
Código: 45069 Fábrica: CARBRINK Unidade: UN/1 F1 F4

UN: R\$ 6,97 AV: R\$ 6,97 15: R\$ 7,12
30: R\$ 7,26 45: R\$ 7,41 60: R\$ 7,56



ALMOFADA P/CARIMBO N2 PRETA ENTINTADA
Código: 41963 Fábrica: CARBRINK Unidade: UN/1 F1 F4

UN: R\$ 8,83 AV: R\$ 8,83 15: R\$ 9,02
30: R\$ 9,20 45: R\$ 9,38 60: R\$ 9,57



ALMOFADA P/CARIMBO N3 AZUL ENTINTADA
Código: Fábrika: Unidade:
10460 CARBRINK UN/1
F1 F4

UN: R\$ 7,88 AV: R\$ 7,88 15: R\$ 8,04
30: R\$ 8,20 45: R\$ 8,37 60: R\$ 8,54



ALMOFADA P/CARIMBO N3 AZUL TPA METAL 772
Código: Fábrika: Unidade:
23964 MASTERPRINT UN/1
F1 F4

UN: R\$ 8,83 AV: R\$ 8,83 15: R\$ 9,02
30: R\$ 9,20 45: R\$ 9,38 60: R\$ 9,57



ALMOFADA P/CARIMBO N3 PRETA ENTINTADA
Código: Fábrika: Unidade:
15529 CARBRINK UN/1
F1 F4

UN: R\$ 7,88 AV: R\$ 7,88 15: R\$ 8,04
30: R\$ 8,20 45: R\$ 8,37 60: R\$ 8,54



ALMOFADA P/CARIMBO N3 PRETO TPA METAL 773
Código: Fábrika: Unidade:
41732 MASTERPRINT UN/1
F1 F4

UN: R\$ 8,83 AV: R\$ 8,83 15: R\$ 9,02
30: R\$ 9,20 45: R\$ 9,38 60: R\$ 9,57



ALMOFADA P/CARIMBO N3 VERM ENTINTADA
Código: Fábrika: Unidade:
41801 CARBRINK UN/1
F1 F4

UN: R\$ 7,88 AV: R\$ 7,88 15: R\$ 8,04
30: R\$ 8,20 45: R\$ 8,37 60: R\$ 8,54



ALMOFADA P/CARIMBO N3 VERM TPA METAL 774
Código: Fábrika: Unidade:
41733 MASTERPRINT UN/1
F1 F4

UN: R\$ 5,34 AV: R\$ 5,34 15: R\$ 5,45
30: R\$ 5,56 45: R\$ 5,67 60: R\$ 5,79



ALMOFADA P/CARIMBO N3 VERMELHA ENTINTADA
Código: Fábrika: Unidade:
6792 RADEX UN/1
F1 F4

UN: R\$ 15,40 AV: R\$ 15,40 15: R\$ 15,72
30: R\$ 16,03 45: R\$ 16,35 60: R\$ 16,68



ALMOFADA P/CARIMBO N4 AZUL ENTINTADA 173
Código: Fábrika: Unidade:
42250 CARBRINK UN/1
F1 F4

UN: R\$ 15,40 AV: R\$ 15,40 15: R\$ 15,72
30: R\$ 16,03 45: R\$ 16,35 60: R\$ 16,68



ALMOFADA P/CARIMBO N4 PRETA ENTINTADA 74
Código: Fábrika: Unidade:
41964 CARBRINK UN/1
F1 F4

UN: R\$ 11,98 AV: R\$ 143,80 15: R\$ 146,79
30: R\$ 149,73 45: R\$ 152,72 60: R\$ 155,78



ANILINA ALCOOL 4GRS SORTIDO 12X1
Código: Fábrika: Unidade:
45520 GLIART DZ/12
F1 F4

UN: R\$ 5,13 AV: R\$ 5,13 15: R\$ 5,23
30: R\$ 5,34 45: R\$ 5,44 60: R\$ 5,55



APAGADOR P/QUADRO BCO ANATOMICO EVA 331
Código: Fábrika: Unidade:
45632 CORTIARTE UN/1
F1 F4

UN: R\$ 6,67 AV: R\$ 6,67 15: R\$ 6,81
30: R\$ 6,94 45: R\$ 7,08 60: R\$ 7,22



APAGADOR P/QUADRO BRANCO C/DEP P/MAR 469
Código: Fábrika: Unidade:
41804 CARBRINK UN/1
F1 F4

UN: R\$ 6,52 AV: R\$ 6,52 15: R\$ 6,66
30: R\$ 6,79 45: R\$ 6,93 60: R\$ 7,07



APAGADOR P/QUADRO BRANCO C/IMA 3100
Código: Fábrika: Unidade:
44127 MASTERPRINT UN/1
F1 F4

UN: R\$ 41,06 AV: R\$ 41,06 15: R\$ 41,91
30: R\$ 42,75 45: R\$ 43,61 60: R\$ 44,48



APAGADOR P/QUADRO BRANCO C/2 MARCADORES
Código: Fábrika: Unidade:
48222 ROKE KI/1
F1 F4

UN: R\$ 34,96 AV: R\$ 34,96 15: R\$ 34,96
30: R\$ 34,96 45: R\$ 34,96 60: R\$ 34,96



APAGADOR P/QUADRO BRANCO C/4 MARCADORES
Código: Fábrika: Unidade:
46413 KAZ KI/1
F1 F4

UN: R\$ 13,82 AV: R\$ 13,82 15: R\$ 14,10
30: R\$ 14,39 45: R\$ 14,67 60: R\$ 14,97



APAGADOR P/QUADRO BRANCO FLIP TOP 102
Código: Fábrika: Unidade:
43193 BRW UN/1
F1 F4

UN: R\$ 6,52 AV: R\$ 6,52 15: R\$ 6,66
30: R\$ 6,79 45: R\$ 6,93 60: R\$ 7,07



APAGADOR P/QUADRO BRANCO MAGNETICO AZUL

Código: Fábrika: Unidade:
11221 BRW UN/1
F1 F4

UN: R\$ 6,15 AV: R\$ 6,15 15: R\$ 6,28
30: R\$ 6,41 45: R\$ 6,53 60: R\$ 6,67



APAGADOR P/QUADRO BRANCO 468/470

Código: Fábrika: Unidade:
41805 CARBRINK UN/1
F1 F4

UN: R\$ 9,23 AV: R\$ 9,23 15: R\$ 9,43
30: R\$ 9,62 45: R\$ 9,81 60: R\$ 10,00



APAGADOR P/QUADRO C/SUPOORTE VERDE 8189

Código: Fábrika: Unidade:
11222 SOUZA/STALO UN/1
F1 F4

UN: R\$ 8,72 AV: R\$ 8,72 15: R\$ 8,90
30: R\$ 9,08 45: R\$ 9,26 60: R\$ 9,45



APAGADOR P/QUADRO MAD C/DEPOSITO 324

Código: Fábrika: Unidade:
45631 CORTIARTE UN/1
F1 F4

UN: R\$ 2,62 AV: R\$ 2,62 15: R\$ 2,67
30: R\$ 2,73 45: R\$ 2,78 60: R\$ 2,84



APAGADOR P/QUADRO MADEIRA 320

Código: Fábrika: Unidade:
6835 CORTIARTE UN/1
F1 F4

UN: R\$ 1,24 AV: R\$ 29,78 15: R\$ 30,40
30: R\$ 31,01 45: R\$ 31,63 60: R\$ 32,26



APONTADOR C/DEP BLOCO 6CM 4531 24X1

Código: Fábrika: Unidade:
9579 LEO&LEO CX/24
F1 F4

UN: R\$ 3,69 AV: R\$ 3,69 15: R\$ 3,76
30: R\$ 3,84 45: R\$ 3,92 60: R\$ 3,99



APONTADOR C/DEP C/BORRACHA HONGSI

Código: Fábrika: Unidade:
40910 TRIS UN/1
F1 F4

UN: R\$ 1,84 AV: R\$ 22,08 15: R\$ 22,54
30: R\$ 23,00 45: R\$ 23,46 60: R\$ 23,92



APONTADOR C/DEP CESTINHA DUPLA 4568 12X1

Código: Fábrika: Unidade:
40914 LEO&LEO CX/12
F1 F4

UN: R\$ 2,57 AV: R\$ 30,82 15: R\$ 31,46
30: R\$ 32,09 45: R\$ 32,73 60: R\$ 33,38



APONTADOR C/DEP CILINDR METAL BETTY 12X1

Código: Fábrika: Unidade:
38550 SUMMIT CX/12
F4

UN: R\$ 0,86 AV: R\$ 20,53 15: R\$ 20,96
30: R\$ 21,38 45: R\$ 21,81 60: R\$ 22,24



APONTADOR C/DEP CORCAO HANNAH MONT 24X1

Código: Fábrika: Unidade:
38549 TRIS CX/24
F1 F4

UN: R\$ 4,10 AV: R\$ 4,10 15: R\$ 4,18
30: R\$ 4,27 45: R\$ 4,35 60: R\$ 4,44



APONTADOR C/DEP DUPLA LOL SURPRISE 3060

Código: Fábrika: Unidade:
41614 LOL UN/1
F4

UN: R\$ 2,80 AV: R\$ 33,56 15: R\$ 34,26
30: R\$ 34,94 45: R\$ 35,64 60: R\$ 36,35



APONTADOR C/DEP OVAL DUPLA 12X1

Código: Fábrika: Unidade:
49268 COLORARE CX/12
F1 F4

UN: R\$ 2,40 AV: R\$ 28,75 15: R\$ 29,35
30: R\$ 29,94 45: R\$ 30,54 60: R\$ 31,15



APONTADOR C/DEP OVAL DUPLA 4534 12X1

Código: Fábrika: Unidade:
41613 LEO&LEO CX/12
F1 F4

UN: R\$ 2,65 AV: R\$ 2,65 15: R\$ 2,71
30: R\$ 2,76 45: R\$ 2,81 60: R\$ 2,87



APONTADOR C/DEP OVAL DUPLA 4752 SOLAPA

Código: Fábrika: Unidade:
47390 LEO&LEO UN/1
F1 F4

UN: R\$ 2,40 AV: R\$ 28,81 15: R\$ 29,41
30: R\$ 30,00 45: R\$ 30,60 60: R\$ 31,21



APONTADOR C/DEP OVAL DUPLA 903891 12X1

Código: Fábrika: Unidade:
49942 BAZZE CX/12
F1 F4

UN: R\$ 2,89 AV: R\$ 34,67 15: R\$ 35,39
30: R\$ 36,10 45: R\$ 36,82 60: R\$ 37,56



APONTADOR C/DEP OVAL PLAST 2005 12X1

Código: Fábrika: Unidade:
21472 BRW CX/12
F1 F4

UN: R\$ 2,46 AV: R\$ 58,98 15: R\$ 60,21
30: R\$ 61,41 45: R\$ 62,64 60: R\$ 63,90



APONTADOR C/DEP OVAL 5CM 2003 24X1
Código: 47014 Fábrica: BRW Unidade: CX/24 F1 F4

UN: R\$ 0,99 AV: R\$ 47,61 15: R\$ 48,60
30: R\$ 49,57 45: R\$ 50,57 60: R\$ 51,58



APONTADOR C/DEP PLAST QUAD 1207 48X1
Código: 46751 Fábrica: MASTERPRINT Unidade: CX/48 F1 F4

UN: R\$ 1,11 AV: R\$ 26,58 15: R\$ 27,14
30: R\$ 27,68 45: R\$ 28,23 60: R\$ 28,80



APONTADOR C/DEP PLAST RET 1208 24X1
Código: 49274 Fábrica: MASTERPRINT Unidade: CX/24 F1 F4

UN: R\$ 1,07 AV: R\$ 25,65 15: R\$ 26,18
30: R\$ 26,71 45: R\$ 27,24 60: R\$ 27,79



APONTADOR C/DEP RET BLOCO 4CM 040 24X1
Código: 49265 Fábrica: COLORARE Unidade: CX/24 F1 F4

UN: R\$ 1,20 AV: R\$ 28,75 15: R\$ 29,35
30: R\$ 29,94 45: R\$ 30,54 60: R\$ 31,15



APONTADOR C/DEP RETANG HIGH SCHOOL 24X1
Código: 21140 Fábrica: TRIS Unidade: CX/24 F1 F4

UN: R\$ 61,62 AV: R\$ 61,62 15: R\$ 62,91
30: R\$ 64,16 45: R\$ 65,45 60: R\$ 66,76



APONTADOR ELETRIC AUTOMAT PILHA AA 245
Código: 46741 Fábrica: KAZ Unidade: UN/1 F1 F4

UN: R\$ 1,11 AV: R\$ 26,70 15: R\$ 27,25
30: R\$ 27,80 45: R\$ 28,35 60: R\$ 28,92



APONTADOR METAL RET CLASSICO 4207 24X1
Código: 44243 Fábrica: LEO&LEO Unidade: CX/24 F1 F4

UN: R\$ 1,62 AV: R\$ 38,83 15: R\$ 39,64
30: R\$ 40,43 45: R\$ 41,24 60: R\$ 42,06



APONTADOR METAL RET SIMPLES 4209 24X1
Código: 6557 Fábrica: LEO&LEO Unidade: CX/24 F1 F4

UN: R\$ 1,03 AV: R\$ 24,64 15: R\$ 25,16
30: R\$ 25,66 45: R\$ 26,17 60: R\$ 26,70



APONTADOR METAL RET 20026 24X1
Código: 50684 Fábrica: WINPAPER Unidade: CX/24 F1 F4

UN: R\$ 1,03 AV: R\$ 20,54 15: R\$ 20,97
30: R\$ 21,39 45: R\$ 21,82 60: R\$ 22,26



APONTADOR METAL 5579 20X1
Código: 14682 Fábrica: GOLLER Unidade: CX/20 F1 F4

UN: R\$ 0,58 AV: R\$ 13,97 15: R\$ 14,26
30: R\$ 14,55 45: R\$ 14,84 60: R\$ 15,13



APONTADOR PLAST C/DEP MINI 4540 24X1
Código: 42143 Fábrica: LEO&LEO Unidade: CX/24 F1 F4

UN: R\$ 7,69 AV: R\$ 7,69 15: R\$ 7,85
30: R\$ 8,01 45: R\$ 8,17 60: R\$ 8,33



APONTADOR PLAST MANIVELA MANUAL 20207
Código: 44750 Fábrica: WIN PAPER Unidade: UN/1 F1 F4

UN: R\$ 0,40 AV: R\$ 9,60 15: R\$ 9,80
30: R\$ 10,00 45: R\$ 10,20 60: R\$ 10,40



APONTADOR RED SIMPLES 0322 24X1
Código: 42594 Fábrica: LEO&LEO Unidade: CX/24 F1 F4

UN: R\$ 0,30 AV: R\$ 7,18 15: R\$ 7,33
30: R\$ 7,48 45: R\$ 7,63 60: R\$ 7,78



APONTADOR RET SIMPLES 10400 24X1
Código: 29998 Fábrica: GATTE Unidade: CX/24 F1 F4

UN: R\$ 0,30 AV: R\$ 7,18 15: R\$ 7,33
30: R\$ 7,48 45: R\$ 7,63 60: R\$ 7,78



APONTADOR RET SIMPLES 4529 24X1
Código: 40918 Fábrica: LEO&LEO Unidade: CX/24 F1 F4

UN: R\$ 0,41 AV: R\$ 41,08 15: R\$ 41,93
30: R\$ 42,77 45: R\$ 43,63 60: R\$ 44,50



APONTADOR RETANGULAR PLAST 1203 100X1
Código: 21138 Fábrica: BRW Unidade: PT/100 F1 F4

UN: R\$ 0,21 AV: R\$ 21,06 15: R\$ 21,50
30: R\$ 21,93 45: R\$ 22,36 60: R\$ 22,81

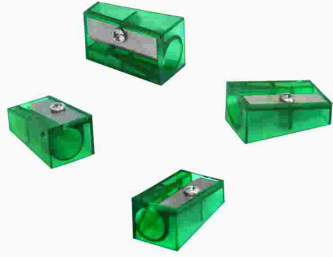

APONTADOR TRIANGULO RETANG PLAST 100X1

Código: Fábrica: Unidade:
37997 FELE PT/100
F1 F4

UN: R\$ 17,21 AV: R\$ 17,21 15: R\$ 17,56
30: R\$ 17,92 45: R\$ 18,27 60: R\$ 18,64



AREIA MAGICA CORES 200 GRS MASSA UN

Código: Fábrica: Unidade:
43024 ACRILEX UN/1
F1 F4

UN: R\$ 39,02 AV: R\$ 39,02 15: R\$ 39,84
30: R\$ 40,63 45: R\$ 41,45 60: R\$ 42,27



AREIA MAGICA 550 GRS 101 VERDE

Código: Fábrica: Unidade:
44847 ACRILEX UN/1
F1 F4

UN: R\$ 39,02 AV: R\$ 39,02 15: R\$ 39,84
30: R\$ 40,63 45: R\$ 41,45 60: R\$ 42,27



AREIA MAGICA 550 GRS 105 LARANJA

Código: Fábrica: Unidade:
44848 ACRILEX UN/1
F1 F4

UN: R\$ 39,02 AV: R\$ 39,02 15: R\$ 39,84
30: R\$ 40,63 45: R\$ 41,45 60: R\$ 42,27



AREIA MAGICA 550 GRS 106 ROXO

Código: Fábrica: Unidade:
44850 ACRILEX UN/1
F1 F4

UN: R\$ 39,02 AV: R\$ 39,02 15: R\$ 39,84
30: R\$ 40,63 45: R\$ 41,45 60: R\$ 42,27



AREIA MAGICA 550 GRS 107 ROSA MARAVILHA

Código: Fábrica: Unidade:
44849 ACRILEX UN/1
F1 F4

UN: R\$ 39,02 AV: R\$ 39,02 15: R\$ 39,84
30: R\$ 40,63 45: R\$ 41,45 60: R\$ 42,27



AREIA MAGICA 550 GRS 109 AZUL

Código: Fábrica: Unidade:
44846 ACRILEX UN/1
F1 F4

UN: R\$ 9,23 AV: R\$ 9,23 15: R\$ 9,43
30: R\$ 9,62 45: R\$ 9,81 60: R\$ 10,00



AVENTAL INF C/BOLSO ARCO IRI 49,5X39,5CM

Código: Fábrica: Unidade:
41704 LEO&LEO UN/1
F1 F4

UN: R\$ 10,26 AV: R\$ 10,26 15: R\$ 10,48
30: R\$ 10,69 45: R\$ 10,90 60: R\$ 11,12



AVENTAL INF C/BOLSO CRISTAL 49,5X39,5CM

Código: Fábrica: Unidade:
41693 LEO&LEO UN/1
F1 F4

UN: R\$ 10,26 AV: R\$ 10,26 15: R\$ 10,48
30: R\$ 10,69 45: R\$ 10,90 60: R\$ 11,12



AVENTAL INF C/BOLSO DINO 49,5X39,5CM

Código: Fábrica: Unidade:
46356 LEO&LEO UN/1
F1 F4

UN: R\$ 10,26 AV: R\$ 10,26 15: R\$ 10,48
30: R\$ 10,69 45: R\$ 10,90 60: R\$ 11,12



AVENTAL INF C/BOLSO FUND MAR 49,5X39,5CM

Código: Fábrica: Unidade:
46355 LEO&LEO UN/1
F1 F4

UN: R\$ 11,60 AV: R\$ 11,60 15: R\$ 11,84
30: R\$ 12,08 45: R\$ 12,32 60: R\$ 12,56



AVENTAL INF C/BOLSO JOY 48X39,5CM 79644

Código: Fábrica: Unidade:
46354 LEO&LEO UN/1
F1 F4

UN: R\$ 10,73 AV: R\$ 10,73 15: R\$ 10,96
30: R\$ 11,18 45: R\$ 11,40 60: R\$ 11,63



AVENTAL INF ESC AZUL 40X45CM 10214AZ

Código: Fábrica: Unidade:
46107 ACP UN/1
F1 F4

UN: R\$ 10,73 AV: R\$ 10,73 15: R\$ 10,96
30: R\$ 11,18 45: R\$ 11,40 60: R\$ 11,63



AVENTAL INF ESC CRISTAL 40X45CM 10214CR

Código: Fábrica: Unidade:
46105 ACP UN/1
F1 F4

UN: R\$ 10,73 AV: R\$ 10,73 15: R\$ 10,96
30: R\$ 11,18 45: R\$ 11,40 60: R\$ 11,63



AVENTAL INF ESC ROSA 41X46CM 10214RS

Código: Fábrica: Unidade:
46106 ACP UN/1
F1 F4

UN: R\$ 6,08 AV: R\$ 6,08 15: R\$ 6,21
30: R\$ 6,33 45: R\$ 6,46 60: R\$ 6,59



AVENTAL INF NYLON PP 34X47CM EST/LISO 20

Código: Fábrica: Unidade:
49682 MARIO BRITO UN/1
F1 F4

UN: R\$ 12,11 AV: R\$ 12,11 15: R\$ 12,36
30: R\$ 12,61 45: R\$ 12,86 60: R\$ 13,12



BASE ACRILICA ARTESANATO 120 ML 3412
Código: Fábrica: Unidade:
44815 ACRILEX UN/1
F1 F4

UN: R\$ 22,00 AV: R\$ 22,00 15: R\$ 22,46
30: R\$ 22,91 45: R\$ 23,37 60: R\$ 23,84



BASE ACRILICA ARTESANATO 250 ML 3425
Código: Fábrica: Unidade:
44816 ACRILEX UN/1
F1 F4

UN: R\$ 1,90 AV: R\$ 38,00 15: R\$ 38,79
30: R\$ 39,56 45: R\$ 40,35 60: R\$ 41,16

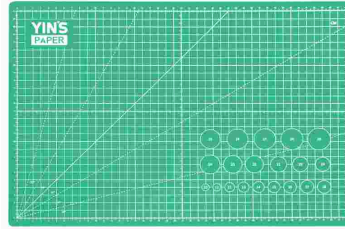

BASE DE CORTE A3 DUPLA FACE 7856
Código: Fábrica: Unidade:
48346 YIN'S PAPER PT/20
F1 F4

UN: R\$ 14,37 AV: R\$ 14,37 15: R\$ 14,67
30: R\$ 14,96 45: R\$ 15,26 60: R\$ 15,57



BETUME 100 ML 15810
Código: Fábrica: Unidade:
44818 ACRILEX UN/1
F1 F4

UN: R\$ 33,89 AV: R\$ 33,89 15: R\$ 34,59
30: R\$ 35,29 45: R\$ 35,99 60: R\$ 36,71

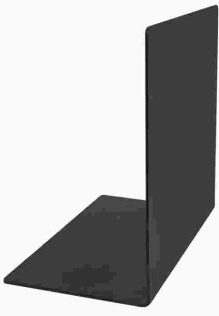

BIBLIO CANTO L METAL 2X1
Código: Fábrica: Unidade:
49526 CARBRINK PT/1
F1 F4

UN: R\$ 17,46 AV: R\$ 34,91 15: R\$ 35,64
30: R\$ 36,35 45: R\$ 37,08 60: R\$ 37,82

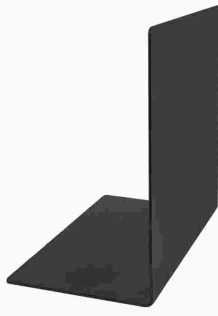

BIBLIO CANTO L 684 2X1
Código: Fábrica: Unidade:
45502 ACRINIL PT/2
F1 F4

UN: R\$ 30,81 AV: R\$ 30,81 15: R\$ 31,45
30: R\$ 32,08 45: R\$ 32,72 60: R\$ 33,37



BLOCO ANOT C/CANETA 13X18,5CM 80FLS 2155
Código: Fábrica: Unidade:
43779 WIN PAPER UN/1
F1 F4

UN: R\$ 48,27 AV: R\$ 48,27 15: R\$ 49,27
30: R\$ 50,26 45: R\$ 51,26 60: R\$ 52,29



BLOCO AQUARELA A3 300GR 12 FLS FILIART
Código: Fábrica: Unidade:
50267 USAPEL PT/1
F1 F4

UN: R\$ 4,91 AV: R\$ 29,48 15: R\$ 30,09
30: R\$ 30,69 45: R\$ 31,31 60: R\$ 31,93



BLOCO BINGO PQ 100 CARTELAS 1 A 75 6X1
Código: Fábrica: Unidade:
12544 PARRKE PT/6
F1 F4

UN: R\$ 3,66 AV: R\$ 3,66 15: R\$ 3,74
30: R\$ 3,81 45: R\$ 3,89 60: R\$ 3,97



BLOCO CD ANOT 120F 7,3X7,4CM 1117
Código: Fábrica: Unidade:
44799 WIN PAPER UN/1
F1 F4

UN: R\$ 2,98 AV: R\$ 2,98 15: R\$ 3,04
30: R\$ 3,10 45: R\$ 3,16 60: R\$ 3,23



BLOCO P/ANOTACOES S/P 100X138SERR 50FLS
Código: Fábrica: Unidade:
42696 PARRKE UN/1
F1 F4

UN: R\$ 10,62 AV: R\$ 106,15 15: R\$ 108,36
30: R\$ 110,53 45: R\$ 112,74 60: R\$ 115,00



BLOCO PAPEL A4 MILIMETRADO 50FLS 10X1
Código: Fábrica: Unidade:
17969 PARRKE PT/10
F1 F4

UN: R\$ 8,73 AV: R\$ 87,28 15: R\$ 89,10
30: R\$ 90,88 45: R\$ 92,70 60: R\$ 94,55



BLOCO PAPEL QUADRICULADO A4 50FLS 10X1
Código: Fábrica: Unidade:
14424 PARRKE PT/10
F1 F4

UN: R\$ 5,66 AV: R\$ 56,62 15: R\$ 57,80
30: R\$ 58,96 45: R\$ 60,14 60: R\$ 61,34



BLOCO PAUTADO GDE 1/9 S/COPIA 50FL 10X1
Código: Fábrica: Unidade:
21417 PARRKE PT/10
F1 F4

UN: R\$ 4,40 AV: R\$ 88,09 15: R\$ 89,93
30: R\$ 91,73 45: R\$ 93,56 60: R\$ 95,43



BLOCO PAUTADO PEQ 1/18 S/COPIA 50FL 20X1
Código: Fábrica: Unidade:
21570 PARRKE PT/20
F1 F4

UN: R\$ 0,99 AV: R\$ 39,52 15: R\$ 40,34
30: R\$ 41,15 45: R\$ 41,97 60: R\$ 42,81



BLOCO RASCUNHO 7X10CM 50FLS 40X1
Código: Fábrica: Unidade:
17971 PARRKE PT/40
F1 F4

UN: R\$ 2,36 AV: R\$ 47,17 15: R\$ 48,16
30: R\$ 49,12 45: R\$ 50,10 60: R\$ 51,10



BLOCO RASCUNHO 10X15CM 50FLS 20X1

Código: Fábrika: Unidade:
17970 PARRKE PT/20
F1 F4

UN: R\$ 0,03 AV: R\$ 17,40 15: R\$ 17,76
30: R\$ 18,12 45: R\$ 18,48 60: R\$ 18,85



BLOCO RECADOS 76X76MM 500X1

Código: Fábrika: Unidade:
46250 IMPORIENTE CX/500
F1 F4

UN: R\$ 9,93 AV: R\$ 297,88 15: R\$ 304,08
30: R\$ 310,17 45: R\$ 316,37 60: R\$ 322,70

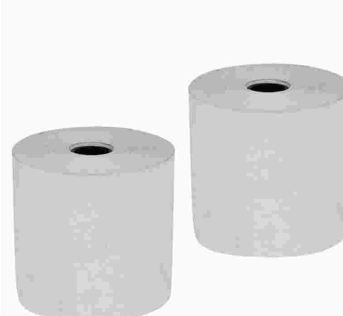

BOBINA CALCULADORA 57MM 22MTS 2VIAS 30X1

Código: Fábrika: Unidade:
29191 PRIMUS CX/30
F1 F4

UN: R\$ 2,74 AV: R\$ 82,17 15: R\$ 83,88
30: R\$ 85,56 45: R\$ 87,27 60: R\$ 89,01



BOBINA CALCULADORA 57MM 30MTS 1VIA 30X1

Código: Fábrika: Unidade:
21580 PRIMUS CX/30
F1 F4

UN: R\$ 20,66 AV: R\$ 20,66 15: R\$ 21,09
30: R\$ 21,51 45: R\$ 21,94 60: R\$ 22,38



BOBINA FAX 30 MTS

Código: Fábrika: Unidade:
26060 PRIMUS RL/1
F1 F4

UN: R\$ 5,14 AV: R\$ 154,07 15: R\$ 157,28
30: R\$ 160,43 45: R\$ 163,63 60: R\$ 166,91



BOBINA TERMICA 57MMX30M 1VIA 30X1

Código: Fábrika: Unidade:
27782 PRIMUS CX/30
F1 F4

UN: R\$ 50,32 AV: R\$ 50,32 15: R\$ 51,37
30: R\$ 52,40 45: R\$ 53,45 60: R\$ 54,52



BOBINA TERMICA 57MMX300M 1VIA BRANCA

Código: Fábrika: Unidade:
29790 PRIMUS UN/1
F1 F4

UN: R\$ 5,78 AV: R\$ 173,31 15: R\$ 176,92
30: R\$ 180,46 45: R\$ 184,07 60: R\$ 187,75



BOBINA TERMICA 57MMX40M 1VIA 30X1

Código: Fábrika: Unidade:
50249 PRIMUS CX/30
F1 F4

UN: R\$ 6,15 AV: R\$ 6,15 15: R\$ 6,28
30: R\$ 6,41 45: R\$ 6,53 60: R\$ 6,67



BOBINA TERMICA 79MM UN

Código: Fábrika: Unidade:
42947 PRIMUS UN/1
F1 F4

UN: R\$ 5,96 AV: R\$ 178,94 15: R\$ 182,67
30: R\$ 186,32 45: R\$ 190,05 60: R\$ 193,85

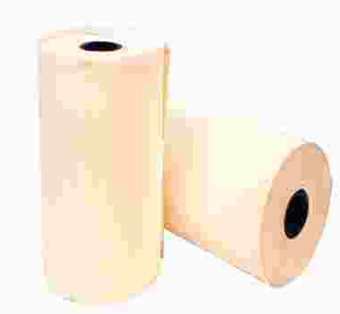

BOBINA TERMICA 79MMX30M 1VIA 30X1

Código: Fábrika: Unidade:
27758 CLEAR/PRIMUS CX/30
F1 F4

UN: R\$ 0,30 AV: R\$ 59,53 15: R\$ 60,77
30: R\$ 61,98 45: R\$ 63,22 60: R\$ 64,49

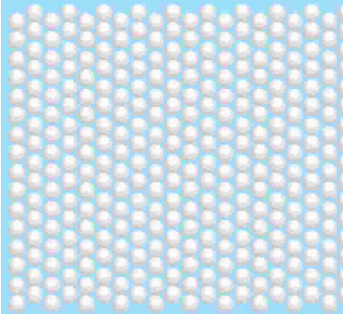

BOLA ISOPOR MOLD EPS DIAM 8MM 200X1

Código: Fábrika: Unidade:
48276 ISOMAX PT/200
F1 F4

UN: R\$ 0,22 AV: R\$ 43,13 15: R\$ 44,03
30: R\$ 44,91 45: R\$ 45,81 60: R\$ 46,73

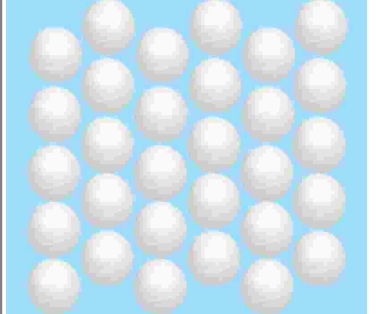

BOLA ISOPOR MOLD EPS DIAM 15MM 200X1

Código: Fábrika: Unidade:
48275 ISOMAX PT/200
F1 F4

UN: R\$ 0,49 AV: R\$ 49,30 15: R\$ 50,32
30: R\$ 51,33 45: R\$ 52,36 60: R\$ 53,40

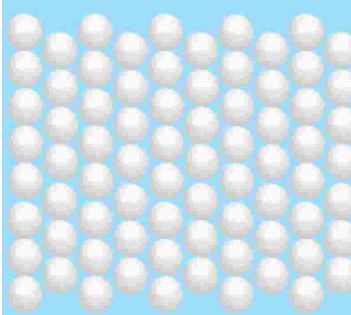

BOLA ISOPOR MOLD EPS DIAM 20MM 100X1

Código: Fábrika: Unidade:
48277 ISOMAX PT/100
F1 F4

UN: R\$ 0,43 AV: R\$ 43,13 15: R\$ 44,03
30: R\$ 44,91 45: R\$ 45,81 60: R\$ 46,73

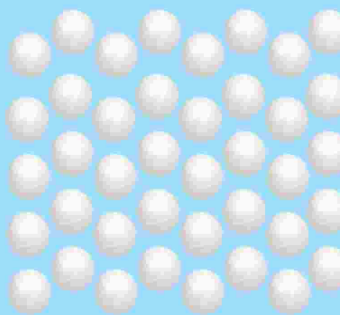

BOLA ISOPOR MOLD EPS DIAM 25MM 100X1

Código: Fábrika: Unidade:
48278 ISOMAX PT/100
F1 F4

UN: R\$ 0,63 AV: R\$ 62,65 15: R\$ 63,95
30: R\$ 65,23 45: R\$ 66,54 60: R\$ 67,87

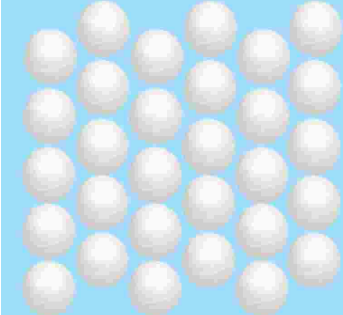

BOLA ISOPOR MOLD EPS DIAM 30MM 100X1

Código: Fábrika: Unidade:
47956 ISOMAX PT/100
F1 F4

UN: R\$ 0,57 AV: R\$ 57,10 15: R\$ 58,29
30: R\$ 59,46 45: R\$ 60,65 60: R\$ 61,86

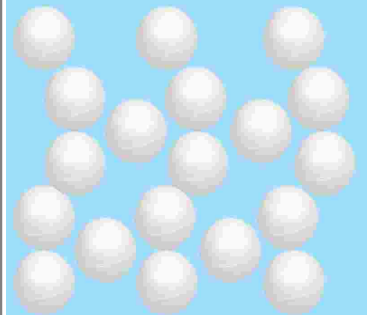

BOLA ISOPOR MOLD EPS DIAM 35MM 100X1

Código: Fábrika: Unidade:
30106 ISOMAX PT/100
F1 F4

UN: R\$ 1,50 AV: R\$ 59,89 15: R\$ 61,13
30: R\$ 62,36 45: R\$ 63,60 60: R\$ 64,88



BOLA ISOPOR MOLD EPS DIAM 40MM 40X1
Código: Fábrica: Unidade:
30107 ISOMAX PT/40
F1 F4

UN: R\$ 1,35 AV: R\$ 67,42 15: R\$ 68,82
30: R\$ 70,20 45: R\$ 71,60 60: R\$ 73,03



BOLA ISOPOR MOLD EPS DIAM 50MM 50X1
Código: Fábrica: Unidade:
30108 ISOMAX PT/50
F1 F4

UN: R\$ 2,53 AV: R\$ 76,00 15: R\$ 77,59
30: R\$ 79,14 45: R\$ 80,72 60: R\$ 82,33



BOLA ISOPOR MOLD EPS DIAM 60MM 30X1
Código: Fábrica: Unidade:
30109 ISOMAX PT/30
F1 F4

UN: R\$ 3,29 AV: R\$ 82,17 15: R\$ 83,88
30: R\$ 85,56 45: R\$ 87,27 60: R\$ 89,01



BOLA ISOPOR MOLD EPS DIAM 70MM 25X1
Código: Fábrica: Unidade:
47957 ISOMAX PT/25
F1 F4

UN: R\$ 2,74 AV: R\$ 68,57 15: R\$ 69,99
30: R\$ 71,39 45: R\$ 72,82 60: R\$ 74,28



BOLA ISOPOR MOLD EPS DIAM 75MM 25X1
Código: Fábrica: Unidade:
30092 ISOMAX PT/25
F1 F4

UN: R\$ 4,78 AV: R\$ 95,52 15: R\$ 97,51
30: R\$ 99,46 45: R\$ 101,45 60: R\$ 103,48



BOLA ISOPOR MOLD EPS DIAM 80MM 20X1
Código: Fábrica: Unidade:
48279 ISOMAX PT/20
F1 F4

UN: R\$ 4,37 AV: R\$ 87,30 15: R\$ 89,12
30: R\$ 90,90 45: R\$ 92,72 60: R\$ 94,58



BOLA ISOPOR MOLD EPS DIAM 90MM 12X1
Código: Fábrica: Unidade:
48280 ISOMAX PT/20
F1 F4

UN: R\$ 6,45 AV: R\$ 64,46 15: R\$ 65,80
30: R\$ 67,12 45: R\$ 68,46 60: R\$ 69,83



BOLA ISOPOR MOLD EPS DIAM 100MM 10X1
Código: Fábrica: Unidade:
30110 ISOMAX PT/10
F1 F4

UN: R\$ 13,69 AV: R\$ 82,17 15: R\$ 83,88
30: R\$ 85,56 45: R\$ 87,27 60: R\$ 89,01



BOLA ISOPOR MOLD EPS DIAM 125MM 6X1
Código: Fábrica: Unidade:
30940 ISOMAX PT/6
F1 F4

UN: R\$ 15,00 AV: R\$ 74,98 15: R\$ 76,54
30: R\$ 78,07 45: R\$ 79,63 60: R\$ 81,22



BOLA ISOPOR MOLD EPS DIAM 150MM 5X1
Código: Fábrica: Unidade:
30941 ISOMAX PT/5
F1 F4

UN: R\$ 20,54 AV: R\$ 82,17 15: R\$ 83,88
30: R\$ 85,56 45: R\$ 87,27 60: R\$ 89,01



BOLA ISOPOR MOLD EPS DIAM 175MM 4X1
Código: Fábrica: Unidade:
30942 ISOMAX PT/4
F1 F4

UN: R\$ 30,39 AV: R\$ 91,16 15: R\$ 93,06
30: R\$ 94,92 45: R\$ 96,82 60: R\$ 98,76



BOLA ISOPOR MOLD EPS DIAM 200MM 3X1
Código: Fábrica: Unidade:
30943 ISOMAX PT/3
F1 F4

UN: R\$ 33,13 AV: R\$ 66,25 15: R\$ 67,63
30: R\$ 68,99 45: R\$ 70,37 60: R\$ 71,77



BOLA ISOPOR MOLD EPS DIAM 250MM 2X1
Código: Fábrica: Unidade:
30944 ISOMAX PT/2
F1 F4

UN: R\$ 60,59 AV: R\$ 60,59 15: R\$ 61,86
30: R\$ 63,09 45: R\$ 64,36 60: R\$ 65,64



BOLA ISOPOR MOLD EPS DIAM 300MM 1X1
Código: Fábrica: Unidade:
30945 ISOMAX UN/1
F1 F4

UN: R\$ 3,07 AV: R\$ 3,07 15: R\$ 3,14
30: R\$ 3,20 45: R\$ 3,26 60: R\$ 3,33



BOLO ISOPOR REDONDO CIRCULO 100X100MM
Código: Fábrica: Unidade:
41302 ISOMAX PT/1
F1 F4

UN: R\$ 18,48 AV: R\$ 18,48 15: R\$ 18,86
30: R\$ 19,24 45: R\$ 19,63 60: R\$ 20,02



BOLO ISOPOR REDONDO 250X250X100MM
Código: Fábrica: Unidade:
35706 ISOMAX PT/1
F1 F4

UN: R\$ 26,82 AV: R\$ 26,82 15: R\$ 27,38
30: R\$ 27,93 45: R\$ 28,49 60: R\$ 29,05



BOLLO ISOPOR REDONDO 350X350X100MM
Código: Fábrika: Unidade:
35707 ISOMAX PT/1
F1 F4

UN: R\$ 0,16 AV: R\$ 16,42 15: R\$ 16,77
30: R\$ 17,10 45: R\$ 17,44 60: R\$ 17,79



BORRACHA PONTEIRA 100X1
Código: Fábrika: Unidade:
41967 VMP CX/100
F1 F4

UN: R\$ 1,87 AV: R\$ 44,84 15: R\$ 45,77
30: R\$ 46,69 45: R\$ 47,62 60: R\$ 48,57



BORRACHA ANATOM PRETA TS2000 24X1
Código: Fábrika: Unidade:
31873 ECOLE CX/24
F1 F4

UN: R\$ 0,74 AV: R\$ 29,69 15: R\$ 30,30
30: R\$ 30,91 45: R\$ 31,53 60: R\$ 32,16



BORRACHA BICOLOR 40 40X1
Código: Fábrika: Unidade:
18703 RED BOR/ZAP CX/40
F1 F4

UN: R\$ 1,34 AV: R\$ 53,40 15: R\$ 54,52
30: R\$ 55,61 45: R\$ 56,72 60: R\$ 57,85



BORRACHA BICOLOR 906281 40X1
Código: Fábrika: Unidade:
49941 BAZZE CX/40
F1 F4

UN: R\$ 1,80 AV: R\$ 43,14 15: R\$ 44,04
30: R\$ 44,92 45: R\$ 45,82 60: R\$ 46,74



BORRACHA BRANCA OVAL GDE BOR6008 24X1
Código: Fábrika: Unidade:
32951 CLASSE CX/24
F1 F4

UN: R\$ 0,37 AV: R\$ 18,48 15: R\$ 18,86
30: R\$ 19,24 45: R\$ 19,63 60: R\$ 20,02



BORRACHA BRANCA PONTEIRA 50X1
Código: Fábrika: Unidade:
28029 RED BOR CX/50
F1 F4

UN: R\$ 0,70 AV: R\$ 1,40 15: R\$ 1,43
30: R\$ 1,45 45: R\$ 1,48 60: R\$ 1,51



BORRACHA BRANCA 2B BLISTER 7351 2X1
Código: Fábrika: Unidade:
46950 YIN'S PAPER PT/2
F1 F4

UN: R\$ 1,02 AV: R\$ 20,36 15: R\$ 20,78
30: R\$ 21,20 45: R\$ 21,62 60: R\$ 22,06



BORRACHA BRANCA 20 GRANDE 20X1
Código: Fábrika: Unidade:
49263 COLORARE CX/20
F1 F4

UN: R\$ 1,03 AV: R\$ 20,53 15: R\$ 20,96
30: R\$ 21,38 45: R\$ 21,81 60: R\$ 22,24



BORRACHA BRANCA 20 GRANDE 20X1
Código: Fábrika: Unidade:
13146 PREMIER CX/20
F1 F4

UN: R\$ 0,98 AV: R\$ 19,51 15: R\$ 19,91
30: R\$ 20,31 45: R\$ 20,72 60: R\$ 21,13



BORRACHA BRANCA 20 4420 20X1
Código: Fábrika: Unidade:
41695 LEO&LEO CX/20
F1 F4

UN: R\$ 0,53 AV: R\$ 21,19 15: R\$ 21,63
30: R\$ 22,07 45: R\$ 22,51 60: R\$ 22,96



BORRACHA BRANCA 40 MEDIA 40X1
Código: Fábrika: Unidade:
13147 RED BOR CX/40
F1 F4

UN: R\$ 0,46 AV: R\$ 18,46 15: R\$ 18,84
30: R\$ 19,22 45: R\$ 19,60 60: R\$ 20,00



BORRACHA BRANCA 40 MEDIA 40X1
Código: Fábrika: Unidade:
50791 BAZZE CX/40
F1 F4

UN: R\$ 0,54 AV: R\$ 21,56 15: R\$ 22,01
30: R\$ 22,45 45: R\$ 22,90 60: R\$ 23,36



BORRACHA BRANCA 40 MEDIA 40X1
Código: Fábrika: Unidade:
49266 COLORARE CX/40
F1 F4

UN: R\$ 0,49 AV: R\$ 19,51 15: R\$ 19,91
30: R\$ 20,31 45: R\$ 20,72 60: R\$ 21,13



BORRACHA BRANCA 40 4419 40X1
Código: Fábrika: Unidade:
41694 LEO&LEO CX/40
F1 F4

UN: R\$ 0,37 AV: R\$ 22,26 15: R\$ 22,72
30: R\$ 23,18 45: R\$ 23,64 60: R\$ 24,11



BORRACHA BRANCA 60 PEQUENA 60X1
Código: Fábrika: Unidade:
13148 PREMIER/RED CX/60
F1 F4

UN: R\$ 0,34 AV: R\$ 20,37 15: R\$ 20,79
30: R\$ 21,21 45: R\$ 21,63 60: R\$ 22,07

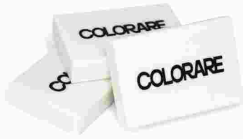

BORRACHA BRANCA 60 PEQUENA 60X1
Código: 49264 Fábrica: COLORARE Unidade: CX/60 F1 F4

UN: R\$ 0,26 AV: R\$ 15,40 15: R\$ 15,72
30: R\$ 16,03 45: R\$ 16,35 60: R\$ 16,68



BORRACHA BRANCA 60 20072 60X1
Código: 50683 Fábrica: WINPAPER Unidade: CX/60 F1 F4

UN: R\$ 0,32 AV: R\$ 19,16 15: R\$ 19,56
30: R\$ 19,95 45: R\$ 20,35 60: R\$ 20,75



BORRACHA BRANCA 60 4418 60X1
Código: 41696 Fábrica: LEO&LEO Unidade: CX/60 F1 F4

UN: R\$ 1,50 AV: R\$ 35,94 15: R\$ 36,69
30: R\$ 37,42 45: R\$ 38,17 60: R\$ 38,94



BORRACHA COLORIDA 4126 24X1
Código: 41650 Fábrica: LEO&LEO Unidade: C//24 F1 F4

UN: R\$ 1,03 AV: R\$ 5,13 15: R\$ 5,23
30: R\$ 5,34 45: R\$ 5,44 60: R\$ 5,55



BORRACHA KIT CHAPEU/BOTA/BOCAFLO 5X1
Código: 41676 Fábrica: MONALIZA Unidade: CR/5 F4

UN: R\$ 0,34 AV: R\$ 8,22 15: R\$ 8,39
30: R\$ 8,56 45: R\$ 8,73 60: R\$ 8,90



BORRACHA MECANICA (REFIL) 24X1
Código: 12047 Fábrica: JL Unidade: PT/24 F1 F4

UN: R\$ 1,11 AV: R\$ 26,71 15: R\$ 27,26
30: R\$ 27,81 45: R\$ 28,37 60: R\$ 28,93



BORRACHA PLAST HANNAH MONTANA 24X1
Código: 38554 Fábrica: TRIS Unidade: CX/24 F1 F4

UN: R\$ 1,11 AV: R\$ 26,71 15: R\$ 27,26
30: R\$ 27,81 45: R\$ 28,37 60: R\$ 28,93



BORRACHA PLAST HIGH SCHOOL MUSICAL 24X1
Código: 38555 Fábrica: TRIS Unidade: CX/24 F1 F4

UN: R\$ 0,16 AV: R\$ 7,90 15: R\$ 8,06
30: R\$ 8,23 45: R\$ 8,39 60: R\$ 8,56



BORRACHA PONTEIRA BRANCA 4352 48X1
Código: 42145 Fábrica: LEO&LEO Unidade: C//48 F1 F4

UN: R\$ 1,20 AV: R\$ 28,75 15: R\$ 29,35
30: R\$ 29,94 45: R\$ 30,54 60: R\$ 31,15



BORRACHA QUAD BRANCA CAPA PLAST 584 24X1
Código: 41227 Fábrica: LEO&LEO Unidade: CX/24 F1 F4

UN: R\$ 1,26 AV: R\$ 30,30 15: R\$ 30,93
30: R\$ 31,55 45: R\$ 32,18 60: R\$ 32,83



BORRACHA QUADR BRANCA C/CAPA PLAST 24X1
Código: 44116 Fábrica: PLANETA Unidade: CX/24 F1 F4

UN: R\$ 1,24 AV: R\$ 14,89 15: R\$ 15,20
30: R\$ 15,51 45: R\$ 15,82 60: R\$ 16,14



BORRACHA SILVER P C/CAPA PLAST 7147 12X1
Código: 23220 Fábrica: GOLLER Unidade: CX/12 F1 F4

UN: R\$ 1,49 AV: R\$ 22,29 15: R\$ 22,75
30: R\$ 23,21 45: R\$ 23,67 60: R\$ 24,15



BORRACHA VERDE 15 GRANDE 15X1
Código: 4253 Fábrica: RED BOR/PREM Unidade: CX/15 F1 F4

UN: R\$ 0,72 AV: R\$ 2,88 15: R\$ 2,94
30: R\$ 2,99 45: R\$ 3,05 60: R\$ 3,12



BORRACHA 40 MEDIA 4X1 CTL
Código: 33832 Fábrica: GOLLER Unidade: CT/4 F1 F4

UN: R\$ 0,66 AV: R\$ 7,94 15: R\$ 7,94
30: R\$ 7,94 45: R\$ 7,94 60: R\$ 7,94



BROCAL 3 GRS AZUL 12X1
Código: 6755 Fábrica: CITY BRILHO Unidade: CX/12 F1 F4

UN: R\$ 0,66 AV: R\$ 7,94 15: R\$ 7,94
30: R\$ 7,94 45: R\$ 7,94 60: R\$ 7,94



BROCAL 3 GRS DOURADO 12X1
Código: 6760 Fábrica: CITY BRILHO Unidade: CX/12 F1 F4

UN: R\$ 0,66 AV: R\$ 7,94 15: R\$ 7,94
30: R\$ 7,94 45: R\$ 7,94 60: R\$ 7,94



BROCAL 3 GRS MULTICOR 12X1

Código: 6759 Fábrica: CITY BRILHO Unidade: CX/12 F1 F4

UN: R\$ 0,66 AV: R\$ 7,94 15: R\$ 7,94
30: R\$ 7,94 45: R\$ 7,94 60: R\$ 7,94



BROCAL 3 GRS PEROLADO 12X1

Código: 6758 Fábrica: CITY BRILHO Unidade: CX/12 F1 F4

UN: R\$ 0,66 AV: R\$ 7,94 15: R\$ 7,94
30: R\$ 7,94 45: R\$ 7,94 60: R\$ 7,94



BROCAL 3 GRS PINK 12X1

Código: 6907 Fábrica: CITY BRILHO Unidade: CX/12 F1 F4

UN: R\$ 0,66 AV: R\$ 7,94 15: R\$ 7,94
30: R\$ 7,94 45: R\$ 7,94 60: R\$ 7,94



BROCAL 3 GRS PRATA 12X1

Código: 25 Fábrica: CITY BRILHO Unidade: CX/12 F1 F4

UN: R\$ 0,66 AV: R\$ 7,94 15: R\$ 7,94
30: R\$ 7,94 45: R\$ 7,94 60: R\$ 7,94



BROCAL 3 GRS PRETO 12X1

Código: 21975 Fábrica: CITY BRILHO Unidade: CX/12 F1 F4

UN: R\$ 0,66 AV: R\$ 7,94 15: R\$ 7,94
30: R\$ 7,94 45: R\$ 7,94 60: R\$ 7,94



BROCAL 3 GRS ROSA 12X1

Código: 6761 Fábrica: CITY BRILHO Unidade: CX/12 F1 F4

UN: R\$ 0,66 AV: R\$ 7,94 15: R\$ 7,94
30: R\$ 7,94 45: R\$ 7,94 60: R\$ 7,94



BROCAL 3 GRS ROXO 12X1

Código: 7477 Fábrica: CITY BRILHO Unidade: CX/12 F1 F4

UN: R\$ 0,66 AV: R\$ 7,94 15: R\$ 7,94
30: R\$ 7,94 45: R\$ 7,94 60: R\$ 7,94



BROCAL 3 GRS VERDE 12X1

Código: 6756 Fábrica: CITY BRILHO Unidade: CX/12 F1 F4

UN: R\$ 0,66 AV: R\$ 7,94 15: R\$ 7,94
30: R\$ 7,94 45: R\$ 7,94 60: R\$ 7,94



BROCAL 3 GRS VERMELHO 12X1

Código: 6757 Fábrica: CITY BRILHO Unidade: CX/12 F1 F4

UN: R\$ 11,09 AV: R\$ 11,09 15: R\$ 11,32
30: R\$ 11,55 45: R\$ 11,78 60: R\$ 12,02



BROCAL 100 GRS AZUL PISCINA

Código: 43646 Fábrica: CITY BRILHO Unidade: PT/1 F1 F4

UN: R\$ 11,09 AV: R\$ 11,09 15: R\$ 11,32
30: R\$ 11,55 45: R\$ 11,78 60: R\$ 12,02



BROCAL 100 GRS AZUL ROYAL

Código: 43649 Fábrica: CITY BRILHO Unidade: PT/1 F1 F4

UN: R\$ 11,09 AV: R\$ 11,09 15: R\$ 11,32
30: R\$ 11,55 45: R\$ 11,78 60: R\$ 12,02



BROCAL 100 GRS AZUL TURQUESA

Código: 43647 Fábrica: CITY BRILHO Unidade: PT/1 F1 F4

UN: R\$ 11,09 AV: R\$ 11,09 15: R\$ 11,32
30: R\$ 11,55 45: R\$ 11,78 60: R\$ 12,02



BROCAL 100 GRS MARROM

Código: 43648 Fábrica: CITY BRILHO Unidade: PT/1 F1 F4

UN: R\$ 11,09 AV: R\$ 11,09 15: R\$ 11,32
30: R\$ 11,55 45: R\$ 11,78 60: R\$ 12,02



BROCAL 100 GRS OURO

Código: 26352 Fábrica: CITY BRILHO Unidade: PT/1 F1 F4

UN: R\$ 11,09 AV: R\$ 11,09 15: R\$ 11,32
30: R\$ 11,55 45: R\$ 11,78 60: R\$ 12,02



BROCAL 100 GRS PEROLADO

Código: 26359 Fábrica: CITY BRILHO Unidade: PT/1 F1 F4

UN: R\$ 11,09 AV: R\$ 11,09 15: R\$ 11,32
30: R\$ 11,55 45: R\$ 11,78 60: R\$ 12,02



BROCAL 100 GRS PINK

Código: 26357 Fábrica: CITY BRILHO Unidade: PT/1 F1 F4

UN: R\$ 11,09 AV: R\$ 11,09 15: R\$ 11,32
30: R\$ 11,55 45: R\$ 11,78 60: R\$ 12,02



BROCAL 100 GRS PRATA

Código: 26353 Fábrica: CITY BRILHO Unidade: PT/1 F1 F4

UN: R\$ 11,09 AV: R\$ 11,09 15: R\$ 11,32
30: R\$ 11,55 45: R\$ 11,78 60: R\$ 12,02



BROCAL 100 GRS PRETO

Código: 21647 Fábrica: CITY BRILHO Unidade: PT/1 F1 F4

UN: R\$ 11,09 AV: R\$ 11,09 15: R\$ 11,32
30: R\$ 11,55 45: R\$ 11,78 60: R\$ 12,02



BROCAL 100 GRS ROSA

Código: 26356 Fábrica: CITY BRILHO Unidade: PT/1 F1 F4

UN: R\$ 11,09 AV: R\$ 11,09 15: R\$ 11,32
30: R\$ 11,55 45: R\$ 11,78 60: R\$ 12,02



BROCAL 100 GRS ROXO

Código: 26361 Fábrica: CITY BRILHO Unidade: PT/1 F1 F4

UN: R\$ 11,09 AV: R\$ 11,09 15: R\$ 11,32
30: R\$ 11,55 45: R\$ 11,78 60: R\$ 12,02



BROCAL 100 GRS VERDE BANDEIRA

Código: 26355 Fábrica: CITY BRILHO Unidade: PT/1 F1 F4

UN: R\$ 11,09 AV: R\$ 11,09 15: R\$ 11,32
30: R\$ 11,55 45: R\$ 11,78 60: R\$ 12,02



BROCAL 100 GRS VERDE OLIVA

Código: 43645 Fábrica: CITY BRILHO Unidade: PT/1 F1 F4

UN: R\$ 11,09 AV: R\$ 11,09 15: R\$ 11,32
30: R\$ 11,55 45: R\$ 11,78 60: R\$ 12,02



BROCAL 100 GRS VERMELHO

Código: 26354 Fábrica: CITY BRILHO Unidade: PT/1 F1 F4

UN: R\$ 46,21 AV: R\$ 46,21 15: R\$ 47,18
30: R\$ 48,12 45: R\$ 49,08 60: R\$ 50,06



BROCAL 500 GRS AZUL

Código: 43637 Fábrica: CITY BRILHO Unidade: PT/1 F1 F4

UN: R\$ 46,21 AV: R\$ 46,21 15: R\$ 47,18
30: R\$ 48,12 45: R\$ 49,08 60: R\$ 50,06



BROCAL 500 GRS OURO

Código: 43639 Fábrica: CITY BRILHO Unidade: PT/1 F1 F4

UN: R\$ 46,21 AV: R\$ 46,21 15: R\$ 47,18
30: R\$ 48,12 45: R\$ 49,08 60: R\$ 50,06



BROCAL 500 GRS PRATA

Código: 43640 Fábrica: CITY BRILHO Unidade: PT/1 F1 F4

UN: R\$ 46,21 AV: R\$ 46,21 15: R\$ 47,18
30: R\$ 48,12 45: R\$ 49,08 60: R\$ 50,06



BROCAL 500 GRS PRETO

Código: 43641 Fábrica: CITY BRILHO Unidade: PT/1 F1 F4

UN: R\$ 46,21 AV: R\$ 46,21 15: R\$ 47,18
30: R\$ 48,12 45: R\$ 49,08 60: R\$ 50,06



BROCAL 500 GRS ROSA

Código: 43642 Fábrica: CITY BRILHO Unidade: PT/1 F1 F4

UN: R\$ 46,21 AV: R\$ 46,21 15: R\$ 47,18
30: R\$ 48,12 45: R\$ 49,08 60: R\$ 50,06



BROCAL 500 GRS VERDE

Código: 43643 Fábrica: CITY BRILHO Unidade: PT/1 F1 F4

UN: R\$ 46,21 AV: R\$ 46,21 15: R\$ 47,18
30: R\$ 48,12 45: R\$ 49,08 60: R\$ 50,06



BROCAL 500 GRS VERMELHO

Código: 43644 Fábrica: CITY BRILHO Unidade: PT/1 F1 F4

UN: R\$ 7,21 AV: R\$ 72,06 15: R\$ 73,57
30: R\$ 75,04 45: R\$ 76,54 60: R\$ 78,07



CADERNETA CD 1/8 ESP 96FLS FURRY BE 10X1

Código: 20343 Fábrica: MAXMA Unidade: PT/10 F1 F4

UN: R\$ 7,21 AV: R\$ 72,06 15: R\$ 73,57
30: R\$ 75,04 45: R\$ 76,54 60: R\$ 78,07



CADERNETA CD 1/8 ESP 96FLS LOUISE 10X1

Código: 34002 Fábrica: MAXIMA Unidade: PT/10 F1 F4

UN: R\$ 7,21 AV: R\$ 72,06 15: R\$ 73,57
30: R\$ 75,04 45: R\$ 76,54 60: R\$ 78,07



CADERNETA CD 1/8 ESP 96FLS LOVE 10X1
Código: Fábrica: Unidade:
33609 MAXIMA PT/10
F1 F4

UN: R\$ 7,21 AV: R\$ 72,06 15: R\$ 73,57
30: R\$ 75,04 45: R\$ 76,54 60: R\$ 78,07

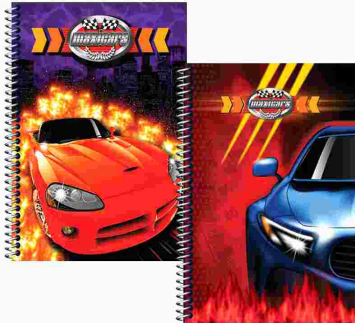

CADERNETA CD 1/8 ESP 96FLS MAXICARS10X1
Código: Fábrica: Unidade:
33999 MAXIMA PT/10
F1 F4

UN: R\$ 7,21 AV: R\$ 72,06 15: R\$ 73,57
30: R\$ 75,04 45: R\$ 76,54 60: R\$ 78,07



CADERNETA CD 1/8 ESP 96FLS X-PHOTO 10X1
Código: Fábrica: Unidade:
34001 MAXIMA PT/10
F1 F4

UN: R\$ 7,21 AV: R\$ 72,06 15: R\$ 73,57
30: R\$ 75,04 45: R\$ 76,54 60: R\$ 78,07



CADERNETA CD 1/8 ESP 96FLS X-SPIDER 10X1
Código: Fábrica: Unidade:
33997 MAXIMA PT/10
F1 F4

UN: R\$ 7,21 AV: R\$ 72,06 15: R\$ 73,57
30: R\$ 75,04 45: R\$ 76,54 60: R\$ 78,07



CADERNETA CD 1/8 ESP 96FLS X-SPORT 10X1
Código: Fábrica: Unidade:
33998 MAXIMA PT/10
F1 F4

UN: R\$ 2,62 AV: R\$ 104,61 15: R\$ 106,79
30: R\$ 108,93 45: R\$ 111,11 60: R\$ 113,33



CADERNETA 1/16 APONTAMENTO 40FLS 40X1
Código: Fábrica: Unidade:
45842 CREDEAL PT/40
F1 F4

UN: R\$ 2,32 AV: R\$ 92,99 15: R\$ 94,93
30: R\$ 96,83 45: R\$ 98,76 60: R\$ 100,74



CADERNETA 1/16 BOLSO ESPIRAL 40FLS 40X1
Código: Fábrica: Unidade:
12473 PAUTA/NOVA PT/40
F1 F4

UN: R\$ 1,86 AV: R\$ 92,99 15: R\$ 94,93
30: R\$ 96,83 45: R\$ 98,76 60: R\$ 100,74



CADERNETA 1/16 BOLSO ESPIRAL 40FLS 50X1
Código: Fábrica: Unidade:
45819 NEEDS PT/50
F1 F4

UN: R\$ 2,79 AV: R\$ 55,79 15: R\$ 56,95
30: R\$ 58,09 45: R\$ 59,25 60: R\$ 60,44

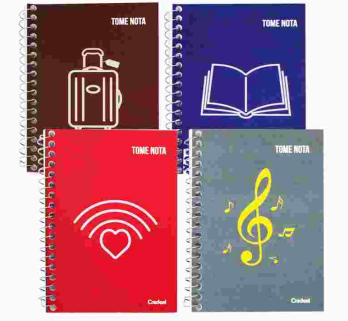

CADERNETA 1/8 ANOTACOES 48FLS ESP 20X1
Código: Fábrica: Unidade:
20286 PANAMER/CRED PT/20
F1 F4

UN: R\$ 5,58 AV: R\$ 55,79 15: R\$ 56,95
30: R\$ 58,09 45: R\$ 59,25 60: R\$ 60,44



CADERNETA 1/8 ANOTACOES 96FLS ESP 10X1
Código: Fábrica: Unidade:
5252 CREDEAL PT/10
F1 F4

UN: R\$ 1,97 AV: R\$ 58,97 15: R\$ 60,20
30: R\$ 61,40 45: R\$ 62,63 60: R\$ 63,88



CADERNETA 1/8 DEVE/HAVER 16FLS 30X1
Código: Fábrica: Unidade:
15707 PARRKE PT/30
F1 F4

UN: R\$ 3,94 AV: R\$ 39,40 15: R\$ 39,40
30: R\$ 39,40 45: R\$ 39,40 60: R\$ 39,40



CADERNETA 1/8 ESP 96FLS 10X1
Código: Fábrica: Unidade:
42912 NEEDS PT/10
F1 F4

UN: R\$ 11,61 AV: R\$ 46,45 15: R\$ 47,42
30: R\$ 48,37 45: R\$ 49,34 60: R\$ 50,32



CADERNO 1MAT 96FLS UNIVERS FLEX 4X1
Código: Fábrica: Unidade:
44110 ROMITEC PT/4
F1 F4

UN: R\$ 11,61 AV: R\$ 58,07 15: R\$ 59,28
30: R\$ 60,46 45: R\$ 61,67 60: R\$ 62,91



CADERNO 1MAT 96FLS UNIVERS FLEX 5X1
Código: Fábrica: Unidade:
45252 ROMITEC PT/5
F1 F4

UN: R\$ 22,09 AV: R\$ 110,43 15: R\$ 112,73
30: R\$ 114,98 45: R\$ 117,28 60: R\$ 119,63



CADERNO ALIBOMBOM CD 80F 123 C/P VD 5X1
Código: Fábrica: Unidade:
33780 MAXIMA PT/5
F1 F4

UN: R\$ 22,09 AV: R\$ 110,43 15: R\$ 112,73
30: R\$ 114,98 45: R\$ 117,28 60: R\$ 119,63



CADERNO ALIBOMBOM CD 80F 123 S/P AZ 5X1
Código: Fábrica: Unidade:
33781 MAXIMA PT/5
F1 F4

UN: R\$ 22,09 AV: R\$ 110,43 15: R\$ 112,73
30: R\$ 114,98 45: R\$ 117,28 60: R\$ 119,63



CADERNO ALIBOMBOM CD 80F 123X C/P VM 5X1

Código: Fábrika: Unidade:
23696 MAXIMA PT/5
F1 F4

UN: R\$ 16,27 AV: R\$ 162,68 15: R\$ 166,07
30: R\$ 169,39 45: R\$ 172,78 60: R\$ 176,24



CADERNO ALIBOMBOM CF 60F 123 C/P VD 10X1

Código: Fábrika: Unidade:
33779 MAXIMA PT/10
F1 F4

UN: R\$ 16,26 AV: R\$ 16,26 15: R\$ 16,60
30: R\$ 16,93 45: R\$ 17,27 60: R\$ 17,62



CADERNO ALIBOMBOM CF 60F 123 S/P AZ

Código: Fábrika: Unidade:
40756 MAXIMA UN/1
F1 F4

UN: R\$ 16,27 AV: R\$ 162,68 15: R\$ 166,07
30: R\$ 169,39 45: R\$ 172,78 60: R\$ 176,24



CADERNO ALIBOMBOM CF 60F 123X C/P VM 10X

Código: Fábrika: Unidade:
23695 MAXIMA PT/10
F1 F4

UN: R\$ 69,74 AV: R\$ 69,74 15: R\$ 71,19
30: R\$ 72,62 45: R\$ 74,07 60: R\$ 75,55



CADERNO ARG PP 80FLS STYLES DREAM C/6DIV

Código: Fábrika: Unidade:
46055 ACP UN/1
F1 F4

UN: R\$ 69,74 AV: R\$ 69,74 15: R\$ 71,19
30: R\$ 72,62 45: R\$ 74,07 60: R\$ 75,55



CADERNO ARG PP 80FLS STYLES LOVE C/6DIV

Código: Fábrika: Unidade:
46102 ACP UN/1
F1 F4

UN: R\$ 52,30 AV: R\$ 52,30 15: R\$ 53,39
30: R\$ 54,46 45: R\$ 55,55 60: R\$ 56,66

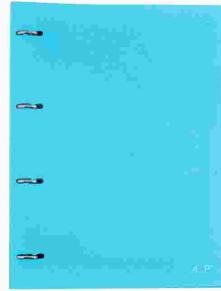

CADERNO ARG PP 96FLS SWEET C/6DIV AZUL

Código: Fábrika: Unidade:
46099 ACP UN/1
F1 F4

UN: R\$ 52,30 AV: R\$ 52,30 15: R\$ 53,39
30: R\$ 54,46 45: R\$ 55,55 60: R\$ 56,66

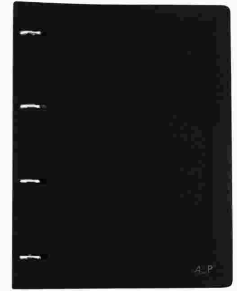

CADERNO ARG PP 96FLS SWEET C/6DIV PRETO

Código: Fábrika: Unidade:
46100 ACP UN/1
F1 F4

UN: R\$ 52,30 AV: R\$ 52,30 15: R\$ 53,39
30: R\$ 54,46 45: R\$ 55,55 60: R\$ 56,66

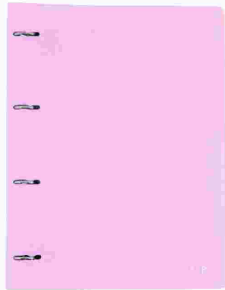

CADERNO ARG PP 96FLS SWEET C/6DIV ROSA

Código: Fábrika: Unidade:
46098 ACP UN/1
F1 F4

UN: R\$ 69,74 AV: R\$ 69,74 15: R\$ 71,19
30: R\$ 72,62 45: R\$ 74,07 60: R\$ 75,55

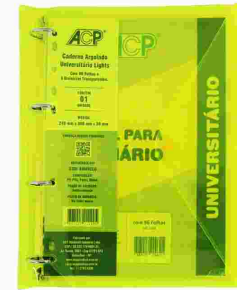

CADERNO ARG PVC 96FLS C/6DIV AMARELO

Código: Fábrika: Unidade:
46089 ACP UN/1
F1 F4

UN: R\$ 69,74 AV: R\$ 69,74 15: R\$ 71,19
30: R\$ 72,62 45: R\$ 74,07 60: R\$ 75,55



CADERNO ARG PVC 96FLS C/6DIV LARANJA

Código: Fábrika: Unidade:
46091 ACP UN/1
F1 F4

UN: R\$ 69,74 AV: R\$ 69,74 15: R\$ 71,19
30: R\$ 72,62 45: R\$ 74,07 60: R\$ 75,55



CADERNO ARG PVC 96FLS C/6DIV PINK

Código: Fábrika: Unidade:
46090 ACP UN/1
F1 F4

UN: R\$ 69,74 AV: R\$ 69,74 15: R\$ 71,19
30: R\$ 72,62 45: R\$ 74,07 60: R\$ 75,55



CADERNO ARG PVC 96FLS C/6DIV VERDE

Código: Fábrika: Unidade:
46088 ACP UN/1
F1 F4

UN: R\$ 72,06 AV: R\$ 72,06 15: R\$ 73,57
30: R\$ 75,04 45: R\$ 76,54 60: R\$ 78,07



CADERNO ARG PVC 96FLS POA C/6DIV LILAS

Código: Fábrika: Unidade:
46092 ACP UN/1
F1 F4

UN: R\$ 72,06 AV: R\$ 72,06 15: R\$ 73,57
30: R\$ 75,04 45: R\$ 76,54 60: R\$ 78,07



CADERNO ARG PVC 96FLS POA C/6DIV PRETO

Código: Fábrika: Unidade:
46094 ACP UN/1
F1 F4

UN: R\$ 72,06 AV: R\$ 72,06 15: R\$ 73,57
30: R\$ 75,04 45: R\$ 76,54 60: R\$ 78,07



CADERNO ARG PVC 96FLS POA C/6DIV ROSA

Código: Fábrika: Unidade:
46095 ACP UN/1
F1 F4

UN: R\$ 97,64 AV: R\$ 97,64 15: R\$ 99,67
30: R\$ 101,67 45: R\$ 103,70 60: R\$ 105,77



CADERNO ARG 96FLS SWEET C/6DIV P LAP LIL
Código: Fábrica: Unidade:
46127 ACP UN/1
F1 F4

UN: R\$ 97,64 AV: R\$ 97,64 15: R\$ 99,67
30: R\$ 101,67 45: R\$ 103,70 60: R\$ 105,77



CADERNO ARG 96FLS SWEET C/6DIV P LAP ROS
Código: Fábrica: Unidade:
46126 ACP UN/1
F1 F4

UN: R\$ 19,51 AV: R\$ 195,12 15: R\$ 199,18
30: R\$ 203,17 45: R\$ 207,23 60: R\$ 211,37



CADERNO BROC CD 40FLS CALIGRAFIA 10X1
Código: Fábrica: Unidade:
50702 CREDEAL PT/10
F1 F4

UN: R\$ 12,32 AV: R\$ 61,62 15: R\$ 62,91
30: R\$ 64,16 45: R\$ 65,45 60: R\$ 66,76



CADERNO BROC CD 80FLS C/P AMARELO 5X1
Código: Fábrica: Unidade:
49100 CREDEAL/MAXI PT/5
F1 F4

UN: R\$ 12,32 AV: R\$ 61,62 15: R\$ 62,91
30: R\$ 64,16 45: R\$ 65,45 60: R\$ 66,76

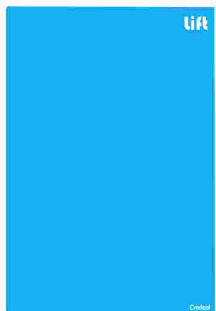

CADERNO BROC CD 80FLS C/P AZUL 5X1
Código: Fábrica: Unidade:
49099 CREDEAL/MAXI PT/5
F1 F4

UN: R\$ 16,27 AV: R\$ 81,36 15: R\$ 83,06
30: R\$ 84,72 45: R\$ 86,42 60: R\$ 88,14



CADERNO BROC CD 80FLS C/P LALA PETS 5X1
Código: Fábrica: Unidade:
43807 CREDEAL PT/5
F1 F4

UN: R\$ 12,32 AV: R\$ 61,62 15: R\$ 62,91
30: R\$ 64,16 45: R\$ 65,45 60: R\$ 66,76

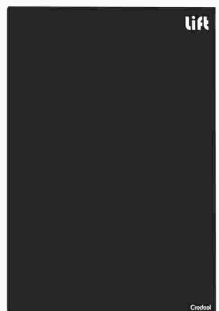

CADERNO BROC CD 80FLS C/P PRETO 5X1
Código: Fábrica: Unidade:
49103 CREDEAL PT/5
F1 F4

UN: R\$ 12,32 AV: R\$ 61,62 15: R\$ 62,91
30: R\$ 64,16 45: R\$ 65,45 60: R\$ 66,76



CADERNO BROC CD 80FLS C/P VERDE 5X1
Código: Fábrica: Unidade:
49102 CREDEAL/MAXI PT/5
F1 F4

UN: R\$ 12,32 AV: R\$ 61,62 15: R\$ 62,91
30: R\$ 64,16 45: R\$ 65,45 60: R\$ 66,76

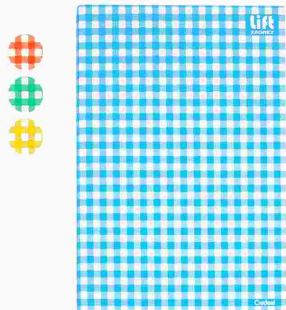

CADERNO BROC CD 80FLS C/P XADREZ 5X1
Código: Fábrica: Unidade:
49104 CREDEAL PT/5
F1 F4

UN: R\$ 15,11 AV: R\$ 75,55 15: R\$ 77,13
30: R\$ 78,67 45: R\$ 80,24 60: R\$ 81,85

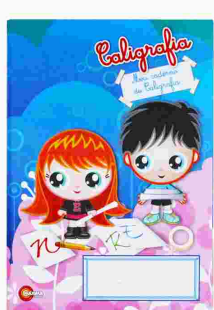

CADERNO BROC CD 96FLS CALIGRAFIA 5X1
Código: Fábrica: Unidade:
33996 MAXIMA PT/5
F1 F4

UN: R\$ 15,58 AV: R\$ 77,88 15: R\$ 79,50
30: R\$ 81,09 45: R\$ 82,71 60: R\$ 84,37



CADERNO BROC CD 96FLS C/P AMARELO 5X1
Código: Fábrica: Unidade:
19351 MAXIM/CREDEA PT/5
F1 F4

UN: R\$ 15,58 AV: R\$ 77,88 15: R\$ 79,50
30: R\$ 81,09 45: R\$ 82,71 60: R\$ 84,37



CADERNO BROC CD 96FLS C/P AZUL 5X1
Código: Fábrica: Unidade:
20603 MAXIMA PT/5
F1 F4

UN: R\$ 13,02 AV: R\$ 651,00 15: R\$ 664,56
30: R\$ 677,85 45: R\$ 691,41 60: R\$ 705,24



CADERNO BROC CD 96FLS C/P DEC FEM 50X1
Código: Fábrica: Unidade:
50893 MAXIMA CX/50
F1 F4

UN: R\$ 13,02 AV: R\$ 651,00 15: R\$ 664,56
30: R\$ 677,85 45: R\$ 691,41 60: R\$ 705,24



CADERNO BROC CD 96FLS C/P DEC MASC 50X1
Código: Fábrica: Unidade:
50894 MAXIMA CX/50
F1 F4

UN: R\$ 16,27 AV: R\$ 81,36 15: R\$ 83,06
30: R\$ 84,72 45: R\$ 86,42 60: R\$ 88,14

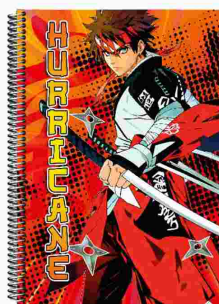

CADERNO BROC CD 96FLS C/P HURRACANE 5X1
Código: Fábrica: Unidade:
46626 MAXIMA PT/5
F1 F4

UN: R\$ 16,27 AV: R\$ 81,36 15: R\$ 83,06
30: R\$ 84,72 45: R\$ 86,42 60: R\$ 88,14



CADERNO BROC CD 96FLS C/P I LIKE 5X1
Código: Fábrica: Unidade:
43311 MAXIMA PT/5
F1 F4

UN: R\$ 16,27 AV: R\$ 81,36 15: R\$ 83,06
30: R\$ 84,72 45: R\$ 86,42 60: R\$ 88,14



CADERNO BROCD CD 96FLS C/P LALA FEM 5X1
Código: 43808 Fábrica: CREDEAL Unidade: PT/5 F1 F4

UN: R\$ 16,27 AV: R\$ 81,36 15: R\$ 83,06
30: R\$ 84,72 45: R\$ 86,42 60: R\$ 88,14



CADERNO BROCD CD 96FLS C/P LALA MASC 5X1
Código: 29792 Fábrica: CREDEAL Unidade: PT/5 F1 F4

UN: R\$ 15,58 AV: R\$ 77,88 15: R\$ 79,50
30: R\$ 81,09 45: R\$ 82,71 60: R\$ 84,37



CADERNO BROCD CD 96FLS C/P LARANJA 5X1
Código: 40827 Fábrica: MAXIMA Unidade: PT/5 F1 F4

UN: R\$ 16,27 AV: R\$ 81,36 15: R\$ 83,06
30: R\$ 84,72 45: R\$ 86,42 60: R\$ 88,14

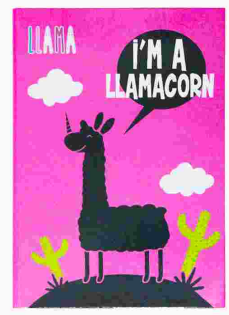

CADERNO BROCD CD 96FLS C/P LLAMAS 5X1
Código: 44979 Fábrica: MAXIMA Unidade: PT/5 F1 F4

UN: R\$ 16,27 AV: R\$ 81,36 15: R\$ 83,06
30: R\$ 84,72 45: R\$ 86,42 60: R\$ 88,14



CADERNO BROCD CD 96FLS C/P LOUISE 5X1
Código: 33263 Fábrica: MAXIMA Unidade: PT/5 F1 F4

UN: R\$ 16,27 AV: R\$ 81,36 15: R\$ 83,06
30: R\$ 84,72 45: R\$ 86,42 60: R\$ 88,14

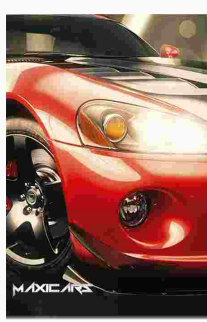

CADERNO BROCD CD 96FLS C/P MAXICARS 5X1
Código: 36291 Fábrica: MAXIMA Unidade: PT/5 F1 F4

UN: R\$ 15,58 AV: R\$ 77,88 15: R\$ 79,50
30: R\$ 81,09 45: R\$ 82,71 60: R\$ 84,37

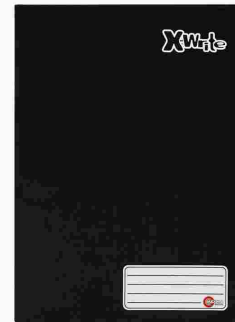

CADERNO BROCD CD 96FLS C/P PRETO 5X1
Código: 40826 Fábrica: MAXIMA Unidade: PT/5 F1 F4

UN: R\$ 16,27 AV: R\$ 81,36 15: R\$ 83,06
30: R\$ 84,72 45: R\$ 86,42 60: R\$ 88,14

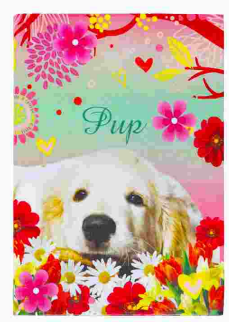

CADERNO BROCD CD 96FLS C/P PUP 5X1
Código: 33268 Fábrica: MAXIMA Unidade: PT/5 F1 F4

UN: R\$ 16,27 AV: R\$ 81,36 15: R\$ 83,06
30: R\$ 84,72 45: R\$ 86,42 60: R\$ 88,14



CADERNO BROCD CD 96FLS C/P SEASON 5X1
Código: 31549 Fábrica: MAXIMA Unidade: PT/5 F1 F4

UN: R\$ 15,58 AV: R\$ 77,88 15: R\$ 79,50
30: R\$ 81,09 45: R\$ 82,71 60: R\$ 84,37



CADERNO BROCD CD 96FLS C/P VERDE 5X1
Código: 23502 Fábrica: MAX/CRED/TIL Unidade: PT/5 F1 F4

UN: R\$ 15,58 AV: R\$ 77,88 15: R\$ 79,50
30: R\$ 81,09 45: R\$ 82,71 60: R\$ 84,37



CADERNO BROCD CD 96FLS C/P VERMELHO 5X1
Código: 20641 Fábrica: MAXIM/CREDEA Unidade: PT/5 F1 F4

UN: R\$ 15,58 AV: R\$ 77,88 15: R\$ 79,50
30: R\$ 81,09 45: R\$ 82,71 60: R\$ 84,37

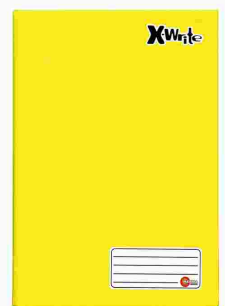

CADERNO BROCD CD 96FLS S/P AMARELO 5X1
Código: 20643 Fábrica: MAXIMA Unidade: PT/5 F1 F4

UN: R\$ 15,58 AV: R\$ 77,88 15: R\$ 79,50
30: R\$ 81,09 45: R\$ 82,71 60: R\$ 84,37

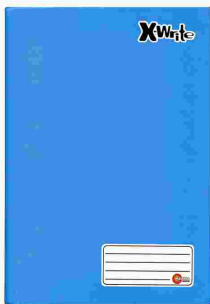

CADERNO BROCD CD 96FLS S/P AZUL 5X1
Código: 36312 Fábrica: MAXIMA Unidade: PT/5 F1 F4

UN: R\$ 16,27 AV: R\$ 81,36 15: R\$ 83,06
30: R\$ 84,72 45: R\$ 86,42 60: R\$ 88,14



CADERNO BROCD CD 96FLS S/P CORUJAS 5X1
Código: 49460 Fábrica: MAXIMA Unidade: PT/5 F1 F4

UN: R\$ 16,27 AV: R\$ 81,36 15: R\$ 83,06
30: R\$ 84,72 45: R\$ 86,42 60: R\$ 88,14



CADERNO BROCD CD 96FLS S/P FLAMINGOS 5X1
Código: 50891 Fábrica: MAXIMA Unidade: PT/5 F1 F4

UN: R\$ 16,27 AV: R\$ 81,36 15: R\$ 83,06
30: R\$ 84,72 45: R\$ 86,42 60: R\$ 88,14



CADERNO BROCD CD 96FLS S/P LOUISES 5X1
Código: 50890 Fábrica: MAXIMA Unidade: PT/5 F1 F4

UN: R\$ 15,58 AV: R\$ 77,88 15: R\$ 79,50
30: R\$ 81,09 45: R\$ 82,71 60: R\$ 84,37

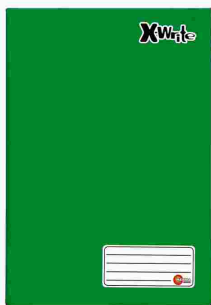

CADERNO BROCD CD 96FLS S/P VERDE 5X1

Código: Fábrica: Unidade:
20600 MAXIMA PT/5
F1 F4

UN: R\$ 15,58 AV: R\$ 77,88 15: R\$ 79,50
30: R\$ 81,09 45: R\$ 82,71 60: R\$ 84,37



CADERNO BROCD CD 96FLS S/P VERMELHO 5X1

Código: Fábrica: Unidade:
20604 MAXIMA PT/5
F1 F4

UN: R\$ 16,27 AV: R\$ 81,36 15: R\$ 83,06
30: R\$ 84,72 45: R\$ 86,42 60: R\$ 88,14

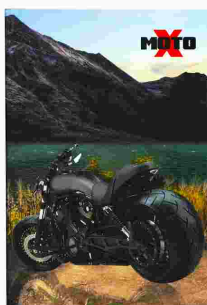

CADERNO BROCD CD 96FLS S/P X-MOTO 5X1

Código: Fábrica: Unidade:
50892 MAXIMA PT/5
F1 F4

UN: R\$ 2,91 AV: R\$ 58,11 15: R\$ 59,32
30: R\$ 60,51 45: R\$ 61,72 60: R\$ 62,96



CADERNO BROCD CF 40FL 1/4 CALIGRAFIA 20X1

Código: Fábrica: Unidade:
43376 CREDEAL PT/20
F1 F4

UN: R\$ 4,65 AV: R\$ 46,49 15: R\$ 47,46
30: R\$ 48,41 45: R\$ 49,37 60: R\$ 50,36



CADERNO BROCD CFORT 48FLS CALIGRAFIA 10X1

Código: Fábrica: Unidade:
42917 NEEDS PT/10
F1 F4

UN: R\$ 13,95 AV: R\$ 139,49 15: R\$ 142,40
30: R\$ 145,24 45: R\$ 148,15 60: R\$ 151,11

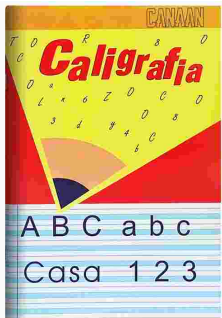

CADERNO BROCD CFORT 60FLS CALIGRAFIA 10X1

Código: Fábrica: Unidade:
19853 MINEIRO PT/10
F1 F4

UN: R\$ 6,97 AV: R\$ 69,74 15: R\$ 71,19
30: R\$ 72,62 45: R\$ 74,07 60: R\$ 75,55



CADERNO BROCD CFORTE 60FLS C/P 10X1

Código: Fábrica: Unidade:
50903 MAXIMA PT/10
F1 F4

UN: R\$ 6,97 AV: R\$ 69,74 15: R\$ 71,19
30: R\$ 72,62 45: R\$ 74,07 60: R\$ 75,55



CADERNO BROCD CFORTE 60FLS S/P 10X1

Código: Fábrica: Unidade:
50904 MAXIMA PT/10
F1 F4

UN: R\$ 8,14 AV: R\$ 81,36 15: R\$ 83,06
30: R\$ 84,72 45: R\$ 86,42 60: R\$ 88,14



CADERNO BROCD CFORTE 80FL 1MA AMIGAS 10X1

Código: Fábrica: Unidade:
43818 FORONI PT/10
F1 F4

UN: R\$ 8,14 AV: R\$ 81,36 15: R\$ 83,06
30: R\$ 84,72 45: R\$ 86,42 60: R\$ 88,14



CADERNO BROCD CFORTE 80FLS 1MAT JUDY 10X1

Código: Fábrica: Unidade:
43832 FORONI PT/10
F1 F4

UN: R\$ 6,71 AV: R\$ 100,66 15: R\$ 102,75
30: R\$ 104,81 45: R\$ 106,90 60: R\$ 109,04



CADERNO BROCD FLEX 60FLS C/P LALA 15X1

Código: Fábrica: Unidade:
19556 CREDEAL PT/15
F1 F4

UN: R\$ 7,56 AV: R\$ 75,55 15: R\$ 77,13
30: R\$ 78,67 45: R\$ 80,24 60: R\$ 81,85



CADERNO BROCD FLEX 60FLS C/P 10X1

Código: Fábrica: Unidade:
9737 MAXIMA/JAND PT/10
F1 F4

UN: R\$ 8,73 AV: R\$ 87,30 15: R\$ 89,12
30: R\$ 90,90 45: R\$ 92,72 60: R\$ 94,58



CADERNO BROCD FLEX 80FLS C/P LALA 10X1

Código: Fábrica: Unidade:
4043 CREDEAL PT/10
F1 F4

UN: R\$ 9,88 AV: R\$ 98,80 15: R\$ 100,86
30: R\$ 102,88 45: R\$ 104,94 60: R\$ 107,03



CADERNO BROCD FLEX 80FLS C/P 10X1

Código: Fábrica: Unidade:
14644 MAXIMA PT/10
F1 F4

UN: R\$ 10,46 AV: R\$ 104,61 15: R\$ 106,79
30: R\$ 108,93 45: R\$ 111,11 60: R\$ 113,33



CADERNO BROCD FLEX 96FLS C/P 10X1

Código: Fábrica: Unidade:
40828 MAXIMA PT/10
F1 F4

UN: R\$ 9,65 AV: R\$ 96,48 15: R\$ 98,49
30: R\$ 100,46 45: R\$ 102,47 60: R\$ 104,52

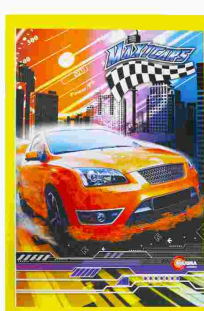

CADERNO BROCD FLEX 96FLS S/P 10X1

Código: Fábrica: Unidade:
35513 MAXIMA/PANAM PT/10
F1 F4

UN: R\$ 6,96 AV: R\$ 6,96 15: R\$ 7,11
30: R\$ 7,25 45: R\$ 7,40 60: R\$ 7,54

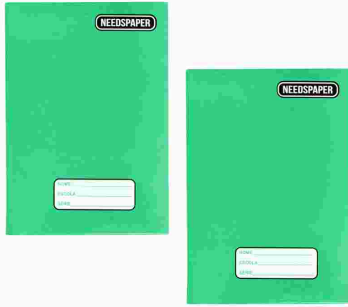

CADERNO BROC 1/4 CD 40FLS PAUTA VERDE
Código: Fábrica: Unidade:
42308 NEEDS UN/1
F1 F4

UN: R\$ 6,74 AV: R\$ 33,70 15: R\$ 34,40
30: R\$ 35,09 45: R\$ 35,79 60: R\$ 36,51



CADERNO BROC 1/4 CD 96FLS CECI 5X1
Código: Fábrica: Unidade:
50896 MAXIMA PT/5
F1 F4

UN: R\$ 6,74 AV: R\$ 33,70 15: R\$ 34,40
30: R\$ 35,09 45: R\$ 35,79 60: R\$ 36,51



CADERNO BROC 1/4 CD 96FLS CHILLIN 5X1
Código: Fábrica: Unidade:
40824 MAXIMA PT/5
F1 F4

UN: R\$ 6,74 AV: R\$ 33,70 15: R\$ 34,40
30: R\$ 35,09 45: R\$ 35,79 60: R\$ 36,51



CADERNO BROC 1/4 CD 96FLS CORUJAS 5X1
Código: Fábrica: Unidade:
34003 MAXIMA PT/5
F1 F4

UN: R\$ 6,74 AV: R\$ 33,70 15: R\$ 34,40
30: R\$ 35,09 45: R\$ 35,79 60: R\$ 36,51

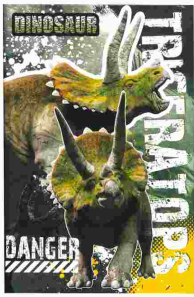

CADERNO BROC 1/4 CD 96FLS DINO 5X1
Código: Fábrica: Unidade:
36127 MAXIMA PT/5
F1 F4

UN: R\$ 6,74 AV: R\$ 33,70 15: R\$ 34,40
30: R\$ 35,09 45: R\$ 35,79 60: R\$ 36,51



CADERNO BROC 1/4 CD 96FLS FLAMINGO 5X1
Código: Fábrica: Unidade:
40841 MAXIMA PT/5
F1 F4

UN: R\$ 6,74 AV: R\$ 33,70 15: R\$ 34,40
30: R\$ 35,09 45: R\$ 35,79 60: R\$ 36,51

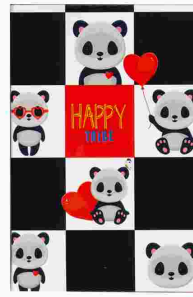

CADERNO BROC 1/4 CD 96FLS HAPPY TRIB 5X1
Código: Fábrica: Unidade:
50897 MAXIMA PT/5
F1 F4

UN: R\$ 6,74 AV: R\$ 33,70 15: R\$ 34,40
30: R\$ 35,09 45: R\$ 35,79 60: R\$ 36,51



CADERNO BROC 1/4 CD 96FLS HURRANE 5X1
Código: Fábrica: Unidade:
50895 MAXIMA PT/5
F1 F4

UN: R\$ 6,74 AV: R\$ 33,70 15: R\$ 34,40
30: R\$ 35,09 45: R\$ 35,79 60: R\$ 36,51

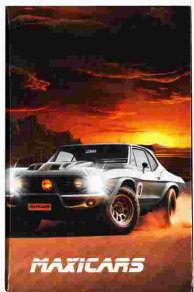

CADERNO BROC 1/4 CD 96FLS MAXICARS 5X1
Código: Fábrica: Unidade:
34434 MAXIMA PT/5
F1 F4

UN: R\$ 6,74 AV: R\$ 33,70 15: R\$ 34,40
30: R\$ 35,09 45: R\$ 35,79 60: R\$ 36,51



CADERNO BROC 1/4 CD 96FLS MERMAID 5X1
Código: Fábrica: Unidade:
40825 MAXIMA PT/5
F1 F4

UN: R\$ 6,74 AV: R\$ 33,70 15: R\$ 34,40
30: R\$ 35,09 45: R\$ 35,79 60: R\$ 36,51



CADERNO BROC 1/4 CD 96FLS PUP 5X1
Código: Fábrica: Unidade:
34004 MAXIMA PT/5
F1 F4

UN: R\$ 6,74 AV: R\$ 33,70 15: R\$ 34,40
30: R\$ 35,09 45: R\$ 35,79 60: R\$ 36,51



CADERNO BROC 1/4 CD 96FLS UNICORNS 5X1
Código: Fábrica: Unidade:
34006 MAXIMA PT/5
F1 F4

UN: R\$ 6,74 AV: R\$ 33,70 15: R\$ 34,40
30: R\$ 35,09 45: R\$ 35,79 60: R\$ 36,51



CADERNO BROC 1/4 CD 96FLS X-MOTO 5X1
Código: Fábrica: Unidade:
34010 MAXIMA PT/5
F1 F4

UN: R\$ 6,74 AV: R\$ 33,70 15: R\$ 34,40
30: R\$ 35,09 45: R\$ 35,79 60: R\$ 36,51



CADERNO BROC 1/4 CD 96FLS X-ROBOTS 5X1
Código: Fábrica: Unidade:
34011 MAXIMA PT/5
F1 F4

UN: R\$ 6,74 AV: R\$ 33,70 15: R\$ 34,40
30: R\$ 35,09 45: R\$ 35,79 60: R\$ 36,51

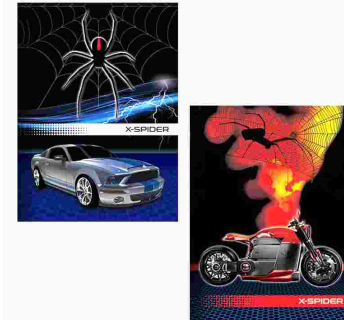

CADERNO BROC 1/4 CD 96FLS X-SPIDER 5X1
Código: Fábrica: Unidade:
34009 MAXIMA PT/5
F1 F4

UN: R\$ 2,49 AV: R\$ 49,80 15: R\$ 49,80
30: R\$ 49,80 45: R\$ 49,80 60: R\$ 49,80



CADERNO BROC 1/4 FLEX 48FLS C/P 20X1
Código: Fábrica: Unidade:
13440 MAXIM/CREDEA PT/20
F1 F4

UN: R\$ 4,07 AV: R\$ 81,36 15: R\$ 83,06
30: R\$ 84,72 45: R\$ 86,42 60: R\$ 88,14



CADERNO BROC 1/4 FLEX 60 FLS 20X1
Código: Fábrika: Unidade:
43269 JANDAINHA PT/20
F1 F4

UN: R\$ 5,23 AV: R\$ 52,30 15: R\$ 53,39
30: R\$ 54,46 45: R\$ 55,55 60: R\$ 56,66



CADERNO BROC 1/4 FLEX 96FLS C/P 10X1
Código: Fábrika: Unidade:
160 MAXIMA/JA PT/10
F1 F4

UN: R\$ 3,25 AV: R\$ 32,54 15: R\$ 33,22
30: R\$ 33,88 45: R\$ 34,56 60: R\$ 35,25



CADERNO BROC 1/4 QUADRICULADO 80FLS 10X1
Código: Fábrika: Unidade:
44715 SULAMERICANA PT/10
F1 F4

UN: R\$ 3,03 AV: R\$ 60,59 15: R\$ 61,86
30: R\$ 63,09 45: R\$ 64,36 60: R\$ 65,64



CADERNO BROC 40 FLS 1/4 CALIGRAFIA 20X1
Código: Fábrika: Unidade:
14041 PANAMERICANA PT/20
F1 F4

UN: R\$ 11,30 AV: R\$ 56,49 15: R\$ 57,66
30: R\$ 58,82 45: R\$ 59,99 60: R\$ 61,19



CADERNO CD 1MAT 80 FLS POP 5X1
Código: Fábrika: Unidade:
34080 CADERSIL PT/5
F1 F4

UN: R\$ 12,83 AV: R\$ 51,32 15: R\$ 52,39
30: R\$ 53,44 45: R\$ 54,50 60: R\$ 55,59



CADERNO CD 1MAT 80FLS ESSENC PRETO 4X1
Código: Fábrika: Unidade:
50701 CREDEAL PT/4
F1 F4

UN: R\$ 13,95 AV: R\$ 69,74 15: R\$ 71,19
30: R\$ 72,62 45: R\$ 74,07 60: R\$ 75,55



CADERNO CD 1MAT 80FLS ESSENCIALE 5X1
Código: Fábrika: Unidade:
43658 CREDEAL PT/5
F1 F4

UN: R\$ 14,53 AV: R\$ 58,11 15: R\$ 59,32
30: R\$ 60,51 45: R\$ 61,72 60: R\$ 62,96



CADERNO CD 1MAT 80FLS MY COLL MASC 4X1
Código: Fábrika: Unidade:
50417 CREDEAL PT/4
F1 F4

UN: R\$ 12,84 AV: R\$ 51,35 15: R\$ 52,42
30: R\$ 53,47 45: R\$ 54,54 60: R\$ 55,63



CADERNO CD 1MAT 80FLS PERFORMANCE 4X1
Código: Fábrika: Unidade:
49105 CREDEAL PT/4
F1 F4

UN: R\$ 17,43 AV: R\$ 17,43 15: R\$ 17,79
30: R\$ 18,14 45: R\$ 18,51 60: R\$ 18,88



CADERNO CD 1MAT 96FLS AYRTON SENA UN
Código: Fábrika: Unidade:
40099 POMBO UN/1
F1 F4

UN: R\$ 17,44 AV: R\$ 104,61 15: R\$ 106,79
30: R\$ 108,93 45: R\$ 111,11 60: R\$ 113,33

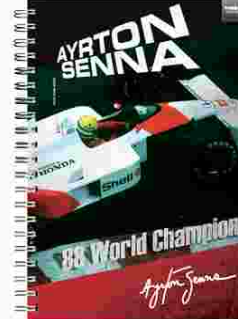

CADERNO CD 1MAT 96FLS AYRTON SENA 6X1
Código: Fábrika: Unidade:
27829 POMBO PT/6
F1 F4

UN: R\$ 12,78 AV: R\$ 76,66 15: R\$ 78,25
30: R\$ 79,82 45: R\$ 81,41 60: R\$ 83,04

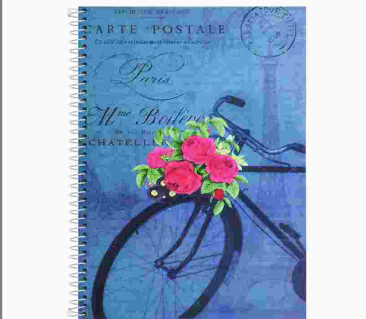

CADERNO CD 1MAT 96FLS BICYCLE 6X1
Código: Fábrika: Unidade:
33757 MAXIMA PT/6
F1 F4

UN: R\$ 11,98 AV: R\$ 71,89 15: R\$ 73,39
30: R\$ 74,86 45: R\$ 76,36 60: R\$ 77,88

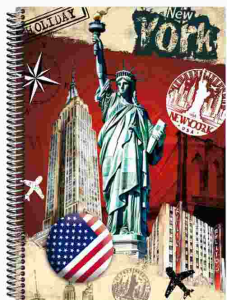

CADERNO CD 1MAT 96FLS CITY TOUR 6X1
Código: Fábrika: Unidade:
33269 MAXIMA PT/6
F1 F4

UN: R\$ 14,14 AV: R\$ 84,85 15: R\$ 86,62
30: R\$ 88,35 45: R\$ 90,12 60: R\$ 91,92

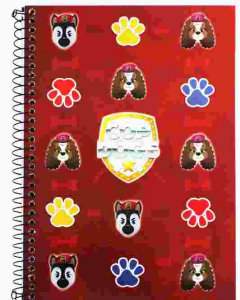

CADERNO CD 1MAT 96FLS COPDOGS B/A 6X1
Código: Fábrika: Unidade:
50901 MAXIMA PT/6
F1 F4

UN: R\$ 14,14 AV: R\$ 84,85 15: R\$ 86,62
30: R\$ 88,35 45: R\$ 90,12 60: R\$ 91,92



CADERNO CD 1MAT 96FLS DINO B/A 6X1
Código: Fábrika: Unidade:
36305 MAXIMA PT/6
F1 F4

UN: R\$ 14,14 AV: R\$ 84,85 15: R\$ 86,62
30: R\$ 88,35 45: R\$ 90,12 60: R\$ 91,92



CADERNO CD 1MAT 96FLS FLAMINGO B/A 6X1
Código: Fábrika: Unidade:
33777 MAXIMA PT/6
F1 F4

UN: R\$ 13,56 AV: R\$ 81,36 15: R\$ 83,06
30: R\$ 84,72 45: R\$ 86,42 60: R\$ 88,14

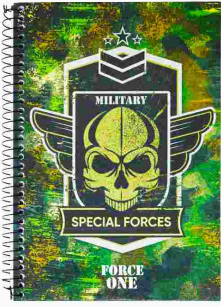

CADERNO CD 1MAT 96FLS FORCE ONE 6X1

Código: 44814 Fábrica: MAXIMA Unidade: PT/6 F1 F4

UN: R\$ 12,50 AV: R\$ 74,98 15: R\$ 76,54
30: R\$ 78,07 45: R\$ 79,63 60: R\$ 81,22



CADERNO CD 1MAT 96FLS FURRY BEA B/A 6X1

Código: 37733 Fábrica: MAXIMA Unidade: PT/6 F1 F4

UN: R\$ 17,43 AV: R\$ 17,43 15: R\$ 17,79
30: R\$ 18,14 45: R\$ 18,51 60: R\$ 18,88

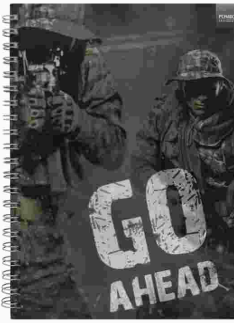

CADERNO CD 1MAT 96FLS GO AHEAD UN

Código: 33356 Fábrica: POMBO Unidade: UN/1 F1 F4

UN: R\$ 13,56 AV: R\$ 81,36 15: R\$ 83,06
30: R\$ 84,72 45: R\$ 86,42 60: R\$ 88,14

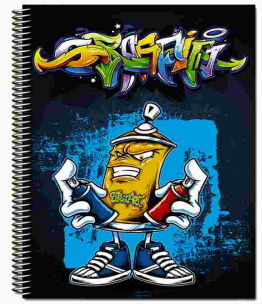

CADERNO CD 1MAT 96FLS GRAFFIX 6X1

Código: 36131 Fábrica: MAXIMA Unidade: PT/6 F1 F4

UN: R\$ 14,12 AV: R\$ 56,49 15: R\$ 57,66
30: R\$ 58,82 45: R\$ 59,99 60: R\$ 61,19

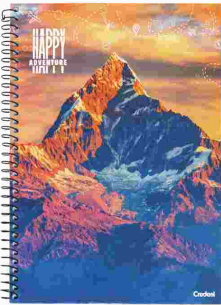

CADERNO CD 1MAT 96FLS HAPPY ADVENTU 4X1

Código: 45838 Fábrica: CREDEAL Unidade: PT/4 F1 F4

UN: R\$ 84,85 AV: R\$ 84,85 15: R\$ 86,62
30: R\$ 88,35 45: R\$ 90,12 60: R\$ 91,92



CADERNO CD 1MAT 96FLS HAPPY TRI B/A 5X1

Código: 23718 Fábrica: MAXIMA Unidade: UN/1 F1 F4

UN: R\$ 13,56 AV: R\$ 81,36 15: R\$ 83,06
30: R\$ 84,72 45: R\$ 86,42 60: R\$ 88,14



CADERNO CD 1MAT 96FLS JEANS WORLD 6X1

Código: 29793 Fábrica: MAXIMA Unidade: PT/6 F1 F4

UN: R\$ 13,56 AV: R\$ 81,36 15: R\$ 83,06
30: R\$ 84,72 45: R\$ 86,42 60: R\$ 88,14



CADERNO CD 1MAT 96FLS LINDINHAS 6X1

Código: 26482 Fábrica: MAXIMA Unidade: PT/6 F1 F4

UN: R\$ 12,50 AV: R\$ 74,98 15: R\$ 76,54
30: R\$ 78,07 45: R\$ 79,63 60: R\$ 81,22



CADERNO CD 1MAT 96FLS LOUISE B/A 6X1

Código: 37735 Fábrica: MAXIMA Unidade: PT/6 F1 F4

UN: R\$ 13,56 AV: R\$ 81,36 15: R\$ 83,06
30: R\$ 84,72 45: R\$ 86,42 60: R\$ 88,14

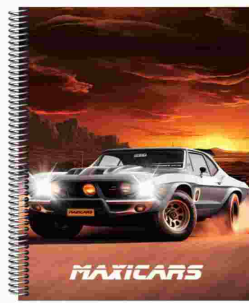

CADERNO CD 1MAT 96FLS MAXICARS 6X1

Código: 26637 Fábrica: MAXIMA Unidade: PT/6 F1 F4

UN: R\$ 13,56 AV: R\$ 81,36 15: R\$ 83,06
30: R\$ 84,72 45: R\$ 86,42 60: R\$ 88,14

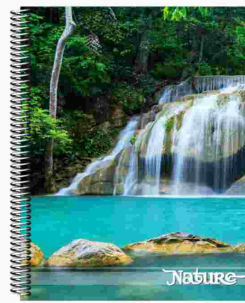

CADERNO CD 1MAT 96FLS NATURE 6X1

Código: 34308 Fábrica: MAXIMA Unidade: PT/6 F1 F4

UN: R\$ 13,56 AV: R\$ 81,36 15: R\$ 83,06
30: R\$ 84,72 45: R\$ 86,42 60: R\$ 88,14



CADERNO CD 1MAT 96FLS OP ART 6X1

Código: 40833 Fábrica: MAXIMA Unidade: PT/6 F1 F4

UN: R\$ 13,56 AV: R\$ 81,36 15: R\$ 83,06
30: R\$ 84,72 45: R\$ 86,42 60: R\$ 88,14

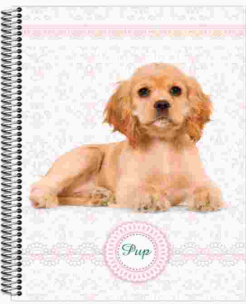

CADERNO CD 1MAT 96FLS PUP 6X1

Código: 26478 Fábrica: MAXIMA Unidade: PT/6 F1 F4

UN: R\$ 14,14 AV: R\$ 84,85 15: R\$ 86,62
30: R\$ 88,35 45: R\$ 90,12 60: R\$ 91,92

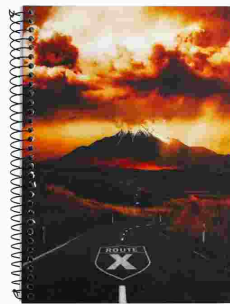

CADERNO CD 1MAT 96FLS ROUTE B/A 6X1

Código: 50900 Fábrica: MAXIMA Unidade: PT/6 F1 F4

UN: R\$ 12,50 AV: R\$ 74,98 15: R\$ 76,54
30: R\$ 78,07 45: R\$ 79,63 60: R\$ 81,22



CADERNO CD 1MAT 96FLS SEASON B/A 6X1

Código: 33758 Fábrica: MAXIMA Unidade: PT/6 F1 F4

UN: R\$ 13,56 AV: R\$ 81,36 15: R\$ 83,06
30: R\$ 84,72 45: R\$ 86,42 60: R\$ 88,14

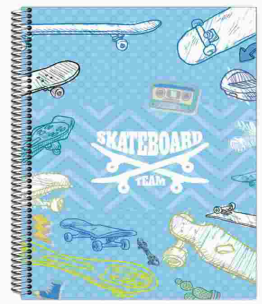

CADERNO CD 1MAT 96FLS SKATE 6X1

Código: 37825 Fábrica: MAXIMA Unidade: PT/6 F1 F4

UN: R\$ 14,14 AV: R\$ 84,85 15: R\$ 86,62
30: R\$ 88,35 45: R\$ 90,12 60: R\$ 91,92

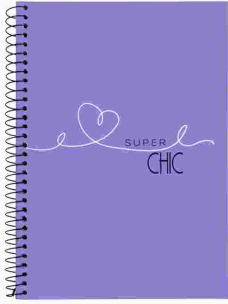

CADERNO CD 1MAT 96FLS SUPER CHI B/A 6X1
Código: 37990 Fábrica: MAXIMA Unidade: PT/6 F1 F4

UN: R\$ 13,56 AV: R\$ 81,36 15: R\$ 83,06
30: R\$ 84,72 45: R\$ 86,42 60: R\$ 88,14



CADERNO CD 1MAT 96FLS X-ANIMAL 6X1
Código: 26480 Fábrica: MAXIMA Unidade: PT/6 F1 F4

UN: R\$ 14,14 AV: R\$ 84,85 15: R\$ 86,62
30: R\$ 88,35 45: R\$ 90,12 60: R\$ 91,92

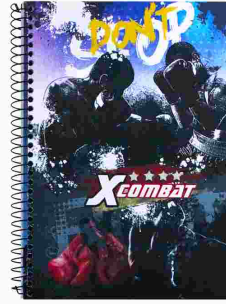

CADERNO CD 1MAT 96FLS X-COMBAT B/A 6X1
Código: 30653 Fábrica: MAXIMA Unidade: PT/6 F1 F4

UN: R\$ 13,56 AV: R\$ 81,36 15: R\$ 83,06
30: R\$ 84,72 45: R\$ 86,42 60: R\$ 88,14



CADERNO CD 1MAT 96FLS X-DAYS 6X1
Código: 50703 Fábrica: MAXIMA Unidade: PT/6 F1 F4

UN: R\$ 13,56 AV: R\$ 81,36 15: R\$ 83,06
30: R\$ 84,72 45: R\$ 86,42 60: R\$ 88,14



CADERNO CD 1MAT 96FLS X-MOTO 6X1
Código: 26676 Fábrica: MAXIMA Unidade: PT/6 F1 F4

UN: R\$ 13,56 AV: R\$ 81,36 15: R\$ 83,06
30: R\$ 84,72 45: R\$ 86,42 60: R\$ 88,14

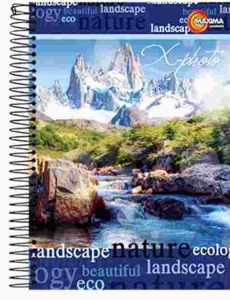

CADERNO CD 1MAT 96FLS X-PHOTO 6X1
Código: 27459 Fábrica: MAXIMA Unidade: PT/6 F1 F4

UN: R\$ 13,56 AV: R\$ 81,36 15: R\$ 83,06
30: R\$ 84,72 45: R\$ 86,42 60: R\$ 88,14

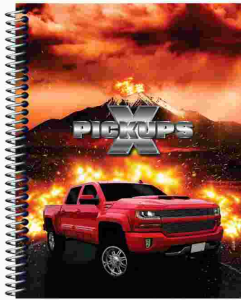

CADERNO CD 1MAT 96FLS X-PICKUP 6X1
Código: 26484 Fábrica: MAXIMA Unidade: PT/6 F1 F4

UN: R\$ 13,56 AV: R\$ 81,36 15: R\$ 83,06
30: R\$ 84,72 45: R\$ 86,42 60: R\$ 88,14



CADERNO CD 1MAT 96FLS X-SPORT 6X1
Código: 29812 Fábrica: MAXIMA Unidade: PT/6 F1 F4

UN: R\$ 11,98 AV: R\$ 71,89 15: R\$ 73,39
30: R\$ 74,86 45: R\$ 76,36 60: R\$ 77,88



CADERNO CD 1MAT 96FLS X-STUDIO 6X1
Código: 32516 Fábrica: MAXIMA Unidade: PT/6 F1 F4

UN: R\$ 13,56 AV: R\$ 81,36 15: R\$ 83,06
30: R\$ 84,72 45: R\$ 86,42 60: R\$ 88,14

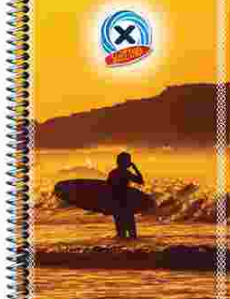

CADERNO CD 1MAT 96FLS X-SURFING 6X1
Código: 33270 Fábrica: MAXIMA Unidade: PT/6 F1 F4

UN: R\$ 14,53 AV: R\$ 58,11 15: R\$ 59,32
30: R\$ 60,51 45: R\$ 61,72 60: R\$ 62,96



CADERNO CD 1MAT 96FLS 177X240MM 4X1
Código: 50440 Fábrica: TILIBRA Unidade: PT/4 F1 F4

UN: R\$ 10,45 AV: R\$ 10,45 15: R\$ 10,67
30: R\$ 10,88 45: R\$ 11,10 60: R\$ 11,32

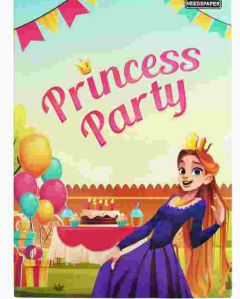

CADERNO CD PEDAG QUADRICULADO 48FLS UN
Código: 45827 Fábrica: NEEDS Unidade: UN/1 F1 F4

UN: R\$ 10,46 AV: R\$ 104,61 15: R\$ 106,79
30: R\$ 108,93 45: R\$ 111,11 60: R\$ 113,33

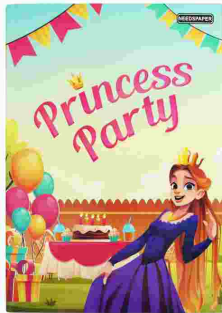

CADERNO CD PEDAG QUADRICULADO 48FLS 10X1
Código: 45822 Fábrica: NEEDS Unidade: PT/10 F1 F4

UN: R\$ 21,21 AV: R\$ 84,85 15: R\$ 86,62
30: R\$ 88,35 45: R\$ 90,12 60: R\$ 91,92

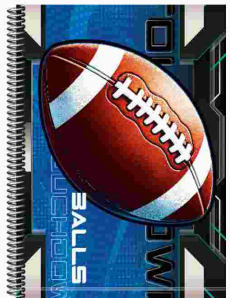

CADERNO CD 10MAT 160FLS BALLS 4X1
Código: 50898 Fábrica: MAXIMA Unidade: PT/4 F1 F4

UN: R\$ 26,73 AV: R\$ 26,73 15: R\$ 27,28
30: R\$ 27,83 45: R\$ 28,39 60: R\$ 28,95

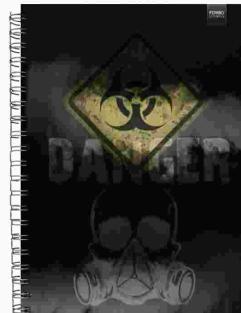

CADERNO CD 10MAT 160FLS GO AHEAD UN
Código: 33361 Fábrica: POMBO Unidade: UN/1 F1 F4

UN: R\$ 29,06 AV: R\$ 174,37 15: R\$ 178,00
30: R\$ 181,56 45: R\$ 185,19 60: R\$ 188,89

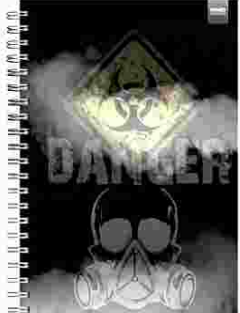

CADERNO CD 10MAT 160FLS GO AHEAD 6X1
Código: 32805 Fábrica: POMBO Unidade: PT/6 F1 F4

UN: R\$ 21,21 AV: R\$ 84,85 15: R\$ 86,62
30: R\$ 88,35 45: R\$ 90,12 60: R\$ 91,92

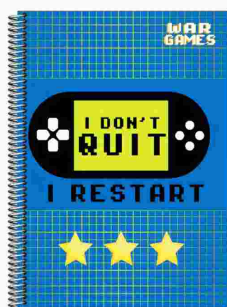

CADERNO CD 10MAT 160FLS WAR GAME 4X1
Código: 50899 Fábrica: MAXIMA Unidade: PT/4 F1 F4

UN: R\$ 23,25 AV: R\$ 69,74 15: R\$ 71,19
30: R\$ 72,62 45: R\$ 74,07 60: R\$ 75,55



CADERNO CD 10MAT 200 FLS X-SPIDE B/A 3X1
Código: 38175 Fábrica: MAXIMA Unidade: PT/3 F1 F4

UN: R\$ 25,57 AV: R\$ 102,29 15: R\$ 104,42
30: R\$ 106,51 45: R\$ 108,64 60: R\$ 110,81

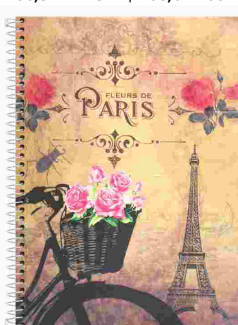

CADERNO CD 10MAT 200FLS BICYCLE 4X1
Código: 33766 Fábrica: MAXIMA Unidade: PT/4 F1 F4

UN: R\$ 24,40 AV: R\$ 97,60 15: R\$ 99,64
30: R\$ 101,63 45: R\$ 103,66 60: R\$ 105,74

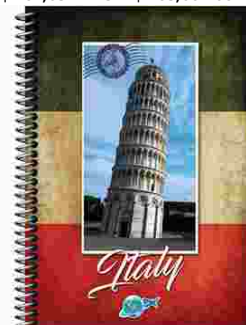

CADERNO CD 10MAT 200FLS CITY TOUR 4X1
Código: 33261 Fábrica: MAXIMA Unidade: PT/4 F1 F4

UN: R\$ 25,57 AV: R\$ 102,29 15: R\$ 104,42
30: R\$ 106,51 45: R\$ 108,64 60: R\$ 110,81



CADERNO CD 10MAT 200FLS FORCE ONE 4X1
Código: 50709 Fábrica: MAXIMA Unidade: PT/4 F1 F4

UN: R\$ 29,05 AV: R\$ 116,21 15: R\$ 118,63
30: R\$ 121,00 45: R\$ 123,42 60: R\$ 125,89

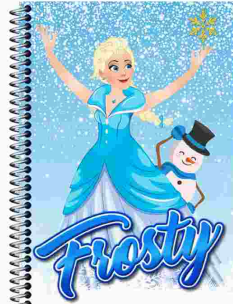

CADERNO CD 10MAT 200FLS FROSTY B/A 4X1
Código: 33765 Fábrica: MAXIMA Unidade: PT/4 F1 F4

UN: R\$ 25,57 AV: R\$ 102,29 15: R\$ 104,42
30: R\$ 106,51 45: R\$ 108,64 60: R\$ 110,81

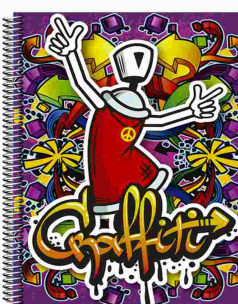

CADERNO CD 10MAT 200FLS GRAFFIX 4X1
Código: 36289 Fábrica: MAXIMA Unidade: PT/4 F1 F4

UN: R\$ 30,61 AV: R\$ 91,83 15: R\$ 93,74
30: R\$ 95,62 45: R\$ 97,53 60: R\$ 99,48

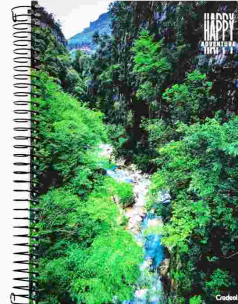

CADERNO CD 10MAT 200FLS HAPPY ADVENT 3X1
Código: 43657 Fábrica: CREDEAL Unidade: PT/3 F1 F4

UN: R\$ 24,40 AV: R\$ 97,60 15: R\$ 99,64
30: R\$ 101,63 45: R\$ 103,66 60: R\$ 105,74



CADERNO CD 10MAT 200FLS JEANS WORLD 4X1
Código: 24633 Fábrica: MAXIMA Unidade: PT/4 F1 F4

UN: R\$ 25,57 AV: R\$ 102,29 15: R\$ 104,42
30: R\$ 106,51 45: R\$ 108,64 60: R\$ 110,81

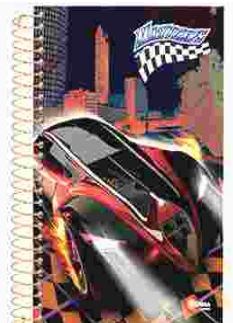

CADERNO CD 10MAT 200FLS MAXICARS 4X1
Código: 24635 Fábrica: MAXIMA Unidade: PT/4 F1 F4

UN: R\$ 29,06 AV: R\$ 87,18 15: R\$ 88,99
30: R\$ 90,77 45: R\$ 92,59 60: R\$ 94,44



CADERNO CD 10MAT 200FLS MY COLL FEM 3X1
Código: 43804 Fábrica: CREDEAL Unidade: PT/3 F1 F4

UN: R\$ 27,12 AV: R\$ 81,36 15: R\$ 83,06
30: R\$ 84,72 45: R\$ 86,42 60: R\$ 88,14

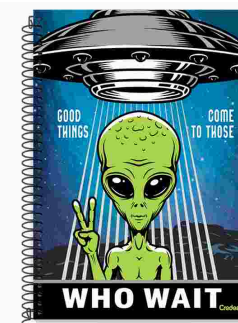

CADERNO CD 10MAT 200FLS MY COLL MASC 3X1
Código: 43803 Fábrica: CREDEAL Unidade: PT/3 F1 F4

UN: R\$ 24,40 AV: R\$ 97,60 15: R\$ 99,64
30: R\$ 101,63 45: R\$ 103,66 60: R\$ 105,74

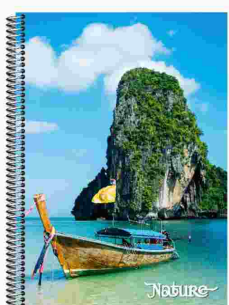

CADERNO CD 10MAT 200FLS NATURE 4X1
Código: 50706 Fábrica: MAXIMA Unidade: PT/4 F1 F4

UN: R\$ 29,05 AV: R\$ 116,21 15: R\$ 118,63
30: R\$ 121,00 45: R\$ 123,42 60: R\$ 125,89



CADERNO CD 10MAT 200FLS PUP B/A4X1
Código: 37682 Fábrica: MAXIMA Unidade: PT/4 F1 F4

UN: R\$ 25,57 AV: R\$ 102,29 15: R\$ 104,42
30: R\$ 106,51 45: R\$ 108,64 60: R\$ 110,81

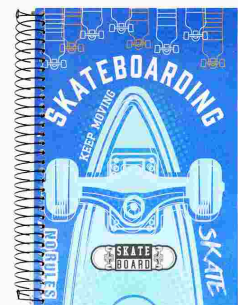

CADERNO CD 10MAT 200FLS SKATE 4X1
Código: 34348 Fábrica: MAXIMA Unidade: PT/4 F1 F4

UN: R\$ 25,57 AV: R\$ 102,29 15: R\$ 104,42
30: R\$ 106,51 45: R\$ 108,64 60: R\$ 110,81

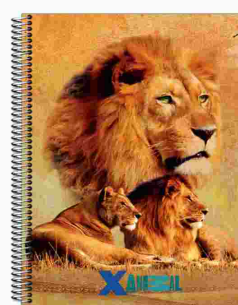

CADERNO CD 10MAT 200FLS X-ANIMAL 4X1
Código: 24634 Fábrica: MAXIMA Unidade: PT/4 F1 F4

UN: R\$ 25,57 AV: R\$ 102,29 15: R\$ 104,42
30: R\$ 106,51 45: R\$ 108,64 60: R\$ 110,81

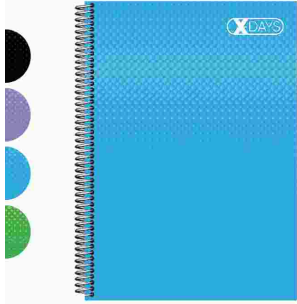

CADERNO CD 10MAT 200FLS X-DAYS 4X1
Código: 50704 Fábrica: MAXIMA Unidade: PT/4 F1 F4

UN: R\$ 25,57 AV: R\$ 102,29 15: R\$ 104,42
30: R\$ 106,51 45: R\$ 108,64 60: R\$ 110,81

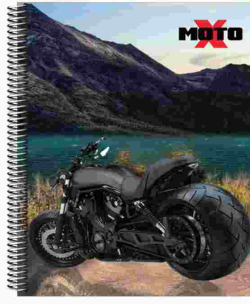

CADERNO CD 10MAT 200FLS X-MOTO 4X1
Código: 20653 Fábrica: MAXIMA Unidade: PT/4 F1 F4

UN: R\$ 25,57 AV: R\$ 102,29 15: R\$ 104,42
30: R\$ 106,51 45: R\$ 108,64 60: R\$ 110,81



CADERNO CD 10MAT 200FLS X-PHOTO 4X1
Código: 24319 Fábrica: MAXIMA Unidade: PT/4 F1 F4

UN: R\$ 25,57 AV: R\$ 102,29 15: R\$ 104,42
30: R\$ 106,51 45: R\$ 108,64 60: R\$ 110,81

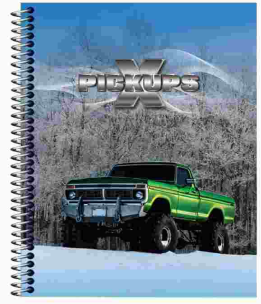

CADERNO CD 10MAT 200FLS X-PICKUP 4X1
Código: 26288 Fábrica: MAXIMA Unidade: PT/4 F1 F4

UN: R\$ 25,57 AV: R\$ 102,29 15: R\$ 104,42
30: R\$ 106,51 45: R\$ 108,64 60: R\$ 110,81

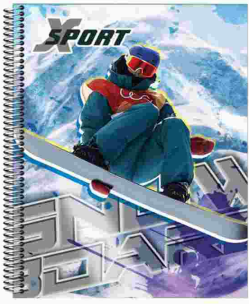

CADERNO CD 10MAT 200FLS X-SPORTS 4X1
Código: 24305 Fábrica: MAXIMA Unidade: PT/4 F1 F4

UN: R\$ 25,57 AV: R\$ 102,29 15: R\$ 104,42
30: R\$ 106,51 45: R\$ 108,64 60: R\$ 110,81

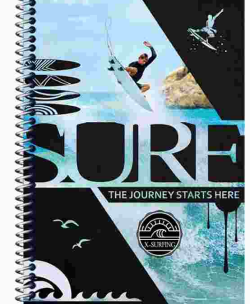

CADERNO CD 10MAT 200FLS X-SURFING 4X1
Código: 28777 Fábrica: MAXIMA Unidade: PT/4 F1 F4

UN: R\$ 6,99 AV: R\$ 6,99 15: R\$ 6,99
30: R\$ 6,99 45: R\$ 6,99 60: R\$ 6,99



CADERNO CD 1/4 ESP 96FLS UN
Código: 45865 Fábrica: SULAMERICANA Unidade: PT/1 F1 F4

UN: R\$ 10,89 AV: R\$ 10,89 15: R\$ 10,89
30: R\$ 10,89 45: R\$ 10,89 60: R\$ 10,89

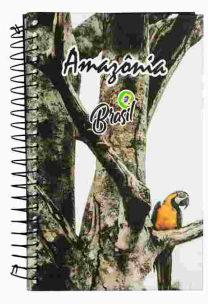

CADERNO CD 1/4 ESP 200FLS UN
Código: 45768 Fábrica: NEEDS Unidade: UN/1 F1 F4

UN: R\$ 12,78 AV: R\$ 51,14 15: R\$ 52,20
30: R\$ 53,25 45: R\$ 54,31 60: R\$ 55,40



CADERNO CD 1/4 ESP 200FLS X-PHOTO 4X1
Código: 34013 Fábrica: MAXIMA Unidade: PT/4 F1 F4

UN: R\$ 36,81 AV: R\$ 110,43 15: R\$ 112,73
30: R\$ 114,98 45: R\$ 117,28 60: R\$ 119,63

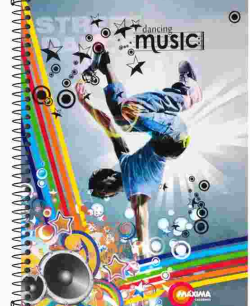

CADERNO CD 15MAT 300FLS DANCING B/A 3X1
Código: 36669 Fábrica: MAXIMA Unidade: PT/3 F1 F4

UN: R\$ 36,81 AV: R\$ 110,43 15: R\$ 112,73
30: R\$ 114,98 45: R\$ 117,28 60: R\$ 119,63



CADERNO CD 15MAT 300FLS I LIKE B/A 3X1
Código: 36134 Fábrica: MAXIMA Unidade: PT/3 F1 F4

UN: R\$ 31,00 AV: R\$ 92,99 15: R\$ 94,93
30: R\$ 96,83 45: R\$ 98,76 60: R\$ 100,74

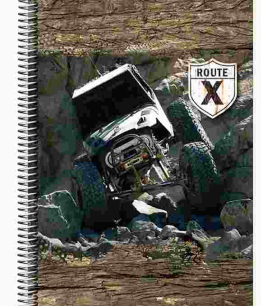

CADERNO CD 15MAT 300FLS ROUTE 3X1
Código: 37992 Fábrica: MAXIMA Unidade: PT/3 F1 F4

UN: R\$ 31,00 AV: R\$ 92,99 15: R\$ 94,93
30: R\$ 96,83 45: R\$ 98,76 60: R\$ 100,74



CADERNO CD 15MAT 300FLS WONDERLA B/A 3X1
Código: 36687 Fábrica: MAXIMA Unidade: PT/3 F1 F4

UN: R\$ 34,10 AV: R\$ 102,29 15: R\$ 104,42
30: R\$ 106,51 45: R\$ 108,64 60: R\$ 110,81



CADERNO CD 15MAT 300FLS X-ANIMAL 3X1
Código: 20658 Fábrica: MAXIMA Unidade: PT/3 F1 F4

UN: R\$ 34,10 AV: R\$ 102,29 15: R\$ 104,42
30: R\$ 106,51 45: R\$ 108,64 60: R\$ 110,81



CADERNO CD 15MAT 300FLS X-DAYS 3X1
Código: 50705 Fábrica: MAXIMA Unidade: PT/3 F1 F4

UN: R\$ 32,93 AV: R\$ 98,80 15: R\$ 100,86
30: R\$ 102,88 45: R\$ 104,94 60: R\$ 107,03



CADERNO CD 15MAT 300FLS X-GIRLS 3X1
Código: 24380 Fábrica: MAXIMA Unidade: PT/3 F1 F4

UN: R\$ 34,10 AV: R\$ 102,29 15: R\$ 104,42
30: R\$ 106,51 45: R\$ 108,64 60: R\$ 110,81



CADERNO CD 15MAT 300FLS X-PHOTO 3X1

Código: 24308 Fábrica: MAXIMA Unidade: PT/3 F1 F4

UN: R\$ 31,00 AV: R\$ 92,99 15: R\$ 94,93
30: R\$ 96,83 45: R\$ 98,76 60: R\$ 100,74

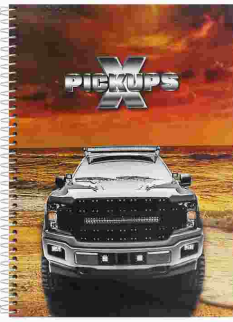

CADERNO CD 15MAT 300FLS X-PICKUP 3X1

Código: 33769 Fábrica: MAXIMA Unidade: PT/3 F1 F4

UN: R\$ 33,71 AV: R\$ 101,13 15: R\$ 103,23
30: R\$ 105,30 45: R\$ 107,40 60: R\$ 109,55



CADERNO CD 16MAT 320FLS LINDINHAS 3X1

Código: 37821 Fábrica: MAXIMA Unidade: PT/3 F1 F4

UN: R\$ 43,59 AV: R\$ 87,18 15: R\$ 88,99
30: R\$ 90,77 45: R\$ 92,59 60: R\$ 94,44

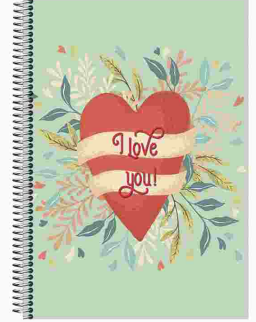

CADERNO CD 20MAT 400FLS LOVE B/A 2X1

Código: 37988 Fábrica: MAXIMA Unidade: PT/2 F1 F4

UN: R\$ 52,31 AV: R\$ 104,61 15: R\$ 106,79
30: R\$ 108,93 45: R\$ 111,11 60: R\$ 113,33

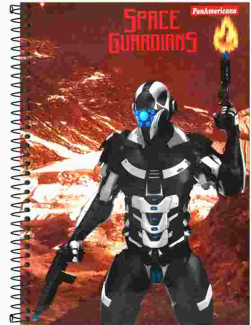

CADERNO CD 20MAT 400FLS SPACE B/A 2X1

Código: 38164 Fábrica: PANAMERICANA Unidade: PT/2 F1 F4

UN: R\$ 52,31 AV: R\$ 104,61 15: R\$ 106,79
30: R\$ 108,93 45: R\$ 111,11 60: R\$ 113,33

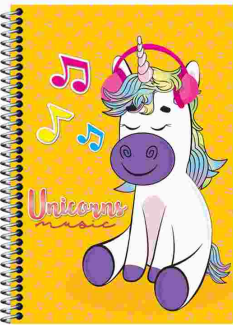

CADERNO CD 20MAT 400FLS UNICORNS B/A2X1

Código: 36650 Fábrica: MAXIMA Unidade: PT/2 F1 F4

UN: R\$ 49,98 AV: R\$ 99,96 15: R\$ 102,05
30: R\$ 104,09 45: R\$ 106,17 60: R\$ 108,29



CADERNO CD 20MAT 400FLS X-GIRLS 2X1

Código: 24383 Fábrica: MAXIMA Unidade: PT/2 F1 F4

UN: R\$ 43,59 AV: R\$ 87,18 15: R\$ 88,99
30: R\$ 90,77 45: R\$ 92,59 60: R\$ 94,44

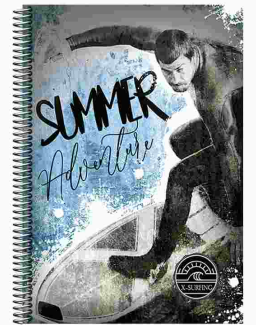

CADERNO CD 20MAT 400FLS X-SURFIN B/A 2X1

Código: 37823 Fábrica: MAXIMA Unidade: PT/2 F1 F4

UN: R\$ 42,26 AV: R\$ 84,51 15: R\$ 86,28
30: R\$ 88,00 45: R\$ 89,76 60: R\$ 91,56

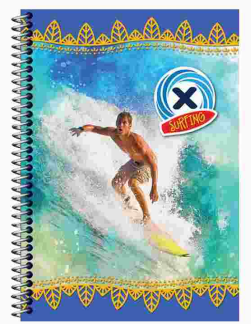

CADERNO CD 20MAT 400FLS X-SURFING 2X1

Código: 33776 Fábrica: MAXIMA Unidade: PT/2 F1 F4

UN: R\$ 13,94 AV: R\$ 13,94 15: R\$ 14,23
30: R\$ 14,51 45: R\$ 14,80 60: R\$ 15,10



CADERNO CD 40FLS CALIGRA 19X24CM PAUVERD

Código: 48077 Fábrica: SAO DOMINGOS Unidade: UN/1 F1 F4

UN: R\$ 11,03 AV: R\$ 11,03 15: R\$ 11,26
30: R\$ 11,49 45: R\$ 11,72 60: R\$ 11,95

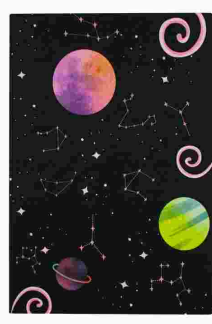

CADERNO COST C/FLEX 25X18CM 32FLS C/P UN

Código: 47917 Fábrica: YIN'S PAPER Unidade: UN/1 F1 F4

UN: R\$ 4,65 AV: R\$ 46,49 15: R\$ 47,46
30: R\$ 48,41 45: R\$ 49,37 60: R\$ 50,36



CADERNO COST 1/4 CD 48FLS AMARE C/P10X1

Código: 24896 Fábrica: MAXIMA Unidade: PT/10 F1 F4

UN: R\$ 4,65 AV: R\$ 46,49 15: R\$ 47,46
30: R\$ 48,41 45: R\$ 49,37 60: R\$ 50,36



CADERNO COST 1/4 CD 48FLS AZUL C/P 10X1

Código: 23221 Fábrica: MAXIMA Unidade: PT/10 F1 F4

UN: R\$ 6,51 AV: R\$ 32,54 15: R\$ 33,22
30: R\$ 33,88 45: R\$ 34,56 60: R\$ 35,25



CADERNO COST 1/4 CD 48FLS COLOR C/P 5X1

Código: 45791 Fábrica: CREDEAL Unidade: PT/5 F1 F4

UN: R\$ 6,97 AV: R\$ 34,86 15: R\$ 35,59
30: R\$ 36,30 45: R\$ 37,03 60: R\$ 37,77



CADERNO COST 1/4 CD 48FLS C/P MAGIC 5X1

Código: 38465 Fábrica: NOVA Unidade: PT/5 F1 F4

UN: R\$ 4,65 AV: R\$ 46,49 15: R\$ 47,46
30: R\$ 48,41 45: R\$ 49,37 60: R\$ 50,36



CADERNO COST 1/4 CD 48FLS VERDE C/P10X1

Código: 27066 Fábrica: MAXIMA Unidade: PT/10 F1 F4

UN: R\$ 4,65 AV: R\$ 46,49 15: R\$ 47,46
30: R\$ 48,41 45: R\$ 49,37 60: R\$ 50,36

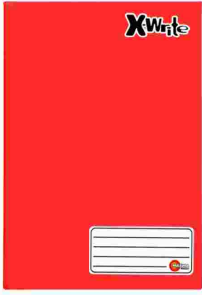

CADERNO COST 1/4 CD 48FLS VERME C/P10X1
Código: Fábrica: Unidade:
26636 MAXIMA PT/10
F1 F4

UN: R\$ 8,71 AV: R\$ 43,54 15: R\$ 44,44
30: R\$ 45,33 45: R\$ 46,24 60: R\$ 47,16



CADERNO COST 1/4 CD 96FLS AZUL C/P 5X1
Código: Fábrica: Unidade:
6166 MAXIM/CREDEA PT/5
F1 F4

UN: R\$ 9,30 AV: R\$ 92,99 15: R\$ 94,93
30: R\$ 96,83 45: R\$ 98,76 60: R\$ 100,74



CADERNO COST 1/4 CD 96FLS BARBI C/P 10X1
Código: Fábrica: Unidade:
35593 FORONI PT/10
F1 F4

UN: R\$ 8,14 AV: R\$ 81,36 15: R\$ 83,06
30: R\$ 84,72 45: R\$ 86,42 60: R\$ 88,14



CADERNO COST 1/4 CD 96FLS FEM C/P 10X1
Código: Fábrica: Unidade:
35335 RENOVO PT/10
F1 F4

UN: R\$ 8,71 AV: R\$ 43,54 15: R\$ 44,44
30: R\$ 45,33 45: R\$ 46,24 60: R\$ 47,16



CADERNO COST 1/4 CD 96FLS VERDE C/P 5X1
Código: Fábrica: Unidade:
19572 MAXIM/CREDEA PT/5
F1 F4

UN: R\$ 8,71 AV: R\$ 43,54 15: R\$ 44,44
30: R\$ 45,33 45: R\$ 46,24 60: R\$ 47,16



CADERNO COST 1/4 CD 96FLS VERME C/P 5X1
Código: Fábrica: Unidade:
6167 CREDEAL PT/5
F1 F4

UN: R\$ 9,30 AV: R\$ 46,49 15: R\$ 47,46
30: R\$ 48,41 45: R\$ 49,37 60: R\$ 50,36

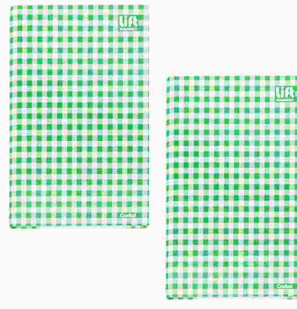

CADERNO COST 1/4 CD 96FLS XADREZ C/P 5X1
Código: Fábrica: Unidade:
43656 CREDEAL PT/5
F1 F4

UN: R\$ 3,36 AV: R\$ 67,19 15: R\$ 68,59
30: R\$ 69,97 45: R\$ 71,36 60: R\$ 72,79



CADERNO DESENHO BROCH 1/4 FLEX 40FL 20X1
Código: Fábrica: Unidade:
46800 JANDAIA PT/20
F1 F4

UN: R\$ 16,27 AV: R\$ 81,36 15: R\$ 83,06
30: R\$ 84,72 45: R\$ 86,42 60: R\$ 88,14



CADERNO DESENHO CD GR MILIMETR 96FLS 5X1
Código: Fábrica: Unidade:
42916 NEEDS PT/5
F1 F4

UN: R\$ 10,80 AV: R\$ 10,80 15: R\$ 11,02
30: R\$ 11,25 45: R\$ 11,47 60: R\$ 11,70



CADERNO DESENHO CD GR 48FLS S/SEDA UN
Código: Fábrica: Unidade:
46731 NEEDS UN/1
F1 F4

UN: R\$ 10,46 AV: R\$ 104,61 15: R\$ 106,79
30: R\$ 108,93 45: R\$ 111,11 60: R\$ 113,33

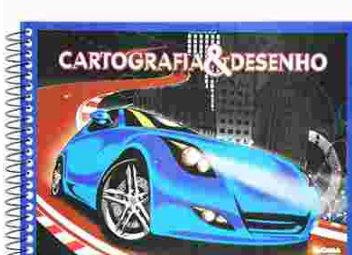

CADERNO DESENHO CD GR 48FLS S/SEDA 10X1
Código: Fábrica: Unidade:
1364 MAXIMA PT/10
F1 F4

UN: R\$ 16,92 AV: R\$ 84,60 15: R\$ 86,36
30: R\$ 88,09 45: R\$ 89,85 60: R\$ 91,64



CADERNO DESENHO CD GR 80FLS VERDE 5X1
Código: Fábrica: Unidade:
50689 CREDEAL PT/5
F1 F4

UN: R\$ 31,97 AV: R\$ 127,87 15: R\$ 130,53
30: R\$ 133,14 45: R\$ 135,80 60: R\$ 138,52



CADERNO DESENHO CD MEIA PAUTA 40FLS 4X1
Código: Fábrica: Unidade:
49107 CREDEAL PT/4
F1 F4

UN: R\$ 10,27 AV: R\$ 102,71 15: R\$ 104,85
30: R\$ 106,95 45: R\$ 109,09 60: R\$ 111,27



CADERNO DESENHO CF GR 48FLS C/SEDA 10X1
Código: Fábrica: Unidade:
14042 CREDEAL PT/10
F1 F4

UN: R\$ 6,97 AV: R\$ 69,74 15: R\$ 71,19
30: R\$ 72,62 45: R\$ 74,07 60: R\$ 75,55



CADERNO DESENHO CF GR 48FLS S/SEDA 10X1
Código: Fábrica: Unidade:
43631 CREDEAL PT/10
F1 F4

UN: R\$ 3,08 AV: R\$ 46,21 15: R\$ 47,18
30: R\$ 48,12 45: R\$ 49,08 60: R\$ 50,06



CADERNO DESENHO ESP 1/4 FLEX 40FL 15X1
Código: Fábrica: Unidade:
46946 PANAMERICANA PT/15
F1 F4

UN: R\$ 6,97 AV: R\$ 69,74 15: R\$ 71,19
30: R\$ 72,62 45: R\$ 74,07 60: R\$ 75,55



CADERNO DESENHO GR 48FLS S/SEDA FLE 10X1
Código: 24704 Fábrica: MAXIMA Unidade: PT/10 F1 F4

UN: R\$ 10,46 AV: R\$ 104,61 15: R\$ 106,79
30: R\$ 108,93 45: R\$ 111,11 60: R\$ 113,33



CADERNO DESENHO GR 96FLS S/SEDA FLE 10X1
Código: 19178 Fábrica: NEEDS Unidade: PT/10 F1 F4

UN: R\$ 11,62 AV: R\$ 58,11 15: R\$ 59,32
30: R\$ 60,51 45: R\$ 61,72 60: R\$ 62,96

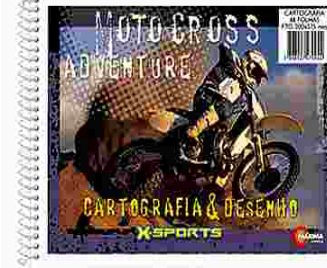

CADERNO DESENHO GR 96FLS S/SEDA FLEX 5X1
Código: 24703 Fábrica: MAXIMA Unidade: PT/5 F1 F4

UN: R\$ 7,67 AV: R\$ 38,35 15: R\$ 39,15
30: R\$ 39,93 45: R\$ 40,73 60: R\$ 41,55



CADERNO ESP 1/4 CD 96FLS PRINCY 5X1
Código: 38462 Fábrica: NOVA Unidade: PT/5 F1 F4

UN: R\$ 3,49 AV: R\$ 69,74 15: R\$ 71,19
30: R\$ 72,62 45: R\$ 74,07 60: R\$ 75,55



CADERNO ESP 1/4 FLEX 48FLS C/P 20X1
Código: 23469 Fábrica: MAXIMA Unidade: PT/20 F1 F4

UN: R\$ 6,97 AV: R\$ 69,74 15: R\$ 71,19
30: R\$ 72,62 45: R\$ 74,07 60: R\$ 75,55



CADERNO ESP 1/4 FLEX 96FLS C/P 10X1
Código: 1366 Fábrica: MAXI/3B/PAN Unidade: PT/10 F1 F4

UN: R\$ 4,64 AV: R\$ 4,64 15: R\$ 4,74
30: R\$ 4,83 45: R\$ 4,93 60: R\$ 5,02

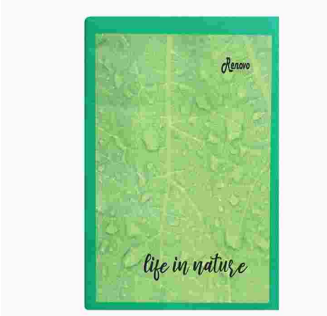

CADERNO FLEX 1/4 96FLS C/P UN
Código: 42446 Fábrica: MAXIMA Unidade: UN/1 F1 F4

UN: R\$ 13,94 AV: R\$ 13,94 15: R\$ 14,23
30: R\$ 14,51 45: R\$ 14,80 60: R\$ 15,10



CADERNO LIVRO ATA 50FLS UN
Código: 42149 Fábrica: PAGINABRASIL Unidade: UN/1 F1 F4

UN: R\$ 13,95 AV: R\$ 139,49 15: R\$ 142,39
30: R\$ 145,25 45: R\$ 148,14 60: R\$ 151,11



CADERNO LIVRO ATA 50FLS 10X1
Código: 8038 Fábrica: PAGINABRASIL Unidade: PT/10 F1 F4

UN: R\$ 41,08 AV: R\$ 41,08 15: R\$ 41,93
30: R\$ 42,77 45: R\$ 43,63 60: R\$ 44,50

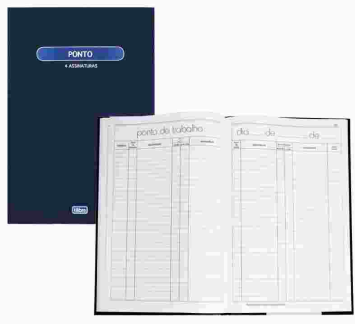

CADERNO LIVRO ATA 100FLS GDE UN
Código: 42052 Fábrica: TILIBRA Unidade: UN/1 F1 F4

UN: R\$ 19,74 AV: R\$ 19,74 15: R\$ 20,15
30: R\$ 20,56 45: R\$ 20,97 60: R\$ 21,39



CADERNO LIVRO ATA 100FLS UN
Código: 41692 Fábrica: GRIFFE/PAGIN Unidade: UN/1 F1 F4

UN: R\$ 40,67 AV: R\$ 40,67 15: R\$ 41,52
30: R\$ 42,35 45: R\$ 43,20 60: R\$ 44,07



CADERNO LIVRO ATA 200FLS UN
Código: 41685 Fábrica: PAGINABRASIL Unidade: UN/1 F1 F4

UN: R\$ 40,69 AV: R\$ 122,06 15: R\$ 124,59
30: R\$ 127,08 45: R\$ 129,63 60: R\$ 132,22



CADERNO LIVRO ATA 200FLS 3X1
Código: 35263 Fábrica: PAGINABRASIL Unidade: PT/3 F1 F4

UN: R\$ 10,00 AV: R\$ 49,98 15: R\$ 51,02
30: R\$ 52,04 45: R\$ 53,08 60: R\$ 54,14



CADERNO MUSICA CD 1/4 ESP 80 FLS 5X1
Código: 43536 Fábrica: CREDEAL Unidade: PT/5 F1 F4

UN: R\$ 10,00 AV: R\$ 49,98 15: R\$ 51,02
30: R\$ 52,04 45: R\$ 53,08 60: R\$ 54,14



CADERNO MUSICA CF ESP 50 FLS 5X1
Código: 43635 Fábrica: CREDEAL Unidade: PT/5 F1 F4

UN: R\$ 29,05 AV: R\$ 29,05 15: R\$ 29,66
30: R\$ 30,25 45: R\$ 30,85 60: R\$ 31,47

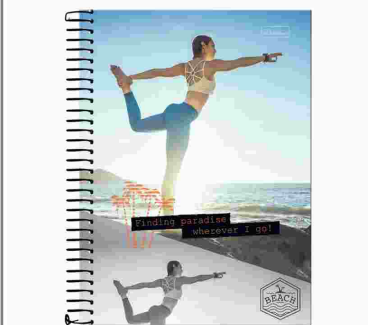

CADERNO PASTA 10MAT 200FLS BEACH B/A
Código: 21566 Fábrica: CADERSIL Unidade: UN/1 F1 F4

UN: R\$ 4,37 AV: R\$ 4,37 15: R\$ 4,46
30: R\$ 4,55 45: R\$ 4,64 60: R\$ 4,73



CAIXA ARQ MORTO OF PARDO 36X24X13CM UN
Código: 12480 Fábrica: DELPAP/JUSSA Unidade: UN/1
F1 F4

UN: R\$ 17,03 AV: R\$ 17,03 15: R\$ 17,38
30: R\$ 17,73 45: R\$ 18,09 60: R\$ 18,45

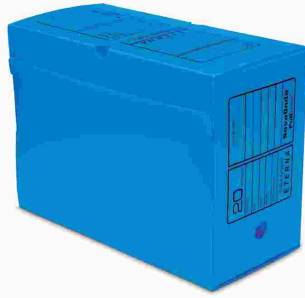

CAIXA ARQ MORTO POLION 30X18,5X39CM AZUL
Código: 49909 Fábrica: POLIBRAS Unidade: PT/1
F1 F4

UN: R\$ 7,82 AV: R\$ 7,82 15: R\$ 7,98
30: R\$ 8,14 45: R\$ 8,30 60: R\$ 8,47



CAIXA ARQ MORTO POLIONDA
Código: 8979 Fábrica: ALAPLAST Unidade: UN/1
F1 F4

UN: R\$ 6,93 AV: R\$ 6,93 15: R\$ 7,08
30: R\$ 7,22 45: R\$ 7,36 60: R\$ 7,51



CAIXA ARQ MORTO POLIONDA AMARELO
Código: 41183 Fábrica: ALAPLAST Unidade: UN/1
F1 F4

UN: R\$ 6,93 AV: R\$ 6,93 15: R\$ 7,08
30: R\$ 7,22 45: R\$ 7,36 60: R\$ 7,51



CAIXA ARQ MORTO POLIONDA AZUL
Código: 46080 Fábrica: ALAPLAST Unidade: UN/1
F1 F4

UN: R\$ 6,93 AV: R\$ 6,93 15: R\$ 7,08
30: R\$ 7,22 45: R\$ 7,36 60: R\$ 7,51



CAIXA ARQ MORTO POLIONDA BRANCO
Código: 46081 Fábrica: ALAPLAST Unidade: UN/1
F1 F4

UN: R\$ 6,93 AV: R\$ 6,93 15: R\$ 7,08
30: R\$ 7,22 45: R\$ 7,36 60: R\$ 7,51



CAIXA ARQ MORTO POLIONDA CINZA
Código: 41184 Fábrica: ALAPLAST Unidade: UN/1
F1 F4

UN: R\$ 13,24 AV: R\$ 662,16 15: R\$ 675,96
30: R\$ 689,48 45: R\$ 703,27 60: R\$ 717,33



CAIXA ARQ MORTO POLIONDA GIG AMARELO 50X1
Código: 42420 Fábrica: ALAPLAST Unidade: PT/50
F1 F4

UN: R\$ 13,24 AV: R\$ 13,24 15: R\$ 13,52
30: R\$ 13,79 45: R\$ 14,06 60: R\$ 14,34



CAIXA ARQ MORTO POLIONDA GIG AMARELO UN
Código: 48783 Fábrica: ALAPLAST Unidade: UN/1
F1 F4

UN: R\$ 13,24 AV: R\$ 13,24 15: R\$ 13,52
30: R\$ 13,79 45: R\$ 14,06 60: R\$ 14,34



CAIXA ARQ MORTO POLIONDA GIG AZUL UN
Código: 48779 Fábrica: ALAPLAST Unidade: UN/1
F1 F4

UN: R\$ 13,24 AV: R\$ 13,24 15: R\$ 13,52
30: R\$ 13,79 45: R\$ 14,06 60: R\$ 14,34



CAIXA ARQ MORTO POLIONDA GIG CINZA UN
Código: 48782 Fábrica: ALAPLAST Unidade: UN/1
F1 F4

UN: R\$ 13,24 AV: R\$ 662,16 15: R\$ 675,96
30: R\$ 689,48 45: R\$ 703,27 60: R\$ 717,33



CAIXA ARQ MORTO POLIONDA GIG PRETA 50X1
Código: 43872 Fábrica: ALAPLAST Unidade: PT/50
F1 F4

UN: R\$ 13,24 AV: R\$ 13,24 15: R\$ 13,52
30: R\$ 13,79 45: R\$ 14,06 60: R\$ 14,34



CAIXA ARQ MORTO POLIONDA GIG PRETO UN
Código: 48784 Fábrica: ALAPLAST Unidade: UN/1
F1 F4

UN: R\$ 13,24 AV: R\$ 13,24 15: R\$ 13,52
30: R\$ 13,79 45: R\$ 14,06 60: R\$ 14,34



CAIXA ARQ MORTO POLIONDA GIG VERDE UN
Código: 48786 Fábrica: ALAPLAST Unidade: UN/1
F1 F4

UN: R\$ 13,24 AV: R\$ 662,16 15: R\$ 675,96
30: R\$ 689,48 45: R\$ 703,27 60: R\$ 717,33



CAIXA ARQ MORTO POLIONDA GIG VERDE 50X1
Código: 43293 Fábrica: ALAPLAST Unidade: PT/50
F1 F4

UN: R\$ 13,24 AV: R\$ 662,16 15: R\$ 675,96
30: R\$ 689,48 45: R\$ 703,27 60: R\$ 717,33



CAIXA ARQ MORTO POLIONDA GIG VERMEL 50X1
Código: 42419 Fábrica: ALAPLAST Unidade: PT/50
F1 F4

UN: R\$ 13,24 AV: R\$ 13,24 15: R\$ 13,52
30: R\$ 13,79 45: R\$ 14,06 60: R\$ 14,34

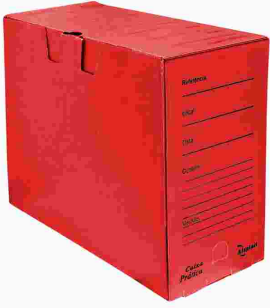

CAIXA ARQ MORTO POLIONDA GIG VERMELHO UN
Código: Fábrica: Unidade:
48785 ALAPLAST UN/1
F1 F4

UN: R\$ 7,82 AV: R\$ 390,97 15: R\$ 399,11
30: R\$ 407,10 45: R\$ 415,24 60: R\$ 423,54



CAIXA ARQ MORTO POLIONDA PRAT AMARE 50X1
Código: Fábrica: Unidade:
42425 ALAPLAST PT/50
F1 F4

UN: R\$ 7,82 AV: R\$ 390,97 15: R\$ 399,11
30: R\$ 407,10 45: R\$ 415,24 60: R\$ 423,54



CAIXA ARQ MORTO POLIONDA PRAT CINZA 50X1
Código: Fábrica: Unidade:
42426 ALAPLAST PT/50
F1 F4

UN: R\$ 7,82 AV: R\$ 390,97 15: R\$ 399,11
30: R\$ 407,10 45: R\$ 415,24 60: R\$ 423,54



CAIXA ARQ MORTO POLIONDA PRAT PRETA 50X1
Código: Fábrica: Unidade:
43079 ALAPLAST PT/50
F1 F4

UN: R\$ 7,82 AV: R\$ 390,97 15: R\$ 399,11
30: R\$ 407,10 45: R\$ 415,24 60: R\$ 423,54

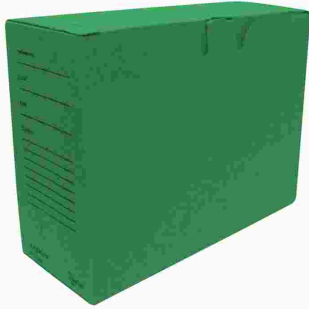

CAIXA ARQ MORTO POLIONDA PRAT VERDE 50X1
Código: Fábrica: Unidade:
42424 ALAPLAST PT/50
F1 F4

UN: R\$ 7,82 AV: R\$ 390,97 15: R\$ 399,11
30: R\$ 407,10 45: R\$ 415,24 60: R\$ 423,54



CAIXA ARQ MORTO POLIONDA PRAT VERME 50X1
Código: Fábrica: Unidade:
42695 ALAPLAST PT/50
F1 F4

UN: R\$ 6,93 AV: R\$ 6,93 15: R\$ 7,08
30: R\$ 7,22 45: R\$ 7,36 60: R\$ 7,51



CAIXA ARQ MORTO POLIONDA PRETO
Código: Fábrica: Unidade:
46079 ALAPLAST UN/1
F1 F4

UN: R\$ 6,93 AV: R\$ 6,93 15: R\$ 7,08
30: R\$ 7,22 45: R\$ 7,36 60: R\$ 7,51



CAIXA ARQ MORTO POLIONDA VERDE
Código: Fábrica: Unidade:
13256 ALAPLAST UN/1
F1 F4

UN: R\$ 6,93 AV: R\$ 6,93 15: R\$ 7,08
30: R\$ 7,22 45: R\$ 7,36 60: R\$ 7,51

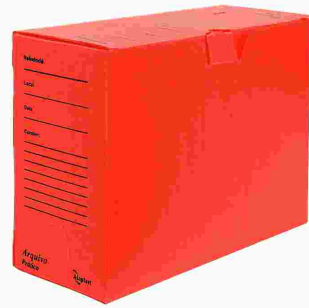

CAIXA ARQ MORTO POLIONDA VERMELHO
Código: Fábrica: Unidade:
41182 ALAPLAST UN/1
F1 F4

UN: R\$ 46,58 AV: R\$ 46,58 15: R\$ 47,55
30: R\$ 48,51 45: R\$ 49,48 60: R\$ 50,46

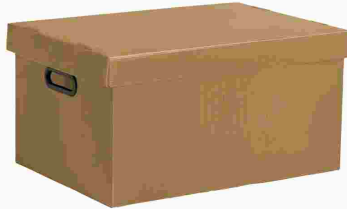

CAIXA ARQ MULTIBOX POLIOND GDE AMADEIRAD
Código: Fábrica: Unidade:
43786 ALAPLAST UN/1
F1 F4

UN: R\$ 46,58 AV: R\$ 46,58 15: R\$ 47,55
30: R\$ 48,51 45: R\$ 49,48 60: R\$ 50,46

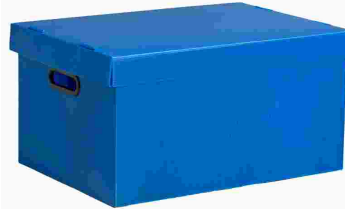

CAIXA ARQ MULTIBOX POLIOND GDE AZUL
Código: Fábrica: Unidade:
43301 ALAPLAST UN/1
F1 F4

UN: R\$ 46,58 AV: R\$ 46,58 15: R\$ 47,55
30: R\$ 48,51 45: R\$ 49,48 60: R\$ 50,46



CAIXA ARQ MULTIBOX POLIOND GDE PRETO
Código: Fábrica: Unidade:
43785 ALAPLAST UN/1
F1 F4

UN: R\$ 40,95 AV: R\$ 40,95 15: R\$ 41,80
30: R\$ 42,64 45: R\$ 43,49 60: R\$ 44,36



CAIXA ARQ MULTIBOX POLIOND MED AMADEIRAD
Código: Fábrica: Unidade:
43788 ALAPLAST UN/1
F1 F4

UN: R\$ 36,31 AV: R\$ 36,31 15: R\$ 37,07
30: R\$ 37,81 45: R\$ 38,57 60: R\$ 39,34

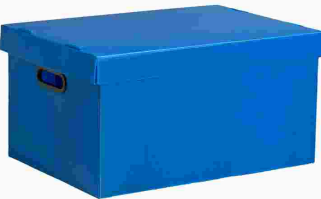

CAIXA ARQ MULTIBOX POLIOND MED AZUL
Código: Fábrica: Unidade:
43300 ALAPLAST UN/1
F1 F4

UN: R\$ 36,31 AV: R\$ 36,31 15: R\$ 37,07
30: R\$ 37,81 45: R\$ 38,57 60: R\$ 39,34



CAIXA ARQ MULTIBOX POLIOND MED PRETO
Código: Fábrica: Unidade:
43787 ALAPLAST UN/1
F1 F4

UN: R\$ 0,88 AV: R\$ 44,00 15: R\$ 44,92
30: R\$ 45,82 45: R\$ 46,73 60: R\$ 47,67

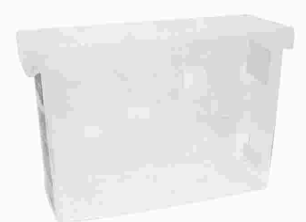

CAIXA ARQ P/PASTA SUSPENSA CRISTAL
Código: Fábrica: Unidade:
42735 DELLO PT/50
F1 F4

UN: R\$ 44,00 AV: R\$ 44,00 15: R\$ 44,92
30: R\$ 45,82 45: R\$ 46,73 60: R\$ 47,67



CAIXA ARQ P/PASTA SUSPensa PRETA
Código: 42742 Fábrica: DELLO Unidade: UN/1
F1 F4

UN: R\$ 54,24 AV: R\$ 54,24 15: R\$ 55,37
30: R\$ 56,48 45: R\$ 57,61 60: R\$ 58,76

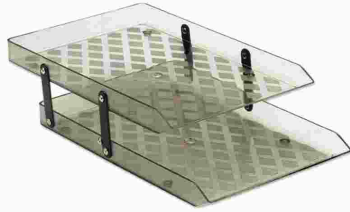

CAIXA CORRESP DUPLA FUME 37X25,5CM 46
Código: 48057 Fábrica: MAXCRIL Unidade: UN/1
F1 F4

UN: R\$ 51,67 AV: R\$ 51,67 15: R\$ 52,74
30: R\$ 53,80 45: R\$ 54,87 60: R\$ 55,97



CAIXA CORRESP DUPLA PRETA 25X35CM 217
Código: 41799 Fábrica: CARBRINK Unidade: UN/1
F1 F4

UN: R\$ 25,83 AV: R\$ 25,83 15: R\$ 26,37
30: R\$ 26,90 45: R\$ 27,44 60: R\$ 27,99

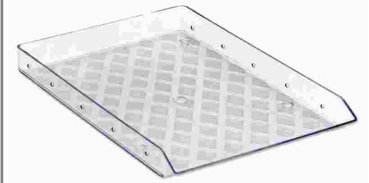

CAIXA CORRESP SIMPL CRISTAL 37X25,5CM 43
Código: 48058 Fábrica: MAXCRIL Unidade: UN/1
F1 F4

UN: R\$ 25,53 AV: R\$ 25,53 15: R\$ 26,06
30: R\$ 26,58 45: R\$ 27,12 60: R\$ 27,66



CAIXA CORRESP SIMPLS PRETA 25X35CM 216
Código: 41797 Fábrica: CARBRINK Unidade: UN/1
F1 F4

UN: R\$ 80,10 AV: R\$ 80,10 15: R\$ 81,77
30: R\$ 83,40 45: R\$ 85,07 60: R\$ 86,77

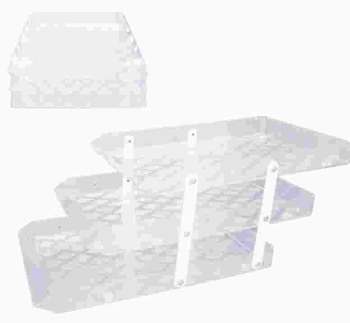

CAIXA CORRESP TRIPLA CRIST 37X25,2CM 50
Código: 44676 Fábrica: MAXCRIL Unidade: UN/1
F1 F4

UN: R\$ 75,46 AV: R\$ 75,46 15: R\$ 77,03
30: R\$ 78,57 45: R\$ 80,14 60: R\$ 81,74



CAIXA CORRESP TRIPLA PRETA NOV VAZAD 441
Código: 50770 Fábrica: CARBRINK Unidade: UN/1
F1 F4

UN: R\$ 77,44 AV: R\$ 77,44 15: R\$ 79,05
30: R\$ 80,64 45: R\$ 82,25 60: R\$ 83,89



CAIXA CORRESP TRIPLA PRETA 25X35CM 218
Código: 41798 Fábrica: CARBRINK Unidade: UN/1
F1 F4

UN: R\$ 33,89 AV: R\$ 33,89 15: R\$ 34,59
30: R\$ 35,29 45: R\$ 35,99 60: R\$ 36,71

21cm
28cm
37cm



CAIXA ORG KRAFT RESINADA 37X28X21CM 1021
Código: 45744 Fábrica: JUSSARA Unidade: UN/1
F1 F4

UN: R\$ 35,94 AV: R\$ 35,94 15: R\$ 36,69
30: R\$ 37,42 45: R\$ 38,17 60: R\$ 38,94

21cm
31cm
44cm



CAIXA ORG KRAFT RESINADA 46X32X23CM 1022
Código: 45745 Fábrica: JUSSARA Unidade: UN/1
F1 F4

UN: R\$ 115,83 AV: R\$ 115,83 15: R\$ 118,24
30: R\$ 120,61 45: R\$ 123,02 60: R\$ 125,48



CAIXA ORGANIZADORA POLIIONDA LISA MED UN
Código: 43012 Fábrica: ALAPLAST Unidade: UN/1
F1 F4

UN: R\$ 1,64 AV: R\$ 41,08 15: R\$ 41,93
30: R\$ 42,77 45: R\$ 43,63 60: R\$ 44,50



CAIXA PAPELAO CV N00 CORREIO 1005 25X1
Código: 42700 Fábrica: SANTECK Unidade: PT/25
F1 F4

UN: R\$ 2,67 AV: R\$ 66,76 15: R\$ 68,15
30: R\$ 69,51 45: R\$ 70,90 60: R\$ 72,32



CAIXA PAPELAO CV N01 CORREIO 1000 25X1
Código: 39979 Fábrica: SANTECK Unidade: PT/25
F1 F4

UN: R\$ 4,71 AV: R\$ 112,98 15: R\$ 115,34
30: R\$ 117,64 45: R\$ 120,00 60: R\$ 122,40



CAIXA PAPELAO CV N02 CORREIO 1002 25X1
Código: 39980 Fábrica: SANTECK Unidade: PT/24
F1 F4

UN: R\$ 8,96 AV: R\$ 223,92 15: R\$ 228,58
30: R\$ 233,16 45: R\$ 237,82 60: R\$ 242,58



CAIXA PAPELAO CV N04 CORREIO 1004 25X1
Código: 42702 Fábrica: SANTECK Unidade: PT/25
F1 F4

UN: R\$ 5,42 AV: R\$ 5,42 15: R\$ 5,54
30: R\$ 5,65 45: R\$ 5,76 60: R\$ 5,88

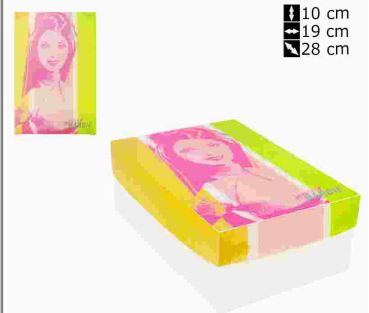

CAIXA PVC PORTA TRECOS BARBIE 2558
Código: 15404 Fábrica: POLIBRAS. Unidade: UN/1
F1 F4

10 cm
19 cm
28 cm

UN: R\$ 15,10 AV: R\$ 15,10 15: R\$ 15,41
30: R\$ 15,72 45: R\$ 16,04 60: R\$ 16,36



CALCULADORA 8 DIG A PILHA MJ-658A

Código: Fábrika: Unidade:
13084 MJ UN/1
F1 F4

UN: R\$ 21,56 AV: R\$ 21,56 15: R\$ 22,01
30: R\$ 22,45 45: R\$ 22,90 60: R\$ 23,36



CALCULADORA 8 DIG MED KK-800A BAT

Código: Fábrika: Unidade:
41647 GATE UN/1
F1 F4

UN: R\$ 21,56 AV: R\$ 21,56 15: R\$ 22,01
30: R\$ 22,45 45: R\$ 22,90 60: R\$ 23,36



CALCULADORA 8 DIG MED KK-800V BAT

Código: Fábrika: Unidade:
41648 GATE UN/1
F1 F4

UN: R\$ 8,21 AV: R\$ 8,21 15: R\$ 8,38
30: R\$ 8,55 45: R\$ 8,72 60: R\$ 8,89



CALCULADORA 8 DIG PQ PILHA AA S/API 402

Código: Fábrika: Unidade:
23639 RELINX UN/1
F1 F4

UN: R\$ 26,70 AV: R\$ 26,70 15: R\$ 27,25
30: R\$ 27,80 45: R\$ 28,35 60: R\$ 28,92



CALCULADORA CIENTIF 10+2 DIG BATER 9318C

Código: Fábrika: Unidade:
35296 IDEA UN/1
F1 F4

UN: R\$ 20,53 AV: R\$ 20,53 15: R\$ 20,96
30: R\$ 21,38 45: R\$ 21,81 60: R\$ 22,24



CALCULADORA CIENTIF 12DIG 240 FUNC 82

Código: Fábrika: Unidade:
49908 MJ UN/1
F1 F4

UN: R\$ 28,75 AV: R\$ 28,75 15: R\$ 29,35
30: R\$ 29,94 45: R\$ 30,54 60: R\$ 31,15



CALCULADORA 12 DIG COLOR PILHA 9136D-12

Código: Fábrika: Unidade:
43292 XHADAY UN/1
F1 F4

UN: R\$ 22,99 AV: R\$ 22,99 15: R\$ 22,99
30: R\$ 22,99 45: R\$ 22,99 60: R\$ 22,99



CALCULADORA 12 DIG PILHA AA 0036

Código: Fábrika: Unidade:
46867 PLANETA UN/1
F1 F4

UN: R\$ 20,53 AV: R\$ 20,53 15: R\$ 20,96
30: R\$ 21,38 45: R\$ 21,81 60: R\$ 22,24



CALCULADORA 12 DIG PILHA 837B

Código: Fábrika: Unidade:
42231 MJ UN/1
F1 F4

UN: R\$ 29,78 AV: R\$ 29,78 15: R\$ 30,40
30: R\$ 31,01 45: R\$ 31,63 60: R\$ 32,26



CALCULADORA 12 DIG PILHA 838B-12

Código: Fábrika: Unidade:
43204 XHADAY UN/1
F1 F4

UN: R\$ 14,10 AV: R\$ 14,10 15: R\$ 14,40
30: R\$ 14,69 45: R\$ 14,98 60: R\$ 15,28



CALCULADORA 8 DIG BAT C/APITO 9844

Código: Fábrika: Unidade:
22056 DOTAD UN/1
F1 F4

UN: R\$ 24,64 AV: R\$ 24,64 15: R\$ 25,16
30: R\$ 25,66 45: R\$ 26,17 60: R\$ 26,70



CALCULADORA 8+2 DIG CIENTIF PILH AA 7722

Código: Fábrika: Unidade:
47929 YIN'S PAPER UN/1
F1 F4

UN: R\$ 0,46 AV: R\$ 23,16 15: R\$ 23,64
30: R\$ 24,11 45: R\$ 24,59 60: R\$ 25,09

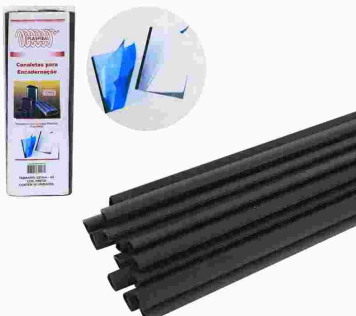

CANAETA P/ENCADERNACAO A4 PRETA 50X1

Código: Fábrika: Unidade:
41677 PLASPIRAL PT/50
F1 F4

UN: R\$ 4,01 AV: R\$ 4,01 15: R\$ 4,09
30: R\$ 4,17 45: R\$ 4,25 60: R\$ 4,34



CANETA CORRETIVA UN

Código: Fábrika: Unidade:
42508 MASTERPRINT UN/1
F1 F4

UN: R\$ 3,85 AV: R\$ 46,21 15: R\$ 47,18
30: R\$ 48,12 45: R\$ 49,08 60: R\$ 50,06



CANETA CORRETIVA 4ML 131 12X1

Código: Fábrika: Unidade:
46415 KAZ CX/12
F1 F4

UN: R\$ 3,00 AV: R\$ 35,94 15: R\$ 36,69
30: R\$ 37,42 45: R\$ 38,17 60: R\$ 38,94



CANETA CORRETIVA 7 ML 904539 12X1

Código: Fábrika: Unidade:
49494 BAZZE DZ/12
F1 F4

UN: R\$ 3,29 AV: R\$ 79,07 15: R\$ 80,72
30: R\$ 82,34 45: R\$ 83,98 60: R\$ 85,66



CANETA CORRETIVA 7ML 435 24X1
Código: Fábrica: Unidade:
13096 MASTERPRINT CX/24
F1 F4

UN: R\$ 4,49 AV: R\$ 107,85 15: R\$ 110,09
30: R\$ 112,29 45: R\$ 114,54 60: R\$ 116,83



CANETA CORRETIVA 8ML 242203 24X1
Código: Fábrica: Unidade:
44107 FUTURO CX/24
F1 F4

UN: R\$ 5,79 AV: R\$ 5,79 15: R\$ 5,91
30: R\$ 6,03 45: R\$ 6,15 60: R\$ 6,28



CANETA DETECTORA DE DH FALSO CTL 96059
Código: Fábrica: Unidade:
40934 JOCAROFFICE CR/1
F1 F4

UN: R\$ 2,09 AV: R\$ 25,08 15: R\$ 25,60
30: R\$ 26,11 45: R\$ 26,63 60: R\$ 27,17



CANETA ESF CLIC 0.55MM BROW 12X1
Código: Fábrica: Unidade:
48561 NEWPEN CZ/12
F1 F4

UN: R\$ 2,09 AV: R\$ 25,08 15: R\$ 25,60
30: R\$ 26,11 45: R\$ 26,63 60: R\$ 27,17



CANETA ESF CLIC 0.55MM GREEN 12X1
Código: Fábrica: Unidade:
48560 NEWPEN DZ/12
F1 F4

UN: R\$ 2,09 AV: R\$ 25,08 15: R\$ 25,60
30: R\$ 26,11 45: R\$ 26,63 60: R\$ 27,17



CANETA ESF CLIC 0.55MM LIGHT GREEN 12X1
Código: Fábrica: Unidade:
48563 NEWPEN DZ/12
F1 F4

UN: R\$ 2,09 AV: R\$ 25,08 15: R\$ 25,60
30: R\$ 26,11 45: R\$ 26,63 60: R\$ 27,17



CANETA ESF CLIC 0.55MM LIGHT PINK 12X1
Código: Fábrica: Unidade:
48562 NEWPEN DZ/12
F1 F4

UN: R\$ 2,09 AV: R\$ 25,08 15: R\$ 25,60
30: R\$ 26,11 45: R\$ 26,63 60: R\$ 27,17



CANETA ESF CLIC 0.55MM SILVER 12X1
Código: Fábrica: Unidade:
48559 NEWPEN DZ/12
F1 F4

UN: R\$ 2,09 AV: R\$ 25,08 15: R\$ 25,60
30: R\$ 26,11 45: R\$ 26,63 60: R\$ 27,17



CANETA ESF CLIC 0.55MM YELLOW 12X1
Código: Fábrica: Unidade:
48564 NEWPEN DZ/12
F1 F4

UN: R\$ 3,12 AV: R\$ 149,77 15: R\$ 152,89
30: R\$ 155,95 45: R\$ 159,07 60: R\$ 162,25



CANETA ESF CLIC 1.0MM AZUL 1135 48X1
Código: Fábrica: Unidade:
48556 NEWPEN CX/48
F1 F4

UN: R\$ 3,12 AV: R\$ 149,77 15: R\$ 152,89
30: R\$ 155,95 45: R\$ 159,07 60: R\$ 162,25



CANETA ESF CLIC 1.0MM PRETA 1134 48X1
Código: Fábrica: Unidade:
48557 NEWPEN CX/48
F1 F4

UN: R\$ 1,43 AV: R\$ 71,44 15: R\$ 72,93
30: R\$ 74,39 45: R\$ 75,88 60: R\$ 77,39



CANETA ESF CRISTAL 0.8MM AZUL FINA 50X1
Código: Fábrica: Unidade:
31710 BIC CX/50
F1 F4

UN: R\$ 1,43 AV: R\$ 71,44 15: R\$ 72,93
30: R\$ 74,39 45: R\$ 75,88 60: R\$ 77,39



CANETA ESF CRISTAL 0.8MM PRETA FINA 50X1
Código: Fábrica: Unidade:
29642 BIC CX/50
F1 F4

UN: R\$ 1,13 AV: R\$ 56,50 15: R\$ 57,67
30: R\$ 58,83 45: R\$ 60,00 60: R\$ 61,20



CANETA ESF CRISTAL 0.8MM VERM FINA 50X1
Código: Fábrica: Unidade:
34032 BIC CX/50
F1 F4

UN: R\$ 1,23 AV: R\$ 61,53 15: R\$ 62,81
30: R\$ 64,07 45: R\$ 65,35 60: R\$ 66,65



CANETA ESF CRISTAL 1.0MM AZUL MED 50X1
Código: Fábrica: Unidade:
12538 BIC CX/50
F1 F4

UN: R\$ 1,23 AV: R\$ 61,53 15: R\$ 62,81
30: R\$ 64,07 45: R\$ 65,35 60: R\$ 66,65



CANETA ESF CRISTAL 1.0MM VERM MED 50X1
Código: Fábrica: Unidade:
29783 BIC CX/50
F1 F4

UN: R\$ 2,55 AV: R\$ 63,64 15: R\$ 64,96
30: R\$ 66,26 45: R\$ 67,59 60: R\$ 68,94



CANETA ESF CRISTAL 1.6MM AZUL BOLD 25X1
Código: Fábrica: Unidade:
50120 BIC CX/25
F1 F4

UN: R\$ 2,55 AV: R\$ 63,64 15: R\$ 64,96
30: R\$ 66,26 45: R\$ 67,59 60: R\$ 68,94



CANETA ESF CRISTAL 1.6MM PRETA BOLD 25X1
Código: Fábrica: Unidade:
50121 BIC CX/25
F1 F4

UN: R\$ 28,75 AV: R\$ 28,75 15: R\$ 29,35
30: R\$ 29,94 45: R\$ 30,54 60: R\$ 31,15



CANETA ESF FIXO AZUL C/CORRENTE+RECARG
Código: Fábrica: Unidade:
48573 NEWPEN UN/1
F1 F4

UN: R\$ 3,25 AV: R\$ 39,02 15: R\$ 39,84
30: R\$ 40,63 45: R\$ 41,45 60: R\$ 42,27



CANETA ESF GELOCIY 0.5MM AZUL FINA 12X1
Código: Fábrica: Unidade:
50122 BIC CX/12
F1 F4

UN: R\$ 3,25 AV: R\$ 39,02 15: R\$ 39,84
30: R\$ 40,63 45: R\$ 41,45 60: R\$ 42,27



CANETA ESF GELOCIY 0.5MM PT/VM FINA 12X1
Código: Fábrica: Unidade:
50123 BIC CX/12
F1 F4

UN: R\$ 1,45 AV: R\$ 17,45 15: R\$ 17,82
30: R\$ 18,17 45: R\$ 18,54 60: R\$ 18,91



CANETA ESF INOX 1.0MM AZUL 12X1
Código: Fábrica: Unidade:
43815 PILOT CX/12
F1 F4

UN: R\$ 1,45 AV: R\$ 17,45 15: R\$ 17,82
30: R\$ 18,17 45: R\$ 18,54 60: R\$ 18,91



CANETA ESF INOX 1.0MM PRETA 12X1
Código: Fábrica: Unidade:
43816 PILOT CX/12
F1 F4

UN: R\$ 1,45 AV: R\$ 17,45 15: R\$ 17,82
30: R\$ 18,17 45: R\$ 18,54 60: R\$ 18,91



CANETA ESF INOX 1.0MM VERMELHO 12X1
Código: Fábrica: Unidade:
43817 PILOT CX/12
F1 F4

UN: R\$ 1,50 AV: R\$ 149,77 15: R\$ 152,89
30: R\$ 155,95 45: R\$ 159,07 60: R\$ 162,25



CANETA ESF 0.7 AZUL 100X1
Código: Fábrica: Unidade:
35991 COMPACTOR CX/100
F1 F4

UN: R\$ 1,51 AV: R\$ 75,46 15: R\$ 77,03
30: R\$ 78,57 45: R\$ 80,15 60: R\$ 81,75



CANETA ESF 0.7 AZUL 50X1
Código: Fábrica: Unidade:
4082 COMPACTOR CX/50
F1 F4

UN: R\$ 3,25 AV: R\$ 81,27 15: R\$ 82,96
30: R\$ 84,62 45: R\$ 86,31 60: R\$ 88,04



CANETA ESF 0.7 MM MY TECH AZUL 7330 25X1
Código: Fábrica: Unidade:
46362 JOCAROFFICE PT/25
F1 F4

UN: R\$ 3,25 AV: R\$ 81,27 15: R\$ 82,96
30: R\$ 84,62 45: R\$ 86,31 60: R\$ 88,04



CANETA ESF 0.7 MM MY TECH PRETO 25X1
Código: Fábrica: Unidade:
46363 JOCAROFFICE CX/25
F1 F4

UN: R\$ 3,25 AV: R\$ 81,27 15: R\$ 82,96
30: R\$ 84,62 45: R\$ 86,31 60: R\$ 88,04



CANETA ESF 0.7 MM MY TECH VERMELHO 25X1
Código: Fábrica: Unidade:
46364 JOCAROFFICE CX/25
F1 F4

UN: R\$ 2,23 AV: R\$ 111,46 15: R\$ 113,78
30: R\$ 116,05 45: R\$ 118,37 60: R\$ 120,74



CANETA ESF 0.7 MM PICNIC COLORIDA 50X1
Código: Fábrica: Unidade:
46376 LEO&LEO PT/50
F1 F4

UN: R\$ 1,26 AV: R\$ 15,08 15: R\$ 15,40
30: R\$ 15,70 45: R\$ 16,02 60: R\$ 16,34



CANETA ESF 0.7 MM SILK AZUL 12X1
Código: Fábrica: Unidade:
42730 JOCAROFFICE CX/12
F1 F4

UN: R\$ 1,26 AV: R\$ 15,08 15: R\$ 15,40
30: R\$ 15,70 45: R\$ 16,02 60: R\$ 16,34



CANETA ESF 0.7 MM SILK PRETO 12X1
Código: Fábrica: Unidade:
42731 JOCAROFFICE CX/12
F1 F4

UN: R\$ 3,68 AV: R\$ 29,43 15: R\$ 30,05
30: R\$ 30,65 45: R\$ 31,26 60: R\$ 31,89



CANETA ESF 0.7 MM TIP CLICK 97945 8X1

Código: 46361 Fábrica: JOCAROFFICE Unidade: CT/8 F1 F4

UN: R\$ 1,51 AV: R\$ 75,46 15: R\$ 77,03
30: R\$ 78,57 45: R\$ 80,15 60: R\$ 81,75



CANETA ESF 0.7 PRETA 50X1

Código: 3198 Fábrica: COMPACTOR Unidade: CX/50 F1 F4

UN: R\$ 1,86 AV: R\$ 46,43 15: R\$ 47,40
30: R\$ 48,35 45: R\$ 49,32 60: R\$ 50,30



CANETA ESF 0.7 ROSA PINK 25X1

Código: 35994 Fábrica: COMPACTOR Unidade: CX/25 F1 F4

UN: R\$ 1,51 AV: R\$ 75,46 15: R\$ 77,03
30: R\$ 78,57 45: R\$ 80,15 60: R\$ 81,75



CANETA ESF 0.7 VERMELHA 50X1

Código: 3199 Fábrica: COMPACTOR Unidade: CX/50 F1 F4

UN: R\$ 1,86 AV: R\$ 46,43 15: R\$ 47,40
30: R\$ 48,35 45: R\$ 49,32 60: R\$ 50,30



CANETA ESF 0.7 VIOLETA 25X1

Código: 35995 Fábrica: COMPACTOR Unidade: CX/25 F1 F4

UN: R\$ 1,79 AV: R\$ 42,95 15: R\$ 43,84
30: R\$ 44,72 45: R\$ 45,62 60: R\$ 46,53



CANETA ESF 0.7MM AZUL POTE 57718 24X1

Código: 48172 Fábrica: CIS Unidade: PT/24 F1 F4

UN: R\$ 2,44 AV: R\$ 12,18 15: R\$ 12,43
30: R\$ 12,68 45: R\$ 12,94 60: R\$ 13,19



CANETA ESF 0.7MM ESPIRAL 98159 5X1

Código: 46391 Fábrica: KAZ Unidade: CT/5 F1 F4

UN: R\$ 15,40 AV: R\$ 61,60 15: R\$ 62,88
30: R\$ 64,14 45: R\$ 65,43 60: R\$ 66,73



CANETA ESF 0.7MM GEL AZUL/PT/VM 4X1

Código: 48221 Fábrica: SHARPIE Unidade: CR/4 F1 F4

UN: R\$ 7,19 AV: R\$ 14,37 15: R\$ 14,67
30: R\$ 14,96 45: R\$ 15,26 60: R\$ 15,57



CANETA ESF 0.7MM INKJOY GEL RETRATIL 2X1

Código: 48206 Fábrica: PAPER MATE Unidade: CR/2 F1 F4

UN: R\$ 6,93 AV: R\$ 27,72 15: R\$ 28,30
30: R\$ 28,87 45: R\$ 29,45 60: R\$ 30,03



CANETA ESF 0.7MM INKJOY GEL RETRATIL 4X1

Código: 48207 Fábrica: PAPER MATE Unidade: CR/4 F1 F4

UN: R\$ 65,80 AV: R\$ 65,80 15: R\$ 67,17
30: R\$ 68,51 45: R\$ 69,88 60: R\$ 71,28



CANETA ESF 0.7MM KIT 5 CORES

Código: 46249 Fábrica: PILOT Unidade: KT/1 F1 F4

UN: R\$ 1,79 AV: R\$ 42,95 15: R\$ 43,84
30: R\$ 44,72 45: R\$ 45,62 60: R\$ 46,53



CANETA ESF 0.7MM PRETA POTE 57719 24X1

Código: 48173 Fábrica: CIS Unidade: PT/24 F1 F4

UN: R\$ 1,79 AV: R\$ 42,95 15: R\$ 43,84
30: R\$ 44,72 45: R\$ 45,62 60: R\$ 46,53



CANETA ESF 0.7MM SORT POTE 57717 24X1

Código: 48174 Fábrica: CIS Unidade: PT/24 F1 F4

UN: R\$ 13,16 AV: R\$ 157,90 15: R\$ 161,19
30: R\$ 164,41 45: R\$ 167,70 60: R\$ 171,06

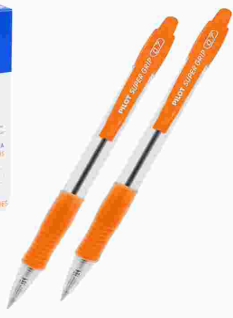

CANETA ESF 0.7MM SUPER GRIP LARANJA 12X1

Código: 46150 Fábrica: PILOT Unidade: CX/12 F1 F4

UN: R\$ 13,16 AV: R\$ 157,90 15: R\$ 161,19
30: R\$ 164,41 45: R\$ 167,70 60: R\$ 171,06



CANETA ESF 0.7MM SUPER GRIP VERDE 12X1

Código: 46152 Fábrica: PILOT Unidade: CX/12 F1 F4

UN: R\$ 13,16 AV: R\$ 157,90 15: R\$ 161,19
30: R\$ 164,41 45: R\$ 167,70 60: R\$ 171,06



CANETA ESF 0.7MM SUPER GRIP VERMELH 12X1

Código: 46154 Fábrica: PILOT Unidade: CX/12 F1 F4

UN: R\$ 13,16 AV: R\$ 157,90 15: R\$ 161,19
30: R\$ 164,41 45: R\$ 167,70 60: R\$ 171,06



CANETA ESF 0.7MM SUPER GRIP VIOLETA 12X1
Código: Fábrika: Unidade:
46153 PILOT CX/12
F1 F4

UN: R\$ 2,26 AV: R\$ 6,77 15: R\$ 6,91
30: R\$ 7,05 45: R\$ 7,19 60: R\$ 7,33



CANETA ESF 0.7MM WAVE 3 CORES 3X1
Código: Fábrika: Unidade:
49498 BAZZE PT/3
F1 F4

UN: R\$ 1,81 AV: R\$ 43,55 15: R\$ 44,46
30: R\$ 45,35 45: R\$ 46,26 60: R\$ 47,18



CANETA ESF 0.7MM WAVE 3CORES POTE 24X1
Código: Fábrika: Unidade:
49496 BAZZE PT/24
F1 F4

UN: R\$ 1,18 AV: R\$ 59,10 15: R\$ 60,33
30: R\$ 61,54 45: R\$ 62,77 60: R\$ 64,02



CANETA ESF 0.8MM PONTA FINA AZUL 50X1
Código: Fábrika: Unidade:
20614 INJEX PEN CX/50
F1 F4

UN: R\$ 1,18 AV: R\$ 59,10 15: R\$ 60,33
30: R\$ 61,54 45: R\$ 62,77 60: R\$ 64,02



CANETA ESF 0.8MM PONTA FINA PRETA 50X1
Código: Fábrika: Unidade:
20617 INJEX PEN CX/50
F1 F4

UN: R\$ 1,18 AV: R\$ 59,10 15: R\$ 60,33
30: R\$ 61,54 45: R\$ 62,77 60: R\$ 64,02



CANETA ESF 0.8MM PONTA FINA VERMELH 50X1
Código: Fábrika: Unidade:
20615 INJEX PEN CX/50
F1 F4

UN: R\$ 1,28 AV: R\$ 63,85 15: R\$ 65,18
30: R\$ 66,48 45: R\$ 67,81 60: R\$ 69,17



CANETA ESF 1.0 ECONOMIC FINA AZUL 50X1
Código: Fábrika: Unidade:
47847 COMPACTOR CX/50
F1 F4

UN: R\$ 1,28 AV: R\$ 63,85 15: R\$ 65,18
30: R\$ 66,48 45: R\$ 67,81 60: R\$ 69,17



CANETA ESF 1.0 ECONOMIC FINA PRETA 50X1
Código: Fábrika: Unidade:
47848 COMPACTOR CX/50
F1 F4

UN: R\$ 1,28 AV: R\$ 63,85 15: R\$ 65,18
30: R\$ 66,48 45: R\$ 67,81 60: R\$ 69,17



CANETA ESF 1.0 ECONOMIC FINA VERMEL 50X1
Código: Fábrika: Unidade:
47849 COMPACTOR CX/50
F1 F4

UN: R\$ 1,04 AV: R\$ 104,49 15: R\$ 106,67
30: R\$ 108,80 45: R\$ 110,97 60: R\$ 113,19



CANETA ESF 1.0 ECONOMIC MED AZUL 100X1
Código: Fábrika: Unidade:
35992 COMPACTOR CX/100
F1 F4

UN: R\$ 1,16 AV: R\$ 58,04 15: R\$ 59,25
30: R\$ 60,44 45: R\$ 61,65 60: R\$ 62,88



CANETA ESF 1.0 ECONOMIC MED AZUL 50X1
Código: Fábrika: Unidade:
27813 COMPACTOR CX/50
F1 F4

UN: R\$ 1,04 AV: R\$ 104,49 15: R\$ 106,67
30: R\$ 108,80 45: R\$ 110,97 60: R\$ 113,19



CANETA ESF 1.0 ECONOMIC MED VERMEL 100X1
Código: Fábrika: Unidade:
50416 COMPACTOR CX/100
F1 F4

UN: R\$ 1,16 AV: R\$ 58,04 15: R\$ 59,25
30: R\$ 60,44 45: R\$ 61,65 60: R\$ 62,88



CANETA ESF 1.0 ECONOMIC MED VERMEL 50X1
Código: Fábrika: Unidade:
31347 COMPACTOR CX/50
F1 F4

UN: R\$ 1,89 AV: R\$ 45,27 15: R\$ 46,21
30: R\$ 47,14 45: R\$ 48,08 60: R\$ 49,04



CANETA ESF 1.0MM COLOR MINI 04577 24X1
Código: Fábrika: Unidade:
49955 BAZZE WAVE CX/24
F1 F4

UN: R\$ 2,27 AV: R\$ 54,56 15: R\$ 55,70
30: R\$ 56,81 45: R\$ 57,95 60: R\$ 59,11



CANETA ESF 1.0MM COLOR 653358 24X1
Código: Fábrika: Unidade:
49954 BAZZE WAVE CX/24
F1 F4

UN: R\$ 2,57 AV: R\$ 15,41 15: R\$ 15,73
30: R\$ 16,04 45: R\$ 16,36 60: R\$ 16,69



CANETA ESF 1.0MM COR PASTEIS 98154 6X1
Código: Fábrika: Unidade:
46388 KAZ CT/6
F1 F4

UN: R\$ 2,46 AV: R\$ 12,30 15: R\$ 12,55
30: R\$ 12,80 45: R\$ 13,06 60: R\$ 13,32



CANETA ESF 1.0MM CORES 98118 5X1

Código: 46389 Fábrica: KAZ Unidade: CT/5 F1 F4

UN: R\$ 2,61 AV: R\$ 62,69 15: R\$ 63,99
30: R\$ 65,28 45: R\$ 66,58 60: R\$ 67,91



CANETA ESF 1.0MM DUO AZ/VM POTE 24X1

Código: 48558 Fábrica: NEWPEN Unidade: CX/24 F1 F4

UN: R\$ 1,00 AV: R\$ 49,92 15: R\$ 50,96
30: R\$ 51,98 45: R\$ 53,01 60: R\$ 54,08



CANETA ESF 1.0MM HEXAG AZUL 402 50X1

Código: 49945 Fábrica: BAZZE SIX Unidade: CX/50 F1 F4

UN: R\$ 1,00 AV: R\$ 49,92 15: R\$ 50,96
30: R\$ 51,98 45: R\$ 53,01 60: R\$ 54,08



CANETA ESF 1.0MM HEXAG PRETA 3396 50X1

Código: 49946 Fábrica: BAZZE SIX Unidade: CX/50 F1 F4

UN: R\$ 1,00 AV: R\$ 49,92 15: R\$ 50,96
30: R\$ 51,98 45: R\$ 53,01 60: R\$ 54,08



CANETA ESF 1.0MM HEXAG VERMEL 419 50X1

Código: 49944 Fábrica: BAZZE SIX Unidade: CX/50 F1 F4

UN: R\$ 2,87 AV: R\$ 28,70 15: R\$ 29,30
30: R\$ 29,89 45: R\$ 30,48 60: R\$ 31,09



CANETA ESF 1.0MM HYPER COLOR 97921 10X1

Código: 46357 Fábrica: JOCAROFFICE Unidade: CT/10 F1 F4

UN: R\$ 2,03 AV: R\$ 16,24 15: R\$ 16,58
30: R\$ 16,91 45: R\$ 17,25 60: R\$ 17,60



CANETA ESF 1.0MM JET LUX 8X1

Código: 48154 Fábrica: COMPACTOR Unidade: CR/8 F1 F4

UN: R\$ 3,25 AV: R\$ 39,02 15: R\$ 39,84
30: R\$ 40,63 45: R\$ 41,45 60: R\$ 42,27



CANETA ESF 1.0MM OURO 12X1

Código: 8456 Fábrica: CIS Unidade: DZ/12 F1 F4

UN: R\$ 2,71 AV: R\$ 65,01 15: R\$ 66,37
30: R\$ 67,69 45: R\$ 69,05 60: R\$ 70,43



CANETA ESF 1.0MM OURO/PRATA 1415 24X1

Código: 49952 Fábrica: BAZZE WAVE Unidade: CX/24 F1 F4

UN: R\$ 2,22 AV: R\$ 8,87 15: R\$ 9,06
30: R\$ 9,24 45: R\$ 9,42 60: R\$ 9,61



CANETA ESF 1.0MM PEROLA 4 CORES 4X1

Código: 20678 Fábrica: INJEX PEN Unidade: PT/4 F1 F4

UN: R\$ 0,93 AV: R\$ 46,43 15: R\$ 47,40
30: R\$ 48,35 45: R\$ 49,32 60: R\$ 50,30



CANETA ESF 1.0MM PONTA MED AZUL 50X1

Código: 20621 Fábrica: INJEX PEN Unidade: CX/50 F1 F4

UN: R\$ 1,85 AV: R\$ 5,55 15: R\$ 5,67
30: R\$ 5,78 45: R\$ 5,89 60: R\$ 6,01



CANETA ESF 1.0MM PONTA MED AZ/VM/PT 3X1

Código: 47259 Fábrica: INJEX PEN Unidade: PT/3 F1 F4

UN: R\$ 0,93 AV: R\$ 46,43 15: R\$ 47,40
30: R\$ 48,35 45: R\$ 49,32 60: R\$ 50,30



CANETA ESF 1.0MM PONTA MED PRETA 50X1

Código: 20618 Fábrica: INJEX PEN Unidade: CX/50 F1 F4

UN: R\$ 0,93 AV: R\$ 46,43 15: R\$ 47,40
30: R\$ 48,35 45: R\$ 49,32 60: R\$ 50,30



CANETA ESF 1.0MM PONTA MED VERMELHA 50X1

Código: 20620 Fábrica: INJEX PEN Unidade: CX/50 F1 F4

UN: R\$ 3,24 AV: R\$ 38,93 15: R\$ 39,74
30: R\$ 40,54 45: R\$ 41,35 60: R\$ 42,17



CANETA ESF 1.0MM PRATA 12X1

Código: 48348 Fábrica: CIS Unidade: DZ/12 F1 F4

UN: R\$ 1,80 AV: R\$ 17,99 15: R\$ 18,36
30: R\$ 18,73 45: R\$ 19,10 60: R\$ 19,48



CANETA ESF 1.0MM TENDENCE 98146 10X1

Código: 46390 Fábrica: KAZ Unidade: CT/10 F1 F4

UN: R\$ 11,55 AV: R\$ 138,61 15: R\$ 141,50
30: R\$ 144,33 45: R\$ 147,21 60: R\$ 150,16



CANETA ESF 1.0MM 4 CORES MED 12X1
Código: Fábrica: Unidade:
50124 BIC CX/12
F1 F4

UN: R\$ 2,70 AV: R\$ 10,78 15: R\$ 11,00
30: R\$ 11,22 45: R\$ 11,44 60: R\$ 11,67



CANETA ESF 1.2MM 4 CORES MED FASHION
Código: Fábrica: Unidade:
6895 BIC CR/4
F1 F4

UN: R\$ 20,53 AV: R\$ 20,53 15: R\$ 20,96
30: R\$ 21,38 45: R\$ 21,81 60: R\$ 22,24



CANETA EXECUTIVA ATENA ESCRITA PRETA CX
Código: Fábrica: Unidade:
47910 YIN'S PAPER UN/1
F1 F4

UN: R\$ 61,62 AV: R\$ 61,62 15: R\$ 62,91
30: R\$ 64,16 45: R\$ 65,45 60: R\$ 66,76



CANETA FIXA METAL C/CORRENTE CTL 234
Código: Fábrica: Unidade:
46781 CARBRINK CR/1
F1 F4

UN: R\$ 2,91 AV: R\$ 17,45 15: R\$ 17,82
30: R\$ 18,17 45: R\$ 18,54 60: R\$ 18,91



CANETA FLAIR BOLD 1.2MM PONTA POROSA 6X1
Código: Fábrica: Unidade:
48209 PAPER MATE CR/6
F1 F4

UN: R\$ 7,35 AV: R\$ 44,11 15: R\$ 45,03
30: R\$ 45,93 45: R\$ 46,85 60: R\$ 47,79



CANETA GEL GLITTER 1.0MM COLOR 980 6X1
Código: Fábrica: Unidade:
41900 LYKE CR/6
F1 F4

UN: R\$ 4,84 AV: R\$ 58,04 15: R\$ 59,25
30: R\$ 60,44 45: R\$ 61,65 60: R\$ 62,88



CANETA GEL GLITTER 1,0MM PRATA 1120 12X1
Código: Fábrica: Unidade:
42593 JOCAROFFICE CR/12
F1 F4

UN: R\$ 4,84 AV: R\$ 58,04 15: R\$ 59,25
30: R\$ 60,44 45: R\$ 61,65 60: R\$ 62,88



CANETA GEL GLITTER 1.0MM PRATA 12X1
Código: Fábrica: Unidade:
41932 TRIS CR/12
F1 F4

UN: R\$ 3,28 AV: R\$ 131,19 15: R\$ 133,93
30: R\$ 136,61 45: R\$ 139,34 60: R\$ 142,12



CANETA GEL GLITTER 1.0MM SORT 97933 40X1
Código: Fábrica: Unidade:
46159 JOCAROFFICE PT/40
F1 F4

UN: R\$ 6,97 AV: R\$ 6,97 15: R\$ 7,11
30: R\$ 7,25 45: R\$ 7,40 60: R\$ 7,55



CANETA GEL METAL 0.7MM OURO/PRATA UN
Código: Fábrica: Unidade:
42830 JOCAROFFICE UN/1
F1 F4

UN: R\$ 6,77 AV: R\$ 40,63 15: R\$ 41,47
30: R\$ 42,30 45: R\$ 43,15 60: R\$ 44,01



CANETA GEL NEON 1.0MM COLOR 966 6X1
Código: Fábrica: Unidade:
41901 LYKE CR/6
F1 F4

UN: R\$ 5,65 AV: R\$ 67,76 15: R\$ 69,18
30: R\$ 70,56 45: R\$ 71,97 60: R\$ 73,41



CANETA GEL 0.5 MM APAGAVEL AZUL 251 12X1
Código: Fábrica: Unidade:
48169 MJ CX/12
F1 F4

UN: R\$ 5,65 AV: R\$ 67,76 15: R\$ 69,18
30: R\$ 70,56 45: R\$ 71,97 60: R\$ 73,41



CANETA GEL 0.5 MM APAGAVEL AZUL 606 12X1
Código: Fábrica: Unidade:
48167 MJ CX/12
F1 F4

UN: R\$ 5,65 AV: R\$ 67,76 15: R\$ 69,18
30: R\$ 70,56 45: R\$ 71,97 60: R\$ 73,41



CANETA GEL 0.5 MM APAGAVEL AZUL 998 12X1
Código: Fábrica: Unidade:
48168 MJ CX/12
F1 F4

UN: R\$ 3,98 AV: R\$ 31,80 15: R\$ 32,47
30: R\$ 33,11 45: R\$ 33,78 60: R\$ 34,45



CANETA GEL 0.55 MM POP UP 97924 8X1
Código: Fábrica: Unidade:
46360 JOCAROFFICE CT/8
F1 F4

UN: R\$ 3,22 AV: R\$ 161,24 15: R\$ 164,60
30: R\$ 167,90 45: R\$ 171,25 60: R\$ 174,68



CANETA GEL 0.7 MM HAPPY 5 CORES 50X1
Código: Fábrica: Unidade:
46366 JOCAROFFICE PT/50
F1 F4

UN: R\$ 3,38 AV: R\$ 168,91 15: R\$ 172,43
30: R\$ 175,87 45: R\$ 179,39 60: R\$ 182,98



CANETA GEL 0.7 MM RAINBOW 6 CORES 50X1

Código: Fábrika: Unidade:
46365 JOCAROFFICE PT/50
F1 F4

UN: R\$ 4,05 AV: R\$ 24,28 15: R\$ 24,78
30: R\$ 25,28 45: R\$ 25,79 60: R\$ 26,30



CANETA GEL 0.7 MM RAINBOW 97936 6X1

Código: Fábrika: Unidade:
46359 JOCAROFFICE CT/6
F1 F4

UN: R\$ 4,21 AV: R\$ 33,66 15: R\$ 34,36
30: R\$ 35,05 45: R\$ 35,75 60: R\$ 36,47



CANETA GEL 1.0 MM CORES 232214 8X1

Código: Fábrika: Unidade:
46384 FUTURO CT/8
F1 F4

UN: R\$ 5,11 AV: R\$ 51,08 15: R\$ 52,14
30: R\$ 53,18 45: R\$ 54,25 60: R\$ 55,33



CANETA GEL 1.0MM GLITTER 98121 10X1

Código: Fábrika: Unidade:
46393 KAZ CT/10
F1 F4

UN: R\$ 4,34 AV: R\$ 21,70 15: R\$ 22,15
30: R\$ 22,60 45: R\$ 23,05 60: R\$ 23,51



CANETA GEL 1.0MM GLITTER 98152 6X1

Código: Fábrika: Unidade:
46392 KAZ CT/5
F1 F4

UN: R\$ 2,81 AV: R\$ 16,84 15: R\$ 17,19
30: R\$ 17,53 45: R\$ 17,88 60: R\$ 18,24



CANETA HIDROG 0.4 MM 6 CORES 6183

Código: Fábrika: Unidade:
40676 GOLLER CR/6
F1 F4

UN: R\$ 2,90 AV: R\$ 34,82 15: R\$ 35,55
30: R\$ 36,26 45: R\$ 36,98 60: R\$ 37,72



CANETA HIDROG 0.4 FINELINER AZUL ES 12X1

Código: Fábrika: Unidade:
43607 BRW PT/12
F1 F4

UN: R\$ 2,90 AV: R\$ 34,82 15: R\$ 35,55
30: R\$ 36,26 45: R\$ 36,98 60: R\$ 37,72



CANETA HIDROG 0.4 FINELINER PINK NE 12X1

Código: Fábrika: Unidade:
44992 BRW PT/12
F1 F4

UN: R\$ 2,90 AV: R\$ 34,82 15: R\$ 35,55
30: R\$ 36,26 45: R\$ 36,98 60: R\$ 37,72



CANETA HIDROG 0.4 FINELINER PRETO 12X1

Código: Fábrika: Unidade:
44991 BRW PT/12
F1 F4

UN: R\$ 2,35 AV: R\$ 14,10 15: R\$ 14,39
30: R\$ 14,68 45: R\$ 14,97 60: R\$ 15,27



CANETA HIDROG 0.4 FINELINER SORT 6X1

Código: Fábrika: Unidade:
46827 BRW PT/6
F1 F4

UN: R\$ 25,53 AV: R\$ 25,53 15: R\$ 26,06
30: R\$ 26,59 45: R\$ 27,12 60: R\$ 27,66



CANETA HIDROGRAFICA BIG 12 CORES 4585

Código: Fábrika: Unidade:
42590 LEO&LEO CR/1
F1 F4

UN: R\$ 1,64 AV: R\$ 19,73 15: R\$ 20,14
30: R\$ 20,54 45: R\$ 20,95 60: R\$ 21,37



CANETA KILOMETRICA 0.7MM AZUL 12X1

Código: Fábrika: Unidade:
45522 PAPER MATE CX/12
F1 F4

UN: R\$ 1,62 AV: R\$ 81,24 15: R\$ 82,94
30: R\$ 84,59 45: R\$ 86,29 60: R\$ 88,01



CANETA KILOMETRICA 0.7MM AZUL 50X1

Código: Fábrika: Unidade:
29037 PAPER MATE CX/50
F1 F4

UN: R\$ 1,62 AV: R\$ 81,24 15: R\$ 82,94
30: R\$ 84,59 45: R\$ 86,29 60: R\$ 88,01



CANETA KILOMETRICA 0.7MM PRETA 50X1

Código: Fábrika: Unidade:
29038 PAPER MATE CX/50
F1 F4

UN: R\$ 1,64 AV: R\$ 19,73 15: R\$ 20,14
30: R\$ 20,54 45: R\$ 20,95 60: R\$ 21,37



CANETA KILOMETRICA 0.7MM PRETO 12X1

Código: Fábrika: Unidade:
45523 PAPER MATE CX/12
F1 F4

UN: R\$ 1,62 AV: R\$ 81,24 15: R\$ 82,94
30: R\$ 84,59 45: R\$ 86,29 60: R\$ 88,01



CANETA KILOMETRICA 0.7MM VERMELHO 50X1

Código: Fábrika: Unidade:
29908 PAPER MATE CX/50
F1 F4

UN: R\$ 1,11 AV: R\$ 55,72 15: R\$ 56,88
30: R\$ 58,02 45: R\$ 59,18 60: R\$ 60,36



CANETA KILOMETRICA 1.0MM AZUL 50X1
Código: 26807 Fábrica: PAPER MATE Unidade: CX/50 F1 F4

UN: R\$ 3,08 AV: R\$ 12,32 15: R\$ 12,57
30: R\$ 12,82 45: R\$ 13,08 60: R\$ 13,34



CANETA KILOMETRICA 1.0MM COLOR 4X1
Código: 29841 Fábrica: PAPER MATE Unidade: PT/4 F1 F4

UN: R\$ 3,19 AV: R\$ 25,53 15: R\$ 26,06
30: R\$ 26,59 45: R\$ 27,12 60: R\$ 27,66



CANETA KILOMETRICA 1.0MM COLOR 8X1
Código: 26805 Fábrica: PAPER MATE Unidade: PT/8 F1 F4

UN: R\$ 3,13 AV: R\$ 31,34 15: R\$ 31,99
30: R\$ 32,63 45: R\$ 33,28 60: R\$ 33,95



CANETA KILOMETRICA 1.0MM COLOR 10X1
Código: 45521 Fábrica: PAPER MATE Unidade: PT/10 F1 F4

UN: R\$ 2,90 AV: R\$ 69,66 15: R\$ 71,11
30: R\$ 72,53 45: R\$ 73,98 60: R\$ 75,46



CANETA KILOMETRICA 1.0MM COLOR 24X1
Código: 26787 Fábrica: PAPER MATE Unidade: PT/24 F1 F4

UN: R\$ 0,97 AV: R\$ 58,04 15: R\$ 59,25
30: R\$ 60,44 45: R\$ 61,65 60: R\$ 62,88



CANETA KILOMETRICA 1.0MM POP AZUL 60X1
Código: 45524 Fábrica: PAPER MATE Unidade: CX/60 F1 F4

UN: R\$ 0,97 AV: R\$ 58,04 15: R\$ 59,25
30: R\$ 60,44 45: R\$ 61,65 60: R\$ 62,88



CANETA KILOMETRICA 1.0MM POP PRETA 60X1
Código: 45525 Fábrica: PAPER MATE Unidade: CX/60 F1 F4

UN: R\$ 0,97 AV: R\$ 58,04 15: R\$ 59,25
30: R\$ 60,44 45: R\$ 61,65 60: R\$ 62,88



CANETA KILOMETRICA 1.0MM POP VERMEL 60X1
Código: 45526 Fábrica: PAPER MATE Unidade: CX/60 F1 F4

UN: R\$ 2,32 AV: R\$ 27,83 15: R\$ 28,41
30: R\$ 28,98 45: R\$ 29,56 60: R\$ 30,15



CANETA KILOMETRICA 1.0MM RETR AZUL 12X1
Código: 48208 Fábrica: PAPER MATE Unidade: CX/12 F1 F4

UN: R\$ 2,23 AV: R\$ 26,71 15: R\$ 27,26
30: R\$ 27,81 45: R\$ 28,36 60: R\$ 28,93



CANETA KILOMETRICA 1.0MM RETR AZUL 12X1
Código: 41619 Fábrica: PAPER MATE Unidade: CX/12 F1 F4

UN: R\$ 1,11 AV: R\$ 55,72 15: R\$ 56,88
30: R\$ 58,02 45: R\$ 59,18 60: R\$ 60,36



CANETA KILOMETRICA 1.0MM VERMELHA 50X1
Código: 26806 Fábrica: PAPER MATE Unidade: CX/50 F1 F4

UN: R\$ 6,62 AV: R\$ 33,08 15: R\$ 33,76
30: R\$ 34,44 45: R\$ 35,13 60: R\$ 35,83



CANETA MARC PERMANENTE COSMIC COLOR 5X1
Código: 48217 Fábrica: SHARPIE Unidade: CR/5 F1 F4

UN: R\$ 19,49 AV: R\$ 19,49 15: R\$ 19,89
30: R\$ 20,29 45: R\$ 20,70 60: R\$ 21,11



CANETA MARC PERMANENTE FINA PRATA CTL
Código: 48214 Fábrica: SHARPIE Unidade: CR/1 F1 F4

UN: R\$ 9,54 AV: R\$ 9,54 15: R\$ 9,74
30: R\$ 9,94 45: R\$ 10,14 60: R\$ 10,34



CANETA MARC PERMANENTE FINA PRETO CTL
Código: 48218 Fábrica: SHARPIE Unidade: CR/1 F1 F4

UN: R\$ 1,20 AV: R\$ 14,37 15: R\$ 14,67
30: R\$ 14,96 45: R\$ 15,26 60: R\$ 15,57



CANETA MARC PERMANENTE FINA VERM 12X1
Código: 48215 Fábrica: SHARPIE Unidade: CX/12 F1 F4

UN: R\$ 6,42 AV: R\$ 51,35 15: R\$ 52,42
30: R\$ 53,47 45: R\$ 54,54 60: R\$ 55,63



CANETA MARC PERMANENTE 8 CORES BRUSH TIP
Código: 48219 Fábrica: SHARPIE Unidade: CR/8 F1 F4

UN: R\$ 3,59 AV: R\$ 43,13 15: R\$ 44,03
30: R\$ 44,91 45: R\$ 45,81 60: R\$ 46,73



CANETA MARCA CD/DVD PONT DUPLA AZUL 12X1
Código: 49956 Fábrica: BAZZE Unidade: DZ/12 F1 F4

UN: R\$ 3,59 AV: R\$ 43,13 15: R\$ 44,03
30: R\$ 44,91 45: R\$ 45,81 60: R\$ 46,73



CANETA MARCA CD/DVD PONT DUPLA PTO 12X1
Código: 49957 Fábrica: BAZZE Unidade: DZ/12 F1 F4

UN: R\$ 2,90 AV: R\$ 34,82 15: R\$ 35,55
30: R\$ 36,26 45: R\$ 36,98 60: R\$ 37,72



CANETA MARCA CD/DVD/RETROP VERDE 12X1
Código: 43741 Fábrica: FIX PAPER Unidade: DZ/12 F1 F4

UN: R\$ 2,40 AV: R\$ 28,75 15: R\$ 29,35
30: R\$ 29,94 45: R\$ 30,54 60: R\$ 31,15



CANETA MARCA CD/RETROPROJ VERMELHA 12X1
Código: 24884 Fábrica: ONDA Unidade: DZ/12 F1 F4

UN: R\$ 11,02 AV: R\$ 11,02 15: R\$ 11,25
30: R\$ 11,47 45: R\$ 11,70 60: R\$ 11,94



CANETA MARCADOR TECIDO PERM 501 AZUL
Código: 41765 Fábrica: ACRILEX Unidade: UN/1 F1 F4

UN: R\$ 11,02 AV: R\$ 11,02 15: R\$ 11,25
30: R\$ 11,47 45: R\$ 11,70 60: R\$ 11,94



CANETA MARCADOR TECIDO PERM 503 AZUL
Código: 43538 Fábrica: ACRILEX Unidade: UN/1 F1 F4

UN: R\$ 11,02 AV: R\$ 11,02 15: R\$ 11,25
30: R\$ 11,47 45: R\$ 11,70 60: R\$ 11,94



CANETA MARCADOR TECIDO PERM 507 VERMELH
Código: 41768 Fábrica: ACRILEX Unidade: UN/1 F1 F4

UN: R\$ 11,02 AV: R\$ 11,02 15: R\$ 11,25
30: R\$ 11,47 45: R\$ 11,70 60: R\$ 11,94



CANETA MARCADOR TECIDO PERM 510 VERDE
Código: 44976 Fábrica: ACRILEX Unidade: UN/1 F1 F4

UN: R\$ 11,02 AV: R\$ 11,02 15: R\$ 11,25
30: R\$ 11,47 45: R\$ 11,70 60: R\$ 11,94



CANETA MARCADOR TECIDO PERM 513 VERDE
Código: 41764 Fábrica: ACRILEX Unidade: UN/1 F1 F4

UN: R\$ 11,02 AV: R\$ 11,02 15: R\$ 11,25
30: R\$ 11,47 45: R\$ 11,70 60: R\$ 11,94



CANETA MARCADOR TECIDO PERM 516 VIOLETA
Código: 44975 Fábrica: ACRILEX Unidade: UN/1 F1 F4

UN: R\$ 11,02 AV: R\$ 11,02 15: R\$ 11,25
30: R\$ 11,47 45: R\$ 11,70 60: R\$ 11,94



CANETA MARCADOR TECIDO PERM 517 LARANJA
Código: 44974 Fábrica: ACRILEX Unidade: UN/1 F1 F4

UN: R\$ 11,02 AV: R\$ 11,02 15: R\$ 11,25
30: R\$ 11,47 45: R\$ 11,70 60: R\$ 11,94



CANETA MARCADOR TECIDO PERM 520 PRETO
Código: 41767 Fábrica: ACRILEX Unidade: UN/1 F1 F4

UN: R\$ 11,02 AV: R\$ 11,02 15: R\$ 11,25
30: R\$ 11,47 45: R\$ 11,70 60: R\$ 11,94



CANETA MARCADOR TECIDO PERM 531 MARROM
Código: 43539 Fábrica: ACRILEX Unidade: UN/1 F1 F4

UN: R\$ 11,02 AV: R\$ 11,02 15: R\$ 11,25
30: R\$ 11,47 45: R\$ 11,70 60: R\$ 11,94



CANETA MARCADOR TECIDO PERM 537 ROSA
Código: 44973 Fábrica: ACRILEX Unidade: UN/1 F1 F4

UN: R\$ 11,02 AV: R\$ 11,02 15: R\$ 11,25
30: R\$ 11,47 45: R\$ 11,70 60: R\$ 11,94



CANETA MARCADOR TECIDO PERM 565 VINHO
Código: 43540 Fábrica: ACRILEX Unidade: UN/1 F1 F4

UN: R\$ 4,61 AV: R\$ 4,61 15: R\$ 4,71
30: R\$ 4,80 45: R\$ 4,90 60: R\$ 5,00



CANETA MARCADOR TECIDO PRETO 4917015
Código: 46846 Fábrica: ONDA Unidade: CR/1 F1 F4

UN: R\$ 1,97 AV: R\$ 23,62 15: R\$ 24,11
30: R\$ 24,59 45: R\$ 25,08 60: R\$ 25,58



CANETA 0.4MM MARCA CD/DVD/RETR 7530 12X1

Código: Fábrika: Unidade:
48148 YIN'S PAPER DZ/12
F1 F4

UN: R\$ 5,61 AV: R\$ 33,66 15: R\$ 34,36
30: R\$ 35,05 45: R\$ 35,75 60: R\$ 36,47



CANETA 0.4MM MICROLINE SORT 6X1

Código: Fábrika: Unidade:
48155 COMPACTOR CR/6
F1 F4

UN: R\$ 5,63 AV: R\$ 56,31 15: R\$ 57,49
30: R\$ 58,64 45: R\$ 59,81 60: R\$ 61,01



CANETA 0.4MM MICROLINE SORT 10X1

Código: Fábrika: Unidade:
48156 COMPACTOR CR/10
F1 F4

UN: R\$ 5,79 AV: R\$ 69,54 15: R\$ 70,99
30: R\$ 72,41 45: R\$ 73,86 60: R\$ 75,33



CANETA 0.4MM MICROLINE SORT 12X1

Código: Fábrika: Unidade:
35993 COMPACTOR CR/12
F1 F4

UN: R\$ 2,18 AV: R\$ 21,82 15: R\$ 22,28
30: R\$ 22,72 45: R\$ 23,18 60: R\$ 23,64



CANETA 0.4MM MICROLINER AMARELO 7409 10X1

Código: Fábrika: Unidade:
48301 YIN'S PAPER CX/10
F1 F4

UN: R\$ 2,20 AV: R\$ 22,05 15: R\$ 22,51
30: R\$ 22,96 45: R\$ 23,42 60: R\$ 23,89



CANETA 0.4MM MICROLINER LILAS 7379 10X1

Código: Fábrika: Unidade:
47922 YIN'S PAPER CX/10
F1 F4

UN: R\$ 2,20 AV: R\$ 22,05 15: R\$ 22,51
30: R\$ 22,96 45: R\$ 23,42 60: R\$ 23,89



CANETA 0.4MM MICROLINER ROSA 7378 10X1

Código: Fábrika: Unidade:
47920 YIN'S PAPER CX/10
F1 F4

UN: R\$ 2,20 AV: R\$ 22,05 15: R\$ 22,51
30: R\$ 22,96 45: R\$ 23,42 60: R\$ 23,89



CANETA 0.4MM MICROLINER VERDE 7380 10X1

Código: Fábrika: Unidade:
47921 YIN'S PAPER CX/10
F1 F4

UN: R\$ 2,20 AV: R\$ 22,05 15: R\$ 22,51
30: R\$ 22,96 45: R\$ 23,42 60: R\$ 23,89



CANETA 0.4MM MICROLINER VERMEL 7377 10X1

Código: Fábrika: Unidade:
47919 YIN'S PAPER CX/10
F1 F4

UN: R\$ 3,48 AV: R\$ 17,41 15: R\$ 17,77
30: R\$ 18,12 45: R\$ 18,49 60: R\$ 18,86



CANETA 1.0MM COLOR 5X1

Código: Fábrika: Unidade:
46278 MOLIN CR/5
F1 F4

UN: R\$ 13,92 AV: R\$ 13,92 15: R\$ 14,21
30: R\$ 14,50 45: R\$ 14,79 60: R\$ 15,08



CANETINHA HIDR NEO PEN GIG 12 CORES

Código: Fábrika: Unidade:
6897 COMPACTOR CX/1
F1 F4

UN: R\$ 30,18 AV: R\$ 30,18 15: R\$ 30,81
30: R\$ 31,42 45: R\$ 32,05 60: R\$ 32,69



CANETINHA HIDR NEO PEN GIG 24 CORES UN

Código: Fábrika: Unidade:
47862 COMPACTOR CX/1
F1 F4

UN: R\$ 6,96 AV: R\$ 6,96 15: R\$ 7,10
30: R\$ 7,24 45: R\$ 7,39 60: R\$ 7,53



CANETINHA HIDR NEO PEN MIRIM 06 CORES

Código: Fábrika: Unidade:
45062 COMPACTOR CX/1
F1 F4

UN: R\$ 12,76 AV: R\$ 12,76 15: R\$ 13,03
30: R\$ 13,29 45: R\$ 13,55 60: R\$ 13,82



CANETINHA HIDR NEO PEN MIRIM 12 CORES

Código: Fábrika: Unidade:
45061 COMPACTOR CX/1
F1 F4

UN: R\$ 1,03 AV: R\$ 7,18 15: R\$ 7,33
30: R\$ 7,48 45: R\$ 7,63 60: R\$ 7,78



CANETINHA HIDR PQ GROSSA 07 CORES CS-007

Código: Fábrika: Unidade:
45221 MCAVM PT/7
F1 F4

UN: R\$ 4,17 AV: R\$ 4,17 15: R\$ 4,26
30: R\$ 4,34 45: R\$ 4,43 60: R\$ 4,52



CANETINHA HIDROCOR 6 CORES 614878

Código: Fábrika: Unidade:
49958 BAZZE WAVE CR/1
F1 F4

UN: R\$ 6,96 AV: R\$ 6,96 15: R\$ 7,10
30: R\$ 7,24 45: R\$ 7,39 60: R\$ 7,53



CANETINHA HIDROCOR 12 CORES UN 614816
Código: 49959 Fábrica: BAZZE WAVE Unidade: CR/1 F1 F4

UN: R\$ 13,76 AV: R\$ 13,76 15: R\$ 14,05
30: R\$ 14,33 45: R\$ 14,62 60: R\$ 14,91



CANETINHA HIDROCOR 24 CORES WAVE CTL
Código: 41933 Fábrica: TRIS Unidade: CT/1 F1 F4

UN: R\$ 14,21 AV: R\$ 85,26 15: R\$ 87,03
30: R\$ 88,77 45: R\$ 90,55 60: R\$ 92,36



CANETINHA HIDROCOR 24 CORES 6X1
Código: 38256 Fábrica: WALEU Unidade: PT/6 F1 F4

UN: R\$ 12,76 AV: R\$ 12,76 15: R\$ 13,03
30: R\$ 13,29 45: R\$ 13,55 60: R\$ 13,82



CANETINHA HIDROGRAFICA 06 CORES 720
Código: 41649 Fábrica: LEO&LEO Unidade: CR/1 F1 F4

UN: R\$ 6,77 AV: R\$ 81,27 15: R\$ 82,96
30: R\$ 84,62 45: R\$ 86,31 60: R\$ 88,04



CANETINHA HIDROGRAFICA 12 CORES 12X1
Código: 49270 Fábrica: COLORARE Unidade: PT/12 F1 F4

UN: R\$ 0,51 AV: R\$ 51,35 15: R\$ 52,42
30: R\$ 53,47 45: R\$ 54,54 60: R\$ 55,63



CAPA LINE A4 FRENTE AMARELO ENCAD 100X1
Código: 30450 Fábrica: LASSANE Unidade: PT/100 F1 F4

UN: R\$ 0,51 AV: R\$ 51,35 15: R\$ 52,42
30: R\$ 53,47 45: R\$ 54,54 60: R\$ 55,63



CAPA LINE A4 FRENTE AZUL ENCAD 100X1
Código: 30452 Fábrica: LASSANE Unidade: PT/100 F1 F4

UN: R\$ 0,51 AV: R\$ 51,35 15: R\$ 52,42
30: R\$ 53,47 45: R\$ 54,54 60: R\$ 55,63

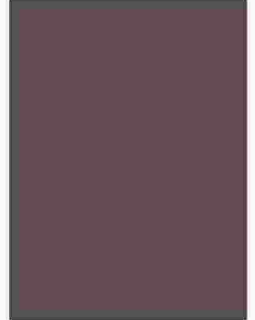

CAPA LINE A4 FRENTE FUME ENCAD 100X1
Código: 36622 Fábrica: LASSANE Unidade: PT/100 F1 F4

UN: R\$ 0,51 AV: R\$ 51,35 15: R\$ 52,42
30: R\$ 53,47 45: R\$ 54,54 60: R\$ 55,63



CAPA LINE A4 FRENTE INCOLOR ENCAD 100X1
Código: 8955 Fábrica: LASSANE Unidade: PT/100 F1 F4

UN: R\$ 0,51 AV: R\$ 51,35 15: R\$ 52,42
30: R\$ 53,47 45: R\$ 54,54 60: R\$ 55,63



CAPA LINE A4 FRENTE ROSA ENCAD 100X1
Código: 36621 Fábrica: LASSANE Unidade: PT/100 F1 F4

UN: R\$ 0,51 AV: R\$ 51,35 15: R\$ 52,42
30: R\$ 53,47 45: R\$ 54,54 60: R\$ 55,63



CAPA LINE A4 FRENTE VERMELHO ENCAD 100X1
Código: 30453 Fábrica: LASSANE Unidade: PT/100 F1 F4

UN: R\$ 0,51 AV: R\$ 51,35 15: R\$ 52,42
30: R\$ 53,47 45: R\$ 54,54 60: R\$ 55,63

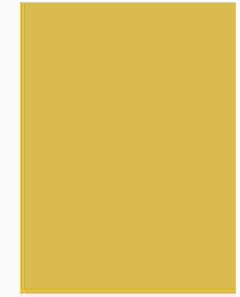

CAPA LINE A4 FUNDO AMARELO ENCAD 10X1
Código: 30451 Fábrica: LASSANE Unidade: PT/100 F1 F4

UN: R\$ 0,51 AV: R\$ 51,35 15: R\$ 52,42
30: R\$ 53,47 45: R\$ 54,54 60: R\$ 55,63

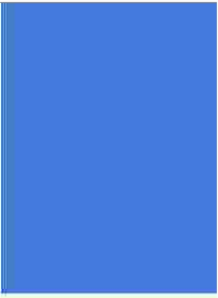

CAPA LINE A4 FUNDO AZUL ENCAD 100X1
Código: 30454 Fábrica: LASSANE Unidade: PT/100 F1 F4

UN: R\$ 0,41 AV: R\$ 41,08 15: R\$ 41,93
30: R\$ 42,77 45: R\$ 43,63 60: R\$ 44,50

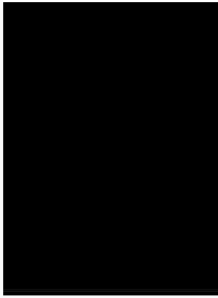

CAPA LINE A4 FUNDO PRETO ENCAD 100X1
Código: 8957 Fábrica: LASSANE Unidade: PT/100 F1 F4

UN: R\$ 0,51 AV: R\$ 51,35 15: R\$ 52,42
30: R\$ 53,47 45: R\$ 54,54 60: R\$ 55,63



CAPA LINE A4 FUNDO VERDE ENCAD 100X1
Código: 30456 Fábrica: LASSANE Unidade: PT/100 F1 F4

UN: R\$ 0,51 AV: R\$ 51,35 15: R\$ 52,42
30: R\$ 53,47 45: R\$ 54,54 60: R\$ 55,63

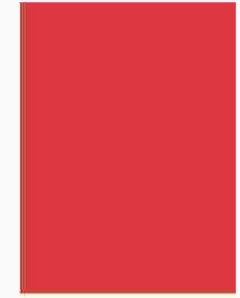

CAPA LINE A4 FUNDO VERMELHO ENCAD 100X1
Código: 30455 Fábrica: LASSANE Unidade: PT/100 F1 F4

UN: R\$ 0,92 AV: R\$ 92,44 15: R\$ 94,36
30: R\$ 96,25 45: R\$ 98,18 60: R\$ 100,14

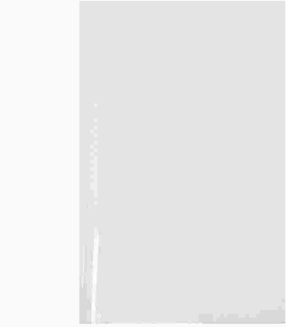

CAPA LINE OF2 FRENTE INCOLOR ENCAD 100X1

Código: Fábrica: Unidade:
41849 LASSANE PT/100
F1 F4

UN: R\$ 1,44 AV: R\$ 71,89 15: R\$ 73,39
30: R\$ 74,86 45: R\$ 76,36 60: R\$ 77,88



CAPA P/CADERNO BROCHURAO TRANSP 50X1

Código: Fábrica: Unidade:
21621 PLASTIBAN PT/50
F1 F4

UN: R\$ 1,23 AV: R\$ 61,62 15: R\$ 62,91
30: R\$ 64,16 45: R\$ 65,45 60: R\$ 66,76

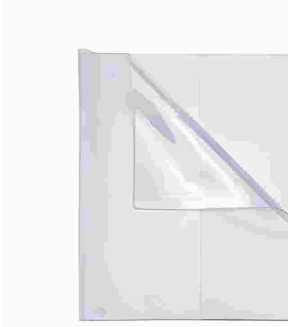

CAPA P/CADERNO CD 1/4 48/96 FLS HP3 50X1

Código: Fábrica: Unidade:
41284 HP PLAST PT/50
F1 F4

UN: R\$ 1,23 AV: R\$ 61,62 15: R\$ 62,91
30: R\$ 64,16 45: R\$ 65,45 60: R\$ 66,76

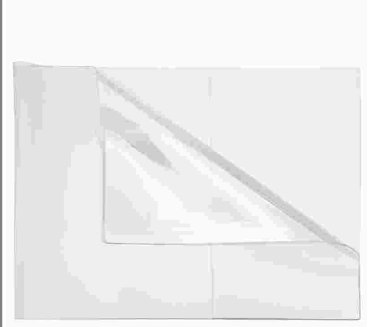

CAPA P/CADERNO DESENHO SOLTA HP25 50X1

Código: Fábrica: Unidade:
41282 HP PLAST PT/50
F1 F4

UN: R\$ 1,44 AV: R\$ 71,89 15: R\$ 73,39
30: R\$ 74,86 45: R\$ 76,36 60: R\$ 77,88

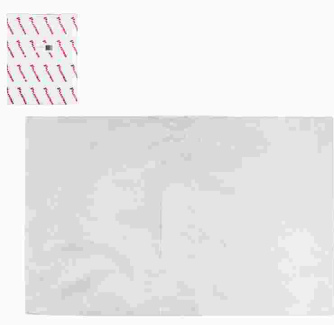

CAPA P/CADERNO UNIVERSITARIO TRANSP 50X1

Código: Fábrica: Unidade:
21623 PLASTIBAN PT/50
F1 F4

UN: R\$ 1,23 AV: R\$ 61,62 15: R\$ 62,91
30: R\$ 64,16 45: R\$ 65,45 60: R\$ 66,76

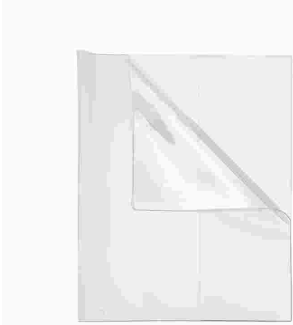

CAPA P/CADERNO 1/4 48/96 FLS HP2 50X1

Código: Fábrica: Unidade:
41283 HP PLAST PT/50
F1 F4

UN: R\$ 2,94 AV: R\$ 293,78 15: R\$ 299,90
30: R\$ 305,90 45: R\$ 312,02 60: R\$ 318,26



CARBONO COST 44X66CM RISC/BOR AMAR 100X1

Código: Fábrica: Unidade:
48067 PRINTERS CE/100
F1 F4

UN: R\$ 2,94 AV: R\$ 293,78 15: R\$ 299,90
30: R\$ 305,90 45: R\$ 312,02 60: R\$ 318,26



CARBONO COST 44X66CM RISC/BOR AZUL 100X1

Código: Fábrica: Unidade:
48066 PRINTERS CE/100
F1 F4

UN: R\$ 2,94 AV: R\$ 293,78 15: R\$ 299,90
30: R\$ 305,90 45: R\$ 312,02 60: R\$ 318,26

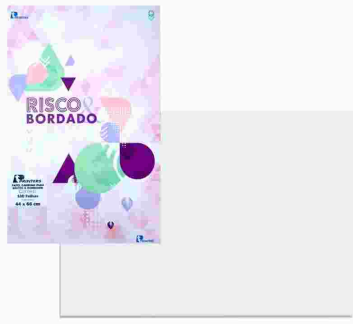

CARBONO COST 44X66CM RISC/BOR BCO 100X1

Código: Fábrica: Unidade:
48068 PRINTERS CE/100
F1 F4

UN: R\$ 2,94 AV: R\$ 293,78 15: R\$ 299,90
30: R\$ 305,90 45: R\$ 312,02 60: R\$ 318,26



CARBONO COST 44X66CM RISC/BOR PTO 100X1

Código: Fábrica: Unidade:
48069 PRINTERS CE/100
F1 F4

UN: R\$ 2,94 AV: R\$ 293,78 15: R\$ 299,90
30: R\$ 305,90 45: R\$ 312,02 60: R\$ 318,26



CARBONO COST 44X66CM RISC/BOR VERM 100X1

Código: Fábrica: Unidade:
50833 PRINTERS CE/100
F1 F4

UN: R\$ 0,62 AV: R\$ 61,63 15: R\$ 62,92
30: R\$ 64,17 45: R\$ 65,46 60: R\$ 66,77



CARBONO DUPLA FACE AZUL 5861 100X1

Código: Fábrica: Unidade:
22898 GOLLER CX/100
F1 F4

UN: R\$ 0,55 AV: R\$ 55,44 15: R\$ 56,59
30: R\$ 57,72 45: R\$ 58,88 60: R\$ 60,06



CARBONO DUPLA FACE AZUL 98688 100X1

Código: Fábrica: Unidade:
48323 BAZZE CX/100
F1 F4

UN: R\$ 0,46 AV: R\$ 46,21 15: R\$ 47,18
30: R\$ 48,12 45: R\$ 49,08 60: R\$ 50,06

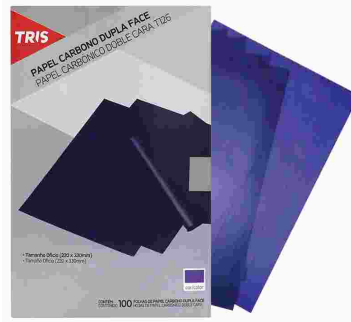

CARBONO DUPLA FACE ROXO 17139 100X1

Código: Fábrica: Unidade:
41926 TRIS CX/100
F1 F4

UN: R\$ 0,51 AV: R\$ 51,35 15: R\$ 52,42
30: R\$ 53,47 45: R\$ 54,54 60: R\$ 55,63



CARBONO FILM AZUL 1 FACE 100X1

Código: Fábrica: Unidade:
6845 KORES CE/100
F1 F4

UN: R\$ 4,28 AV: R\$ 51,35 15: R\$ 52,42
30: R\$ 53,47 45: R\$ 54,54 60: R\$ 55,63



CARBONO P/RISCO 33X44CM AZUL 2602 12X1

Código: Fábrica: Unidade:
45504 GLIART PT/12
F1 F4

UN: R\$ 4,28 AV: R\$ 51,35 15: R\$ 52,42
30: R\$ 53,47 45: R\$ 54,54 60: R\$ 55,63

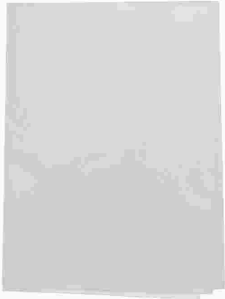

CARBONO P/RISCO 33X44CM BRANCO 2601 12X1

Código: Fábriça: Unidade:
36251 GLIART PT/12
F1 F4

UN: R\$ 0,62 AV: R\$ 61,62 15: R\$ 62,91
30: R\$ 64,16 45: R\$ 65,45 60: R\$ 66,76



CARBONO 1 FACE PRETO A4 100X1

Código: Fábriça: Unidade:
6844 GRAMP LINE PT/100
F1 F4

UN: R\$ 18,48 AV: R\$ 18,48 15: R\$ 18,86
30: R\$ 19,24 45: R\$ 19,63 60: R\$ 20,02



CARIMBO AUTOM AUTO ENTINTAD 14X38MM 2501

Código: Fábriça: Unidade:
46649 CARBRINK UN/1
F1 F4

UN: R\$ 22,59 AV: R\$ 22,59 15: R\$ 23,06
30: R\$ 23,52 45: R\$ 23,99 60: R\$ 24,47



CARIMBO AUTOM AUTO ENTINTAD 18X47MM 2521

Código: Fábriça: Unidade:
50134 CARBRINK UN/1
F1 F4

UN: R\$ 44,16 AV: R\$ 44,16 15: R\$ 45,08
30: R\$ 45,98 45: R\$ 46,90 60: R\$ 47,84



CARIMBO AUTOM AUTO ENTINTAD 60X40MM 2521

Código: Fábriça: Unidade:
50987 CARBRINK UN/1
F1 F4

UN: R\$ 241,39 AV: R\$ 241,39 15: R\$ 246,42
30: R\$ 251,35 45: R\$ 256,38 60: R\$ 261,50



CARIMBO AUTOM NUMERADOR 6 DIG

Código: Fábriça: Unidade:
49177 CARBRINK UN/1
F1 F4

UN: R\$ 25,37 AV: R\$ 25,37 15: R\$ 25,90
30: R\$ 26,42 45: R\$ 26,95 60: R\$ 27,49



CARIMBO ENTINTADO INF NUMEROS 10X1

Código: Fábriça: Unidade:
41974 VMP UN/1
F1 F4

UN: R\$ 2,71 AV: R\$ 70,57 15: R\$ 72,04
30: R\$ 73,48 45: R\$ 74,95 60: R\$ 76,45



CARIMBO ENTINTADO INF SORT 2 26X1

Código: Fábriça: Unidade:
46010 VMP CX/26
F1 F4

UN: R\$ 2,71 AV: R\$ 70,57 15: R\$ 72,04
30: R\$ 73,48 45: R\$ 74,95 60: R\$ 76,45



CARIMBO ENTINTADO INF SORT 3 26X1

Código: Fábriça: Unidade:
46011 VMP CX/26
F1 F4

UN: R\$ 89,22 AV: R\$ 89,22 15: R\$ 91,08
30: R\$ 92,90 45: R\$ 94,76 60: R\$ 96,66



CARIMBOS ALFABETO MAD 28PCS 50932

Código: Fábriça: Unidade:
49529 XALINGO UN/1
F1 F4

UN: R\$ 49,45 AV: R\$ 49,45 15: R\$ 50,48
30: R\$ 51,49 45: R\$ 52,52 60: R\$ 53,57



CARIMBOS ANIMAIS SITIO MAD C/GIZ 50787

Código: Fábriça: Unidade:
49554 XALINGO UN/1
F1 F4

UN: R\$ 34,56 AV: R\$ 34,56 15: R\$ 35,27
30: R\$ 35,98 45: R\$ 36,70 60: R\$ 37,43



CARIMBOS FOFOSAURUS MAD C/GIZ CER 54287

Código: Fábriça: Unidade:
49527 XALINGO UN/1
F1 F4

UN: R\$ 89,22 AV: R\$ 89,22 15: R\$ 91,08
30: R\$ 92,90 45: R\$ 94,76 60: R\$ 96,66



CARIMBOS LETRAS E NUMEROS MAD 40PC 50910

Código: Fábriça: Unidade:
49528 XALINGO UN/1
F1 F4

UN: R\$ 29,91 AV: R\$ 29,91 15: R\$ 30,54
30: R\$ 31,15 45: R\$ 31,77 60: R\$ 32,40



CARIMBOS VOGAIS MAD MINHA ESCOLINHA 1543

Código: Fábriça: Unidade:
49821 XALINGO UN/1
F1 F4

UN: R\$ 4,48 AV: R\$ 89,64 15: R\$ 91,51
30: R\$ 93,34 45: R\$ 95,20 60: R\$ 97,11



CARNE GPS (GUIA PREVIDENCIA SOCIAL) 20X1

Código: Fábriça: Unidade:
24938 PARRKE PT/20
F1 F4

UN: R\$ 0,11 AV: R\$ 11,04 15: R\$ 11,27
30: R\$ 11,50 45: R\$ 11,73 60: R\$ 11,96

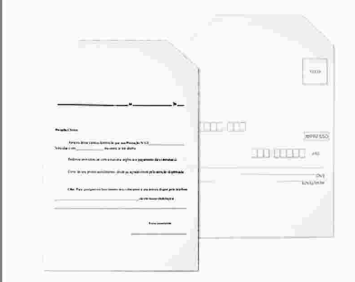

CARTA COBRANCA 100X1

Código: Fábriça: Unidade:
1330 UNICART CE/100
F1 F4

UN: R\$ 1,73 AV: R\$ 17,31 15: R\$ 17,67
30: R\$ 18,02 45: R\$ 18,38 60: R\$ 18,75



CARTAO G-11 REF 155 BODAS 10X1

Código: Fábrica: Unidade:
5129 UNICART PT/10
F1 F4

UN: R\$ 0,21 AV: R\$ 21,22 15: R\$ 21,66
30: R\$ 22,10 45: R\$ 22,54 60: R\$ 22,99

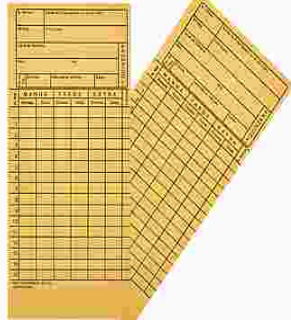

CARTAO PONTO MENSAL SIMPLES 100X1

Código: Fábrica: Unidade:
27101 GRIFFE PT/100
F1 F4

UN: R\$ 0,32 AV: R\$ 15,81 15: R\$ 16,14
30: R\$ 16,46 45: R\$ 16,79 60: R\$ 17,12



CARTAZ ALUGA-SE 157X320MM 50X1

Código: Fábrica: Unidade:
39289 TAMOIO PT/50
F1 F4

UN: R\$ 0,32 AV: R\$ 15,81 15: R\$ 16,14
30: R\$ 16,46 45: R\$ 16,79 60: R\$ 17,12



CARTAZ VENDE-SE 157X320MM 50X1

Código: Fábrica: Unidade:
39290 TAMOIO PT/50
F1 F4

UN: R\$ 2,46 AV: R\$ 49,30 15: R\$ 50,32
30: R\$ 51,33 45: R\$ 52,36 60: R\$ 53,40

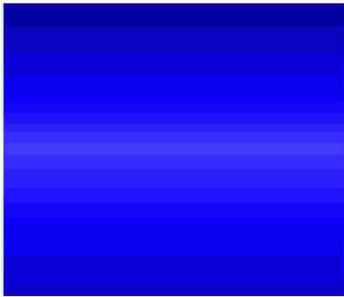

CARTOLINA LAMINADA 48X58CM AZUL 20X1

Código: Fábrica: Unidade:
12804 EMBALE PT/20
F1 F4

UN: R\$ 2,46 AV: R\$ 49,30 15: R\$ 50,32
30: R\$ 51,33 45: R\$ 52,36 60: R\$ 53,40



CARTOLINA LAMINADA 48X58CM OURO 20X1

Código: Fábrica: Unidade:
12805 EMBALE PT/20
F1 F4

UN: R\$ 2,46 AV: R\$ 49,30 15: R\$ 50,32
30: R\$ 51,33 45: R\$ 52,36 60: R\$ 53,40

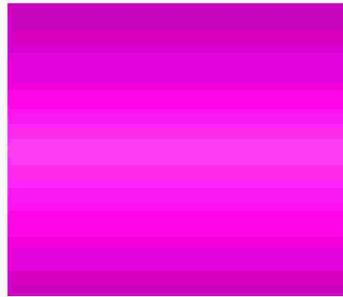

CARTOLINA LAMINADA 48X58CM PINK 20X1

Código: Fábrica: Unidade:
12806 EMBALE PT/20
F1 F4

UN: R\$ 2,05 AV: R\$ 41,08 15: R\$ 41,93
30: R\$ 42,77 45: R\$ 43,63 60: R\$ 44,50

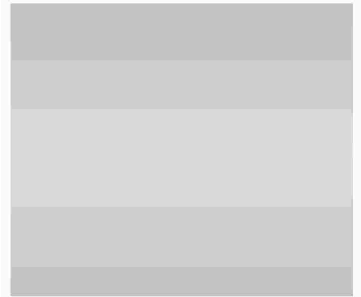

CARTOLINA LAMINADA 48X58CM PRATA 20X1

Código: Fábrica: Unidade:
7134 EMBALE PT/20
F1 F4

UN: R\$ 2,46 AV: R\$ 49,30 15: R\$ 50,32
30: R\$ 51,33 45: R\$ 52,36 60: R\$ 53,40



CARTOLINA LAMINADA 48X58CM VERDE 20X1

Código: Fábrica: Unidade:
12807 EMBALE PT/20
F1 F4

UN: R\$ 2,46 AV: R\$ 49,30 15: R\$ 50,32
30: R\$ 51,33 45: R\$ 52,36 60: R\$ 53,40

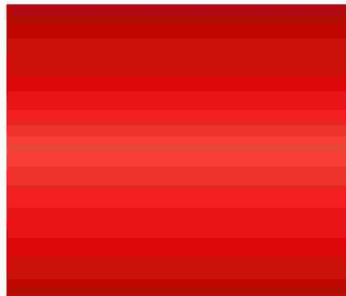

CARTOLINA LAMINADA 48X58CM VERMELHO 20X1

Código: Fábrica: Unidade:
12808 EMBALE PT/20
F1 F4

UN: R\$ 1,23 AV: R\$ 123,25 15: R\$ 125,82
30: R\$ 128,34 45: R\$ 130,90 60: R\$ 133,52



CARTOLINA SORTIDA 100X1

Código: Fábrica: Unidade:
29236 MINASPEL CE/100
F1 F4

UN: R\$ 1,13 AV: R\$ 112,98 15: R\$ 115,34
30: R\$ 117,64 45: R\$ 120,00 60: R\$ 122,40



CARTOLINA 47X65CM AMARELA 100X1

Código: Fábrica: Unidade:
13184 MINASPEL CE/100
F1 F4

UN: R\$ 1,13 AV: R\$ 112,98 15: R\$ 115,34
30: R\$ 117,64 45: R\$ 120,00 60: R\$ 122,40



CARTOLINA 47X65CM AZUL 100X1

Código: Fábrica: Unidade:
13186 MINASPEL CE/100
F1 F4

UN: R\$ 0,92 AV: R\$ 92,44 15: R\$ 94,36
30: R\$ 96,25 45: R\$ 98,18 60: R\$ 100,14



CARTOLINA 47X65CM BRANCA 100X1

Código: Fábrica: Unidade:
838 MINASPEL CE/100
F1 F4

UN: R\$ 1,13 AV: R\$ 112,98 15: R\$ 115,34
30: R\$ 117,64 45: R\$ 120,00 60: R\$ 122,40



CARTOLINA 47X65CM ROSA 100X1

Código: Fábrica: Unidade:
13185 MINASPEL CE/100
F1 F4

UN: R\$ 1,13 AV: R\$ 112,98 15: R\$ 115,34
30: R\$ 117,64 45: R\$ 120,00 60: R\$ 122,40



CARTOLINA 47X65CM VERDE 100X1

Código: Fábrica: Unidade:
13187 MINASPEL CE/100
F1 F4

UN: R\$ 64,70 AV: R\$ 64,70 15: R\$ 66,05
30: R\$ 67,37 45: R\$ 68,72 60: R\$ 70,09



CAVALETE P/TELA PINTURA NEO 071 CM 9922
Código: Fábrica: Unidade:
47878 STALO UN/1
F1 F4

UN: R\$ 1,64 AV: R\$ 82,17 15: R\$ 83,88
30: R\$ 85,56 45: R\$ 87,27 60: R\$ 89,01



CD-R GRAVAVEL 80 MIN 700 MB 50X1
Código: Fábrica: Unidade:
18272 MAKETECH PT/50
F1 F4

UN: R\$ 1,92 AV: R\$ 15,40 15: R\$ 15,72
30: R\$ 16,03 45: R\$ 16,35 60: R\$ 16,68



CHAVEIRO E ETIQUETA CORES C/SUPORTE 8X1
Código: Fábrica: Unidade:
48056 MAXCRIL CR/8
F1 F4

UN: R\$ 1,41 AV: R\$ 169,49 15: R\$ 173,02
30: R\$ 176,48 45: R\$ 180,01 60: R\$ 183,61



CHAVEIRO E ETIQUETA CORES POTE 120X1
Código: Fábrica: Unidade:
40483 ACRINIL C//120
F1 F4

UN: R\$ 1,39 AV: R\$ 66,76 15: R\$ 68,15
30: R\$ 69,51 45: R\$ 70,90 60: R\$ 72,32



CHAVEIRO E ETIQUETA CORES POTE 48X1
Código: Fábrica: Unidade:
46742 KAZ C//48
F1 F4

UN: R\$ 1,82 AV: R\$ 108,93 15: R\$ 111,20
30: R\$ 113,43 45: R\$ 115,70 60: R\$ 118,01



CHAVEIRO E ETIQUETA CORES POTE 60X1
Código: Fábrica: Unidade:
40482 ACRIMET C//60
F1 F4

UN: R\$ 1,41 AV: R\$ 169,49 15: R\$ 173,02
30: R\$ 176,48 45: R\$ 180,01 60: R\$ 183,61



CHAVEIRO E ETIQUETA CRISTAL POTE 120X1
Código: Fábrica: Unidade:
46008 ACRINIL C//120
F1 F4

UN: R\$ 1,56 AV: R\$ 37,49 15: R\$ 38,27
30: R\$ 39,04 45: R\$ 39,82 60: R\$ 40,62



CHAVEIRO E ETIQUETA CRISTAL POTE 24X1
Código: Fábrica: Unidade:
46007 ACRINIL C//24
F1 F4

UN: R\$ 300,46 AV: R\$ 300,46 15: R\$ 306,72
30: R\$ 312,85 45: R\$ 319,11 60: R\$ 325,49

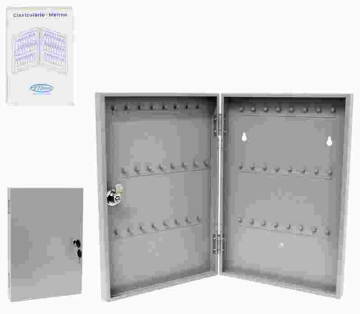

CLAVICULARIO UN
Código: Fábrica: Unidade:
43476 MENNO UN/1
F1 F4

UN: R\$ 12,61 AV: R\$ 12,61 15: R\$ 12,88
30: R\$ 13,13 45: R\$ 13,40 60: R\$ 13,66



CLIPS 0 METAL P/PAPEL 500 GRS
Código: Fábrica: Unidade:
11059 BRW CX/1
F1 F4

UN: R\$ 0,02 AV: R\$ 19,00 15: R\$ 19,40
30: R\$ 19,79 45: R\$ 20,18 60: R\$ 20,59



CLIPS 0 METAL P/PAPEL 770X1
Código: Fábrica: Unidade:
35869 LVC CX/770
F1 F4

UN: R\$ 0,02 AV: R\$ 20,12 15: R\$ 20,76
30: R\$ 21,38 45: R\$ 22,02 60: R\$ 22,68



CLIPS 1 P/PAPEL 500G
Código: Fábrica: Unidade:
24776 GASPER CX/940
F1 F4

UN: R\$ 0,03 AV: R\$ 3,07 15: R\$ 3,14
30: R\$ 3,20 45: R\$ 3,26 60: R\$ 3,33



CLIPS 1/0 METAL P/PAPEL 100X1
Código: Fábrica: Unidade:
41773 JUSSARA CX/100
F1 F4

UN: R\$ 0,03 AV: R\$ 3,07 15: R\$ 3,14
30: R\$ 3,20 45: R\$ 3,26 60: R\$ 3,33



CLIPS 1/0 METAL P/PAPEL 100X1
Código: Fábrica: Unidade:
42187 BACCHI CX/100
F1 F4

UN: R\$ 0,02 AV: R\$ 19,00 15: R\$ 19,40
30: R\$ 19,79 45: R\$ 20,18 60: R\$ 20,59



CLIPS 1/0 (0) METAL P/PAPEL 770X1
Código: Fábrica: Unidade:
44183 BACCHI CX/770
F1 F4

UN: R\$ 0,02 AV: R\$ 15,40 15: R\$ 15,72
30: R\$ 16,03 45: R\$ 16,35 60: R\$ 16,68



CLIPS 2 METAL ORGAN PENSAMENTOS 800X1
Código: Fábrica: Unidade:
22489 CHAPARRAU CX/800
F1 F4

UN: R\$ 0,03 AV: R\$ 3,07 15: R\$ 3,14
30: R\$ 3,20 45: R\$ 3,26 60: R\$ 3,33



CLIPS 2 METAL P/PAPEL 28MM 7553 100X1

Código: 48141 Fábrica: YIN'S PAPER Unidade: CX/100 F1 F4

UN: R\$ 0,03 AV: R\$ 19,00 15: R\$ 19,40
30: R\$ 19,79 45: R\$ 20,18 60: R\$ 20,59

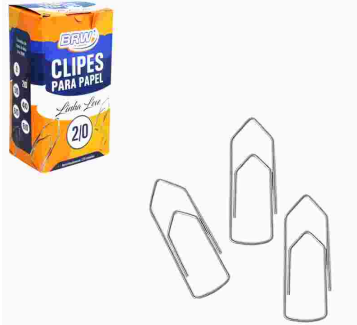

CLIPS 2/0 (0)METAL P/PAPEL APROX 720X1

Código: 27438 Fábrica: BRW Unidade: CX/720 F1 F4

UN: R\$ 0,03 AV: R\$ 19,00 15: R\$ 19,40
30: R\$ 19,79 45: R\$ 20,18 60: R\$ 20,59



CLIPS 2/0 (00) METAL P/PAPEL 720X1

Código: 44182 Fábrica: BACCHI Unidade: CX/720 F1 F4

UN: R\$ 0,02 AV: R\$ 2,04 15: R\$ 2,09
30: R\$ 2,13 45: R\$ 2,17 60: R\$ 2,21



CLIPS 3 METAL P/PAPEL 25MM 7552 100X1

Código: 48140 Fábrica: YIN'S PAPER Unidade: CX/100 F1 F4

UN: R\$ 0,01 AV: R\$ 10,27 15: R\$ 10,49
30: R\$ 10,70 45: R\$ 10,91 60: R\$ 11,13



CLIPS 3 METAL P/PAPEL 500 GRS

Código: 26699 Fábrica: CHAPARRAU Unidade: CX/960 F1 F4

UN: R\$ 0,02 AV: R\$ 19,51 15: R\$ 19,91
30: R\$ 20,31 45: R\$ 20,72 60: R\$ 21,13



CLIPS 3 METAL P/PAPEL 960X1

Código: 41609 Fábrica: LVC Unidade: CX/960 F1 F4

UN: R\$ 0,07 AV: R\$ 3,31 15: R\$ 3,38
30: R\$ 3,44 45: R\$ 3,51 60: R\$ 3,58



CLIPS 3/0 METAL P/PAPEL 50X1

Código: 46895 Fábrica: JUSSARA Unidade: CX/50 F1 F4

UN: R\$ 0,03 AV: R\$ 15,40 15: R\$ 15,72
30: R\$ 16,03 45: R\$ 16,35 60: R\$ 16,68



CLIPS 3/0 METAL P/PAPEL 440X1

Código: 35866 Fábrica: LVC Unidade: CX/440 F1 F4

UN: R\$ 0,04 AV: R\$ 15,40 15: R\$ 15,72
30: R\$ 16,03 45: R\$ 16,35 60: R\$ 16,68



CLIPS 4/0 METAL P/PAPEL 400X1

Código: 35868 Fábrica: LVC Unidade: CX/400 F1 F4

UN: R\$ 0,06 AV: R\$ 3,07 15: R\$ 3,14
30: R\$ 3,20 45: R\$ 3,26 60: R\$ 3,33



CLIPS 4/0 METAL P/PAPEL 50X1

Código: 43522 Fábrica: TOP Unidade: CX/50 F1 F4

UN: R\$ 0,11 AV: R\$ 5,64 15: R\$ 5,76
30: R\$ 5,87 45: R\$ 5,99 60: R\$ 6,11



CLIPS 6/0 METAL P/PAPEL 50X1

Código: 46898 Fábrica: JUSSARA Unidade: CX/50 F1 F4

UN: R\$ 0,08 AV: R\$ 18,27 15: R\$ 18,65
30: R\$ 19,03 45: R\$ 19,41 60: R\$ 19,80



CLIPS 6/0 METAL P/PAPEL 220X1

Código: 46897 Fábrica: JUSSARA Unidade: CX/220 F1 F4

UN: R\$ 0,07 AV: R\$ 3,58 15: R\$ 3,66
30: R\$ 3,73 45: R\$ 3,81 60: R\$ 3,88



CLIPS 6/0 METAL P/PAPEL 50X1

Código: 42587 Fábrica: BACCHI Unidade: CX/50 F1 F4

UN: R\$ 0,11 AV: R\$ 19,10 15: R\$ 19,49
30: R\$ 19,88 45: R\$ 20,28 60: R\$ 20,69



CLIPS 8/0 METAL P/PAPEL 170X1

Código: 46899 Fábrica: JUSSARA Unidade: CX/170 F1 F4

UN: R\$ 0,11 AV: R\$ 19,10 15: R\$ 19,49
30: R\$ 19,88 45: R\$ 20,28 60: R\$ 20,69



CLIPS 8/0 METAL P/PAPEL 170X1

Código: 35867 Fábrica: CHAPARRAU Unidade: CX/170 F1 F4

UN: R\$ 0,11 AV: R\$ 19,10 15: R\$ 19,49
30: R\$ 19,88 45: R\$ 20,28 60: R\$ 20,69



CLIPS 8/0 METAL P/PAPEL 170X1

Código: 42664 Fábrica: TOP/BACCHI Unidade: CX/170 F1 F4

UN: R\$ 0,12 AV: R\$ 3,07 15: R\$ 3,14
30: R\$ 3,20 45: R\$ 3,26 60: R\$ 3,33

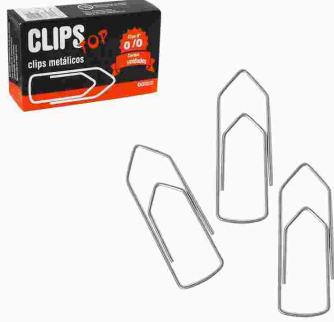

CLIPS 8/0 METAL P/PAPEL 25X1
Código: 34104 Fábrica: CHAPARRAU Unidade: CX/25 F1 F4

UN: R\$ 0,13 AV: R\$ 3,28 15: R\$ 3,35
30: R\$ 3,41 45: R\$ 3,48 60: R\$ 3,55



CLIPS 8/0 METAL P/PAPEL 25X1
Código: 42743 Fábrica: BACCHI Unidade: CX/25 F1 F4

UN: R\$ 0,33 AV: R\$ 19,51 15: R\$ 19,91
30: R\$ 20,31 45: R\$ 20,72 60: R\$ 21,13



CLIPS BINDER 15MM PRETO 292204 60X1
Código: 46380 Fábrica: FUTURO Unidade: PT/60 F1 F4

UN: R\$ 0,38 AV: R\$ 15,40 15: R\$ 15,72
30: R\$ 16,03 45: R\$ 16,35 60: R\$ 16,68



CLIPS BINDER 19MM (PRENDEDOR) COLOR 40X1
Código: 41931 Fábrica: TRIS Unidade: PT/40 F1 F4

UN: R\$ 0,53 AV: R\$ 25,67 15: R\$ 26,20
30: R\$ 26,73 45: R\$ 27,26 60: R\$ 27,81



CLIPS BINDER 25MM COLOR 48X1
Código: 41930 Fábrica: TRIS Unidade: PT/48 F1 F4

UN: R\$ 0,81 AV: R\$ 19,51 15: R\$ 19,91
30: R\$ 20,31 45: R\$ 20,72 60: R\$ 21,13



CLIPS BINDER 32MM PRETO 618913 24X1
Código: 49940 Fábrica: BAZZE Unidade: PT/24 F1 F4

UN: R\$ 1,32 AV: R\$ 31,59 15: R\$ 32,24
30: R\$ 32,89 45: R\$ 33,55 60: R\$ 34,22



CLIPS BINDER 41MM PRETO 292204 24X1
Código: 46379 Fábrica: FUTURO Unidade: PT/24 F1 F4

UN: R\$ 2,14 AV: R\$ 25,67 15: R\$ 26,20
30: R\$ 26,73 45: R\$ 27,26 60: R\$ 27,81



CLIPS BINDER 51MM PRETO 93092 12X1
Código: 42727 Fábrica: JOCAROFFICE Unidade: PT/12 F1 F4

UN: R\$ 0,16 AV: R\$ 4,92 15: R\$ 5,02
30: R\$ 5,12 45: R\$ 5,23 60: R\$ 5,33
12,5 cm



CLIPS MINI PRENDEDOR MAD 2,5CM COLOR30X1
Código: 44510 Fábrica: ALIANCA Unidade: PT/30 F1 F4

UN: R\$ 0,04 AV: R\$ 4,42 15: R\$ 4,51
30: R\$ 4,60 45: R\$ 4,69 60: R\$ 4,79



CLIPS MINI 5 GALVANIZADO P/PAPEL 100X1
Código: 46070 Fábrica: BACCHI Unidade: CX/100 F1 F4

UN: R\$ 0,03 AV: R\$ 3,17 15: R\$ 3,24
30: R\$ 3,31 45: R\$ 3,37 60: R\$ 3,44



CLIPS P/PAPEL COLOR 28MM 80207 100X1
Código: 44541 Fábrica: WIN PAPER Unidade: CX/100 F1 F4

UN: R\$ 0,03 AV: R\$ 3,07 15: R\$ 3,14
30: R\$ 3,20 45: R\$ 3,26 60: R\$ 3,33



CLIPS P/PAPEL NIQUEL 5 MINI 80193 100X1
Código: 44743 Fábrica: WIN PAPER Unidade: CX/100 F1 F4

UN: R\$ 1,08 AV: R\$ 107,85 15: R\$ 110,09
30: R\$ 112,29 45: R\$ 114,54 60: R\$ 116,83



CLIPS REMOVIVEL JACARE C/ALCA 100X1
Código: 9732 Fábrica: DAC Unidade: CE/100 F1 F4

UN: R\$ 0,31 AV: R\$ 5,64 15: R\$ 5,76
30: R\$ 5,87 45: R\$ 5,99 60: R\$ 6,11



CLIPS 10/0 METAL P/PAPEL 18X1
Código: 44186 Fábrica: BACCHI Unidade: CX/18 F1 F4

UN: R\$ 0,27 AV: R\$ 28,75 15: R\$ 29,35
30: R\$ 29,94 45: R\$ 30,54 60: R\$ 31,15



CLIPS 12/0 METAL P/PAPEL 105X1
Código: 44188 Fábrica: BACCHI Unidade: CX/105 F1 F4

UN: R\$ 0,40 AV: R\$ 4,82 15: R\$ 4,92
30: R\$ 5,02 45: R\$ 5,12 60: R\$ 5,22



CLIPS 12/0 METAL P/PAPEL 12X1
Código: 44187 Fábrica: BACCHI Unidade: CX/12 F1 F4

UN: R\$ 6,85 AV: R\$ 41,08 15: R\$ 41,93
30: R\$ 42,77 45: R\$ 43,63 60: R\$ 44,50



COLA ISOPOR & EVA 90 GRS COLA MAIS 6X1
Código: Fábrica: Unidade:
42574 COLA MAIS PT/6
F1 F4

UN: R\$ 1,84 AV: R\$ 11,04 15: R\$ 11,27
30: R\$ 11,50 45: R\$ 11,73 60: R\$ 11,96



COLA 25 GRS 6 CORES C/GLITTER SORT
Código: Fábrica: Unidade:
46433 KAZ CX/6
F1 F4

UN: R\$ 11,29 AV: R\$ 11,29 15: R\$ 11,52
30: R\$ 11,75 45: R\$ 11,99 60: R\$ 12,23



COLA ADESIVO INSTANTANEO 20 GRS UN
Código: Fábrica: Unidade:
42934 GLIART UN/1
F1 F4

UN: R\$ 4,69 AV: R\$ 4,69 15: R\$ 4,79
30: R\$ 4,89 45: R\$ 4,99 60: R\$ 5,09



COLA ADESIVO PVC P/CANO 17 GRS UN
Código: Fábrica: Unidade:
50754 TEK BOND UN/1
F1 F4

UN: R\$ 59,89 AV: R\$ 59,89 15: R\$ 61,13
30: R\$ 62,36 45: R\$ 63,60 60: R\$ 64,88



COLA ADESIVO SPRAY CONTATO 500ML
Código: Fábrica: Unidade:
50979 TEK BOND UN/1
F1 F4

UN: R\$ 10,27 AV: R\$ 10,27 15: R\$ 10,49
30: R\$ 10,70 45: R\$ 10,91 60: R\$ 11,13



COLA BASTAO 10 GRS
Código: Fábrica: Unidade:
15350 ACRILEX UN/1
F1 F4

UN: R\$ 3,69 AV: R\$ 36,86 15: R\$ 37,62
30: R\$ 38,38 45: R\$ 39,14 60: R\$ 39,93



COLA BASTAO 10 GRS 02710 10X1
Código: Fábrica: Unidade:
41326 ACRILEX PT/10
F1 F4

UN: R\$ 1,11 AV: R\$ 13,34 15: R\$ 13,62
30: R\$ 13,89 45: R\$ 14,17 60: R\$ 14,46



COLA BASTAO 10 GRS 10101 12X1
Código: Fábrica: Unidade:
41327 GATTE KIDS DZ/12
F1 F4

UN: R\$ 1,22 AV: R\$ 14,69 15: R\$ 15,00
30: R\$ 15,29 45: R\$ 15,60 60: R\$ 15,91



COLA BASTAO 10 GRS 12X1
Código: Fábrica: Unidade:
50031 BAZZE CX/12
F1 F4

UN: R\$ 2,72 AV: R\$ 32,69 15: R\$ 33,37
30: R\$ 34,03 45: R\$ 34,71 60: R\$ 35,41



COLA BASTAO 20 GRS 12X1
Código: Fábrica: Unidade:
50759 MARIPEL CX/12
F1 F4

UN: R\$ 1,96 AV: R\$ 23,57 15: R\$ 24,07
30: R\$ 24,55 45: R\$ 25,04 60: R\$ 25,54



COLA BASTAO 20 GRS 12X1
Código: Fábrica: Unidade:
50032 BAZZE CX/12
F1 F4

UN: R\$ 2,97 AV: R\$ 17,83 15: R\$ 18,20
30: R\$ 18,57 45: R\$ 18,94 60: R\$ 19,32



COLA BASTAO 40 GRS 6X1
Código: Fábrica: Unidade:
50207 BAZZE CX/6
F1 F4

UN: R\$ 3,58 AV: R\$ 3,58 15: R\$ 3,66
30: R\$ 3,73 45: R\$ 3,81 60: R\$ 3,88



COLA BRANCA 40 GRS UN
Código: Fábrica: Unidade:
51069 TEK BOND UN/1
F1 F4

UN: R\$ 0,87 AV: R\$ 73,32 15: R\$ 75,66
30: R\$ 77,93 45: R\$ 80,27 60: R\$ 82,68



COLA BRANCA 40 GRS 84X1
Código: Fábrica: Unidade:
30509 COPLAMIX CX/84
F1 F4

UN: R\$ 16,18 AV: R\$ 16,18 15: R\$ 16,52
30: R\$ 16,85 45: R\$ 17,18 60: R\$ 17,53



COLA BRANCA 1 KG
Código: Fábrica: Unidade:
42575 FIRST UN/1
F1 F4

UN: R\$ 51,35 AV: R\$ 51,35 15: R\$ 52,42
30: R\$ 53,47 45: R\$ 54,54 60: R\$ 55,63



COLA BRANCA 1 KG EXTRA USO PROFISSIONAL
Código: Fábrica: Unidade:
1181 APLICOLA UN/1
F1 F4

UN: R\$ 16,18 AV: R\$ 16,18 15: R\$ 16,52
30: R\$ 16,85 45: R\$ 17,18 60: R\$ 17,53



COLA BRANCA 1 KG NEW MAGIC
Código: Fábrika: Unidade:
19689 NEW MAGIC UN/1
F1 F4

UN: R\$ 4,67 AV: R\$ 4,67 15: R\$ 4,77
30: R\$ 4,87 45: R\$ 4,96 60: R\$ 5,06



COLA BRANCA 100 GRS ACRILEX UN
Código: Fábrika: Unidade:
40900 ACRILEX UN/1
F1 F4

UN: R\$ 3,42 AV: R\$ 20,53 15: R\$ 20,96
30: R\$ 21,38 45: R\$ 21,81 60: R\$ 22,24



COLA BRANCA 110 GRS COLA MAIS 6X1
Código: Fábrika: Unidade:
45152 COLA MAIS PT/6
F1 F4

UN: R\$ 2,97 AV: R\$ 2,97 15: R\$ 3,03
30: R\$ 3,09 45: R\$ 3,15 60: R\$ 3,22



COLA BRANCA 110 GRS COLA UN
Código: Fábrika: Unidade:
46511 COLA MAIS UN/1
F1 F4

UN: R\$ 1,80 AV: R\$ 1,80 15: R\$ 1,84
30: R\$ 1,87 45: R\$ 1,91 60: R\$ 1,95



COLA BRANCA 37 GRS UN
Código: Fábrika: Unidade:
42019 ACRILEX UN/1
F1 F4

UN: R\$ 1,72 AV: R\$ 1,72 15: R\$ 1,75
30: R\$ 1,79 45: R\$ 1,82 60: R\$ 1,86



COLA BRANCA 40 GRS COLEX UN
Código: Fábrika: Unidade:
46797 INJEX PEN UN/1
F1 F4

UN: R\$ 1,95 AV: R\$ 140,73 15: R\$ 143,66
30: R\$ 146,53 45: R\$ 149,46 60: R\$ 152,45



COLA BRANCA 40 GRS NEW MAGIC 72X1
Código: Fábrika: Unidade:
30112 NEW MAGIC CX/72
F1 F4

UN: R\$ 1,72 AV: R\$ 1,72 15: R\$ 1,75
30: R\$ 1,79 45: R\$ 1,82 60: R\$ 1,86



COLA BRANCA 40 GRS UN
Código: Fábrika: Unidade:
42783 NEW MAGIC UN/1
F1 F4

UN: R\$ 1,71 AV: R\$ 20,53 15: R\$ 20,96
30: R\$ 21,38 45: R\$ 21,81 60: R\$ 22,24



COLA BRANCA 40 GRS 12X1
Código: Fábrika: Unidade:
44031 PALHACINHO DZ/12
F1 F4

UN: R\$ 11,29 AV: R\$ 11,29 15: R\$ 11,52
30: R\$ 11,75 45: R\$ 11,99 60: R\$ 12,23



COLA BRANCA 500 GRS
Código: Fábrika: Unidade:
3347 COPLAMIX UN/1
F1 F4

UN: R\$ 12,28 AV: R\$ 12,28 15: R\$ 12,53
30: R\$ 12,78 45: R\$ 13,04 60: R\$ 13,30



COLA BRANCA 500 GRS
Código: Fábrika: Unidade:
42576 COLA MAIS UN/1
F1 F4

UN: R\$ 3,07 AV: R\$ 3,07 15: R\$ 3,14
30: R\$ 3,20 45: R\$ 3,26 60: R\$ 3,33



COLA BRANCA 90 GRS NEW MAGIC UN
Código: Fábrika: Unidade:
50642 NEW MAGIC UN/1
F1 F4

UN: R\$ 3,21 AV: R\$ 154,07 15: R\$ 157,28
30: R\$ 160,43 45: R\$ 163,63 60: R\$ 166,91



COLA BRANCA 90 GRS NEW MAGIC 48X1
Código: Fábrika: Unidade:
35872 NEW MAGIC CX/48
F1 F4

UN: R\$ 3,25 AV: R\$ 19,51 15: R\$ 19,91
30: R\$ 20,31 45: R\$ 20,72 60: R\$ 21,13



COLA BRANCA 90 GRS NEW MAGIC 6X1
Código: Fábrika: Unidade:
27904 NEW MAGIC CX/6
F1 F4

UN: R\$ 7,18 AV: R\$ 7,18 15: R\$ 7,33
30: R\$ 7,48 45: R\$ 7,63 60: R\$ 7,78



COLA BRANCA 90 GRS UN
Código: Fábrika: Unidade:
51070 TEK BOND UN/1
F1 F4

UN: R\$ 2,87 AV: R\$ 34,39 15: R\$ 35,11
30: R\$ 35,81 45: R\$ 36,53 60: R\$ 37,26



COLA BRANCA 90 GRS 12X1
Código: Fábrika: Unidade:
19086 PALHACINHO PT/12
F1 F4

UN: R\$ 2,91 AV: R\$ 17,45 15: R\$ 17,82
30: R\$ 18,17 45: R\$ 18,54 60: R\$ 18,91



COLA BRANCA 90 GRS 6X1

Código: Fábrica: Unidade:
39834 COLA MAIS/IR PT/6
F1 F4

UN: R\$ 3,08 AV: R\$ 12,32 15: R\$ 12,57
30: R\$ 12,82 45: R\$ 13,08 60: R\$ 13,34



COLA BRILHANTE VERD C/GLITTER 25 GRS 4X1

Código: Fábrica: Unidade:
5826 APLICOLA CX/4
F1 F4

UN: R\$ 3,25 AV: R\$ 19,51 15: R\$ 19,91
30: R\$ 20,31 45: R\$ 20,72 60: R\$ 21,13



COLA BRILHANTE 6 COR SORT C/GLIT 25 GRS

Código: Fábrica: Unidade:
3352 APLICOLA CX/6
F1 F4

UN: R\$ 1,96 AV: R\$ 11,78 15: R\$ 12,03
30: R\$ 12,27 45: R\$ 12,51 60: R\$ 12,76



COLA C/GLITTER 25 GRS 6 CORES SORT

Código: Fábrica: Unidade:
46256 COLA MAIS CX/6
F1 F4

UN: R\$ 2,31 AV: R\$ 9,23 15: R\$ 9,43
30: R\$ 9,62 45: R\$ 9,81 60: R\$ 10,00



COLA COLORIDA 23 GRS 4 CORES SORT

Código: Fábrica: Unidade:
45280 ACRILEX CX/4
F1 F4

UN: R\$ 2,22 AV: R\$ 13,34 15: R\$ 13,62
30: R\$ 13,89 45: R\$ 14,17 60: R\$ 14,46



COLA COLORIDA 23 GRS 6 CORES SORT

Código: Fábrica: Unidade:
19855 ACRILEX CX/6
F1 F4

UN: R\$ 5,64 AV: R\$ 5,64 15: R\$ 5,76
30: R\$ 5,87 45: R\$ 5,99 60: R\$ 6,11



COLA EVA E ISOPOR 35 GRS UN

Código: Fábrica: Unidade:
48424 ACRILEX UN/1
F1 F4

UN: R\$ 17,45 AV: R\$ 17,45 15: R\$ 17,82
30: R\$ 18,17 45: R\$ 18,54 60: R\$ 18,91



COLA GEL 120 ML DECOUPAGE MULTICOL 18112

Código: Fábrica: Unidade:
44819 ACRILEX UN/1
F1 F4

UN: R\$ 12,01 AV: R\$ 12,01 15: R\$ 12,26
30: R\$ 12,50 45: R\$ 12,75 60: R\$ 13,01



COLA GEL 60 GRS DECOUPAGE MULTICOLAG 1816

Código: Fábrica: Unidade:
43612 ACRILEX UN/1
F1 F4

UN: R\$ 7,68 AV: R\$ 92,16 15: R\$ 94,08
30: R\$ 95,96 45: R\$ 97,88 60: R\$ 99,84



COLA INSTAN 20 GRS ALTA VISCOSIDAD 12X1

Código: Fábrica: Unidade:
47928 YIN'S PAPER CX/12
F1 F4

UN: R\$ 12,22 AV: R\$ 122,24 15: R\$ 124,78
30: R\$ 127,28 45: R\$ 129,82 60: R\$ 132,42



COLA INSTAN 20 GRS ARTESANATO N1 10X1

Código: Fábrica: Unidade:
48639 TEK BOND CX/10
F1 F4

UN: R\$ 12,22 AV: R\$ 122,24 15: R\$ 124,78
30: R\$ 127,28 45: R\$ 129,82 60: R\$ 132,42



COLA INSTAN 20 GRS ARTESANATO N2 10X1

Código: Fábrica: Unidade:
48640 TEK BOND CX/10
F1 F4

UN: R\$ 12,22 AV: R\$ 122,24 15: R\$ 124,78
30: R\$ 127,28 45: R\$ 129,82 60: R\$ 132,42



COLA INSTAN 20 GRS ARTESANATO N3 10X1

Código: Fábrica: Unidade:
48641 TEK BOND CX/10
F1 F4

UN: R\$ 3,94 AV: R\$ 23,62 15: R\$ 24,11
30: R\$ 24,59 45: R\$ 25,08 60: R\$ 25,58



COLA ISOPOR & EVA 35 GRS COLA MAIS 6X1

Código: Fábrica: Unidade:
39833 COLA MAIS PT/6
F1 F4

UN: R\$ 11,73 AV: R\$ 11,73 15: R\$ 11,98
30: R\$ 12,21 45: R\$ 12,46 60: R\$ 12,71



COLA MADEIRA 100 GRS UN

Código: Fábrica: Unidade:
50720 TEK BOND UN/1
F1 F4

UN: R\$ 7,18 AV: R\$ 7,18 15: R\$ 7,33
30: R\$ 7,48 45: R\$ 7,63 60: R\$ 7,78



COLA PANO 35 GRS 16812 UN

Código: Fábrica: Unidade:
44822 ACRILEX UN/1
F1 F4

UN: R\$ 7,18 AV: R\$ 7,18 15: R\$ 7,33
30: R\$ 7,48 45: R\$ 7,63 60: R\$ 7,78



COLA PANO 37 GRS 16840 UN
Código: Fábrica: Unidade:
45497 ACRILEX UN/1
F1 F4

UN: R\$ 15,40 AV: R\$ 15,40 15: R\$ 15,72
30: R\$ 16,03 45: R\$ 16,35 60: R\$ 16,68



COLA PANO 100 GRS (TECIDO) UN
Código: Fábrica: Unidade:
45402 ACRILEX UN/1
F1 F4

UN: R\$ 46,21 AV: R\$ 46,21 15: R\$ 47,18
30: R\$ 48,12 45: R\$ 49,08 60: R\$ 50,06



COLA PERMANENTE 250 GRS UN
Código: Fábrica: Unidade:
50266 ACRILEX UN/1
F1 F4

UN: R\$ 6,87 AV: R\$ 6,87 15: R\$ 7,02
30: R\$ 7,16 45: R\$ 7,30 60: R\$ 7,44



COLA PERMANENTE 37 GRS UN
Código: Fábrica: Unidade:
42950 ACRILEX UN/1
F1 F4

UN: R\$ 5,30 AV: R\$ 5,30 15: R\$ 5,41
30: R\$ 5,52 45: R\$ 5,63 60: R\$ 5,74



COLA PERMANENTE 37 GRS UN
Código: Fábrica: Unidade:
50733 TEK BOND UN/1
F1 F4

UN: R\$ 0,55 AV: R\$ 4,37 15: R\$ 4,46
30: R\$ 4,55 45: R\$ 4,64 60: R\$ 4,73



COLA QUENTE FINA REFIL 175 8X1
Código: Fábrica: Unidade:
30471 FUTURO PT/8
F1 F4

UN: R\$ 1,35 AV: R\$ 6,77 15: R\$ 6,91
30: R\$ 7,05 45: R\$ 7,19 60: R\$ 7,33



COLA QUENTE GROSSA REFIL 176 5X1
Código: Fábrica: Unidade:
50225 FUTURO PT/5
F1 F4

UN: R\$ 62,97 AV: R\$ 62,97 15: R\$ 64,28
30: R\$ 65,56 45: R\$ 66,88 60: R\$ 68,21



COLA QUENTE 1 KG FINA REFIL APROX 77X1
Código: Fábrica: Unidade:
5953 PLANETA KG/1
F1 F4

UN: R\$ 49,99 AV: R\$ 49,99 15: R\$ 49,99
30: R\$ 49,99 45: R\$ 49,99 60: R\$ 49,99



COLA QUENTE 1 KG FINA REFIL 84X1
Código: Fábrica: Unidade:
50027 BAZZE KG/1
F1 F4

UN: R\$ 61,62 AV: R\$ 61,62 15: R\$ 62,91
30: R\$ 64,16 45: R\$ 65,45 60: R\$ 66,76



COLA QUENTE 1 KG GROSSA REFIL APROX 32X1
Código: Fábrica: Unidade:
46425 KAZ KG/1
F1 F4

UN: R\$ 49,99 AV: R\$ 49,99 15: R\$ 49,99
30: R\$ 49,99 45: R\$ 49,99 60: R\$ 49,99

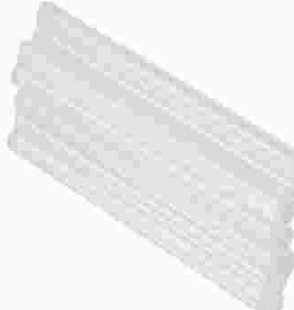

COLA QUENTE 1 KG GROSSA REFIL APROX 32X1
Código: Fábrica: Unidade:
3016 IB/REN/FU/PL KG/1
F1 F4

UN: R\$ 9,23 AV: R\$ 9,23 15: R\$ 9,43
30: R\$ 9,62 45: R\$ 9,81 60: R\$ 10,00



COLA SILICONE LIQUIDA 100ML UN
Código: Fábrica: Unidade:
31876 LEO&LEO UN/1
F1 F4

UN: R\$ 6,00 AV: R\$ 6,00 15: R\$ 6,12
30: R\$ 6,25 45: R\$ 6,37 60: R\$ 6,50



COLA SILICONE LIQUIDA 54 GRS UN
Código: Fábrica: Unidade:
48950 LEO&LEO UN/1
F1 F4

UN: R\$ 5,04 AV: R\$ 30,25 15: R\$ 30,88
30: R\$ 31,50 45: R\$ 32,13 60: R\$ 32,77



COLA SILICONE LIQUIDA 54 GRS 60ML 6X1
Código: Fábrica: Unidade:
50029 BAZZE CX/6
F1 F4

UN: R\$ 6,16 AV: R\$ 73,96 15: R\$ 75,50
30: R\$ 77,01 45: R\$ 78,55 60: R\$ 80,12



COLA SILICONE LIQUIDA 60 GRS 0060 12X1
Código: Fábrica: Unidade:
33685 BRW CX/12
F1 F4

UN: R\$ 7,53 AV: R\$ 90,38 15: R\$ 92,27
30: R\$ 94,11 45: R\$ 95,99 60: R\$ 97,91



COLA SILICONE LIQUIDA 90 GRS 100ML 12X1
Código: Fábrica: Unidade:
41705 LEO&LEO CX/12
F1 F4

UN: R\$ 7,56 AV: R\$ 45,37 15: R\$ 46,32
30: R\$ 47,24 45: R\$ 48,19 60: R\$ 49,15



COLA SILICONE LIQUIDA 90 GRS 100ML 6X1
Código: Fábrika: Unidade:
50030 BAZZE CX/6
F1 F4

UN: R\$ 1,07 AV: R\$ 12,84 15: R\$ 13,11
30: R\$ 13,37 45: R\$ 13,64 60: R\$ 13,91



COLA SUPER COLA TP SUP BOND 3 GRS 12X1
Código: Fábrika: Unidade:
21631 WINMAX/HAI CR/12
F1 F4

UN: R\$ 3,41 AV: R\$ 3,41 15: R\$ 3,48
30: R\$ 3,55 45: R\$ 3,62 60: R\$ 3,69



COLA TEK BOND INSTAN 2 GRS BLISTER UN
Código: Fábrika: Unidade:
51068 TEK BOND CR/1
F1 F4

UN: R\$ 20,65 AV: R\$ 20,65 15: R\$ 21,08
30: R\$ 21,50 45: R\$ 21,93 60: R\$ 22,37



COLA TRANSP ECOLOGICA 1 KG APLICOLA
Código: Fábrika: Unidade:
45578 APLICOLA UN/1
F1 F4

UN: R\$ 1,78 AV: R\$ 128,40 15: R\$ 131,08
30: R\$ 133,70 45: R\$ 136,37 60: R\$ 139,10



COLA TRANSP ECOLOGICA 40 GRS APLIC 72X1
Código: Fábrika: Unidade:
30111 APLICOLA CX/72
F1 F4

UN: R\$ 2,97 AV: R\$ 142,77 15: R\$ 145,74
30: R\$ 148,66 45: R\$ 151,63 60: R\$ 154,67



COLA TRANSP 90 GRS ECOLOGICA APLIC 48X1
Código: Fábrika: Unidade:
36330 APLICOLA CX/48
F1 F4

UN: R\$ 2,82 AV: R\$ 2,82 15: R\$ 2,88
30: R\$ 2,94 45: R\$ 3,00 60: R\$ 3,06



COLA TRANSPARENTE 37 GRS 19937
Código: Fábrika: Unidade:
21340 ACRILEX UN/1
F1 F4

UN: R\$ 6,12 AV: R\$ 6,12 15: R\$ 6,25
30: R\$ 6,37 45: R\$ 6,50 60: R\$ 6,63



COLA 35 GRS C/GLITTER 102 AMARELO LIMAO
Código: Fábrika: Unidade:
47787 ACRILEX UN/1
F1 F4

UN: R\$ 6,12 AV: R\$ 6,12 15: R\$ 6,25
30: R\$ 6,37 45: R\$ 6,50 60: R\$ 6,63



COLA 35 GRS C/GLITTER 105 LARANJA
Código: Fábrika: Unidade:
47788 ACRILEX UN/1
F1 F4

UN: R\$ 6,12 AV: R\$ 6,12 15: R\$ 6,25
30: R\$ 6,37 45: R\$ 6,50 60: R\$ 6,63



COLA 35 GRS C/GLITTER 201 AMARELO OURO
Código: Fábrika: Unidade:
47789 ACRILEX UN/1
F1 F4

UN: R\$ 6,12 AV: R\$ 6,12 15: R\$ 6,25
30: R\$ 6,37 45: R\$ 6,50 60: R\$ 6,63



COLA 35 GRS C/GLITTER 202 PRATA
Código: Fábrika: Unidade:
47790 ACRILEX UN/1
F1 F4

UN: R\$ 6,12 AV: R\$ 6,12 15: R\$ 6,25
30: R\$ 6,37 45: R\$ 6,50 60: R\$ 6,63



COLA 35 GRS C/GLITTER 204 AZUL
Código: Fábrika: Unidade:
47791 ACRILEX UN/1
F1 F4

UN: R\$ 6,12 AV: R\$ 6,12 15: R\$ 6,25
30: R\$ 6,37 45: R\$ 6,50 60: R\$ 6,63



COLA 35 GRS C/GLITTER 205 VERMELHO
Código: Fábrika: Unidade:
47792 ACRILEX UN/1
F1 F4

UN: R\$ 6,12 AV: R\$ 6,12 15: R\$ 6,25
30: R\$ 6,37 45: R\$ 6,50 60: R\$ 6,63



COLA 35 GRS C/GLITTER 206 VERDE BANDEIRA
Código: Fábrika: Unidade:
47793 ACRILEX UN/1
F1 F4

UN: R\$ 6,12 AV: R\$ 6,12 15: R\$ 6,25
30: R\$ 6,37 45: R\$ 6,50 60: R\$ 6,63



COLA 35 GRS C/GLITTER 207 VIOLETA
Código: Fábrika: Unidade:
47794 ACRILEX UN/1
F1 F4

UN: R\$ 6,12 AV: R\$ 6,12 15: R\$ 6,25
30: R\$ 6,37 45: R\$ 6,50 60: R\$ 6,63



COLA 35 GRS C/GLITTER 209 CRISTAL
Código: Fábrika: Unidade:
47795 ACRILEX UN/1
F1 F4

UN: R\$ 6,12 AV: R\$ 6,12 15: R\$ 6,25
30: R\$ 6,37 45: R\$ 6,50 60: R\$ 6,63



COLA 35 GRS C/GLITER 221 CEU ESTRELADO
Código: Fábrica: Unidade:
47796 ACRILEX UN/1
F1 F4

UN: R\$ 6,12 AV: R\$ 6,12 15: R\$ 6,25
30: R\$ 6,37 45: R\$ 6,50 60: R\$ 6,63



COLA 35 GRS C/GLITER 527 PINK
Código: Fábrica: Unidade:
47797 ACRILEX UN/1
F1 F4

UN: R\$ 6,12 AV: R\$ 6,12 15: R\$ 6,25
30: R\$ 6,37 45: R\$ 6,50 60: R\$ 6,63



COLA 35 GRS C/GLITER 528 LILAS
Código: Fábrica: Unidade:
47798 ACRILEX UN/1
F1 F4

UN: R\$ 0,07 AV: R\$ 5,33 15: R\$ 5,44
30: R\$ 5,55 45: R\$ 5,66 60: R\$ 5,78



COLCHETE LATONADO N02 1,6CM 40FLS 72X1
Código: Fábrica: Unidade:
47228 FIX PAPER CX/72
F1 F4

UN: R\$ 0,08 AV: R\$ 5,43 15: R\$ 5,55
30: R\$ 5,66 45: R\$ 5,77 60: R\$ 5,89



COLCHETE LATONADO N03 1,7CM 60FLS 72X1
Código: Fábrica: Unidade:
47229 FIX PAPER CX/72
F1 F4

UN: R\$ 0,08 AV: R\$ 5,54 15: R\$ 5,65
30: R\$ 5,77 45: R\$ 5,88 60: R\$ 6,00



COLCHETE LATONADO N04 2,2CM 80FLS 72X1
Código: Fábrica: Unidade:
47230 FIX PAPER CX/72
F1 F4

UN: R\$ 0,09 AV: R\$ 6,16 15: R\$ 6,29
30: R\$ 6,42 45: R\$ 6,54 60: R\$ 6,68



COLCHETE LATONADO N05 2,6CM 110FLS 72X1
Código: Fábrica: Unidade:
47231 FIX PAPER CX/72
F1 F4

UN: R\$ 0,10 AV: R\$ 7,08 15: R\$ 7,22
30: R\$ 7,37 45: R\$ 7,52 60: R\$ 7,67



COLCHETE LATONADO N06 2,8CM 120FLS 72X1
Código: Fábrica: Unidade:
47232 FIX PAPER CX/72
F1 F4

UN: R\$ 0,10 AV: R\$ 7,18 15: R\$ 7,33
30: R\$ 7,48 45: R\$ 7,63 60: R\$ 7,78



COLCHETE LATONADO N07 3,2CM 140FLS 72X1
Código: Fábrica: Unidade:
47233 FIX PAPER CX/72
F1 F4

UN: R\$ 0,13 AV: R\$ 9,13 15: R\$ 9,32
30: R\$ 9,51 45: R\$ 9,70 60: R\$ 9,89



COLCHETE LATONADO N08 4CM 180FLS 72X1
Código: Fábrica: Unidade:
47234 FIX PAPER CX/72
F1 F4

UN: R\$ 0,14 AV: R\$ 10,26 15: R\$ 10,48
30: R\$ 10,69 45: R\$ 10,90 60: R\$ 11,12



COLCHETE LATONADO N09 4,5CM 200FLS 72X1
Código: Fábrica: Unidade:
47235 FIX PAPER CX/72
F1 F4

UN: R\$ 0,15 AV: R\$ 10,78 15: R\$ 11,00
30: R\$ 11,22 45: R\$ 11,44 60: R\$ 11,67



COLCHETE LATONADO N10 5CM 210FLS 72X1
Código: Fábrica: Unidade:
47236 FIX PAPER CX/72
F1 F4

UN: R\$ 0,19 AV: R\$ 13,34 15: R\$ 13,62
30: R\$ 13,89 45: R\$ 14,17 60: R\$ 14,46



COLCHETE LATONADO N11 5,5CM 240FLS 72X1
Código: Fábrica: Unidade:
47237 FIX PAPER CX/72
F1 F4

UN: R\$ 0,19 AV: R\$ 13,34 15: R\$ 13,62
30: R\$ 13,89 45: R\$ 14,17 60: R\$ 14,46



COLCHETE LATONADO N12 6CM 270FLS 72X1
Código: Fábrica: Unidade:
47239 FIX PAPER CX/72
F1 F4

UN: R\$ 0,23 AV: R\$ 16,42 15: R\$ 16,77
30: R\$ 17,10 45: R\$ 17,44 60: R\$ 17,79



COLCHETE LATONADO N13 7,5CM 360FLS 72X1
Código: Fábrica: Unidade:
47240 FIX PAPER CX/72
F1 F4

UN: R\$ 0,22 AV: R\$ 16,13 15: R\$ 16,46
30: R\$ 16,79 45: R\$ 17,13 60: R\$ 17,47



COLCHETE LATONADO N14 8,2CM 400FLS 72X1
Código: Fábrica: Unidade:
47241 FIX PAPER CX/72
F1 F4

UN: R\$ 0,29 AV: R\$ 20,53 15: R\$ 20,96
30: R\$ 21,38 45: R\$ 21,81 60: R\$ 22,24



COLCHETE LATONADO N15 10CM 450FLS 72X1
Código: 43718 Fábrica: FIX PAPER Unidade: CX/72 F1 F4

UN: R\$ 0,30 AV: R\$ 21,56 15: R\$ 22,01
30: R\$ 22,45 45: R\$ 22,90 60: R\$ 23,36



COLCHETE LATONADO N17 11CM 455FLS 72X1
Código: 47242 Fábrica: FIX PAPER Unidade: CX/72 F1 F4

UN: R\$ 0,14 AV: R\$ 10,26 15: R\$ 10,48
30: R\$ 10,69 45: R\$ 10,90 60: R\$ 11,12



COLCHETE METAL N07 3,2CM 140 FLS 72X1
Código: 43513 Fábrica: BACCHI Unidade: CX/72 F1 F4

UN: R\$ 0,17 AV: R\$ 12,32 15: R\$ 12,57
30: R\$ 12,82 45: R\$ 13,08 60: R\$ 13,34



COLCHETE METAL N09 4,5CM 200 FLS 72X1
Código: 43515 Fábrica: BACCHI Unidade: CX/72 F1 F4

UN: R\$ 0,26 AV: R\$ 18,48 15: R\$ 18,86
30: R\$ 19,24 45: R\$ 19,63 60: R\$ 20,02



COLCHETE METAL N11 5,5CM 240 FLS 72X1
Código: 43514 Fábrica: BACCHI Unidade: CX/72 F1 F4

UN: R\$ 0,31 AV: R\$ 22,59 15: R\$ 23,06
30: R\$ 23,52 45: R\$ 23,99 60: R\$ 24,47



COLCHETE METAL N13 7,5CM 360 FLS 72X1
Código: 43516 Fábrica: BACCHI Unidade: CX/72 F1 F4

UN: R\$ 9,67 AV: R\$ 116,10 15: R\$ 118,52
30: R\$ 120,89 45: R\$ 123,31 60: R\$ 125,77



COMPASSO JOLLY 12X1
Código: 6889 Fábrica: COMPACTOR Unidade: CX/12 F1 F4

UN: R\$ 12,32 AV: R\$ 12,32 15: R\$ 12,57
30: R\$ 12,82 45: R\$ 13,08 60: R\$ 13,34



COMPASSO METAL C/ESTOJO GRAFITE EXT 7302
Código: 48345 Fábrica: YIN'S PAPER Unidade: UN/1 F1 F4

UN: R\$ 8,94 AV: R\$ 8,94 15: R\$ 9,12
30: R\$ 9,31 45: R\$ 9,49 60: R\$ 9,68



COMPASSO METAL C/ESTOJO 4458
Código: 42599 Fábrica: LEO&LEO Unidade: UN/1 F1 F4

UN: R\$ 19,51 AV: R\$ 19,51 15: R\$ 19,91
30: R\$ 20,31 45: R\$ 20,72 60: R\$ 21,13



COMPASSO PINUS P/GIZCM 2930
Código: 49901 Fábrica: SOUZA Unidade: UN/1 F1 F4

UN: R\$ 22,59 AV: R\$ 22,59 15: R\$ 23,06
30: R\$ 23,52 45: R\$ 23,99 60: R\$ 24,47

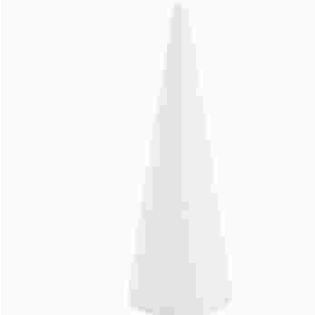

CONE ISOPOR 360X140MM
Código: 30093 Fábrica: ISOMAX Unidade: UN/1 F1 F4

UN: R\$ 0,21 AV: R\$ 2,05 15: R\$ 2,10
30: R\$ 2,14 45: R\$ 2,18 60: R\$ 2,23



CONVITE SIMPLES ANIVERSARIO 10X1
Código: 29839 Fábrica: UNICART Unidade: PT/10 F1 F4

UN: R\$ 0,21 AV: R\$ 2,05 15: R\$ 2,10
30: R\$ 2,14 45: R\$ 2,18 60: R\$ 2,23



CONVITE SIMPLES CHA COZINHA/PANELA 10X1
Código: 5130 Fábrica: UNICART Unidade: PT/10 F1 F4

UN: R\$ 0,21 AV: R\$ 2,05 15: R\$ 2,10
30: R\$ 2,14 45: R\$ 2,18 60: R\$ 2,23



CONVITE SIMPLES CHA DO BEBE AZUL 10X1
Código: 5600 Fábrica: UNICART Unidade: PT/10 F1 F4

UN: R\$ 0,21 AV: R\$ 2,05 15: R\$ 2,10
30: R\$ 2,14 45: R\$ 2,18 60: R\$ 2,23



CONVITE SIMPLES CHA DO BEBE ROSA 10X1
Código: 32365 Fábrica: UNICART Unidade: PT/10 F1 F4

UN: R\$ 0,75 AV: R\$ 4,51 15: R\$ 4,60
30: R\$ 4,70 45: R\$ 4,79 60: R\$ 4,89



CORACAO EVA 8CM GLITER VERMELHO 6X1
Código: 47913 Fábrica: YIN'S PAPER Unidade: PT/6 F1 F4

UN: R\$ 5,34 AV: R\$ 5,34 15: R\$ 5,45
30: R\$ 5,56 45: R\$ 5,67 60: R\$ 5,79



CORACAO 15 GRS MULTICOR

Código: 39436 Fábrica: MINAS BRILHO Unidade: PT/1 F1 F4

UN: R\$ 1,46 AV: R\$ 17,46 15: R\$ 17,83
30: R\$ 18,18 45: R\$ 18,55 60: R\$ 18,92



CORACAO 3 GR MULTICOR 12X1

Código: 15078 Fábrica: MINAS BRILHO Unidade: DZ/12 F1 F4

UN: R\$ 4,10 AV: R\$ 4,10 15: R\$ 4,18
30: R\$ 4,27 45: R\$ 4,35 60: R\$ 4,44



CORANTE LIQ 10 ML ANILINA AMARELO DAM

Código: 50304 Fábrica: MIX Unidade: UN/1 F1 F4

UN: R\$ 4,10 AV: R\$ 4,10 15: R\$ 4,18
30: R\$ 4,27 45: R\$ 4,35 60: R\$ 4,44



CORANTE LIQ 10 ML ANILINA AMARELO GEMA

Código: 50357 Fábrica: MIX Unidade: UN/1 F1 F4

UN: R\$ 4,10 AV: R\$ 4,10 15: R\$ 4,18
30: R\$ 4,27 45: R\$ 4,35 60: R\$ 4,44



CORANTE LIQ 10 ML ANILINA AZUL JEANS

Código: 50301 Fábrica: MIX Unidade: UN/1 F1 F4

UN: R\$ 4,10 AV: R\$ 4,10 15: R\$ 4,18
30: R\$ 4,27 45: R\$ 4,35 60: R\$ 4,44



CORANTE LIQ 10 ML ANILINA BRANCO LEITE

Código: 50358 Fábrica: MIX Unidade: UN/1 F1 F4

UN: R\$ 4,10 AV: R\$ 4,10 15: R\$ 4,18
30: R\$ 4,27 45: R\$ 4,35 60: R\$ 4,44



CORANTE LIQ 10 ML ANILINA LARANJA

Código: 50352 Fábrica: MIX Unidade: UN/1 F1 F4

UN: R\$ 4,10 AV: R\$ 4,10 15: R\$ 4,18
30: R\$ 4,27 45: R\$ 4,35 60: R\$ 4,44



CORANTE LIQ 10 ML ANILINA MARROM CHOCOLA

Código: 50354 Fábrica: MIX Unidade: UN/1 F1 F4

UN: R\$ 4,10 AV: R\$ 4,10 15: R\$ 4,18
30: R\$ 4,27 45: R\$ 4,35 60: R\$ 4,44



CORANTE LIQ 10 ML ANILINA PRETO INTENSO

Código: 50302 Fábrica: MIX Unidade: UN/1 F1 F4

UN: R\$ 4,10 AV: R\$ 4,10 15: R\$ 4,18
30: R\$ 4,27 45: R\$ 4,35 60: R\$ 4,44



CORANTE LIQ 10 ML ANILINA ROSA CEREJA

Código: 50356 Fábrica: MIX Unidade: UN/1 F1 F4

UN: R\$ 4,10 AV: R\$ 4,10 15: R\$ 4,18
30: R\$ 4,27 45: R\$ 4,35 60: R\$ 4,44



CORANTE LIQ 10 ML ANILINA ROSA PINK

Código: 50350 Fábrica: MIX Unidade: UN/1 F1 F4

UN: R\$ 4,10 AV: R\$ 4,10 15: R\$ 4,18
30: R\$ 4,27 45: R\$ 4,35 60: R\$ 4,44



CORANTE LIQ 10 ML ANILINA VERDE FOLHA

Código: 50303 Fábrica: MIX Unidade: UN/1 F1 F4

UN: R\$ 4,10 AV: R\$ 4,10 15: R\$ 4,18
30: R\$ 4,27 45: R\$ 4,35 60: R\$ 4,44



CORANTE LIQ 10 ML ANILINA VERDE HORTELA

Código: 50349 Fábrica: MIX Unidade: UN/1 F1 F4

UN: R\$ 4,10 AV: R\$ 4,10 15: R\$ 4,18
30: R\$ 4,27 45: R\$ 4,35 60: R\$ 4,44



CORANTE LIQ 10 ML ANILINA VERDE LIMAO

Código: 50355 Fábrica: MIX Unidade: UN/1 F1 F4

UN: R\$ 4,10 AV: R\$ 4,10 15: R\$ 4,18
30: R\$ 4,27 45: R\$ 4,35 60: R\$ 4,44



CORANTE LIQ 10 ML ANILINA VERMELHO MORAN

Código: 50305 Fábrica: MIX Unidade: UN/1 F1 F4

UN: R\$ 4,10 AV: R\$ 4,10 15: R\$ 4,18
30: R\$ 4,27 45: R\$ 4,35 60: R\$ 4,44



CORANTE LIQ 10 ML ANILINA VERMELHO NATAL

Código: 50353 Fábrica: MIX Unidade: UN/1 F1 F4

UN: R\$ 4,10 AV: R\$ 4,10 15: R\$ 4,18
30: R\$ 4,27 45: R\$ 4,35 60: R\$ 4,44



CORANTE LIQ 10 ML ANILINA VINHO BORDO
Código: 50351 Fábrica: MIX Unidade: UN/1 F1 F4

UN: R\$ 2,57 AV: R\$ 25,67 15: R\$ 26,20
30: R\$ 26,73 45: R\$ 27,26 60: R\$ 27,81



CORDAO P/CRACHA C/JACARE 40CM AZUL 10X1
Código: 45601 Fábrica: KAZ Unidade: PT/10 F1 F4

UN: R\$ 2,56 AV: R\$ 25,58 15: R\$ 26,11
30: R\$ 26,63 45: R\$ 27,17 60: R\$ 27,71



CORDAO P/CRACHA C/JACARE 40CM PRETO 10X1
Código: 45602 Fábrica: KAZ Unidade: PT/10 F1 F4

UN: R\$ 3,59 AV: R\$ 35,94 15: R\$ 36,69
30: R\$ 37,42 45: R\$ 38,17 60: R\$ 38,94



CORDAO P/CRACHA C/JACARE 40CM VERDE 10X1
Código: 45603 Fábrica: DAC Unidade: PT/10 F1 F4

UN: R\$ 2,70 AV: R\$ 32,36 15: R\$ 33,03
30: R\$ 33,69 45: R\$ 34,37 60: R\$ 35,05



CORRETIVO LIQUIDO REFIX 18 ML 12X1
Código: 49503 Fábrica: TRIS Unidade: DZ/12 F1 F4

UN: R\$ 2,87 AV: R\$ 2,87 15: R\$ 2,93
30: R\$ 2,98 45: R\$ 3,04 60: R\$ 3,10



CORRETIVO LIQUIDO 18 ML UN
Código: 42298 Fábrica: NEW MAGIC EC Unidade: UN/1 F1 F4

UN: R\$ 3,08 AV: R\$ 36,97 15: R\$ 37,74
30: R\$ 38,49 45: R\$ 39,26 60: R\$ 40,05



CORRETIVO LIQUIDO 18 ML 12X1
Código: 3348 Fábrica: NEW MAGIC Unidade: DZ/12 F1 F4

UN: R\$ 0,45 AV: R\$ 45,17 15: R\$ 46,11
30: R\$ 47,03 45: R\$ 47,97 60: R\$ 48,93



CRACHA BH-05 9,3X6,7CM 100X1
Código: 41787 Fábrica: MP Unidade: CE/100 F1 F4

UN: R\$ 0,47 AV: R\$ 47,25 15: R\$ 48,24
30: R\$ 49,20 45: R\$ 50,18 60: R\$ 51,19



CRACHA HORIZ AB LAT 7X10CM C-9 100X1
Código: 46175 Fábrica: ACP Unidade: PT/100 F1 F4

UN: R\$ 0,47 AV: R\$ 47,25 15: R\$ 48,24
30: R\$ 49,20 45: R\$ 50,18 60: R\$ 51,19



CRACHA HORIZ AB SUP 7X10CM C-9/S 100X1
Código: 46172 Fábrica: ACP Unidade: CE/100 F1 F4

UN: R\$ 1,69 AV: R\$ 168,77 15: R\$ 172,29
30: R\$ 175,73 45: R\$ 179,25 60: R\$ 182,83



CRACHA HORIZ C/PRESILIN 7X10CM C-7 100X1
Código: 46204 Fábrica: ACP Unidade: CE/100 F1 F4

UN: R\$ 1,26 AV: R\$ 12,58 15: R\$ 12,85
30: R\$ 13,10 45: R\$ 13,36 60: R\$ 13,63

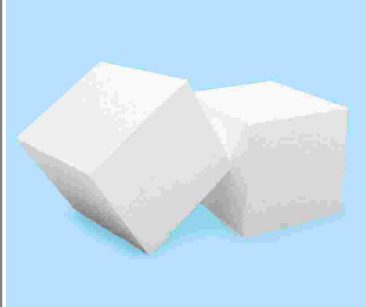

CUBO ISOPOR 100X100X100MM 10X1
Código: 30094 Fábrica: ISOMAX Unidade: PT/10 F1 F4

UN: R\$ 0,82 AV: R\$ 8,22 15: R\$ 8,39
30: R\$ 8,56 45: R\$ 8,73 60: R\$ 8,90

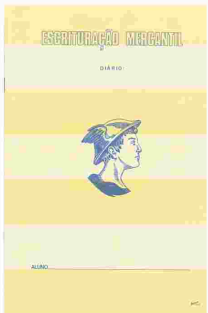

DIARIO DE ESCRITURACAO MERCANTIL 10X1
Código: 28916 Fábrica: GRAMULI Unidade: PT/10 F1 F4

UN: R\$ 4,61 AV: R\$ 4,61 15: R\$ 4,71
30: R\$ 4,80 45: R\$ 4,90 60: R\$ 5,00



DICIONARIO MINI ESPANHOL 101
Código: 42686 Fábrica: CULTURAMA Unidade: UN/1 F1 F4

UN: R\$ 6,15 AV: R\$ 6,15 15: R\$ 6,28
30: R\$ 6,41 45: R\$ 6,53 60: R\$ 6,67

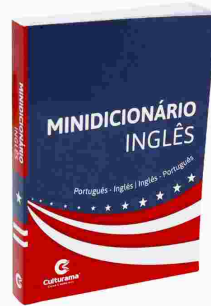

DICIONARIO MINI INGLES 102
Código: 42687 Fábrica: CULTURAMA Unidade: UN/1 F1 F4

UN: R\$ 4,10 AV: R\$ 4,10 15: R\$ 4,18
30: R\$ 4,27 45: R\$ 4,35 60: R\$ 4,44

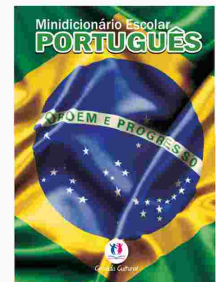

DICIONARIO MINI PORTUGUES JORNAL
Código: 33425 Fábrica: CIRANDACULT Unidade: UN/1 F1 F4

UN: R\$ 2,35 AV: R\$ 2,35 15: R\$ 2,40
30: R\$ 2,45 45: R\$ 2,50 60: R\$ 2,55



DICIONARIO MINI PORTUGUES JORNAL
Código: Fábrica: Unidade:
12962 CIRANDA CULT UN/1
F1 F4

UN: R\$ 6,15 AV: R\$ 6,15 15: R\$ 6,28
30: R\$ 6,41 45: R\$ 6,53 60: R\$ 6,67

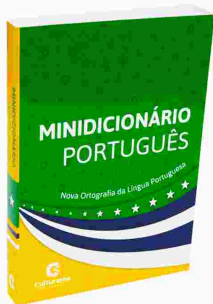

DICIONARIO MINI PORTUGUES 103
Código: Fábrica: Unidade:
42688 CULTURAMA UN/1
F1 F4

UN: R\$ 5,95 AV: R\$ 5,95 15: R\$ 6,07
30: R\$ 6,19 45: R\$ 6,32 60: R\$ 6,44



DICIONARIO MINI SCOTTINI ESPANHOL
Código: Fábrica: Unidade:
48484 TODOLIVRO UN/1
F1 F4

UN: R\$ 5,95 AV: R\$ 5,95 15: R\$ 6,07
30: R\$ 6,19 45: R\$ 6,32 60: R\$ 6,44



DICIONARIO MINI SCOTTINI INGLES
Código: Fábrica: Unidade:
30919 TODOLIVRO UN/1
F1 F4

UN: R\$ 5,95 AV: R\$ 5,95 15: R\$ 6,07
30: R\$ 6,19 45: R\$ 6,32 60: R\$ 6,44



DICIONARIO MINI SCOTTINI PORTUGUES
Código: Fábrica: Unidade:
30918 TODOLIVRO UN/1
F1 F4

UN: R\$ 8,47 AV: R\$ 8,47 15: R\$ 8,65
30: R\$ 8,82 45: R\$ 9,00 60: R\$ 9,18



DILUENTE P/TINTA TECIDO 60 ML 19360 UN
Código: Fábrica: Unidade:
44983 ACRILEX UN/1
F1 F4

UN: R\$ 22,98 AV: R\$ 22,98 15: R\$ 23,46
30: R\$ 23,92 45: R\$ 24,40 60: R\$ 24,89



DISPLAY FRONTAL A4 31X23X0,3CM 10090013
Código: Fábrica: Unidade:
44677 MAXCRIL UN/1
F1 F4

UN: R\$ 5,79 AV: R\$ 5,79 15: R\$ 5,91
30: R\$ 6,03 45: R\$ 6,15 60: R\$ 6,28



DIVISORIA P/ FICHARIO 12 MATERIAS 855
Código: Fábrica: Unidade:
19469 ACP UN/1
F1 F4

UN: R\$ 1,75 AV: R\$ 87,31 15: R\$ 89,13
30: R\$ 90,91 45: R\$ 92,73 60: R\$ 94,59



DVD-R GRAVAVEL 120 MIN 4,7 GB 50X1
Código: Fábrica: Unidade:
14632 MAKETECH PT/50
F1 F4

UN: R\$ 41,34 AV: R\$ 41,34 15: R\$ 42,21
30: R\$ 43,05 45: R\$ 43,91 60: R\$ 44,79



ELASTICO P/DINH N18 (GOMINHA) KG 1200X1
Código: Fábrica: Unidade:
28031 RED BOR PT/1
F1 F4

UN: R\$ 5,54 AV: R\$ 5,54 15: R\$ 5,65
30: R\$ 5,77 45: R\$ 5,88 60: R\$ 6,00



ELASTICO P/DINH N18 (GOMINHA) 100G 120X1
Código: Fábrica: Unidade:
13142 PREMIER/MAMU PT/1
F1 F4

UN: R\$ 5,43 AV: R\$ 5,43 15: R\$ 5,55
30: R\$ 5,66 45: R\$ 5,77 60: R\$ 5,89



ELASTICO P/DINH N18 (GOMINHA) 100X1
Código: Fábrica: Unidade:
41228 PREMIER PT/1
F1 F4

UN: R\$ 10,26 AV: R\$ 10,26 15: R\$ 10,48
30: R\$ 10,69 45: R\$ 10,90 60: R\$ 11,12



ELASTICO P/DINH N18 (GOMINHA) 200X1
Código: Fábrica: Unidade:
41226 MERCUR PT/1
F1 F4

UN: R\$ 2,23 AV: R\$ 2,23 15: R\$ 2,28
30: R\$ 2,32 45: R\$ 2,37 60: R\$ 2,41



ELASTICO P/DINH N18 (GOMINHA) 25G 30X1
Código: Fábrica: Unidade:
28030 PREMIER CX/1
F1 F4

UN: R\$ 13,34 AV: R\$ 13,34 15: R\$ 13,62
30: R\$ 13,89 45: R\$ 14,17 60: R\$ 14,46



ELASTICO P/DINH N18 (GOMINHA) 250G 300X1
Código: Fábrica: Unidade:
49144 PREMIER PT/1
F1 F4

UN: R\$ 3,67 AV: R\$ 3,67 15: R\$ 3,74
30: R\$ 3,82 45: R\$ 3,89 60: R\$ 3,97



ELASTICO P/DINH N18 (GOMINHA) 50G 60X1
Código: Fábrica: Unidade:
22488 PREMIER PT/1
F1 F4

UN: R\$ 22,59 AV: R\$ 22,59 15: R\$ 23,06
30: R\$ 23,52 45: R\$ 23,99 60: R\$ 24,47



ELASTICO P/DINH N18 (GOMINHA)500G 600X1
Código: 35961 Fábrica: PREMIER Unidade: PT/1 F1 F4

UN: R\$ 35,94 AV: R\$ 35,94 15: R\$ 36,69
30: R\$ 37,42 45: R\$ 38,17 60: R\$ 38,94

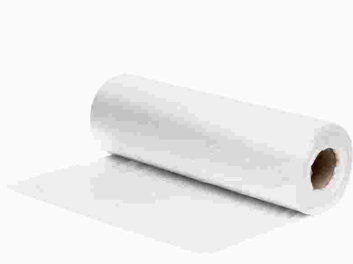

EMBALAGEM PLAST BOBINA 25CM KG
Código: 46254 Fábrica: ACP Unidade: KG/1 F1 F4

UN: R\$ 0,38 AV: R\$ 95,52 15: R\$ 97,51
30: R\$ 99,46 45: R\$ 101,45 60: R\$ 103,48

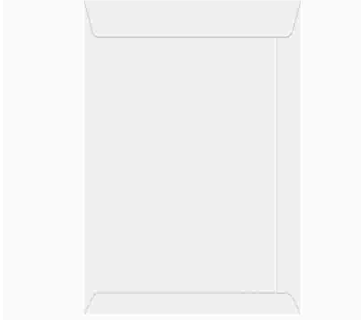

ENVELOPE BRANCO SACO 176X250MM O25 250X1
Código: 28126 Fábrica: REIPEL Unidade: CX/250 F1 F4

UN: R\$ 0,72 AV: R\$ 71,89 15: R\$ 73,39
30: R\$ 74,86 45: R\$ 76,36 60: R\$ 77,88



ENVELOPE BRANCO SACO 176X250MM 725 100X1
Código: 19602 Fábrica: SCRITY Unidade: CX/100 F1 F4

UN: R\$ 0,45 AV: R\$ 112,98 15: R\$ 115,34
30: R\$ 117,64 45: R\$ 120,00 60: R\$ 122,40

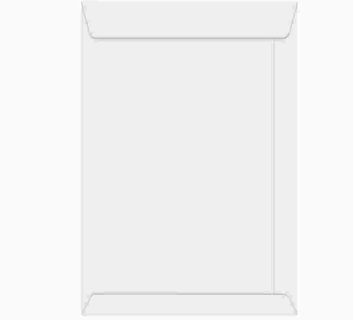

ENVELOPE BRANCO SACO 200X280MM O28 250X1
Código: 12189 Fábrica: REIPEL Unidade: CX/250 F1 F4

UN: R\$ 0,53 AV: R\$ 133,53 15: R\$ 136,31
30: R\$ 139,03 45: R\$ 141,81 60: R\$ 144,65

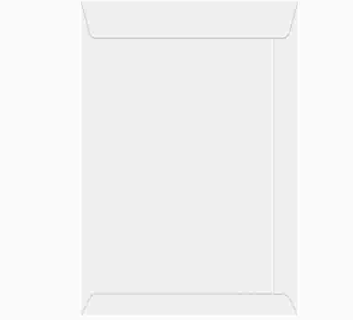

ENVELOPE BRANCO SACO 229X324MM O32 250X1
Código: 28127 Fábrica: REIPEL/SCRIT Unidade: CX/250 F1 F4

UN: R\$ 0,62 AV: R\$ 61,62 15: R\$ 62,91
30: R\$ 64,16 45: R\$ 65,45 60: R\$ 66,76



ENVELOPE BRANCO SACO 229X324MM 732 100X1
Código: 27863 Fábrica: SCRITY Unidade: CX/100 F1 F4

UN: R\$ 0,62 AV: R\$ 154,07 15: R\$ 157,28
30: R\$ 160,43 45: R\$ 163,63 60: R\$ 166,91

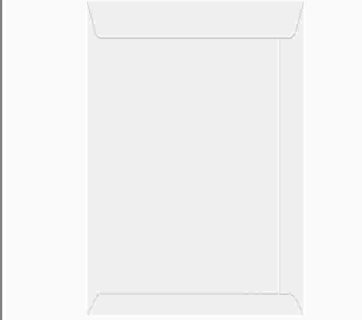

ENVELOPE BRANCO SACO 240X340MM O34 250X1
Código: 28128 Fábrica: REIPEL/SCRIT Unidade: CX/250 F1 F4

UN: R\$ 0,72 AV: R\$ 71,89 15: R\$ 73,39
30: R\$ 74,86 45: R\$ 76,36 60: R\$ 77,88



ENVELOPE BRANCO SACO 240X340MM 734 100X1
Código: 28125 Fábrica: SCRITY Unidade: CX/100 F1 F4

UN: R\$ 0,74 AV: R\$ 184,89 15: R\$ 188,74
30: R\$ 192,51 45: R\$ 196,36 60: R\$ 200,29

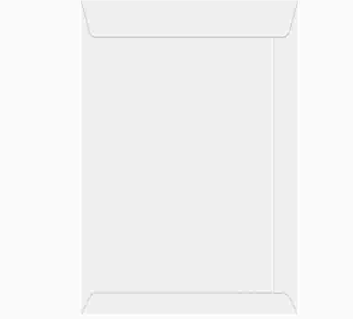

ENVELOPE BRANCO SACO 260X360MM O36 250X1
Código: 46598 Fábrica: REIPEL Unidade: CX/250 F1 F4

UN: R\$ 0,82 AV: R\$ 82,17 15: R\$ 83,88
30: R\$ 85,56 45: R\$ 87,27 60: R\$ 89,01



ENVELOPE BRANCO SACO 260X360MM 100X1
Código: 46918 Fábrica: SCRITY Unidade: CX/100 F1 F4

UN: R\$ 1,03 AV: R\$ 102,71 15: R\$ 104,85
30: R\$ 106,95 45: R\$ 109,09 60: R\$ 111,27



ENVELOPE BRANCO SACO 310X410MM 100X1
Código: 50623 Fábrica: REIPEL Unidade: CX/100 F1 F4

UN: R\$ 0,24 AV: R\$ 23,62 15: R\$ 24,11
30: R\$ 24,59 45: R\$ 25,08 60: R\$ 25,58



ENVELOPE BRANCO 121X190MM 100X1
Código: 50630 Fábrica: REIPEL Unidade: CX/100 F1 F4

UN: R\$ 0,82 AV: R\$ 82,17 15: R\$ 83,88
30: R\$ 85,56 45: R\$ 87,27 60: R\$ 89,01



ENVELOPE COM 110X162MM AZUL BAHAMA 100X1
Código: 45240 Fábrica: AGAPE Unidade: CE/100 F1 F4

UN: R\$ 0,82 AV: R\$ 82,17 15: R\$ 83,88
30: R\$ 85,56 45: R\$ 87,27 60: R\$ 89,01



ENVELOPE COM 110X162MM AZUL GRECIA 100X1
Código: 45238 Fábrica: AGAPE Unidade: CE/100 F1 F4

UN: R\$ 0,82 AV: R\$ 82,17 15: R\$ 83,88
30: R\$ 85,56 45: R\$ 87,27 60: R\$ 89,01

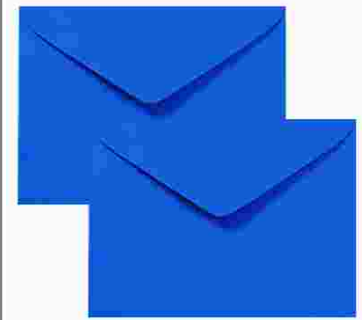

ENVELOPE COM 110X162MM AZUL GRECIA 100X1
Código: 35303 Fábrica: AGAPE Unidade: CE/100 F1 F4

UN: R\$ 0,82 AV: R\$ 82,17 15: R\$ 83,88
30: R\$ 85,56 45: R\$ 87,27 60: R\$ 89,01

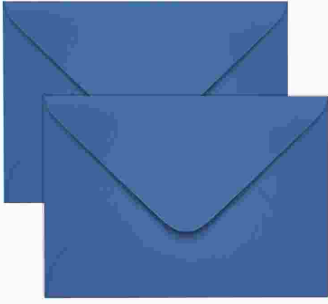

ENVELOPE COM 110X162MM AZUL P SEGU 100X1
Código: Fábriça: Unidade:
45239 AGAPE CE/100
F1 F4

UN: R\$ 0,82 AV: R\$ 82,17 15: R\$ 83,88
30: R\$ 85,56 45: R\$ 87,27 60: R\$ 89,01



ENVELOPE COM 110X162MM LARANJ CART 100X1
Código: Fábriça: Unidade:
45245 AGAPE CE/100
F1 F4

UN: R\$ 0,82 AV: R\$ 82,17 15: R\$ 83,88
30: R\$ 85,56 45: R\$ 87,27 60: R\$ 89,01

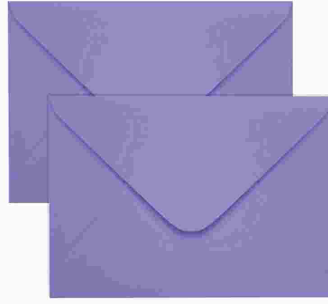

ENVELOPE COM 110X162MM LILAS AMSTE 100X1
Código: Fábriça: Unidade:
45250 AGAPE CE/100
F1 F4

UN: R\$ 0,82 AV: R\$ 82,17 15: R\$ 83,88
30: R\$ 85,56 45: R\$ 87,27 60: R\$ 89,01



ENVELOPE COM 110X162MM PRETO LOS A 100X1
Código: Fábriça: Unidade:
45242 AGAPE CE/100
F1 F4

UN: R\$ 0,82 AV: R\$ 41,08 15: R\$ 41,93
30: R\$ 42,77 45: R\$ 43,63 60: R\$ 44,50

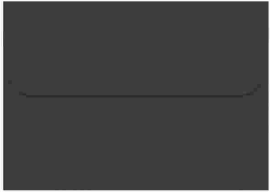

ENVELOPE COM 110X162MM PRETO 50X1
Código: Fábriça: Unidade:
35881 AGAPE PT/50
F1 F4

UN: R\$ 0,82 AV: R\$ 82,17 15: R\$ 83,88
30: R\$ 85,56 45: R\$ 87,27 60: R\$ 89,01

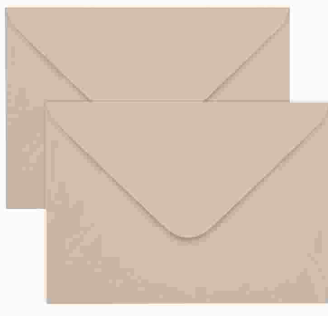

ENVELOPE COM 110X162MM RECICLADO 100X1
Código: Fábriça: Unidade:
45249 AGAPE CE/100
F1 F4

UN: R\$ 0,82 AV: R\$ 82,17 15: R\$ 83,88
30: R\$ 85,56 45: R\$ 87,27 60: R\$ 89,01



ENVELOPE COM 110X162MM ROSA CHICLE 100X1
Código: Fábriça: Unidade:
45247 AGAPE CE/100
F1 F4

UN: R\$ 0,82 AV: R\$ 41,08 15: R\$ 41,93
30: R\$ 42,77 45: R\$ 43,63 60: R\$ 44,50



ENVELOPE COM 110X162MM ROSA 50X1
Código: Fábriça: Unidade:
35883 AGAPE PT/50
F1 F4

UN: R\$ 0,82 AV: R\$ 82,17 15: R\$ 83,88
30: R\$ 85,56 45: R\$ 87,27 60: R\$ 89,01

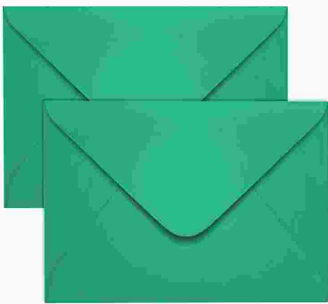

ENVELOPE COM 110X162MM VERDE BRASI 100X1
Código: Fábriça: Unidade:
45246 AGAPE CE/100
F1 F4

UN: R\$ 0,82 AV: R\$ 82,17 15: R\$ 83,88
30: R\$ 85,56 45: R\$ 87,27 60: R\$ 89,01



ENVELOPE COM 110X162MM VERMELH TOQ 100X1
Código: Fábriça: Unidade:
14398 AGAPE CE/100
F1 F4

UN: R\$ 0,20 AV: R\$ 19,51 15: R\$ 19,91
30: R\$ 20,31 45: R\$ 20,72 60: R\$ 21,13

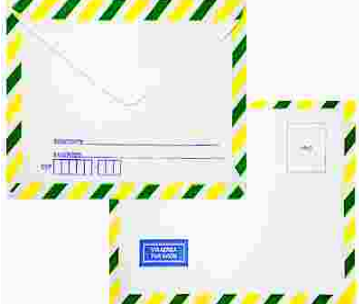

ENVELOPE COM 114X162MM AEREO 015 100X1
Código: Fábriça: Unidade:
498 SCRITY CE/100
F1 F4

UN: R\$ 0,82 AV: R\$ 82,17 15: R\$ 83,88
30: R\$ 85,56 45: R\$ 87,27 60: R\$ 89,01

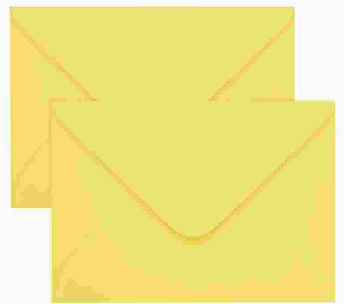

ENVELOPE COM 114X162MM AMARELO RIO 100X1
Código: Fábriça: Unidade:
45241 AGAPE CE/100
F1 F4

UN: R\$ 0,82 AV: R\$ 82,17 15: R\$ 83,88
30: R\$ 85,56 45: R\$ 87,27 60: R\$ 89,01



ENVELOPE COM 114X162MM AZUL GRECIA 100X1
Código: Fábriça: Unidade:
15932 SCRITY CE/100
F1 F4

UN: R\$ 0,82 AV: R\$ 82,17 15: R\$ 83,88
30: R\$ 85,56 45: R\$ 87,27 60: R\$ 89,01

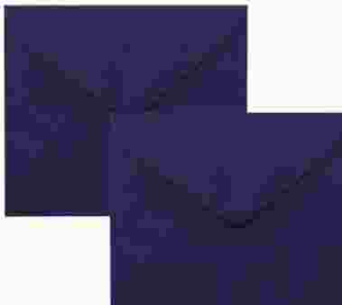

ENVELOPE COM 114X162MM AZUL P SEG 100X1
Código: Fábriça: Unidade:
14397 SCRITY CE/100
F1 F4

UN: R\$ 0,82 AV: R\$ 41,08 15: R\$ 41,93
30: R\$ 42,77 45: R\$ 43,63 60: R\$ 44,50



ENVELOPE COM 114X162MM AZUL P SEGUR 50X1
Código: Fábriça: Unidade:
35884 AGAPE PT/50
F1 F4

UN: R\$ 0,16 AV: R\$ 164,34 15: R\$ 167,77
30: R\$ 171,12 45: R\$ 174,54 60: R\$ 178,03

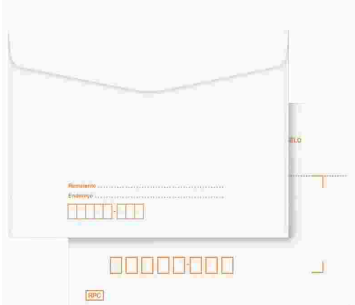

ENVELOPE COM 114X162MM BCO C/CEP 1000X1
Código: Fábriça: Unidade:
37408 SCRITY CX/1000
F1 F4

UN: R\$ 0,17 AV: R\$ 17,45 15: R\$ 17,82
30: R\$ 18,17 45: R\$ 18,54 60: R\$ 18,91



ENVELOPE COM 114X162MM BCO S/CEP 100X1

Código: 2299 Fábrica: SCRITY Unidade: CE/100
F1 F4

UN: R\$ 0,16 AV: R\$ 164,34 15: R\$ 167,77
30: R\$ 171,12 45: R\$ 174,54 60: R\$ 178,03



ENVELOPE COM 114X162MM BCO S/CEP 1000X1

Código: 14396 Fábrica: REIPEL/SCRITY Unidade: CX/1000
F1 F4

UN: R\$ 0,82 AV: R\$ 82,17 15: R\$ 83,88
30: R\$ 85,56 45: R\$ 87,27 60: R\$ 89,01

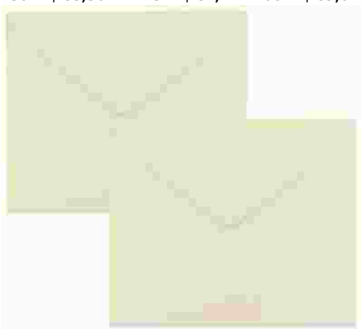

ENVELOPE COM 114X162MM CREM MARFIM 100X1

Código: 9136 Fábrica: SCRITY Unidade: CE/100
F1 F4

UN: R\$ 0,82 AV: R\$ 82,17 15: R\$ 83,88
30: R\$ 85,56 45: R\$ 87,27 60: R\$ 89,01



ENVELOPE COM 114X162MM CREME 100X1

Código: 45248 Fábrica: AGAPE Unidade: CE/100
F1 F4

UN: R\$ 0,82 AV: R\$ 82,17 15: R\$ 83,88
30: R\$ 85,56 45: R\$ 87,27 60: R\$ 89,01



ENVELOPE COM 114X162MM LARANJA CAR 100X1

Código: 14399 Fábrica: SCRITY Unidade: CE/100
F1 F4

UN: R\$ 0,82 AV: R\$ 41,08 15: R\$ 41,93
30: R\$ 42,77 45: R\$ 43,63 60: R\$ 44,50



ENVELOPE COM 114X162MM LILAS 50X1

Código: 35882 Fábrica: AGAPE Unidade: PT/50
F1 F4

UN: R\$ 0,24 AV: R\$ 236,25 15: R\$ 241,17
30: R\$ 245,99 45: R\$ 250,91 60: R\$ 255,93

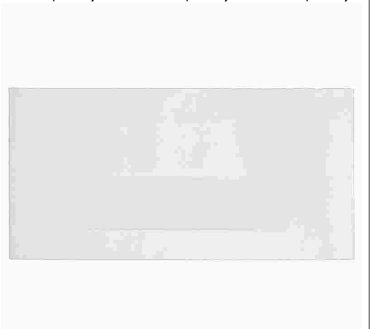

ENVELOPE COM 114X162MM OFIC JANEL 1000X1

Código: 45059 Fábrica: CELUCAT Unidade: CX/1000
F1 F4

UN: R\$ 0,82 AV: R\$ 82,17 15: R\$ 83,88
30: R\$ 85,56 45: R\$ 87,27 60: R\$ 89,01



ENVELOPE COM 114X162MM PRETO LOS 100X1

Código: 43813 Fábrica: SCRITY Unidade: CE/100
F1 F4

UN: R\$ 82,17 AV: R\$ 82,17 15: R\$ 83,88
30: R\$ 85,56 45: R\$ 87,27 60: R\$ 89,01

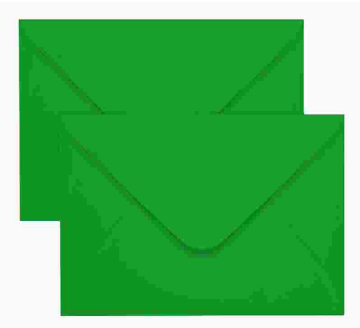

ENVELOPE COM 114X162MM VERDE BRASI 100X1

Código: 44180 Fábrica: SCRITY Unidade: PT/1
F1 F4

UN: R\$ 0,82 AV: R\$ 82,17 15: R\$ 83,88
30: R\$ 85,56 45: R\$ 87,27 60: R\$ 89,01

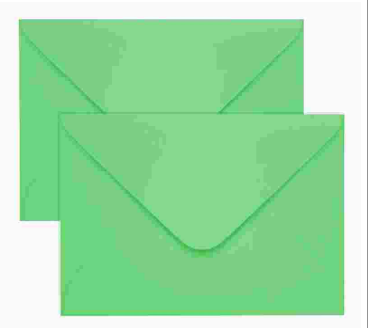

ENVELOPE COM 114X162MM VERDE BUENO 100X1

Código: 45243 Fábrica: AGAPE Unidade: CE/100
F1 F4

UN: R\$ 0,82 AV: R\$ 82,17 15: R\$ 83,88
30: R\$ 85,56 45: R\$ 87,27 60: R\$ 89,01

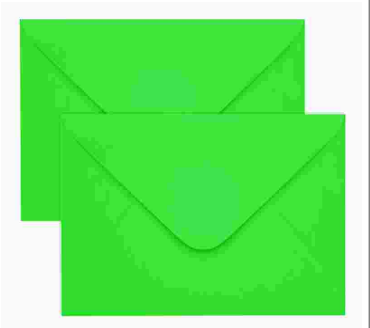

ENVELOPE COM 114X162MM VERDE NEON 100X1

Código: 45244 Fábrica: AGAPE Unidade: CE/100
F1 F4

UN: R\$ 0,22 AV: R\$ 21,56 15: R\$ 22,01
30: R\$ 22,45 45: R\$ 22,90 60: R\$ 23,36

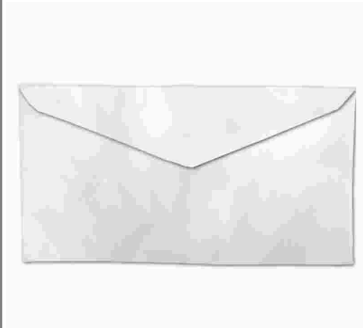

ENVELOPE COM 114X229MM OFICIO 020 100X1

Código: 7135 Fábrica: SCRITY Unidade: CE/100
F1 F4

UN: R\$ 0,19 AV: R\$ 188,49 15: R\$ 192,42
30: R\$ 196,27 45: R\$ 200,19 60: R\$ 204,20

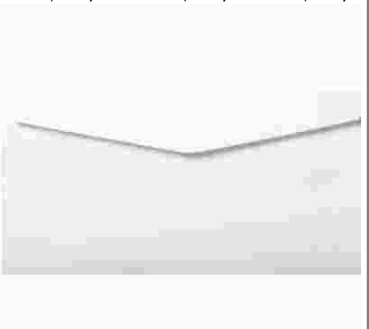

ENVELOPE COM 114X229MM OFICIO 020 1000X1

Código: 20438 Fábrica: REIPEL/SCRIT Unidade: CX/1000
F1 F4

UN: R\$ 1,03 AV: R\$ 51,35 15: R\$ 52,42
30: R\$ 53,47 45: R\$ 54,54 60: R\$ 55,63

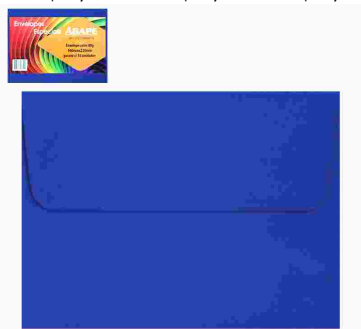

ENVELOPE CONV AZUL ESC 160X220MM 50X1

Código: 35891 Fábrica: AGAPE Unidade: PT/50
F1 F4

UN: R\$ 1,23 AV: R\$ 61,62 15: R\$ 62,91
30: R\$ 64,16 45: R\$ 65,45 60: R\$ 66,76



ENVELOPE CONV CINZ METAL 163X225MM 50X1

Código: 35591 Fábrica: ROMITEC Unidade: C//50
F1 F4

UN: R\$ 1,03 AV: R\$ 51,35 15: R\$ 52,42
30: R\$ 53,47 45: R\$ 54,54 60: R\$ 55,63

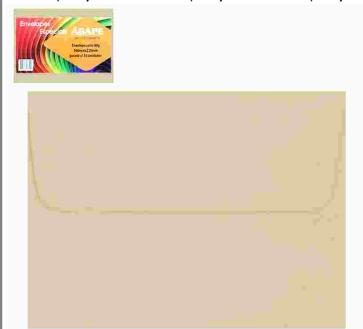

ENVELOPE CONV CREME 160X220MM 50X1

Código: 41547 Fábrica: AGAPE Unidade: PT/50
F1 F4

UN: R\$ 1,03 AV: R\$ 102,71 15: R\$ 104,85
30: R\$ 106,95 45: R\$ 109,09 60: R\$ 111,27



ENVELOPE CONV LILAS AMST 160X235MM 100X1

Código: 43822 Fábrica: SCRITY Unidade: CE/100
F1 F4

UN: R\$ 1,03 AV: R\$ 51,35 15: R\$ 52,42
30: R\$ 53,47 45: R\$ 54,54 60: R\$ 55,63



ENVELOPE CONV LILAS 160X220MM 50X1

Código: 35890 Fábrica: AGAPE Unidade: PT/50
F1 F4

UN: R\$ 1,03 AV: R\$ 51,35 15: R\$ 52,42
30: R\$ 53,47 45: R\$ 54,54 60: R\$ 55,63



ENVELOPE CONV MARFIM 160X220MM 50X1

Código: 35892 Fábrica: AGAPE Unidade: PT/50
F1 F4

UN: R\$ 1,03 AV: R\$ 102,71 15: R\$ 104,85
30: R\$ 106,95 45: R\$ 109,09 60: R\$ 111,27



ENVELOPE CONV MARFIM 160X235MM 100X1

Código: 43825 Fábrica: SCRITY Unidade: CE/100
F1 F4

UN: R\$ 1,23 AV: R\$ 61,62 15: R\$ 62,91
30: R\$ 64,16 45: R\$ 65,45 60: R\$ 66,76



ENVELOPE CONV PINK 163X225MM 50X1 3230

Código: 35589 Fábrica: ROMITEC Unidade: C//50
F1 F4

UN: R\$ 1,03 AV: R\$ 51,35 15: R\$ 52,42
30: R\$ 53,47 45: R\$ 54,54 60: R\$ 55,63



ENVELOPE CONV PRETO 160X220MM 50X1

Código: 35887 Fábrica: AGAPE Unidade: PT/50
F1 F4

UN: R\$ 1,03 AV: R\$ 102,71 15: R\$ 104,85
30: R\$ 106,95 45: R\$ 109,09 60: R\$ 111,27

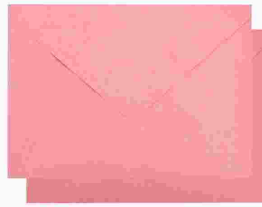

ENVELOPE CONV ROSA FIDJI 160X235MM 100X1

Código: 43820 Fábrica: SCRITY Unidade: CE/100
F1 F4

UN: R\$ 1,23 AV: R\$ 61,62 15: R\$ 62,91
30: R\$ 64,16 45: R\$ 65,45 60: R\$ 66,76



ENVELOPE CONV ROSA METAL 163X225MM 50X1

Código: 35590 Fábrica: ROMITEC Unidade: C//50
F1 F4

UN: R\$ 1,03 AV: R\$ 51,35 15: R\$ 52,42
30: R\$ 53,47 45: R\$ 54,54 60: R\$ 55,63



ENVELOPE CONV ROSA 160X220MM 50X1

Código: 35886 Fábrica: AGAPE Unidade: PT/50
F1 F4

UN: R\$ 1,03 AV: R\$ 102,71 15: R\$ 104,85
30: R\$ 106,95 45: R\$ 109,09 60: R\$ 111,27



ENVELOPE CONV ROXO 163X225MM 100X1

Código: 35592 Fábrica: ROMITEC Unidade: C//100
F1 F4

UN: R\$ 1,03 AV: R\$ 102,71 15: R\$ 104,85
30: R\$ 106,95 45: R\$ 109,09 60: R\$ 111,27



ENVELOPE CONV VERD BRASI 160X235MM 100X1

Código: 43821 Fábrica: SCRITY Unidade: CE/100
F1 F4

UN: R\$ 1,03 AV: R\$ 51,35 15: R\$ 52,42
30: R\$ 53,47 45: R\$ 54,54 60: R\$ 55,63



ENVELOPE CONV VERDE BAND 160X220MM 50X1

Código: 35888 Fábrica: AGAPE Unidade: PT/50
F1 F4

UN: R\$ 1,03 AV: R\$ 102,71 15: R\$ 104,85
30: R\$ 106,95 45: R\$ 109,09 60: R\$ 111,27



ENVELOPE CONV VERM TOQUI 160X235MM 100X1

Código: 43823 Fábrica: SCRITY Unidade: CE/100
F1 F4

UN: R\$ 1,03 AV: R\$ 51,35 15: R\$ 52,42
30: R\$ 53,47 45: R\$ 54,54 60: R\$ 55,63



ENVELOPE CONV VERMELHO 160X220MM 50X1

Código: 35889 Fábrica: AGAPE Unidade: PT/50
F1 F4

UN: R\$ 0,29 AV: R\$ 28,75 15: R\$ 29,35
30: R\$ 29,94 45: R\$ 30,54 60: R\$ 31,15



ENVELOPE KRAFT SACO 110X170MM 100X1

Código: 50629 Fábrica: REIPEL Unidade: CX/100
F1 F4

UN: R\$ 0,27 AV: R\$ 66,76 15: R\$ 68,15
30: R\$ 69,51 45: R\$ 70,90 60: R\$ 72,32



ENVELOPE KRAFT SACO 110X170MM KN17 250X1

Código: 15929 Fábrica: SCRITY Unidade: CX/250
F1 F4

UN: R\$ 0,25 AV: R\$ 61,62 15: R\$ 62,91
30: R\$ 64,16 45: R\$ 65,45 60: R\$ 66,76



ENVELOPE KRAFT SACO 125X176MM KN18 250X1
Código: 29999 Fábrica: SCRITY Unidade: CX/250
F1 F4

UN: R\$ 0,33 AV: R\$ 82,17 15: R\$ 83,88
30: R\$ 85,56 45: R\$ 87,27 60: R\$ 89,01



ENVELOPE KRAFT SACO 162X229MM KN23 250X1
Código: 47016 Fábrica: REIPEL Unidade: CX/250
F1 F4

UN: R\$ 0,37 AV: R\$ 92,44 15: R\$ 94,36
30: R\$ 96,25 45: R\$ 98,18 60: R\$ 100,14



ENVELOPE KRAFT SACO 176X250MM KN18 250X1
Código: 9124 Fábrica: SCRITY Unidade: CX/250
F1 F4

UN: R\$ 0,41 AV: R\$ 41,08 15: R\$ 41,93
30: R\$ 42,77 45: R\$ 43,63 60: R\$ 44,50



ENVELOPE KRAFT SACO 176X250MM 325 100X1
Código: 12188 Fábrica: SCRITY Unidade: CX/100
F1 F4

UN: R\$ 0,39 AV: R\$ 98,60 15: R\$ 100,66
30: R\$ 102,67 45: R\$ 104,72 60: R\$ 106,82



ENVELOPE KRAFT SACO 200X280MM KN28 250X1
Código: 26698 Fábrica: SCRITY Unidade: CX/250
F1 F4

UN: R\$ 0,51 AV: R\$ 51,35 15: R\$ 52,42
30: R\$ 53,47 45: R\$ 54,54 60: R\$ 55,63



ENVELOPE KRAFT SACO 200X280MM 353 100X1
Código: 19796 Fábrica: SCRITY Unidade: CX/100
F1 F4

UN: R\$ 0,41 AV: R\$ 205,43 15: R\$ 209,71
30: R\$ 213,90 45: R\$ 218,18 60: R\$ 222,55



ENVELOPE KRAFT SACO 200X280MM 38 500X1
Código: 45056 Fábrica: CELUCAT Unidade: CX/500
F1 F4

UN: R\$ 0,40 AV: R\$ 99,95 15: R\$ 99,95
30: R\$ 99,95 45: R\$ 99,95 60: R\$ 99,95



ENVELOPE KRAFT SACO 229X324MM KN32 250X1
Código: 23223 Fábrica: SCRITY Unidade: CX/250
F1 F4

UN: R\$ 0,51 AV: R\$ 51,35 15: R\$ 52,42
30: R\$ 53,47 45: R\$ 54,54 60: R\$ 55,63



ENVELOPE KRAFT SACO 229X324MM 332 100X1
Código: 9128 Fábrica: CELUCAT/SCRITY Unidade: CX/100
F1 F4

UN: R\$ 0,51 AV: R\$ 127,36 15: R\$ 130,02
30: R\$ 132,62 45: R\$ 135,27 60: R\$ 137,97



ENVELOPE KRAFT SACO 240X340MM KN34 250X1
Código: 8469 Fábrica: SCRITY Unidade: CX/250
F1 F4

UN: R\$ 0,53 AV: R\$ 133,53 15: R\$ 136,31
30: R\$ 139,03 45: R\$ 141,81 60: R\$ 144,65



ENVELOPE KRAFT SACO 250X353MM KN35 250X1
Código: 6044 Fábrica: REIPEL/SCRITY Unidade: CX/250
F1 F4

UN: R\$ 0,58 AV: R\$ 143,80 15: R\$ 146,79
30: R\$ 149,73 45: R\$ 152,72 60: R\$ 155,78



ENVELOPE KRAFT SACO 260X360MM KN36 250X1
Código: 42635 Fábrica: REIPEL Unidade: CX/250
F1 F4

UN: R\$ 0,58 AV: R\$ 143,80 15: R\$ 146,79
30: R\$ 149,73 45: R\$ 152,72 60: R\$ 155,78



ENVELOPE KRAFT SACO 260X360MM KN36 250X1
Código: 19031 Fábrica: SCRITY Unidade: CX/250
F1 F4

UN: R\$ 0,74 AV: R\$ 184,89 15: R\$ 188,74
30: R\$ 192,51 45: R\$ 196,36 60: R\$ 200,29



ENVELOPE KRAFT SACO 310X410MM KN41 250X1
Código: 42626 Fábrica: REIPEL/CELUC Unidade: CX/250
F1 F4

UN: R\$ 1,03 AV: R\$ 102,71 15: R\$ 104,85
30: R\$ 106,95 45: R\$ 109,09 60: R\$ 111,27



ENVELOPE KRAFT SACO 310X410MM 341 100X1
Código: 42073 Fábrica: SCRITY Unidade: CX/100
F1 F4

UN: R\$ 1,44 AV: R\$ 143,80 15: R\$ 146,79
30: R\$ 149,73 45: R\$ 152,72 60: R\$ 155,78



ENVELOPE KRAFT SACO 370X470MM 347 100X1
Código: 44179 Fábrica: SCRITY/CELUC Unidade: CX/100
F1 F4

UN: R\$ 0,31 AV: R\$ 30,81 15: R\$ 31,45
30: R\$ 32,08 45: R\$ 32,72 60: R\$ 33,37



ENVELOPE OURO SACO 110X170MM 100X1
Código: Fábrica: Unidade:
50628 REIPEL CX/100
F1 F4

UN: R\$ 41,08 AV: R\$ 41,08 15: R\$ 41,93
30: R\$ 42,77 45: R\$ 43,63 60: R\$ 44,50



ENVELOPE OURO SACO 162X229MM KO 100X1
Código: Fábrica: Unidade:
50625 REIPEL PT/1
F1 F4

UN: R\$ 0,37 AV: R\$ 92,44 15: R\$ 94,36
30: R\$ 96,25 45: R\$ 98,18 60: R\$ 100,14

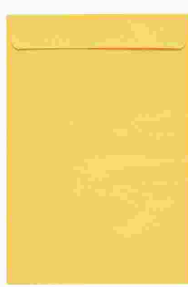

ENVELOPE OURO SACO 162X229MM KO23 250X1
Código: Fábrica: Unidade:
47616 REIPEL CX/250
F1 F4

UN: R\$ 0,50 AV: R\$ 50,32 15: R\$ 51,37
30: R\$ 52,40 45: R\$ 53,45 60: R\$ 54,52



ENVELOPE OURO SACO 185X248MM 100X1
Código: Fábrica: Unidade:
50624 REIPEL CX/100
F1 F4

UN: R\$ 0,62 AV: R\$ 154,07 15: R\$ 157,28
30: R\$ 160,43 45: R\$ 163,63 60: R\$ 166,91



ENVELOPE OURO SACO 240X340MM KO34 250X1
Código: Fábrica: Unidade:
47595 REIPEL CX/250
F1 F4

UN: R\$ 0,41 AV: R\$ 41,08 15: R\$ 41,93
30: R\$ 42,77 45: R\$ 43,63 60: R\$ 44,50



ENVELOPE VIS 80GR AMAR RJ 72X108MM 100X1
Código: Fábrica: Unidade:
12192 SCRITY CE/100
F1 F4

UN: R\$ 0,41 AV: R\$ 41,08 15: R\$ 41,93
30: R\$ 42,77 45: R\$ 43,63 60: R\$ 44,50



ENVELOPE VIS 80GR AMARELO 75X115MM 100X1
Código: Fábrica: Unidade:
9137 AGAPE CE/100
F1 F4

UN: R\$ 0,41 AV: R\$ 41,08 15: R\$ 41,93
30: R\$ 42,77 45: R\$ 43,63 60: R\$ 44,50



ENVELOPE VIS 80GR AZUL BA 72X108MM 100X1
Código: Fábrica: Unidade:
43827 SCRITY CE/100
F1 F4

UN: R\$ 0,41 AV: R\$ 20,53 15: R\$ 20,96
30: R\$ 21,38 45: R\$ 21,81 60: R\$ 22,24



ENVELOPE VIS 80GR AZUL ESC 75X115MM 50X1
Código: Fábrica: Unidade:
44667 AGAPE PT/50
F1 F4

UN: R\$ 0,41 AV: R\$ 41,08 15: R\$ 41,93
30: R\$ 42,77 45: R\$ 43,63 60: R\$ 44,50



ENVELOPE VIS 80GR AZUL GR 72X108MM 100X1
Código: Fábrica: Unidade:
43826 SCRITY CE/100
F1 F4

UN: R\$ 0,41 AV: R\$ 41,08 15: R\$ 41,93
30: R\$ 42,77 45: R\$ 43,63 60: R\$ 44,50



ENVELOPE VIS 80GR AZUL 75X115MM 100X1
Código: Fábrica: Unidade:
12191 AGAPE CE/100
F1 F4

UN: R\$ 0,41 AV: R\$ 41,08 15: R\$ 41,93
30: R\$ 42,77 45: R\$ 43,63 60: R\$ 44,50



ENVELOPE VIS 80GR BEGE 78X115MM 100X1
Código: Fábrica: Unidade:
12190 AGAPE CE/100
F1 F4

UN: R\$ 0,41 AV: R\$ 20,53 15: R\$ 20,96
30: R\$ 21,38 45: R\$ 21,81 60: R\$ 22,24



ENVELOPE VIS 80GR LILAS 75X115MM 50X1
Código: Fábrica: Unidade:
35879 AGAPE PT/50
F1 F4

UN: R\$ 0,41 AV: R\$ 41,08 15: R\$ 41,93
30: R\$ 42,77 45: R\$ 43,63 60: R\$ 44,50



ENVELOPE VIS 80GR MARFIM 72X108MM 100X1
Código: Fábrica: Unidade:
43829 SCRITY CE/100
F1 F4

UN: R\$ 0,41 AV: R\$ 41,08 15: R\$ 41,93
30: R\$ 42,77 45: R\$ 43,63 60: R\$ 44,50



ENVELOPE VIS 80GR PRETO L 72X108MM 100X1
Código: Fábrica: Unidade:
43830 SCRITY CE/100
F1 F4

UN: R\$ 0,41 AV: R\$ 20,53 15: R\$ 20,96
30: R\$ 21,38 45: R\$ 21,81 60: R\$ 22,24



ENVELOPE VIS 80GR PRETO 75X115MM 50X1
Código: Fábrica: Unidade:
35880 AGAPE PT/50
F1 F4

UN: R\$ 0,41 AV: R\$ 41,08 15: R\$ 41,93
30: R\$ 42,77 45: R\$ 43,63 60: R\$ 44,50



ENVELOPE VIS 80GR ROSA CA 72X108MM 100X1

Código: 12193 Fábrica: SCRITY Unidade: CE/100 F1 F4

UN: R\$ 0,41 AV: R\$ 41,08 15: R\$ 41,93
30: R\$ 42,77 45: R\$ 43,63 60: R\$ 44,50



ENVELOPE VIS 80GR ROSA CL 78X115MM 100X1

Código: 14400 Fábrica: AGAPE Unidade: CE/100 F1 F4

UN: R\$ 0,41 AV: R\$ 41,08 15: R\$ 41,93
30: R\$ 42,77 45: R\$ 43,63 60: R\$ 44,50



ENVELOPE VIS 80GR ROSA FI 72X108MM 100X1

Código: 43831 Fábrica: SCRITY Unidade: CE/100 F1 F4

UN: R\$ 0,41 AV: R\$ 41,08 15: R\$ 41,93
30: R\$ 42,77 45: R\$ 43,63 60: R\$ 44,50



ENVELOPE VIS 80GR ROSA 75X115MM 100X1

Código: 9139 Fábrica: AGAPE Unidade: CE/100 F1 F4

UN: R\$ 0,41 AV: R\$ 20,53 15: R\$ 20,96
30: R\$ 21,38 45: R\$ 21,81 60: R\$ 22,24



ENVELOPE VIS 80GR ROSA 75X115MM 50X1

Código: 35878 Fábrica: AGAPE Unidade: PT/50 F1 F4

UN: R\$ 0,41 AV: R\$ 41,08 15: R\$ 41,93
30: R\$ 42,77 45: R\$ 43,63 60: R\$ 44,50



ENVELOPE VIS 80GR VERDE T 72X108MM 100X1

Código: 43828 Fábrica: SCRITY Unidade: CE/100 F1 F4

UN: R\$ 0,41 AV: R\$ 41,08 15: R\$ 41,93
30: R\$ 42,77 45: R\$ 43,63 60: R\$ 44,50

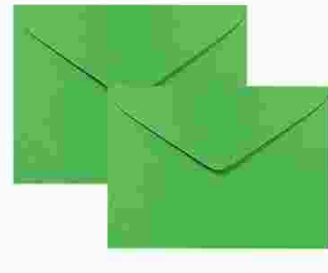

ENVELOPE VIS 80GR VERDE 75X115MM 100X1

Código: 35304 Fábrica: AGAPE Unidade: CE/100 F1 F4

UN: R\$ 0,41 AV: R\$ 41,08 15: R\$ 41,93
30: R\$ 42,77 45: R\$ 43,63 60: R\$ 44,50



ENVELOPE VIS 80GR VERM T 72X108MM 100X1

Código: 29596 Fábrica: SCRITY Unidade: CE/100 F1 F4

UN: R\$ 36,97 AV: R\$ 36,97 15: R\$ 37,74
30: R\$ 38,49 45: R\$ 39,26 60: R\$ 40,05
1 30cm

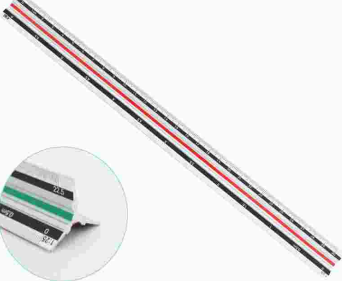

ESCALIMETRO 30CM METAL 2008

Código: 46743 Fábrica: KAZ Unidade: UN/1 F1 F4

UN: R\$ 29,28 AV: R\$ 29,28 15: R\$ 29,89
30: R\$ 30,48 45: R\$ 31,09 60: R\$ 31,71
1 30cm



ESCALIMETRO 30CM PLAST 970107

Código: 46745 Fábrica: KAZ Unidade: UN/1 F1 F4

UN: R\$ 12,99 AV: R\$ 12,99 15: R\$ 13,26
30: R\$ 13,53 45: R\$ 13,80 60: R\$ 14,08
1 16,4 cm

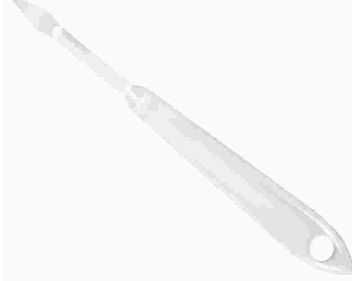

ESPATULA PLAST ARTIST PINTURA 16,4CM 548

Código: 45492 Fábrica: CONDOR Unidade: UN/1 F1 F4

UN: R\$ 13,11 AV: R\$ 13,11 15: R\$ 13,38
30: R\$ 13,65 45: R\$ 13,92 60: R\$ 14,20
1 17,2 cm

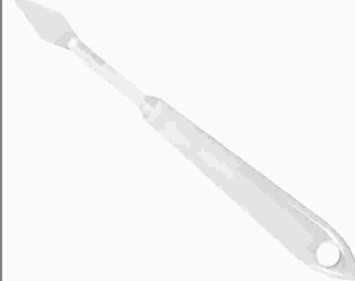

ESPATULA PLAST ARTIST PINTURA 17,2CM 541

Código: 45495 Fábrica: CONDOR Unidade: UN/1 F1 F4

UN: R\$ 13,11 AV: R\$ 13,11 15: R\$ 13,38
30: R\$ 13,65 45: R\$ 13,92 60: R\$ 14,20
1 18 cm



ESPATULA PLAST ARTIST PINTURA 18CM 543

Código: 45494 Fábrica: CONDOR Unidade: UN/1 F1 F4

UN: R\$ 15,40 AV: R\$ 15,40 15: R\$ 15,72
30: R\$ 16,03 45: R\$ 16,35 60: R\$ 16,68
1 21 cm

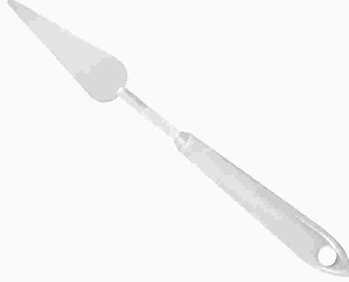

ESPATULA PLAST ARTIST PINTURA 21CM 545

Código: 45493 Fábrica: CONDOR Unidade: UN/1 F1 F4

UN: R\$ 3,41 AV: R\$ 3,41 15: R\$ 3,48
30: R\$ 3,55 45: R\$ 3,62 60: R\$ 3,69



ESPATULA PLAST 14CM 992 86314

Código: 45485 Fábrica: CONDOR Unidade: UN/1 F1 F4

UN: R\$ 18,50 AV: R\$ 92,49 15: R\$ 94,42
30: R\$ 96,31 45: R\$ 98,24 60: R\$ 100,20
1 30 cm
2 26 cm

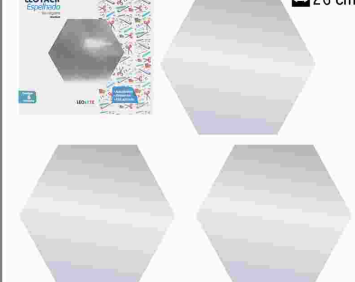

ESPELHADO AUTOADES HEXAGONOS 30X26CM 6X1

Código: 39820 Fábrica: LEO&LEO Unidade: PT/5 F1 F4

UN: R\$ 0,47 AV: R\$ 47,02 15: R\$ 48,00
30: R\$ 48,96 45: R\$ 49,94 60: R\$ 50,94

12mm
70 folhas

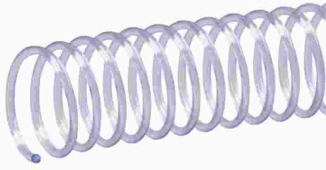

ESPIRAL CRIS 12MM 70 FLS P/ ENCADERNACAO

Código: **8999** Fábrica: **AFORPLASTIC** Unidade: **PT/100**
F1 F4

UN: R\$ 0,76 AV: R\$ 76,42 15: R\$ 78,01
30: R\$ 79,57 45: R\$ 81,16 60: R\$ 82,78

17mm
100 folhas

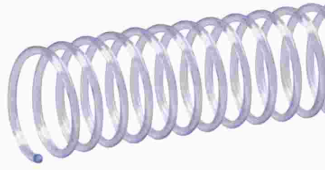

ESPIRAL CRIS 17MM 100 FLS P/ ENCAD 100X1

Código: **9001** Fábrica: **AFORPLASTIC** Unidade: **PT/100**
F1 F4

UN: R\$ 1,01 AV: R\$ 70,54 15: R\$ 72,01
30: R\$ 73,45 45: R\$ 74,92 60: R\$ 76,41

20mm
120 folhas

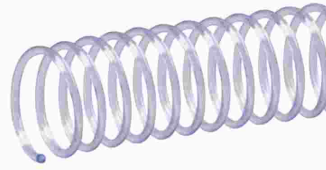

ESPIRAL CRIS 20MM 120 FLS P/ ENCADERNACA

Código: **9002** Fábrica: **AFROPLASTIC** Unidade: **PT/70**
F1 F4

UN: R\$ 4,41 AV: R\$ 70,54 15: R\$ 72,01
30: R\$ 73,45 45: R\$ 74,92 60: R\$ 76,41

45mm
450 folhas

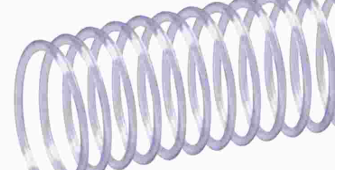

ESPIRAL CRIS 45MM 450 FLS P/ ENCADERNACA

Código: **9008** Fábrica: **AFORPLASTIC** Unidade: **PT/16**
F1 F4

UN: R\$ 0,22 AV: R\$ 22,09 15: R\$ 22,55
30: R\$ 23,01 45: R\$ 23,47 60: R\$ 23,93

07mm

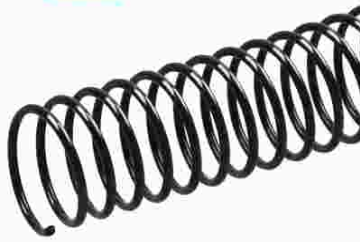

ESPIRAL PTO 07 MM 25 FLS P/ ENCAD 100X1

Código: **8980** Fábrica: **AFORPLASTIC** Unidade: **PT/100**
F1 F4

UN: R\$ 0,32 AV: R\$ 31,74 15: R\$ 32,40
30: R\$ 33,04 45: R\$ 33,71 60: R\$ 34,38

09 mm

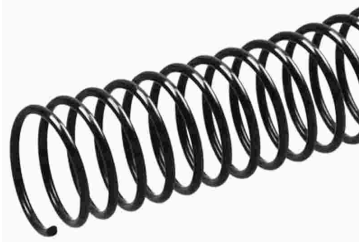

ESPIRAL PTO 09 MM 50 FLS P/ ENCAD 100X1

Código: **8981** Fábrica: **AFORPLASTIC** Unidade: **PT/100**
F1 F4

UN: R\$ 0,41 AV: R\$ 41,14 15: R\$ 42,00
30: R\$ 42,84 45: R\$ 43,70 60: R\$ 44,57

12 mm

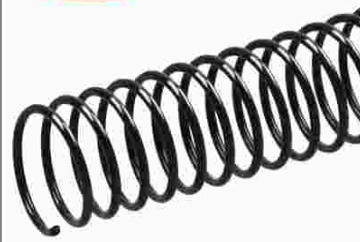

ESPIRAL PTO 12 MM 70 FLS P/ ENCAD 100X1

Código: **8982** Fábrica: **AFORPLASTIC** Unidade: **PT/100**
F1 F4

UN: R\$ 0,47 AV: R\$ 47,02 15: R\$ 48,00
30: R\$ 48,96 45: R\$ 49,94 60: R\$ 50,94



ESPIRAL PTO 14 MM 85 FLS P/ ENCAD 100X1

Código: **8983** Fábrica: **AFORPLASTIC** Unidade: **PT/100**
F1 F4

UN: R\$ 0,59 AV: R\$ 58,78 15: R\$ 60,00
30: R\$ 61,20 45: R\$ 62,43 60: R\$ 63,68

17mm

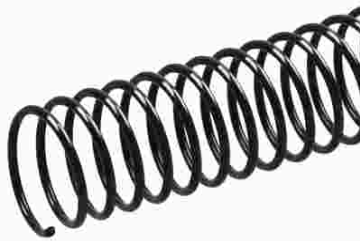

ESPIRAL PTO 17 MM 100 FLS P/ ENCAD 100X1

Código: **8984** Fábrica: **AFORPLASTIC** Unidade: **PT/100**
F1 F4

UN: R\$ 0,73 AV: R\$ 58,78 15: R\$ 60,00
30: R\$ 61,20 45: R\$ 62,43 60: R\$ 63,68



ESPIRAL PTO 20 MM 120 FLS P/ ENCAD 80X1

Código: **8985** Fábrica: **AFORPLASTIC** Unidade: **PT/80**
F1 F4

UN: R\$ 0,98 AV: R\$ 58,78 15: R\$ 60,00
30: R\$ 61,20 45: R\$ 62,43 60: R\$ 63,68

23mm

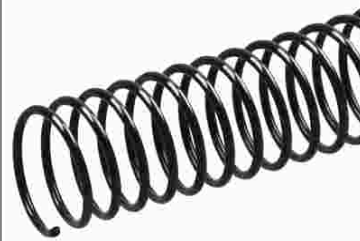

ESPIRAL PTO 23 MM 140 FLS P/ ENCAD 60X1

Código: **8986** Fábrica: **AFORPLASTIC** Unidade: **PT/60**
F1 F4

UN: R\$ 1,22 AV: R\$ 58,78 15: R\$ 60,00
30: R\$ 61,20 45: R\$ 62,43 60: R\$ 63,68



ESPIRAL PTO 25 MM 160 FLS P/ ENCAD 48X1

Código: **8987** Fábrica: **AFORPLASTIC** Unidade: **PT/48**
F1 F4

UN: R\$ 1,80 AV: R\$ 64,66 15: R\$ 66,01
30: R\$ 67,33 45: R\$ 68,67 60: R\$ 70,05

29mm

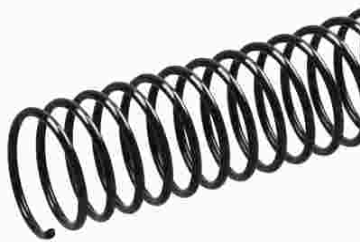

ESPIRAL PTO 29 MM 200 FLS P/ ENCAD 36X1

Código: **8988** Fábrica: **AFORPLASTIC** Unidade: **PT/36**
F1 F4

UN: R\$ 2,18 AV: R\$ 58,78 15: R\$ 60,00
30: R\$ 61,20 45: R\$ 62,43 60: R\$ 63,68

33mm

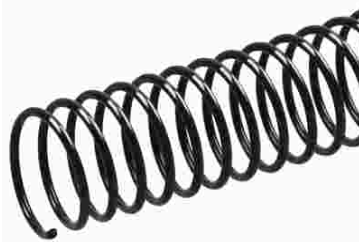

ESPIRAL PTO 33 MM 300 FLS P/ ENCAD 27X1

Código: **8989** Fábrica: **AFORPLASTIC** Unidade: **PT/27**
F1 F4

UN: R\$ 3,27 AV: R\$ 58,78 15: R\$ 60,00
30: R\$ 61,20 45: R\$ 62,43 60: R\$ 63,68

40mm

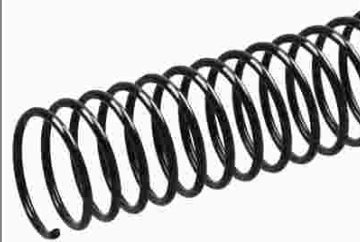

ESPIRAL PTO 40 MM 400 FLS P/ ENCAD 18X1

Código: **8990** Fábrica: **AFORPLASTIC** Unidade: **PT/18**
F1 F4

UN: R\$ 3,92 AV: R\$ 58,78 15: R\$ 60,00
30: R\$ 61,20 45: R\$ 62,43 60: R\$ 63,68

45mm

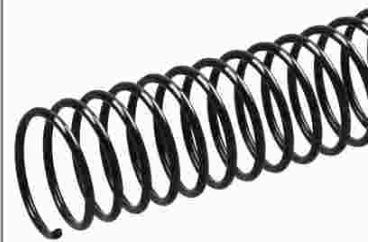

ESPIRAL PTO 45 MM 450 FLS P/ ENCAD 15X1

Código: **8992** Fábrica: **AFORPLASTIC** Unidade: **PT/15**
F1 F4

UN: R\$ 4,90 AV: R\$ 58,78 15: R\$ 60,00
30: R\$ 61,20 45: R\$ 62,43 60: R\$ 63,68



ESPIRAL PTO 50 MM 500 FLS P/ ENCAD 12X1
Código: Fábrika: Unidade:
8994 AFORPLASTIC PT/12
F1 F4

UN: R\$ 20,53 AV: R\$ 20,53 15: R\$ 20,96
30: R\$ 21,38 45: R\$ 21,81 60: R\$ 22,24

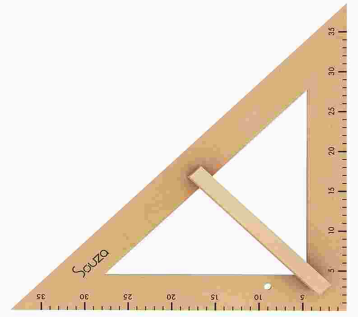

ESQUADRO MDF 45 GRAUS 2934
Código: Fábrika: Unidade:
49903 SOUZA UN/1
F1 F4

UN: R\$ 20,53 AV: R\$ 20,53 15: R\$ 20,96
30: R\$ 21,38 45: R\$ 21,81 60: R\$ 22,24

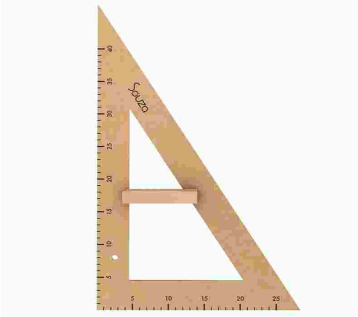

ESQUADRO MDF 60 GRAUS 2936
Código: Fábrika: Unidade:
49902 SOUZA UN/1
F1 F4

UN: R\$ 0,17 AV: R\$ 1,74 15: R\$ 1,77
30: R\$ 1,81 45: R\$ 1,84 60: R\$ 1,88

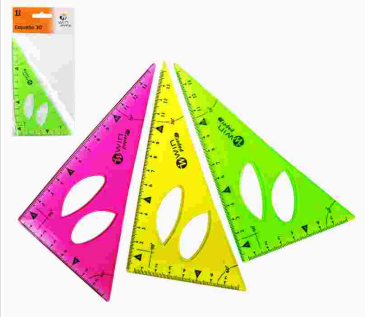

ESQUADRO 30° FLEXIVEL COLOR 218
Código: Fábrika: Unidade:
44742 WIN PAPER PT/10
F1 F4

UN: R\$ 1,44 AV: R\$ 14,37 15: R\$ 14,67
30: R\$ 14,96 45: R\$ 15,26 60: R\$ 15,57

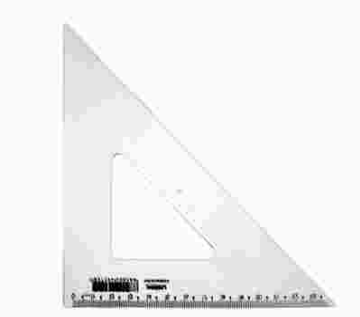

ESQUADRO 45 GRAUS 10X1
Código: Fábrika: Unidade:
10110 WALEU PT/10
F1 F4

UN: R\$ 1,45 AV: R\$ 14,53 15: R\$ 14,84
30: R\$ 15,13 45: R\$ 15,44 60: R\$ 15,75

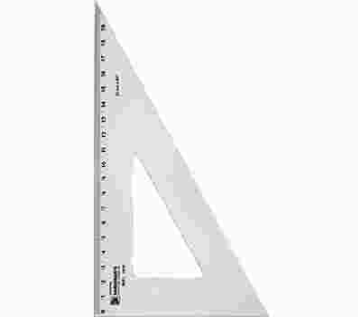

ESQUADRO 60 GRAUS 10X1
Código: Fábrika: Unidade:
23662 WALEU PT/10
F1 F4

UN: R\$ 7,18 AV: R\$ 7,18 15: R\$ 7,33
30: R\$ 7,48 45: R\$ 7,63 60: R\$ 7,78



ESTECAS KIT P/ESCUPIR 7640 8X1
Código: Fábrika: Unidade:
47937 YIN'S PAPER KI/1
F1 F4

UN: R\$ 44,16 AV: R\$ 44,16 15: R\$ 45,08
30: R\$ 45,98 45: R\$ 46,90 60: R\$ 47,84



ESTILETE CORTADOR CIRCUL MANUAL EVA 45MM
Código: Fábrika: Unidade:
48729 LEO&LEO CR/1
F1 F4

UN: R\$ 2,14 AV: R\$ 25,67 15: R\$ 26,20
30: R\$ 26,73 45: R\$ 27,26 60: R\$ 27,81



ESTILETE ESTREITO 9MM COLOR 12X1
Código: Fábrika: Unidade:
39908 FUTURO DZ/12
F1 F4

UN: R\$ 1,24 AV: R\$ 29,78 15: R\$ 30,40
30: R\$ 31,01 45: R\$ 31,63 60: R\$ 32,26



ESTILETE ESTREITO 9MM COLOR 450 24X1
Código: Fábrika: Unidade:
6768 MASTERPRINT CX/24
F1 F4

UN: R\$ 1,54 AV: R\$ 18,48 15: R\$ 18,86
30: R\$ 19,24 45: R\$ 19,63 60: R\$ 20,02



ESTILETE ESTREITO 9MM COLOR 91410 12X1
Código: Fábrika: Unidade:
50666 LEOARTE DZ/12
F1 F4

UN: R\$ 7,80 AV: R\$ 7,80 15: R\$ 7,96
30: R\$ 8,12 45: R\$ 8,28 60: R\$ 8,45



ESTILETE ESTREITO 9MM PLAST EMBOR 91419
Código: Fábrika: Unidade:
42603 JOCAROFFICE UN/1
F1 F4

UN: R\$ 7,69 AV: R\$ 7,69 15: R\$ 7,85
30: R\$ 8,01 45: R\$ 8,17 60: R\$ 8,33



ESTILETE ESTREITO 10MM PLAST EMBOR 5434
Código: Fábrika: Unidade:
43281 MAGAGIFT UN/1
F1 F4

UN: R\$ 9,23 AV: R\$ 9,23 15: R\$ 9,43
30: R\$ 9,62 45: R\$ 9,81 60: R\$ 10,00



ESTILETE LARGO 18MM CB EMBORR CTL 900517
Código: Fábrika: Unidade:
48320 BAZZE CR/1
F1 F4

UN: R\$ 13,86 AV: R\$ 13,86 15: R\$ 14,15
30: R\$ 14,43 45: R\$ 14,72 60: R\$ 15,01



ESTILETE LARGO 18MM CB EMBORRA CTL 1804
Código: Fábrika: Unidade:
23642 BRW UN/1
F1 F4

UN: R\$ 1,71 AV: R\$ 20,53 15: R\$ 20,96
30: R\$ 21,38 45: R\$ 21,81 60: R\$ 22,24



ESTILETE LARGO 18MM COLOR CTL 12X1
Código: Fábrika: Unidade:
44810 FBG DZ/12
F1 F4

UN: R\$ 3,85 AV: R\$ 46,21 15: R\$ 47,18
30: R\$ 48,12 45: R\$ 49,08 60: R\$ 50,06



ESTILETE LARGO 18MM COLOR NA CX 12X1
Código: Fábriça: Unidade:
19317 FUTURO DZ/12
F1 F4

UN: R\$ 22,59 AV: R\$ 22,59 15: R\$ 23,06
30: R\$ 23,52 45: R\$ 23,99 60: R\$ 24,47



ESTILETE LARGO 18MM METAL EMBORR 91421
Código: Fábriça: Unidade:
42592 LEO&LEO UN/1
F1 F4

UN: R\$ 11,01 AV: R\$ 11,01 15: R\$ 11,24
30: R\$ 11,47 45: R\$ 11,70 60: R\$ 11,93



ESTILETE LARGO 18MM PLAST C/5LAMINAS
Código: Fábriça: Unidade:
46746 KAZ CT/1
F1 F4

UN: R\$ 10,78 AV: R\$ 10,78 15: R\$ 11,00
30: R\$ 11,22 45: R\$ 11,44 60: R\$ 11,67



ESTILETE LARGO 18MM PLAST TR GIRAT 1883
Código: Fábriça: Unidade:
46432 KAZ CT/1
F1 F4

UN: R\$ 2,10 AV: R\$ 2,10 15: R\$ 2,14
30: R\$ 2,18 45: R\$ 2,23 60: R\$ 2,27



ESTOJO ESCOLAR LATA CILINDRICO C/APONT 6
Código: Fábriça: Unidade:
15288 ALFA RIO UN/1
F1 F4

UN: R\$ 8,03 AV: R\$ 96,33 15: R\$ 98,34
30: R\$ 100,30 45: R\$ 102,31 60: R\$ 104,36



ESTOJO PLAST MULTIUSO COLOR 190 12X1
Código: Fábriça: Unidade:
37678 MAMITA PT/12
F1 F4

UN: R\$ 0,83 AV: R\$ 10,02 15: R\$ 10,22
30: R\$ 10,43 45: R\$ 10,64 60: R\$ 10,85



ESTRELINHA 2,3 GR C/FURO COLOR 12X1
Código: Fábriça: Unidade:
46910 GLITTER VMP CT/12
F1 F4

UN: R\$ 0,98 AV: R\$ 11,81 15: R\$ 12,06
30: R\$ 12,30 45: R\$ 12,55 60: R\$ 12,80



ESTRELINHA 3 GR 12X1
Código: Fábriça: Unidade:
15077 CITY BRILHO DZ/12
F1 F4

UN: R\$ 0,14 AV: R\$ 27,17 15: R\$ 27,74
30: R\$ 28,29 45: R\$ 28,86 60: R\$ 29,43



ETIQUETA ADESIV TERMICA 10X15CM 200X1
Código: Fábriça: Unidade:
46981 MASTERPRINT RL/200
F1 F4

UN: R\$ 0,65 AV: R\$ 65,43 15: R\$ 66,80
30: R\$ 68,13 45: R\$ 69,49 60: R\$ 70,88



ETIQUETA ADESIVA A4 BCA 210X297MM 100X1
Código: Fábriça: Unidade:
48111 JUSSARA PT/100
F1 F4

UN: R\$ 0,65 AV: R\$ 65,43 15: R\$ 66,80
30: R\$ 68,13 45: R\$ 69,49 60: R\$ 70,88



ETIQUETA ADESIVA BCA 216X279MM 100X1
Código: Fábriça: Unidade:
48112 JUSSARA PT/100
F1 F4

UN: R\$ 49,31 AV: R\$ 49,31 15: R\$ 50,33
30: R\$ 51,34 45: R\$ 52,37 60: R\$ 53,41

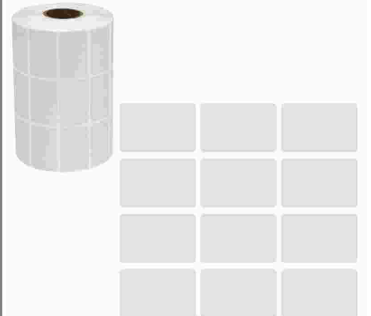

ETIQUETA ADESIVA 33X21X3 30MTS
Código: Fábriça: Unidade:
40124 PRIMUS RL/1
F1 F4

UN: R\$ 0,09 AV: R\$ 9,23 15: R\$ 9,43
30: R\$ 9,62 45: R\$ 9,81 60: R\$ 10,00



ETIQUETA DEC C/AMOR 300 100X1
Código: Fábriça: Unidade:
2903 KARINA RL/100
F1 F4

UN: R\$ 0,09 AV: R\$ 9,23 15: R\$ 9,43
30: R\$ 9,62 45: R\$ 9,81 60: R\$ 10,00



ETIQUETA DEC C/CARINHO DE/PARA 01 100X1
Código: Fábriça: Unidade:
18827 KARINA RL/100
F1 F4

UN: R\$ 0,09 AV: R\$ 9,23 15: R\$ 9,43
30: R\$ 9,62 45: R\$ 9,81 60: R\$ 10,00



ETIQUETA DEC C/CARINHO 435 100X1
Código: Fábriça: Unidade:
18755 KARINA RL/100
F1 F4

UN: R\$ 0,09 AV: R\$ 9,23 15: R\$ 9,43
30: R\$ 9,62 45: R\$ 9,81 60: R\$ 10,00



ETIQUETA DEC C/CARINHO 536 100X1
Código: Fábriça: Unidade:
16057 KARINA RL/100
F1 F4

UN: R\$ 0,09 AV: R\$ 9,23 15: R\$ 9,43
30: R\$ 9,62 45: R\$ 9,81 60: R\$ 10,00



ETIQUETA DEC DE/PARA 503 100X1

Código: Fábrica: Unidade:
16035 KARINA RL/100
F1 F4

UN: R\$ 0,09 AV: R\$ 9,23 15: R\$ 9,43
30: R\$ 9,62 45: R\$ 9,81 60: R\$ 10,00



ETIQUETA DEC FELICIDADES 70 100X1

Código: Fábrica: Unidade:
16052 KARINA RL/100
F1 F4

UN: R\$ 0,09 AV: R\$ 9,23 15: R\$ 9,43
30: R\$ 9,62 45: R\$ 9,81 60: R\$ 10,00



ETIQUETA DEC FELICIDADES DE/PA 256 100X1

Código: Fábrica: Unidade:
16036 KARINA RL/100
F1 F4

UN: R\$ 0,09 AV: R\$ 9,23 15: R\$ 9,43
30: R\$ 9,62 45: R\$ 9,81 60: R\$ 10,00



ETIQUETA DEC FELICIDADES DE/PA 548 100X1

Código: Fábrica: Unidade:
41878 KARINA RL/100
F1 F4

UN: R\$ 0,09 AV: R\$ 9,23 15: R\$ 9,43
30: R\$ 9,62 45: R\$ 9,81 60: R\$ 10,00



ETIQUETA DEC FELICIDADES 005 100X1

Código: Fábrica: Unidade:
14169 KARINA RL/100
F1 F4

UN: R\$ 0,09 AV: R\$ 9,23 15: R\$ 9,43
30: R\$ 9,62 45: R\$ 9,81 60: R\$ 10,00



ETIQUETA DEC FELICIDADES 278 100X1

Código: Fábrica: Unidade:
3094 KARINA RL/100
F1 F4

UN: R\$ 0,09 AV: R\$ 9,23 15: R\$ 9,43
30: R\$ 9,62 45: R\$ 9,81 60: R\$ 10,00



ETIQUETA DEC FELICIDADES 295 100X1

Código: Fábrica: Unidade:
10846 KARINA RL/100
F1 F4

UN: R\$ 0,09 AV: R\$ 9,23 15: R\$ 9,43
30: R\$ 9,62 45: R\$ 9,81 60: R\$ 10,00



ETIQUETA DEC FELICIDADES 585 100X1

Código: Fábrica: Unidade:
16061 KARINA RL/100
F1 F4

UN: R\$ 0,09 AV: R\$ 9,23 15: R\$ 9,43
30: R\$ 9,62 45: R\$ 9,81 60: R\$ 10,00



ETIQUETA DEC FELICIDADES 628 100X1

Código: Fábrica: Unidade:
16026 KARINA RL/100
F1 F4

UN: R\$ 0,09 AV: R\$ 9,23 15: R\$ 9,43
30: R\$ 9,62 45: R\$ 9,81 60: R\$ 10,00



ETIQUETA DEC JESUS TE AMA 08 100X1

Código: Fábrica: Unidade:
30927 KARINA RL/100
F1 F4

UN: R\$ 0,09 AV: R\$ 9,23 15: R\$ 9,43
30: R\$ 9,62 45: R\$ 9,81 60: R\$ 10,00



ETIQUETA DEC MENINHA DE PARA 50 100X1

Código: Fábrica: Unidade:
31887 KARINA RL/100
F1 F4

UN: R\$ 0,09 AV: R\$ 9,23 15: R\$ 9,43
30: R\$ 9,62 45: R\$ 9,81 60: R\$ 10,00



ETIQUETA DEC PARABENS 125 100X1

Código: Fábrica: Unidade:
18819 KARINA RL/100
F1 F4

UN: R\$ 0,09 AV: R\$ 9,23 15: R\$ 9,43
30: R\$ 9,62 45: R\$ 9,81 60: R\$ 10,00



ETIQUETA DEC TRENZINHO DE PARA 95 100X1

Código: Fábrica: Unidade:
31886 KARINA RL/100
F1 F4

UN: R\$ 0,09 AV: R\$ 9,23 15: R\$ 9,43
30: R\$ 9,62 45: R\$ 9,81 60: R\$ 10,00



ETIQUETA DEC URSINHO DE PARA 97 100X1

Código: Fábrica: Unidade:
31888 KARINA RL/100
F1 F4

UN: R\$ 0,13 AV: R\$ 1,53 15: R\$ 1,56
30: R\$ 1,59 45: R\$ 1,63 60: R\$ 1,66



ETIQUETA ESC AUTO ADES 78X35MM VERD 12X1

Código: Fábrica: Unidade:
47934 YIN'S PAPER PT/12
F1 F4

UN: R\$ 0,13 AV: R\$ 1,53 15: R\$ 1,56
30: R\$ 1,59 45: R\$ 1,63 60: R\$ 1,66



ETIQUETA ESC AUTO ADES 78X35MM VERM 2X1

Código: Fábrica: Unidade:
47933 YIN'S PAPER PT/12
F1 F4

UN: R\$ 0,19 AV: R\$ 1,53 15: R\$ 1,56
30: R\$ 1,59 45: R\$ 1,63 60: R\$ 1,66



ETIQUETA ESC AUTO ADES 80X53MM AZUL 8X1

Código: 47931 Fábrica: YIN'S PAPER Unidade: PT/8 F1 F4

UN: R\$ 0,19 AV: R\$ 1,53 15: R\$ 1,56
30: R\$ 1,59 45: R\$ 1,63 60: R\$ 1,66



ETIQUETA ESC AUTO ADES 80X53MM SORT 8X1

Código: 47932 Fábrica: YIN'S PAPER Unidade: PT/8 F1 F4

UN: R\$ 0,08 AV: R\$ 9,99 15: R\$ 10,20
30: R\$ 10,40 45: R\$ 10,61 60: R\$ 10,82



ETIQUETA ESC DEC ATLETICO 6X20

Código: 23310 Fábrica: MINEIRO Unidade: PT/120 F1 F4

UN: R\$ 0,08 AV: R\$ 9,99 15: R\$ 10,20
30: R\$ 10,40 45: R\$ 10,61 60: R\$ 10,82



ETIQUETA ESC DEC BARBIE 6X20

Código: 9471 Fábrica: MINEIRO Unidade: PT/120 F1 F4

UN: R\$ 0,19 AV: R\$ 11,68 15: R\$ 11,92
30: R\$ 12,16 45: R\$ 12,40 60: R\$ 12,65



ETIQUETA ESC DEC CARROS GLITER 6X10

Código: 23302 Fábrica: MINEIRO Unidade: PT/60 F1 F4

UN: R\$ 0,08 AV: R\$ 9,99 15: R\$ 10,20
30: R\$ 10,40 45: R\$ 10,61 60: R\$ 10,82



ETIQUETA ESC DEC CARROSEL 6X20

Código: 15624 Fábrica: MINEIRO Unidade: PT/120 F1 F4

UN: R\$ 0,08 AV: R\$ 9,99 15: R\$ 10,20
30: R\$ 10,40 45: R\$ 10,61 60: R\$ 10,82

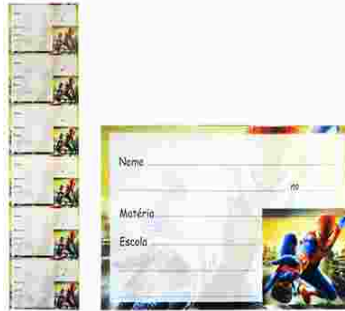

ETIQUETA ESC DEC HOMEM ARANHA 6X20

Código: 23325 Fábrica: MINEIRO Unidade: PT/120 F1 F4

UN: R\$ 0,08 AV: R\$ 9,99 15: R\$ 10,20
30: R\$ 10,40 45: R\$ 10,61 60: R\$ 10,82

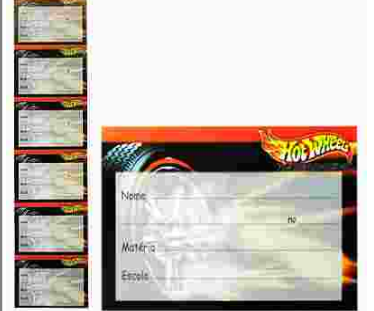

ETIQUETA ESC DEC HOT WELLS 6X20

Código: 15623 Fábrica: MINEIRO Unidade: PT/120 F1 F4

UN: R\$ 0,08 AV: R\$ 9,99 15: R\$ 10,20
30: R\$ 10,40 45: R\$ 10,61 60: R\$ 10,82



ETIQUETA ESC DEC JOLIE 6X20

Código: 23312 Fábrica: MINEIRO Unidade: PT/120 F1 F4

UN: R\$ 0,08 AV: R\$ 9,99 15: R\$ 10,20
30: R\$ 10,40 45: R\$ 10,61 60: R\$ 10,82

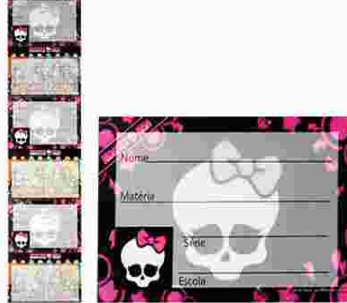

ETIQUETA ESC DEC MONSTER HIGH 6X20

Código: 18816 Fábrica: MINEIRO Unidade: PT/120 F1 F4

UN: R\$ 0,07 AV: R\$ 8,70 15: R\$ 8,88
30: R\$ 9,06 45: R\$ 9,24 60: R\$ 9,43



ETIQUETA ESC DEC MORANGUINHO 6X20

Código: 9475 Fábrica: MINEIRO Unidade: PT/120 F1 F4

UN: R\$ 0,08 AV: R\$ 9,99 15: R\$ 10,20
30: R\$ 10,40 45: R\$ 10,61 60: R\$ 10,82



ETIQUETA ESC DEC PATATI PATATA 6X20

Código: 23322 Fábrica: MINEIRO Unidade: PT/120 F1 F4

UN: R\$ 0,08 AV: R\$ 9,99 15: R\$ 10,20
30: R\$ 10,40 45: R\$ 10,61 60: R\$ 10,82

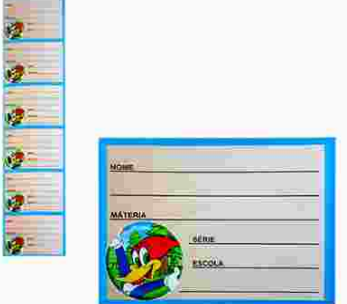

ETIQUETA ESC DEC PICA PAU 6X20

Código: 23308 Fábrica: MINEIRO Unidade: PT/120 F1 F4

UN: R\$ 0,08 AV: R\$ 9,99 15: R\$ 10,20
30: R\$ 10,40 45: R\$ 10,61 60: R\$ 10,82



ETIQUETA ESC DEC PUCCA 6X20

Código: 9476 Fábrica: MINEIRO Unidade: PT/120 F1 F4

UN: R\$ 0,08 AV: R\$ 9,99 15: R\$ 10,20
30: R\$ 10,40 45: R\$ 10,61 60: R\$ 10,82



ETIQUETA ESC DEC SMILINGUIDO 6X20

Código: 9468 Fábrica: MINEIRO Unidade: PT/120 F1 F4

UN: R\$ 0,07 AV: R\$ 8,14 15: R\$ 8,31
30: R\$ 8,47 45: R\$ 8,64 60: R\$ 8,82



ETIQUETA ESC SIMPLES 12X10

Código: 26789 Fábrica: MIN Unidade: PT/120 F1 F4

UN: R\$ 2,05 AV: R\$ 20,53 15: R\$ 20,96
30: R\$ 21,38 45: R\$ 21,81 60: R\$ 22,24



ETIQUETA ETIQUETADORA BRANCO 10X500
Código: Fábrica: Unidade:
49563 ALIANCA RL/10
F1 F4

UN: R\$ 1,58 AV: R\$ 15,77 15: R\$ 16,10
30: R\$ 16,42 45: R\$ 16,75 60: R\$ 17,08

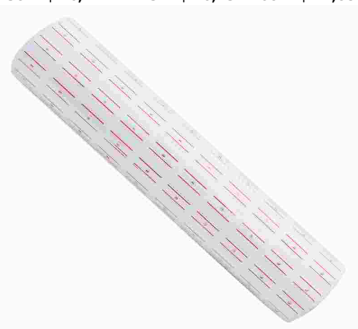

ETIQUETA ETIQUETADORA BRANCO 3551 10X300
Código: Fábrica: Unidade:
36331 WINMAX RL/10
F1 F4

UN: R\$ 2,36 AV: R\$ 23,62 15: R\$ 24,11
30: R\$ 24,59 45: R\$ 25,08 60: R\$ 25,58

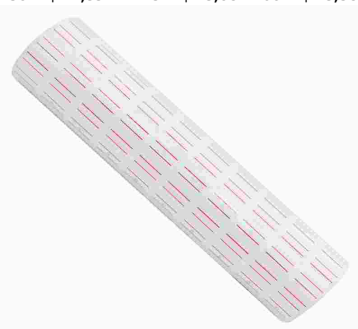

ETIQUETA ETIQUETADORA BRANCO 3552 10X500
Código: Fábrica: Unidade:
16058 WINMAX RL/10
F1 F4

UN: R\$ 2,70 AV: R\$ 27,02 15: R\$ 27,58
30: R\$ 28,13 45: R\$ 28,69 60: R\$ 29,27

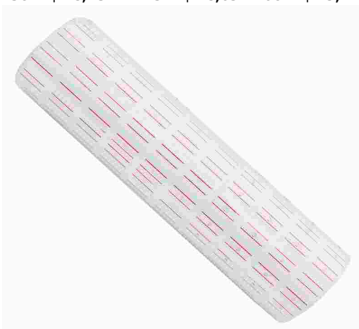

ETIQUETA ETIQUETADORA BRANCO 3553 10X700
Código: Fábrica: Unidade:
49626 WINMAX RL/10
F1 F4

UN: R\$ 3,15 AV: R\$ 31,50 15: R\$ 32,16
30: R\$ 32,80 45: R\$ 33,46 60: R\$ 34,13



ETIQUETA ETIQUETADORA BRANCO 554 10X1000
Código: Fábrica: Unidade:
49625 WINMAX RL/10
F1 F4

UN: R\$ 35,94 AV: R\$ 35,94 15: R\$ 36,69
30: R\$ 37,42 45: R\$ 38,17 60: R\$ 38,94



ETIQUETA ETIQUETADORA 10328 10X1000
Código: Fábrica: Unidade:
22743 LETRON RL/1
F1 F4

UN: R\$ 0,05 AV: R\$ 9,23 15: R\$ 9,43
30: R\$ 9,62 45: R\$ 9,81 60: R\$ 10,00

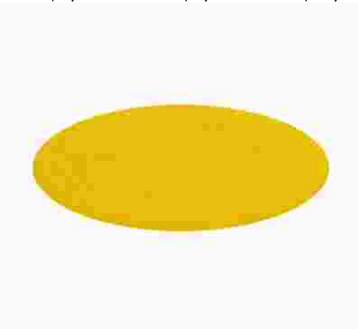

ETIQUETA OVAL P/CONVITE OURO 133 200X1
Código: Fábrica: Unidade:
16047 KARINA RL/200
F1 F4

UN: R\$ 0,05 AV: R\$ 9,23 15: R\$ 9,43
30: R\$ 9,62 45: R\$ 9,81 60: R\$ 10,00

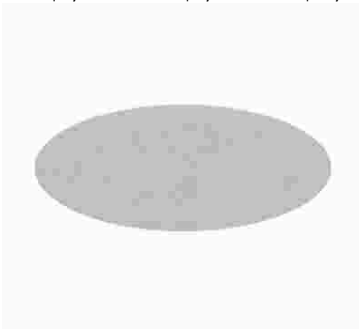

ETIQUETA OVAL P/CONVITE PRATA 134 200X1
Código: Fábrica: Unidade:
16048 KARINA RL/200
F1 F4

UN: R\$ 0,69 AV: R\$ 6,93 15: R\$ 7,08
30: R\$ 7,22 45: R\$ 7,36 60: R\$ 7,51



ETIQUETA PRECO N 1 22X15MM C/REF10X66UN
Código: Fábrica: Unidade:
37775 CARVALHO RL/10
F1 F4

UN: R\$ 0,69 AV: R\$ 6,93 15: R\$ 7,08
30: R\$ 7,22 45: R\$ 7,36 60: R\$ 7,51



ETIQUETA PRECO N 2 22X15MM 10X80UN
Código: Fábrica: Unidade:
5865 FERREIRA RL/10
F1 F4

UN: R\$ 0,69 AV: R\$ 6,93 15: R\$ 7,08
30: R\$ 7,22 45: R\$ 7,36 60: R\$ 7,51



ETIQUETA PRECO N 3 10X20MM 10X100UN
Código: Fábrica: Unidade:
8355 CARVALHO RL/10
F1 F4

UN: R\$ 0,69 AV: R\$ 6,93 15: R\$ 7,08
30: R\$ 7,22 45: R\$ 7,36 60: R\$ 7,51



ETIQUETA PRECO N 3 19X10MM 10X120UN
Código: Fábrica: Unidade:
22738 FERREIRA RL/10
F1 F4

UN: R\$ 0,70 AV: R\$ 6,97 15: R\$ 7,12
30: R\$ 7,26 45: R\$ 7,41 60: R\$ 7,56



ETIQUETA PRECO N 4 22X12MM 10X100UN
Código: Fábrica: Unidade:
10294 FERREIRA RL/10
F1 F4

UN: R\$ 0,70 AV: R\$ 6,97 15: R\$ 7,12
30: R\$ 7,26 45: R\$ 7,41 60: R\$ 7,56



ETIQUETA PRECO N 5 19X40MM 10X30UN
Código: Fábrica: Unidade:
8358 FERREIRA RL/10
F1 F4

UN: R\$ 1,73 AV: R\$ 6,93 15: R\$ 7,08
30: R\$ 7,22 45: R\$ 7,36 60: R\$ 7,51



ETIQUETA PRECO N 6 50X30MM 4X40UN
Código: Fábrica: Unidade:
22737 FERREIRA RL/4
F1 F4

UN: R\$ 0,23 AV: R\$ 6,93 15: R\$ 7,08
30: R\$ 7,22 45: R\$ 7,36 60: R\$ 7,51



ETIQUETA PRECO N 7 76X40MM 3X30UN
Código: Fábrica: Unidade:
50097 FERREIRA PT/30
F1 F4

UN: R\$ 0,69 AV: R\$ 6,93 15: R\$ 7,08
30: R\$ 7,22 45: R\$ 7,36 60: R\$ 7,51



ETIQUETA PRECO N 8 19X30MM 10X40UN
Código: Fábrica: Unidade:
8357 FERREIRA RL/10
F1 F4

UN: R\$ 0,69 AV: R\$ 6,93 15: R\$ 7,08
30: R\$ 7,22 45: R\$ 7,36 60: R\$ 7,51



ETIQUETA PRECO N 9 29X15MM 8X80UN
Código: Fábrica: Unidade:
37684 FERREIRA RL/10
F1 F4

UN: R\$ 1,73 AV: R\$ 6,93 15: R\$ 7,08
30: R\$ 7,22 45: R\$ 7,36 60: R\$ 7,51



ETIQUETA PRECO N 11 43X25MM 4X40UN
Código: Fábrica: Unidade:
37778 CARVALHO RL/4
F1 F4

UN: R\$ 10,78 AV: R\$ 21,56 15: R\$ 22,01
30: R\$ 22,45 45: R\$ 22,90 60: R\$ 23,36



ETIQUETA PRECO N 15 60X40MM 2X250UN
Código: Fábrica: Unidade:
37686 FERREIRA RL/2
F1 F4

UN: R\$ 4,75 AV: R\$ 19,00 15: R\$ 19,40
30: R\$ 19,79 45: R\$ 20,18 60: R\$ 20,59



ETIQUETA PRECO 30MMX5MTS 2124 4X312UN
Código: Fábrica: Unidade:
37422 ADERE RL/4
F1 F4

UN: R\$ 0,02 AV: R\$ 3,16 15: R\$ 3,23
30: R\$ 3,29 45: R\$ 3,36 60: R\$ 3,43



ETIQUETA RED AUTO ADESIV 15MM OURO 210X1
Código: Fábrica: Unidade:
46940 YIN'S PAPER PT/210
F1 F4

UN: R\$ 0,01 AV: R\$ 2,66 15: R\$ 2,72
30: R\$ 2,77 45: R\$ 2,83 60: R\$ 2,88



ETIQUETA RED AUTO ADESIV 15MM SORT 210X1
Código: Fábrica: Unidade:
42813 YIN'S PAPER PT/210
F1 F4

UN: R\$ 0,03 AV: R\$ 9,23 15: R\$ 9,43
30: R\$ 9,62 45: R\$ 9,81 60: R\$ 10,00

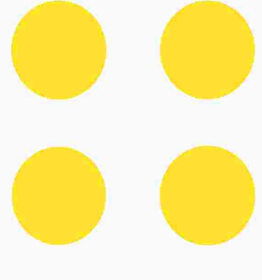

ETIQUETA RED P/CONVITE AMARELO 79 300X1
Código: Fábrica: Unidade:
16042 KARINA RL/300
F1 F4

UN: R\$ 0,03 AV: R\$ 9,23 15: R\$ 9,43
30: R\$ 9,62 45: R\$ 9,81 60: R\$ 10,00

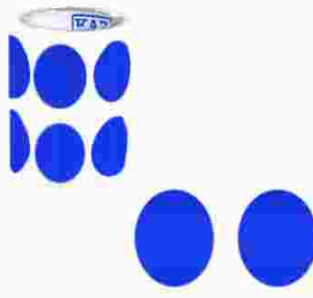

ETIQUETA RED P/CONVITE AZUL 77 300X1
Código: Fábrica: Unidade:
16044 KARINA RL/300
F1 F4

UN: R\$ 0,05 AV: R\$ 9,23 15: R\$ 9,43
30: R\$ 9,62 45: R\$ 9,81 60: R\$ 10,00

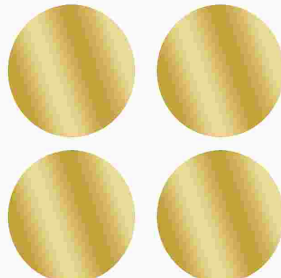

ETIQUETA RED P/CONVITE OURO 27 200X1
Código: Fábrica: Unidade:
35852 KARINA RL/200
F1 F4

UN: R\$ 9,23 AV: R\$ 9,23 15: R\$ 9,43
30: R\$ 9,62 45: R\$ 9,81 60: R\$ 10,00

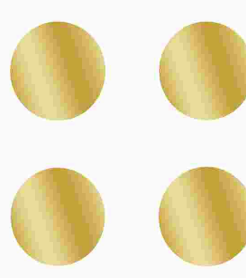

ETIQUETA RED P/CONVITE OURO 96 300X1
Código: Fábrica: Unidade:
6727 KARINA RL/1
F1 F4

UN: R\$ 0,03 AV: R\$ 9,23 15: R\$ 9,43
30: R\$ 9,62 45: R\$ 9,81 60: R\$ 10,00

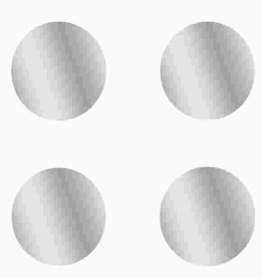

ETIQUETA RED P/CONVITE PRATA 101 300X1
Código: Fábrica: Unidade:
6728 KARINA RL/300
F1 F4

UN: R\$ 0,05 AV: R\$ 9,23 15: R\$ 9,43
30: R\$ 9,62 45: R\$ 9,81 60: R\$ 10,00

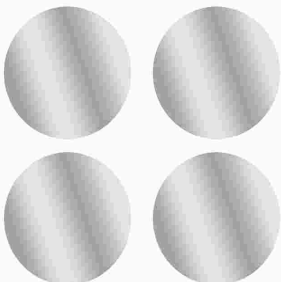

ETIQUETA RED P/CONVITE PRATA 153 200X1
Código: Fábrica: Unidade:
47148 KARINA RL/200
F1 F4

UN: R\$ 0,03 AV: R\$ 9,23 15: R\$ 9,43
30: R\$ 9,62 45: R\$ 9,81 60: R\$ 10,00

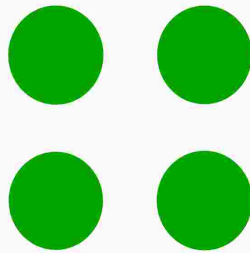

ETIQUETA RED P/CONVITE VERDE 78 300X1
Código: Fábrica: Unidade:
16040 KARINA RL/300
F1 F4

UN: R\$ 0,03 AV: R\$ 9,23 15: R\$ 9,43
30: R\$ 9,62 45: R\$ 9,81 60: R\$ 10,00

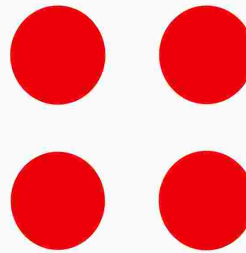

ETIQUETA RED P/CONVITE VERMELHO 76 300X1
Código: Fábrica: Unidade:
16041 KARINA RL/300
F1 F4

UN: R\$ 2,12 AV: R\$ 25,45 15: R\$ 25,98
30: R\$ 26,50 45: R\$ 27,03 60: R\$ 27,57



EXTRATOR GRAMPO METAL CROM 109 12X1
Código: Fábrica: Unidade:
26146 MASTERPRINT DZ/12
F1 F4

UN: R\$ 2,40 AV: R\$ 2,40 15: R\$ 2,45
30: R\$ 2,50 45: R\$ 2,55 60: R\$ 2,60



EXTRATOR GRAMPO METAL GALVANIZ 93050 UN
Código: Fábrika: Unidade:
46519 JOCAROFFICE UN/1
F1 F4

UN: R\$ 3,60 AV: R\$ 3,60 15: R\$ 3,67
30: R\$ 3,74 45: R\$ 3,82 60: R\$ 3,89



EXTRATOR GRAMPO PIRANHA
Código: Fábrika: Unidade:
41715 WIN PAPER UN/1
F1 F4

UN: R\$ 4,17 AV: R\$ 4,17 15: R\$ 4,26
30: R\$ 4,34 45: R\$ 4,43 60: R\$ 4,52



EXTRATOR GRAMPO PIRANHA 24/6 26/6 7138
Código: Fábrika: Unidade:
42812 YIN'S PAPER UN/1
F1 F4

UN: R\$ 1,95 AV: R\$ 23,38 15: R\$ 23,87
30: R\$ 24,34 45: R\$ 24,83 60: R\$ 25,33



EXTRATOR GRAMPO ZINCADO 176 12X1
Código: Fábrika: Unidade:
10459 CARBRINK DZ/12
F1 F4

UN: R\$ 102,71 AV: R\$ 102,71 15: R\$ 104,85
30: R\$ 106,95 45: R\$ 109,09 60: R\$ 111,27



FELTRO EST 140CMX2,5MX200G COMPOSE MAGAL
Código: Fábrika: Unidade:
41987 SANTA FE RL/1
F1 F4

UN: R\$ 41,08 AV: R\$ 102,71 15: R\$ 104,85
30: R\$ 106,95 45: R\$ 109,09 60: R\$ 111,27

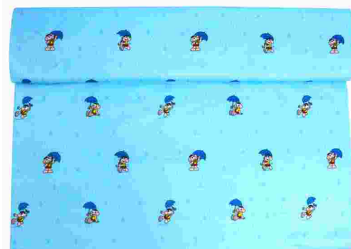

FELTRO EST 140CMX2,5MX200GR CASCAO CHUVA
Código: Fábrika: Unidade:
41992 SANTA FE RL/2,5
F1 F4

UN: R\$ 41,08 AV: R\$ 102,71 15: R\$ 104,85
30: R\$ 106,95 45: R\$ 109,09 60: R\$ 111,27



FELTRO EST 140CMX2,5MX200GR CASCAO GUARD
Código: Fábrika: Unidade:
41993 SANTA FE RL/2,5
F1 F4

UN: R\$ 41,08 AV: R\$ 102,71 15: R\$ 104,85
30: R\$ 106,95 45: R\$ 109,09 60: R\$ 111,27



FELTRO EST 140CMX2,5MX200GR CHIC/ ROSINH
Código: Fábrika: Unidade:
42007 SANTA FE RL/2,5
F1 F4

UN: R\$ 41,08 AV: R\$ 102,71 15: R\$ 104,85
30: R\$ 106,95 45: R\$ 109,09 60: R\$ 111,27

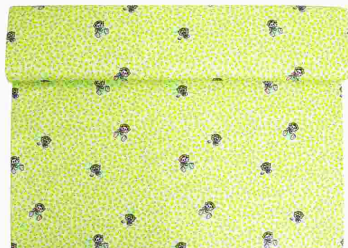

FELTRO EST 140CMX2,5MX200GR CHICO B GOIA
Código: Fábrika: Unidade:
41989 SANTA FE RL/2,5
F1 F4

UN: R\$ 41,08 AV: R\$ 102,71 15: R\$ 104,85
30: R\$ 106,95 45: R\$ 109,09 60: R\$ 111,27



FELTRO EST 140CMX2,5MX200GR MAGALI
Código: Fábrika: Unidade:
41986 SANTA FE RL/2,5
F1 F4

UN: R\$ 41,08 AV: R\$ 102,71 15: R\$ 104,85
30: R\$ 106,95 45: R\$ 109,09 60: R\$ 111,27



FELTRO EST 140CMX2,5MX200GR MONICA CORAC
Código: Fábrika: Unidade:
41990 SANTA FE RL/2,5
F1 F4

UN: R\$ 41,08 AV: R\$ 102,71 15: R\$ 104,85
30: R\$ 106,95 45: R\$ 109,09 60: R\$ 111,27



FELTRO EST 140CMX2,5MX200GR MONICA SANSA
Código: Fábrika: Unidade:
41997 SANTA FE RL/2,5
F1 F4

UN: R\$ 41,08 AV: R\$ 102,71 15: R\$ 104,85
30: R\$ 106,95 45: R\$ 109,09 60: R\$ 111,27



FELTRO EST 140CMX2,5MX200GR QUADRINHOS
Código: Fábrika: Unidade:
41991 SANTA FE RL/2,5
F1 F4

UN: R\$ 41,08 AV: R\$ 102,71 15: R\$ 104,85
30: R\$ 106,95 45: R\$ 109,09 60: R\$ 111,27



FELTRO EST 140CMX2,5MX200GR SANSAO
Código: Fábrika: Unidade:
41995 SANTA FE RL/2,5
F1 F4

UN: R\$ 203,39 AV: R\$ 203,39 15: R\$ 207,62
30: R\$ 211,78 45: R\$ 216,01 60: R\$ 220,33

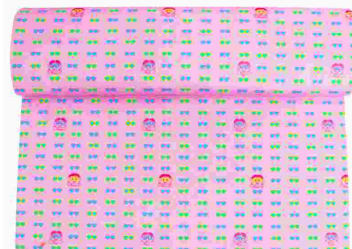

FELTRO EST 140CMX4 CORES 10 T MONICA
Código: Fábrika: Unidade:
41988 SANTA FE RL/1
F1 F4

UN: R\$ 205,43 AV: R\$ 205,43 15: R\$ 209,71
30: R\$ 213,90 45: R\$ 218,18 60: R\$ 222,55

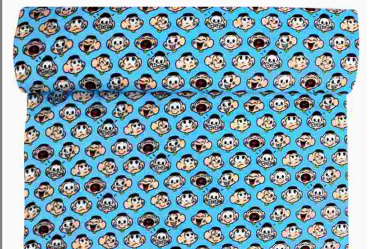

FELTRO EST 140CMX5MX200GR CASCAO
Código: Fábrika: Unidade:
41996 SANTA FE RL/1
F1 F4

UN: R\$ 205,43 AV: R\$ 205,43 15: R\$ 209,71
30: R\$ 213,90 45: R\$ 218,18 60: R\$ 222,55



FELTRO EST 140CMX5MX200GR MAGALI LISTRAS
Código: Fábrica: Unidade:
41994 SANTA FE RL/1
F1 F4

UN: R\$ 277,33 AV: R\$ 277,33 15: R\$ 283,11
30: R\$ 288,77 45: R\$ 294,55 60: R\$ 300,44



FELTRO LISO 140CMX10MX200GR AMARELO CITR
Código: Fábrica: Unidade:
42006 SANTA FE RL/1
F1 F4

UN: R\$ 277,33 AV: R\$ 277,33 15: R\$ 283,11
30: R\$ 288,77 45: R\$ 294,55 60: R\$ 300,44



FELTRO LISO 140CMX10MX200GR AZUL CLARO
Código: Fábrica: Unidade:
41998 SANTA FE RL/1
F1 F4

UN: R\$ 277,33 AV: R\$ 277,33 15: R\$ 283,11
30: R\$ 288,77 45: R\$ 294,55 60: R\$ 300,44



FELTRO LISO 140CMX10MX200GR BRANCO
Código: Fábrica: Unidade:
42002 SANTA FE RL/1
F1 F4

UN: R\$ 277,33 AV: R\$ 277,33 15: R\$ 283,11
30: R\$ 288,77 45: R\$ 294,55 60: R\$ 300,44

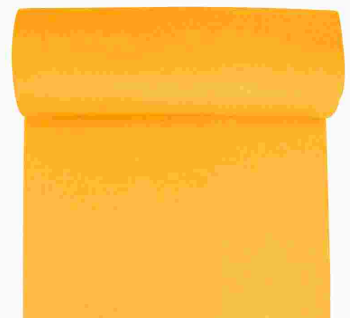

FELTRO LISO 140CMX10MX200GR LARANJA
Código: Fábrica: Unidade:
42000 SANTA FE RL/1
F1 F4

UN: R\$ 277,33 AV: R\$ 277,33 15: R\$ 283,11
30: R\$ 288,77 45: R\$ 294,55 60: R\$ 300,44



FELTRO LISO 140CMX10MX200GR MARROM
Código: Fábrica: Unidade:
42001 SANTA FE RL/1
F1 F4

UN: R\$ 277,33 AV: R\$ 277,33 15: R\$ 283,11
30: R\$ 288,77 45: R\$ 294,55 60: R\$ 300,44



FELTRO LISO 140CMX10MX200GR NUDE
Código: Fábrica: Unidade:
42003 SANTA FE RL/1
F1 F4

UN: R\$ 277,33 AV: R\$ 277,33 15: R\$ 283,11
30: R\$ 288,77 45: R\$ 294,55 60: R\$ 300,44



FELTRO LISO 140CMX10MX200GR ROSA NASCENT
Código: Fábrica: Unidade:
42004 SANTA FE RL/1
F1 F4

UN: R\$ 277,33 AV: R\$ 277,33 15: R\$ 283,11
30: R\$ 288,77 45: R\$ 294,55 60: R\$ 300,44



FELTRO LISO 140CMX10MX200GR VERDE BILHAR
Código: Fábrica: Unidade:
47836 SANTA FE RL/1
F1 F4

UN: R\$ 0,09 AV: R\$ 8,73 15: R\$ 8,91
30: R\$ 9,09 45: R\$ 9,27 60: R\$ 9,46



FICHA CONTAS CORRENTES 5X8 6127-5 100X1
Código: Fábrica: Unidade:
28593 SAO DOMINGOS CE/100
F1 F4

UN: R\$ 0,08 AV: R\$ 8,25 15: R\$ 8,42
30: R\$ 8,59 45: R\$ 8,76 60: R\$ 8,93

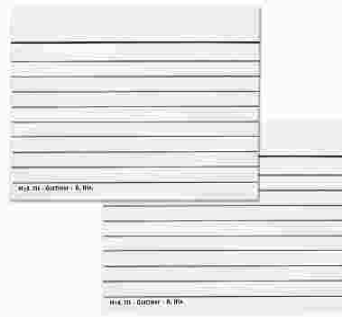

FICHA PAUTADA 3"X5" 100X1
Código: Fábrica: Unidade:
17973 PARKKE PT/100
F1 F4

UN: R\$ 0,14 AV: R\$ 13,74 15: R\$ 14,03
30: R\$ 14,31 45: R\$ 14,60 60: R\$ 14,89



FICHA PAUTADA 4"X6" 100X1
Código: Fábrica: Unidade:
17974 PARRKE PT/100
F1 F4

UN: R\$ 0,21 AV: R\$ 20,94 15: R\$ 21,37
30: R\$ 21,80 45: R\$ 22,24 60: R\$ 22,68



FICHA PAUTADA 5"X8" 100X1
Código: Fábrica: Unidade:
17975 PARKKE PT/100
F1 F4

UN: R\$ 0,21 AV: R\$ 20,53 15: R\$ 20,96
30: R\$ 21,38 45: R\$ 21,81 60: R\$ 22,24



FICHA PAUTADA 6"X9" 100X1
Código: Fábrica: Unidade:
14426 GRIFFE PT/100
F1 F4

UN: R\$ 20,53 AV: R\$ 20,53 15: R\$ 20,96
30: R\$ 21,38 45: R\$ 21,81 60: R\$ 22,24



FICHARIO COMPLETO MICKEY/MINNIE
Código: Fábrica: Unidade:
13395 TILIBRA UN/1
F1 F4

UN: R\$ 154,07 AV: R\$ 154,07 15: R\$ 157,28
30: R\$ 160,43 45: R\$ 163,63 60: R\$ 166,91



FICHARIO P/FICHAS 4"X6" C/INDICE 922
Código: Fábrica: Unidade:
31474 ACRIMET UN/1
F1 F4

UN: R\$ 256,79 AV: R\$ 256,79 15: R\$ 262,14
30: R\$ 267,38 45: R\$ 272,73 60: R\$ 278,18



FICHARIO P/FICHAS 6''X9'' C/ÍNDICE M74
Código: Fábriça: Unidade:
43534 MENNO UN/1
F1 F4

UN: R\$ 20,53 AV: R\$ 20,53 15: R\$ 20,96
30: R\$ 21,38 45: R\$ 21,81 60: R\$ 22,24



FICHARIO TRANSPARENTE
Código: Fábriça: Unidade:
12566 ACP UN/1
F1 F4

UN: R\$ 20,53 AV: R\$ 20,53 15: R\$ 20,96
30: R\$ 21,38 45: R\$ 21,81 60: R\$ 22,24

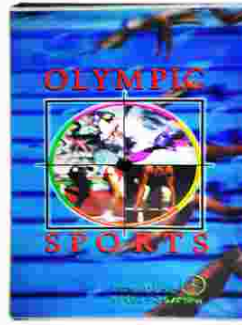

FICHARIO UNIVERS OLYMPIC-SCRAPBOOK 316/A
Código: Fábriça: Unidade:
3756 ACP UN/1
F1 F4

UN: R\$ 20,53 AV: R\$ 20,53 15: R\$ 20,96
30: R\$ 21,38 45: R\$ 21,81 60: R\$ 22,24

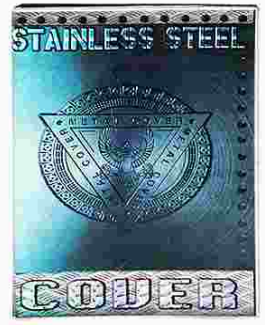

FICHARIO UNIVERS RUSTY STE TEXTURE 316 D
Código: Fábriça: Unidade:
10071 ACP UN/1
F1 F4

UN: R\$ 20,53 AV: R\$ 20,53 15: R\$ 20,96
30: R\$ 21,38 45: R\$ 21,81 60: R\$ 22,24

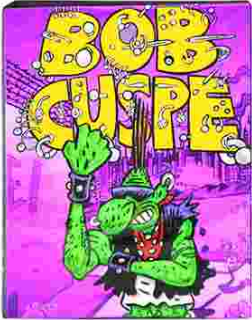

FICHARIO UNIVERSITARIO ANGELI 4089 SKRO
Código: Fábriça: Unidade:
19338 FORONI UN/1
F1 F4

UN: R\$ 20,53 AV: R\$ 20,53 15: R\$ 20,96
30: R\$ 21,38 45: R\$ 21,81 60: R\$ 22,24

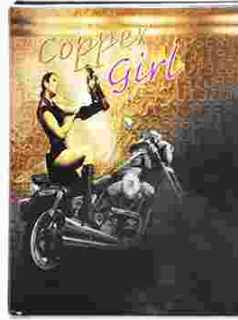

FICHARIO UNIVERSITARIO GIRL 316C
Código: Fábriça: Unidade:
19335 ACP UN/1
F1 F4

UN: R\$ 20,53 AV: R\$ 20,53 15: R\$ 20,96
30: R\$ 21,38 45: R\$ 21,81 60: R\$ 22,24



FICHARIO UNIVERSITARIO JEANS FASHION316B
Código: Fábriça: Unidade:
19334 ACP UN/1
F1 F4

UN: R\$ 30,81 AV: R\$ 30,81 15: R\$ 31,45
30: R\$ 32,08 45: R\$ 32,72 60: R\$ 33,37



FICHARIO UNIVERSITARIO 4 ARGOL PRETO 316
Código: Fábriça: Unidade:
19337 ACP UN/1
F1 F4

UN: R\$ 24,85 AV: R\$ 24,85 15: R\$ 25,37
30: R\$ 25,87 45: R\$ 26,39 60: R\$ 26,92



FICHARIO 2 ARGOLAS
Código: Fábriça: Unidade:
45965 ACP UN/1
F1 F4

UN: R\$ 20,53 AV: R\$ 20,53 15: R\$ 20,96
30: R\$ 21,38 45: R\$ 21,81 60: R\$ 22,24



FICHARIO 4 ARGOLAS
Código: Fábriça: Unidade:
6424 LOMY UN/1
F1 F4

UN: R\$ 5,39 AV: R\$ 5,39 15: R\$ 5,51
30: R\$ 5,62 45: R\$ 5,73 60: R\$ 5,84

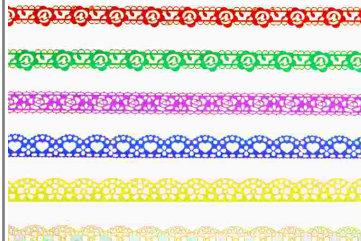

FITA ADES DECORATIVA 1,8CMX100MM 20135
Código: Fábriça: Unidade:
45944 WIN PAPER RL/1
F1 F4

UN: R\$ 7,50 AV: R\$ 7,50 15: R\$ 7,65
30: R\$ 7,81 45: R\$ 7,96 60: R\$ 8,12



FITA ADES MINI DEC BRILHANTE C/SUP 9X1
Código: Fábriça: Unidade:
34793 AGUIA BRANCA CR/1
F1 F4

UN: R\$ 1,68 AV: R\$ 8,41 15: R\$ 8,58
30: R\$ 8,76 45: R\$ 8,93 60: R\$ 9,11



FITA ADES PEQ DECORAD 15MMX2,6MTS 5X1
Código: Fábriça: Unidade:
42803 INTERPOTENTE PT/5
F1 F4

UN: R\$ 2,05 AV: R\$ 12,32 15: R\$ 12,57
30: R\$ 12,82 45: R\$ 13,08 60: R\$ 13,34



FITA ADES WASHI 15MMX3M GOLD 234 6X1
Código: Fábriça: Unidade:
40276 LYKE CR/6
F1 F4

UN: R\$ 1,27 AV: R\$ 12,68 15: R\$ 12,94
30: R\$ 13,20 45: R\$ 13,47 60: R\$ 13,73



FITA ADES 12MMX10 MTS AZUL 10X1
Código: Fábriça: Unidade:
6202 FITPEL/ADELB PT/10
F1 F4

UN: R\$ 1,27 AV: R\$ 12,68 15: R\$ 12,94
30: R\$ 13,20 45: R\$ 13,47 60: R\$ 13,73



FITA ADES 12MMX10 MTS BRANCO 10X1
Código: Fábriça: Unidade:
6204 FIT-PEL PT/10
F1 F4

UN: R\$ 1,27 AV: R\$ 12,68 15: R\$ 12,94
30: R\$ 13,20 45: R\$ 13,47 60: R\$ 13,73



FITA ADES 12MMX10MTS LARANJA 10X1
Código: 15564 Fábrica: FIT-PEL Unidade: PT/10 F1 F4

UN: R\$ 1,27 AV: R\$ 12,68 15: R\$ 12,94
30: R\$ 13,20 45: R\$ 13,47 60: R\$ 13,73



FITA ADES 12MMX10MTS LILAS 10X1
Código: 35944 Fábrica: FIT-PEL Unidade: PT/10 F1 F4

UN: R\$ 1,27 AV: R\$ 12,68 15: R\$ 12,94
30: R\$ 13,20 45: R\$ 13,47 60: R\$ 13,73



FITA ADES 12MMX10MTS PRATA 10X1
Código: 6544 Fábrica: FIT-PEL Unidade: PT/10 F1 F4

UN: R\$ 1,21 AV: R\$ 12,10 15: R\$ 12,35
30: R\$ 12,60 45: R\$ 12,85 60: R\$ 13,11



FITA ADES 12MMX10MTS ROSA 10X1
Código: 15565 Fábrica: FITPEL/ADELB Unidade: PT/10 F1 F4

UN: R\$ 1,19 AV: R\$ 85,60 15: R\$ 87,38
30: R\$ 89,13 45: R\$ 90,91 60: R\$ 92,73



FITA ADES 12MMX10MTS SORT POTE 72X1
Código: 46830 Fábrica: BRW Unidade: CJ/72 F1 F4

UN: R\$ 0,77 AV: R\$ 7,69 15: R\$ 7,85
30: R\$ 8,01 45: R\$ 8,17 60: R\$ 8,33



FITA ADES 12MMX10MTS TRANSPARENT 10X1
Código: 356 Fábrica: FIT-PEL Unidade: PT/10 F1 F4

UN: R\$ 1,13 AV: R\$ 11,29 15: R\$ 11,52
30: R\$ 11,75 45: R\$ 11,99 60: R\$ 12,23



FITA ADES 12MMX10MTS VERDE 10X1
Código: 6203 Fábrica: FIT-PEL Unidade: PT/10 F1 F4

UN: R\$ 1,27 AV: R\$ 12,68 15: R\$ 12,94
30: R\$ 13,20 45: R\$ 13,47 60: R\$ 13,73



FITA ADES 12MMX10MTS VERMELHO 10X1
Código: 358 Fábrica: FITPEL/ADELB Unidade: PT/10 F1 F4

UN: R\$ 2,88 AV: R\$ 11,52 15: R\$ 11,76
30: R\$ 12,00 45: R\$ 12,24 60: R\$ 12,48



FITA ADES 12MMX18MTS METALI SORT 12X1
Código: 34679 Fábrica: HAI BRASIL Unidade: PT/4 F1 F4

UN: R\$ 0,89 AV: R\$ 8,94 15: R\$ 8,94
30: R\$ 8,94 45: R\$ 8,94 60: R\$ 8,94



FITA ADES 12MMX20MTS TRANSPARENT 10X1
Código: 2984 Fábrica: FIT-PEL Unidade: PT/10 F1 F4

UN: R\$ 1,44 AV: R\$ 14,37 15: R\$ 14,67
30: R\$ 14,96 45: R\$ 15,26 60: R\$ 15,57



FITA ADES 12MMX30MTS TRANSP 7495 10X1
Código: 5827 Fábrica: YINS/KORETCH Unidade: PT/10 F1 F4

UN: R\$ 2,05 AV: R\$ 20,53 15: R\$ 20,96
30: R\$ 21,38 45: R\$ 21,81 60: R\$ 22,24



FITA ADES 12MMX33MTS AMARELO FLU 10X1
Código: 31539 Fábrica: FIT-PEL Unidade: PT/10 F1 F4

UN: R\$ 2,05 AV: R\$ 20,53 15: R\$ 20,96
30: R\$ 21,38 45: R\$ 21,81 60: R\$ 22,24



FITA ADES 12MMX33MTS AMARELO 10X1
Código: 31537 Fábrica: FIT-PEL Unidade: PT/10 F1 F4

UN: R\$ 2,05 AV: R\$ 20,53 15: R\$ 20,96
30: R\$ 21,38 45: R\$ 21,81 60: R\$ 22,24



FITA ADES 12MMX33MTS AZUL 10X1
Código: 43710 Fábrica: FIT-PEL Unidade: PT/10 F1 F4

UN: R\$ 2,05 AV: R\$ 20,53 15: R\$ 20,96
30: R\$ 21,38 45: R\$ 21,81 60: R\$ 22,24



FITA ADES 12MMX33MTS BRANCO 10X1
Código: 31543 Fábrica: FIT-PEL Unidade: PT/10 F1 F4

UN: R\$ 2,69 AV: R\$ 2,69 15: R\$ 2,69
30: R\$ 2,69 45: R\$ 2,69 60: R\$ 2,69



FITA ADES 12MMX33MTS INVISI C/SUP PTO
Código: 33630 Fábrica: KORES Unidade: UN/1 F1 F4

106 cm

UN: R\$ 2,05 AV: R\$ 20,53 15: R\$ 20,96
30: R\$ 21,38 45: R\$ 21,81 60: R\$ 22,24



FITA ADES 12MMX33MTS LILAS 10X1

Código: 31536 Fábrica: FIT-PEL Unidade: PT/10 F1 F4

UN: R\$ 2,05 AV: R\$ 20,53 15: R\$ 20,96
30: R\$ 21,38 45: R\$ 21,81 60: R\$ 22,24



FITA ADES 12MMX33MTS PRETO 10X1

Código: 31542 Fábrica: FIT-PEL Unidade: PT/10 F1 F4

UN: R\$ 2,05 AV: R\$ 20,53 15: R\$ 20,96
30: R\$ 21,38 45: R\$ 21,81 60: R\$ 22,24



FITA ADES 12MMX33MTS ROSA FLUOR 10X1

Código: 31544 Fábrica: FIT-PEL Unidade: PT/10 F1 F4

UN: R\$ 3,07 AV: R\$ 3,07 15: R\$ 3,14
30: R\$ 3,20 45: R\$ 3,26 60: R\$ 3,33



FITA ADES 12MMX33MTS TRANSP C/SUP VERMEL

Código: 33255 Fábrica: KORES Unidade: UN/1 F1 F4

UN: R\$ 2,05 AV: R\$ 20,53 15: R\$ 20,96
30: R\$ 21,38 45: R\$ 21,81 60: R\$ 22,24



FITA ADES 12MMX33MTS VERDE FLUOR 10X1

Código: 31541 Fábrica: FIT-PEL Unidade: PT/10 F1 F4

UN: R\$ 2,05 AV: R\$ 20,53 15: R\$ 20,96
30: R\$ 21,38 45: R\$ 21,81 60: R\$ 22,24



FITA ADES 12MMX33MTS VERDE 10X1

Código: 31540 Fábrica: FIT-PEL Unidade: PT/10 F1 F4

UN: R\$ 2,05 AV: R\$ 20,54 15: R\$ 20,97
30: R\$ 21,39 45: R\$ 21,82 60: R\$ 22,25



FITA ADES 12MMX33MTS VERMELHO 10X1

Código: 43711 Fábrica: FIT-PEL Unidade: PT/10 F1 F4

UN: R\$ 1,72 AV: R\$ 1,72 15: R\$ 1,75
30: R\$ 1,79 45: R\$ 1,83 60: R\$ 1,86



FITA ADES 12MMX40MTS TRANSPARENTE UN

Código: 33914 Fábrica: KORES Unidade: UN/1 F1 F4

UN: R\$ 1,49 AV: R\$ 14,94 15: R\$ 14,94
30: R\$ 14,94 45: R\$ 14,94 60: R\$ 14,94



FITA ADES 12MMX40MTS TRANSPARENTE 10X1

Código: 19321 Fábrica: KORETECH Unidade: PT/10 F1 F4

UN: R\$ 2,26 AV: R\$ 22,59 15: R\$ 23,06
30: R\$ 23,52 45: R\$ 23,99 60: R\$ 24,47



FITA ADES 12MMX65MTS TRANSPARENT 10X1

Código: 32699 Fábrica: KORETECH Unidade: PT/10 F1 F4

UN: R\$ 2,40 AV: R\$ 14,37 15: R\$ 14,67
30: R\$ 14,96 45: R\$ 15,26 60: R\$ 15,57



FITA ADES 15MMX3MTS C/GLITER 2011 6X1

Código: 44808 Fábrica: WIN PAPER Unidade: CX/6 F1 F4

UN: R\$ 2,49 AV: R\$ 17,45 15: R\$ 17,82
30: R\$ 18,17 45: R\$ 18,54 60: R\$ 18,91



FITA ADES 18MMX50MTS TRANSP 43 7X1

Código: 49895 Fábrica: ALLTAPE Unidade: PT/7 F1 F4

UN: R\$ 7,21 AV: R\$ 7,21 15: R\$ 7,36
30: R\$ 7,51 45: R\$ 7,66 60: R\$ 7,81



FITA ADES 19MMX33MTS INVISIVEL 20018

Código: 48387 Fábrica: WIN PAPER Unidade: CR/1 F1 F4

UN: R\$ 3,28 AV: R\$ 16,42 15: R\$ 16,77
30: R\$ 17,10 45: R\$ 17,44 60: R\$ 17,79



FITA ADES 24MMX50MTS TRANSP 44 5X1

Código: 49893 Fábrica: ALLTAPE Unidade: PT/5 F1 F4

UN: R\$ 173,03 AV: R\$ 173,03 15: R\$ 176,63
30: R\$ 180,17 45: R\$ 183,77 60: R\$ 187,44



FITA ADES 45MMX1200MTS TRANSPARENTE

Código: 42204 Fábrica: HAI BRASIL Unidade: UN/1 F1 F4

UN: R\$ 26,52 AV: R\$ 26,52 15: R\$ 27,07
30: R\$ 27,62 45: R\$ 28,17 60: R\$ 28,73



FITA ADES 45MMX150MTS TRANSPARENTE

Código: 42203 Fábrica: HAI BRASIL Unidade: UN/1 F1 F4

UN: R\$ 35,75 AV: R\$ 35,75 15: R\$ 36,49
30: R\$ 37,22 45: R\$ 37,97 60: R\$ 38,73



FITA ADES 45MMX200MTS TRANSPARENTE

Código: Fábrica: Unidade:
42202 HAI BRASIL UN/1
F1 F4

UN: R\$ 2,99 AV: R\$ 14,95 15: R\$ 14,95
30: R\$ 14,95 45: R\$ 14,95 60: R\$ 14,95



FITA ADES 45MMX30MTS MARROM 5X1

Código: Fábrica: Unidade:
43332 KORETECH PT/5
F1 F4

UN: R\$ 2,99 AV: R\$ 14,95 15: R\$ 14,95
30: R\$ 14,95 45: R\$ 14,95 60: R\$ 14,95



FITA ADES 45MMX30MTS TRANSPARENTE 5X1

Código: Fábrica: Unidade:
43331 KORETECH PT/5
F1 F4

UN: R\$ 40,36 AV: R\$ 40,36 15: R\$ 41,21
30: R\$ 42,03 45: R\$ 42,87 60: R\$ 43,73



FITA ADES 45MMX300MTS TRANSPARENTE

Código: Fábrica: Unidade:
38431 HAI BRASIL UN/1
F1 F4

UN: R\$ 7,69 AV: R\$ 46,13 15: R\$ 47,09
30: R\$ 48,04 45: R\$ 49,00 60: R\$ 49,98



FITA ADES 45MMX35MTS COR SORT 468 6X1

Código: Fábrica: Unidade:
27729 HAI BRASIL PT/6
F1 F4

UN: R\$ 7,80 AV: R\$ 39,02 15: R\$ 39,84
30: R\$ 40,63 45: R\$ 41,45 60: R\$ 42,27



FITA ADES 45MMX40MTS AMARELO 5X1

Código: Fábrica: Unidade:
43347 KORETECH PT/5
F1 F4

UN: R\$ 7,80 AV: R\$ 39,02 15: R\$ 39,84
30: R\$ 40,63 45: R\$ 41,45 60: R\$ 42,27

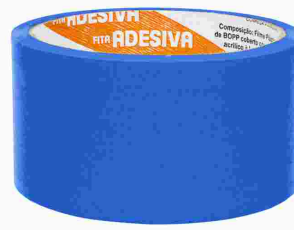

FITA ADES 45MMX40MTS AZUL 5X1

Código: Fábrica: Unidade:
43344 KORETECH PT/5
F1 F4

UN: R\$ 7,80 AV: R\$ 39,02 15: R\$ 39,84
30: R\$ 40,63 45: R\$ 41,45 60: R\$ 42,27



FITA ADES 45MMX40MTS BRANCA 5X1

Código: Fábrica: Unidade:
43342 KORETECH PT/5
F1 F4

UN: R\$ 5,34 AV: R\$ 26,70 15: R\$ 27,25
30: R\$ 27,80 45: R\$ 28,35 60: R\$ 28,92



FITA ADES 45MMX40MTS MARROM 5X1

Código: Fábrica: Unidade:
43349 KORETECH PT/5
F1 F4

UN: R\$ 7,80 AV: R\$ 39,02 15: R\$ 39,84
30: R\$ 40,63 45: R\$ 41,45 60: R\$ 42,27



FITA ADES 45MMX40MTS PRETA 5X1

Código: Fábrica: Unidade:
43343 KORETECH PT/5
F1 F4

UN: R\$ 4,99 AV: R\$ 19,96 15: R\$ 19,96
30: R\$ 19,96 45: R\$ 19,96 60: R\$ 19,96



FITA ADES 45MMX40MTS TRANSP 710 4X1

Código: Fábrica: Unidade:
42206 ADERE PT/4
F1 F4

UN: R\$ 4,59 AV: R\$ 22,95 15: R\$ 22,95
30: R\$ 22,95 45: R\$ 22,95 60: R\$ 22,95



FITA ADES 45MMX40MTS TRANSPARENTE 5X1

Código: Fábrica: Unidade:
43348 KORETECH PT/5
F1 F4

UN: R\$ 7,80 AV: R\$ 39,02 15: R\$ 39,84
30: R\$ 40,63 45: R\$ 41,45 60: R\$ 42,27



FITA ADES 45MMX40MTS VERDE 5X1

Código: Fábrica: Unidade:
43345 KORETECH PT/5
F1 F4

UN: R\$ 7,80 AV: R\$ 39,02 15: R\$ 39,84
30: R\$ 40,63 45: R\$ 41,45 60: R\$ 42,27



FITA ADES 45MMX40MTS VERMELHO 5X1

Código: Fábrica: Unidade:
43346 KORETECH PT/5
F1 F4

UN: R\$ 5,77 AV: R\$ 28,83 15: R\$ 29,43
30: R\$ 30,02 45: R\$ 30,62 60: R\$ 31,23



FITA ADES 45MMX45MTS MARROM 5X1

Código: Fábrica: Unidade:
4161 FIT-PEL/KORE PT/5
F1 F4

UN: R\$ 6,10 AV: R\$ 30,51 15: R\$ 31,15
30: R\$ 31,77 45: R\$ 32,41 60: R\$ 33,05



FITA ADES 45MMX45MTS MARROM 5X1

Código: Fábrica: Unidade:
40211 TIGHT TAPE PT/5
F1 F4

UN: R\$ 6,91 AV: R\$ 6,91 15: R\$ 7,05
30: R\$ 7,20 45: R\$ 7,34 60: R\$ 7,49



FITA ADES 45MMX45MTS TRANSPARENTE UN
Código: Fábrica: Unidade:
42434 FIT PEL UN/1
F1 F4

UN: R\$ 12,32 AV: R\$ 61,62 15: R\$ 62,91
30: R\$ 64,16 45: R\$ 65,45 60: R\$ 66,76

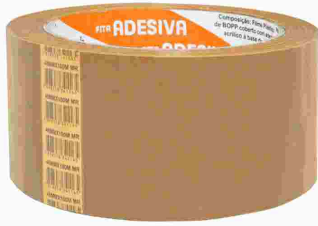

FITA ADES 48MMX100MTS MARROM 5X1
Código: Fábrica: Unidade:
43337 KORETECH PT/5
F1 F4

UN: R\$ 24,64 AV: R\$ 24,64 15: R\$ 25,16
30: R\$ 25,66 45: R\$ 26,17 60: R\$ 26,70



FITA ADES 48MMX30M DEMARC SOLO AMA/PT 80
Código: Fábrica: Unidade:
44320 ALLTAPE RL/1
F1 F4

UN: R\$ 24,64 AV: R\$ 24,64 15: R\$ 25,16
30: R\$ 25,66 45: R\$ 26,17 60: R\$ 26,70



FITA ADES 48MMX30M DEMARC SOLO AMAREL 71
Código: Fábrica: Unidade:
44318 ALLTAPE RL/1
F1 F4

UN: R\$ 24,64 AV: R\$ 24,64 15: R\$ 25,16
30: R\$ 25,66 45: R\$ 26,17 60: R\$ 26,70



FITA ADES 48MMX30M DEMARC SOLO AZUL 83
Código: Fábrica: Unidade:
44315 ALLTAPE RL/1
F1 F4

UN: R\$ 24,64 AV: R\$ 24,64 15: R\$ 25,16
30: R\$ 25,66 45: R\$ 26,17 60: R\$ 26,70



FITA ADES 48MMX30M DEMARC SOLO BRANCA 81
Código: Fábrica: Unidade:
44316 ALLTAPE RL/1
F1 F4

UN: R\$ 24,64 AV: R\$ 24,64 15: R\$ 25,16
30: R\$ 25,66 45: R\$ 26,17 60: R\$ 26,70



FITA ADES 48MMX30M DEMARC SOLO VERDE 82
Código: Fábrica: Unidade:
44317 ALLTAPE RL/1
F1 F4

UN: R\$ 24,64 AV: R\$ 24,64 15: R\$ 25,16
30: R\$ 25,66 45: R\$ 26,17 60: R\$ 26,70



FITA ADES 48MMX30M DEMARC SOLO VERM 72
Código: Fábrica: Unidade:
44319 ALLTAPE RL/1
F1 F4

UN: R\$ 7,19 AV: R\$ 35,94 15: R\$ 36,69
30: R\$ 37,42 45: R\$ 38,17 60: R\$ 38,94



FITA ADES 48MMX40MTS METALIZADA 5X1
Código: Fábrica: Unidade:
43334 KORETECH PT/5
F1 F4

UN: R\$ 6,63 AV: R\$ 26,53 15: R\$ 27,09
30: R\$ 27,63 45: R\$ 28,18 60: R\$ 28,74



FITA ADES 48MMX40MTS TRANSPARENTE 4X1
Código: Fábrica: Unidade:
31612 ADELBRAS PT/4
F1 F4

UN: R\$ 6,37 AV: R\$ 31,83 15: R\$ 32,50
30: R\$ 33,15 45: R\$ 33,81 60: R\$ 34,49



FITA ADES 48MMX45MTS MARROM 5X1
Código: Fábrica: Unidade:
43336 KORETECH PT/5
F1 F4

UN: R\$ 6,37 AV: R\$ 31,83 15: R\$ 32,50
30: R\$ 33,15 45: R\$ 33,81 60: R\$ 34,49



FITA ADES 48MMX45MTS TRANSPARENTE 5X1
Código: Fábrica: Unidade:
43335 KORETECH PT/5
F1 F4

UN: R\$ 20,53 AV: R\$ 20,53 15: R\$ 20,96
30: R\$ 21,38 45: R\$ 21,81 60: R\$ 22,24



FITA ADES 48MMX5MTS PRATA UN
Código: Fábrica: Unidade:
49397 TEK BOND UN/1
F1 F4

UN: R\$ 6,42 AV: R\$ 25,67 15: R\$ 26,20
30: R\$ 26,73 45: R\$ 27,26 60: R\$ 27,81



FITA ADES 48MMX50MTS TRANSP 4X1
Código: Fábrica: Unidade:
44314 ALLTAPE PT/4
F1 F4

UN: R\$ 7,46 AV: R\$ 7,46 15: R\$ 7,61
30: R\$ 7,77 45: R\$ 7,92 60: R\$ 8,08



FITA CORRETIVA 5MMX10MTS CTL 242201
Código: Fábrica: Unidade:
44108 FUTURO CR/1
F1 F4

UN: R\$ 6,78 AV: R\$ 6,78 15: R\$ 6,92
30: R\$ 7,06 45: R\$ 7,20 60: R\$ 7,34



FITA CORRETIVA 5MMX10MTS 91416
Código: Fábrica: Unidade:
50648 JOCAROFFICE CR/1
F1 F4

UN: R\$ 11,76 AV: R\$ 11,76 15: R\$ 12,01
30: R\$ 12,25 45: R\$ 12,49 60: R\$ 12,74



FITA CORRETIVA 5MMX12MTS PRIME 1003
Código: 44986 Fábrica: BRW Unidade: CR/1 F1 F4

UN: R\$ 5,27 AV: R\$ 5,27 15: R\$ 5,38
30: R\$ 5,49 45: R\$ 5,60 60: R\$ 5,71



FITA CORRETIVA 5MMX12MTS 437
Código: 46545 Fábrica: MASTERPRINT Unidade: UN/1 F1 F4

UN: R\$ 6,16 AV: R\$ 6,16 15: R\$ 6,29
30: R\$ 6,42 45: R\$ 6,55 60: R\$ 6,68



FITA CORRETIVA 5MMX6MTS CTL 1002
Código: 34108 Fábrica: BRW Unidade: CR/1 F1 F4

UN: R\$ 4,25 AV: R\$ 4,25 15: R\$ 4,34
30: R\$ 4,43 45: R\$ 4,52 60: R\$ 4,61



FITA CORRETIVA 5MMX6MTS 436
Código: 40786 Fábrica: MASTERPRINT Unidade: CR/1 F1 F4

UN: R\$ 5,54 AV: R\$ 27,70 15: R\$ 28,28
30: R\$ 28,85 45: R\$ 29,42 60: R\$ 30,01



FITA CREPE 18MMX40MTS USO GERAL 5X1
Código: 48113 Fábrica: JUSSARA Unidade: PT/5 F1 F4

UN: R\$ 6,93 AV: R\$ 34,67 15: R\$ 35,39
30: R\$ 36,10 45: R\$ 36,82 60: R\$ 37,56



FITA CREPE 18MMX50MTS USO GERAL 5X1
Código: 48114 Fábrica: JUSSARA Unidade: PT/5 F1 F4

UN: R\$ 6,78 AV: R\$ 33,89 15: R\$ 34,59
30: R\$ 35,29 45: R\$ 35,99 60: R\$ 36,71



FITA CREPE 18MMX50MTS USO GERAL 5X1
Código: 48649 Fábrica: TEK BOND Unidade: PT/5 F1 F4

UN: R\$ 5,39 AV: R\$ 43,13 15: R\$ 44,03
30: R\$ 44,91 45: R\$ 45,81 60: R\$ 46,73



FITA CREPE 18MMX50MTS USO GERAL 81 8X1
Código: 49891 Fábrica: ALLTAPE Unidade: PT/8 F1 F4

UN: R\$ 7,60 AV: R\$ 38,00 15: R\$ 38,79
30: R\$ 39,56 45: R\$ 40,35 60: R\$ 41,16



FITA CREPE 24MMX50MTS USO GERAL 5X1
Código: 48650 Fábrica: TEK BOND Unidade: PT/5 F1 F4

UN: R\$ 17,45 AV: R\$ 17,45 15: R\$ 17,82
30: R\$ 18,17 45: R\$ 18,54 60: R\$ 18,91



FITA CREPE 48MMX50MTS USO GERAL 1X1
Código: 48651 Fábrica: TEK BOND Unidade: UN/1 F1 F4

UN: R\$ 15,75 AV: R\$ 47,24 15: R\$ 48,23
30: R\$ 49,19 45: R\$ 50,17 60: R\$ 51,18



FITA CREPE 48MMX50MTS USO GERAL 83 3X1
Código: 44313 Fábrica: ALLTAPE Unidade: PT/3 F1 F4

UN: R\$ 14,37 AV: R\$ 14,37 15: R\$ 14,67
30: R\$ 14,96 45: R\$ 15,26 60: R\$ 15,57



FITA DEC 25MMX10MTS ROSA BRILHO
Código: 43387 Fábrica: VMP Unidade: RL/1 F1 F4

UN: R\$ 15,40 AV: R\$ 15,40 15: R\$ 15,72
30: R\$ 16,03 45: R\$ 16,35 60: R\$ 16,68



FITA DEC 38MMX10MTS AZUL ESTAMP BOLINHAS
Código: 43385 Fábrica: VMP Unidade: RL/1 F1 F4

UN: R\$ 17,45 AV: R\$ 17,45 15: R\$ 17,82
30: R\$ 18,17 45: R\$ 18,54 60: R\$ 18,91



FITA DEC 38MMX10MTS AZUL ESTAMP PRATA
Código: 43382 Fábrica: VMP Unidade: RL/1 F1 F4

UN: R\$ 16,42 AV: R\$ 16,42 15: R\$ 16,77
30: R\$ 17,10 45: R\$ 17,44 60: R\$ 17,79



FITA DEC 38MMX10MTS BRANCO C/ GLITER
Código: 43383 Fábrica: VMP Unidade: RL/1 F1 F4

UN: R\$ 24,64 AV: R\$ 24,64 15: R\$ 25,16
30: R\$ 25,66 45: R\$ 26,17 60: R\$ 26,70



FITA DEC 38MMX10MTS ESTAMP NATAL
Código: 43381 Fábrica: VMP Unidade: RL/1 F1 F4

UN: R\$ 17,45 AV: R\$ 17,45 15: R\$ 17,82
30: R\$ 18,17 45: R\$ 18,54 60: R\$ 18,91



FITA DEC 38MMX10MTS LILAS ESTAMP OURO
Código: Fábrica: Unidade:
43380 VMP RL/1
F1 F4

UN: R\$ 16,42 AV: R\$ 16,42 15: R\$ 16,77
30: R\$ 17,10 45: R\$ 17,44 60: R\$ 17,79



FITA DEC 38MMX10MTS OURO ESTAMP
Código: Fábrica: Unidade:
43378 VMP RL/1
F1 F4

UN: R\$ 24,14 AV: R\$ 24,14 15: R\$ 24,64
30: R\$ 25,13 45: R\$ 25,64 60: R\$ 26,15



FITA DEC 63MMX10MTS BRANCO C/ GLITER
Código: Fábrica: Unidade:
43388 VMP RL/1
F1 F4

UN: R\$ 24,14 AV: R\$ 24,14 15: R\$ 24,64
30: R\$ 25,13 45: R\$ 25,64 60: R\$ 26,15



FITA DEC 63MMX10MTS OURO ESTAMP
Código: Fábrica: Unidade:
43377 VMP RL/1
F1 F4

UN: R\$ 11,29 AV: R\$ 11,29 15: R\$ 11,52
30: R\$ 11,75 45: R\$ 11,99 60: R\$ 12,23



FITA DECORATIVA 15MMX50MTS 01 BRANCO
Código: Fábrica: Unidade:
31522 NIZURI RL/1
F1 F4

UN: R\$ 11,29 AV: R\$ 11,29 15: R\$ 11,52
30: R\$ 11,75 45: R\$ 11,99 60: R\$ 12,23



FITA DECORATIVA 15MMX50MTS 11 DOURADO
Código: Fábrica: Unidade:
31524 NIZURI RL/1
F1 F4

UN: R\$ 11,29 AV: R\$ 11,29 15: R\$ 11,52
30: R\$ 11,75 45: R\$ 11,99 60: R\$ 12,23



FITA DECORATIVA 15MMX50MTS 12 ROSA PINK
Código: Fábrica: Unidade:
31526 NIZURI RL/1
F1 F4

UN: R\$ 11,29 AV: R\$ 11,29 15: R\$ 11,52
30: R\$ 11,75 45: R\$ 11,99 60: R\$ 12,23



FITA DECORATIVA 15MMX50MTS 15 LILAS
Código: Fábrica: Unidade:
32982 NIZURI RL/1
F1 F4

UN: R\$ 11,29 AV: R\$ 11,29 15: R\$ 11,52
30: R\$ 11,75 45: R\$ 11,99 60: R\$ 12,23



FITA DECORATIVA 15MMX50MTS 19 PRETO
Código: Fábrica: Unidade:
31528 NIZURI RL/1
F1 F4

UN: R\$ 11,29 AV: R\$ 11,29 15: R\$ 11,52
30: R\$ 11,75 45: R\$ 11,99 60: R\$ 12,23



FITA DECORATIVA 15MMX50MTS 20 VERDE LIMA
Código: Fábrica: Unidade:
32981 NIZURI RL/1
F1 F4

UN: R\$ 11,29 AV: R\$ 11,29 15: R\$ 11,52
30: R\$ 11,75 45: R\$ 11,99 60: R\$ 12,23



FITA DECORATIVA 15MMX50MTS 22 ROSA
Código: Fábrica: Unidade:
31529 NIZURI RL/1
F1 F4

UN: R\$ 13,34 AV: R\$ 13,34 15: R\$ 13,62
30: R\$ 13,89 45: R\$ 14,17 60: R\$ 14,46



FITA DECORATIVA 21MMX50MTS 01 BRANCO
Código: Fábrica: Unidade:
32984 NIZURI RL/1
F1 F4

UN: R\$ 19,51 AV: R\$ 19,51 15: R\$ 19,91
30: R\$ 20,31 45: R\$ 20,72 60: R\$ 21,13



FITA DECORATIVA 30MMX50MTS 01 BRANCO
Código: Fábrica: Unidade:
47175 NIZURI/RAIO RL/1
F1 F4

UN: R\$ 19,51 AV: R\$ 19,51 15: R\$ 19,91
30: R\$ 20,31 45: R\$ 20,72 60: R\$ 21,13



FITA DECORATIVA 30MMX50MTS 11 DOURADO
Código: Fábrica: Unidade:
47180 NIZURI/RAIO RL/1
F1 F4

UN: R\$ 19,51 AV: R\$ 19,51 15: R\$ 19,91
30: R\$ 20,31 45: R\$ 20,72 60: R\$ 21,13



FITA DECORATIVA 30MMX50MTS 12 PINK
Código: Fábrica: Unidade:
47181 NIZURI/RAIO RL/1
F1 F4

UN: R\$ 19,51 AV: R\$ 19,51 15: R\$ 19,91
30: R\$ 20,31 45: R\$ 20,72 60: R\$ 21,13



FITA DECORATIVA 30MMX50MTS 17 LILAS
Código: Fábrica: Unidade:
47182 NIZURI/RAIO RL/1
F1 F4

UN: R\$ 19,51 AV: R\$ 19,51 15: R\$ 19,91
30: R\$ 20,31 45: R\$ 20,72 60: R\$ 21,13



FITA DECORATIVA 32MMX50MTS 07 VERDE MILI
Código: Fábrica: Unidade:
47183 NIZURI RL/1
F1 F4

UN: R\$ 19,51 AV: R\$ 19,51 15: R\$ 19,91
30: R\$ 20,31 45: R\$ 20,72 60: R\$ 21,13



FITA DECORATIVA 32MMX50MTS 10 PRATA
Código: Fábrica: Unidade:
47178 NIZURI RL/1
F1 F4

UN: R\$ 19,51 AV: R\$ 19,51 15: R\$ 19,91
30: R\$ 20,31 45: R\$ 20,72 60: R\$ 21,13



FITA DECORATIVA 32MMX50MTS 19 PRETO
Código: Fábrica: Unidade:
47177 NIZURI RL/1
F1 F4

UN: R\$ 20,53 AV: R\$ 20,53 15: R\$ 20,96
30: R\$ 21,38 45: R\$ 21,81 60: R\$ 22,24



FITA DUPLA FACE 5MMX20MT SOLAPA 520
Código: Fábrica: Unidade:
47421 HAI BRASIL UN/1
F1 F4

UN: R\$ 92,44 AV: R\$ 92,44 15: R\$ 94,36
30: R\$ 96,25 45: R\$ 98,18 60: R\$ 100,14



FITA DUPLA FACE ACR INT 19MMX20MTS
Código: Fábrica: Unidade:
50753 TEK BOND UN/1
F1 F4

UN: R\$ 5,24 AV: R\$ 5,24 15: R\$ 5,35
30: R\$ 5,45 45: R\$ 5,56 60: R\$ 5,68



FITA DUPLA FACE ESPUMA 18MMX2M CTL D2
Código: Fábrica: Unidade:
38224 HAI BRASIL CR/1
F1 F4

UN: R\$ 6,67 AV: R\$ 6,67 15: R\$ 6,81
30: R\$ 6,94 45: R\$ 7,08 60: R\$ 7,22



FITA DUPLA FACE ESPUMA 18MMX5M CTL 53007
Código: Fábrica: Unidade:
50127 ALFACELL CR/1
F1 F4

UN: R\$ 11,29 AV: R\$ 11,29 15: R\$ 11,52
30: R\$ 11,75 45: R\$ 11,99 60: R\$ 12,23



FITA DUPLA FACE EXTRA FORTE VERD 24MMX2M
Código: Fábrica: Unidade:
47935 YIN'S PAPER RL/1
F1 F4

UN: R\$ 5,13 AV: R\$ 51,30 15: R\$ 52,37
30: R\$ 53,41 45: R\$ 54,48 60: R\$ 55,57



FITA DUPLA FACE 12MMX30MTS 581 10X1
Código: Fábrica: Unidade:
49889 ALLTAPE PT/10
F1 F4

UN: R\$ 14,37 AV: R\$ 14,37 15: R\$ 14,67
30: R\$ 14,96 45: R\$ 15,26 60: R\$ 15,57



FITA DUPLA FACE 18MMX2MTS SILICONE CTL
Código: Fábrica: Unidade:
45539 WINMAX UN/1
F1 F4

UN: R\$ 7,70 AV: R\$ 46,21 15: R\$ 47,18
30: R\$ 48,12 45: R\$ 49,08 60: R\$ 50,06



FITA DUPLA FACE 18MMX30MTS 581 6X1
Código: Fábrica: Unidade:
50306 ALLTAPE PT/6
F1 F4

UN: R\$ 6,43 AV: R\$ 6,43 15: R\$ 6,56
30: R\$ 6,70 45: R\$ 6,83 60: R\$ 6,97



FITA MAQUINA ESCRIVER OLIVETTI 13X8MM
Código: Fábrica: Unidade:
45123 MASTERPRINT UN/1
F1 F4

UN: R\$ 9,24 AV: R\$ 92,44 15: R\$ 94,36
30: R\$ 96,25 45: R\$ 98,18 60: R\$ 100,14

UN: R\$ 9,24 AV: R\$ 92,44 15: R\$ 94,36
30: R\$ 96,25 45: R\$ 98,18 60: R\$ 100,14

UN: R\$ 18,38 AV: R\$ 18,38 15: R\$ 18,76
30: R\$ 19,13 45: R\$ 19,52 60: R\$ 19,91

UN: R\$ 7,18 AV: R\$ 7,18 15: R\$ 7,33
30: R\$ 7,48 45: R\$ 7,63 60: R\$ 7,78



FITA METALOIDE 15MMX50MTS HOLOGRAFI 10X1
Código: Fábrica: Unidade:
36610 BRW RL/10
F1 F4



FITA METALOIDE 15MMX50MTS VERDE 6X1
Código: Fábrica: Unidade:
35349 BRW RL/10
F1 F4



FITA NYLON P/IMPRESSORA MATRICIAL LX350
Código: Fábrica: Unidade:
44332 MASTERPRINT UN/1
F1 F4



FITA P/CALCULADORA SHARP PRETA/VERMELHO
Código: Fábrica: Unidade:
47221 MASTERPRINT UN/1
F1 F4

UN: R\$ 30,81 AV: R\$ 30,81 15: R\$ 31,45
30: R\$ 32,08 45: R\$ 32,72 60: R\$ 33,37



FITA P/IMPRESSORA EPSON FX2190 13MMX14MT

Código: 41956 Fábrica: MASTERPRINT Unidade: UN/1 F1 F4

UN: R\$ 12,22 AV: R\$ 12,22 15: R\$ 12,48
30: R\$ 12,73 45: R\$ 12,98 60: R\$ 13,24



FITA P/IMPRESSORA EPSON MX80 MATRICIAL

Código: 14350 Fábrica: MASTERPRINT Unidade: UN/1 F1 F4

UN: R\$ 2,98 AV: R\$ 29,78 15: R\$ 30,40
30: R\$ 31,01 45: R\$ 31,63 60: R\$ 32,26



FITILHO DECORAT 5MMX50MTS AMARELO 10X1

Código: 18286 Fábrica: SAO VITOR Unidade: PT/10 F1 F4

UN: R\$ 2,98 AV: R\$ 29,78 15: R\$ 30,40
30: R\$ 31,01 45: R\$ 31,63 60: R\$ 32,26



FITILHO DECORAT 5MMX50MTS AZUL BB 10X1

Código: 34561 Fábrica: SAO VITOR Unidade: PT/10 F1 F4

UN: R\$ 2,98 AV: R\$ 29,78 15: R\$ 30,40
30: R\$ 31,01 45: R\$ 31,63 60: R\$ 32,26



FITILHO DECORAT 5MMX50MTS AZUL 10X1

Código: 18284 Fábrica: SAO VITOR Unidade: PT/10 F1 F4

UN: R\$ 2,98 AV: R\$ 29,78 15: R\$ 30,40
30: R\$ 31,01 45: R\$ 31,63 60: R\$ 32,26



FITILHO DECORAT 5MMX50MTS BRANCO 10X1

Código: 18279 Fábrica: SAO VITOR Unidade: PT/10 F1 F4

UN: R\$ 2,98 AV: R\$ 29,78 15: R\$ 30,40
30: R\$ 31,01 45: R\$ 31,63 60: R\$ 32,26



FITILHO DECORAT 5MMX50MTS CHAMPAGNE 10X1

Código: 41922 Fábrica: SAO VITOR Unidade: PT/10 F1 F4

UN: R\$ 2,98 AV: R\$ 29,78 15: R\$ 30,40
30: R\$ 31,01 45: R\$ 31,63 60: R\$ 32,26



FITILHO DECORAT 5MMX50MTS DOURADO 10X1

Código: 18278 Fábrica: SAO VITOR Unidade: PT/10 F1 F4

UN: R\$ 2,98 AV: R\$ 29,78 15: R\$ 30,40
30: R\$ 31,01 45: R\$ 31,63 60: R\$ 32,26



FITILHO DECORAT 5MMX50MTS GEMA 10X1

Código: 41877 Fábrica: SAO VITOR Unidade: PT/10 F1 F4

UN: R\$ 2,98 AV: R\$ 29,78 15: R\$ 30,40
30: R\$ 31,01 45: R\$ 31,63 60: R\$ 32,26



FITILHO DECORAT 5MMX50MTS GOIABA 10X1

Código: 41924 Fábrica: SAO VITOR Unidade: PT/10 F1 F4

UN: R\$ 2,98 AV: R\$ 29,78 15: R\$ 30,40
30: R\$ 31,01 45: R\$ 31,63 60: R\$ 32,26



FITILHO DECORAT 5MMX50MTS LARANJA 10X1

Código: 18303 Fábrica: SAO VITOR Unidade: PT/10 F1 F4

UN: R\$ 2,98 AV: R\$ 29,78 15: R\$ 30,40
30: R\$ 31,01 45: R\$ 31,63 60: R\$ 32,26



FITILHO DECORAT 5MMX50MTS LILAS 10X1

Código: 18276 Fábrica: SAO VITOR Unidade: PT/10 F1 F4

UN: R\$ 2,98 AV: R\$ 29,78 15: R\$ 30,40
30: R\$ 31,01 45: R\$ 31,63 60: R\$ 32,26



FITILHO DECORAT 5MMX50MTS MARROM 10X1

Código: 19783 Fábrica: SAO VITOR Unidade: PT/10 F1 F4

UN: R\$ 2,98 AV: R\$ 29,78 15: R\$ 30,40
30: R\$ 31,01 45: R\$ 31,63 60: R\$ 32,26



FITILHO DECORAT 5MMX50MTS PRETO 10X1

Código: 18282 Fábrica: SAO VITOR Unidade: PT/10 F1 F4

UN: R\$ 2,98 AV: R\$ 29,78 15: R\$ 30,40
30: R\$ 31,01 45: R\$ 31,63 60: R\$ 32,26



FITILHO DECORAT 5MMX50MTS ROSA PINK 10X1

Código: 18277 Fábrica: SAO VITOR Unidade: PT/10 F1 F4

UN: R\$ 2,98 AV: R\$ 29,78 15: R\$ 30,40
30: R\$ 31,01 45: R\$ 31,63 60: R\$ 32,26



FITILHO DECORAT 5MMX50MTS ROSA 10X1

Código: 18304 Fábrica: SAO VITOR Unidade: PT/10 F1 F4

UN: R\$ 2,98 AV: R\$ 29,78 15: R\$ 30,40
30: R\$ 31,01 45: R\$ 31,63 60: R\$ 32,26



FITILHO DECORAT 5MMX50MTS ROXO 10X1

Código: Fábrica: Unidade:
41921 SAO VITOR PT/10
F1 F4

UN: R\$ 2,57 AV: R\$ 25,67 15: R\$ 26,20
30: R\$ 26,73 45: R\$ 27,26 60: R\$ 27,81



FITILHO DECORAT 5MMX50MTS RUBRO 10X1

Código: Fábrica: Unidade:
41913 SAO VITOR PT/10
F1 F4

UN: R\$ 2,50 AV: R\$ 24,99 15: R\$ 24,99
30: R\$ 24,99 45: R\$ 24,99 60: R\$ 24,99



FITILHO DECORAT 5MMX50MTS SORTIDO 10X1

Código: Fábrica: Unidade:
18305 SAO VITOR PT/10
F1 F4

UN: R\$ 2,98 AV: R\$ 29,78 15: R\$ 30,40
30: R\$ 31,01 45: R\$ 31,63 60: R\$ 32,26



FITILHO DECORAT 5MMX50MTS VERDE LM 10X1

Código: Fábrica: Unidade:
41911 SAO VITOR PT/10
F1 F4

UN: R\$ 2,98 AV: R\$ 29,78 15: R\$ 30,40
30: R\$ 31,01 45: R\$ 31,63 60: R\$ 32,26



FITILHO DECORAT 5MMX50MTS VERDE MIL 10X1

Código: Fábrica: Unidade:
18287 SAO VITOR PT/10
F1 F4

UN: R\$ 2,98 AV: R\$ 29,78 15: R\$ 30,40
30: R\$ 31,01 45: R\$ 31,63 60: R\$ 32,26



FITILHO DECORAT 5MMX50MTS VERDE OLI 10X1

Código: Fábrica: Unidade:
18288 SAO VITOR PT/10
F1 F4

UN: R\$ 2,98 AV: R\$ 29,78 15: R\$ 30,40
30: R\$ 31,01 45: R\$ 31,63 60: R\$ 32,26



FITILHO DECORAT 5MMX50MTS VERDE 10X1

Código: Fábrica: Unidade:
18274 SAO VITOR PT/10
F1 F4

UN: R\$ 2,98 AV: R\$ 29,78 15: R\$ 30,40
30: R\$ 31,01 45: R\$ 31,63 60: R\$ 32,26



FITILHO DECORAT 5MMX50MTS VERMELHO 10X1

Código: Fábrica: Unidade:
18281 SAO VITOR PT/10
F1 F4

UN: R\$ 2,98 AV: R\$ 29,78 15: R\$ 30,40
30: R\$ 31,01 45: R\$ 31,63 60: R\$ 32,26



FITILHO DECORAT 5MMX50MTS VINHO 10X1

Código: Fábrica: Unidade:
41923 SAO VITOR PT/10
F1 F4

UN: R\$ 11,19 AV: R\$ 11,19 15: R\$ 11,42
30: R\$ 11,65 45: R\$ 11,89 60: R\$ 12,12



FORMA PLAST GELO 12 CUBOS FDO SILIC 0215

Código: Fábrica: Unidade:
40316 WINCY UN/1
F1 F4

UN: R\$ 0,62 AV: R\$ 6,15 15: R\$ 6,28
30: R\$ 6,41 45: R\$ 6,53 60: R\$ 6,67



FOSFORO DE SEGURANCA 10X40

Código: Fábrica: Unidade:
49698 SABIA PT/10
F1 F4

UN: R\$ 0,11 AV: R\$ 11,29 15: R\$ 11,52
30: R\$ 11,75 45: R\$ 11,99 60: R\$ 12,23

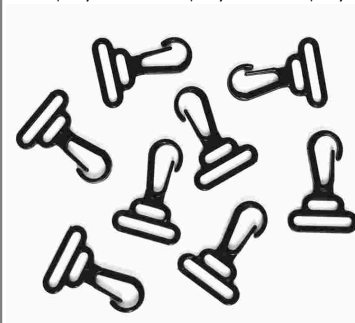

GANCHO PLAST P/CARTAO PRETO 100X1

Código: Fábrica: Unidade:
47735 ITALY'S PT/100
F1 F4

UN: R\$ 2,14 AV: R\$ 25,67 15: R\$ 26,20
30: R\$ 26,73 45: R\$ 27,26 60: R\$ 27,81



GIZ CERA 6 CORES 24 GRS FINO 1018 12X1

Código: Fábrica: Unidade:
42618 SERELEPE PT/12
F1 F4

UN: R\$ 22,25 AV: R\$ 66,76 15: R\$ 68,15
30: R\$ 69,51 45: R\$ 70,90 60: R\$ 72,32



GIZ CERA 6 CORES 185 GRS MEU 1º GIZ 3X1

Código: Fábrica: Unidade:
42135 ACRILEX PT/3
F1 F4

UN: R\$ 5,99 AV: R\$ 71,89 15: R\$ 73,39
30: R\$ 74,86 45: R\$ 76,36 60: R\$ 77,88



GIZ CERA 6 CORES 56 GRS BIG 12X1

Código: Fábrica: Unidade:
42133 ACRILEX PT/12
F1 F4

UN: R\$ 4,21 AV: R\$ 4,21 15: R\$ 4,30
30: R\$ 4,39 45: R\$ 4,47 60: R\$ 4,56



GIZ CERA 12 CORES

Código: Fábrica: Unidade:
34442 SERELEPE UN/1
F1 F4

UN: R\$ 4,28 AV: R\$ 51,35 15: R\$ 52,42
30: R\$ 53,47 45: R\$ 54,54 60: R\$ 55,63



GIZ CERA 12 CORES 48 GRS FINO 1019 12X1
Código: Fábrika: Unidade:
42619 SERELEPE PT/12
F1 F4

UN: R\$ 5,56 AV: R\$ 66,76 15: R\$ 68,15
30: R\$ 69,51 45: R\$ 70,90 60: R\$ 72,32



GIZ CERA 12 CORES 48 GRS 12X1
Código: Fábrika: Unidade:
42137 ACRILEX PT/12
F1 F4

UN: R\$ 8,21 AV: R\$ 8,21 15: R\$ 8,38
30: R\$ 8,55 45: R\$ 8,72 60: R\$ 8,89



GIZ CERA 12 CORES GROSSO GDE 062203
Código: Fábrika: Unidade:
44072 FUTURO CX/1
F1 F4

UN: R\$ 6,94 AV: R\$ 6,94 15: R\$ 7,09
30: R\$ 7,23 45: R\$ 7,37 60: R\$ 7,52



GIZ CERA 12 CORES 118 GRS BIG 4462 UN
Código: Fábrika: Unidade:
46349 LEO&LEO UN/1
F1 F4

UN: R\$ 51,35 AV: R\$ 51,35 15: R\$ 52,42
30: R\$ 53,47 45: R\$ 54,54 60: R\$ 55,63



GIZ CERA 12 CORES 370 GRS JUMBO UN
Código: Fábrika: Unidade:
47437 ACRILEX UN/1
F1 F4

UN: R\$ 42,80 AV: R\$ 128,40 15: R\$ 131,08
30: R\$ 133,70 45: R\$ 136,37 60: R\$ 139,10



GIZ CERA 12 CORES 370 GRS MEU 1º GIZ 3X1
Código: Fábrika: Unidade:
42136 ACRILEX PT/3
F1 F4

UN: R\$ 30,81 AV: R\$ 30,81 15: R\$ 31,45
30: R\$ 32,08 45: R\$ 32,72 60: R\$ 33,37



GIZ CERA 12 CORES 510 GRS BIG 752612
Código: Fábrika: Unidade:
49267 COLORARE CX/1
F1 F4

UN: R\$ 9,42 AV: R\$ 112,98 15: R\$ 115,34
30: R\$ 117,64 45: R\$ 120,00 60: R\$ 122,40



GIZ CERA 12 CORES 95 GRS BIG TRIANG 12X1
Código: Fábrika: Unidade:
42139 ACRILEX PT/12
F1 F4

UN: R\$ 0,14 AV: R\$ 7,18 15: R\$ 7,33
30: R\$ 7,48 45: R\$ 7,63 60: R\$ 7,78



GIZ ESCOLAR BRANCO ANTIALÉRGICO 50X1
Código: Fábrika: Unidade:
24040 DELTA/ZIGGIZ CX/50
F1 F4

UN: R\$ 0,11 AV: R\$ 7,18 15: R\$ 7,33
30: R\$ 7,48 45: R\$ 7,63 60: R\$ 7,78



GIZ ESCOLAR BRANCO ANTIALÉRGICO 64X1
Código: Fábrika: Unidade:
7312 DELTA2 CX/64
F1 F4

UN: R\$ 0,23 AV: R\$ 11,29 15: R\$ 11,52
30: R\$ 11,75 45: R\$ 11,99 60: R\$ 12,23



GIZ ESCOLAR COLORIDO ANTIALÉRGICO 50X1
Código: Fábrika: Unidade:
24041 DELTA CX/50
F1 F4

UN: R\$ 0,13 AV: R\$ 8,21 15: R\$ 8,38
30: R\$ 8,55 45: R\$ 8,72 60: R\$ 8,89



GIZ ESCOLAR COLORIDO 64X1
Código: Fábrika: Unidade:
7395 DELTA CX/64
F1 F4

UN: R\$ 20,53 AV: R\$ 20,53 15: R\$ 20,96
30: R\$ 21,38 45: R\$ 21,81 60: R\$ 22,24



GIZ PASTEL OLEO 12 CORES
Código: Fábrika: Unidade:
46341 CIS UN/1
F1 F4

UN: R\$ 41,08 AV: R\$ 41,08 15: R\$ 41,93
30: R\$ 42,77 45: R\$ 43,63 60: R\$ 44,50



GIZ PASTEL OLEO 24 CORES
Código: Fábrika: Unidade:
47779 CIS UN/1
F1 F4

UN: R\$ 61,62 AV: R\$ 61,62 15: R\$ 62,91
30: R\$ 64,16 45: R\$ 65,45 60: R\$ 66,76



GIZ PASTEL OLEO 36 CORES
Código: Fábrika: Unidade:
47780 CIS UN/1
F1 F4

UN: R\$ 77,03 AV: R\$ 77,03 15: R\$ 78,63
30: R\$ 80,21 45: R\$ 81,81 60: R\$ 83,45



GIZ P/TACO SINUCA BILHAR 144X1
Código: Fábrika: Unidade:
50275 7BELO CX/1
F1 F4

UN: R\$ 13,20 AV: R\$ 13,20 15: R\$ 13,47
30: R\$ 13,74 45: R\$ 14,02 60: R\$ 14,30



GIZAO CERA 6 CORES 230 GRS 1 INFAN 4318
Código: Fábrica: Unidade:
47392 LEO&LEO CX/1
F1 F4

UN: R\$ 0,77 AV: R\$ 9,23 15: R\$ 9,43
30: R\$ 9,62 45: R\$ 9,81 60: R\$ 10,00



GLITER 3 GRS AZUL CLARO 12X1
Código: Fábrica: Unidade:
45060 CITY BRILHO CX/12
F1 F4

UN: R\$ 0,77 AV: R\$ 9,23 15: R\$ 9,43
30: R\$ 9,62 45: R\$ 9,81 60: R\$ 10,00



GLITER 3 GRS AZUL 12X1
Código: Fábrica: Unidade:
7465 CITY BRILHO CX/12
F1 F4

UN: R\$ 0,77 AV: R\$ 9,23 15: R\$ 9,43
30: R\$ 9,62 45: R\$ 9,81 60: R\$ 10,00



GLITER 3 GRS BRANCO PEROLADO 12X1
Código: Fábrica: Unidade:
7468 CITY BRILHO CX/12
F1 F4

UN: R\$ 0,77 AV: R\$ 9,23 15: R\$ 9,43
30: R\$ 9,62 45: R\$ 9,81 60: R\$ 10,00



GLITER 3 GRS DOURADO 12X1
Código: Fábrica: Unidade:
7463 CITY BRILHO CX/12
F1 F4

UN: R\$ 0,77 AV: R\$ 9,23 15: R\$ 9,43
30: R\$ 9,62 45: R\$ 9,81 60: R\$ 10,00



GLITER 3 GRS LARANJA 12X1
Código: Fábrica: Unidade:
26418 CITY BRILHO CX/12
F1 F4

UN: R\$ 0,77 AV: R\$ 9,23 15: R\$ 9,43
30: R\$ 9,62 45: R\$ 9,81 60: R\$ 10,00



GLITER 3 GRS LILAS 12X1
Código: Fábrica: Unidade:
15677 CITY BRILHO CX/12
F1 F4

UN: R\$ 0,77 AV: R\$ 9,23 15: R\$ 9,43
30: R\$ 9,62 45: R\$ 9,81 60: R\$ 10,00



GLITER 3 GRS PINK 12X1
Código: Fábrica: Unidade:
15675 CITY BRILHO CX/12
F1 F4

UN: R\$ 0,77 AV: R\$ 9,23 15: R\$ 9,43
30: R\$ 9,62 45: R\$ 9,81 60: R\$ 10,00



GLITER 3 GRS PRATA 12X1
Código: Fábrica: Unidade:
7464 CITY BRILHO CX/12
F1 F4

UN: R\$ 0,77 AV: R\$ 9,23 15: R\$ 9,43
30: R\$ 9,62 45: R\$ 9,81 60: R\$ 10,00



GLITER 3 GRS PRETO 12X1
Código: Fábrica: Unidade:
12770 CITY BRILHO CX/12
F1 F4

UN: R\$ 0,77 AV: R\$ 9,23 15: R\$ 9,43
30: R\$ 9,62 45: R\$ 9,81 60: R\$ 10,00



GLITER 3 GRS ROSA 12X1
Código: Fábrica: Unidade:
7467 CITY BRILHO CX/12
F1 F4

UN: R\$ 0,77 AV: R\$ 9,23 15: R\$ 9,43
30: R\$ 9,62 45: R\$ 9,81 60: R\$ 10,00



GLITER 3 GRS ROXO 12X1
Código: Fábrica: Unidade:
15676 CITY BRILHO CX/12
F1 F4

UN: R\$ 0,77 AV: R\$ 9,23 15: R\$ 9,43
30: R\$ 9,62 45: R\$ 9,81 60: R\$ 10,00



GLITER 3 GRS SORTIDO 12X1
Código: Fábrica: Unidade:
47723 CITY BRILHO CX/12
F1 F4

UN: R\$ 0,77 AV: R\$ 9,23 15: R\$ 9,43
30: R\$ 9,62 45: R\$ 9,81 60: R\$ 10,00



GLITER 3 GRS VERDE 12X1
Código: Fábrica: Unidade:
7466 CITY BRILHO CX/12
F1 F4

UN: R\$ 0,77 AV: R\$ 9,23 15: R\$ 9,43
30: R\$ 9,62 45: R\$ 9,81 60: R\$ 10,00



GLITER 3 GRS VERMELHO 12X1
Código: Fábrica: Unidade:
26 CITY BRILHO CX/12
F1 F4

UN: R\$ 10,26 AV: R\$ 10,26 15: R\$ 10,48
30: R\$ 10,69 45: R\$ 10,90 60: R\$ 11,12



GLITER 100 GRS AZUL
Código: Fábrica: Unidade:
15534 CITY BRILHO PT/1
F1 F4

UN: R\$ 10,26 AV: R\$ 10,26 15: R\$ 10,48
30: R\$ 10,69 45: R\$ 10,90 60: R\$ 11,12



GLITER 100 GRS LILAS

Código: 9805 Fábrica: CITY BRILHO Unidade: PT/1 F1 F4

UN: R\$ 10,26 AV: R\$ 10,26 15: R\$ 10,48
30: R\$ 10,69 45: R\$ 10,90 60: R\$ 11,12



GLITER 100 GRS PEROLADO

Código: 26345 Fábrica: CITY BRILHO Unidade: PT/1 F1 F4

UN: R\$ 10,26 AV: R\$ 10,26 15: R\$ 10,48
30: R\$ 10,69 45: R\$ 10,90 60: R\$ 11,12



GLITER 100 GRS PINK

Código: 15533 Fábrica: CITY BRILHO Unidade: PT/1 F1 F4

UN: R\$ 10,26 AV: R\$ 10,26 15: R\$ 10,48
30: R\$ 10,69 45: R\$ 10,90 60: R\$ 11,12



GLITER 100 GRS PRATA

Código: 15531 Fábrica: CITY BRILHO Unidade: PT/1 F1 F4

UN: R\$ 10,26 AV: R\$ 10,26 15: R\$ 10,48
30: R\$ 10,69 45: R\$ 10,90 60: R\$ 11,12



GLITER 100 GRS VERMELHO

Código: 15532 Fábrica: CITY BRILHO Unidade: PT/1 F1 F4

UN: R\$ 44,16 AV: R\$ 44,16 15: R\$ 45,08
30: R\$ 45,98 45: R\$ 46,90 60: R\$ 47,84



GLITER 500 GRS AZUL

Código: 42453 Fábrica: CITY BRILHO Unidade: PT/1 F1 F4

UN: R\$ 44,16 AV: R\$ 44,16 15: R\$ 45,08
30: R\$ 45,98 45: R\$ 46,90 60: R\$ 47,84



GLITER 500 GRS AZUL CLARO

Código: 50012 Fábrica: CITY BRILHO Unidade: PT/1 F1 F4

UN: R\$ 44,16 AV: R\$ 44,16 15: R\$ 45,08
30: R\$ 45,98 45: R\$ 46,90 60: R\$ 47,84



GLITER 500 GRS BRONZE

Código: 50010 Fábrica: CITY BRILHO Unidade: PT/1 F1 F4

UN: R\$ 44,16 AV: R\$ 44,16 15: R\$ 45,08
30: R\$ 45,98 45: R\$ 46,90 60: R\$ 47,84



GLITER 500 GRS CHUMBO

Código: 50015 Fábrica: CITY BRILHO Unidade: PT/1 F1 F4

UN: R\$ 44,16 AV: R\$ 44,16 15: R\$ 45,08
30: R\$ 45,98 45: R\$ 46,90 60: R\$ 47,84



GLITER 500 GRS LARANJA

Código: 50014 Fábrica: CITY BRILHO Unidade: PT/1 F1 F4

UN: R\$ 44,16 AV: R\$ 44,16 15: R\$ 45,08
30: R\$ 45,98 45: R\$ 46,90 60: R\$ 47,84



GLITER 500 GRS LILAS

Código: 44168 Fábrica: CITY BRILHO Unidade: PT/1 F1 F4

UN: R\$ 44,16 AV: R\$ 44,16 15: R\$ 45,08
30: R\$ 45,98 45: R\$ 46,90 60: R\$ 47,84



GLITER 500 GRS MARRON

Código: 50011 Fábrica: CITY BRILHO Unidade: PT/1 F1 F4

UN: R\$ 44,16 AV: R\$ 44,16 15: R\$ 45,08
30: R\$ 45,98 45: R\$ 46,90 60: R\$ 47,84



GLITER 500 GRS OURO/AMARELO

Código: 41879 Fábrica: CITY BRILHO Unidade: PT/1 F1 F4

UN: R\$ 44,16 AV: R\$ 44,16 15: R\$ 45,08
30: R\$ 45,98 45: R\$ 46,90 60: R\$ 47,84



GLITER 500 GRS PEROLADO

Código: 41881 Fábrica: CITY BRILHO Unidade: PT/1 F1 F4

UN: R\$ 44,16 AV: R\$ 44,16 15: R\$ 45,08
30: R\$ 45,98 45: R\$ 46,90 60: R\$ 47,84



GLITER 500 GRS PINK

Código: 50009 Fábrica: CITY BRILHO Unidade: PT/1 F1 F4

UN: R\$ 44,16 AV: R\$ 44,16 15: R\$ 45,08
30: R\$ 45,98 45: R\$ 46,90 60: R\$ 47,84



GLITER 500 GRS PRATA

Código: 41880 Fábrica: CITY BRILHO Unidade: PT/1 F1 F4

UN: R\$ 44,16 AV: R\$ 44,16 15: R\$ 45,08
30: R\$ 45,98 45: R\$ 46,90 60: R\$ 47,84



GLITER 500 GRS PRETO

Código: 44167 Fábrica: CITY BRILHO Unidade: PT/1 F1 F4

UN: R\$ 44,16 AV: R\$ 44,16 15: R\$ 45,08
30: R\$ 45,98 45: R\$ 46,90 60: R\$ 47,84



GLITER 500 GRS ROSA

Código: 44133 Fábrica: CITY BRILHO Unidade: PT/1 F1 F4

UN: R\$ 44,16 AV: R\$ 44,16 15: R\$ 45,08
30: R\$ 45,98 45: R\$ 46,90 60: R\$ 47,84



GLITER 500 GRS ROXO

Código: 50008 Fábrica: CITY BRILHO Unidade: PT/1 F1 F4

UN: R\$ 44,16 AV: R\$ 44,16 15: R\$ 45,08
30: R\$ 45,98 45: R\$ 46,90 60: R\$ 47,84



GLITER 500 GRS VERDE

Código: 42454 Fábrica: CITY BRILHO Unidade: PT/1 F1 F4

UN: R\$ 44,16 AV: R\$ 44,16 15: R\$ 45,08
30: R\$ 45,98 45: R\$ 46,90 60: R\$ 47,84



GLITER 500 GRS VERDE CLARO

Código: 50013 Fábrica: CITY BRILHO Unidade: PT/1 F1 F4

UN: R\$ 44,16 AV: R\$ 44,16 15: R\$ 45,08
30: R\$ 45,98 45: R\$ 46,90 60: R\$ 47,84



GLITER 500 GRS VERMELHO

Código: 44169 Fábrica: CITY BRILHO Unidade: PT/1 F1 F4

UN: R\$ 15,31 AV: R\$ 76,53 15: R\$ 78,12
30: R\$ 79,68 45: R\$ 81,28 60: R\$ 82,90



GOLA HIGIENICA BRANCA 6,6CM 5X100

Código: 48138 Fábrica: SEKICH Unidade: PT/5 F1 F4

UN: R\$ 1,28 AV: R\$ 30,82 15: R\$ 31,46
30: R\$ 32,09 45: R\$ 32,73 60: R\$ 33,38



GRAFITE 0.5MM EST 20 MINAS BETTY B 24X1

Código: 38556 Fábrica: TRIS Unidade: CX/24 F1 F4

UN: R\$ 0,64 AV: R\$ 15,40 15: R\$ 15,72
30: R\$ 16,03 45: R\$ 16,35 60: R\$ 16,68



GRAFITE 0.5MM HB COLOR EST 12 MINA 24X1

Código: 47994 Fábrica: MECHANICAL Unidade: CX/24 F1 F4

UN: R\$ 0,86 AV: R\$ 10,26 15: R\$ 10,48
30: R\$ 10,69 45: R\$ 10,90 60: R\$ 11,12



GRAFITE 0.5MM HB EST 12 MINAS 12X1

Código: 43811 Fábrica: WIN PAPER Unidade: PT/12 F1 F4

UN: R\$ 0,86 AV: R\$ 10,26 15: R\$ 10,48
30: R\$ 10,69 45: R\$ 10,90 60: R\$ 11,12



GRAFITE 0.5MM HB EST 12 MINAS 12X1

Código: 18932 Fábrica: GOLLER Unidade: DZ/12 F1 F4

UN: R\$ 0,86 AV: R\$ 10,26 15: R\$ 10,48
30: R\$ 10,69 45: R\$ 10,90 60: R\$ 11,12



GRAFITE 0.5MM HB EST 12 MINAS 12X1

Código: 19716 Fábrica: CONCEPT Unidade: DZ/12 F1 F4

UN: R\$ 0,94 AV: R\$ 11,29 15: R\$ 11,52
30: R\$ 11,75 45: R\$ 11,99 60: R\$ 12,23



GRAFITE 0.5MM HB EST 12 MINAS 12X1

Código: 7157 Fábrica: STYLO Unidade: PT/12 F1 F4

UN: R\$ 0,86 AV: R\$ 10,26 15: R\$ 10,48
30: R\$ 10,69 45: R\$ 10,90 60: R\$ 11,12



GRAFITE 0.5MM HB EST 12 MINAS 12X1

Código: 6772 Fábrica: LEO&LEO Unidade: CX/12 F1 F4

UN: R\$ 0,51 AV: R\$ 12,32 15: R\$ 12,57
30: R\$ 12,82 45: R\$ 13,08 60: R\$ 13,34



GRAFITE 0.5MM HB EST 12 MINAS 24X1

Código: 19561 Fábrica: CLASSE Unidade: CX/24 F1 F4

UN: R\$ 0,51 AV: R\$ 12,32 15: R\$ 12,57
30: R\$ 12,82 45: R\$ 13,08 60: R\$ 13,34



GRAFITE 0.5MM HB EST 20 MINAS 24X1

Código: 47996 Fábrica: HANSA Unidade: CX/24 F1 F4

UN: R\$ 1,03 AV: R\$ 12,32 15: R\$ 12,57
30: R\$ 12,82 45: R\$ 13,08 60: R\$ 13,34



GRAFITE 0.5MM HB EST 24 MINAS 12X1
Código: Fábrica: Unidade:
47995 CLASSE CX/12
F1 F4

UN: R\$ 0,51 AV: R\$ 12,32 15: R\$ 12,57
30: R\$ 12,82 45: R\$ 13,08 60: R\$ 13,34



GRAFITE 0.5MM HB EST 30 MINAS 24X1
Código: Fábrica: Unidade:
19560 CLASSE CX/24
F1 F4

UN: R\$ 0,86 AV: R\$ 10,26 15: R\$ 10,48
30: R\$ 10,69 45: R\$ 10,90 60: R\$ 11,12



GRAFITE 0.5MM 2B EST 12 MINAS 12X1
Código: Fábrica: Unidade:
7160 ADECK CX/12
F1 F4

UN: R\$ 0,28 AV: R\$ 6,68 15: R\$ 6,82
30: R\$ 6,95 45: R\$ 7,09 60: R\$ 7,23



GRAFITE 0.5MM 2B EST 12 MINAS 24X1
Código: Fábrica: Unidade:
13072 CLASSE CX/24
F1 F4

UN: R\$ 1,03 AV: R\$ 12,32 15: R\$ 12,57
30: R\$ 12,82 45: R\$ 13,08 60: R\$ 13,34



GRAFITE 0.5MM 2B EST 24 MINAS 12X1
Código: Fábrica: Unidade:
22178 CLASSE CX/12
F1 F4

UN: R\$ 0,77 AV: R\$ 9,23 15: R\$ 9,43
30: R\$ 9,62 45: R\$ 9,81 60: R\$ 10,00



GRAFITE 0.7MM HB EST 12 MINAS 12X1
Código: Fábrica: Unidade:
2537 LEO&LEO PT/12
F1 F4

UN: R\$ 1,03 AV: R\$ 12,32 15: R\$ 12,57
30: R\$ 12,82 45: R\$ 13,08 60: R\$ 13,34



GRAFITE 0.9MM HB EST 12 MINAS 12X1
Código: Fábrica: Unidade:
46791 UFFIZI CX/12
F1 F4

UN: R\$ 1,03 AV: R\$ 12,32 15: R\$ 12,57
30: R\$ 12,82 45: R\$ 13,08 60: R\$ 13,34



GRAFITE 0.9MM HB EST 12 MINAS 12X1
Código: Fábrica: Unidade:
18699 GOLLER PT/12
F1 F4

UN: R\$ 1,03 AV: R\$ 12,32 15: R\$ 12,57
30: R\$ 12,82 45: R\$ 13,08 60: R\$ 13,34



GRAFITE 0.9MM HB EST 12 MINAS 12X1
Código: Fábrica: Unidade:
47997 LEO&LEO PT/12
F1 F4

UN: R\$ 21,93 AV: R\$ 21,93 15: R\$ 22,39
30: R\$ 22,84 45: R\$ 23,29 60: R\$ 23,76



GRAMPEADOR ALICATE METAL 25F 2153
Código: Fábrica: Unidade:
48849 FIRST UN/1
F1 F4

UN: R\$ 25,67 AV: R\$ 25,67 15: R\$ 26,20
30: R\$ 26,73 45: R\$ 27,26 60: R\$ 27,81



GRAMPEADOR ALICATE METAL 15F+2000GRAM 10
Código: Fábrica: Unidade:
47889 SOON UN/1
F1 F4

UN: R\$ 42,10 AV: R\$ 42,10 15: R\$ 42,98
30: R\$ 43,84 45: R\$ 44,72 60: R\$ 45,61



GRAMPEADOR ALICATE METAL 17CM 26/6 45F
Código: Fábrica: Unidade:
50679 WINPAPER UN/1
F1 F4

UN: R\$ 26,09 AV: R\$ 26,09 15: R\$ 26,63
30: R\$ 27,17 45: R\$ 27,71 60: R\$ 28,26



GRAMPEADOR ALICATE METAL 24/6 20FLS 131
Código: Fábrica: Unidade:
43395 YIZHIWANG UN/1
F1 F4

UN: R\$ 25,67 AV: R\$ 25,67 15: R\$ 26,20
30: R\$ 26,73 45: R\$ 27,26 60: R\$ 27,81



GRAMPEADOR ALICATE METAL 25FLS 93048
Código: Fábrica: Unidade:
39906 JOCAROFFICE UN/1
F1 F4

UN: R\$ 19,51 AV: R\$ 19,51 15: R\$ 19,91
30: R\$ 20,31 45: R\$ 20,72 60: R\$ 21,13



GRAMPEADOR ALICATE METAL 26/6 20FLS 6014
Código: Fábrica: Unidade:
50680 WINPAPER UN/1
F1 F4

UN: R\$ 23,21 AV: R\$ 23,21 15: R\$ 23,70
30: R\$ 24,17 45: R\$ 24,66 60: R\$ 25,15



GRAMPEADOR ALICATE METAL 26/6 25FLS 5227
Código: Fábrica: Unidade:
50208 BAZZE UN/1
F1 F4

UN: R\$ 36,59 AV: R\$ 36,59 15: R\$ 37,35
30: R\$ 38,10 45: R\$ 38,86 60: R\$ 39,64



GRAMPEADOR ALICATE METAL 26/6 25FLS 887
Código: Fábrica: Unidade:
39780 MASTERPRINT UN/1
F1 F4

UN: R\$ 51,35 AV: R\$ 51,35 15: R\$ 52,42
30: R\$ 53,47 45: R\$ 54,54 60: R\$ 55,63



GRAMPEADOR ALICATE METAL 45F 24/26/6 158
Código: Fábrica: Unidade:
47924 YIN'S PAPER UN/1
F1 F4

UN: R\$ 139,69 AV: R\$ 139,69 15: R\$ 142,60
30: R\$ 145,45 45: R\$ 148,36 60: R\$ 151,33

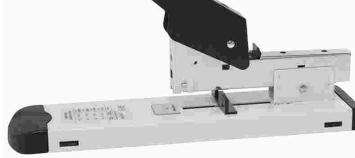

GRAMPEADOR METAL EXTRA G 30CM 100FL 1069
Código: Fábrica: Unidade:
41762 GRAMP LINE UN/1
F1 F4

UN: R\$ 77,03 AV: R\$ 77,03 15: R\$ 78,63
30: R\$ 80,21 45: R\$ 81,81 60: R\$ 83,45



GRAMPEADOR METAL EXTRA GDE 100FLS 29CM
Código: Fábrica: Unidade:
41736 MASTERPRINT UN/1
F1 F4

UN: R\$ 9,75 AV: R\$ 9,75 15: R\$ 9,95
30: R\$ 10,15 45: R\$ 10,35 60: R\$ 10,56



GRAMPEADOR METAL MINI C/EXTRAT 16FLS 305
Código: Fábrica: Unidade:
39785 MASTERPRINT UN/1
F1 F4

UN: R\$ 51,35 AV: R\$ 51,35 15: R\$ 52,42
30: R\$ 53,47 45: R\$ 54,54 60: R\$ 55,63



GRAMPEADOR METAL PISTOL 106/6/8 14CM 600
Código: Fábrica: Unidade:
43195 BRW UN/1
F1 F4

UN: R\$ 34,91 AV: R\$ 34,91 15: R\$ 35,64
30: R\$ 36,35 45: R\$ 37,08 60: R\$ 37,82



GRAMPEADOR METAL PISTOL 13/4-8 15CM 6017
Código: Fábrica: Unidade:
50678 WIN PAPER UN/1
F1 F4

UN: R\$ 111,50 AV: R\$ 111,50 15: R\$ 113,83
30: R\$ 116,10 45: R\$ 118,42 60: R\$ 120,79



GRAMPEADOR METAL PROFIS 240FL BM2144
Código: Fábrica: Unidade:
48848 FIRST UN/1
F1 F4

UN: R\$ 48,27 AV: R\$ 48,27 15: R\$ 49,27
30: R\$ 50,26 45: R\$ 51,26 60: R\$ 52,29



GRAMPEADOR METAL 19,5CM 25FLS 400
Código: Fábrica: Unidade:
43394 MASTERPRINT UN/1
F1 F4

UN: R\$ 42,58 AV: R\$ 42,58 15: R\$ 43,46
30: R\$ 44,33 45: R\$ 45,22 60: R\$ 46,12



GRAMPEADOR METAL 20CM 30FLS 93016
Código: Fábrica: Unidade:
45229 JOCAROFFICE UN/1
F1 F4

UN: R\$ 41,08 AV: R\$ 41,08 15: R\$ 41,93
30: R\$ 42,77 45: R\$ 43,63 60: R\$ 44,50



GRAMPEADOR METAL 50FL 613031
Código: Fábrica: Unidade:
48811 BAZZE PT/1
F1 F4

UN: R\$ 43,13 AV: R\$ 43,13 15: R\$ 44,03
30: R\$ 44,91 45: R\$ 45,81 60: R\$ 46,73

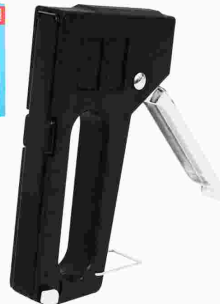

GRAMPEADOR PISTOLA TAPECEIRO 15CM 98931
Código: Fábrica: Unidade:
46426 KAZ UN/1
F1 F4

UN: R\$ 35,46 AV: R\$ 35,46 15: R\$ 36,20
30: R\$ 36,92 45: R\$ 37,66 60: R\$ 38,41



GRAMPEADOR PISTOLA 23/4 13/4 24/6 15CM
Código: Fábrica: Unidade:
50331 FIRST UN/1
F1 F4

UN: R\$ 41,08 AV: R\$ 41,08 15: R\$ 41,93
30: R\$ 42,77 45: R\$ 43,63 60: R\$ 44,50



GRAMPEADOR PROF METAL 13/4-6-8 45FL 6028
Código: Fábrica: Unidade:
50681 WINPAPER UN/1
F1 F4

UN: R\$ 71,89 AV: R\$ 71,89 15: R\$ 73,39
30: R\$ 74,86 45: R\$ 76,36 60: R\$ 77,88



GRAMPEADOR PROF METAL 23/6-8 100FL 6015
Código: Fábrica: Unidade:
50685 WINPAPER UN/1
F1 F4

UN: R\$ 69,75 AV: R\$ 69,75 15: R\$ 71,20
30: R\$ 72,62 45: R\$ 74,08 60: R\$ 75,56



GRAMPEADOR TAPECEIRO 106/6 108/6 16CM 51
Código: Fábrica: Unidade:
50330 FIRST UN/1
F1 F4

UN: R\$ 71,89 AV: R\$ 71,89 15: R\$ 73,39
30: R\$ 74,86 45: R\$ 76,36 60: R\$ 77,88



GRAMPEADOR 106 METAL PROF TAPECARIA 16CM
Código: Fábrika: Unidade:
46382 FUTURO UN/1
F1 F4

UN: R\$ 171,53 AV: R\$ 171,53 15: R\$ 175,11
30: R\$ 178,61 45: R\$ 182,18 60: R\$ 185,82



GRAMPEADOR 23/06 A 23/24 METAL 30CM 240F
Código: Fábrika: Unidade:
46429 KAZ UN/1
F1 F4

UN: R\$ 179,45 AV: R\$ 179,45 15: R\$ 183,19
30: R\$ 186,85 45: R\$ 190,59 60: R\$ 194,40



GRAMPEADOR 23/24 METAL 29CM 240FL 262214
Código: Fábrika: Unidade:
46333 FUTURO UN/1
F1 F4

UN: R\$ 71,89 AV: R\$ 71,89 15: R\$ 73,39
30: R\$ 74,86 45: R\$ 76,36 60: R\$ 77,88



GRAMPEADOR 23/6 23/13 METAL 28,5CM 100FL
Código: Fábrika: Unidade:
44497 DOTAD UN/1
F1 F4

UN: R\$ 203,38 AV: R\$ 203,38 15: R\$ 207,61
30: R\$ 211,76 45: R\$ 216,00 60: R\$ 220,32



GRAMPEADOR 23/6/20/24 METAL 28CM 240FLS
Código: Fábrika: Unidade:
42582 BRW UN/1
F1 F4

UN: R\$ 193,10 AV: R\$ 193,10 15: R\$ 197,13
30: R\$ 201,07 45: R\$ 205,09 60: R\$ 209,19



GRAMPEADOR 23/6/8/10/ METAL 29CM 200FLS
Código: Fábrika: Unidade:
44238 MAXPRINT UN/1
F1 F4

UN: R\$ 92,44 AV: R\$ 92,44 15: R\$ 94,36
30: R\$ 96,25 45: R\$ 98,18 60: R\$ 100,14



GRAMPEADOR 24/6 METAL 27CM 100FL
Código: Fábrika: Unidade:
48435 BAZZE PT/1
F1 F4

UN: R\$ 39,25 AV: R\$ 39,25 15: R\$ 40,07
30: R\$ 40,87 45: R\$ 41,69 60: R\$ 42,52



GRAMPEADOR 24/6 24/8 26/8 METAL 19CM 40F
Código: Fábrika: Unidade:
48355 JOCAROFFICE UN/1
F1 F4

UN: R\$ 17,55 AV: R\$ 17,55 15: R\$ 17,92
30: R\$ 18,28 45: R\$ 18,64 60: R\$ 19,02



GRAMPEADOR 24/6 26/6 METAL MED 15FL V300
Código: Fábrika: Unidade:
39924 VMP UN/1
F1 F4

UN: R\$ 20,53 AV: R\$ 20,53 15: R\$ 20,96
30: R\$ 21,38 45: R\$ 21,81 60: R\$ 22,24



GRAMPEADOR 24/6 26/6 METAL MED 2000
Código: Fábrika: Unidade:
18706 BRW UN/1
F1 F4

UN: R\$ 20,03 AV: R\$ 20,03 15: R\$ 20,45
30: R\$ 20,86 45: R\$ 21,27 60: R\$ 21,70



GRAMPEADOR 24/6 26/6 METAL MED 301
Código: Fábrika: Unidade:
39782 MASTERPRINT UN/1
F1 F4

UN: R\$ 12,72 AV: R\$ 12,72 15: R\$ 12,98
30: R\$ 13,24 45: R\$ 13,51 60: R\$ 13,78



GRAMPEADOR 24/6 26/6 METAL PEQ 20FLS 300
Código: Fábrika: Unidade:
39781 MASTERPRINT UN/1
F1 F4

UN: R\$ 18,48 AV: R\$ 18,48 15: R\$ 18,86
30: R\$ 19,24 45: R\$ 19,63 60: R\$ 20,02



GRAMPEADOR 24/6 26/6 METAL 10CM 25FL
Código: Fábrika: Unidade:
50028 BAZZE UN/1
F1 F4

UN: R\$ 35,94 AV: R\$ 35,94 15: R\$ 36,69
30: R\$ 37,42 45: R\$ 38,17 60: R\$ 38,94



GRAMPEADOR 24/6 26/6 METAL 16CM 40FL
Código: Fábrika: Unidade:
48321 BAZZE UN/1
F1 F4

UN: R\$ 41,08 AV: R\$ 41,08 15: R\$ 41,93
30: R\$ 42,77 45: R\$ 43,63 60: R\$ 44,50



GRAMPEADOR 24/6 26/6 METAL 20CM 30FLS
Código: Fábrika: Unidade:
46381 FUTURO UN/1
F1 F4

UN: R\$ 14,12 AV: R\$ 14,12 15: R\$ 14,42
30: R\$ 14,71 45: R\$ 15,00 60: R\$ 15,30



GRAMPEADOR 24/6 26/6 METAL 20FLS 1000
Código: Fábrika: Unidade:
41084 BRW UN/1
F1 F4

UN: R\$ 44,16 AV: R\$ 44,16 15: R\$ 45,08
30: R\$ 45,98 45: R\$ 46,90 60: R\$ 47,84



GRAMPEADOR 24/6 26/6 METAL 30 FLS GDE
Código: Fábrica: Unidade:
42457 GATTE UN/1
F1 F4

UN: R\$ 29,99 AV: R\$ 29,99 15: R\$ 29,99
30: R\$ 29,99 45: R\$ 29,99 60: R\$ 29,99



GRAMPEADOR 24/6 26/6 METAL 50F 16CM 2137
Código: Fábrica: Unidade:
48842 FIRST UN/1
F1 F4

UN: R\$ 30,81 AV: R\$ 30,81 15: R\$ 31,45
30: R\$ 32,08 45: R\$ 32,72 60: R\$ 33,37



GRAMPEADOR 24/6/26/6 METAL 15CM 20F 2001
Código: Fábrica: Unidade:
44994 BRW UN/1
F1 F4

UN: R\$ 51,35 AV: R\$ 51,35 15: R\$ 52,42
30: R\$ 53,47 45: R\$ 54,54 60: R\$ 55,63



GRAMPEADOR 24/6/26/6 METAL 20CM 30F 1110
Código: Fábrica: Unidade:
43854 LIKE UN/1
F1 F4

UN: R\$ 46,21 AV: R\$ 46,21 15: R\$ 47,18
30: R\$ 48,12 45: R\$ 49,08 60: R\$ 50,06



GRAMPEADOR 24/6/26/6 METAL 20CM 30F 3001
Código: Fábrica: Unidade:
43194 BRW UN/1
F1 F4

UN: R\$ 26,70 AV: R\$ 26,70 15: R\$ 27,25
30: R\$ 27,80 45: R\$ 28,35 60: R\$ 28,92



GRAMPEADOR 24/6/26/6 METAL 20CM 30F 6012
Código: Fábrica: Unidade:
50682 WINPAPER UN/1
F1 F4

UN: R\$ 45,19 AV: R\$ 45,19 15: R\$ 46,13
30: R\$ 47,05 45: R\$ 47,99 60: R\$ 48,95



GRAMPEADOR 24/6-8 26/6 METAL 16CM 50FL
Código: Fábrica: Unidade:
46428 KAZ UN/1
F1 F4

UN: R\$ 67,78 AV: R\$ 67,78 15: R\$ 69,20
30: R\$ 70,58 45: R\$ 71,99 60: R\$ 73,43



GRAMPEADOR 24/6/8 26/6/8 METAL 50FL 3002
Código: Fábrica: Unidade:
43187 BRW UN/1
F1 F4

UN: R\$ 43,13 AV: R\$ 43,13 15: R\$ 44,03
30: R\$ 44,91 45: R\$ 45,81 60: R\$ 46,73



GRAMPEADOR 26/6 METAL 20CM 40FL 7317
Código: Fábrica: Unidade:
46427 KAZ UN/1
F1 F4

UN: R\$ 9,23 AV: R\$ 9,23 15: R\$ 9,43
30: R\$ 9,62 45: R\$ 9,81 60: R\$ 10,00



GRAMPO GRAMPEADOR COBREADO 26/6 5000X1
Código: Fábrica: Unidade:
24962 JOCAROFFICE CX/1
F1 F4

UN: R\$ 7,18 AV: R\$ 7,18 15: R\$ 7,33
30: R\$ 7,48 45: R\$ 7,63 60: R\$ 7,78



GRAMPO GRAMPEADOR COBREADO 26/6 5000X1
Código: Fábrica: Unidade:
48322 BAZZE CX/1
F1 F4

UN: R\$ 9,81 AV: R\$ 9,81 15: R\$ 10,01
30: R\$ 10,21 45: R\$ 10,42 60: R\$ 10,63

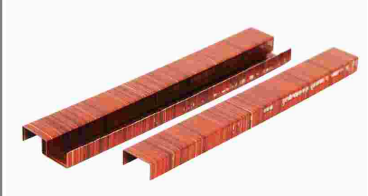

GRAMPO GRAMPEADOR COBREADO 26/6 5000X1
Código: Fábrica: Unidade:
46518 LVC CX/1
F1 F4

UN: R\$ 5,83 AV: R\$ 5,83 15: R\$ 5,96
30: R\$ 6,08 45: R\$ 6,20 60: R\$ 6,32

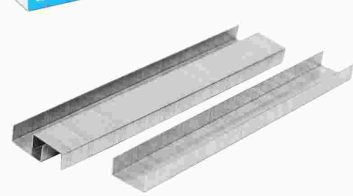

GRAMPO GRAMPEADOR GALV 26/6 5000X1
Código: Fábrica: Unidade:
19708 CIS CX/1
F1 F4

UN: R\$ 0,01 AV: R\$ 9,96 15: R\$ 10,17
30: R\$ 10,37 45: R\$ 10,58 60: R\$ 10,79



GRAMPO GRAMPEADOR GALV 9/12 1000X1
Código: Fábrica: Unidade:
44191 BACCHI CX/1000
F1 F4

UN: R\$ 14,64 AV: R\$ 14,64 15: R\$ 14,94
30: R\$ 15,24 45: R\$ 15,55 60: R\$ 15,86

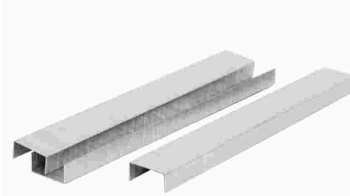

GRAMPO GRAMPEADOR GALV 160/6 1124 3500X1
Código: Fábrica: Unidade:
49134 JOCAROFFICE CX/1
F1 F4

UN: R\$ 4,66 AV: R\$ 4,66 15: R\$ 4,76
30: R\$ 4,86 45: R\$ 4,95 60: R\$ 5,05

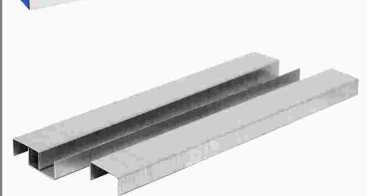

GRAMPO GRAMPEADOR GALV 26/6 5000 5000X1
Código: Fábrica: Unidade:
49154 BRW CX/1
F1 F4

UN: R\$ 5,74 AV: R\$ 5,74 15: R\$ 5,86
30: R\$ 5,98 45: R\$ 6,10 60: R\$ 6,22

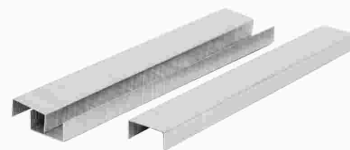

GRAMPO GRAMPEADOR GALV 26/6 93010 5000X1
Código: Fábrika: Unidade:
48351 JOCAROFFICE CX/1
F1 F4

UN: R\$ 0,01 AV: R\$ 5,76 15: R\$ 5,88
30: R\$ 6,00 45: R\$ 6,12 60: R\$ 6,24

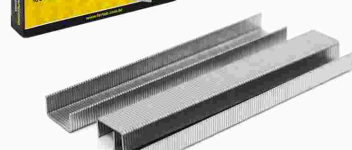

GRAMPO GRAMPEADOR GALV 6MM TAPECE 1000X1
Código: Fábrika: Unidade:
48061 FERTAK CX/1000
F1 F4

UN: R\$ 0,01 AV: R\$ 5,62 15: R\$ 5,74
30: R\$ 5,85 45: R\$ 5,97 60: R\$ 6,09

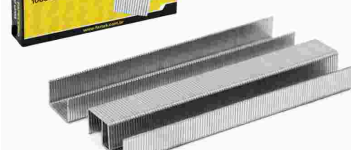

GRAMPO GRAMPEADOR GALV 8MM TAPECE 1000X1
Código: Fábrika: Unidade:
48062 FERTAK CX/1000
F1 F4

UN: R\$ 27,72 AV: R\$ 27,72 15: R\$ 28,30
30: R\$ 28,87 45: R\$ 29,45 60: R\$ 30,03



GRAMPO GRAMPEADOR GALVAN 23/10 5000X1
Código: Fábrika: Unidade:
42150 BRW CX/1
F1 F4

UN: R\$ 32,86 AV: R\$ 32,86 15: R\$ 33,54
30: R\$ 34,22 45: R\$ 34,90 60: R\$ 35,60



GRAMPO GRAMPEADOR GALVAN 23/13 5000X1
Código: Fábrika: Unidade:
41759 BRW CX/1
F1 F4

UN: R\$ 9,54 AV: R\$ 9,54 15: R\$ 9,74
30: R\$ 9,94 45: R\$ 10,14 60: R\$ 10,34

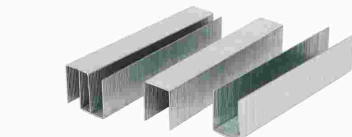

GRAMPO GRAMPEADOR GALVAN 23/17 1000X1
Código: Fábrika: Unidade:
44987 BRW CX/1
F1 F4

UN: R\$ 36,33 AV: R\$ 36,33 15: R\$ 37,09
30: R\$ 37,83 45: R\$ 38,59 60: R\$ 39,36

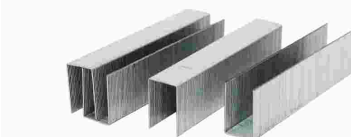

GRAMPO GRAMPEADOR GALVAN 23/20 1000X1
Código: Fábrika: Unidade:
44988 BRW CX/1
F1 F4

UN: R\$ 0,03 AV: R\$ 26,09 15: R\$ 26,63
30: R\$ 27,17 45: R\$ 27,71 60: R\$ 28,26

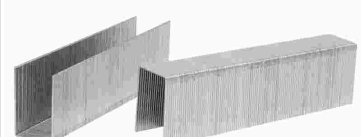

GRAMPO GRAMPEADOR GALVAN 23/20 1000X1
Código: Fábrika: Unidade:
44190 BACCHI CX/1000
F1 F4

UN: R\$ 24,29 AV: R\$ 24,29 15: R\$ 24,80
30: R\$ 25,30 45: R\$ 25,80 60: R\$ 26,32

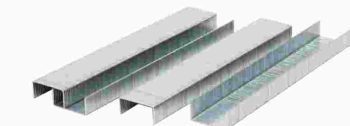

GRAMPO GRAMPEADOR GALVAN 23/6 5000X1
Código: Fábrika: Unidade:
44989 BRW CX/1
F1 F4

UN: R\$ 0,01 AV: R\$ 31,83 15: R\$ 32,50
30: R\$ 33,15 45: R\$ 33,81 60: R\$ 34,49



GRAMPO GRAMPEADOR GALVAN 23/8 5000X1
Código: Fábrika: Unidade:
43247 BACCHI CX/5000
F1 F4

UN: R\$ 0,01 AV: R\$ 5,86 15: R\$ 5,98
30: R\$ 6,10 45: R\$ 6,22 60: R\$ 6,34



GRAMPO GRAMPEADOR GALVAN 24/6 1000X1
Código: Fábrika: Unidade:
44192 BACCHI CX/1000
F1 F4

UN: R\$ 2,05 AV: R\$ 2,05 15: R\$ 2,10
30: R\$ 2,14 45: R\$ 2,18 60: R\$ 2,23

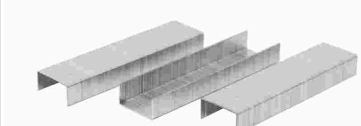

GRAMPO GRAMPEADOR GALVAN 26/6 1000X1
Código: Fábrika: Unidade:
47388 JOCAROFFICE CX/1
F1 F4

UN: R\$ 1,69 AV: R\$ 1,69 15: R\$ 1,73
30: R\$ 1,76 45: R\$ 1,80 60: R\$ 1,84



GRAMPO GRAMPEADOR GALVAN 26/6 1000X1
Código: Fábrika: Unidade:
50033 BAZZE CX/1
F1 F4

UN: R\$ 5,13 AV: R\$ 5,13 15: R\$ 5,23
30: R\$ 5,34 45: R\$ 5,44 60: R\$ 5,55

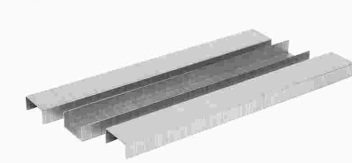

GRAMPO GRAMPEADOR GALVAN 26/6 5000X1
Código: Fábrika: Unidade:
18293 MASTER/NINES CX/1
F1 F4

UN: R\$ 10,94 AV: R\$ 10,94 15: R\$ 11,17
30: R\$ 11,39 45: R\$ 11,62 60: R\$ 11,85

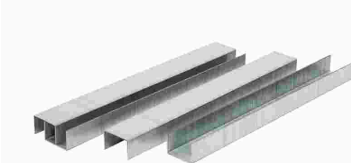

GRAMPO GRAMPEADOR GALVAN 26/8 5000X1
Código: Fábrika: Unidade:
44990 BRW CX/1
F1 F4

UN: R\$ 17,80 AV: R\$ 17,80 15: R\$ 18,17
30: R\$ 18,54 45: R\$ 18,91 60: R\$ 19,28



GRAMPO GRAMPEADOR GALVAN 106/6 3500X1
Código: Fábrika: Unidade:
43190 BRW CX/1
F1 F4

UN: R\$ 20,53 AV: R\$ 20,53 15: R\$ 20,96
30: R\$ 21,38 45: R\$ 21,81 60: R\$ 22,24

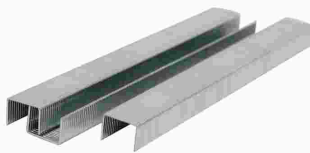

GRAMPO GRAMPEADOR GALVAN 106/8 2500X1
Código: Fábrika: Unidade:
46835 WIN PAPER CX/1
F1 F4

UN: R\$ 18,10 AV: R\$ 18,10 15: R\$ 18,48
30: R\$ 18,85 45: R\$ 19,22 60: R\$ 19,61



GRAMPO GRAMPEADOR GALVAN 106/8 3000X1
Código: Fábrika: Unidade:
43192 BRW CX/1
F1 F4

UN: R\$ 7,18 AV: R\$ 7,18 15: R\$ 7,33
30: R\$ 7,48 45: R\$ 7,63 60: R\$ 7,78

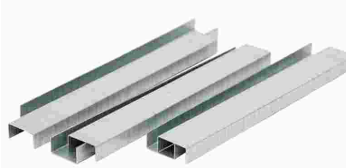

GRAMPO GRAMPEADOR GALVAN 26/6 5000X1
Código: Fábrika: Unidade:
45391 NOX CX/1
F1 F4

AV: R\$ 6,15 15: R\$ 6,28
30: R\$ 6,41 45: R\$ 6,53 60: R\$ 6,67

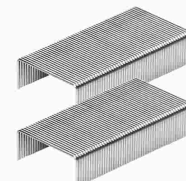

GRAMPO GRAMPEADOR GALVAN 26/6 5000X1
Código: Fábrika: Unidade:
49961 BAZZE CX/5000
F1 F4

UN: R\$ 5,99 AV: R\$ 5,99 15: R\$ 5,99
30: R\$ 5,99 45: R\$ 5,99 60: R\$ 5,99

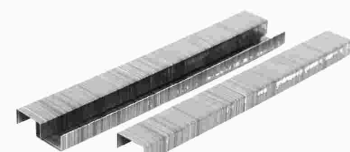

GRAMPO GRAMPEADOR GALVAN 26/6 5000X1
Código: Fábrika: Unidade:
46517 LVC CX/1
F1 F4

UN: R\$ 0,48 AV: R\$ 5,75 15: R\$ 5,87
30: R\$ 5,99 45: R\$ 6,11 60: R\$ 6,23

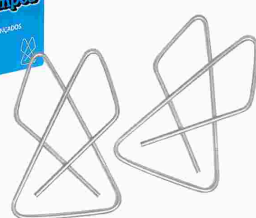

GRAMPO TRANCADO GALVAN 1 METAL 12X1
Código: Fábrika: Unidade:
44184 BACCHI CX/12
F1 F4

UN: R\$ 0,22 AV: R\$ 10,94 15: R\$ 11,17
30: R\$ 11,39 45: R\$ 11,62 60: R\$ 11,85

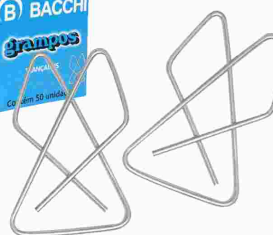

GRAMPO TRANCADO GALVAN 2 METAL 50X1
Código: Fábrika: Unidade:
44185 BACCHI CX/50
F1 F4

UN: R\$ 0,35 AV: R\$ 17,41 15: R\$ 17,77
30: R\$ 18,12 45: R\$ 18,49 60: R\$ 18,86



GRAMPO TRILHO GALVAN 80MM P/PASTA 50X1
Código: Fábrika: Unidade:
11063 JOCAROFFICE CX/50
F1 F4

UN: R\$ 0,22 AV: R\$ 10,99 15: R\$ 10,99
30: R\$ 10,99 45: R\$ 10,99 60: R\$ 10,99

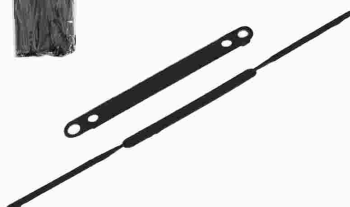

GRAMPO TRILHO PLAST 20CM P/PASTA PT 50X1
Código: Fábrika: Unidade:
44446 POLYCART PT/50
F1 F4

UN: R\$ 0,35 AV: R\$ 17,45 15: R\$ 17,82
30: R\$ 18,17 45: R\$ 18,54 60: R\$ 18,91

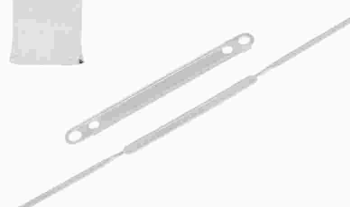

GRAMPO TRILHO PLAST 20CM P/PASTA 50X1
Código: Fábrika: Unidade:
42020 WALEU PT/50
F1 F4

UN: R\$ 0,50 AV: R\$ 25,01 15: R\$ 25,53
30: R\$ 26,04 45: R\$ 26,56 60: R\$ 27,09



GRAMPO TRILHO PLAST 30CM BC P/PASTA 50X1
Código: Fábrika: Unidade:
47243 FIX PAPER PT/50
F1 F4

UN: R\$ 1,93 AV: R\$ 3,85 15: R\$ 3,93
30: R\$ 4,01 45: R\$ 4,09 60: R\$ 4,17



GRIP P/LAPIS OU CANETA CANDY 8583 2X1
Código: Fábrika: Unidade:
48143 YIN'S PAPER CR/2
F1 F4

UN: R\$ 0,15 AV: R\$ 3,07 15: R\$ 3,14
30: R\$ 3,20 45: R\$ 3,26 60: R\$ 3,33



GUARDANAPO PAPEL 33CM P/DECOUP 1304 20X1
Código: Fábrika: Unidade:
44741 ROCIE PT/20
F1 F4

UN: R\$ 0,86 AV: R\$ 17,15 15: R\$ 17,51
30: R\$ 17,86 45: R\$ 18,22 60: R\$ 18,58



GUARDANAPO PAPEL 33X33CM P/DECOUP 20X1
Código: Fábrika: Unidade:
50079 BOMPACK PT/20
F1 F4

UN: R\$ 152,02 AV: R\$ 152,02 15: R\$ 155,18
30: R\$ 158,29 45: R\$ 161,45 60: R\$ 164,68



GUILHOTINA PAPEL A4/A5 10 FLS 7891
Código: Fábrika: Unidade:
46922 YIN'S PAPER UN/1
F1 F4

UN: R\$ 308,15 AV: R\$ 308,15 15: R\$ 314,57
30: R\$ 320,86 45: R\$ 327,28 60: R\$ 333,82



GUILHOTINA PAPEL 10FLS GPM200 BEGE
Código: Fábrika: Unidade:
44285 MENNO UN/1
F1 F4

UN: R\$ 297,88 AV: R\$ 297,88 15: R\$ 304,08
30: R\$ 310,17 45: R\$ 316,37 60: R\$ 322,70



GUILHOTINA REFILADORA PAPEL 10FLS

Código: Fábrika: Unidade:
46387 KAZ UN/1
F1 F4

UN: R\$ 1,03 AV: R\$ 22,59 15: R\$ 23,06
30: R\$ 23,52 45: R\$ 23,99 60: R\$ 24,47



INDICE PAPEL CARTOLINA 3X5 A/Z 3039

Código: Fábrika: Unidade:
44286 MENNO PT/22
F1 F4

UN: R\$ 1,18 AV: R\$ 25,89 15: R\$ 26,42
30: R\$ 26,95 45: R\$ 27,49 60: R\$ 28,04

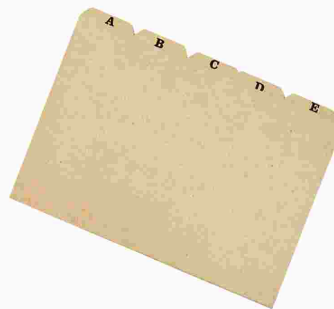

INDICE PAPEL CARTOLINA 4X6 A/Z 3072

Código: Fábrika: Unidade:
44287 MENNO PT/22
F1 F4

UN: R\$ 1,33 AV: R\$ 29,28 15: R\$ 29,89
30: R\$ 30,48 45: R\$ 31,09 60: R\$ 31,71

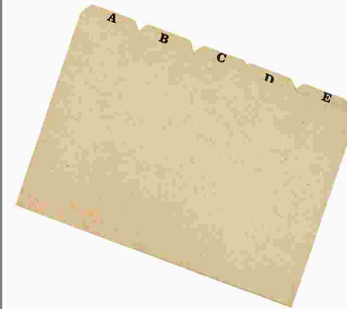

INDICE PAPEL CARTOLINA 5X8 A/Z 3074

Código: Fábrika: Unidade:
44288 MENNO PT/22
F1 F4

UN: R\$ 25,67 AV: R\$ 25,67 15: R\$ 26,20
30: R\$ 26,73 45: R\$ 27,26 60: R\$ 27,81

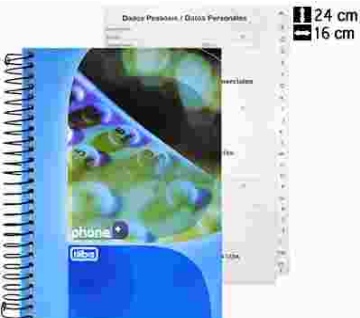

INDICE TELEFONICO CD PHONE 64 FLS 1236

Código: Fábrika: Unidade:
14634 TILIBRA UN/1
F1 F4

UN: R\$ 2,05 AV: R\$ 2,05 15: R\$ 2,10
30: R\$ 2,14 45: R\$ 2,18 60: R\$ 2,23



INDICE TELEFONICO MED ACRILICO

Código: Fábrika: Unidade:
2541 IMPORTADO UN/1
F1 F4

UN: R\$ 12,14 AV: R\$ 12,14 15: R\$ 12,39
30: R\$ 12,64 45: R\$ 12,90 60: R\$ 13,15



KIT DESENHO MALETA PINTURA 24 PCS 23728

Código: Fábrika: Unidade:
49148 IMPBRINK CJ/1
F1 F4

UN: R\$ 17,10 AV: R\$ 17,10 15: R\$ 17,46
30: R\$ 17,81 45: R\$ 18,16 60: R\$ 18,53



KIT DESENHO MALETA PINTURA 42 PCS 23729

Código: Fábrika: Unidade:
49149 IMPBRINK CJ/1
F1 F4

UN: R\$ 10,36 AV: R\$ 10,36 15: R\$ 10,58
30: R\$ 10,79 45: R\$ 11,01 60: R\$ 11,23



KIT DESENHO MALETA PINTURA 42 PCS 23730

Código: Fábrika: Unidade:
49150 IMPBRINK CJ/1
F1 F4

UN: R\$ 33,15 AV: R\$ 33,15 15: R\$ 33,84
30: R\$ 34,52 45: R\$ 35,21 60: R\$ 35,91



KIT DESENHO MALETA PINTURA 68 PCS 23731

Código: Fábrika: Unidade:
49151 IMPBRINK CJ/1
F1 F4

UN: R\$ 40,54 AV: R\$ 40,54 15: R\$ 41,39
30: R\$ 42,22 45: R\$ 43,06 60: R\$ 43,92



KIT DESENHO MALETA PINTURA 86 PCS 23732

Código: Fábrika: Unidade:
49152 IMPBRINK CJ/1
F1 F4

UN: R\$ 6,15 AV: R\$ 6,15 15: R\$ 6,28
30: R\$ 6,41 45: R\$ 6,53 60: R\$ 6,67

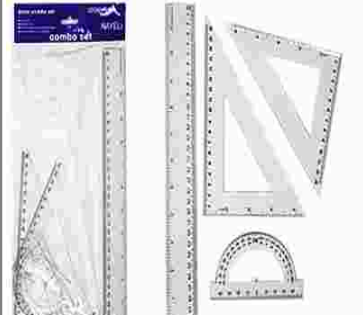

KIT ESCOLAR 1.º GRAU 4 PCS 10130001

Código: Fábrika: Unidade:
24887 WALEU PT/1
F1 F4

UN: R\$ 7,18 AV: R\$ 7,18 15: R\$ 7,33
30: R\$ 7,48 45: R\$ 7,63 60: R\$ 7,78



KIT ESCOLAR 1.º GRAU 4 PCS 2918

Código: Fábrika: Unidade:
40787 PLANETA PT/1
F1 F4

UN: R\$ 7,49 AV: R\$ 7,49 15: R\$ 7,64
30: R\$ 7,80 45: R\$ 7,95 60: R\$ 8,11



KIT ESCOLAR 2.º GRAU 4 PCS 10130002

Código: Fábrika: Unidade:
22765 WALEU PT/1
F1 F4

UN: R\$ 8,52 AV: R\$ 8,52 15: R\$ 8,69
30: R\$ 8,87 45: R\$ 9,04 60: R\$ 9,23



KIT ESCRITORIO (APON/TES/BORR/GRAM) 8861

Código: Fábrika: Unidade:
44751 WIN PAPER UN/1
F1 F4

UN: R\$ 8,21 AV: R\$ 8,21 15: R\$ 8,38
30: R\$ 8,55 45: R\$ 8,72 60: R\$ 8,89



KIT NORMOGRAFO CRISTAL 19MM 14006

Código: Fábrika: Unidade:
44059 MAXCRIL PT/1
F1 F4

UN: R\$ 0,11 AV: R\$ 1,08 15: R\$ 1,10
30: R\$ 1,12 45: R\$ 1,15 60: R\$ 1,17



LACO FACIL 12MMX21CM COLOR 12A 10X1
Código: Fábrica: Unidade:
35988 PULLFLOWER PT/10
F1 F4

UN: R\$ 0,18 AV: R\$ 1,77 15: R\$ 1,80
30: R\$ 1,84 45: R\$ 1,88 60: R\$ 1,91



LACO FACIL 12MMX24CM COLOR 64 10X1
Código: Fábrica: Unidade:
45956 WINMAX PT/10
F1 F4

UN: R\$ 0,14 AV: R\$ 1,37 15: R\$ 1,39
30: R\$ 1,42 45: R\$ 1,45 60: R\$ 1,48



LACO FACIL 15MMX27CM COLOR 15A 10X1
Código: Fábrica: Unidade:
35989 PULLFLOWER PT/10
F1 F4

UN: R\$ 0,37 AV: R\$ 3,75 15: R\$ 3,83
30: R\$ 3,90 45: R\$ 3,98 60: R\$ 4,06



LACO FACIL 18MMX34CM COLOR 65 10X1
Código: Fábrica: Unidade:
45957 WINMAX PT/10
F1 F4

UN: R\$ 0,41 AV: R\$ 4,10 15: R\$ 4,18
30: R\$ 4,27 45: R\$ 4,35 60: R\$ 4,44



LAMINA P/ESTILETE 09MM ESTREITO 10X1
Código: Fábrica: Unidade:
41608 BRW CR/10
F1 F4

UN: R\$ 0,21 AV: R\$ 20,53 15: R\$ 20,96
30: R\$ 21,38 45: R\$ 21,81 60: R\$ 22,24



LAMINA P/ESTILETE 09MM ESTREITO 10X10
Código: Fábrica: Unidade:
45125 MASTERPRINT CX/100
F1 F4

UN: R\$ 3,90 AV: R\$ 39,02 15: R\$ 39,84
30: R\$ 40,63 45: R\$ 41,45 60: R\$ 42,27



LAMINA P/ESTILETE 18MM LARGO 10X10
Código: Fábrica: Unidade:
45126 MASTERPRINT CX/10
F1 F4

UN: R\$ 0,59 AV: R\$ 5,91 15: R\$ 6,03
30: R\$ 6,15 45: R\$ 6,27 60: R\$ 6,40



LAMINA P/ESTILETE 18MM LARGO 1801 10X1
Código: Fábrica: Unidade:
22804 BRW/MASTER CR/10
F1 F4

UN: R\$ 31,83 AV: R\$ 31,83 15: R\$ 32,50
30: R\$ 33,15 45: R\$ 33,81 60: R\$ 34,49



LANCHEIRA BATTLE LA4658
Código: Fábrica: Unidade:
48989 PONTO VERDE UN/1
F1 F4

UN: R\$ 32,86 AV: R\$ 32,86 15: R\$ 33,54
30: R\$ 34,22 45: R\$ 34,90 60: R\$ 35,60



LANCHEIRA BRANCA DE NEVE LA4628
Código: Fábrica: Unidade:
49031 PONTO VERDE UN/1
F1 F4

UN: R\$ 41,08 AV: R\$ 41,08 15: R\$ 41,93
30: R\$ 42,77 45: R\$ 43,63 60: R\$ 44,50



LANCHEIRA FEM AMANDA&FRIENDS REVELA2190
Código: Fábrica: Unidade:
29618 SBC UN/1
F1 F4

UN: R\$ 21,56 AV: R\$ 21,56 15: R\$ 22,01
30: R\$ 22,45 45: R\$ 22,90 60: R\$ 23,36



LANCHEIRA FEM ANGOLITA E PINTINHOS LA253
Código: Fábrica: Unidade:
28927 SBC UN/1
F1 F4

UN: R\$ 20,54 AV: R\$ 20,54 15: R\$ 20,97
30: R\$ 21,39 45: R\$ 21,82 60: R\$ 22,26



LANCHEIRA FEM BEAUTY FREAKY LA225
Código: Fábrica: Unidade:
28925 SBC UN/1
F1 F4

UN: R\$ 35,94 AV: R\$ 35,94 15: R\$ 36,69
30: R\$ 37,42 45: R\$ 38,17 60: R\$ 38,94



LANCHEIRA FEM BELLA LA3539
Código: Fábrica: Unidade:
34241 SBC UN/1
F1 F4

UN: R\$ 35,94 AV: R\$ 35,94 15: R\$ 36,69
30: R\$ 37,42 45: R\$ 38,17 60: R\$ 38,94



LANCHEIRA FEM CALIFORNIA GIRL LA2948
Código: Fábrica: Unidade:
32143 SBC UN/1
F1 F4

UN: R\$ 41,08 AV: R\$ 41,08 15: R\$ 41,93
30: R\$ 42,77 45: R\$ 43,63 60: R\$ 44,50



LANCHEIRA FEM CALIFORNIA GIRL REL 3026
Código: Fábrica: Unidade:
32144 SBC UN/1
F1 F4

UN: R\$ 41,08 AV: R\$ 41,08 15: R\$ 41,93
30: R\$ 42,77 45: R\$ 43,63 60: R\$ 44,50



LANCHEIRA FEM CALIFORNIA GIRL REL 3150
Código: Fábrica: Unidade:
32329 SBC UN/1
F1 F4

UN: R\$ 20,54 AV: R\$ 20,54 15: R\$ 20,97
30: R\$ 21,39 45: R\$ 21,82 60: R\$ 22,26



LANCHEIRA FEM CRYSTAL PRINCESS REL LA2634
Código: Fábrica: Unidade:
31325 SBC UN/1
F1 F4

UN: R\$ 41,08 AV: R\$ 41,08 15: R\$ 41,93
30: R\$ 42,77 45: R\$ 43,63 60: R\$ 44,50



LANCHEIRA FEM DOLL LA3922
Código: Fábrica: Unidade:
36218 SBC UN/1
F1 F4

UN: R\$ 35,94 AV: R\$ 35,94 15: R\$ 36,69
30: R\$ 37,42 45: R\$ 38,17 60: R\$ 38,94



LANCHEIRA FEM EMOJI LA3254
Código: Fábrica: Unidade:
32303 SBC UN/1
F1 F4

UN: R\$ 41,08 AV: R\$ 41,08 15: R\$ 41,93
30: R\$ 42,77 45: R\$ 43,63 60: R\$ 44,50



LANCHEIRA FEM LITTLE PRINCESS LA3644
Código: Fábrica: Unidade:
34245 SBC UN/1
F1 F4

UN: R\$ 41,08 AV: R\$ 41,08 15: R\$ 41,93
30: R\$ 42,77 45: R\$ 43,63 60: R\$ 44,50



LANCHEIRA FEM LOVE FASHION LA3517
Código: Fábrica: Unidade:
34246 SBC UN/1
F1 F4

UN: R\$ 25,68 AV: R\$ 25,68 15: R\$ 26,22
30: R\$ 26,74 45: R\$ 27,27 60: R\$ 27,82



LANCHEIRA FEM MAGICAL FAIRIES LA165
Código: Fábrica: Unidade:
27856 SBC UN/1
F1 F4

UN: R\$ 35,94 AV: R\$ 35,94 15: R\$ 36,69
30: R\$ 37,42 45: R\$ 38,17 60: R\$ 38,94



LANCHEIRA FEM MAGICAL 2920
Código: Fábrica: Unidade:
32333 SBC UN/1
F1 F4

UN: R\$ 25,68 AV: R\$ 25,68 15: R\$ 26,22
30: R\$ 26,74 45: R\$ 27,27 60: R\$ 27,82



LANCHEIRA FEM MELODY LA985
Código: Fábrica: Unidade:
26658 SBC UN/1
F1 F4

UN: R\$ 35,94 AV: R\$ 35,94 15: R\$ 36,69
30: R\$ 37,42 45: R\$ 38,17 60: R\$ 38,94



LANCHEIRA FEM MY PRINCESS LA183
Código: Fábrica: Unidade:
27798 SBC UN/1
F1 F4

UN: R\$ 34,41 AV: R\$ 34,41 15: R\$ 35,13
30: R\$ 35,83 45: R\$ 36,55 60: R\$ 37,28



LANCHEIRA FEM PEQUENA PRINCESA REL 3038
Código: Fábrica: Unidade:
32332 SBC UN/1
F1 F4

UN: R\$ 41,08 AV: R\$ 41,08 15: R\$ 41,93
30: R\$ 42,77 45: R\$ 43,63 60: R\$ 44,50



LANCHEIRA FEM PEQUENA PRINCESA REL 3144
Código: Fábrica: Unidade:
32330 SBC UN/1
F1 F4

UN: R\$ 41,08 AV: R\$ 41,08 15: R\$ 41,93
30: R\$ 42,77 45: R\$ 43,63 60: R\$ 44,50



LANCHEIRA FEM PET PRINCESS LA 3088
Código: Fábrica: Unidade:
32148 SBC UN/1
F1 F4

UN: R\$ 35,94 AV: R\$ 35,94 15: R\$ 36,69
30: R\$ 37,42 45: R\$ 38,17 60: R\$ 38,94



LANCHEIRA FEM PET PRINCESSS 2934
Código: Fábrica: Unidade:
32331 SBC UN/1
F1 F4

UN: R\$ 35,94 AV: R\$ 35,94 15: R\$ 36,69
30: R\$ 37,42 45: R\$ 38,17 60: R\$ 38,94



LANCHEIRA FEM PIGGY LA2004
Código: Fábrica: Unidade:
29631 SBC UN/1
F1 F4

UN: R\$ 41,08 AV: R\$ 41,08 15: R\$ 41,93
30: R\$ 42,77 45: R\$ 43,63 60: R\$ 44,50



LANCHEIRA FEM PIGGY RELEVÔ LA2402
Código: Fábrica: Unidade:
29700 SBC UN/1
F1 F4

UN: R\$ 25,68 AV: R\$ 25,68 15: R\$ 26,22
30: R\$ 26,74 45: R\$ 27,27 60: R\$ 27,82



LANCHEIRA FEM PINK BALLERINA LA269
Código: Fábrica: Unidade:
27969 SBC UN/1
F1 F4

UN: R\$ 41,08 AV: R\$ 41,08 15: R\$ 41,93
30: R\$ 42,77 45: R\$ 43,63 60: R\$ 44,50



LANCHEIRA FEM PRINCESS ON ICE LA3006
Código: Fábrica: Unidade:
32211 SBC UN/1
F1 F4

UN: R\$ 41,08 AV: R\$ 41,08 15: R\$ 41,93
30: R\$ 42,77 45: R\$ 43,63 60: R\$ 44,50



LANCHEIRA FEM PRINCESS ON ICE LA3106
Código: Fábrica: Unidade:
32105 SBC UN/1
F1 F4

UN: R\$ 41,08 AV: R\$ 41,08 15: R\$ 41,93
30: R\$ 42,77 45: R\$ 43,63 60: R\$ 44,50



LANCHEIRA FEM PRINCESS ON ICE REL LA3044
Código: Fábrica: Unidade:
32106 SBC UN/1
F1 F4

UN: R\$ 41,08 AV: R\$ 41,08 15: R\$ 41,93
30: R\$ 42,77 45: R\$ 43,63 60: R\$ 44,50



LANCHEIRA FEM PRINCESS REL LA3032
Código: Fábrica: Unidade:
32104 SBC UN/1
F1 F4

UN: R\$ 41,08 AV: R\$ 41,08 15: R\$ 41,93
30: R\$ 42,77 45: R\$ 43,63 60: R\$ 44,50



LANCHEIRA FEM PRINCESS REL LA3074
Código: Fábrica: Unidade:
32146 SBC UN/1
F1 F4

UN: R\$ 15,41 AV: R\$ 15,41 15: R\$ 15,73
30: R\$ 16,04 45: R\$ 16,36 60: R\$ 16,69



LANCHEIRA FEM RAPUNZEL LA189
Código: Fábrica: Unidade:
27873 VOZZ UN/1
F1 F4

UN: R\$ 35,94 AV: R\$ 35,94 15: R\$ 36,69
30: R\$ 37,42 45: R\$ 38,17 60: R\$ 38,94



LANCHEIRA FEM REBEL PRINCESS LA2940
Código: Fábrica: Unidade:
32151 SBC UN/1
F1 F4

UN: R\$ 35,94 AV: R\$ 35,94 15: R\$ 36,69
30: R\$ 37,42 45: R\$ 38,17 60: R\$ 38,94



LANCHEIRA FEM SOPHIA REL LA2628
Código: Fábrica: Unidade:
31310 SBC UN/1
F1 F4

UN: R\$ 41,08 AV: R\$ 41,08 15: R\$ 41,93
30: R\$ 42,77 45: R\$ 43,63 60: R\$ 44,50



LANCHEIRA FEM STAR SHOW LA3884
Código: Fábrica: Unidade:
35969 SBC UN/1
F1 F4

UN: R\$ 35,94 AV: R\$ 35,94 15: R\$ 36,69
30: R\$ 37,42 45: R\$ 38,17 60: R\$ 38,94



LANCHEIRA FEM SUPER CATHIE LA3551
Código: Fábrica: Unidade:
38053 SBC UN/1
F1 F4

UN: R\$ 41,08 AV: R\$ 41,08 15: R\$ 41,93
30: R\$ 42,77 45: R\$ 43,63 60: R\$ 44,50



LANCHEIRA FEM UNILOVERS LA3722
Código: Fábrica: Unidade:
34248 SBC UN/1
F1 F4

UN: R\$ 36,72 AV: R\$ 36,72 15: R\$ 37,49
30: R\$ 38,24 45: R\$ 39,00 60: R\$ 39,78



LANCHEIRA FEM VALENTINA LA3168
Código: Fábrica: Unidade:
31783 SBC UN/1
F1 F4

UN: R\$ 35,94 AV: R\$ 35,94 15: R\$ 36,69
30: R\$ 37,42 45: R\$ 38,17 60: R\$ 38,94



LANCHEIRA FEM WORDER GIRL LA3904
Código: Fábrica: Unidade:
35970 SBC UN/1
F1 F4

UN: R\$ 30,81 AV: R\$ 30,81 15: R\$ 31,45
30: R\$ 32,08 45: R\$ 32,72 60: R\$ 33,37



LANCHEIRA FEM WORLD OF PRINCESS LA277
Código: Fábrica: Unidade:
28939 SBC UN/1
F1 F4

UN: R\$ 35,94 AV: R\$ 35,94 15: R\$ 36,69
30: R\$ 37,42 45: R\$ 38,17 60: R\$ 38,94



LANCHEIRA INF LINHA BABY GATINHA LA715
Código: Fábrica: Unidade:
49183 PONTO VERDE UN/1
F1 F4

UN: R\$ 46,94 AV: R\$ 46,94 15: R\$ 47,92
30: R\$ 48,88 45: R\$ 49,86 60: R\$ 50,85



LANCHEIRA INF MASC GUARDIAN NIGHT LA4178
Código: Fábrica: Unidade:
44405 PONTO VERDE UN/1
F1 F4

UN: R\$ 46,94 AV: R\$ 46,94 15: R\$ 47,92
30: R\$ 48,88 45: R\$ 49,86 60: R\$ 50,85



LANCHEIRA INF MASC SPEED WEB LA4142
Código: Fábrica: Unidade:
44404 PONTO VERDE UN/1
F1 F4

UN: R\$ 43,13 AV: R\$ 43,13 15: R\$ 44,03
30: R\$ 44,91 45: R\$ 45,81 60: R\$ 46,73



LANCHEIRA JUVENIL FEM VKG LA4288
Código: Fábrica: Unidade:
48960 PONTO VERDE UN/1
F1 F4

UN: R\$ 35,94 AV: R\$ 35,94 15: R\$ 36,69
30: R\$ 37,42 45: R\$ 38,17 60: R\$ 38,94



LANCHEIRA JUVENIL FEM VKG LA4294
Código: Fábrica: Unidade:
48961 PONTO VERDE UN/1
F1 F4

UN: R\$ 43,13 AV: R\$ 43,13 15: R\$ 44,03
30: R\$ 44,91 45: R\$ 45,81 60: R\$ 46,73



LANCHEIRA JUVENIL FEM VKG LA4298
Código: Fábrica: Unidade:
49181 PONTO VERDE UN/1
F1 F4

UN: R\$ 31,83 AV: R\$ 31,83 15: R\$ 32,50
30: R\$ 33,15 45: R\$ 33,81 60: R\$ 34,49



LANCHEIRA KARS KIDS LA4668
Código: Fábrica: Unidade:
48990 PONTO VERDE UN/1
F1 F4

UN: R\$ 35,94 AV: R\$ 35,94 15: R\$ 36,69
30: R\$ 37,42 45: R\$ 38,17 60: R\$ 38,94



LANCHEIRA MASC AIR JUMP LA3746
Código: Fábrica: Unidade:
38052 SBC UN/1
F1 F4

UN: R\$ 30,41 AV: R\$ 30,41 15: R\$ 31,04
30: R\$ 31,66 45: R\$ 32,29 60: R\$ 32,94



LANCHEIRA MASC BLOCK GAME LA3628
Código: Fábrica: Unidade:
34242 SBC UN/1
F1 F4

UN: R\$ 41,08 AV: R\$ 41,08 15: R\$ 41,93
30: R\$ 42,77 45: R\$ 43,63 60: R\$ 44,50



LANCHEIRA MASC BROKEBONES LA3020
Código: Fábrica: Unidade:
32142 SBC UN/1
F1 F4

UN: R\$ 41,08 AV: R\$ 41,08 15: R\$ 41,93
30: R\$ 42,77 45: R\$ 43,63 60: R\$ 44,50



LANCHEIRA MASC BROKEBONES REL LA3050
Código: Fábrica: Unidade:
32316 SBC UN/1
F1 F4

UN: R\$ 41,08 AV: R\$ 41,08 15: R\$ 41,93
30: R\$ 42,77 45: R\$ 43,63 60: R\$ 44,50



LANCHEIRA MASC BROKEBONES REL LA3124
Código: Fábrica: Unidade:
32101 SBC UN/1
F1 F4

UN: R\$ 41,08 AV: R\$ 41,08 15: R\$ 41,93
30: R\$ 42,77 45: R\$ 43,63 60: R\$ 44,50



LANCHEIRA MASC BROKEBONES REL LA3162
Código: Fábrica: Unidade:
32102 SBC UN/1
F1 F4

UN: R\$ 35,94 AV: R\$ 35,94 15: R\$ 36,69
30: R\$ 37,42 45: R\$ 38,17 60: R\$ 38,94



LANCHEIRA MASC BROKEBONES RELEVO LA2174
Código: Fábrica: Unidade:
29511 SBC UN/1
F1 F4

UN: R\$ 35,94 AV: R\$ 35,94 15: R\$ 36,69
30: R\$ 37,42 45: R\$ 38,17 60: R\$ 38,94



LANCHEIRA MASC DINOSSAURO LA4034
Código: Fábrica: Unidade:
36102 SBC UN/1
F1 F4

UN: R\$ 41,08 AV: R\$ 41,08 15: R\$ 41,93
30: R\$ 42,77 45: R\$ 43,63 60: R\$ 44,50



LANCHEIRA MASC GALERA RADICAL LA3576
Código: Fábrica: Unidade:
34373 SBC UN/1
F1 F4

UN: R\$ 35,94 AV: R\$ 35,94 15: R\$ 36,69
30: R\$ 37,42 45: R\$ 38,17 60: R\$ 38,94



LANCHEIRA MASC HEROES VOZZ LA3056
Código: Fábrica: Unidade:
31833 SBC UN/1
F1 F4

UN: R\$ 35,94 AV: R\$ 35,94 15: R\$ 36,69
30: R\$ 37,42 45: R\$ 38,17 60: R\$ 38,94



LANCHEIRA MASC HEROES VOZZ LA2956

Código: Fábrica: Unidade:
38047 SBC UN/1
F1 F4

UN: R\$ 16,95 AV: R\$ 16,95 15: R\$ 17,30
30: R\$ 17,65 45: R\$ 18,00 60: R\$ 18,36



LANCHEIRA MASC HEROES VOZZ REL LA2658

Código: Fábrica: Unidade:
31303 SBC UN/1
F1 F4

UN: R\$ 41,08 AV: R\$ 41,08 15: R\$ 41,93
30: R\$ 42,77 45: R\$ 43,63 60: R\$ 44,50



LANCHEIRA MASC HEROES VOZZ REL LA3112

Código: Fábrica: Unidade:
32103 SBC UN/1
F1 F4

UN: R\$ 31,83 AV: R\$ 31,83 15: R\$ 32,50
30: R\$ 33,15 45: R\$ 33,81 60: R\$ 34,49



LANCHEIRA MASC HOOZ LA3637

Código: Fábrica: Unidade:
34244 SBC UN/1
F1 F4

UN: R\$ 30,81 AV: R\$ 30,81 15: R\$ 31,45
30: R\$ 32,08 45: R\$ 32,72 60: R\$ 33,37



LANCHEIRA MASC PIGGY BOY LA2052

Código: Fábrica: Unidade:
29521 SBC UN/1
F1 F4

UN: R\$ 35,94 AV: R\$ 35,94 15: R\$ 36,69
30: R\$ 37,42 45: R\$ 38,17 60: R\$ 38,94



LANCHEIRA MASC PIGGY BOY RELEVO LA2434

Código: Fábrica: Unidade:
29609 SBC UN/1
F1 F4

UN: R\$ 35,94 AV: R\$ 35,94 15: R\$ 36,69
30: R\$ 37,42 45: R\$ 38,17 60: R\$ 38,94



LANCHEIRA MASC REINO LEAO LA4015

Código: Fábrica: Unidade:
35968 SBC UN/1
F1 F4

UN: R\$ 41,08 AV: R\$ 41,08 15: R\$ 41,93
30: R\$ 42,77 45: R\$ 43,63 60: R\$ 44,50



LANCHEIRA MASC ROBOT POWER LA3658

Código: Fábrica: Unidade:
34247 SBC UN/1
F1 F4

UN: R\$ 30,81 AV: R\$ 30,81 15: R\$ 31,45
30: R\$ 32,08 45: R\$ 32,72 60: R\$ 33,37



LANCHEIRA MASC SPEED BOY LA 2964

Código: Fábrica: Unidade:
32152 SBC UN/1
F1 F4

UN: R\$ 35,94 AV: R\$ 35,94 15: R\$ 36,69
30: R\$ 37,42 45: R\$ 38,17 60: R\$ 38,94



LANCHEIRA MASC SPEED BOY LA2154

Código: Fábrica: Unidade:
29610 SBC UN/1
F1 F4

UN: R\$ 35,94 AV: R\$ 35,94 15: R\$ 36,69
30: R\$ 37,42 45: R\$ 38,17 60: R\$ 38,94



LANCHEIRA MASC SPEED BOY LA3613

Código: Fábrica: Unidade:
38048 SBC UN/1
F1 F4

UN: R\$ 41,08 AV: R\$ 41,08 15: R\$ 41,93
30: R\$ 42,77 45: R\$ 43,63 60: R\$ 44,50



LANCHEIRA MASC SPEED BOY REL LA3156

Código: Fábrica: Unidade:
32315 SBC UN/1
F1 F4

UN: R\$ 31,83 AV: R\$ 31,83 15: R\$ 32,50
30: R\$ 33,15 45: R\$ 33,81 60: R\$ 34,49



LANCHEIRA PRINCESA LA4638

Código: Fábrica: Unidade:
48991 PONTO VERDE UN/1
F1 F4

UN: R\$ 32,86 AV: R\$ 32,86 15: R\$ 33,54
30: R\$ 34,22 45: R\$ 34,90 60: R\$ 35,60



LANCHEIRA SEREIA LA4618

Código: Fábrica: Unidade:
49032 PONTO VERDE UN/1
F1 F4

UN: R\$ 10,79 AV: R\$ 10,79 15: R\$ 11,01
30: R\$ 11,23 45: R\$ 11,46 60: R\$ 11,68



LANCHEIRA TERM FEM PROMOCAO

Código: Fábrica: Unidade:
21180 YINS/YANGZI UN/1
F4

UN: R\$ 41,08 AV: R\$ 41,08 15: R\$ 41,93
30: R\$ 42,77 45: R\$ 43,63 60: R\$ 44,50



LANCHEIRA TERM JUVENIL FEM VIKING LA4256

Código: Fábrica: Unidade:
49182 PONTO VERDE UN/1
F1 F4

UN: R\$ 33,53 AV: R\$ 33,53 15: R\$ 34,23
30: R\$ 34,91 45: R\$ 35,61 60: R\$ 36,32



LANCHEIRA TERM JUVENIL FEM VKG LA4266

Código: Fábrica: Unidade:
49221 PONTO VERDE UN/1
F1 F4

UN: R\$ 30,81 AV: R\$ 30,81 15: R\$ 31,45
30: R\$ 32,08 45: R\$ 32,72 60: R\$ 33,37



LANCHEIRA UNISSEX FRIENDS AVENTURE LA153

Código: Fábrica: Unidade:
29018 SBC UN/1
F1 F4

UN: R\$ 25,68 AV: R\$ 25,68 15: R\$ 26,22
30: R\$ 26,74 45: R\$ 27,27 60: R\$ 27,82



LANCHEIRA UNISSEX TURMA DO RISO LA111

Código: Fábrica: Unidade:
28923 SBC UN/1
F1 F4

UN: R\$ 1,02 AV: R\$ 12,20 15: R\$ 12,46
30: R\$ 12,71 45: R\$ 12,96 60: R\$ 13,22



LANTEJOULA 2 GRS AZUL12X1

Código: Fábrica: Unidade:
9808 CITY BRILHO DZ/12
F1 F4

UN: R\$ 1,02 AV: R\$ 12,20 15: R\$ 12,46
30: R\$ 12,71 45: R\$ 12,96 60: R\$ 13,22



LANTEJOULA 2 GRS BRANCO 12X1

Código: Fábrica: Unidade:
9806 CITY BRILHO DZ/12
F1 F4

UN: R\$ 1,02 AV: R\$ 12,20 15: R\$ 12,46
30: R\$ 12,71 45: R\$ 12,96 60: R\$ 13,22



LANTEJOULA 2 GRS DOURADO 12X1

Código: Fábrica: Unidade:
9807 CITY BRILHO DZ/12
F1 F4

UN: R\$ 1,02 AV: R\$ 12,20 15: R\$ 12,46
30: R\$ 12,71 45: R\$ 12,96 60: R\$ 13,22



LANTEJOULA 2 GRS PRATA 12X1

Código: Fábrica: Unidade:
15072 CITY BRILHO DZ/12
F1 F4

UN: R\$ 1,02 AV: R\$ 12,20 15: R\$ 12,46
30: R\$ 12,71 45: R\$ 12,96 60: R\$ 13,22



LANTEJOULA 2 GRS PRETA 12X1

Código: Fábrica: Unidade:
15073 CITY BRILHO DZ/12
F1 F4

UN: R\$ 1,02 AV: R\$ 12,20 15: R\$ 12,46
30: R\$ 12,71 45: R\$ 12,96 60: R\$ 13,22



LANTEJOULA 2 GRS ROSA 12X1

Código: Fábrica: Unidade:
15074 CITY BRILHO DZ/12
F1 F4

UN: R\$ 1,02 AV: R\$ 12,20 15: R\$ 12,46
30: R\$ 12,71 45: R\$ 12,96 60: R\$ 13,22



LANTEJOULA 2 GRS VERDE 12X1

Código: Fábrica: Unidade:
9809 CITY BRILHO DZ/12
F1 F4

UN: R\$ 1,02 AV: R\$ 12,20 15: R\$ 12,46
30: R\$ 12,71 45: R\$ 12,96 60: R\$ 13,22



LANTEJOULA 2 GRS VERMELHA 12X1

Código: Fábrica: Unidade:
9810 CITY BRILHO DZ/12
F1 F4

UN: R\$ 9,93 AV: R\$ 29,78 15: R\$ 30,40
30: R\$ 31,01 45: R\$ 31,63 60: R\$ 32,26



LAPIS COR RED 24 CORES 3X1

Código: Fábrica: Unidade:
7365 INJEX PEN PT/3
F1 F4

UN: R\$ 4,96 AV: R\$ 29,78 15: R\$ 30,40
30: R\$ 31,01 45: R\$ 31,63 60: R\$ 32,26



LAPIS COR SUPERACAO 12 CORES RED 6X1

Código: Fábrica: Unidade:
44030 INJEX PEN PT/6
F1 F4

UN: R\$ 23,62 AV: R\$ 23,62 15: R\$ 24,11
30: R\$ 24,59 45: R\$ 25,08 60: R\$ 25,58



LAPIS COR 10 CORES METALICO SOFT COLOR

Código: Fábrica: Unidade:
49502 TRIS UN/1
F1 F4

UN: R\$ 18,38 AV: R\$ 18,38 15: R\$ 18,76
30: R\$ 19,13 45: R\$ 19,52 60: R\$ 19,91



LAPIS COR 12 CORES AQUAREL C/PINCEL9652

Código: Fábrica: Unidade:
48429 ACRILEX UN/1
F1 F4

UN: R\$ 11,91 AV: R\$ 11,91 15: R\$ 12,15
30: R\$ 12,40 45: R\$ 12,64 60: R\$ 12,90



LAPIS COR 12 CORES AQUARELAV SEXT C/APON

Código: Fábrica: Unidade:
46931 YIN'S PAPER UN/1
F1 F4

UN: R\$ 8,26 AV: R\$ 33,02 15: R\$ 33,71
30: R\$ 34,39 45: R\$ 35,07 60: R\$ 35,78



LAPIS COR 12 CORES C/APONT/BORR/2LAP 4X1

Código: Fábrica: Unidade:
27954 LEO&LEO PT/6
F1 F4

UN: R\$ 15,52 AV: R\$ 93,12 15: R\$ 95,06
30: R\$ 96,96 45: R\$ 98,90 60: R\$ 100,87



LAPIS COR 12 CORES HEXAG MEGA SOFT 6X1

Código: Fábrica: Unidade:
48812 TRIS PT/6
F1 F4

UN: R\$ 99,12 AV: R\$ 99,12 15: R\$ 101,19
30: R\$ 103,21 45: R\$ 105,28 60: R\$ 107,38



LAPIS COR 12 CORES JUMBO C/APONTADOR 3X1

Código: Fábrica: Unidade:
43754 TRIS UN/1
F1 F4

UN: R\$ 11,25 AV: R\$ 67,49 15: R\$ 68,89
30: R\$ 70,27 45: R\$ 71,68 60: R\$ 73,11



LAPIS COR 12 CORES JUMBO C/APONTADOR 6X1

Código: Fábrica: Unidade:
50329 FIRST PT/6
F1 F4

UN: R\$ 5,13 AV: R\$ 30,81 15: R\$ 31,45
30: R\$ 32,08 45: R\$ 32,72 60: R\$ 33,37



LAPIS COR 12 CORES MAD RED ECO 4692 6X1

Código: Fábrica: Unidade:
50618 LEO&LEO PT/6
F1 F4

UN: R\$ 5,13 AV: R\$ 30,81 15: R\$ 31,45
30: R\$ 32,08 45: R\$ 32,72 60: R\$ 33,37



LAPIS COR 12 CORES MAD SEXT ECO 4220 6X1

Código: Fábrica: Unidade:
50617 LEO&LEO PT/6
F1 F4

UN: R\$ 12,64 AV: R\$ 75,86 15: R\$ 77,44
30: R\$ 78,99 45: R\$ 80,57 60: R\$ 82,18



LAPIS COR 12 CORES MAD SEXTAV 4130 6X1

Código: Fábrica: Unidade:
48356 LEO&LEO PT/6
F1 F4

UN: R\$ 4,99 AV: R\$ 29,94 15: R\$ 29,94
30: R\$ 29,94 45: R\$ 29,94 60: R\$ 29,94



LAPIS COR 12 CORES MADEIRA 120636 6X1

Código: Fábrica: Unidade:
42034 SERELEPE PT/6
F1 F4

UN: R\$ 5,18 AV: R\$ 31,10 15: R\$ 31,75
30: R\$ 32,39 45: R\$ 33,03 60: R\$ 33,70



LAPIS COR 12 CORES RED PIRILAMPO REC 6X1

Código: Fábrica: Unidade:
47461 ECOLE PT/6
F1 F4

UN: R\$ 7,91 AV: R\$ 7,91 15: R\$ 8,07
30: R\$ 8,24 45: R\$ 8,40 60: R\$ 8,57



LAPIS COR 12 CORES SEXT MAD FSC UN

Código: Fábrica: Unidade:
49271 COLORARE UN/1
F1 F4

UN: R\$ 10,61 AV: R\$ 10,61 15: R\$ 10,83
30: R\$ 11,05 45: R\$ 11,27 60: R\$ 11,50



LAPIS COR 12 CORES SEXT MADEIRA 0012

Código: Fábrica: Unidade:
49153 BRW UN/1
F1 F4

UN: R\$ 4,19 AV: R\$ 50,32 15: R\$ 51,37
30: R\$ 52,40 45: R\$ 53,45 60: R\$ 54,52



LAPIS COR 12 CORES SEXTAV WAVE REC 12X1

Código: Fábrica: Unidade:
48330 BAZZE PT/12
F1 F4

UN: R\$ 4,62 AV: R\$ 27,72 15: R\$ 28,30
30: R\$ 28,87 45: R\$ 29,45 60: R\$ 30,03



LAPIS COR 12 CORES SEXTAV ECO 1204 6X1

Código: Fábrica: Unidade:
25503 BRW PT/6
F1 F4

UN: R\$ 11,66 AV: R\$ 11,66 15: R\$ 11,90
30: R\$ 12,14 45: R\$ 12,38 60: R\$ 12,63



LAPIS COR 12 CORES SUPER MINA 3MM 9692

Código: Fábrica: Unidade:
48432 ACRILEX UN/1
F1 F4

UN: R\$ 13,63 AV: R\$ 13,63 15: R\$ 13,91
30: R\$ 14,19 45: R\$ 14,48 60: R\$ 14,77



LAPIS COR 12 CORES TRIAN BIG C/APON 4194

Código: Fábrica: Unidade:
42591 LEO&LEO UN/1
F1 F4

UN: R\$ 14,80 AV: R\$ 88,82 15: R\$ 90,67
30: R\$ 92,49 45: R\$ 94,34 60: R\$ 96,22



LAPIS COR 12 CORES TRIANG AQUARELAV 6X1

Código: Fábrica: Unidade:
46847 ONDA PT/6
F1 F4

UN: R\$ 23,97 AV: R\$ 143,80 15: R\$ 146,79
30: R\$ 149,73 45: R\$ 152,72 60: R\$ 155,78



LÁPIS COR 12 CORES TRIANG BIG 1206 6X1
Código: Fábrika: Unidade:
44293 BRW PT/6
F1 F4

UN: R\$ 10,27 AV: R\$ 61,60 15: R\$ 62,88
30: R\$ 64,14 45: R\$ 65,43 60: R\$ 66,73



LÁPIS COR 12 CORES TRIANG MEGA SOFT 6X1
Código: Fábrika: Unidade:
48329 TRIS PT/6
F1 F4

UN: R\$ 5,13 AV: R\$ 5,13 15: R\$ 5,23
30: R\$ 5,34 45: R\$ 5,44 60: R\$ 5,55



LÁPIS COR 12 CORES UN
Código: Fábrika: Unidade:
38508 SERELEPE UN/1
F1 F4

UN: R\$ 4,10 AV: R\$ 4,10 15: R\$ 4,18
30: R\$ 4,27 45: R\$ 4,35 60: R\$ 4,44



LÁPIS COR 12 CORES UN
Código: Fábrika: Unidade:
42826 INJEX UN/1
F1 F4

UN: R\$ 2,98 AV: R\$ 2,98 15: R\$ 3,04
30: R\$ 3,10 45: R\$ 3,16 60: R\$ 3,23



LÁPIS COR 1/2 12 CORES WK 09235 UN
Código: Fábrika: Unidade:
38509 KLUB UN/1
F1 F4

UN: R\$ 1,49 AV: R\$ 17,88 15: R\$ 17,88
30: R\$ 17,88 45: R\$ 17,88 60: R\$ 17,88



LÁPIS COR 1/2 12 CORES WK 09235 12X1
Código: Fábrika: Unidade:
4257 KLUB CX/12
F1 F4

UN: R\$ 33,89 AV: R\$ 33,89 15: R\$ 34,59
30: R\$ 35,29 45: R\$ 35,99 60: R\$ 36,71



LÁPIS COR 24 CORES AQUAREL C/PINCEL 9654
Código: Fábrika: Unidade:
48431 ACRILEX UN/1
F1 F4

UN: R\$ 15,92 AV: R\$ 15,92 15: R\$ 16,25
30: R\$ 16,58 45: R\$ 16,91 60: R\$ 17,25



LÁPIS COR 24 CORES RED WOW 4678
Código: Fábrika: Unidade:
46348 LEO&LEO UN/1
F1 F4

UN: R\$ 15,40 AV: R\$ 15,40 15: R\$ 15,72
30: R\$ 16,03 45: R\$ 16,35 60: R\$ 16,68



LÁPIS COR 24 CORES SEXT MAD FSC UN
Código: Fábrika: Unidade:
49272 COLORARE PT/1
F1 F4

UN: R\$ 23,62 AV: R\$ 23,62 15: R\$ 24,11
30: R\$ 24,59 45: R\$ 25,08 60: R\$ 25,58



LÁPIS COR 24 CORES SUPER MINA 3MM 9694
Código: Fábrika: Unidade:
41605 ACRILEX UN/1
F1 F4

UN: R\$ 8,92 AV: R\$ 53,53 15: R\$ 54,64
30: R\$ 55,74 45: R\$ 56,85 60: R\$ 57,99



LÁPIS COR 24 CORES UN
Código: Fábrika: Unidade:
19811 INJEX PT/6
F1 F4

UN: R\$ 20,53 AV: R\$ 20,53 15: R\$ 20,96
30: R\$ 21,38 45: R\$ 21,81 60: R\$ 22,24



LÁPIS COR 36 CORES SEXTAV FLEX 4482
Código: Fábrika: Unidade:
46343 LEO&LEO UN/1
F1 F4

UN: R\$ 20,54 AV: R\$ 61,62 15: R\$ 62,91
30: R\$ 64,16 45: R\$ 65,45 60: R\$ 66,76



LÁPIS COR 36 CORES SEXTAVADO 3X1
Código: Fábrika: Unidade:
41844 ONDA PT/3
F1 F4

UN: R\$ 36,97 AV: R\$ 36,97 15: R\$ 37,74
30: R\$ 38,49 45: R\$ 39,26 60: R\$ 40,05



LÁPIS COR 36 CORES SUPER MINA 3MM 9626
Código: Fábrika: Unidade:
48430 ACRILEX UN/1
F1 F4

UN: R\$ 25,47 AV: R\$ 25,47 15: R\$ 26,01
30: R\$ 26,53 45: R\$ 27,06 60: R\$ 27,60



LÁPIS COR 48 CORES SEXTAV 72105
Código: Fábrika: Unidade:
46344 LEO&LEO UN/1
F1 F4

UN: R\$ 1,28 AV: R\$ 15,40 15: R\$ 15,72
30: R\$ 16,03 45: R\$ 16,35 60: R\$ 16,68



LÁPIS (GIZ) CERA ESTACA AMARELO 100G 12X1
Código: Fábrika: Unidade:
28917 FABERCASTELL DZ/12
F1 F4

UN: R\$ 1,28 AV: R\$ 15,40 15: R\$ 15,72
30: R\$ 16,03 45: R\$ 16,35 60: R\$ 16,68



LAPIS (GIZ) CERA ESTACA VERDE CL 10012X1
Código: 28918 Fábrica: FABER CASTEL Unidade: DZ/12 F1 F4

UN: R\$ 1,28 AV: R\$ 15,40 15: R\$ 15,72
30: R\$ 16,03 45: R\$ 16,35 60: R\$ 16,68



LAPIS (GIZ) CERA ESTACA VERDE 100G 12X1
Código: 3828 Fábrica: FABER/ACRILE Unidade: DZ/12 F1 F4

UN: R\$ 2,91 AV: R\$ 34,91 15: R\$ 35,64
30: R\$ 36,35 45: R\$ 37,08 60: R\$ 37,82



LAPIS HB BLACK PEPS JUMBO C/BORR 12X1
Código: 44294 Fábrica: MAPED Unidade: CX/12 F1 F4

UN: R\$ 8,41 AV: R\$ 100,90 15: R\$ 103,00
30: R\$ 105,06 45: R\$ 107,17 60: R\$ 109,31



LAPIS HB INFINITO COLOR AZUL 13084 12X1
Código: 48554 Fábrica: NEWPEN Unidade: CX/12 F1 F4

UN: R\$ 8,41 AV: R\$ 100,90 15: R\$ 103,00
30: R\$ 105,06 45: R\$ 107,17 60: R\$ 109,31



LAPIS HB INFINITO COLOR ROSA 13085 12X1
Código: 48555 Fábrica: NEWPEN Unidade: CX/12 F1 F4

UN: R\$ 1,33 AV: R\$ 7,96 15: R\$ 8,13
30: R\$ 8,29 45: R\$ 8,46 60: R\$ 8,62



LAPIS MARCENEIRO/CARPINTEIRO 19460 6X1
Código: 46587 Fábrica: ALIANCA Unidade: PT/6 F1 F4

UN: R\$ 105,79 AV: R\$ 105,79 15: R\$ 108,00
30: R\$ 110,16 45: R\$ 112,36 60: R\$ 114,61



LAPIS PRETO C/BORRACHA HB N2 JUMBO 36X1
Código: 41925 Fábrica: TRIS Unidade: CX/1 F1 F4

UN: R\$ 0,77 AV: R\$ 55,21 15: R\$ 56,36
30: R\$ 57,49 45: R\$ 58,64 60: R\$ 59,81



LAPIS PRETO HB C/BOR RED DEC 907721 72X1
Código: 49949 Fábrica: BAZZE WAVE Unidade: PT/72 F1 F4

UN: R\$ 0,78 AV: R\$ 56,49 15: R\$ 57,66
30: R\$ 58,82 45: R\$ 59,99 60: R\$ 61,19



LAPIS PRETO HB C/BORR PANDA 72191 72X1
Código: 44245 Fábrica: LEO&LEO Unidade: CX/72 F1 F4

UN: R\$ 0,68 AV: R\$ 49,30 15: R\$ 50,32
30: R\$ 51,33 45: R\$ 52,36 60: R\$ 53,40



LAPIS PRETO HB C/BORR RED FUNDO MAR 72X1
Código: 46330 Fábrica: LEO&LEO Unidade: PT/72 F1 F4

UN: R\$ 1,25 AV: R\$ 59,99 15: R\$ 59,99
30: R\$ 59,99 45: R\$ 59,99 60: R\$ 59,99



LAPIS PRETO HB N.2 OFFICE PREMIUM 48X1
Código: 46279 Fábrica: MOLIN Unidade: CX/48 F1 F4

UN: R\$ 1,50 AV: R\$ 71,89 15: R\$ 73,39
30: R\$ 74,86 45: R\$ 76,36 60: R\$ 77,88



LAPIS PRETO HB N.2 OFFICE STRIPES 48X1
Código: 46280 Fábrica: MOLIN Unidade: CX/48 F1 F4

UN: R\$ 1,67 AV: R\$ 80,11 15: R\$ 81,78
30: R\$ 83,42 45: R\$ 85,08 60: R\$ 86,79



LAPIS PRETO HB N.2 PINK AND BLUE 48X1
Código: 46281 Fábrica: MOLIN Unidade: CX/48 F1 F4

UN: R\$ 0,77 AV: R\$ 110,81 15: R\$ 113,12
30: R\$ 115,39 45: R\$ 117,69 60: R\$ 120,05



LAPIS PRETO HB N.2 SEXT C/DIPPING 144X1
Código: 48425 Fábrica: ACRILEX Unidade: CX/144 F1 F4

UN: R\$ 0,86 AV: R\$ 61,62 15: R\$ 62,91
30: R\$ 64,16 45: R\$ 65,45 60: R\$ 66,76



LAPIS PRETO HB RED C/BORR TABUADA 72X1
Código: 41701 Fábrica: LEO&LEO Unidade: CX/72 F1 F4

UN: R\$ 0,79 AV: R\$ 56,78 15: R\$ 57,97
30: R\$ 59,13 45: R\$ 60,31 60: R\$ 61,51



LAPIS PRETO HB RED DEC 901767 72X1
Código: 49947 Fábrica: BAZZE WAVE Unidade: PT/72 F1 F4

UN: R\$ 0,74 AV: R\$ 53,40 15: R\$ 54,52
30: R\$ 55,61 45: R\$ 56,72 60: R\$ 57,85



LAPIS PRETO HB RED EMOTION 901743 72X1
Código: Fábrika: Unidade:
49948 BAZZE PT/72
F1 F4

UN: R\$ 0,71 AV: R\$ 51,35 15: R\$ 52,42
30: R\$ 53,47 45: R\$ 54,54 60: R\$ 55,63



LAPIS PRETO HB RED TABUADA 611914 72X1
Código: Fábrika: Unidade:
49950 BAZZE PT/72
F1 F4

UN: R\$ 0,42 AV: R\$ 29,99 15: R\$ 29,99
30: R\$ 29,99 45: R\$ 29,99 60: R\$ 29,99



LAPIS PRETO HB SEXTAV VERDE 4389 72X1
Código: Fábrika: Unidade:
46345 LEO%LEO PT/72
F1 F4

UN: R\$ 0,47 AV: R\$ 5,64 15: R\$ 5,76
30: R\$ 5,87 45: R\$ 5,99 60: R\$ 6,11



LAPIS PRETO HB SEXTAVADO 7834 12X1
Código: Fábrika: Unidade:
47936 YIN'S PAPER CX/12
F1 F4

UN: R\$ 0,38 AV: R\$ 27,05 15: R\$ 27,61
30: R\$ 28,16 45: R\$ 28,73 60: R\$ 29,30



LAPIS PRETO HB SEXTAVADO 902894 72X1
Código: Fábrika: Unidade:
49493 BAZZE PT/72
F1 F4

UN: R\$ 1,00 AV: R\$ 35,94 15: R\$ 36,69
30: R\$ 37,42 45: R\$ 38,17 60: R\$ 38,94



LAPIS PRETO HB TRIAG BIG 4197 36X1
Código: Fábrika: Unidade:
46332 LEO&LEO PT/36
F1 F4

UN: R\$ 0,42 AV: R\$ 60,59 15: R\$ 61,86
30: R\$ 63,09 45: R\$ 64,36 60: R\$ 65,64



LAPIS PRETO N.2 SEXTAVADO RESINA 144X1
Código: Fábrika: Unidade:
47219 MASTERPRINT CX/144
F1 F4

UN: R\$ 1,02 AV: R\$ 12,30 15: R\$ 12,55
30: R\$ 12,80 45: R\$ 13,06 60: R\$ 13,32



LAPIS PRETO 2B TECNICO MADEIRA 5546 12X1
Código: Fábrika: Unidade:
44246 LEO&LEO DZ/12
F1 F4

UN: R\$ 1,02 AV: R\$ 12,30 15: R\$ 12,55
30: R\$ 12,80 45: R\$ 13,06 60: R\$ 13,32



LAPIS PRETO 8B TECNICO MADEIRA 72155 12X1
Código: Fábrika: Unidade:
44249 LEO&LEO DZ/12
F1 F4

UN: R\$ 0,21 AV: R\$ 29,99 15: R\$ 29,99
30: R\$ 29,99 45: R\$ 29,99 60: R\$ 29,99



LAPIS PRETO 8202 12X12
Código: Fábrika: Unidade:
20518 YINS CX/144
F1 F4

UN: R\$ 0,37 AV: R\$ 52,76 15: R\$ 53,86
30: R\$ 54,93 45: R\$ 56,03 60: R\$ 57,15



LAPIS RESINA HB RED GRAF 144X1 BM2024
Código: Fábrika: Unidade:
48843 FIRST CX/144
F1 F4

UN: R\$ 4,60 AV: R\$ 110,42 15: R\$ 112,72
30: R\$ 114,98 45: R\$ 117,28 60: R\$ 119,62



LAPISEIRA 0.5MM HIT 4CORES 102208 24X1
Código: Fábrika: Unidade:
43809 FUTURO PT/24
F1 F4

UN: R\$ 2,40 AV: R\$ 57,51 15: R\$ 58,71
30: R\$ 59,89 45: R\$ 61,08 60: R\$ 62,30



LAPISEIRA 0.5MM POP C/BORRACH 98078 24X1
Código: Fábrika: Unidade:
50646 LEO&LEO PT/24
F1 F4

UN: R\$ 7,36 AV: R\$ 88,33 15: R\$ 90,17
30: R\$ 91,97 45: R\$ 93,81 60: R\$ 95,69



LAPISEIRA 0.5MM TECNICA C/BORRACH 12X1
Código: Fábrika: Unidade:
44996 BRW CX/12
F1 F4

UN: R\$ 5,56 AV: R\$ 66,73 15: R\$ 68,12
30: R\$ 69,48 45: R\$ 70,87 60: R\$ 72,29



LAPISEIRA 0.5MM TECNICA TRIAN 98027 12X1
Código: Fábrika: Unidade:
29751 JOCAR OFFICE DZ/12
F1 F4

UN: R\$ 2,01 AV: R\$ 24,09 15: R\$ 24,59
30: R\$ 25,08 45: R\$ 25,58 60: R\$ 26,09



LAPISEIRA 0.7MM C/BORRACHA 1101 12X1
Código: Fábrika: Unidade:
51060 MASTERPRINT CX/12
F1 F4

UN: R\$ 2,40 AV: R\$ 57,51 15: R\$ 58,71
30: R\$ 59,89 45: R\$ 61,08 60: R\$ 62,30



LAPISEIRA 0.7MM POP C/BORRACH 98079 24X1
Código: Fábrika: Unidade:
46369 LEO&LEO PT/24
F1 F4

UN: R\$ 4,28 AV: R\$ 102,71 15: R\$ 104,85
30: R\$ 106,95 45: R\$ 109,09 60: R\$ 111,27



LAPISEIRA 0.7MM SHAKE 4137 24X1
Código: Fábrika: Unidade:
41212 LEO&LEO CX/24
F1 F4

UN: R\$ 2,05 AV: R\$ 49,30 15: R\$ 50,32
30: R\$ 51,33 45: R\$ 52,36 60: R\$ 53,40



LAPISEIRA 2.0MM COLOR C/APONTADOR 24X1
Código: Fábrika: Unidade:
44646 LEO&LEO CX/24
F1 F4

UN: R\$ 3,72 AV: R\$ 89,39 15: R\$ 91,26
30: R\$ 93,08 45: R\$ 94,94 60: R\$ 96,84



LAPISEIRA 2.0MM 4 COR PASTEL 2024 24X1
Código: Fábrika: Unidade:
42581 BRW CX/24
F1 F4

UN: R\$ 0,02 AV: R\$ 12,49 15: R\$ 12,75
30: R\$ 13,00 45: R\$ 13,26 60: R\$ 13,53



LEMBRANCINHAS ANIVERSARIO 12X50X1
Código: Fábrika: Unidade:
11265 KID-ART PT/600
F1 F4

UN: R\$ 97,48 AV: R\$ 97,48 15: R\$ 99,51
30: R\$ 101,50 45: R\$ 103,53 60: R\$ 105,60



LIMPA QUADRO 1 L
Código: Fábrika: Unidade:
48094 STOP CLEAN UN/1
F1 F4

UN: R\$ 17,45 AV: R\$ 17,45 15: R\$ 17,82
30: R\$ 18,17 45: R\$ 18,54 60: R\$ 18,91



LIMPADOR INST 60ML P/TELA MONITOR
Código: Fábrika: Unidade:
42806 CARBRINK UN/1
F1 F4

UN: R\$ 18,28 AV: R\$ 18,28 15: R\$ 18,67
30: R\$ 19,04 45: R\$ 19,42 60: R\$ 19,81



LIQUIDO DE LIMPEZA P/QUADRO BRANCO 110ML
Código: Fábrika: Unidade:
45629 CRTIARTE UN/1
F1 F4

UN: R\$ 0,72 AV: R\$ 7,18 15: R\$ 7,33
30: R\$ 7,48 45: R\$ 7,63 60: R\$ 7,78



LIVRAO C/QUEBRA CABECA PRINCESAS
Código: Fábrika: Unidade:
30913 TODOLIVRO PT/10
F1 F4

UN: R\$ 37,75 AV: R\$ 37,75 15: R\$ 38,54
30: R\$ 39,31 45: R\$ 40,09 60: R\$ 40,89



LIVRO C/FANTOCHE ANIMAIS DA FAZENDA
Código: Fábrika: Unidade:
48504 TODOLIVRO UN/1
F1 F4

UN: R\$ 37,75 AV: R\$ 37,75 15: R\$ 38,54
30: R\$ 39,31 45: R\$ 40,09 60: R\$ 40,89



LIVRO C/FANTOCHE ANIMAIS DA SELVA
Código: Fábrika: Unidade:
48511 TODOLIVRO UN/1
F1 F4

UN: R\$ 37,75 AV: R\$ 37,75 15: R\$ 38,54
30: R\$ 39,31 45: R\$ 40,09 60: R\$ 40,89



LIVRO C/FANTOCHE ANIMAIS DE ESTIMACAO
Código: Fábrika: Unidade:
48512 TODOLIVRO UN/1
F1 F4

UN: R\$ 37,75 AV: R\$ 37,75 15: R\$ 38,54
30: R\$ 39,31 45: R\$ 40,09 60: R\$ 40,89



LIVRO C/FANTOCHE ARCA DE NOE
Código: Fábrika: Unidade:
48513 TODOLIVRO UN/1
F1 F4

UN: R\$ 37,75 AV: R\$ 37,75 15: R\$ 38,54
30: R\$ 39,31 45: R\$ 40,09 60: R\$ 40,89



LIVRO C/FANTOCHE CHAPEUZINHO VERMELHO
Código: Fábrika: Unidade:
48514 TODOLIVRO UN/1
F1 F4

UN: R\$ 37,75 AV: R\$ 37,75 15: R\$ 38,54
30: R\$ 39,31 45: R\$ 40,09 60: R\$ 40,89



LIVRO C/FANTOCHE CINDERELA
Código: Fábrika: Unidade:
48515 TODOLIVRO UN/1
F1 F4

UN: R\$ 37,75 AV: R\$ 37,75 15: R\$ 38,54
30: R\$ 39,31 45: R\$ 40,09 60: R\$ 40,89



LIVRO C/FANTOCHE DINOSSAUROS
Código: Fábrika: Unidade:
48517 TODOLIVRO UN/1
F1 F4

UN: R\$ 37,75 AV: R\$ 37,75 15: R\$ 38,54
30: R\$ 39,31 45: R\$ 40,09 60: R\$ 40,89



LIVRO C/FANTOCHE OS TRES PORQUINHOS
Código: Fábrica: Unidade:
48516 TODOLIVRO UN/1
F1 F4

UN: R\$ 17,45 AV: R\$ 17,45 15: R\$ 17,82
30: R\$ 18,17 45: R\$ 18,54 60: R\$ 18,91

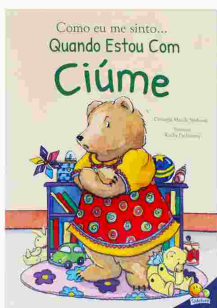

LIVRO COMO EU ME SINTO QDO ESTOU C/CIUME
Código: Fábrica: Unidade:
48456 TODOLIVRO UN/1
F1 F4

UN: R\$ 10,26 AV: R\$ 10,26 15: R\$ 10,48
30: R\$ 10,69 45: R\$ 10,90 60: R\$ 11,12



LIVRO COMO EU ME SINTO QDO ESTOU TRISTE
Código: Fábrica: Unidade:
48457 TODOLIVRO UN/1
F1 F4

UN: R\$ 10,26 AV: R\$ 10,26 15: R\$ 10,48
30: R\$ 10,69 45: R\$ 10,90 60: R\$ 11,12



LIVRO COMO EU ME SINTO QDO ESTOU ZANGADO
Código: Fábrica: Unidade:
48458 TODOLIVRO UN/1
F1 F4

UN: R\$ 10,26 AV: R\$ 10,26 15: R\$ 10,48
30: R\$ 10,69 45: R\$ 10,90 60: R\$ 11,12



LIVRO COMO EU ME SINTO QDO ME IMPORTO C/
Código: Fábrica: Unidade:
48459 TODOLIVRO UN/1
F1 F4

UN: R\$ 10,26 AV: R\$ 10,26 15: R\$ 10,48
30: R\$ 10,69 45: R\$ 10,90 60: R\$ 11,12



LIVRO COMO EU ME SINTO QDO ME SINTO BEM
Código: Fábrica: Unidade:
48460 TODOLIVRO UN/1
F1 F4

UN: R\$ 10,26 AV: R\$ 10,26 15: R\$ 10,48
30: R\$ 10,69 45: R\$ 10,90 60: R\$ 11,12

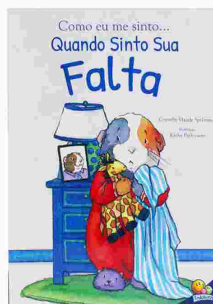

LIVRO COMO EU ME SINTO QDO SINTO SUA FAL
Código: Fábrica: Unidade:
48461 TODOLIVRO UN/1
F1 F4

UN: R\$ 10,26 AV: R\$ 10,26 15: R\$ 10,48
30: R\$ 10,69 45: R\$ 10,90 60: R\$ 11,12



LIVRO COMO EU ME SINTO QDO TENHO MEDO
Código: Fábrica: Unidade:
48462 TODOLIVRO UN/1
F1 F4

UN: R\$ 30,81 AV: R\$ 30,81 15: R\$ 31,45
30: R\$ 32,08 45: R\$ 32,72 60: R\$ 33,37



LIVRO CUTE & COMFY CANETINHA P DUPLA 914
Código: Fábrica: Unidade:
49873 IBC UN/1
F1 F4

UN: R\$ 24,64 AV: R\$ 24,64 15: R\$ 25,16
30: R\$ 25,66 45: R\$ 26,17 60: R\$ 26,70

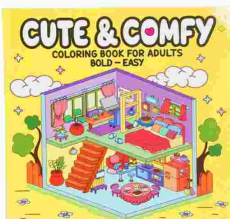

LIVRO CUTE & COMFY COLORING BOOK AD 1600
Código: Fábrica: Unidade:
49708 IBC UN/1
F1 F4

UN: R\$ 28,75 AV: R\$ 28,75 15: R\$ 29,35
30: R\$ 29,94 45: R\$ 30,54 60: R\$ 31,15



LIVRO CUTE & COMFY DES SIMPLES LAPIS COR
Código: Fábrica: Unidade:
49718 IBC UN/1
F1 F4

UN: R\$ 15,40 AV: R\$ 15,40 15: R\$ 15,72
30: R\$ 16,03 45: R\$ 16,35 60: R\$ 16,68



LIVRO CUTE & COMFY FRIENDS COLORING 2096
Código: Fábrica: Unidade:
49711 IBC UN/1
F1 F4

UN: R\$ 28,75 AV: R\$ 28,75 15: R\$ 29,35
30: R\$ 29,94 45: R\$ 30,54 60: R\$ 31,15



LIVRO CUTE & COMFY MENINAS C/LAPIS COR
Código: Fábrica: Unidade:
49715 IBC UN/1
F1 F4

UN: R\$ 15,40 AV: R\$ 15,40 15: R\$ 15,72
30: R\$ 16,03 45: R\$ 16,35 60: R\$ 16,68



LIVRO CUTE & COMFY NO STRESS COLORING 72
Código: Fábrica: Unidade:
49710 IBC UN/1
F1 F4

UN: R\$ 28,75 AV: R\$ 28,75 15: R\$ 29,35
30: R\$ 29,94 45: R\$ 30,54 60: R\$ 31,15



LIVRO CUTE & COMFY RELAXAR C/LAPIS COR
Código: Fábrica: Unidade:
49717 IBC UN/1
F1 F4

UN: R\$ 28,75 AV: R\$ 28,75 15: R\$ 29,35
30: R\$ 29,94 45: R\$ 30,54 60: R\$ 31,15



LIVRO CUTE & COMFY SEM STRESS LAPIS COR
Código: Fábrica: Unidade:
49716 IBC UN/1
F1 F4

UN: R\$ 20,53 AV: R\$ 20,53 15: R\$ 20,96
30: R\$ 21,38 45: R\$ 21,81 60: R\$ 22,24



LIVRO DE BANHO A FAZENDA SOM DOS ANIMAIS
Código: 46637 Fábrica: CIRANDACULT Unidade: UN/1 F1 F4

UN: R\$ 20,53 AV: R\$ 20,53 15: R\$ 20,96
30: R\$ 21,38 45: R\$ 21,81 60: R\$ 22,24



LIVRO DE BANHO ANIMAIS CRIACOES DEUS
Código: 46636 Fábrica: CIRANDACULT Unidade: UN/1 F1 F4

UN: R\$ 20,53 AV: R\$ 20,53 15: R\$ 20,96
30: R\$ 21,38 45: R\$ 21,81 60: R\$ 22,24



LIVRO DE BANHO ANIMAIS DA SELVA
Código: 46635 Fábrica: CIRANDACULT Unidade: UN/1 F1 F4

UN: R\$ 20,53 AV: R\$ 20,53 15: R\$ 20,96
30: R\$ 21,38 45: R\$ 21,81 60: R\$ 22,24



LIVRO DE BANHO FISHER PRICE ELEFANTE
Código: 46639 Fábrica: CIRANDACULT Unidade: UN/1 F1 F4

UN: R\$ 20,53 AV: R\$ 20,53 15: R\$ 20,96
30: R\$ 21,38 45: R\$ 21,81 60: R\$ 22,24



LIVRO DE BANHO FISHER PRICE GIRAFA
Código: 46638 Fábrica: CIRANDACULT Unidade: UN/1 F1 F4

UN: R\$ 20,53 AV: R\$ 20,53 15: R\$ 20,96
30: R\$ 21,38 45: R\$ 21,81 60: R\$ 22,24



LIVRO DE BANHO NUMEROS
Código: 46641 Fábrica: CIRANDACULT Unidade: UN/1 F1 F4

UN: R\$ 20,53 AV: R\$ 20,53 15: R\$ 20,96
30: R\$ 21,38 45: R\$ 21,81 60: R\$ 22,24

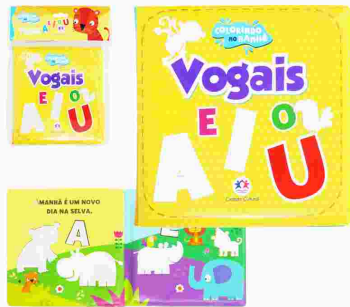

LIVRO DE BANHO VOGAIS
Código: 46640 Fábrica: CIRANDACULT Unidade: UN/1 F1 F4

UN: R\$ 3,15 AV: R\$ 31,45 15: R\$ 32,11
30: R\$ 32,75 45: R\$ 33,41 60: R\$ 34,07



LIVRO ECOG CLASSICOS INESQUECIVEIS 10X1
Código: 48463 Fábrica: TODOLIVRO Unidade: PT/10 F1 F4

UN: R\$ 3,15 AV: R\$ 31,45 15: R\$ 32,11
30: R\$ 32,75 45: R\$ 33,41 60: R\$ 34,07



LIVRO ECOG COLORINDO HIST CLASSICAS 10X1
Código: 48464 Fábrica: TODOLIVRO Unidade: PT/10 F1 F4

UN: R\$ 3,15 AV: R\$ 31,45 15: R\$ 32,11
30: R\$ 32,75 45: R\$ 33,41 60: R\$ 34,07



LIVRO ECOG COLORINDO HIST DA BIBLIA 10X1
Código: 48465 Fábrica: TODOLIVRO Unidade: UN/1 F1 F4

UN: R\$ 3,15 AV: R\$ 31,45 15: R\$ 32,11
30: R\$ 32,75 45: R\$ 33,41 60: R\$ 34,07



LIVRO ECOG FESTA DAS CORES 10X1
Código: 48466 Fábrica: TODOLIVRO Unidade: PT/10 F1 F4

UN: R\$ 3,93 AV: R\$ 31,45 15: R\$ 32,11
30: R\$ 32,75 45: R\$ 33,41 60: R\$ 34,07



LIVRO ECOG HIST BIBLICAS FAVORITAS 8X1
Código: 48467 Fábrica: TODOLIVRO Unidade: PT/8 F1 F4

UN: R\$ 1,44 AV: R\$ 14,37 15: R\$ 14,67
30: R\$ 14,96 45: R\$ 15,26 60: R\$ 15,57



LIVRO ECOM AVENTURA SERES DO MAR 10X1
Código: 48468 Fábrica: TODOLIVRO Unidade: PT/10 F1 F4

UN: R\$ 1,44 AV: R\$ 14,37 15: R\$ 14,67
30: R\$ 14,96 45: R\$ 15,26 60: R\$ 15,57



LIVRO ECOM BRINCANDO C/AS CORES 10X1
Código: 48469 Fábrica: TODOLIVRO Unidade: PT/10 F1 F4

UN: R\$ 1,44 AV: R\$ 14,37 15: R\$ 14,67
30: R\$ 14,96 45: R\$ 15,26 60: R\$ 15,57



LIVRO ECOM BRINCANDO DE COLORIR 10X1
Código: 48470 Fábrica: TODOLIVRO Unidade: PT/10 F1 F4

UN: R\$ 1,44 AV: R\$ 14,37 15: R\$ 14,67
30: R\$ 14,96 45: R\$ 15,26 60: R\$ 15,57



LIVRO ECOM CLASSICOS ADORAVEIS III 10X1
Código: 48471 Fábrica: TODOLIVRO Unidade: PT/10 F1 F4

UN: R\$ 1,44 AV: R\$ 14,37 15: R\$ 14,67
30: R\$ 14,96 45: R\$ 15,26 60: R\$ 15,57



LIVRO ECOM CLASSICOS DA BIBLIA 10X1

Código: Fábrika: Unidade:
48472 TODOLIVRO PT/10
F1 F4

UN: R\$ 1,44 AV: R\$ 14,37 15: R\$ 14,67
30: R\$ 14,96 45: R\$ 15,26 60: R\$ 15,57



LIVRO ECOM COLORIR BRINCAR ANIMAIS 10X1

Código: Fábrika: Unidade:
48473 TODOLIVRO PT/10
F1 F4

UN: R\$ 1,44 AV: R\$ 14,37 15: R\$ 14,67
30: R\$ 14,96 45: R\$ 15,26 60: R\$ 15,57



LIVRO ECOM DINOSSAUROS OS GIGANTES 10X1

Código: Fábrika: Unidade:
48474 TODOLIVRO PT/10
F1 F4

UN: R\$ 1,44 AV: R\$ 14,37 15: R\$ 14,67
30: R\$ 14,96 45: R\$ 15,26 60: R\$ 15,57



LIVRO ECOM FESTA DAS CORES 10X1

Código: Fábrika: Unidade:
48475 TODOLIVRO PT/10
F1 F4

UN: R\$ 1,44 AV: R\$ 14,37 15: R\$ 14,67
30: R\$ 14,96 45: R\$ 15,26 60: R\$ 15,57



LIVRO ECOM FOLCLORE CONTOS E CANTOS 10X1

Código: Fábrika: Unidade:
48478 TODOLIVRO PT/10
F1 F4

UN: R\$ 1,44 AV: R\$ 14,37 15: R\$ 14,67
30: R\$ 14,96 45: R\$ 15,26 60: R\$ 15,57



LIVRO ECOM HISTORIAS ENCANTADAS 10X1

Código: Fábrika: Unidade:
48479 TODOLIVRO PT/10
F1 F4

UN: R\$ 1,44 AV: R\$ 14,37 15: R\$ 14,67
30: R\$ 14,96 45: R\$ 15,26 60: R\$ 15,57



LIVRO ECOM MUNDO ENCANTADO PRINCESAS 10X1

Código: Fábrika: Unidade:
48476 TODOLIVRO PT/10
F1 F4

UN: R\$ 1,44 AV: R\$ 14,37 15: R\$ 14,67
30: R\$ 14,96 45: R\$ 15,26 60: R\$ 15,57



LIVRO ECOM UM MUNDO DE AVENTURAS 10X1

Código: Fábrika: Unidade:
48477 TODOLIVRO PT/10
F1 F4

UN: R\$ 25,67 AV: R\$ 25,67 15: R\$ 26,20
30: R\$ 26,73 45: R\$ 27,26 60: R\$ 27,81



LIVRO ESCOLINHA C/BLOCO A4 CRIATIVO

Código: Fábrika: Unidade:
48480 TODOLIVRO UN/1
F1 F4

UN: R\$ 5,13 AV: R\$ 5,13 15: R\$ 5,23
30: R\$ 5,34 45: R\$ 5,44 60: R\$ 5,55



LIVRO ESCOLINHA TABUADA COMPLETA

Código: Fábrika: Unidade:
48481 TODOLIVRO UN/1
F1 F4

UN: R\$ 2,56 AV: R\$ 2,56 15: R\$ 2,61
30: R\$ 2,66 45: R\$ 2,72 60: R\$ 2,77



LIVRO GIBI CLASSIC A BELA ADORMECIDA

Código: Fábrika: Unidade:
48489 TODOLIVRO UN/1
F1 F4

UN: R\$ 2,56 AV: R\$ 2,56 15: R\$ 2,61
30: R\$ 2,66 45: R\$ 2,72 60: R\$ 2,77



LIVRO GIBI CLASSIC A BELA E A FERA

Código: Fábrika: Unidade:
48485 TODOLIVRO UN/1
F1 F4

UN: R\$ 2,56 AV: R\$ 2,56 15: R\$ 2,61
30: R\$ 2,66 45: R\$ 2,72 60: R\$ 2,77

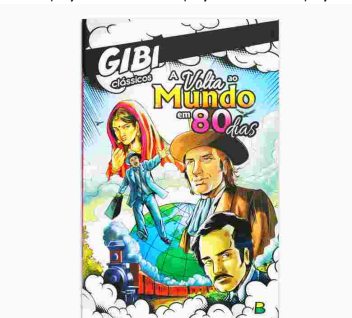

LIVRO GIBI CLASSIC A VOLTA AO MUNDO 80 D

Código: Fábrika: Unidade:
48496 TODOLIVRO UN/1
F1 F4

UN: R\$ 2,56 AV: R\$ 2,56 15: R\$ 2,61
30: R\$ 2,66 45: R\$ 2,72 60: R\$ 2,77



LIVRO GIBI CLASSIC ALICE PARAISO MARAVIL

Código: Fábrika: Unidade:
48488 TODOLIVRO UN/1
F1 F4

UN: R\$ 2,56 AV: R\$ 2,56 15: R\$ 2,61
30: R\$ 2,66 45: R\$ 2,72 60: R\$ 2,77



LIVRO GIBI CLASSIC BRANCA DE NEVE 7 ANOS

Código: Fábrika: Unidade:
48490 TODOLIVRO UN/1
F1 F4

UN: R\$ 2,56 AV: R\$ 2,56 15: R\$ 2,61
30: R\$ 2,66 45: R\$ 2,72 60: R\$ 2,77



LIVRO GIBI CLASSIC DA SELVA

Código: Fábrika: Unidade:
48492 TODOLIVRO UN/1
F1 F4

UN: R\$ 2,56 AV: R\$ 2,56 15: R\$ 2,61
30: R\$ 2,66 45: R\$ 2,72 60: R\$ 2,77



LIVRO GIBI CLASSIC O GATO DE BOTAS
Código: Fábrica: Unidade:
48491 TODOLIVRO UN/1
F1 F4

UN: R\$ 2,56 AV: R\$ 2,56 15: R\$ 2,61
30: R\$ 2,66 45: R\$ 2,72 60: R\$ 2,77

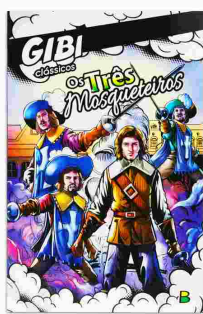

LIVRO GIBI CLASSIC OS TRES MOSQUETEIROS
Código: Fábrica: Unidade:
48494 TODOLIVRO UN/1
F1 F4

UN: R\$ 2,56 AV: R\$ 2,56 15: R\$ 2,61
30: R\$ 2,66 45: R\$ 2,72 60: R\$ 2,77



LIVRO GIBI CLASSIC OS TRES PORQUINHOS
Código: Fábrica: Unidade:
48495 TODOLIVRO UN/1
F1 F4

UN: R\$ 2,56 AV: R\$ 2,56 15: R\$ 2,61
30: R\$ 2,66 45: R\$ 2,72 60: R\$ 2,77



LIVRO GIBI CLASSIC PETER PAN
Código: Fábrica: Unidade:
48493 TODOLIVRO UN/1
F1 F4

UN: R\$ 1,28 AV: R\$ 10,26 15: R\$ 10,48
30: R\$ 10,69 45: R\$ 10,90 60: R\$ 11,12



LIVRO HIST/ATIV/COLOR PEPPA PIG 8X1
Código: Fábrica: Unidade:
46634 CIRANDACULT PT/8
F1 F4

UN: R\$ 1,28 AV: R\$ 10,26 15: R\$ 10,48
30: R\$ 10,69 45: R\$ 10,90 60: R\$ 11,12



LIVRO HIST/ATIV/COLORIR HIST BIBLICA 8X1
Código: Fábrica: Unidade:
38108 CIRANDACULT PT/8
F1 F4

UN: R\$ 1,28 AV: R\$ 10,26 15: R\$ 10,48
30: R\$ 10,69 45: R\$ 10,90 60: R\$ 11,12



LIVRO HIST/ATIV/COLORIR TURMA MONICA 8X1
Código: Fábrica: Unidade:
46633 CIRANDACULT PT/8
F1 F4

UN: R\$ 1,28 AV: R\$ 10,26 15: R\$ 10,48
30: R\$ 10,69 45: R\$ 10,90 60: R\$ 11,12



LIVRO HIST/ATIV/COLORIR TURMA MONICA 8X1
Código: Fábrica: Unidade:
46628 CIRANDACULT PT/8
F1 F4

UN: R\$ 18,48 AV: R\$ 18,48 15: R\$ 18,86
30: R\$ 19,24 45: R\$ 19,63 60: R\$ 20,02



LIVRO PAW PATROL NEON COLORIND C/CANETA
Código: Fábrica: Unidade:
49714 IBC UN/1
F1 F4

UN: R\$ 41,08 AV: R\$ 41,08 15: R\$ 41,93
30: R\$ 42,77 45: R\$ 43,63 60: R\$ 44,50



LIVRO PLAY QUEBRA CAB 18PCS FAZENDA
Código: Fábrica: Unidade:
48498 TODOLIVRO UN/1
F1 F4

UN: R\$ 41,08 AV: R\$ 41,08 15: R\$ 41,93
30: R\$ 42,77 45: R\$ 43,63 60: R\$ 44,50



LIVRO PLAY QUEBRA CAB 18PCS MAMAES FILHO
Código: Fábrica: Unidade:
48500 TODOLIVRO UN/1
F1 F4

UN: R\$ 41,08 AV: R\$ 41,08 15: R\$ 41,93
30: R\$ 42,77 45: R\$ 43,63 60: R\$ 44,50



LIVRO PLAY QUEBRA CAB 18PCS OPOSTOS
Código: Fábrica: Unidade:
48501 TODOLIVRO UN/1
F1 F4

UN: R\$ 41,08 AV: R\$ 41,08 15: R\$ 41,93
30: R\$ 42,77 45: R\$ 43,63 60: R\$ 44,50



LIVRO PLAY QUEBRA CAB 35PCS ALFABETO
Código: Fábrica: Unidade:
48497 TODOLIVRO UN/1
F1 F4

UN: R\$ 41,08 AV: R\$ 41,08 15: R\$ 41,93
30: R\$ 42,77 45: R\$ 43,63 60: R\$ 44,50



LIVRO PLAY QUEBRA CAB 35PCS CORPO HUMANO
Código: Fábrica: Unidade:
48499 TODOLIVRO UN/1
F1 F4

UN: R\$ 41,08 AV: R\$ 41,08 15: R\$ 41,93
30: R\$ 42,77 45: R\$ 43,63 60: R\$ 44,50



LIVRO PLAY QUEBRA CAB 36PCS EMOCOES
Código: Fábrica: Unidade:
48502 TODOLIVRO UN/1
F1 F4

UN: R\$ 41,08 AV: R\$ 41,08 15: R\$ 41,93
30: R\$ 42,77 45: R\$ 43,63 60: R\$ 44,50



LIVRO PLAY QUEBRA CAB 60PCS SILABAS
Código: Fábrica: Unidade:
48503 TODOLIVRO UN/1
F1 F4

UN: R\$ 24,64 AV: R\$ 24,64 15: R\$ 25,16
30: R\$ 25,66 45: R\$ 26,17 60: R\$ 26,70

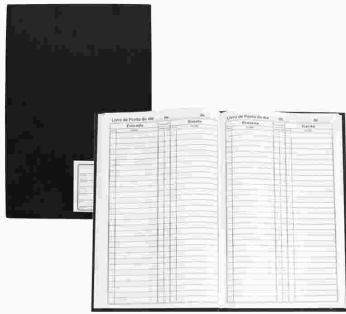

LIVRO PONTO 50 FLS 2 ASSINATURAS GDE UN
Código: 48872 Fábrica: GRIFFE Unidade: UN/1
F1 F4

UN: R\$ 26,70 AV: R\$ 26,70 15: R\$ 27,25
30: R\$ 27,80 45: R\$ 28,35 60: R\$ 28,92

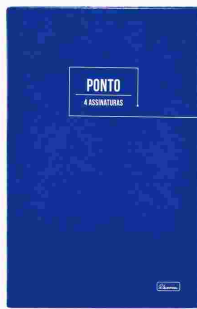

LIVRO PONTO 50 FLS 4 ASSINATURAS NUM UN
Código: 48344 Fábrica: PAGINABRASIL Unidade: UN/1
F1 F4

UN: R\$ 17,15 AV: R\$ 17,15 15: R\$ 17,51
30: R\$ 17,86 45: R\$ 18,22 60: R\$ 18,58



LIVRO POP-UPS BARBIE UMA AVENTURA MAGICA
Código: 38092 Fábrica: CIRANDACULT Unidade: UN/1
F1 F4

UN: R\$ 17,15 AV: R\$ 17,15 15: R\$ 17,51
30: R\$ 17,86 45: R\$ 18,22 60: R\$ 18,58



LIVRO POP-UPS TURMA DA MONICA
Código: 38093 Fábrica: CIRANDACULT Unidade: UN/1
F1 F4

UN: R\$ 14,37 AV: R\$ 14,37 15: R\$ 14,67
30: R\$ 14,96 45: R\$ 15,26 60: R\$ 15,57

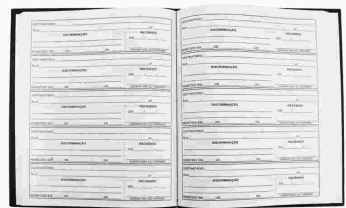

LIVRO PROTOCOLO CORRESP CD 100FL UN
Código: 42786 Fábrica: GRIFFE Unidade: UN/1
F1 F4

UN: R\$ 17,36 AV: R\$ 86,80 15: R\$ 88,61
30: R\$ 90,38 45: R\$ 92,19 60: R\$ 94,03

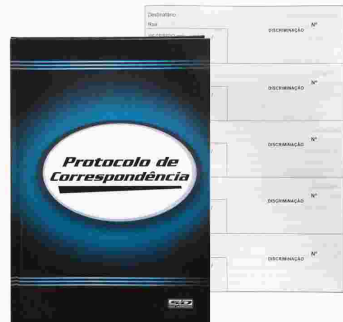

LIVRO PROTOCOLO CORRESP CD 104 FL 5X1
Código: 36820 Fábrica: SAO DOMINGOS Unidade: PT/5
F1 F4

UN: R\$ 17,36 AV: R\$ 86,80 15: R\$ 88,61
30: R\$ 90,38 45: R\$ 92,19 60: R\$ 94,03



LIVRO PROTOCOLO CORRESP 1/4 CD 100F 5X1
Código: 42384 Fábrica: PAGINA BRASI Unidade: PT/5
F1 F4

UN: R\$ 17,45 AV: R\$ 17,45 15: R\$ 17,82
30: R\$ 18,17 45: R\$ 18,54 60: R\$ 18,91



LIVRO SONIC HORA ALEGRIA C/LAPIS COR 084
Código: 49713 Fábrica: IBC Unidade: UN/1
F1 F4

UN: R\$ 18,52 AV: R\$ 18,52 15: R\$ 18,91
30: R\$ 19,29 45: R\$ 19,67 60: R\$ 20,07



MALETA POLIONDA 4 CM AZUL PASTEL
Código: 9793 Fábrica: ALAPLAST Unidade: UN/1
F1 F4

UN: R\$ 18,52 AV: R\$ 18,52 15: R\$ 18,91
30: R\$ 19,29 45: R\$ 19,67 60: R\$ 20,07



MALETA POLIONDA 4 CM PRETO
Código: 44330 Fábrica: ALAPLAST Unidade: UN/1
F1 F4

UN: R\$ 18,52 AV: R\$ 18,52 15: R\$ 18,91
30: R\$ 19,29 45: R\$ 19,67 60: R\$ 20,07



MALETA POLIONDA 4 CM ROSA PASTEL
Código: 9867 Fábrica: ALAPLAST Unidade: UN/1
F1 F4

UN: R\$ 18,52 AV: R\$ 18,52 15: R\$ 18,91
30: R\$ 19,29 45: R\$ 19,67 60: R\$ 20,07



MALETA POLIONDA 4 CM VERDE PASTEL
Código: 9791 Fábrica: ALAPLAST Unidade: UN/1
F1 F4

UN: R\$ 28,30 AV: R\$ 28,30 15: R\$ 28,89
30: R\$ 29,47 45: R\$ 30,06 60: R\$ 30,66



MALETA PP OFICIO C/ALCA MARIO 2281
Código: 41274 Fábrica: DAC Unidade: UN/1
F1 F4

UN: R\$ 33,02 AV: R\$ 33,02 15: R\$ 33,71
30: R\$ 34,38 45: R\$ 35,07 60: R\$ 35,77



MALETA PP OFICIO C/ALCA BATMAN 2826
Código: 41271 Fábrica: DAC Unidade: UN/1
F1 F4

UN: R\$ 28,30 AV: R\$ 28,30 15: R\$ 28,89
30: R\$ 29,47 45: R\$ 30,06 60: R\$ 30,66



MALETA PP OFICIO C/ALCA CARROS 2545
Código: 41272 Fábrica: DAC Unidade: UN/1
F1 F4

UN: R\$ 28,30 AV: R\$ 28,30 15: R\$ 28,89
30: R\$ 29,47 45: R\$ 30,06 60: R\$ 30,66



MALETA PP OFICIO C/ALCA MIRACULOUS CAT
Código: 41277 Fábrica: DAC Unidade: UN/1
F1 F4

UN: R\$ 28,30 AV: R\$ 28,30 15: R\$ 28,89
30: R\$ 29,47 45: R\$ 30,06 60: R\$ 30,66



MALETA PP OFICIO C/ALCA MIRACULOUS 2607
Código: Fábrica: Unidade:
41276 DAC UN/1
F1 F4

UN: R\$ 28,30 AV: R\$ 28,30 15: R\$ 28,89
30: R\$ 29,47 45: R\$ 30,06 60: R\$ 30,66



MALETA PP OFICIO C/ALCA PAW PATROL FEM
Código: Fábrica: Unidade:
41278 DAC UN/1
F1 F4

UN: R\$ 46,21 AV: R\$ 46,21 15: R\$ 47,18
30: R\$ 48,12 45: R\$ 49,08 60: R\$ 50,06



MAQUINA ETIQUETADORA 8 DIG MX5500
Código: Fábrica: Unidade:
17620 HAI BRASIL UN/1
F1 F4

UN: R\$ 60,19 AV: R\$ 60,19 15: R\$ 61,45
30: R\$ 62,68 45: R\$ 63,93 60: R\$ 65,21



MAQUINA ETIQUETADORA 8 DIG MX5500 6505
Código: Fábrica: Unidade:
45943 WIN PAPER UN/1
F1 F4

UN: R\$ 44,43 AV: R\$ 44,43 15: R\$ 45,35
30: R\$ 46,26 45: R\$ 47,18 60: R\$ 48,13



MAQUINA ETIQUETADORA 8 DIG 10326
Código: Fábrica: Unidade:
48723 LETRON UN/1
F1 F4

UN: R\$ 821,75 AV: R\$ 821,75 15: R\$ 838,87
30: R\$ 855,65 45: R\$ 872,76 60: R\$ 890,22



MAQUINA PLASTIFICADORA BIVOLT OFICIO 280
Código: Fábrica: Unidade:
17077 MAROGER UN/1
F1 F4

UN: R\$ 1,26 AV: R\$ 15,08 15: R\$ 15,40
30: R\$ 15,70 45: R\$ 16,02 60: R\$ 16,34



MARCA TEXTO DASHLIGHT AMARELO 2201 12X1
Código: Fábrica: Unidade:
47850 BRW DZ/12
F1 F4

UN: R\$ 1,26 AV: R\$ 15,08 15: R\$ 15,40
30: R\$ 15,70 45: R\$ 16,02 60: R\$ 16,34



MARCA TEXTO DASHLIGHT LARANJA 2204 12X1
Código: Fábrica: Unidade:
47853 BRW DZ/12
F1 F4

UN: R\$ 1,26 AV: R\$ 15,08 15: R\$ 15,40
30: R\$ 15,70 45: R\$ 16,02 60: R\$ 16,34



MARCA TEXTO DASHLIGHT ROSA 2202 12X1
Código: Fábrica: Unidade:
47851 BRW DZ/12
F1 F4

UN: R\$ 1,26 AV: R\$ 15,08 15: R\$ 15,40
30: R\$ 15,70 45: R\$ 16,02 60: R\$ 16,34



MARCA TEXTO DASHLIGHT VERDE 2203 12X1
Código: Fábrica: Unidade:
47852 BRW DZ/12
F1 F4

UN: R\$ 1,37 AV: R\$ 8,21 15: R\$ 8,38
30: R\$ 8,55 45: R\$ 8,72 60: R\$ 8,89



MARCA TEXTO FLUOR AMARELO 6X1
Código: Fábrica: Unidade:
44271 M COMERCIO CT/6
F1 F4

UN: R\$ 1,73 AV: R\$ 20,76 15: R\$ 21,19
30: R\$ 21,62 45: R\$ 22,05 60: R\$ 22,49



MARCA TEXTO FLUOR AMARELO 612 12X1
Código: Fábrica: Unidade:
41734 MASTERPRINT DZ/12
F1 F4

UN: R\$ 1,22 AV: R\$ 14,62 15: R\$ 14,92
30: R\$ 15,22 45: R\$ 15,53 60: R\$ 15,84



MARCA TEXTO FLUOR AMARELO 617947 12X1
Código: Fábrica: Unidade:
48315 BAZZE DZ/12
F1 F4

UN: R\$ 1,31 AV: R\$ 31,34 15: R\$ 31,99
30: R\$ 32,63 45: R\$ 33,28 60: R\$ 33,95



MARCA TEXTO FLUOR AMAR/VERDE/LARANJ 24X1
Código: Fábrica: Unidade:
48317 BAZZE CX/24
F1 F4

UN: R\$ 1,73 AV: R\$ 20,76 15: R\$ 21,19
30: R\$ 21,62 45: R\$ 22,05 60: R\$ 22,49



MARCA TEXTO FLUOR AZUL 612 12X1
Código: Fábrica: Unidade:
42887 MASTERPRINT DZ/12
F1 F4

UN: R\$ 2,93 AV: R\$ 2,93 15: R\$ 2,99
30: R\$ 3,05 45: R\$ 3,11 60: R\$ 3,17



MARCA TEXTO FLUOR GEL AMARELO UN
Código: Fábrica: Unidade:
35733 MASTERPRINT CR/1
F1 F4

UN: R\$ 4,06 AV: R\$ 24,37 15: R\$ 24,88
30: R\$ 25,38 45: R\$ 25,88 60: R\$ 26,40



MARCA TEXTO FLUOR GEL AMARELO 613 6X1
Código: Fábrika: Unidade:
42585 MASTERPRINT CX/6
F1 F4

UN: R\$ 4,95 AV: R\$ 59,45 15: R\$ 60,69
30: R\$ 61,91 45: R\$ 63,15 60: R\$ 64,41



MARCA TEXTO FLUOR GEL AMARELO 9001 12X1
Código: Fábrika: Unidade:
20361 BRW DZ/12
F1 F4

UN: R\$ 4,06 AV: R\$ 24,37 15: R\$ 24,88
30: R\$ 25,38 45: R\$ 25,88 60: R\$ 26,40



MARCA TEXTO FLUOR GEL LARANJA 613 6X1
Código: Fábrika: Unidade:
48906 MASTERPRINT CX/6
F1 F4

UN: R\$ 4,95 AV: R\$ 59,45 15: R\$ 60,69
30: R\$ 61,91 45: R\$ 63,15 60: R\$ 64,41



MARCA TEXTO FLUOR GEL LARANJA 9004 12X1
Código: Fábrika: Unidade:
50667 BRW DZ/12
F1 F4

UN: R\$ 4,06 AV: R\$ 24,37 15: R\$ 24,88
30: R\$ 25,38 45: R\$ 25,88 60: R\$ 26,40



MARCA TEXTO FLUOR GEL ROSA 613 6X1
Código: Fábrika: Unidade:
48905 MASTERPRINT CX/6
F1 F4

UN: R\$ 4,95 AV: R\$ 59,45 15: R\$ 60,69
30: R\$ 61,91 45: R\$ 63,15 60: R\$ 64,41



MARCA TEXTO FLUOR GEL ROSA 9002 12X1
Código: Fábrika: Unidade:
50668 BRW DZ/12
F1 F4

UN: R\$ 1,73 AV: R\$ 20,76 15: R\$ 21,19
30: R\$ 21,62 45: R\$ 22,05 60: R\$ 22,49



MARCA TEXTO FLUOR LARANJA 612 12X1
Código: Fábrika: Unidade:
42886 MASTERPRINT DZ/12
F1 F4

UN: R\$ 1,22 AV: R\$ 14,62 15: R\$ 14,92
30: R\$ 15,22 45: R\$ 15,53 60: R\$ 15,84



MARCA TEXTO FLUOR LARANJA 900074 12X1
Código: Fábrika: Unidade:
48316 BAZZE DZ/12
F1 F4

UN: R\$ 1,73 AV: R\$ 20,76 15: R\$ 21,19
30: R\$ 21,62 45: R\$ 22,05 60: R\$ 22,49



MARCA TEXTO FLUOR ROSA 612 12X1
Código: Fábrika: Unidade:
42889 MASTERPRINT DZ/12
F1 F4

UN: R\$ 1,22 AV: R\$ 14,62 15: R\$ 14,92
30: R\$ 15,22 45: R\$ 15,53 60: R\$ 15,84



MARCA TEXTO FLUOR ROSA 904645 12X1
Código: Fábrika: Unidade:
48444 BAZZE DZ/12
F1 F4

UN: R\$ 1,53 AV: R\$ 18,37 15: R\$ 18,75
30: R\$ 19,12 45: R\$ 19,51 60: R\$ 19,90



MARCA TEXTO FLUOR VERDE 2003 12X1
Código: Fábrika: Unidade:
41085 BRW DZ/12
F1 F4

UN: R\$ 1,73 AV: R\$ 20,76 15: R\$ 21,19
30: R\$ 21,62 45: R\$ 22,05 60: R\$ 22,49



MARCA TEXTO FLUOR VERDE 612 12X1
Código: Fábrika: Unidade:
42885 MASTERPRINT DZ/12
F1 F4

UN: R\$ 1,22 AV: R\$ 14,62 15: R\$ 14,92
30: R\$ 15,22 45: R\$ 15,53 60: R\$ 15,84



MARCA TEXTO FLUOR VERDE 617961 12X1
Código: Fábrika: Unidade:
48810 BAZZE DZ/12
F1 F4

UN: R\$ 1,53 AV: R\$ 18,37 15: R\$ 18,75
30: R\$ 19,12 45: R\$ 19,51 60: R\$ 19,90



MARCA TEXTO FLUOR VERMELHO 2007 12X1
Código: Fábrika: Unidade:
19731 BRW DZ/12
F1 F4

UN: R\$ 1,73 AV: R\$ 20,76 15: R\$ 21,19
30: R\$ 21,62 45: R\$ 22,05 60: R\$ 22,49



MARCA TEXTO FLUOR VERMELHO 612 12X1
Código: Fábrika: Unidade:
42888 MASTERPRINT DZ/12
F1 F4

UN: R\$ 2,71 AV: R\$ 16,24 15: R\$ 16,58
30: R\$ 16,91 45: R\$ 17,25 60: R\$ 17,60



MARCA TEXTO METALICO SORT 612 6X1
Código: Fábrika: Unidade:
50007 MASTERPRINT CX/6
F1 F4

UN: R\$ 0,97 AV: R\$ 11,69 15: R\$ 11,93
30: R\$ 12,17 45: R\$ 12,42 60: R\$ 12,66



MARCA TEXTO NEON SLIM AMARELO 614 12X1
Código: Fábrica: Unidade:
51053 MASTERPRINT DZ/12
F1 F4

UN: R\$ 1,95 AV: R\$ 11,69 15: R\$ 11,93
30: R\$ 12,17 45: R\$ 12,42 60: R\$ 12,66



MARCA TEXTO NEON SLIM AZUL 614 12X1
Código: Fábrica: Unidade:
51055 MASTERPRINT DZ/12
F1 F4

UN: R\$ 0,97 AV: R\$ 11,69 15: R\$ 11,93
30: R\$ 12,17 45: R\$ 12,42 60: R\$ 12,66



MARCA TEXTO NEON SLIM LARANJA 614 12X1
Código: Fábrica: Unidade:
51057 MASTERPRINT DZ/12
F1 F4

UN: R\$ 0,97 AV: R\$ 11,69 15: R\$ 11,93
30: R\$ 12,17 45: R\$ 12,42 60: R\$ 12,66



MARCA TEXTO NEON SLIM ROSA 614 12X1
Código: Fábrica: Unidade:
51056 MASTERPRINT DZ/12
F1 F4

UN: R\$ 1,33 AV: R\$ 7,96 15: R\$ 8,13
30: R\$ 8,29 45: R\$ 8,46 60: R\$ 8,62



MARCA TEXTO NEON SLIM SORT 610 6X1
Código: Fábrica: Unidade:
51051 MASTERPRINT PT/6
F1 F4

UN: R\$ 0,97 AV: R\$ 11,69 15: R\$ 11,93
30: R\$ 12,17 45: R\$ 12,42 60: R\$ 12,66



MARCA TEXTO NEON SLIM VERDE 614 12X1
Código: Fábrica: Unidade:
51054 MASTERPRINT DZ/12
F1 F4

UN: R\$ 1,87 AV: R\$ 11,22 15: R\$ 11,45
30: R\$ 11,68 45: R\$ 11,91 60: R\$ 12,15



MARCA TEXTO PASTEL AMARELO 612 6X1
Código: Fábrica: Unidade:
47215 MASTERPRINT CX/6
F1 F4

UN: R\$ 1,87 AV: R\$ 11,22 15: R\$ 11,45
30: R\$ 11,68 45: R\$ 11,91 60: R\$ 12,15



MARCA TEXTO PASTEL AZUL 612 6X1
Código: Fábrica: Unidade:
47216 MASTERPRINT CX/6
F1 F4

UN: R\$ 1,87 AV: R\$ 11,22 15: R\$ 11,45
30: R\$ 11,68 45: R\$ 11,91 60: R\$ 12,15



MARCA TEXTO PASTEL ROSE 612 6X1
Código: Fábrica: Unidade:
47217 MASTERPRINT CX/6
F1 F4

UN: R\$ 1,33 AV: R\$ 7,96 15: R\$ 8,13
30: R\$ 8,29 45: R\$ 8,46 60: R\$ 8,62



MARCA TEXTO PASTEL SLIM SORT 611 6X1
Código: Fábrica: Unidade:
51052 MASTERPRINT PT/6
F1 F4

UN: R\$ 1,87 AV: R\$ 11,22 15: R\$ 11,45
30: R\$ 11,68 45: R\$ 11,91 60: R\$ 12,15



MARCA TEXTO PASTEL VERDE 612 6X1
Código: Fábrica: Unidade:
47218 MASTERPRINT CX/6
F1 F4

UN: R\$ 5,13 AV: R\$ 5,13 15: R\$ 5,23
30: R\$ 5,34 45: R\$ 5,44 60: R\$ 5,55



MARCADOR DETECTA DH FALSO 4915014
Código: Fábrica: Unidade:
46775 ONDA CT/1
F1 F4

UN: R\$ 2,35 AV: R\$ 2,35 15: R\$ 2,40
30: R\$ 2,45 45: R\$ 2,50 60: R\$ 2,55



MASSA MODELAR 6 CORES 65 GRS 216
Código: Fábrica: Unidade:
33833 MAGIX UN/1
F1 F4

UN: R\$ 4,88 AV: R\$ 4,88 15: R\$ 4,98
30: R\$ 5,08 45: R\$ 5,18 60: R\$ 5,29



MASSA MODELAR 6 CORES 60 GRS PLASTI UN
Código: Fábrica: Unidade:
45018 ACRILEX UN/1
F1 F4

UN: R\$ 5,96 AV: R\$ 5,96 15: R\$ 6,08
30: R\$ 6,20 45: R\$ 6,33 60: R\$ 6,45



MASSA MODELAR 6 CORES 90 GRS PLASTI UN
Código: Fábrica: Unidade:
45017 ACRILEX UN/1
F1 F4

UN: R\$ 3,65 AV: R\$ 3,65 15: R\$ 3,72
30: R\$ 3,80 45: R\$ 3,87 60: R\$ 3,95



MASSA MODELAR 6 CORES 90 GRS SOFT UN
Código: Fábrica: Unidade:
36061 ACRILEX UN/1
F1 F4

UN: R\$ 79,08 AV: R\$ 79,08 15: R\$ 80,73
30: R\$ 82,35 45: R\$ 83,99 60: R\$ 85,67



MASSA MODELAR BALDE C/36UN 2,100KG
Código: 47394 Fábrica: APLICOR Unidade: UN/1 F1 F4

UN: R\$ 16,42 AV: R\$ 16,42 15: R\$ 16,77
30: R\$ 17,10 45: R\$ 17,44 60: R\$ 17,79



MASSA MODELAR POTE 500 GRS AMARELO 241
Código: 50997 Fábrica: MAGIX Unidade: UN/1 F1 F4

UN: R\$ 16,42 AV: R\$ 16,42 15: R\$ 16,77
30: R\$ 17,10 45: R\$ 17,44 60: R\$ 17,79



MASSA MODELAR POTE 500 GRS AZUL 248
Código: 50999 Fábrica: MAGIX Unidade: UN/1 F1 F4

UN: R\$ 16,42 AV: R\$ 16,42 15: R\$ 16,77
30: R\$ 17,10 45: R\$ 17,44 60: R\$ 17,79



MASSA MODELAR POTE 500 GRS BRANCO 247
Código: 50996 Fábrica: MAGIX Unidade: UN/1 F1 F4

UN: R\$ 16,42 AV: R\$ 16,42 15: R\$ 16,77
30: R\$ 17,10 45: R\$ 17,44 60: R\$ 17,79



MASSA MODELAR POTE 500 GRS ROSA 245
Código: 51001 Fábrica: MAGIX Unidade: UN/1 F1 F4

UN: R\$ 16,42 AV: R\$ 16,42 15: R\$ 16,77
30: R\$ 17,10 45: R\$ 17,44 60: R\$ 17,79



MASSA MODELAR POTE 500 GRS VERDE CLA 243
Código: 50998 Fábrica: MAGIX Unidade: UN/1 F1 F4

UN: R\$ 4,92 AV: R\$ 4,92 15: R\$ 5,02
30: R\$ 5,12 45: R\$ 5,23 60: R\$ 5,33



MASSA MODELAR 12 CORES 130 GRS 215
Código: 41010 Fábrica: MAGIX Unidade: UN/1 F1 F4

UN: R\$ 10,26 AV: R\$ 10,26 15: R\$ 10,48
30: R\$ 10,69 45: R\$ 10,90 60: R\$ 11,12



MASSA MODELAR 12 CORES 180 GRS PLASTI UN
Código: 45016 Fábrica: ACRILEX Unidade: UN/1 F1 F4

UN: R\$ 4,75 AV: R\$ 4,75 15: R\$ 4,75
30: R\$ 4,75 45: R\$ 4,75 60: R\$ 4,75



MASSA MODELAR 12 CORES 180 GRS 210
Código: 36062 Fábrica: MAGIX Unidade: UN/1 F1 F4

UN: R\$ 347,52 AV: R\$ 347,52 15: R\$ 354,76
30: R\$ 361,85 45: R\$ 369,09 60: R\$ 376,47



MOCHILA CARR MH (CAPRICH) MC3446
Código: 34324 Fábrica: WOOKEY Unidade: UN/1 F1 F4

UN: R\$ 347,52 AV: R\$ 347,52 15: R\$ 354,76
30: R\$ 361,85 45: R\$ 369,09 60: R\$ 376,47



MOCHILA CARR MH (CAPRICH) MC3448
Código: 34288 Fábrica: WOOKEY Unidade: UN/1 F1 F4

UN: R\$ 289,59 AV: R\$ 289,59 15: R\$ 295,63
30: R\$ 301,54 45: R\$ 307,57 60: R\$ 313,72



MOCHILA CARR MH (CAPRICH) 3765
Código: 34250 Fábrica: VOZZ Unidade: UN/1 F1 F4

UN: R\$ 301,18 AV: R\$ 301,18 15: R\$ 307,45
30: R\$ 313,60 45: R\$ 319,87 60: R\$ 326,27



MOCHILA CARR MH (CAPRICH) 3766
Código: 34310 Fábrica: VOZZ Unidade: UN/1 F1 F4

UN: R\$ 173,75 AV: R\$ 173,75 15: R\$ 177,37
30: R\$ 180,92 45: R\$ 184,54 60: R\$ 188,23



MOCHILA CARR SUPER HOT MC3437
Código: 34252 Fábrica: VOZZ Unidade: UN/1 F1 F4

UN: R\$ 139,00 AV: R\$ 139,00 15: R\$ 141,90
30: R\$ 144,73 45: R\$ 147,63 60: R\$ 150,58



MOCHILA CARR WOOKEY MC3406
Código: 34287 Fábrica: WOOKEY Unidade: UN/1 F1 F4

UN: R\$ 324,35 AV: R\$ 324,35 15: R\$ 331,10
30: R\$ 337,73 45: R\$ 344,48 60: R\$ 351,37



MOCHILA CARR WOOKEY MC3442
Código: 34325 Fábrica: WOOKEY Unidade: UN/1 F1 F4

UN: R\$ 173,75 AV: R\$ 173,75 15: R\$ 177,37
30: R\$ 180,92 45: R\$ 184,54 60: R\$ 188,23



MOCHILA CARR WOOKEY MC3465

Código: Fábrica: Unidade:
34292 WOOKEY UN/1
F1 F4

UN: R\$ 289,59 AV: R\$ 289,59 15: R\$ 295,63
30: R\$ 301,54 45: R\$ 307,57 60: R\$ 313,72



MOCHILA CARR WOOKEY MC3690

Código: Fábrica: Unidade:
34293 WOOKEY UN/1
F1 F4

UN: R\$ 289,59 AV: R\$ 289,59 15: R\$ 295,63
30: R\$ 301,54 45: R\$ 307,57 60: R\$ 313,72



MOCHILA CARR WOOKEY MC3691

Código: Fábrica: Unidade:
34294 WOOKEY UN/1
F1 F4

UN: R\$ 173,75 AV: R\$ 173,75 15: R\$ 177,37
30: R\$ 180,92 45: R\$ 184,54 60: R\$ 188,23



MOCHILA CARR WOOKEY MC3713

Código: Fábrica: Unidade:
34298 WOOKEY UN/1
F1 F4

UN: R\$ 173,75 AV: R\$ 173,75 15: R\$ 177,37
30: R\$ 180,92 45: R\$ 184,54 60: R\$ 188,23



MOCHILA CARR WOOKEY MC3714

Código: Fábrica: Unidade:
34299 WOOKEY UN/1
F1 F4

UN: R\$ 97,58 AV: R\$ 97,58 15: R\$ 99,62
30: R\$ 101,61 45: R\$ 103,64 60: R\$ 105,71



MOCHILA CARR WOOKEY 3458

Código: Fábrica: Unidade:
34289 WOOKEY UN/1
F1 F4

UN: R\$ 208,50 AV: R\$ 208,50 15: R\$ 212,85
30: R\$ 217,11 45: R\$ 221,45 60: R\$ 225,88



MOCHILA C/CARR WOOKEY MC3693

Código: Fábrica: Unidade:
38060 WOOKEY UN/1
F1 F4

UN: R\$ 31,83 AV: R\$ 31,83 15: R\$ 32,50
30: R\$ 33,15 45: R\$ 33,81 60: R\$ 34,49



MOCHILA CONVOY CASUAL POLIESTER CO70000

Código: Fábrica: Unidade:
23649 CONVOY UN/1
F1 F4

UN: R\$ 51,35 AV: R\$ 51,35 15: R\$ 52,42
30: R\$ 53,47 45: R\$ 54,54 60: R\$ 55,63



MOCHILA CONVOY CASUAL POLIESTER YS29068

Código: Fábrica: Unidade:
34099 YIN'S UN/1
F1 F4

UN: R\$ 44,99 AV: R\$ 44,99 15: R\$ 44,99
30: R\$ 44,99 45: R\$ 44,99 60: R\$ 44,99



MOCHILA CONVOY CASUAL POLIESTER YS29071

Código: Fábrica: Unidade:
34046 YIN'S UN/1
F1 F4

UN: R\$ 51,35 AV: R\$ 51,35 15: R\$ 52,42
30: R\$ 53,47 45: R\$ 54,54 60: R\$ 55,63



MOCHILA CONVOY CASUAL POLIESTER YS29073

Código: Fábrica: Unidade:
34100 YIN'S UN/1
F1 F4

UN: R\$ 51,35 AV: R\$ 51,35 15: R\$ 52,42
30: R\$ 53,47 45: R\$ 54,54 60: R\$ 55,63



MOCHILA CONVOY CASUAL POLIESTER YS29082

Código: Fábrica: Unidade:
35874 YIN'S UN/1
F1 F4

UN: R\$ 51,35 AV: R\$ 51,35 15: R\$ 52,42
30: R\$ 53,47 45: R\$ 54,54 60: R\$ 55,63



MOCHILA CONVOY JUVENIL FLORES YS29272

Código: Fábrica: Unidade:
42940 YINS UN/1
F1 F4

UN: R\$ 143,80 AV: R\$ 143,80 15: R\$ 146,79
30: R\$ 149,73 45: R\$ 152,72 60: R\$ 155,78



MOCHILA ESPORTIVA BARCELONA B01 9150

Código: Fábrica: Unidade:
39839 XERYUS UN/1
F1 F4

UN: R\$ 143,80 AV: R\$ 143,80 15: R\$ 146,79
30: R\$ 149,73 45: R\$ 152,72 60: R\$ 155,78



MOCHILA ESPORTIVA BARCELONA B06 9155

Código: Fábrica: Unidade:
39840 XERYUS UN/1
F1 F4

UN: R\$ 154,07 AV: R\$ 154,07 15: R\$ 157,28
30: R\$ 160,43 45: R\$ 163,63 60: R\$ 166,91



MOCHILA ESPORTIVA BARCELONA B07 9156

Código: Fábrica: Unidade:
39841 XERYUS UN/1
F1 F4

UN: R\$ 143,80 AV: R\$ 143,80 15: R\$ 146,79
30: R\$ 149,73 45: R\$ 152,72 60: R\$ 155,78



MOCHILA ESPORTIVA BARCELONA TEEN B1 9157
Código: Fábrika: Unidade:
39842 XERYUS UN/1
F1 F4

UN: R\$ 205,43 AV: R\$ 205,43 15: R\$ 209,71
30: R\$ 213,90 45: R\$ 218,18 60: R\$ 222,55



MOCHILA ESPORTIVA CORINTHIANS B01 9890
Código: Fábrika: Unidade:
39838 XERYUS UN/1
F1 F4

UN: R\$ 205,43 AV: R\$ 205,43 15: R\$ 209,71
30: R\$ 213,90 45: R\$ 218,18 60: R\$ 222,55



MOCHILA ESPORTIVA CORINTHIANS I01 9893
Código: Fábrika: Unidade:
39837 XERYUS UN/1
F1 F4

UN: R\$ 215,70 AV: R\$ 215,70 15: R\$ 220,20
30: R\$ 224,60 45: R\$ 229,09 60: R\$ 233,67



MOCHILA ESPORTIVA FLAMENGO B03 9904
Código: Fábrika: Unidade:
39836 XERYUS UN/1
F1 F4

UN: R\$ 92,44 AV: R\$ 92,44 15: R\$ 94,36
30: R\$ 96,25 45: R\$ 98,18 60: R\$ 100,14



MOCHILA FEM NICOBOCO NB49
Código: Fábrika: Unidade:
29291 NICOBOCO UN/1
F1 F4

UN: R\$ 43,14 AV: R\$ 43,14 15: R\$ 44,04
30: R\$ 44,92 45: R\$ 45,82 60: R\$ 46,74



MOCHILA INF BATTLE M M4651
Código: Fábrika: Unidade:
49021 PONTO VERDE UN/1
F1 F4

UN: R\$ 42,01 AV: R\$ 42,01 15: R\$ 42,89
30: R\$ 43,75 45: R\$ 44,62 60: R\$ 45,51



MOCHILA INF BATTLE PRE M4650
Código: Fábrika: Unidade:
49020 PONTO VERDE UN/1
F1 F4

UN: R\$ 54,43 AV: R\$ 54,43 15: R\$ 55,57
30: R\$ 56,68 45: R\$ 57,81 60: R\$ 58,97



MOCHILA INF BRANCA DE NEVE PRE M4620
Código: Fábrika: Unidade:
49042 PONTO VERDE UN/1
F1 F4

UN: R\$ 61,62 AV: R\$ 61,62 15: R\$ 62,91
30: R\$ 64,16 45: R\$ 65,45 60: R\$ 66,76



MOCHILA INF CALIFORNIA GIRLS REL M 3023
Código: Fábrika: Unidade:
32249 SBC UN/1
F1 F4

UN: R\$ 56,49 AV: R\$ 56,49 15: R\$ 57,66
30: R\$ 58,82 45: R\$ 59,99 60: R\$ 61,19



MOCHILA INF CALIFORNIA GIRLS REL P 2943
Código: Fábrika: Unidade:
32256 SBC UN/1
F1 F4

UN: R\$ 61,62 AV: R\$ 61,62 15: R\$ 62,91
30: R\$ 64,16 45: R\$ 65,45 60: R\$ 66,76



MOCHILA INF CALIFORNIA GIRLS REL P 3022
Código: Fábrika: Unidade:
32251 SBC UN/1
F1 F4

UN: R\$ 66,76 AV: R\$ 66,76 15: R\$ 68,15
30: R\$ 69,51 45: R\$ 70,90 60: R\$ 72,32



MOCHILA INF CALIFORNIA GIRLS REL P 3193
Código: Fábrika: Unidade:
32252 SBC UN/1
F1 F4

UN: R\$ 136,61 AV: R\$ 136,61 15: R\$ 139,45
30: R\$ 142,24 45: R\$ 145,09 60: R\$ 147,99



MOCHILA INF CARR BATTLE KIT 3PC MCK4656
Código: Fábrika: Unidade:
48996 PONTO VERDE UN/1
F1 F4

UN: R\$ 86,27 AV: R\$ 86,27 15: R\$ 88,07
30: R\$ 89,83 45: R\$ 91,63 60: R\$ 93,46



MOCHILA INF CARR BATTLE MC4654
Código: Fábrika: Unidade:
48994 PONTO VERDE UN/1
F1 F4

UN: R\$ 85,25 AV: R\$ 85,25 15: R\$ 87,02
30: R\$ 88,76 45: R\$ 90,54 60: R\$ 92,35



MOCHILA INF CARR BATTLE PRE MC4653
Código: Fábrika: Unidade:
48993 PONTO VERDE UN/1
F1 F4

UN: R\$ 136,61 AV: R\$ 136,61 15: R\$ 139,45
30: R\$ 142,24 45: R\$ 145,09 60: R\$ 147,99



MOCHILA INF CARR BEE FRIENDES KIT K4802
Código: Fábrika: Unidade:
49079 PONTO VERDE UN/1
F1 F4

UN: R\$ 143,80 AV: R\$ 143,80 15: R\$ 146,79
30: R\$ 149,73 45: R\$ 152,72 60: R\$ 155,78



MOCHILA INF CARR BELIEVE G MCK4741
Código: Fábrica: Unidade:
49033 PONTO VERDE UN/1
F1 F4

UN: R\$ 335,93 AV: R\$ 335,93 15: R\$ 342,93
30: R\$ 349,79 45: R\$ 356,78 60: R\$ 363,92



MOCHILA INF CARR BELLA KIT 3PC MCK3717
Código: Fábrica: Unidade:
34256 SBC UN/1
F1 F4

UN: R\$ 92,44 AV: R\$ 92,44 15: R\$ 94,36
30: R\$ 96,25 45: R\$ 98,18 60: R\$ 100,14



MOCHILA INF CARR BRANCA DE NEVE P MC4624
Código: Fábrica: Unidade:
49038 PONTO VERDE UN/1
F1 F4

UN: R\$ 115,83 AV: R\$ 115,83 15: R\$ 118,24
30: R\$ 120,61 45: R\$ 123,02 60: R\$ 125,48



MOCHILA INF CARR CRYSTAL PRINCE G 2633
Código: Fábrica: Unidade:
31341 SBC UN/1
F1 F4

UN: R\$ 215,70 AV: R\$ 215,70 15: R\$ 220,20
30: R\$ 224,60 45: R\$ 229,09 60: R\$ 233,67



MOCHILA INF CARR EVA ARANHA 3D KIT 4893
Código: Fábrica: Unidade:
49034 PONTO VERDE UN/1
F1 F4

UN: R\$ 215,70 AV: R\$ 215,70 15: R\$ 220,20
30: R\$ 224,60 45: R\$ 229,09 60: R\$ 233,67



MOCHILA INF CARR EVA PRINCESS 3D KIT 5039
Código: Fábrica: Unidade:
49035 PONTO VERDE UN/1
F1 F4

UN: R\$ 213,14 AV: R\$ 213,14 15: R\$ 217,58
30: R\$ 221,94 45: R\$ 226,37 60: R\$ 230,90



MOCHILA INF CARR FUNNY KIT 3PC MCK4334
Código: Fábrica: Unidade:
44024 PONTO VERDE UN/1
F1 F4

UN: R\$ 136,61 AV: R\$ 136,61 15: R\$ 139,45
30: R\$ 142,24 45: R\$ 145,09 60: R\$ 147,99



MOCHILA INF CARR GAME WORLD KIT 3PC 4831
Código: Fábrica: Unidade:
49081 PONTO VERDE UN/1
F1 F4

UN: R\$ 98,60 AV: R\$ 98,60 15: R\$ 100,66
30: R\$ 102,67 45: R\$ 104,72 60: R\$ 106,82



MOCHILA INF CARR GAMER BOY P MC4729
Código: Fábrica: Unidade:
49187 PONTO VERDE UN/1
F1 F4

UN: R\$ 256,79 AV: R\$ 256,79 15: R\$ 262,14
30: R\$ 267,38 45: R\$ 272,73 60: R\$ 278,18



MOCHILA INF CARR GUARDIAN KIT 3PC MK4180
Código: Fábrica: Unidade:
44394 PONTO VERDE UN/1
F1 F4

UN: R\$ 119,99 AV: R\$ 119,99 15: R\$ 119,99
30: R\$ 119,99 45: R\$ 119,99 60: R\$ 119,99



MOCHILA INF CARR KARS KID KIT 3PC K4666
Código: Fábrica: Unidade:
50517 PONTO VERDE UN/1
F1 F4

UN: R\$ 143,80 AV: R\$ 143,80 15: R\$ 146,79
30: R\$ 149,73 45: R\$ 152,72 60: R\$ 155,78



MOCHILA INF CARR KARS KIDS KIT 3PC K4667
Código: Fábrica: Unidade:
48997 PONTO VERDE UN/1
F1 F4

UN: R\$ 150,58 AV: R\$ 150,58 15: R\$ 153,72
30: R\$ 156,80 45: R\$ 159,93 60: R\$ 163,13



MOCHILA INF CARR KARS KIDS M4660
Código: Fábrica: Unidade:
32175 PONTO VERDE UN/1
F1 F4

UN: R\$ 87,30 AV: R\$ 87,30 15: R\$ 89,12
30: R\$ 90,90 45: R\$ 92,72 60: R\$ 94,58



MOCHILA INF CARR KARS KIDS PRE MC4663
Código: Fábrica: Unidade:
49184 PONTO VERDE UN/1
F1 F4

UN: R\$ 97,57 AV: R\$ 97,57 15: R\$ 99,61
30: R\$ 101,60 45: R\$ 103,63 60: R\$ 105,70



MOCHILA INF CARR LINHA BABY POA MC4720
Código: Fábrica: Unidade:
49186 PONTO VERDE UN/1
F1 F4

UN: R\$ 157,15 AV: R\$ 157,15 15: R\$ 160,43
30: R\$ 163,63 45: R\$ 166,91 60: R\$ 170,24



MOCHILA INF CARR LINHA BABY SPIDE MC4726
Código: Fábrica: Unidade:
46704 PONTO VERDE UN/1
F1 F4

UN: R\$ 85,25 AV: R\$ 85,25 15: R\$ 87,02
30: R\$ 88,76 45: R\$ 90,54 60: R\$ 92,35



MOCHILA INF CARR NINJA MC4685

Código: Fábrica: Unidade:
48999 PONTO VERDE UN/1
F1 F4

UN: R\$ 81,08 AV: R\$ 81,08 15: R\$ 82,77
30: R\$ 84,42 45: R\$ 86,11 60: R\$ 87,83



MOCHILA INF CARR PEQ

Código: Fábrica: Unidade:
15520 HAI BRASIL UN/1
F1 F4

UN: R\$ 104,25 AV: R\$ 104,25 15: R\$ 106,42
30: R\$ 108,55 45: R\$ 110,72 60: R\$ 112,93



MOCHILA INF CARR PIGGY G 2003

Código: Fábrica: Unidade:
29629 SBC UN/1
F1 F4

UN: R\$ 150,58 AV: R\$ 150,58 15: R\$ 153,72
30: R\$ 156,80 45: R\$ 159,93 60: R\$ 163,13



MOCHILA INF CARR PRINCE ON ICE R G3105

Código: Fábrica: Unidade:
32171 SBC UN/1
F1 F4

UN: R\$ 150,58 AV: R\$ 150,58 15: R\$ 153,72
30: R\$ 156,80 45: R\$ 159,93 60: R\$ 163,13



MOCHILA INF CARR PRINCES ON ICE G 3069

Código: Fábrica: Unidade:
32188 SBC UN/1
F1 F4

UN: R\$ 127,42 AV: R\$ 127,42 15: R\$ 130,07
30: R\$ 132,67 45: R\$ 135,32 60: R\$ 138,03



MOCHILA INF CARR PRINCES ON ICE M 3004

Código: Fábrica: Unidade:
31844 SBC UN/1
F1 F4

UN: R\$ 127,42 AV: R\$ 127,42 15: R\$ 130,07
30: R\$ 132,67 45: R\$ 135,32 60: R\$ 138,03



MOCHILA INF CARR PRINCES ON ICE M 3042

Código: Fábrica: Unidade:
31842 SBC UN/1
F1 F4

UN: R\$ 150,58 AV: R\$ 150,58 15: R\$ 153,72
30: R\$ 156,80 45: R\$ 159,93 60: R\$ 163,13



MOCHILA INF CARR PRINCES ON ICE M 3104

Código: Fábrica: Unidade:
31843 SBC UN/1
F1 F4

UN: R\$ 139,00 AV: R\$ 139,00 15: R\$ 141,90
30: R\$ 144,73 45: R\$ 147,63 60: R\$ 150,58



MOCHILA INF CARR PRINCES ON ICE P 3003

Código: Fábrica: Unidade:
32187 SBC UN/1
F1 F4

UN: R\$ 136,61 AV: R\$ 136,61 15: R\$ 139,45
30: R\$ 142,24 45: R\$ 145,09 60: R\$ 147,99



MOCHILA INF CARR PRINCESA KIT 3PC K4636

Código: Fábrica: Unidade:
49000 PONTO VERDE UN/1
F1 F4

UN: R\$ 146,88 AV: R\$ 146,88 15: R\$ 149,94
30: R\$ 152,94 45: R\$ 156,00 60: R\$ 159,12



MOCHILA INF CARR PRINCESA KIT 3PC K4637

Código: Fábrica: Unidade:
49002 PONTO VERDE UN/1
F1 F4

UN: R\$ 85,25 AV: R\$ 85,25 15: R\$ 87,02
30: R\$ 88,76 45: R\$ 90,54 60: R\$ 92,35



MOCHILA INF CARR PRINCESA M MC4634

Código: Fábrica: Unidade:
49001 PONTO VERDE UN/1
F1 F4

UN: R\$ 90,38 AV: R\$ 90,38 15: R\$ 92,27
30: R\$ 94,11 45: R\$ 95,99 60: R\$ 97,91



MOCHILA INF CARR PRINCESA M MC4635

Código: Fábrica: Unidade:
49188 PONTO VERDE UN/1
F1 F4

UN: R\$ 92,44 AV: R\$ 92,44 15: R\$ 94,36
30: R\$ 96,25 45: R\$ 98,18 60: R\$ 100,14



MOCHILA INF CARR PRINCESA PRE MC4633

Código: Fábrica: Unidade:
49039 PONTO VERDE UN/1
F1 F4

UN: R\$ 115,83 AV: R\$ 115,83 15: R\$ 118,24
30: R\$ 120,61 45: R\$ 123,02 60: R\$ 125,48



MOCHILA INF CARR PRINCESS P 2904

Código: Fábrica: Unidade:
32186 SBC UN/1
F1 F4

UN: R\$ 102,71 AV: R\$ 102,71 15: R\$ 104,85
30: R\$ 106,95 45: R\$ 109,09 60: R\$ 111,27



MOCHILA INF CARR PRINCESS PRE 2903

Código: Fábrica: Unidade:
32325 SBC UN/1
F1 F4

UN: R\$ 150,58 AV: R\$ 150,58 15: R\$ 153,72
30: R\$ 156,80 45: R\$ 159,93 60: R\$ 163,13



MOCHILA INF CARR PRINCESS R M 3092
Código: Fábrica: Unidade:
32184 SBC UN/1
F1 F4

UN: R\$ 115,83 AV: R\$ 115,83 15: R\$ 118,24
30: R\$ 120,61 45: R\$ 123,02 60: R\$ 125,48



MOCHILA INF CARR PRINCESS REL G 2905
Código: Fábrica: Unidade:
32182 SBC UN/1
F1 F4

UN: R\$ 162,17 AV: R\$ 162,17 15: R\$ 165,55
30: R\$ 168,86 45: R\$ 172,23 60: R\$ 175,68



MOCHILA INF CARR PRINCESS REL G 3073
Código: Fábrica: Unidade:
32183 SBC UN/1
F1 F4

UN: R\$ 139,00 AV: R\$ 139,00 15: R\$ 141,90
30: R\$ 144,73 45: R\$ 147,63 60: R\$ 150,58



MOCHILA INF CARR PRINCESS REL M 3030
Código: Fábrica: Unidade:
32215 SBC UN/1
F1 F4

UN: R\$ 115,83 AV: R\$ 115,83 15: R\$ 118,24
30: R\$ 120,61 45: R\$ 123,02 60: R\$ 125,48



MOCHILA INF CARR REBEL PRINCES R M2938
Código: Fábrica: Unidade:
32192 SBC UN/1
F1 F4

UN: R\$ 127,42 AV: R\$ 127,42 15: R\$ 130,07
30: R\$ 132,67 45: R\$ 135,32 60: R\$ 138,03



MOCHILA INF CARR REBEL PRINCESS M 2939
Código: Fábrica: Unidade:
32193 SBC UN/1
F1 F4

UN: R\$ 143,80 AV: R\$ 143,80 15: R\$ 146,79
30: R\$ 149,73 45: R\$ 152,72 60: R\$ 155,78



MOCHILA INF CARR SEREIA KIT 3PC MCK4616
Código: Fábrica: Unidade:
49036 PONTO VERDE UN/1
F1 F4

UN: R\$ 163,31 AV: R\$ 163,31 15: R\$ 166,72
30: R\$ 170,05 45: R\$ 173,45 60: R\$ 176,92



MOCHILA INF CARR SPACE BOARD+LANCHE 4702
Código: Fábrica: Unidade:
46703 PONTO VERDE UN/1
F1 F4

UN: R\$ 143,80 AV: R\$ 143,80 15: R\$ 146,79
30: R\$ 149,73 45: R\$ 152,72 60: R\$ 155,78



MOCHILA INF CARR SPACE KIT 3PC MCK4705
Código: Fábrica: Unidade:
50518 PONTO VERDE UN/1
F1 F4

UN: R\$ 139,00 AV: R\$ 139,00 15: R\$ 141,90
30: R\$ 144,73 45: R\$ 147,63 60: R\$ 150,58



MOCHILA INF CARR SPEED BOY M 3010
Código: Fábrica: Unidade:
32197 SBC UN/1
F1 F4

UN: R\$ 102,71 AV: R\$ 102,71 15: R\$ 104,85
30: R\$ 106,95 45: R\$ 109,09 60: R\$ 111,27



MOCHILA INF CARR SPEED BOY PRE 2961
Código: Fábrica: Unidade:
32196 SBC UN/1
F1 F4

UN: R\$ 150,58 AV: R\$ 150,58 15: R\$ 153,72
30: R\$ 156,80 45: R\$ 159,93 60: R\$ 163,13



MOCHILA INF CARR SPEED BOY REL G 3081
Código: Fábrica: Unidade:
32109 SBC UN/1
F1 F4

UN: R\$ 150,58 AV: R\$ 150,58 15: R\$ 153,72
30: R\$ 156,80 45: R\$ 159,93 60: R\$ 163,13



MOCHILA INF CARR SPEED BOY REL G3011
Código: Fábrica: Unidade:
32200 SBC UN/1
F1 F4

UN: R\$ 119,99 AV: R\$ 119,99 15: R\$ 119,99
30: R\$ 119,99 45: R\$ 119,99 60: R\$ 119,99



MOCHILA INF CARR SPEED WEB KIT 3PC K4646
Código: Fábrica: Unidade:
49003 PONTO VERDE UN/1
F1 F4

UN: R\$ 146,88 AV: R\$ 146,88 15: R\$ 149,94
30: R\$ 152,94 45: R\$ 156,00 60: R\$ 159,12



MOCHILA INF CARR SPEED WEB KIT 3PC K4647
Código: Fábrica: Unidade:
49004 PONTO VERDE UN/1
F1 F4

UN: R\$ 215,70 AV: R\$ 215,70 15: R\$ 220,20
30: R\$ 224,60 45: R\$ 229,09 60: R\$ 233,67



MOCHILA INF CARR SPEED WEB KIT 3PC M4144
Código: Fábrica: Unidade:
44393 PONTO VERDE UN/1
F1 F4

UN: R\$ 102,71 AV: R\$ 102,71 15: R\$ 104,85
30: R\$ 106,95 45: R\$ 109,09 60: R\$ 111,27



MOCHILA INF CARR SPEED WEB M MC4140
Código: 49190 Fábrica: PONTO VERDE Unidade: UN/1
F1 F4

UN: R\$ 87,30 AV: R\$ 87,30 15: R\$ 89,12
30: R\$ 90,90 45: R\$ 92,72 60: R\$ 94,58



MOCHILA INF CARR SPEED WEB MC4645
Código: 49006 Fábrica: PONTO VERDE Unidade: UN/1
F1 F4

UN: R\$ 87,30 AV: R\$ 87,30 15: R\$ 89,12
30: R\$ 90,90 45: R\$ 92,72 60: R\$ 94,58



MOCHILA INF CARR SPEED WEB PRE MC4644
Código: 49189 Fábrica: PONTO VERDE Unidade: UN/1
F1 F4

UN: R\$ 84,22 AV: R\$ 84,22 15: R\$ 85,97
30: R\$ 87,69 45: R\$ 89,45 60: R\$ 91,24



MOCHILA INF CARR SPEED WEB PRE 4643
Código: 49005 Fábrica: PONTO VERDE Unidade: UN/1
F1 F4

UN: R\$ 139,00 AV: R\$ 139,00 15: R\$ 141,90
30: R\$ 144,73 45: R\$ 147,63 60: R\$ 150,58



MOCHILA INF CARR STAR SHOW M 3882
Código: 36040 Fábrica: SBC Unidade: UN/1
F1 F4

UN: R\$ 104,25 AV: R\$ 104,25 15: R\$ 106,42
30: R\$ 108,55 45: R\$ 110,72 60: R\$ 112,93



MOCHILA INF CARR SUPER SHIELD P MC3591
Código: 38045 Fábrica: VOZZ Unidade: UN/1
F1 F4

UN: R\$ 81,08 AV: R\$ 81,08 15: R\$ 82,77
30: R\$ 84,42 45: R\$ 86,11 60: R\$ 87,83



MOCHILA INF CARR SUPER SQUARE 22454
Código: 44749 Fábrica: WINTH Unidade: UN/1
F1 F4

UN: R\$ 139,00 AV: R\$ 139,00 15: R\$ 141,90
30: R\$ 144,73 45: R\$ 147,63 60: R\$ 150,58



MOCHILA INF CARR UNILOVERS G MC3721
Código: 38041 Fábrica: SBC Unidade: UN/1
F1 F4

UN: R\$ 335,93 AV: R\$ 335,93 15: R\$ 342,93
30: R\$ 349,79 45: R\$ 356,78 60: R\$ 363,92



MOCHILA INF CARR UNILOVERS KIT 3PC 3682
Código: 34282 Fábrica: SBC Unidade: UN/1
F1 F4

UN: R\$ 127,42 AV: R\$ 127,42 15: R\$ 130,07
30: R\$ 132,67 45: R\$ 135,32 60: R\$ 138,03



MOCHILA INF CARR UNILOVERS P 3494
Código: 34280 Fábrica: SBC Unidade: UN/1
F1 F4

UN: R\$ 115,83 AV: R\$ 115,83 15: R\$ 118,24
30: R\$ 120,61 45: R\$ 123,02 60: R\$ 125,48



MOCHILA INF CARR VALENTINA M 3167
Código: 32202 Fábrica: SBC Unidade: UN/1
F1 F4

UN: R\$ 115,83 AV: R\$ 115,83 15: R\$ 118,24
30: R\$ 120,61 45: R\$ 123,02 60: R\$ 125,48



MOCHILA INF CARR VALENTINA P 3166
Código: 31845 Fábrica: SBC Unidade: UN/1
F1 F4

UN: R\$ 335,93 AV: R\$ 335,93 15: R\$ 342,93
30: R\$ 349,79 45: R\$ 356,78 60: R\$ 363,92



MOCHILA INF CARR WONDER GIRL KIT 3PC 3170
Código: 32214 Fábrica: VOZZ Unidade: UN/1
F1 F4

UN: R\$ 335,93 AV: R\$ 335,93 15: R\$ 342,93
30: R\$ 349,79 45: R\$ 356,78 60: R\$ 363,92



MOCHILA INF CARR WONDER GIRL KIT 3PC3683
Código: 34283 Fábrica: SBC Unidade: UN/1
F1 F4

UN: R\$ 127,42 AV: R\$ 127,42 15: R\$ 130,07
30: R\$ 132,67 45: R\$ 135,32 60: R\$ 138,03



MOCHILA INF CARR X-FORCE REL M 2983
Código: 32204 Fábrica: SBC Unidade: UN/1
F1 F4

UN: R\$ 136,61 AV: R\$ 136,61 15: R\$ 139,45
30: R\$ 142,24 45: R\$ 145,09 60: R\$ 147,99



MOCHILA INF CARR 3 PRINCESA KIT 3PC 4824
Código: 49078 Fábrica: PONTO VERDE Unidade: UN/1
F1 F4

UN: R\$ 136,61 AV: R\$ 136,61 15: R\$ 139,45
30: R\$ 142,24 45: R\$ 145,09 60: R\$ 147,99



MOCHILA INF CARR 3 PRINCESA KIT 3PC 4825
Código: Fábrica: Unidade:
49077 PONTO VERDE UN/1
F1 F4

UN: R\$ 123,25 AV: R\$ 123,25 15: R\$ 125,82
30: R\$ 128,34 45: R\$ 130,90 60: R\$ 133,52



MOCHILA INF C/CARR AIR JUMPER R G MC3745
Código: Fábrica: Unidade:
38037 SBC UN/1
F1 F4

UN: R\$ 150,58 AV: R\$ 150,58 15: R\$ 153,72
30: R\$ 156,80 45: R\$ 159,93 60: R\$ 163,13



MOCHILA INF C/CARR AMANDA REL G 2189
Código: Fábrica: Unidade:
29627 SBC UN/1
F1 F4

UN: R\$ 65,74 AV: R\$ 65,74 15: R\$ 67,11
30: R\$ 68,45 45: R\$ 69,82 60: R\$ 71,22



MOCHILA INF C/CARR BEAUTY FREAKY 194
Código: Fábrica: Unidade:
27800 SBC UN/1
F1 F4

UN: R\$ 123,25 AV: R\$ 123,25 15: R\$ 125,82
30: R\$ 128,34 45: R\$ 130,90 60: R\$ 133,52



MOCHILA INF C/CARR BEST FRIEND G MC3668
Código: Fábrica: Unidade:
38058 SBC UN/1
F1 F4

UN: R\$ 127,42 AV: R\$ 127,42 15: R\$ 130,07
30: R\$ 132,67 45: R\$ 135,32 60: R\$ 138,03



MOCHILA INF C/CARR BLOCK GAME P 3626
Código: Fábrica: Unidade:
34258 SBC UN/1
F1 F4

UN: R\$ 127,42 AV: R\$ 127,42 15: R\$ 130,07
30: R\$ 132,67 45: R\$ 135,32 60: R\$ 138,03



MOCHILA INF C/CARR BROKEBONES R PRE 3017
Código: Fábrica: Unidade:
32157 SBC UN/1
F1 F4

UN: R\$ 150,58 AV: R\$ 150,58 15: R\$ 153,72
30: R\$ 156,80 45: R\$ 159,93 60: R\$ 163,13



MOCHILA INF C/CARR BROKEBONES REL P 3122
Código: Fábrica: Unidade:
32107 SBC UN/1
F1 F4

UN: R\$ 115,83 AV: R\$ 115,83 15: R\$ 118,24
30: R\$ 120,61 45: R\$ 123,02 60: R\$ 125,48



MOCHILA INF C/CARR CALIFORNIA GIRL 2947
Código: Fábrica: Unidade:
32164 SBC UN/1
F1 F4

UN: R\$ 150,58 AV: R\$ 150,58 15: R\$ 153,72
30: R\$ 156,80 45: R\$ 159,93 60: R\$ 163,13



MOCHILA INF C/CARR CALIFORNIA GIRL G3025
Código: Fábrica: Unidade:
32161 SBC UN/1
F1 F4

UN: R\$ 150,58 AV: R\$ 150,58 15: R\$ 153,72
30: R\$ 156,80 45: R\$ 159,93 60: R\$ 163,13



MOCHILA INF C/CARR CALIFORNIA GIRL G3196
Código: Fábrica: Unidade:
32162 SBC UN/1
F1 F4

UN: R\$ 115,83 AV: R\$ 115,83 15: R\$ 118,24
30: R\$ 120,61 45: R\$ 123,02 60: R\$ 125,48



MOCHILA INF C/CARR CALIFORNIA GIRL M2946
Código: Fábrica: Unidade:
32160 SBC UN/1
F1 F4

UN: R\$ 127,42 AV: R\$ 127,42 15: R\$ 130,07
30: R\$ 132,67 45: R\$ 135,32 60: R\$ 138,03



MOCHILA INF C/CARR CALIFORNIA GIRL M3024
Código: Fábrica: Unidade:
32165 SBC UN/1
F1 F4

UN: R\$ 139,00 AV: R\$ 139,00 15: R\$ 141,90
30: R\$ 144,73 45: R\$ 147,63 60: R\$ 150,58



MOCHILA INF C/CARR CALIFORNIA GIRL M3195
Código: Fábrica: Unidade:
32163 SBC UN/1
F1 F4

UN: R\$ 139,00 AV: R\$ 139,00 15: R\$ 141,90
30: R\$ 144,73 45: R\$ 147,63 60: R\$ 150,58



MOCHILA INF C/CARR DOLL M MC3919
Código: Fábrica: Unidade:
36214 SBC UN/1
F1 F4

UN: R\$ 127,42 AV: R\$ 127,42 15: R\$ 130,07
30: R\$ 132,67 45: R\$ 135,32 60: R\$ 138,03



MOCHILA INF C/CARR HOOZ P 3634
Código: Fábrica: Unidade:
34271 SBC UN/1
F1 F4

UN: R\$ 162,17 AV: R\$ 162,17 15: R\$ 165,55
30: R\$ 168,86 45: R\$ 172,23 60: R\$ 175,68



MOCHILA INF C/CARR LITTLE PRINCESS P3641
Código: Fábrica: Unidade:
34274 SBC UN/1
F1 F4

UN: R\$ 127,42 AV: R\$ 127,42 15: R\$ 130,07
30: R\$ 132,67 45: R\$ 135,32 60: R\$ 138,03



MOCHILA INF C/CARR LOVE FASHION P 3514
Código: Fábrica: Unidade:
34276 SBC UN/1
F1 F4

UN: R\$ 115,83 AV: R\$ 115,83 15: R\$ 118,24
30: R\$ 120,61 45: R\$ 123,02 60: R\$ 125,48



MOCHILA INF C/CARR MAGICAL P MC2918
Código: Fábrica: Unidade:
32176 SBC UN/1
F1 F4

UN: R\$ 102,71 AV: R\$ 102,71 15: R\$ 104,85
30: R\$ 106,95 45: R\$ 109,09 60: R\$ 111,27



MOCHILA INF C/CARR MY PRINCES P MC3522
Código: Fábrica: Unidade:
40059 VOZZ UN/1
F1 F4

UN: R\$ 115,83 AV: R\$ 115,83 15: R\$ 118,24
30: R\$ 120,61 45: R\$ 123,02 60: R\$ 125,48



MOCHILA INF C/CARR MY PRINCESS P MC3543
Código: Fábrica: Unidade:
40055 SBC UN/1
F1 F4

UN: R\$ 139,00 AV: R\$ 139,00 15: R\$ 141,90
30: R\$ 144,73 45: R\$ 147,63 60: R\$ 150,58



MOCHILA INF C/CARR PEQUENA PRINCE R G3143
Código: Fábrica: Unidade:
32154 SBC UN/1
F1 F4

UN: R\$ 115,83 AV: R\$ 115,83 15: R\$ 118,24
30: R\$ 120,61 45: R\$ 123,02 60: R\$ 125,48



MOCHILA INF C/CARR PEQUENA PRINCE M 2913
Código: Fábrica: Unidade:
32338 SBC UN/1
F1 F4

UN: R\$ 115,83 AV: R\$ 115,83 15: R\$ 118,24
30: R\$ 120,61 45: R\$ 123,02 60: R\$ 125,48



MOCHILA INF C/CARR PEQUENA PRINCE P 2912
Código: Fábrica: Unidade:
32326 SBC UN/1
F1 F4

UN: R\$ 127,42 AV: R\$ 127,42 15: R\$ 130,07
30: R\$ 132,67 45: R\$ 135,32 60: R\$ 138,03



MOCHILA INF C/CARR PEQUENA PRINCE P 3036
Código: Fábrica: Unidade:
32305 SBC UN/1
F1 F4

UN: R\$ 127,42 AV: R\$ 127,42 15: R\$ 130,07
30: R\$ 132,67 45: R\$ 135,32 60: R\$ 138,03



MOCHILA INF C/CARR PEQUENA PRINCE P 3142
Código: Fábrica: Unidade:
31836 SBC UN/1
F1 F4

UN: R\$ 127,42 AV: R\$ 127,42 15: R\$ 130,07
30: R\$ 132,67 45: R\$ 135,32 60: R\$ 138,03



MOCHILA INF C/CARR PEQUENA PRINCESA 3523
Código: Fábrica: Unidade:
34255 SBC UN/1
F1 F4

UN: R\$ 150,58 AV: R\$ 150,58 15: R\$ 153,72
30: R\$ 156,80 45: R\$ 159,93 60: R\$ 163,13



MOCHILA INF C/CARR PET PRINCE R P 3086
Código: Fábrica: Unidade:
32181 SBC UN/1
F1 F4

UN: R\$ 115,83 AV: R\$ 115,83 15: R\$ 118,24
30: R\$ 120,61 45: R\$ 123,02 60: R\$ 125,48



MOCHILA INF C/CARR PET PRINCESS P 2932
Código: Fábrica: Unidade:
32168 SBC UN/1
F1 F4

UN: R\$ 102,71 AV: R\$ 102,71 15: R\$ 104,85
30: R\$ 106,95 45: R\$ 109,09 60: R\$ 111,27



MOCHILA INF C/CARR PET PRINCESS M MC2933
Código: Fábrica: Unidade:
32169 SBC UN/1
F1 F4

UN: R\$ 150,58 AV: R\$ 150,58 15: R\$ 153,72
30: R\$ 156,80 45: R\$ 159,93 60: R\$ 163,13



MOCHILA INF C/CARR PET PRINCESS R M 3087
Código: Fábrica: Unidade:
32178 SBC UN/1
F1 F4

UN: R\$ 104,25 AV: R\$ 104,25 15: R\$ 106,42
30: R\$ 108,55 45: R\$ 110,72 60: R\$ 112,93



MOCHILA INF C/CARR PIGGY BOY G 2051
Código: Fábrica: Unidade:
29686 SBC UN/1
F1 F4

UN: R\$ 127,42 AV: R\$ 127,42 15: R\$ 130,07
30: R\$ 132,67 45: R\$ 135,32 60: R\$ 138,03



MOCHILA INF C/CARR PIGGY BOY M 2432
Código: 29654 Fábrica: SBC Unidade: UN/1 F1 F4

UN: R\$ 104,25 AV: R\$ 104,25 15: R\$ 106,42
30: R\$ 108,55 45: R\$ 110,72 60: R\$ 112,93



MOCHILA INF C/CARR PIGGY BOY P 2050
Código: 29685 Fábrica: SBC Unidade: UN/1 F1 F4

UN: R\$ 66,76 AV: R\$ 66,76 15: R\$ 68,15
30: R\$ 69,51 45: R\$ 70,90 60: R\$ 72,32



MOCHILA INF CRYSTAL PRINCESS REL M 2720
Código: 30552 Fábrica: SBC Unidade: UN/1 F1 F4

UN: R\$ 66,76 AV: R\$ 66,76 15: R\$ 68,15
30: R\$ 69,51 45: R\$ 70,90 60: R\$ 72,32



MOCHILA INF CRYSTAL PRINCESS REL M 2768
Código: 31312 Fábrica: SBC Unidade: UN/1 F1 F4

UN: R\$ 61,62 AV: R\$ 61,62 15: R\$ 62,91
30: R\$ 64,16 45: R\$ 65,45 60: R\$ 66,76



MOCHILA INF DOLL P 3915
Código: 36038 Fábrica: SBC Unidade: UN/1 F1 F4

UN: R\$ 61,62 AV: R\$ 61,62 15: R\$ 62,91
30: R\$ 64,16 45: R\$ 65,45 60: R\$ 66,76



MOCHILA INF DOLL PRE 3914
Código: 35975 Fábrica: SBC Unidade: UN/1 F1 F4

UN: R\$ 47,24 AV: R\$ 47,24 15: R\$ 48,23
30: R\$ 49,19 45: R\$ 50,17 60: R\$ 51,18



MOCHILA INF FEM BEE FRIENDES PRE M4800
Código: 49087 Fábrica: PONTO VERDE Unidade: UN/1 F1 F4

UN: R\$ 49,30 AV: R\$ 49,30 15: R\$ 50,32
30: R\$ 51,33 45: R\$ 52,36 60: R\$ 53,40



MOCHILA INF FEM BEE FRINDES G M4801
Código: 49088 Fábrica: PONTO VERDE Unidade: UN/1 F1 F4

UN: R\$ 61,62 AV: R\$ 61,62 15: R\$ 62,91
30: R\$ 64,16 45: R\$ 65,45 60: R\$ 66,76



MOCHILA INF FEM BRANCA DE NEVE G M4622
Código: 49044 Fábrica: PONTO VERDE Unidade: UN/1 F1 F4

UN: R\$ 56,49 AV: R\$ 56,49 15: R\$ 57,66
30: R\$ 58,82 45: R\$ 59,99 60: R\$ 61,19



MOCHILA INF FEM BRANCA DE NEVE M M4621
Código: 49043 Fábrica: PONTO VERDE Unidade: UN/1 F1 F4

UN: R\$ 136,61 AV: R\$ 136,61 15: R\$ 139,45
30: R\$ 142,24 45: R\$ 145,09 60: R\$ 147,99



MOCHILA INF FEM CARR SEREIA KIT 3PC 4808
Código: 49082 Fábrica: PONTO VERDE Unidade: UN/1 F1 F4

UN: R\$ 82,17 AV: R\$ 82,17 15: R\$ 83,88
30: R\$ 85,56 45: R\$ 87,27 60: R\$ 89,01



MOCHILA INF FEM EVA HIIHI 3D G M4924
Código: 49050 Fábrica: PONTO VERDE Unidade: UN/1 F1 F4

UN: R\$ 82,17 AV: R\$ 82,17 15: R\$ 83,88
30: R\$ 85,56 45: R\$ 87,27 60: R\$ 89,01



MOCHILA INF FEM EVA PRINCESS 3D G M5038
Código: 49049 Fábrica: PONTO VERDE Unidade: UN/1 F1 F4

UN: R\$ 77,03 AV: R\$ 77,03 15: R\$ 78,63
30: R\$ 80,21 45: R\$ 81,81 60: R\$ 83,45



MOCHILA INF FEM EVA 3D G M4920
Código: 49053 Fábrica: PONTO VERDE Unidade: UN/1 F1 F4

UN: R\$ 51,35 AV: R\$ 51,35 15: R\$ 52,42
30: R\$ 53,47 45: R\$ 54,54 60: R\$ 55,63



MOCHILA INF FEM FREAKY G M4812
Código: 49091 Fábrica: PONTO VERDE Unidade: UN/1 F1 F4

UN: R\$ 89,36 AV: R\$ 89,36 15: R\$ 91,22
30: R\$ 93,04 45: R\$ 94,90 60: R\$ 96,80



MOCHILA INF FEM M4324
Código: 44057 Fábrica: PONTO VERDE Unidade: UN/1 F1 F4

UN: R\$ 49,30 AV: R\$ 49,30 15: R\$ 50,32
30: R\$ 51,33 45: R\$ 52,36 60: R\$ 53,40



MOCHILA INF FEM RAYBOW G M4959

Código: 49095 Fábrica: PONTO VERDE Unidade: UN/1 F1 F4

UN: R\$ 49,30 AV: R\$ 49,30 15: R\$ 50,32
30: R\$ 51,33 45: R\$ 52,36 60: R\$ 53,40



MOCHILA INF FEM SEREIA G M4807

Código: 49097 Fábrica: PONTO VERDE Unidade: UN/1 F1 F4

UN: R\$ 51,35 AV: R\$ 51,35 15: R\$ 52,42
30: R\$ 53,47 45: R\$ 54,54 60: R\$ 55,63



MOCHILA INF FEM SEREIA PRE M4610

Código: 49061 Fábrica: PONTO VERDE Unidade: UN/1 F1 F4

UN: R\$ 46,21 AV: R\$ 46,21 15: R\$ 47,18
30: R\$ 48,12 45: R\$ 49,08 60: R\$ 50,06



MOCHILA INF FEM SEREIA PRE M4806

Código: 49096 Fábrica: PONTO VERDE Unidade: UN/1 F1 F4

UN: R\$ 51,35 AV: R\$ 51,35 15: R\$ 52,42
30: R\$ 53,47 45: R\$ 54,54 60: R\$ 55,63



MOCHILA INF FEM TWICE PRE M4118

Código: 49193 Fábrica: PONTO VERDE Unidade: UN/1 F1 F4

UN: R\$ 49,30 AV: R\$ 49,30 15: R\$ 50,32
30: R\$ 51,33 45: R\$ 52,36 60: R\$ 53,40



MOCHILA INF FEM 3 PRINCESAS M4823

Código: 49083 Fábrica: PONTO VERDE Unidade: UN/1 F1 F4

UN: R\$ 47,24 AV: R\$ 47,24 15: R\$ 48,23
30: R\$ 49,19 45: R\$ 50,17 60: R\$ 51,18



MOCHILA INF FEM 3 PRINCESAS PRE M4822

Código: 49084 Fábrica: PONTO VERDE Unidade: UN/1 F1 F4

UN: R\$ 51,35 AV: R\$ 51,35 15: R\$ 52,42
30: R\$ 53,47 45: R\$ 54,54 60: R\$ 55,63



MOCHILA INF GALAXY GIRL G M3554

Código: 38042 Fábrica: VOZZ Unidade: UN/1 F1 F4

UN: R\$ 48,27 AV: R\$ 48,27 15: R\$ 49,27
30: R\$ 50,26 45: R\$ 51,26 60: R\$ 52,29



MOCHILA INF KIDS PLAY G M4817

Código: 49094 Fábrica: PONTO VERDE Unidade: UN/1 F1 F4

UN: R\$ 61,62 AV: R\$ 61,62 15: R\$ 62,91
30: R\$ 64,16 45: R\$ 65,45 60: R\$ 66,76



MOCHILA INF LINHA BABY GATINHA M M4713

Código: 49192 Fábrica: PONTO VERDE Unidade: UN/1 F1 F4

UN: R\$ 97,57 AV: R\$ 97,57 15: R\$ 99,61
30: R\$ 101,60 45: R\$ 103,63 60: R\$ 105,70



MOCHILA INF LINHA BABY NARUT M4722

Código: 46707 Fábrica: PONTO VERDE Unidade: UN/1 F1 F4

UN: R\$ 82,17 AV: R\$ 82,17 15: R\$ 83,88
30: R\$ 85,56 45: R\$ 87,27 60: R\$ 89,01



MOCHILA INF LINHA BABY PRINCESS M4716

Código: 46705 Fábrica: PONTO VERDE Unidade: UN/1 F1 F4

UN: R\$ 52,38 AV: R\$ 52,38 15: R\$ 53,47
30: R\$ 54,54 45: R\$ 55,63 60: R\$ 56,74



MOCHILA INF LINHA BABY SETINADO POA 4719

Código: 49055 Fábrica: PONTO VERDE Unidade: UN/1 F1 F4

UN: R\$ 72,92 AV: R\$ 72,92 15: R\$ 74,44
30: R\$ 75,93 45: R\$ 77,45 60: R\$ 79,00



MOCHILA INF LINHA BABY SPEED WEB M4725

Código: 46706 Fábrica: PONTO VERDE Unidade: UN/1 F1 F4

UN: R\$ 44,16 AV: R\$ 44,16 15: R\$ 45,08
30: R\$ 45,98 45: R\$ 46,90 60: R\$ 47,84



MOCHILA INF LO SURPRISE REL BRILHO P 1226

Código: 35825 Fábrica: BRASILIMPORT Unidade: UN/1 F1 F4

UN: R\$ 47,24 AV: R\$ 47,24 15: R\$ 48,23
30: R\$ 49,19 45: R\$ 50,17 60: R\$ 51,18



MOCHILA INF MASC BATTLE PRE M4844

Código: 49086 Fábrica: PONTO VERDE Unidade: UN/1 F1 F4

UN: R\$ 49,30 AV: R\$ 49,30 15: R\$ 50,32
30: R\$ 51,33 45: R\$ 52,36 60: R\$ 53,40



MOCHILA INF MASC BLOOK GAME G M4850
Código: Fábrica: Unidade:
49089 PONTO VERDE UN/1
F1 F4

UN: R\$ 143,80 AV: R\$ 143,80 15: R\$ 146,79
30: R\$ 149,73 45: R\$ 152,72 60: R\$ 155,78



MOCHILA INF MASC CARR SPACE KIT 3PC 4865
Código: Fábrica: Unidade:
49037 PONTO VERDE UN/1
F1 F4

UN: R\$ 92,44 AV: R\$ 92,44 15: R\$ 94,36
30: R\$ 96,25 45: R\$ 98,18 60: R\$ 100,14



MOCHILA INF MASC EVA ARANHA 3D G M4892
Código: Fábrica: Unidade:
49045 PONTO VERDE UN/1
F1 F4

UN: R\$ 82,17 AV: R\$ 82,17 15: R\$ 83,88
30: R\$ 85,56 45: R\$ 87,27 60: R\$ 89,01



MOCHILA INF MASC EVA ARANHA 3D G M4916
Código: Fábrica: Unidade:
49048 PONTO VERDE UN/1
F1 F4

UN: R\$ 85,25 AV: R\$ 85,25 15: R\$ 87,02
30: R\$ 88,76 45: R\$ 90,54 60: R\$ 92,35



MOCHILA INF MASC EVA ESTRELA 3D G M4900
Código: Fábrica: Unidade:
49046 PONTO VERDE UN/1
F1 F4

UN: R\$ 78,06 AV: R\$ 78,06 15: R\$ 79,68
30: R\$ 81,28 45: R\$ 82,90 60: R\$ 84,56



MOCHILA INF MASC EVA KARS KIDS 3D M4514
Código: Fábrica: Unidade:
49215 PONTO VERDE UN/1
F1 F4

UN: R\$ 85,25 AV: R\$ 85,25 15: R\$ 87,02
30: R\$ 88,76 45: R\$ 90,54 60: R\$ 92,35



MOCHILA INF MASC EVA MORCEGO 3D G M4896
Código: Fábrica: Unidade:
49047 PONTO VERDE UN/1
F1 F4

UN: R\$ 77,03 AV: R\$ 77,03 15: R\$ 78,63
30: R\$ 80,21 45: R\$ 81,81 60: R\$ 83,45



MOCHILA INF MASC EVA SUPER RACE 3D M4908
Código: Fábrica: Unidade:
49054 PONTO VERDE UN/1
F1 F4

UN: R\$ 77,03 AV: R\$ 77,03 15: R\$ 78,63
30: R\$ 80,21 45: R\$ 81,81 60: R\$ 83,45



MOCHILA INF MASC EVA 3D M4904
Código: Fábrica: Unidade:
49052 PONTO VERDE UN/1
F1 F4

UN: R\$ 51,35 AV: R\$ 51,35 15: R\$ 52,42
30: R\$ 53,47 45: R\$ 54,54 60: R\$ 55,63



MOCHILA INF MASC GAME WORLD M4829
Código: Fábrica: Unidade:
49092 PONTO VERDE UN/1
F1 F4

UN: R\$ 61,62 AV: R\$ 61,62 15: R\$ 62,91
30: R\$ 64,16 45: R\$ 65,45 60: R\$ 66,76



MOCHILA INF MASC GUARDIAN NIGHT PRE 4172
Código: Fábrica: Unidade:
44395 PONTO VERDE UN/1
F1 F4

UN: R\$ 49,30 AV: R\$ 49,30 15: R\$ 50,32
30: R\$ 51,33 45: R\$ 52,36 60: R\$ 53,40



MOCHILA INF MASC JUNGLE HUNTERS G M4834
Código: Fábrica: Unidade:
49090 PONTO VERDE UN/1
F1 F4

UN: R\$ 52,38 AV: R\$ 52,38 15: R\$ 53,47
30: R\$ 54,54 45: R\$ 55,63 60: R\$ 56,74



MOCHILA INF MASC SPACE G M4864
Código: Fábrica: Unidade:
49062 PONTO VERDE UN/1
F1 F4

UN: R\$ 51,35 AV: R\$ 51,35 15: R\$ 52,42
30: R\$ 53,47 45: R\$ 54,54 60: R\$ 55,63



MOCHILA INF MASC STATION DOG M4839
Código: Fábrica: Unidade:
49098 PONTO VERDE UN/1
F1 F4

UN: R\$ 45,12 AV: R\$ 45,12 15: R\$ 46,07
30: R\$ 46,99 45: R\$ 47,93 60: R\$ 48,88



MOCHILA INF NINJA G M4682
Código: Fábrica: Unidade:
49022 PONTO VERDE UN/1
F1 F4

UN: R\$ 71,89 AV: R\$ 71,89 15: R\$ 73,39
30: R\$ 74,86 45: R\$ 76,36 60: R\$ 77,88



MOCHILA INF PET PRINCESS REL P 3084
Código: Fábrica: Unidade:
32242 SBC UN/1
F1 F4

UN: R\$ 67,80 AV: R\$ 67,80 15: R\$ 69,21
30: R\$ 70,59 45: R\$ 72,00 60: R\$ 73,44



MOCHILA INF PIGGY G 2399

Código: 29523 Fábrica: SBC Unidade: UN/1 F1 F4

UN: R\$ 67,95 AV: R\$ 67,95 15: R\$ 69,36
30: R\$ 70,75 45: R\$ 72,17 60: R\$ 73,61



MOCHILA INF PIGGY BOY RELEVO G 2431

Código: 29608 Fábrica: SBC Unidade: UN/1 F1 F4

UN: R\$ 51,35 AV: R\$ 51,35 15: R\$ 52,42
30: R\$ 53,47 45: R\$ 54,54 60: R\$ 55,63



MOCHILA INF PIGGY G 2001

Código: 29622 Fábrica: SBC Unidade: UN/1 F1 F4

UN: R\$ 40,57 AV: R\$ 40,57 15: R\$ 41,42
30: R\$ 42,25 45: R\$ 43,09 60: R\$ 43,95



MOCHILA INF PIGGY P 2000

Código: 29667 Fábrica: VOZZ Unidade: UN/1 F1 F4

UN: R\$ 65,74 AV: R\$ 65,74 15: R\$ 67,11
30: R\$ 68,45 45: R\$ 69,82 60: R\$ 71,22



MOCHILA INF PIGGY RELEVO P 2398

Código: 29606 Fábrica: SBC Unidade: UN/1 F1 F4

UN: R\$ 52,38 AV: R\$ 52,38 15: R\$ 53,47
30: R\$ 54,54 45: R\$ 55,63 60: R\$ 56,74



MOCHILA INF PRINCESA G M4632

Código: 49057 Fábrica: PONTO VERDE Unidade: UN/1 F1 F4

UN: R\$ 61,62 AV: R\$ 61,62 15: R\$ 62,91
30: R\$ 64,16 45: R\$ 65,45 60: R\$ 66,76



MOCHILA INF PRINCESS G 2666

Código: 31344 Fábrica: SBC Unidade: UN/1 F1 F4

UN: R\$ 71,89 AV: R\$ 71,89 15: R\$ 73,39
30: R\$ 74,86 45: R\$ 76,36 60: R\$ 77,88



MOCHILA INF PRINCESS ON ICE REL M 3103

Código: 31859 Fábrica: SBC Unidade: UN/1 F1 F4

UN: R\$ 61,62 AV: R\$ 61,62 15: R\$ 62,91
30: R\$ 64,16 45: R\$ 65,45 60: R\$ 66,76



MOCHILA INF PRINCESS ON ICE P 2509

Código: 30735 Fábrica: SBC Unidade: UN/1 F1 F4

UN: R\$ 66,76 AV: R\$ 66,76 15: R\$ 68,15
30: R\$ 69,51 45: R\$ 70,90 60: R\$ 72,32



MOCHILA INF PRINCESS ON ICE P 2594

Código: 30761 Fábrica: SBC Unidade: UN/1 F1 F4

UN: R\$ 71,89 AV: R\$ 71,89 15: R\$ 73,39
30: R\$ 74,86 45: R\$ 76,36 60: R\$ 77,88



MOCHILA INF PRINCESS ON ICE P 3001

Código: 31860 Fábrica: SBC Unidade: UN/1 F1 F4

UN: R\$ 71,89 AV: R\$ 71,89 15: R\$ 73,39
30: R\$ 74,86 45: R\$ 76,36 60: R\$ 77,88



MOCHILA INF PRINCESS ON ICE P 3102

Código: 31857 Fábrica: SBC Unidade: UN/1 F1 F4

UN: R\$ 66,76 AV: R\$ 66,76 15: R\$ 68,15
30: R\$ 69,51 45: R\$ 70,90 60: R\$ 72,32



MOCHILA INF PRINCESS ON ICE REL G 2674

Código: 30740 Fábrica: SBC Unidade: UN/1 F1 F4

UN: R\$ 71,89 AV: R\$ 71,89 15: R\$ 73,39
30: R\$ 74,86 45: R\$ 76,36 60: R\$ 77,88



MOCHILA INF PRINCESS ON ICE REL M 2763

Código: 31313 Fábrica: SBC Unidade: UN/1 F1 F4

UN: R\$ 71,89 AV: R\$ 71,89 15: R\$ 73,39
30: R\$ 74,86 45: R\$ 76,36 60: R\$ 77,88



MOCHILA INF PRINCESS ON ICE REL M 3068

Código: 32244 Fábrica: SBC Unidade: UN/1 F1 F4

UN: R\$ 56,49 AV: R\$ 56,49 15: R\$ 57,66
30: R\$ 58,82 45: R\$ 59,99 60: R\$ 61,19



MOCHILA INF PRINCESS P 2901

Código: 32240 Fábrica: SBC Unidade: UN/1 F1 F4

UN: R\$ 44,16 AV: R\$ 44,16 15: R\$ 45,08
30: R\$ 45,98 45: R\$ 46,90 60: R\$ 47,84



MOCHILA INF PRINCESS REL BRILHO P 1226

Código: 35823 Fábrica: BRASILIMPORT Unidade: UN/1 F1 F4

UN: R\$ 65,74 AV: R\$ 65,74 15: R\$ 67,11
30: R\$ 68,45 45: R\$ 69,82 60: R\$ 71,22



MOCHILA INF PRINCESS REL G 3072

Código: 32254 Fábrica: SBC Unidade: UN/1 F1 F4

UN: R\$ 71,89 AV: R\$ 71,89 15: R\$ 73,39
30: R\$ 74,86 45: R\$ 76,36 60: R\$ 77,88



MOCHILA INF PRINCESS REL M 3029

Código: 31924 Fábrica: SBC Unidade: UN/1 F1 F4

UN: R\$ 71,89 AV: R\$ 71,89 15: R\$ 73,39
30: R\$ 74,86 45: R\$ 76,36 60: R\$ 77,88



MOCHILA INF PRINCESS REL M 3091

Código: 32255 Fábrica: SBC Unidade: UN/1 F1 F4

UN: R\$ 66,76 AV: R\$ 66,76 15: R\$ 68,15
30: R\$ 69,51 45: R\$ 70,90 60: R\$ 72,32



MOCHILA INF PRINCESS REL P 3028

Código: 31923 Fábrica: SBC Unidade: UN/1 F1 F4

UN: R\$ 61,62 AV: R\$ 61,62 15: R\$ 62,91
30: R\$ 64,16 45: R\$ 65,45 60: R\$ 66,76



MOCHILA INF REBEL PRINCESS REL G 2670

Código: 31315 Fábrica: SBC Unidade: UN/1 F1 F4

UN: R\$ 52,38 AV: R\$ 52,38 15: R\$ 53,47
30: R\$ 54,54 45: R\$ 55,63 60: R\$ 56,74



MOCHILA INF SEREIA G M4612

Código: 49059 Fábrica: PONTO VERDE Unidade: UN/1 F1 F4

UN: R\$ 51,35 AV: R\$ 51,35 15: R\$ 52,42
30: R\$ 53,47 45: R\$ 54,54 60: R\$ 55,63



MOCHILA INF SEREIA P M4611

Código: 49060 Fábrica: PONTO VERDE Unidade: UN/1 F1 F4

UN: R\$ 44,16 AV: R\$ 44,16 15: R\$ 45,08
30: R\$ 45,98 45: R\$ 46,90 60: R\$ 47,84



MOCHILA INF SOFI REL BRILHO P 1226

Código: 35826 Fábrica: BRASILIMPORT Unidade: UN/1 F1 F4

UN: R\$ 71,89 AV: R\$ 71,89 15: R\$ 73,39
30: R\$ 74,86 45: R\$ 76,36 60: R\$ 77,88



MOCHILA INF SOPHIA REL P 2624

Código: 30748 Fábrica: SBC Unidade: UN/1 F1 F4

UN: R\$ 51,35 AV: R\$ 51,35 15: R\$ 52,42
30: R\$ 53,47 45: R\$ 54,54 60: R\$ 55,63



MOCHILA INF SPEED BOY 2 M3598

Código: 38055 Fábrica: SBC Unidade: UN/1 F1 F4

UN: R\$ 63,79 AV: R\$ 63,79 15: R\$ 65,12
30: R\$ 66,42 45: R\$ 67,75 60: R\$ 69,10



MOCHILA INF SPEED WEB G M4642

Código: 49025 Fábrica: PONTO VERDE Unidade: UN/1 F1 F4

UN: R\$ 47,24 AV: R\$ 47,24 15: R\$ 48,23
30: R\$ 49,19 45: R\$ 50,17 60: R\$ 51,18



MOCHILA INF SPEED WEB P M4641

Código: 49023 Fábrica: PONTO VERDE Unidade: UN/1 F1 F4

UN: R\$ 44,16 AV: R\$ 44,16 15: R\$ 45,08
30: R\$ 45,98 45: R\$ 46,90 60: R\$ 47,84



MOCHILA INF SPEED WEB PRE M4640

Código: 49024 Fábrica: PONTO VERDE Unidade: UN/1 F1 F4

UN: R\$ 61,62 AV: R\$ 61,62 15: R\$ 62,91
30: R\$ 64,16 45: R\$ 65,45 60: R\$ 66,76



MOCHILA INF STAR SHOW M 3879

Código: 36099 Fábrica: SBC Unidade: UN/1 F1 F4

UN: R\$ 56,49 AV: R\$ 56,49 15: R\$ 57,66
30: R\$ 58,82 45: R\$ 59,99 60: R\$ 61,19



MOCHILA INF STAR SHOW P M3878

Código: 36100 Fábrica: SBC Unidade: UN/1 F1 F4

UN: R\$ 56,49 AV: R\$ 56,49 15: R\$ 57,66
30: R\$ 58,82 45: R\$ 59,99 60: R\$ 61,19



MOCHILA INF STAR SHOW PP 3877

Código: Fábrica: Unidade:
36035 SBC UN/1
F1 F4

UN: R\$ 51,35 AV: R\$ 51,35 15: R\$ 52,42
30: R\$ 53,47 45: R\$ 54,54 60: R\$ 55,63



MOCHILA INF SUPER CATHIE P M3547

Código: Fábrica: Unidade:
38011 VOZZ UN/1
F1 F4

UN: R\$ 56,49 AV: R\$ 56,49 15: R\$ 57,66
30: R\$ 58,82 45: R\$ 59,99 60: R\$ 61,19



MOCHILA INF UNILOVERS M M3719

Código: Fábrica: Unidade:
38050 VOZZ UN/1
F1 F4

UN: R\$ 56,49 AV: R\$ 56,49 15: R\$ 57,66
30: R\$ 58,82 45: R\$ 59,99 60: R\$ 61,19



MOCHILA INF UNILOVERS P M3718

Código: Fábrica: Unidade:
34174 SBC UN/1
F1 F4

UN: R\$ 61,62 AV: R\$ 61,62 15: R\$ 62,91
30: R\$ 64,16 45: R\$ 65,45 60: R\$ 66,76



MOCHILA JEANS EST 3 DIV DETAL CORINO 326

Código: Fábrica: Unidade:
31679 LITA UN/1
F1 F4

UN: R\$ 56,49 AV: R\$ 56,49 15: R\$ 57,66
30: R\$ 58,82 45: R\$ 59,99 60: R\$ 61,19



MOCHILA JEANS ESTAMPADO FORRO DUPLO 320

Código: Fábrica: Unidade:
28776 LITA UN/1
F1 F4

UN: R\$ 32,86 AV: R\$ 32,86 15: R\$ 33,54
30: R\$ 34,22 45: R\$ 34,90 60: R\$ 35,60



MOCHILA JEANS S/LAVAR AZUL 321

Código: Fábrica: Unidade:
14628 LITA UN/1
F1 F4

UN: R\$ 30,81 AV: R\$ 30,81 15: R\$ 31,45
30: R\$ 32,08 45: R\$ 32,72 60: R\$ 33,37



MOCHILA JEANS S/LAVAR PRETA 332

Código: Fábrica: Unidade:
48455 LITA UN/1
F1 F4

UN: R\$ 289,59 AV: R\$ 289,59 15: R\$ 295,63
30: R\$ 301,54 45: R\$ 307,57 60: R\$ 313,72



MOCHILA JUV CARR KIT 3PCS MCK 3962

Código: Fábrica: Unidade:
41432 SBC CJ/1
F1 F4

UN: R\$ 139,00 AV: R\$ 139,00 15: R\$ 141,90
30: R\$ 144,73 45: R\$ 147,63 60: R\$ 150,58



MOCHILA JUV C/CARR FEM VIKING MC3983

Código: Fábrica: Unidade:
41426 SBC UN/1
F1 F4

UN: R\$ 115,04 AV: R\$ 115,04 15: R\$ 117,43
30: R\$ 119,78 45: R\$ 122,18 60: R\$ 124,62



MOCHILA JUV FEM POLIESTER MORMAII 0116

Código: Fábrica: Unidade:
44032 MORMAII UN/1
F1 F4

UN: R\$ 115,04 AV: R\$ 115,04 15: R\$ 117,43
30: R\$ 119,78 45: R\$ 122,18 60: R\$ 124,62



MOCHILA JUV FEM POLIESTER MORMAII 0119

Código: Fábrica: Unidade:
44033 MORMAII UN/1
F1 F4

UN: R\$ 115,04 AV: R\$ 115,04 15: R\$ 117,43
30: R\$ 119,78 45: R\$ 122,18 60: R\$ 124,62



MOCHILA JUV FEM POLIESTER MORMAII 0121

Código: Fábrica: Unidade:
44034 MORMAII UN/1
F1 F4

UN: R\$ 115,04 AV: R\$ 115,04 15: R\$ 117,43
30: R\$ 119,78 45: R\$ 122,18 60: R\$ 124,62



MOCHILA JUV FEM POLIESTER MORMAII 0122

Código: Fábrica: Unidade:
44036 MORMAII UN/1
F1 F4

UN: R\$ 71,89 AV: R\$ 71,89 15: R\$ 73,39
30: R\$ 74,86 45: R\$ 76,36 60: R\$ 77,88



MOCHILA JUV FLAMINGO M M4057

Código: Fábrica: Unidade:
41430 VOZZ UN/1
F1 F4

UN: R\$ 115,04 AV: R\$ 115,04 15: R\$ 117,43
30: R\$ 119,78 45: R\$ 122,18 60: R\$ 124,62



MOCHILA JUV POLIESTER MORMAII 0111

Código: Fábrica: Unidade:
44037 MORMAII UN/1
F1 F4

UN: R\$ 115,04 AV: R\$ 115,04 15: R\$ 117,43
30: R\$ 119,78 45: R\$ 122,18 60: R\$ 124,62



MOCHILA JUV POLIESTER MORMAII 0113

Código: Fábrica: Unidade:
44039 MORMAII UN/1
F1 F4

UN: R\$ 115,04 AV: R\$ 115,04 15: R\$ 117,43
30: R\$ 119,78 45: R\$ 122,18 60: R\$ 124,62



MOCHILA JUV POLIESTER MORMAII 0115

Código: Fábrica: Unidade:
44035 MORMAII UN/1
F1 F4

UN: R\$ 123,25 AV: R\$ 123,25 15: R\$ 125,82
30: R\$ 128,34 45: R\$ 130,90 60: R\$ 133,52



MOCHILA JUV POLIESTER MORMAII 0120

Código: Fábrica: Unidade:
44038 MORMAII UN/1
F1 F4

UN: R\$ 49,30 AV: R\$ 49,30 15: R\$ 50,32
30: R\$ 51,33 45: R\$ 52,36 60: R\$ 53,40



MOCHILA JUVENIL BASIC 21734

Código: Fábrica: Unidade:
43222 WINTH UN/1
F1 F4

UN: R\$ 49,30 AV: R\$ 49,30 15: R\$ 50,32
30: R\$ 51,33 45: R\$ 52,36 60: R\$ 53,40



MOCHILA JUVENIL CASUAL POLIESTER 32084

Código: Fábrica: Unidade:
44071 WINTH UN/1
F1 F4

UN: R\$ 49,30 AV: R\$ 49,30 15: R\$ 50,32
30: R\$ 51,33 45: R\$ 52,36 60: R\$ 53,40



MOCHILA JUVENIL CASUAL 32142

Código: Fábrica: Unidade:
43600 WINTH UN/1
F1 F4

UN: R\$ 82,17 AV: R\$ 82,17 15: R\$ 83,88
30: R\$ 85,56 45: R\$ 87,27 60: R\$ 89,01



MOCHILA JUVENIL COST HOT PINK 0800404

Código: Fábrica: Unidade:
35620 GOSUPER UN/1
F1 F4

UN: R\$ 143,80 AV: R\$ 143,80 15: R\$ 146,79
30: R\$ 149,73 45: R\$ 152,72 60: R\$ 155,78



MOCHILA JUVENIL FEM ESTAMPA 30063

Código: Fábrica: Unidade:
45938 WINTH TEEN UN/1
F1 F4

UN: R\$ 90,38 AV: R\$ 90,38 15: R\$ 92,27
30: R\$ 94,11 45: R\$ 95,99 60: R\$ 97,91



MOCHILA JUVENIL FEM FS BORBOLETAS 30511

Código: Fábrica: Unidade:
45939 WINTH UN/1
F1 F4

UN: R\$ 90,38 AV: R\$ 90,38 15: R\$ 92,27
30: R\$ 94,11 45: R\$ 95,99 60: R\$ 97,91



MOCHILA JUVENIL FEM FS FLAMINGOS 30461

Código: Fábrica: Unidade:
45940 WINTH UN/1
F1 F4

UN: R\$ 105,79 AV: R\$ 105,79 15: R\$ 108,00
30: R\$ 110,16 45: R\$ 112,36 60: R\$ 114,61



MOCHILA JUVENIL FEM LOVEKING M4736

Código: Fábrica: Unidade:
48982 PONTO VERDE UN/1
F1 F4

UN: R\$ 105,79 AV: R\$ 105,79 15: R\$ 108,00
30: R\$ 110,16 45: R\$ 112,36 60: R\$ 114,61



MOCHILA JUVENIL FEM LOVEKING M4737

Código: Fábrica: Unidade:
48967 PONTO VERDE UN/1
F1 F4

UN: R\$ 97,57 AV: R\$ 97,57 15: R\$ 99,61
30: R\$ 101,60 45: R\$ 103,63 60: R\$ 105,70



MOCHILA JUVENIL FEM LOVEKING M5033

Código: Fábrica: Unidade:
48975 PONTO VERDE UN/1
F1 F4

UN: R\$ 97,57 AV: R\$ 97,57 15: R\$ 99,61
30: R\$ 101,60 45: R\$ 103,63 60: R\$ 105,70



MOCHILA JUVENIL FEM LOVEKING M5034

Código: Fábrica: Unidade:
48972 PONTO VERDE UN/1
F1 F4

UN: R\$ 97,57 AV: R\$ 97,57 15: R\$ 99,61
30: R\$ 101,60 45: R\$ 103,63 60: R\$ 105,70



MOCHILA JUVENIL FEM LOVEKING M5035

Código: Fábrica: Unidade:
48978 PONTO VERDE UN/1
F1 F4

UN: R\$ 99,63 AV: R\$ 99,63 15: R\$ 101,70
30: R\$ 103,74 45: R\$ 105,81 60: R\$ 107,93



MOCHILA JUVENIL FEM LOVEKING M5036

Código: Fábrica: Unidade:
48970 PONTO VERDE UN/1
F1 F4

UN: R\$ 71,89 AV: R\$ 71,89 15: R\$ 73,39
30: R\$ 74,86 45: R\$ 76,36 60: R\$ 77,88



MOCHILA JUVENIL FEM MH3300

Código: 32348 Fábrica: SBC Unidade: UN/1 F1 F4

UN: R\$ 71,89 AV: R\$ 71,89 15: R\$ 73,39
30: R\$ 74,86 45: R\$ 76,36 60: R\$ 77,88



MOCHILA JUVENIL FEM MH3303

Código: 32110 Fábrica: SBC Unidade: UN/1 F1 F4

UN: R\$ 66,76 AV: R\$ 66,76 15: R\$ 68,15
30: R\$ 69,51 45: R\$ 70,90 60: R\$ 72,32



MOCHILA JUVENIL FEM POLIESTER GARDE 2331

Código: 44049 Fábrica: RABISK Unidade: UN/1 F1 F4

UN: R\$ 66,76 AV: R\$ 66,76 15: R\$ 68,15
30: R\$ 69,51 45: R\$ 70,90 60: R\$ 72,32



MOCHILA JUVENIL FEM POLIESTER STARS 2332

Código: 44050 Fábrica: RABISK Unidade: UN/1 F1 F4

UN: R\$ 107,85 AV: R\$ 107,85 15: R\$ 110,09
30: R\$ 112,29 45: R\$ 114,54 60: R\$ 116,83



MOCHILA JUVENIL FEM SBC MH MH3768

Código: 36033 Fábrica: SBC Unidade: UN/1 F1 F4

UN: R\$ 143,80 AV: R\$ 143,80 15: R\$ 146,79
30: R\$ 149,73 45: R\$ 152,72 60: R\$ 155,78



MOCHILA JUVENIL FEM SBC MH MH3971

Código: 36044 Fábrica: SBC Unidade: UN/1 F1 F4

UN: R\$ 102,71 AV: R\$ 102,71 15: R\$ 104,85
30: R\$ 106,95 45: R\$ 109,09 60: R\$ 111,27

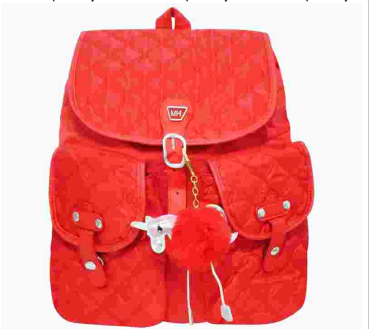

MOCHILA JUVENIL FEM SBC MH M3767

Código: 36094 Fábrica: SBC Unidade: UN/1 F1 F4

UN: R\$ 105,79 AV: R\$ 105,79 15: R\$ 108,00
30: R\$ 110,16 45: R\$ 112,36 60: R\$ 114,61



MOCHILA JUVENIL FEM SBC MH M3769

Código: 36058 Fábrica: SBC Unidade: UN/1 F1 F4

UN: R\$ 102,72 AV: R\$ 102,72 15: R\$ 104,86
30: R\$ 106,96 45: R\$ 109,10 60: R\$ 111,28



MOCHILA JUVENIL FEM SBC MH3171

Código: 32320 Fábrica: SBC Unidade: UN/1 F1 F4

UN: R\$ 112,99 AV: R\$ 112,99 15: R\$ 115,35
30: R\$ 117,65 45: R\$ 120,01 60: R\$ 122,41



MOCHILA JUVENIL FEM SBC VKG M3987

Código: 36220 Fábrica: SBC Unidade: UN/1 F1 F4

UN: R\$ 97,57 AV: R\$ 97,57 15: R\$ 99,61
30: R\$ 101,60 45: R\$ 103,63 60: R\$ 105,70



MOCHILA JUVENIL FEM TOP MODEL TM25

Código: 48974 Fábrica: PONTO VERDE Unidade: UN/1 F1 F4

UN: R\$ 97,57 AV: R\$ 97,57 15: R\$ 99,61
30: R\$ 101,60 45: R\$ 103,63 60: R\$ 105,70



MOCHILA JUVENIL FEM TOP MODEL TM26

Código: 48979 Fábrica: PONTO VERDE Unidade: UN/1 F1 F4

UN: R\$ 61,62 AV: R\$ 61,62 15: R\$ 62,91
30: R\$ 64,16 45: R\$ 65,45 60: R\$ 66,76



MOCHILA JUVENIL FEM UNI LOVER EMOJ M3774

Código: 34304 Fábrica: SBC Unidade: UN/1 F1 F4

UN: R\$ 105,79 AV: R\$ 105,79 15: R\$ 108,00
30: R\$ 110,16 45: R\$ 112,36 60: R\$ 114,61



MOCHILA JUVENIL FEM VKG M4263

Código: 48963 Fábrica: PONTO VERDE Unidade: UN/1 F1 F4

UN: R\$ 97,57 AV: R\$ 97,57 15: R\$ 99,61
30: R\$ 101,60 45: R\$ 103,63 60: R\$ 105,70



MOCHILA JUVENIL FEM VKG M4286

Código: 48971 Fábrica: PONTO VERDE Unidade: UN/1 F1 F4

UN: R\$ 143,80 AV: R\$ 143,80 15: R\$ 146,79
30: R\$ 149,73 45: R\$ 152,72 60: R\$ 155,78



MOCHILA JUVENIL FEM VKG M4302

Código: 44396 Fábrica: PONTO VERDE Unidade: UN/1 F1 F4

UN: R\$ 112,98 AV: R\$ 112,98 15: R\$ 115,34
30: R\$ 117,64 45: R\$ 120,00 60: R\$ 122,40



MOCHILA JUVENIL FEM VKG M4305

Código: Fábrika: Unidade:
44398 PONTO VERDE UN/1
F1 F4

UN: R\$ 107,85 AV: R\$ 107,85 15: R\$ 110,09
30: R\$ 112,29 45: R\$ 114,54 60: R\$ 116,83



MOCHILA JUVENIL FEM VKG M4356

Código: Fábrika: Unidade:
48981 PONTO VERDE UN/1
F1 F4

UN: R\$ 87,30 AV: R\$ 87,30 15: R\$ 89,12
30: R\$ 90,90 45: R\$ 92,72 60: R\$ 94,58



MOCHILA JUVENIL FEM WOOKEY 3687

Código: Fábrika: Unidade:
34206 WOOKEY UN/1
F1 F4

UN: R\$ 49,30 AV: R\$ 49,30 15: R\$ 50,32
30: R\$ 51,33 45: R\$ 52,36 60: R\$ 53,40



MOCHILA JUVENIL FEM 31824

Código: Fábrika: Unidade:
43594 WINTH UN/1
F1 F4

UN: R\$ 49,30 AV: R\$ 49,30 15: R\$ 50,32
30: R\$ 51,33 45: R\$ 52,36 60: R\$ 53,40



MOCHILA JUVENIL FEM 31834

Código: Fábrika: Unidade:
43593 WINTH UN/1
F1 F4

UN: R\$ 49,30 AV: R\$ 49,30 15: R\$ 50,32
30: R\$ 51,33 45: R\$ 52,36 60: R\$ 53,40



MOCHILA JUVENIL FEM 31844

Código: Fábrika: Unidade:
43595 WINTH UN/1
F1 F4

UN: R\$ 49,30 AV: R\$ 49,30 15: R\$ 50,32
30: R\$ 51,33 45: R\$ 52,36 60: R\$ 53,40



MOCHILA JUVENIL FEM 31924

Código: Fábrika: Unidade:
43229 WINTH UN/1
F1 F4

UN: R\$ 49,30 AV: R\$ 49,30 15: R\$ 50,32
30: R\$ 51,33 45: R\$ 52,36 60: R\$ 53,40



MOCHILA JUVENIL FEM 31994

Código: Fábrika: Unidade:
43228 WINTH UN/1
F1 F4

UN: R\$ 49,30 AV: R\$ 49,30 15: R\$ 50,32
30: R\$ 51,33 45: R\$ 52,36 60: R\$ 53,40



MOCHILA JUVENIL FEM 32014

Código: Fábrika: Unidade:
43225 WINTH UN/1
F1 F4

UN: R\$ 49,30 AV: R\$ 49,30 15: R\$ 50,32
30: R\$ 51,33 45: R\$ 52,36 60: R\$ 53,40



MOCHILA JUVENIL FEM 32024

Código: Fábrika: Unidade:
43226 WINTH UN/1
F1 F4

UN: R\$ 49,30 AV: R\$ 49,30 15: R\$ 50,32
30: R\$ 51,33 45: R\$ 52,36 60: R\$ 53,40



MOCHILA JUVENIL FEM 32034

Código: Fábrika: Unidade:
43227 WINTH UN/1
F1 F4

UN: R\$ 49,30 AV: R\$ 49,30 15: R\$ 50,32
30: R\$ 51,33 45: R\$ 52,36 60: R\$ 53,40



MOCHILA JUVENIL FEM 32054

Código: Fábrika: Unidade:
43596 WINTH UN/1
F1 F4

UN: R\$ 107,85 AV: R\$ 107,85 15: R\$ 110,09
30: R\$ 112,29 45: R\$ 114,54 60: R\$ 116,83



MOCHILA JUVENIL HI PANDA 4327

Código: Fábrika: Unidade:
44397 PONTO VERDE UN/1
F1 F4

UN: R\$ 73,95 AV: R\$ 73,95 15: R\$ 75,49
30: R\$ 77,00 45: R\$ 78,54 60: R\$ 80,11



MOCHILA JUVENIL JAKARTA M5000

Código: Fábrika: Unidade:
49012 PONTO VERDE UN/1
F1 F4

UN: R\$ 73,95 AV: R\$ 73,95 15: R\$ 75,49
30: R\$ 77,00 45: R\$ 78,54 60: R\$ 80,11



MOCHILA JUVENIL JAKARTA M5006

Código: Fábrika: Unidade:
49017 PONTO VERDE UN/1
F1 F4

UN: R\$ 84,22 AV: R\$ 84,22 15: R\$ 85,97
30: R\$ 87,69 45: R\$ 89,45 60: R\$ 91,24



MOCHILA JUVENIL JAKARTA M5008

Código: Fábrika: Unidade:
49018 PONTO VERDE UN/1
F1 F4

UN: R\$ 35,94 AV: R\$ 35,94 15: R\$ 36,69
30: R\$ 37,42 45: R\$ 38,17 60: R\$ 38,94



MOCHILA JUVENIL MASC FULL COLOR 21834

Código: Fábrica: Unidade:
45937 WINTH UN/1
F1 F4

UN: R\$ 143,80 AV: R\$ 143,80 15: R\$ 146,79
30: R\$ 149,73 45: R\$ 152,72 60: R\$ 155,78



MOCHILA JUVENIL MASC PATCHES 20023

Código: Fábrica: Unidade:
45936 WINTH TEEN UN/1
F1 F4

UN: R\$ 49,30 AV: R\$ 49,30 15: R\$ 50,32
30: R\$ 51,33 45: R\$ 52,36 60: R\$ 53,40



MOCHILA JUVENIL MASC POLIESTER 21774

Código: Fábrica: Unidade:
44070 WINTH UN/1
F1 F4

UN: R\$ 49,30 AV: R\$ 49,30 15: R\$ 50,32
30: R\$ 51,33 45: R\$ 52,36 60: R\$ 53,40



MOCHILA JUVENIL MASC 21534

Código: Fábrica: Unidade:
43597 WINTH UN/1
F1 F4

UN: R\$ 49,30 AV: R\$ 49,30 15: R\$ 50,32
30: R\$ 51,33 45: R\$ 52,36 60: R\$ 53,40



MOCHILA JUVENIL MASC 21584

Código: Fábrica: Unidade:
43598 WINTH UN/1
F1 F4

UN: R\$ 49,30 AV: R\$ 49,30 15: R\$ 50,32
30: R\$ 51,33 45: R\$ 52,36 60: R\$ 53,40



MOCHILA JUVENIL MASC 21594

Código: Fábrica: Unidade:
43599 WINTH UN/1
F1 F4

UN: R\$ 49,30 AV: R\$ 49,30 15: R\$ 50,32
30: R\$ 51,33 45: R\$ 52,36 60: R\$ 53,40



MOCHILA JUVENIL MASC 21724

Código: Fábrica: Unidade:
43223 WINTH UN/1
F1 F4

UN: R\$ 49,30 AV: R\$ 49,30 15: R\$ 50,32
30: R\$ 51,33 45: R\$ 52,36 60: R\$ 53,40



MOCHILA JUVENIL MASC 21744

Código: Fábrica: Unidade:
43224 WINTH UN/1
F1 F4

UN: R\$ 92,44 AV: R\$ 92,44 15: R\$ 94,36
30: R\$ 96,25 45: R\$ 98,18 60: R\$ 100,14



MOCHILA JUVENIL MH M3445

Código: Fábrica: Unidade:
34195 SBC UN/1
F1 F4

UN: R\$ 116,06 AV: R\$ 116,06 15: R\$ 118,48
30: R\$ 120,85 45: R\$ 123,27 60: R\$ 125,73



MOCHILA JUVENIL POLIESTER FEM WILSON 531

Código: Fábrica: Unidade:
43668 WILSON UN/1
F1 F4

UN: R\$ 102,71 AV: R\$ 102,71 15: R\$ 104,85
30: R\$ 106,95 45: R\$ 109,09 60: R\$ 111,27



MOCHILA JUVENIL POLIESTER MORMAII 110/21

Código: Fábrica: Unidade:
45404 MORMAII UN/1
F1 F4

UN: R\$ 95,68 AV: R\$ 95,68 15: R\$ 97,68
30: R\$ 99,63 45: R\$ 101,62 60: R\$ 103,66



MOCHILA JUVENIL POLIESTER MORMAII 124

Código: Fábrica: Unidade:
45405 MORMAII UN/1
F1 F4

UN: R\$ 102,71 AV: R\$ 102,71 15: R\$ 104,85
30: R\$ 106,95 45: R\$ 109,09 60: R\$ 111,27



MOCHILA JUVENIL POLIESTER MORMAII 209

Código: Fábrica: Unidade:
45403 MORMAII UN/1
F1 F4

UN: R\$ 102,71 AV: R\$ 102,71 15: R\$ 104,85
30: R\$ 106,95 45: R\$ 109,09 60: R\$ 111,27



MOCHILA JUVENIL POLIESTER MORMAII 210

Código: Fábrica: Unidade:
46793 MORMAII UN/1
F1 F4

UN: R\$ 102,71 AV: R\$ 102,71 15: R\$ 104,85
30: R\$ 106,95 45: R\$ 109,09 60: R\$ 111,27



MOCHILA JUVENIL POLIESTER MORMAII 211

Código: Fábrica: Unidade:
45408 MORMAII UN/1
F1 F4

UN: R\$ 102,71 AV: R\$ 102,71 15: R\$ 104,85
30: R\$ 106,95 45: R\$ 109,09 60: R\$ 111,27



MOCHILA JUVENIL POLIESTER MORMAII 213

Código: Fábrica: Unidade:
45406 MORMAII UN/1
F1 F4

UN: R\$ 102,71 AV: R\$ 102,71 15: R\$ 104,85
30: R\$ 106,95 45: R\$ 109,09 60: R\$ 111,27



MOCHILA JUVENIL POLIESTER MORMAII 214

Código: Fábrica: Unidade:
45409 MORMAII UN/1
F1 F4

UN: R\$ 102,71 AV: R\$ 102,71 15: R\$ 104,85
30: R\$ 106,95 45: R\$ 109,09 60: R\$ 111,27



MOCHILA JUVENIL POLIESTER MORMAII 215

Código: Fábrica: Unidade:
45407 MORMAII UN/1
F1 F4

UN: R\$ 107,85 AV: R\$ 107,85 15: R\$ 110,09
30: R\$ 112,29 45: R\$ 114,54 60: R\$ 116,83



MOCHILA JUVENIL POLIESTER WILSON 514

Código: Fábrica: Unidade:
43688 WILSON UN/1
F1 F4

UN: R\$ 107,85 AV: R\$ 107,85 15: R\$ 110,09
30: R\$ 112,29 45: R\$ 114,54 60: R\$ 116,83



MOCHILA JUVENIL POLIESTER WILSON 515

Código: Fábrica: Unidade:
43687 WILSON UN/1
F1 F4

UN: R\$ 107,85 AV: R\$ 107,85 15: R\$ 110,09
30: R\$ 112,29 45: R\$ 114,54 60: R\$ 116,83



MOCHILA JUVENIL POLIESTER WILSON 520

Código: Fábrica: Unidade:
43692 WILSON UN/1
F1 F4

UN: R\$ 92,44 AV: R\$ 92,44 15: R\$ 94,36
30: R\$ 96,25 45: R\$ 98,18 60: R\$ 100,14



MOCHILA JUVENIL POLIESTER WILSON 521

Código: Fábrica: Unidade:
43673 WILSON UN/1
F1 F4

UN: R\$ 107,85 AV: R\$ 107,85 15: R\$ 110,09
30: R\$ 112,29 45: R\$ 114,54 60: R\$ 116,83



MOCHILA JUVENIL POLIESTER WILSON 524

Código: Fábrica: Unidade:
43691 WILSON UN/1
F1 F4

UN: R\$ 116,06 AV: R\$ 116,06 15: R\$ 118,48
30: R\$ 120,85 45: R\$ 123,27 60: R\$ 125,73



MOCHILA JUVENIL POLIESTER WILSON 529

Código: Fábrica: Unidade:
43686 WILSON UN/1
F1 F4

UN: R\$ 102,71 AV: R\$ 102,71 15: R\$ 104,85
30: R\$ 106,95 45: R\$ 109,09 60: R\$ 111,27



MOCHILA JUVENIL POLIESTER WILSON 530

Código: Fábrica: Unidade:
43678 WILSON UN/1
F1 F4

UN: R\$ 116,06 AV: R\$ 116,06 15: R\$ 118,48
30: R\$ 120,85 45: R\$ 123,27 60: R\$ 125,73



MOCHILA JUVENIL POLIESTER WILSON 533

Código: Fábrica: Unidade:
43675 WILSON UN/1
F1 F4

UN: R\$ 116,06 AV: R\$ 116,06 15: R\$ 118,48
30: R\$ 120,85 45: R\$ 123,27 60: R\$ 125,73



MOCHILA JUVENIL POLIESTER WILSON 536

Código: Fábrica: Unidade:
43676 WILSON UN/1
F1 F4

UN: R\$ 116,06 AV: R\$ 116,06 15: R\$ 118,48
30: R\$ 120,85 45: R\$ 123,27 60: R\$ 125,73



MOCHILA JUVENIL POLIESTER WILSON 537

Código: Fábrica: Unidade:
43674 WILSON UN/1
F1 F4

UN: R\$ 116,06 AV: R\$ 116,06 15: R\$ 118,48
30: R\$ 120,85 45: R\$ 123,27 60: R\$ 125,73



MOCHILA JUVENIL POLIESTER WILSON 544

Código: Fábrica: Unidade:
43684 WILSON UN/1
F1 F4

UN: R\$ 116,06 AV: R\$ 116,06 15: R\$ 118,48
30: R\$ 120,85 45: R\$ 123,27 60: R\$ 125,73



MOCHILA JUVENIL POLIESTER WILSON 545

Código: Fábrica: Unidade:
43670 WILSON UN/1
F1 F4

UN: R\$ 116,06 AV: R\$ 116,06 15: R\$ 118,48
30: R\$ 120,85 45: R\$ 123,27 60: R\$ 125,73



MOCHILA JUVENIL POLIESTER WILSON 546

Código: Fábrica: Unidade:
43704 WILSON UN/1
F1 F4

UN: R\$ 116,06 AV: R\$ 116,06 15: R\$ 118,48
30: R\$ 120,85 45: R\$ 123,27 60: R\$ 125,73



MOCHILA JUVENIL POLIESTER WILSON 548

Código: Fábrica: Unidade:
43690 WILSON UN/1
F1 F4

UN: R\$ 116,06 AV: R\$ 116,06 15: R\$ 118,48
30: R\$ 120,85 45: R\$ 123,27 60: R\$ 125,73



MOCHILA JUVENIL POLIESTER WILSON 550
Código: 43677 Fábrica: WILSON Unidade: UN/1
F1 F4

UN: R\$ 116,06 AV: R\$ 116,06 15: R\$ 118,48
30: R\$ 120,85 45: R\$ 123,27 60: R\$ 125,73



MOCHILA JUVENIL POLIESTER WILSON 554
Código: 43705 Fábrica: WILSON Unidade: UN/1
F1 F4

UN: R\$ 116,06 AV: R\$ 116,06 15: R\$ 118,48
30: R\$ 120,85 45: R\$ 123,27 60: R\$ 125,73



MOCHILA JUVENIL POLIESTER WILSON 558
Código: 43671 Fábrica: WILSON Unidade: UN/1
F1 F4

UN: R\$ 116,06 AV: R\$ 116,06 15: R\$ 118,48
30: R\$ 120,85 45: R\$ 123,27 60: R\$ 125,73



MOCHILA JUVENIL POLIESTER WILSON 560
Código: 43681 Fábrica: WILSON Unidade: UN/1
F1 F4

UN: R\$ 116,06 AV: R\$ 116,06 15: R\$ 118,48
30: R\$ 120,85 45: R\$ 123,27 60: R\$ 125,73



MOCHILA JUVENIL POLIESTER WILSON 563
Código: 43669 Fábrica: WILSON Unidade: UN/1
F1 F4

UN: R\$ 116,06 AV: R\$ 116,06 15: R\$ 118,48
30: R\$ 120,85 45: R\$ 123,27 60: R\$ 125,73



MOCHILA JUVENIL POLIESTER WILSON 619
Código: 43672 Fábrica: WILSON Unidade: UN/1
F1 F4

UN: R\$ 66,76 AV: R\$ 66,76 15: R\$ 68,15
30: R\$ 69,51 45: R\$ 70,90 60: R\$ 72,32



MOCHILA JUVENIL POLIESTER 2333
Código: 44041 Fábrica: RABISK Unidade: UN/1
F1 F4

UN: R\$ 66,76 AV: R\$ 66,76 15: R\$ 68,15
30: R\$ 69,51 45: R\$ 70,90 60: R\$ 72,32



MOCHILA JUVENIL POLIESTER 2334
Código: 44040 Fábrica: RABISK Unidade: UN/1
F1 F4

UN: R\$ 39,99 AV: R\$ 39,99 15: R\$ 39,99
30: R\$ 39,99 45: R\$ 39,99 60: R\$ 39,99



MOCHILA JUVENIL POLIESTER 46310
Código: 43783 Fábrica: ADV Unidade: UN/1
F1 F4

UN: R\$ 92,44 AV: R\$ 92,44 15: R\$ 94,36
30: R\$ 96,25 45: R\$ 98,18 60: R\$ 100,14



MOCHILA JUVENIL PRETA 6201
Código: 19416 Fábrica: FUSECO Unidade: UN/1
F1 F4

UN: R\$ 92,44 AV: R\$ 92,44 15: R\$ 94,36
30: R\$ 96,25 45: R\$ 98,18 60: R\$ 100,14



MOCHILA JUVENIL PRETA 6202
Código: 19417 Fábrica: FUSECO Unidade: UN/1
F1 F4

UN: R\$ 92,44 AV: R\$ 92,44 15: R\$ 94,36
30: R\$ 96,25 45: R\$ 98,18 60: R\$ 100,14



MOCHILA JUVENIL PRETA 6204
Código: 19419 Fábrica: FUSECO Unidade: UN/1
F1 F4

UN: R\$ 92,44 AV: R\$ 92,44 15: R\$ 94,36
30: R\$ 96,25 45: R\$ 98,18 60: R\$ 100,14



MOCHILA JUVENIL PRETA 6205
Código: 19420 Fábrica: FUSECO Unidade: UN/1
F1 F4

UN: R\$ 92,44 AV: R\$ 92,44 15: R\$ 94,36
30: R\$ 96,25 45: R\$ 98,18 60: R\$ 100,14



MOCHILA JUVENIL PRETA 6206
Código: 19421 Fábrica: FUSECO Unidade: UN/1
F1 F4

UN: R\$ 92,44 AV: R\$ 92,44 15: R\$ 94,36
30: R\$ 96,25 45: R\$ 98,18 60: R\$ 100,14



MOCHILA JUVENIL PRETA 6207
Código: 19422 Fábrica: FUSECO Unidade: UN/1
F1 F4

UN: R\$ 92,44 AV: R\$ 92,44 15: R\$ 94,36
30: R\$ 96,25 45: R\$ 98,18 60: R\$ 100,14



MOCHILA JUVENIL PRETA 6208
Código: 19423 Fábrica: FUSECO Unidade: UN/1
F1 F4

UN: R\$ 92,44 AV: R\$ 92,44 15: R\$ 94,36
30: R\$ 96,25 45: R\$ 98,18 60: R\$ 100,14



MOCHILA JUVENIL PRETA 7801

Código: Fábrica: Unidade:
19424 FUSECO UN/1
F1 F4

UN: R\$ 92,44 AV: R\$ 92,44 15: R\$ 94,36
30: R\$ 96,25 45: R\$ 98,18 60: R\$ 100,14



MOCHILA JUVENIL PRETA 7803

Código: Fábrica: Unidade:
19425 FUSECO UN/1
F1 F4

UN: R\$ 92,44 AV: R\$ 92,44 15: R\$ 94,36
30: R\$ 96,25 45: R\$ 98,18 60: R\$ 100,14



MOCHILA JUVENIL PRETA 7808

Código: Fábrica: Unidade:
19426 FUSECO UN/1
F1 F4

UN: R\$ 82,17 AV: R\$ 82,17 15: R\$ 83,88
30: R\$ 85,56 45: R\$ 87,27 60: R\$ 89,01



MOCHILA JUVENIL SBC VKG M4061

Código: Fábrica: Unidade:
38044 SBC UN/1
F1 F4

UN: R\$ 41,08 AV: R\$ 41,08 15: R\$ 41,93
30: R\$ 42,77 45: R\$ 43,63 60: R\$ 44,50



MOCHILA JUVENIL UNI LOVERS M3469

Código: Fábrica: Unidade:
32936 SBC UN/1
F1 F4

UN: R\$ 82,17 AV: R\$ 82,17 15: R\$ 83,88
30: R\$ 85,56 45: R\$ 87,27 60: R\$ 89,01



MOCHILA JUVENIL WOOKEY M3443

Código: Fábrica: Unidade:
38054 WOOKEY UN/1
F1 F4

UN: R\$ 92,44 AV: R\$ 92,44 15: R\$ 94,36
30: R\$ 96,25 45: R\$ 98,18 60: R\$ 100,14



MOCHILA JUVENIL WOOKEY M3447

Código: Fábrica: Unidade:
34196 WOOKEY UN/1
F1 F4

UN: R\$ 102,71 AV: R\$ 102,71 15: R\$ 104,85
30: R\$ 106,95 45: R\$ 109,09 60: R\$ 111,27



MOCHILA JUVENIL WOOKEY M3686

Código: Fábrica: Unidade:
34205 WOOKEY UN/1
F1 F4

UN: R\$ 82,17 AV: R\$ 82,17 15: R\$ 83,88
30: R\$ 85,56 45: R\$ 87,27 60: R\$ 89,01



MOCHILA JUVENIL WOOKEY M3688

Código: Fábrica: Unidade:
34207 WOOKEY UN/1
F1 F4

UN: R\$ 79,99 AV: R\$ 79,99 15: R\$ 79,99
30: R\$ 79,99 45: R\$ 79,99 60: R\$ 79,99



MOCHILA JUVENIL WOOKEY M3965

Código: Fábrica: Unidade:
44055 PONTO VERDE UN/1
F1 F4

UN: R\$ 69,99 AV: R\$ 69,99 15: R\$ 69,99
30: R\$ 69,99 45: R\$ 69,99 60: R\$ 69,99



MOCHILA JUVENIL WOOKEY M3967

Código: Fábrica: Unidade:
46470 WOOKEY UN/1
F1 F4

UN: R\$ 71,89 AV: R\$ 71,89 15: R\$ 73,39
30: R\$ 74,86 45: R\$ 76,36 60: R\$ 77,88



MOCHILA JUVENIL WOOKEY M4058

Código: Fábrica: Unidade:
38043 WOOKEY UN/1
F1 F4

UN: R\$ 92,44 AV: R\$ 92,44 15: R\$ 94,36
30: R\$ 96,25 45: R\$ 98,18 60: R\$ 100,14



MOCHILA JUVENIL WOOKEY 3441

Código: Fábrica: Unidade:
34194 WOOKEY UN/1
F1 F4

UN: R\$ 87,30 AV: R\$ 87,30 15: R\$ 89,12
30: R\$ 90,90 45: R\$ 92,72 60: R\$ 94,58



MOCHILA JUVENIL WOOKEY 3460

Código: Fábrica: Unidade:
34201 WOOKEY UN/1
F1 F4

UN: R\$ 87,30 AV: R\$ 87,30 15: R\$ 89,12
30: R\$ 90,90 45: R\$ 92,72 60: R\$ 94,58



MOCHILA JUVENIL WOOKEY 3461

Código: Fábrica: Unidade:
34203 WOOKEY UN/1
F1 F4

UN: R\$ 87,30 AV: R\$ 87,30 15: R\$ 89,12
30: R\$ 90,90 45: R\$ 92,72 60: R\$ 94,58



MOCHILA JUVENIL WOOKEY 3462

Código: Fábrica: Unidade:
34202 WOOKEY UN/1
F1 F4

UN: R\$ 87,30 AV: R\$ 87,30 15: R\$ 89,12
30: R\$ 90,90 45: R\$ 92,72 60: R\$ 94,58



MOCHILA JUVENIL WOOKEY 3463

Código: Fábrica: Unidade:
34204 WOOKEY UN/1
F1 F4

UN: R\$ 97,57 AV: R\$ 97,57 15: R\$ 99,61
30: R\$ 101,60 45: R\$ 103,63 60: R\$ 105,70



MOCHILA LAP TOP AZX CB ACO PRETA 1476

Código: Fábrica: Unidade:
46734 ROCIE UN/1
F1 F4

UN: R\$ 95,52 AV: R\$ 95,52 15: R\$ 97,51
30: R\$ 99,46 45: R\$ 101,45 60: R\$ 103,48



MOCHILA LAP TOP AZX CB ACO PRETA 1478

Código: Fábrica: Unidade:
46146 ROCIE UN/1
F1 F4

UN: R\$ 81,46 AV: R\$ 81,46 15: R\$ 83,15
30: R\$ 84,82 45: R\$ 86,51 60: R\$ 88,24



MOCHILA LAP TOP AZX PRETA 1520

Código: Fábrica: Unidade:
46145 ROCIE UN/1
F1 F4

UN: R\$ 69,99 AV: R\$ 69,99 15: R\$ 69,99
30: R\$ 69,99 45: R\$ 69,99 60: R\$ 69,99



MOCHILA LONA WOOKEY CB ACO W2021

Código: Fábrica: Unidade:
29360 WOOKEY UN/1
F1 F4

UN: R\$ 41,08 AV: R\$ 41,08 15: R\$ 41,93
30: R\$ 42,77 45: R\$ 43,63 60: R\$ 44,50



MOCHILA LOVELY GIRL TM18 LG-1880

Código: Fábrica: Unidade:
35768 SPEXPRESS UN/1
F1 F4

UN: R\$ 205,43 AV: R\$ 205,43 15: R\$ 209,71
30: R\$ 213,90 45: R\$ 218,18 60: R\$ 222,55



MOCHILA NOTEBOOK BLOONFIELD BF13

Código: Fábrica: Unidade:
26951 BLOONFIELD UN/1
F1 F4

UN: R\$ 174,61 AV: R\$ 174,61 15: R\$ 178,25
30: R\$ 181,82 45: R\$ 185,45 60: R\$ 189,16



MOCHILA NOTEBOOK BLOONFIELD BF50

Código: Fábrica: Unidade:
30538 BLOONFIELD UN/1
F1 F4

UN: R\$ 102,71 AV: R\$ 102,71 15: R\$ 104,85
30: R\$ 106,95 45: R\$ 109,09 60: R\$ 111,27



MOCHILA NOTEBOOK BLOONFIELD CB ACO BF42

Código: Fábrica: Unidade:
29298 BLOONFIELD UN/1
F1 F4

UN: R\$ 95,52 AV: R\$ 95,52 15: R\$ 97,51
30: R\$ 99,46 45: R\$ 101,45 60: R\$ 103,48



MOCHILA NOTEBOOK BLOONFIELD CB ACO BF43

Código: Fábrica: Unidade:
29611 BLOONFIELD UN/1
F1 F4

UN: R\$ 102,71 AV: R\$ 102,71 15: R\$ 104,85
30: R\$ 106,95 45: R\$ 109,09 60: R\$ 111,27



MOCHILA NOTEBOOK BLOONFIELD CB ACO BF44

Código: Fábrica: Unidade:
29614 BLOONFIELD UN/1
F1 F4

UN: R\$ 94,42 AV: R\$ 94,42 15: R\$ 96,39
30: R\$ 98,32 45: R\$ 100,28 60: R\$ 102,29



MOCHILA NOTEBOOK BLOONFIELD CB ACO BF45

Código: Fábrica: Unidade:
29613 BLOONFIELD UN/1
F1 F4

UN: R\$ 112,98 AV: R\$ 112,98 15: R\$ 115,34
30: R\$ 117,64 45: R\$ 120,00 60: R\$ 122,40



MOCHILA NOTEBOOK BLOONFIELD CB ACO BF57

Código: Fábrica: Unidade:
49196 PONTO VERDE UN/1
F1 F4

UN: R\$ 112,98 AV: R\$ 112,98 15: R\$ 115,34
30: R\$ 117,64 45: R\$ 120,00 60: R\$ 122,40



MOCHILA NOTEBOOK BLOONFIELD CB ACO BF58

Código: Fábrica: Unidade:
49197 PONTO VERDE UN/1
F1 F4

UN: R\$ 102,71 AV: R\$ 102,71 15: R\$ 104,85
30: R\$ 106,95 45: R\$ 109,09 60: R\$ 111,27



MOCHILA NOTEBOOK BLOONFIELD CB ACO M4500

Código: Fábrica: Unidade:
46458 BLOONFIELD UN/1
F1 F4

UN: R\$ 124,83 AV: R\$ 124,83 15: R\$ 127,43
30: R\$ 129,97 45: R\$ 132,57 60: R\$ 135,23



MOCHILA NOTEBOOK BLOONFIELD CB ACO M4501

Código: Fábrica: Unidade:
44053 BLOONFIELD UN/1
F1 F4

UN: R\$ 102,71 AV: R\$ 102,71 15: R\$ 104,85
30: R\$ 106,95 45: R\$ 109,09 60: R\$ 111,27



MOCHILA NOTEBOOK BLOONFIELD CB ACO M4502
Código: 44054 Fábrica: BLOONFIELD Unidade: UN/1
F1 F4

UN: R\$ 110,31 AV: R\$ 110,31 15: R\$ 112,61
30: R\$ 114,86 45: R\$ 117,16 60: R\$ 119,50



MOCHILA NOTEBOOK BLOONFIELD CB ACO M4505
Código: 46455 Fábrica: BLOONFIELD Unidade: UN/1
F1 F4

UN: R\$ 102,71 AV: R\$ 102,71 15: R\$ 104,85
30: R\$ 106,95 45: R\$ 109,09 60: R\$ 111,27



MOCHILA NOTEBOOK BLOONFIELD CB ACO M4506
Código: 46456 Fábrica: BLOONFIELD Unidade: UN/1
F1 F4

UN: R\$ 102,71 AV: R\$ 102,71 15: R\$ 104,85
30: R\$ 106,95 45: R\$ 109,09 60: R\$ 111,27



MOCHILA NOTEBOOK BLOONFIELD CB ACO M4507
Código: 46457 Fábrica: BLOONFIELD Unidade: UN/1
F1 F4

UN: R\$ 95,52 AV: R\$ 95,52 15: R\$ 97,51
30: R\$ 99,46 45: R\$ 101,45 60: R\$ 103,48



MOCHILA NOTEBOOK BLOONFIELD CB ACO M5019
Código: 48986 Fábrica: PONTO VERDE Unidade: UN/1
F1 F4

UN: R\$ 94,49 AV: R\$ 94,49 15: R\$ 96,46
30: R\$ 98,39 45: R\$ 100,36 60: R\$ 102,36



MOCHILA NOTEBOOK BLOONFIELD CB ACO M5022
Código: 49069 Fábrica: BLOONFIELD Unidade: UN/1
F1 F4

UN: R\$ 94,49 AV: R\$ 94,49 15: R\$ 96,46
30: R\$ 98,39 45: R\$ 100,36 60: R\$ 102,36



MOCHILA NOTEBOOK BLOONFIELD CB ACO M5023
Código: 49068 Fábrica: BLOONFIELD Unidade: UN/1
F1 F4

UN: R\$ 92,44 AV: R\$ 92,44 15: R\$ 94,36
30: R\$ 96,25 45: R\$ 98,18 60: R\$ 100,14



MOCHILA NOTEBOOK CB ACO 188-83
Código: 45592 Fábrica: KIMTINO Unidade: UN/1
F1 F4

UN: R\$ 92,44 AV: R\$ 92,44 15: R\$ 94,36
30: R\$ 96,25 45: R\$ 98,18 60: R\$ 100,14



MOCHILA NOTEBOOK CB ACO 188-85
Código: 45591 Fábrica: KIMTINO Unidade: UN/1
F1 F4

UN: R\$ 92,44 AV: R\$ 92,44 15: R\$ 94,36
30: R\$ 96,25 45: R\$ 98,18 60: R\$ 100,14



MOCHILA NOTEBOOK CB ACO 188-86
Código: 45610 Fábrica: KIMTINO Unidade: UN/1
F1 F4

UN: R\$ 289,59 AV: R\$ 289,59 15: R\$ 295,63
30: R\$ 301,54 45: R\$ 307,57 60: R\$ 313,72



MOCHILA NOTEBOOK C/CARR BLOONFIELD BF09
Código: 31805 Fábrica: BLOONFIELD Unidade: UN/1
F1 F4

UN: R\$ 289,59 AV: R\$ 289,59 15: R\$ 295,63
30: R\$ 301,54 45: R\$ 307,57 60: R\$ 313,72



MOCHILA NOTEBOOK C/CARR BLOONFIELD BF15
Código: 31806 Fábrica: BLOONFIELD Unidade: UN/1
F1 F4

UN: R\$ 278,01 AV: R\$ 278,01 15: R\$ 283,80
30: R\$ 289,48 45: R\$ 295,27 60: R\$ 301,17



MOCHILA NOTEBOOK C/CARR BLOONFIELD BF16
Código: 32347 Fábrica: BLOONFIELD Unidade: UN/1
F1 F4

UN: R\$ 205,43 AV: R\$ 205,43 15: R\$ 209,71
30: R\$ 213,90 45: R\$ 218,18 60: R\$ 222,55



MOCHILA NOTEBOOK C/CARR BLOONFIELD BF70
Código: 33968 Fábrica: BLOONFIELD Unidade: UN/1
F1 F4

UN: R\$ 190,02 AV: R\$ 190,02 15: R\$ 193,98
30: R\$ 197,86 45: R\$ 201,82 60: R\$ 205,85



MOCHILA NOTEBOOK C/CARR FEM MC4297
Código: 49194 Fábrica: PONTO VERDE Unidade: UN/1
F1 F4

UN: R\$ 190,02 AV: R\$ 190,02 15: R\$ 193,98
30: R\$ 197,86 45: R\$ 201,82 60: R\$ 205,85



MOCHILA NOTEBOOK C/CARR FEM VKG MC4290
Código: 49195 Fábrica: PONTO VERDE Unidade: UN/1
F1 F4

UN: R\$ 289,59 AV: R\$ 289,59 15: R\$ 295,63
30: R\$ 301,54 45: R\$ 307,57 60: R\$ 313,72



MOCHILA NOTEBOOK C/CARR MH BFC75/74

Código: 34312 Fábrica: BLOONFIELD Unidade: UN/1 F1 F4

UN: R\$ 215,71 AV: R\$ 215,71 15: R\$ 220,21
30: R\$ 224,61 45: R\$ 229,10 60: R\$ 233,68



MOCHILA NOTEBOOK C/CARRINHO TM10

Código: 31736 Fábrica: VOZZ Unidade: UN/1 F1 F4

UN: R\$ 289,59 AV: R\$ 289,59 15: R\$ 295,63
30: R\$ 301,54 45: R\$ 307,57 60: R\$ 313,72



MOCHILA NOTEBOOK C/CARRINHO TM11

Código: 31737 Fábrica: VOZZ Unidade: UN/1 F1 F4

UN: R\$ 289,59 AV: R\$ 289,59 15: R\$ 295,63
30: R\$ 301,54 45: R\$ 307,57 60: R\$ 313,72



MOCHILA NOTEBOOK C/CARRINHO TM13

Código: 31739 Fábrica: VOZZ Unidade: UN/1 F1 F4

UN: R\$ 289,59 AV: R\$ 289,59 15: R\$ 295,63
30: R\$ 301,54 45: R\$ 307,57 60: R\$ 313,72



MOCHILA NOTEBOOK C/CARRINHO TM14

Código: 31740 Fábrica: VOZZ Unidade: UN/1 F1 F4

UN: R\$ 289,59 AV: R\$ 289,59 15: R\$ 295,63
30: R\$ 301,54 45: R\$ 307,57 60: R\$ 313,72



MOCHILA NOTEBOOK C/CARRINHO TM15

Código: 31741 Fábrica: VOZZ Unidade: UN/1 F1 F4

UN: R\$ 236,25 AV: R\$ 236,25 15: R\$ 241,17
30: R\$ 245,99 45: R\$ 250,91 60: R\$ 255,93



MOCHILA NOTEBOOK C/CARRINHO TM34

Código: 34309 Fábrica: VOZZ Unidade: UN/1 F1 F4

UN: R\$ 105,79 AV: R\$ 105,79 15: R\$ 108,00
30: R\$ 110,16 45: R\$ 112,36 60: R\$ 114,61



MOCHILA NOTEBOOK INTERLAKEN CB ACO M5002

Código: 49007 Fábrica: PONTO VERDE Unidade: UN/1 F1 F4

UN: R\$ 105,79 AV: R\$ 105,79 15: R\$ 108,00
30: R\$ 110,16 45: R\$ 112,36 60: R\$ 114,61



MOCHILA NOTEBOOK INTERLAKEN CB ACO M5003

Código: 49019 Fábrica: PONTO VERDE Unidade: UN/1 F1 F4

UN: R\$ 105,79 AV: R\$ 105,79 15: R\$ 108,00
30: R\$ 110,16 45: R\$ 112,36 60: R\$ 114,61



MOCHILA NOTEBOOK INTERLAKEN CB ACO M5004

Código: 49009 Fábrica: PONTO VERDE Unidade: UN/1 F1 F4

UN: R\$ 129,99 AV: R\$ 129,99 15: R\$ 129,99
30: R\$ 129,99 45: R\$ 129,99 60: R\$ 129,99

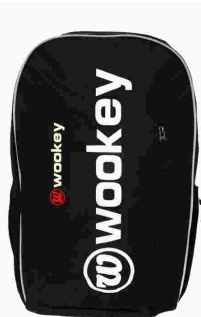

MOCHILA NOTEBOOK WOOKIEY GG W59

Código: 46460 Fábrica: WOOKIEY Unidade: UN/1 F1 F4

UN: R\$ 92,44 AV: R\$ 92,44 15: R\$ 94,36
30: R\$ 96,25 45: R\$ 98,18 60: R\$ 100,14



MOCHILA PAW PATROL M M8492

Código: 37879 Fábrica: XERYUS Unidade: UN/1 F1 F4

UN: R\$ 112,98 AV: R\$ 112,98 15: R\$ 115,34
30: R\$ 117,64 45: R\$ 120,00 60: R\$ 122,40



MOCHILA POLIESTER WILSON 65010031

Código: 37839 Fábrica: WILSON Unidade: UN/1 F1 F4

UN: R\$ 92,44 AV: R\$ 92,44 15: R\$ 94,36
30: R\$ 96,25 45: R\$ 98,18 60: R\$ 100,14



MOCHILA POLIESTER WILSON 65010195

Código: 37836 Fábrica: WILSON Unidade: UN/1 F1 F4

UN: R\$ 92,44 AV: R\$ 92,44 15: R\$ 94,36
30: R\$ 96,25 45: R\$ 98,18 60: R\$ 100,14



MOCHILA POLIESTER WILSON 65010197

Código: 37835 Fábrica: WILSON Unidade: UN/1 F1 F4

UN: R\$ 92,44 AV: R\$ 92,44 15: R\$ 94,36
30: R\$ 96,25 45: R\$ 98,18 60: R\$ 100,14



MOCHILA POLIESTER WILSON 65010207

Código: 37837 Fábrica: WILSON Unidade: UN/1 F1 F4

UN: R\$ 92,44 AV: R\$ 92,44 15: R\$ 94,36
30: R\$ 96,25 45: R\$ 98,18 60: R\$ 100,14



MOCHILA POLIESTER WILSON 65010208
Código: Fábrika: Unidade:
37838 WILSON UN/1
F1 F4

UN: R\$ 28,75 AV: R\$ 28,75 15: R\$ 29,35
30: R\$ 29,94 45: R\$ 30,54 60: R\$ 31,15



MOCHILA SACO 01 BARCELONA 8317
Código: Fábrika: Unidade:
39843 XERYUS UN/1
F1 F4

UN: R\$ 27,72 AV: R\$ 27,72 15: R\$ 28,30
30: R\$ 28,87 45: R\$ 29,45 60: R\$ 30,03



MOCHILA SACO 02 BARCELONA 8318
Código: Fábrika: Unidade:
39844 XERYUS UN/1
F1 F4

UN: R\$ 41,08 AV: R\$ 41,08 15: R\$ 41,93
30: R\$ 42,77 45: R\$ 43,63 60: R\$ 44,50



MOCHILA TM17 LS-1718
Código: Fábrika: Unidade:
35778 SPEXPRESS UN/1
F1 F4

UN: R\$ 82,18 AV: R\$ 82,18 15: R\$ 83,89
30: R\$ 85,57 45: R\$ 87,28 60: R\$ 89,02



MOUSE GAMER X7
Código: Fábrika: Unidade:
36296 INOVA UN/1
F4

UN: R\$ 12,32 AV: R\$ 12,32 15: R\$ 12,57
30: R\$ 12,82 45: R\$ 13,08 60: R\$ 13,34



MOUSE OPTICO SCROLL USB 74300
Código: Fábrika: Unidade:
26801 LETRON UN/1
F1 F4

UN: R\$ 9,86 AV: R\$ 9,86 15: R\$ 10,07
30: R\$ 10,27 45: R\$ 10,48 60: R\$ 10,69



MOUSE PAD C/IMPRESSAO 210X210MM
Código: Fábrika: Unidade:
42741 DELLO UN/1
F1 F4

UN: R\$ 25,67 AV: R\$ 25,67 15: R\$ 26,20
30: R\$ 26,73 45: R\$ 27,26 60: R\$ 27,81



MOUSE PAD ERGONOMICO C/APOIO P/PUNHO
Código: Fábrika: Unidade:
42831 MBTECH UN/1
F1 F4

UN: R\$ 58,35 AV: R\$ 58,35 15: R\$ 59,57
30: R\$ 60,76 45: R\$ 61,97 60: R\$ 63,21

30 cm
80 cm



MOUSE PAD P/JOGOS 800X300X3MM 308
Código: Fábrika: Unidade:
41306 INOVA UN/1
F1 F4

UN: R\$ 9,22 AV: R\$ 9,22 15: R\$ 9,41
30: R\$ 9,60 45: R\$ 9,79 60: R\$ 9,99

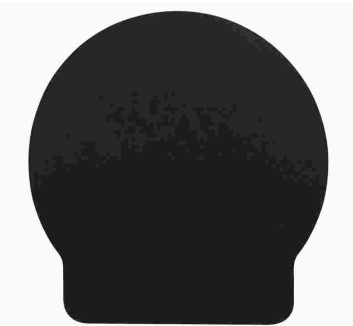

MOUSE PAD PRETO 6553 210X210MM
Código: Fábrika: Unidade:
41807 DELLO UN/1
F1 F4

UN: R\$ 7,98 AV: R\$ 7,98 15: R\$ 8,15
30: R\$ 8,31 45: R\$ 8,48 60: R\$ 8,65



MOUSE PAD SLIM 20X18CM 74412
Código: Fábrika: Unidade:
46346 LETRON PT/1
F1 F4

UN: R\$ 32,86 AV: R\$ 32,86 15: R\$ 33,54
30: R\$ 34,22 45: R\$ 34,90 60: R\$ 35,60



MOUSE S/FIO 8608/8541/8580
Código: Fábrika: Unidade:
27125 INOVA UN/1
F1 F4

UN: R\$ 16,23 AV: R\$ 81,15 15: R\$ 82,84
30: R\$ 84,50 45: R\$ 86,19 60: R\$ 87,91



MOVIMENTO CAIXA 1/4 CD 100 F 154X216 5X1
Código: Fábrika: Unidade:
3381 SAO DOMINGOS PT/5
F1 F4

UN: R\$ 0,97 AV: R\$ 9,75 15: R\$ 9,95
30: R\$ 10,15 45: R\$ 10,35 60: R\$ 10,56

13 cm

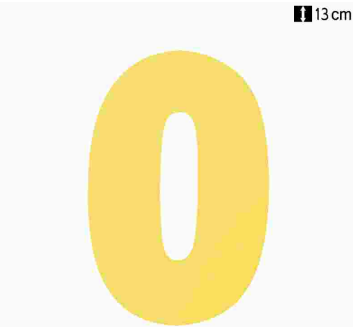

NUMEROS EVA 13CM 0 AMARELO 10X1
Código: Fábrika: Unidade:
38866 BRASILPAPERS PT/10
F1 F4

UN: R\$ 0,97 AV: R\$ 9,75 15: R\$ 9,95
30: R\$ 10,15 45: R\$ 10,35 60: R\$ 10,56

13 cm

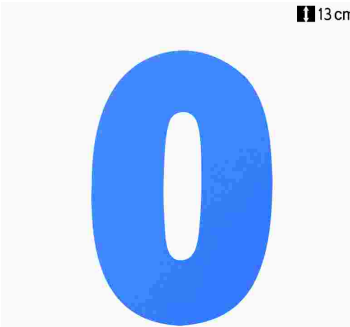

NUMEROS EVA 13CM 0 AZUL 10X1
Código: Fábrika: Unidade:
39054 BRASILPAPERS PT/10
F1 F4

UN: R\$ 0,97 AV: R\$ 9,75 15: R\$ 9,95
30: R\$ 10,15 45: R\$ 10,35 60: R\$ 10,56

13 cm



NUMEROS EVA 13CM 0 BRANCO 10X1
Código: Fábrika: Unidade:
38856 BRASILPAPERS PT/10
F1 F4

UN: R\$ 0,97 AV: R\$ 9,75 15: R\$ 9,95
30: R\$ 10,15 45: R\$ 10,35 60: R\$ 10,56
13 cm

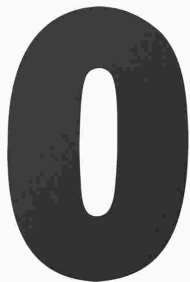

NUMEROS EVA 13CM 0 PRETO 10X1

Código: 39093 Fábrica: BRASILPAPERS Unidade: PT/10 F1 F4

UN: R\$ 0,97 AV: R\$ 9,75 15: R\$ 9,95
30: R\$ 10,15 45: R\$ 10,35 60: R\$ 10,56
13 cm



NUMEROS EVA 13CM 0 ROSA 10X1

Código: 39063 Fábrica: BRASILPAPERS Unidade: PT/10 F1 F4

UN: R\$ 0,97 AV: R\$ 9,75 15: R\$ 9,95
30: R\$ 10,15 45: R\$ 10,35 60: R\$ 10,56
13 cm

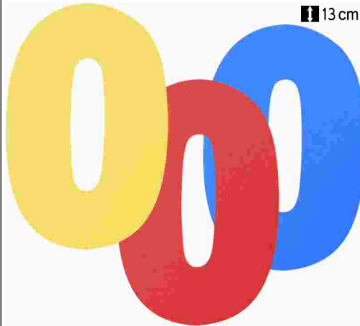

NUMEROS EVA 13CM 0 SORTIDO 10X1

Código: 39103 Fábrica: BRASILPAPERS Unidade: PT/10 F1 F4

UN: R\$ 0,97 AV: R\$ 9,75 15: R\$ 9,95
30: R\$ 10,15 45: R\$ 10,35 60: R\$ 10,56
13 cm



NUMEROS EVA 13CM 0 VERDE 10X1

Código: 39081 Fábrica: BRASILPAPERS Unidade: PT/10 F1 F4

UN: R\$ 0,97 AV: R\$ 9,75 15: R\$ 9,95
30: R\$ 10,15 45: R\$ 10,35 60: R\$ 10,56
13 cm

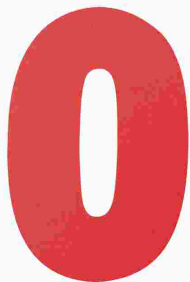

NUMEROS EVA 13CM 0 VERMELHO 10X1

Código: 39073 Fábrica: BRASILPAPERS Unidade: PT/10 F1 F4

UN: R\$ 0,97 AV: R\$ 9,75 15: R\$ 9,95
30: R\$ 10,15 45: R\$ 10,35 60: R\$ 10,56
13 cm



NUMEROS EVA 13CM 1 AMARELO 10X1

Código: 38857 Fábrica: BRASILPAPERS Unidade: PT/10 F1 F4

UN: R\$ 0,97 AV: R\$ 9,75 15: R\$ 9,95
30: R\$ 10,15 45: R\$ 10,35 60: R\$ 10,56
13 cm



NUMEROS EVA 13CM 1 AZUL 10X1

Código: 38868 Fábrica: BRASILPAPERS Unidade: PT/10 F1 F4

UN: R\$ 0,97 AV: R\$ 9,75 15: R\$ 9,95
30: R\$ 10,15 45: R\$ 10,35 60: R\$ 10,56
13 cm



NUMEROS EVA 13CM 1 BRANCO 10X1

Código: 38848 Fábrica: BRASILPAPERS Unidade: PT/10 F1 F4

UN: R\$ 0,97 AV: R\$ 9,75 15: R\$ 9,95
30: R\$ 10,15 45: R\$ 10,35 60: R\$ 10,56
13 cm

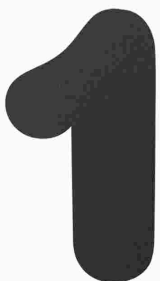

NUMEROS EVA 13CM 1 PRETO 10X1

Código: 39084 Fábrica: BRASILPAPERS Unidade: PT/10 F1 F4

UN: R\$ 0,97 AV: R\$ 9,75 15: R\$ 9,95
30: R\$ 10,15 45: R\$ 10,35 60: R\$ 10,56
13 cm



NUMEROS EVA 13CM 1 ROSA 10X1

Código: 38867 Fábrica: BRASILPAPERS Unidade: PT/10 F1 F4

UN: R\$ 0,97 AV: R\$ 9,75 15: R\$ 9,95
30: R\$ 10,15 45: R\$ 10,35 60: R\$ 10,56
13 cm

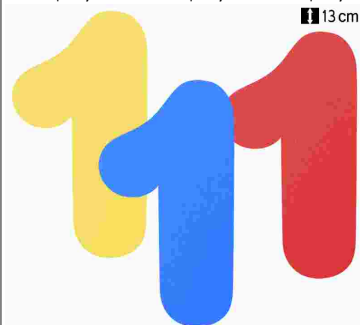

NUMEROS EVA 13CM 1 SORTIDO 10X1

Código: 39094 Fábrica: BRASILPAPERS Unidade: PT/10 F1 F4

UN: R\$ 0,97 AV: R\$ 9,75 15: R\$ 9,95
30: R\$ 10,15 45: R\$ 10,35 60: R\$ 10,56
13 cm



NUMEROS EVA 13CM 1 VERDE 10X1

Código: 39074 Fábrica: BRASILPAPERS Unidade: PT/10 F1 F4

UN: R\$ 0,97 AV: R\$ 9,75 15: R\$ 9,95
30: R\$ 10,15 45: R\$ 10,35 60: R\$ 10,56
13 cm



NUMEROS EVA 13CM 1 VERMELHO 10X1

Código: 39064 Fábrica: BRASILPAPERS Unidade: PT/10 F1 F4

UN: R\$ 0,97 AV: R\$ 9,75 15: R\$ 9,95
30: R\$ 10,15 45: R\$ 10,35 60: R\$ 10,56
13 cm



NUMEROS EVA 13CM 2 AMARELO 10X1

Código: 38858 Fábrica: BRASILPAPERS Unidade: PT/10 F1 F4

UN: R\$ 0,97 AV: R\$ 9,75 15: R\$ 9,95
30: R\$ 10,15 45: R\$ 10,35 60: R\$ 10,56
13 cm



NUMEROS EVA 13CM 2 AZUL 10X1

Código: 38869 Fábrica: BRASILPAPERS Unidade: PT/10 F1 F4

UN: R\$ 0,97 AV: R\$ 9,75 15: R\$ 9,95
30: R\$ 10,15 45: R\$ 10,35 60: R\$ 10,56
13 cm



NUMEROS EVA 13CM 2 BRANCO 10X1

Código: 38849 Fábrica: BRASILPAPERS Unidade: PT/10 F1 F4

UN: R\$ 0,97 AV: R\$ 9,75 15: R\$ 9,95
30: R\$ 10,15 45: R\$ 10,35 60: R\$ 10,56
13 cm



NUMEROS EVA 13CM 2 PRETO 10X1

Código: 39085 Fábrica: BRASILPAPERS Unidade: PT/10 F1 F4

UN: R\$ 0,97 AV: R\$ 9,75 15: R\$ 9,95
30: R\$ 10,15 45: R\$ 10,35 60: R\$ 10,56
13 cm



NUMEROS EVA 13CM 2 ROSA 10X1

Código: 39055 Fábrica: BRASILPAPERS Unidade: PT/10 F1 F4

UN: R\$ 0,97 AV: R\$ 9,75 15: R\$ 9,95
30: R\$ 10,15 45: R\$ 10,35 60: R\$ 10,56
13 cm



NUMEROS EVA 13CM 2 SORTIDO 10X1

Código: 39096 Fábrica: BRASILPAPERS Unidade: PT/10 F1 F4

UN: R\$ 0,97 AV: R\$ 9,75 15: R\$ 9,95
30: R\$ 10,15 45: R\$ 10,35 60: R\$ 10,56
13 cm



NUMEROS EVA 13CM 2 VERDE 10X1

Código: 39075 Fábrica: BRASILPAPERS Unidade: PT/10 F1 F4

UN: R\$ 0,97 AV: R\$ 9,75 15: R\$ 9,95
30: R\$ 10,15 45: R\$ 10,35 60: R\$ 10,56
13 cm



NUMEROS EVA 13CM 3 VERMELHO 10X1

Código: 39065 Fábrica: BRASILPAPERS Unidade: PT/10 F1 F4

UN: R\$ 0,97 AV: R\$ 9,75 15: R\$ 9,95
30: R\$ 10,15 45: R\$ 10,35 60: R\$ 10,56
13 cm



NUMEROS EVA 13CM 3 AMARELO 10X1

Código: 38859 Fábrica: BRASILPAPERS Unidade: PT/10 F1 F4

UN: R\$ 0,97 AV: R\$ 9,75 15: R\$ 9,95
30: R\$ 10,15 45: R\$ 10,35 60: R\$ 10,56
13 cm



NUMEROS EVA 13CM 3 AZUL 10X1

Código: 38870 Fábrica: BRASILPAPERS Unidade: PT/10 F1 F4

UN: R\$ 0,97 AV: R\$ 9,75 15: R\$ 9,95
30: R\$ 10,15 45: R\$ 10,35 60: R\$ 10,56
13 cm



NUMEROS EVA 13CM 3 BRANCO 10X1

Código: 38850 Fábrica: BRASILPAPERS Unidade: PT/10 F1 F4

UN: R\$ 0,97 AV: R\$ 9,75 15: R\$ 9,95
30: R\$ 10,15 45: R\$ 10,35 60: R\$ 10,56
13 cm



NUMEROS EVA 13CM 3 PRETO 10X1

Código: 39086 Fábrica: BRASILPAPERS Unidade: PT/10 F1 F4

UN: R\$ 0,97 AV: R\$ 9,75 15: R\$ 9,95
30: R\$ 10,15 45: R\$ 10,35 60: R\$ 10,56
13 cm



NUMEROS EVA 13CM 3 ROSA 10X1

Código: 39056 Fábrica: BRASILPAPERS Unidade: PT/10 F1 F4

UN: R\$ 0,97 AV: R\$ 9,75 15: R\$ 9,95
30: R\$ 10,15 45: R\$ 10,35 60: R\$ 10,56
13 cm



NUMEROS EVA 13CM 3 SORTIDO 10X1

Código: 39097 Fábrica: BRASILPAPERS Unidade: PT/10 F1 F4

UN: R\$ 0,97 AV: R\$ 9,75 15: R\$ 9,95
30: R\$ 10,15 45: R\$ 10,35 60: R\$ 10,56
13 cm



NUMEROS EVA 13CM 3 VERDE 10X1

Código: 39076 Fábrica: BRASILPAPERS Unidade: PT/10 F1 F4

UN: R\$ 0,97 AV: R\$ 9,75 15: R\$ 9,95
30: R\$ 10,15 45: R\$ 10,35 60: R\$ 10,56
13 cm



NUMEROS EVA 13CM 3 VERMELHO 10X1

Código: 39066 Fábrica: BRASILPAPERS Unidade: PT/10 F1 F4

UN: R\$ 0,97 AV: R\$ 9,75 15: R\$ 9,95
30: R\$ 10,15 45: R\$ 10,35 60: R\$ 10,56
13 cm



NUMEROS EVA 13CM 4 AMARELO 10X1

Código: 38860 Fábrica: BRASILPAPERS Unidade: PT/10 F1 F4

UN: R\$ 0,97 AV: R\$ 9,75 15: R\$ 9,95
30: R\$ 10,15 45: R\$ 10,35 60: R\$ 10,56
13 cm



NUMEROS EVA 13CM 4 AZUL 10X1

Código: 38871 Fábrica: BRASILPAPERS Unidade: PT/10 F1 F4

UN: R\$ 0,97 AV: R\$ 9,75 15: R\$ 9,95
30: R\$ 10,15 45: R\$ 10,35 60: R\$ 10,56
13 cm



NUMEROS EVA 13CM 4 BRANCO 10X1

Código: 38851 Fábrica: BRASILPAPERS Unidade: PT/10 F1 F4

UN: R\$ 0,97 AV: R\$ 9,75 15: R\$ 9,95
30: R\$ 10,15 45: R\$ 10,35 60: R\$ 10,56
13 cm

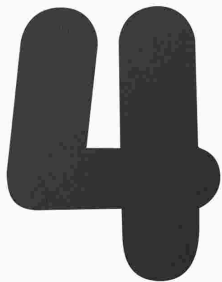

NUMEROS EVA 13CM 4 PRETO 10X1

Código: 39087 Fábrica: BRASILPAPERS Unidade: PT/10 F1 F4

UN: R\$ 0,97 AV: R\$ 9,75 15: R\$ 9,95
30: R\$ 10,15 45: R\$ 10,35 60: R\$ 10,56
13 cm



NUMEROS EVA 13CM 4 ROSA 10X1

Código: 39057 Fábrica: BRASILPAPERS Unidade: PT/10 F1 F4

UN: R\$ 0,97 AV: R\$ 9,75 15: R\$ 9,95
30: R\$ 10,15 45: R\$ 10,35 60: R\$ 10,56
13 cm

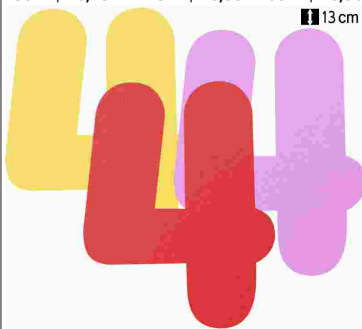

NUMEROS EVA 13CM 4 SORTIDO 10X1

Código: 39095 Fábrica: BRASILPAPERS Unidade: PT/10 F1 F4

UN: R\$ 0,97 AV: R\$ 9,75 15: R\$ 9,95
30: R\$ 10,15 45: R\$ 10,35 60: R\$ 10,56
13 cm



NUMEROS EVA 13CM 4 VERDE 10X1

Código: 39077 Fábrica: BRASILPAPERS Unidade: PT/10 F1 F4

UN: R\$ 0,97 AV: R\$ 9,75 15: R\$ 9,95
30: R\$ 10,15 45: R\$ 10,35 60: R\$ 10,56
13 cm

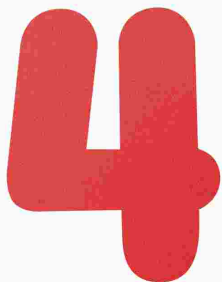

NUMEROS EVA 13CM 4 VERMELHO 10X1

Código: 39067 Fábrica: BRASILPAPERS Unidade: PT/10 F1 F4

UN: R\$ 0,97 AV: R\$ 9,75 15: R\$ 9,95
30: R\$ 10,15 45: R\$ 10,35 60: R\$ 10,56
13 cm



NUMEROS EVA 13CM 5 AMARELO 10X1

Código: 38861 Fábrica: BRASILPAPERS Unidade: PT/10 F1 F4

UN: R\$ 0,97 AV: R\$ 9,75 15: R\$ 9,95
30: R\$ 10,15 45: R\$ 10,35 60: R\$ 10,56
13 cm



NUMEROS EVA 13CM 5 AZUL 10X1

Código: 38872 Fábrica: BRASILPAPERS Unidade: PT/10 F1 F4

UN: R\$ 0,97 AV: R\$ 9,75 15: R\$ 9,95
30: R\$ 10,15 45: R\$ 10,35 60: R\$ 10,56
13 cm



NUMEROS EVA 13CM 5 BRANCO 10X1

Código: 38877 Fábrica: BRASILPAPERS Unidade: PT/10 F1 F4

UN: R\$ 0,97 AV: R\$ 9,75 15: R\$ 9,95
30: R\$ 10,15 45: R\$ 10,35 60: R\$ 10,56
13 cm



NUMEROS EVA 13CM 5 PRETO 10X1

Código: 39088 Fábrica: BRASILPAPERS Unidade: PT/10 F1 F4

UN: R\$ 0,97 AV: R\$ 9,75 15: R\$ 9,95
30: R\$ 10,15 45: R\$ 10,35 60: R\$ 10,56
13 cm



NUMEROS EVA 13CM 5 ROSA 10X1

Código: 39058 Fábrica: BRASILPAPERS Unidade: PT/10 F1 F4

UN: R\$ 0,97 AV: R\$ 9,75 15: R\$ 9,95
30: R\$ 10,15 45: R\$ 10,35 60: R\$ 10,56
13 cm



NUMEROS EVA 13CM 5 SORTIDO 10X1

Código: 39098 Fábrica: BRASILPAPERS Unidade: PT/10 F1 F4

UN: R\$ 0,97 AV: R\$ 9,75 15: R\$ 9,95
30: R\$ 10,15 45: R\$ 10,35 60: R\$ 10,56
13 cm



NUMEROS EVA 13CM 5 VERDE 10X1

Código: 39078 Fábrica: BRASILPAPERS Unidade: PT/10 F1 F4

UN: R\$ 0,97 AV: R\$ 9,75 15: R\$ 9,95
30: R\$ 10,15 45: R\$ 10,35 60: R\$ 10,56
13 cm



NUMEROS EVA 13CM 5 VERMELHO 10X1

Código: 39068 Fábrica: BRASILPAPERS Unidade: PT/10 F1 F4

UN: R\$ 0,97 AV: R\$ 9,75 15: R\$ 9,95
30: R\$ 10,15 45: R\$ 10,35 60: R\$ 10,56
13 cm



NUMEROS EVA 13CM 6 AMARELO 10X1

Código: 38862 Fábrica: BRASILPAPERS Unidade: PT/10 F1 F4

UN: R\$ 0,97 AV: R\$ 9,75 15: R\$ 9,95
30: R\$ 10,15 45: R\$ 10,35 60: R\$ 10,56
13 cm



NUMEROS EVA 13CM 6 AZUL 10X1

Código: 38873 Fábrica: BRASILPAPERS Unidade: PT/10 F1 F4

UN: R\$ 0,97 AV: R\$ 9,75 15: R\$ 9,95
30: R\$ 10,15 45: R\$ 10,35 60: R\$ 10,56
13 cm



NUMEROS EVA 13CM 6 BRANCO 10X1

Código: 38852 Fábrica: BRASILPAPERS Unidade: PT/10 F1 F4

UN: R\$ 0,97 AV: R\$ 9,75 15: R\$ 9,95
30: R\$ 10,15 45: R\$ 10,35 60: R\$ 10,56
13 cm



NUMEROS EVA 13CM 6 PRETO 10X1

Código: 39089 Fábrica: BRASILPAPERS Unidade: PT/10 F1 F4

UN: R\$ 0,97 AV: R\$ 9,75 15: R\$ 9,95
30: R\$ 10,15 45: R\$ 10,35 60: R\$ 10,56
13 cm



NUMEROS EVA 13CM 6 ROSA 10X1

Código: 39059 Fábrica: BRASILPAPERS Unidade: PT/10 F1 F4

UN: R\$ 0,97 AV: R\$ 9,75 15: R\$ 9,95
30: R\$ 10,15 45: R\$ 10,35 60: R\$ 10,56
13 cm

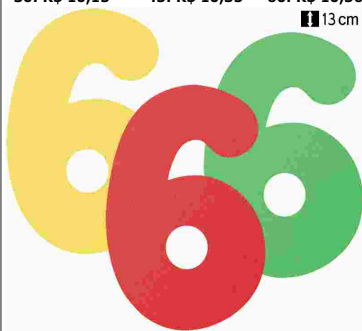

NUMEROS EVA 13CM 6 SORTIDO 10X1

Código: 39099 Fábrica: BRASILPAPERS Unidade: PT/10 F1 F4

UN: R\$ 0,97 AV: R\$ 9,75 15: R\$ 9,95
30: R\$ 10,15 45: R\$ 10,35 60: R\$ 10,56
13 cm



NUMEROS EVA 13CM 6 VERDE 10X1

Código: 39079 Fábrica: BRASILPAPERS Unidade: PT/10 F1 F4

UN: R\$ 0,97 AV: R\$ 9,75 15: R\$ 9,95
30: R\$ 10,15 45: R\$ 10,35 60: R\$ 10,56
13 cm



NUMEROS EVA 13CM 6 VERMELHO 10X1

Código: 39069 Fábrica: BRASILPAPERS Unidade: PT/10 F1 F4

UN: R\$ 0,97 AV: R\$ 9,75 15: R\$ 9,95
30: R\$ 10,15 45: R\$ 10,35 60: R\$ 10,56
13 cm



NUMEROS EVA 13CM 7 AMARELO 10X1

Código: 38863 Fábrica: BRASILPAPERS Unidade: PT/10 F1 F4

UN: R\$ 0,97 AV: R\$ 9,75 15: R\$ 9,95
30: R\$ 10,15 45: R\$ 10,35 60: R\$ 10,56
13 cm



NUMEROS EVA 13CM 7 AZUL 10X1

Código: 38874 Fábrica: BRASILPAPERS Unidade: PT/10 F1 F4

UN: R\$ 0,97 AV: R\$ 9,75 15: R\$ 9,95
30: R\$ 10,15 45: R\$ 10,35 60: R\$ 10,56
13 cm



NUMEROS EVA 13CM 7 BRANCO 10X1

Código: 38853 Fábrica: BRASILPAPERS Unidade: PT/10 F1 F4

UN: R\$ 0,97 AV: R\$ 9,75 15: R\$ 9,95
30: R\$ 10,15 45: R\$ 10,35 60: R\$ 10,56
13 cm



NUMEROS EVA 13CM 7 PRETO 10X1

Código: 39090 Fábrica: BRASILPAPERS Unidade: PT/10 F1 F4

UN: R\$ 0,97 AV: R\$ 9,75 15: R\$ 9,95
30: R\$ 10,15 45: R\$ 10,35 60: R\$ 10,56
13 cm



NUMEROS EVA 13CM 7 ROSA 10X1

Código: 39060 Fábrica: BRASILPAPERS Unidade: PT/10 F1 F4

UN: R\$ 0,97 AV: R\$ 9,75 15: R\$ 9,95
30: R\$ 10,15 45: R\$ 10,35 60: R\$ 10,56
13 cm



NUMEROS EVA 13CM 7 SORTIDO 10X1

Código: 39100 Fábrica: BRASILPAPERS Unidade: PT/10 F1 F4

UN: R\$ 0,97 AV: R\$ 9,75 15: R\$ 9,95
30: R\$ 10,15 45: R\$ 10,35 60: R\$ 10,56
13 cm



NUMEROS EVA 13CM 7 VERDE 10X1

Código: 39080 Fábrica: BRASILPAPERS Unidade: PT/10 F1 F4

UN: R\$ 0,97 AV: R\$ 9,75 15: R\$ 9,95
30: R\$ 10,15 45: R\$ 10,35 60: R\$ 10,56
13 cm



NUMEROS EVA 13CM 7 VERMELHO 10X1

Código: 39070 Fábrica: BRASILPAPERS Unidade: PT/10 F1 F4

UN: R\$ 0,97 AV: R\$ 9,75 15: R\$ 9,95
30: R\$ 10,15 45: R\$ 10,35 60: R\$ 10,56
13 cm



NUMEROS EVA 13CM 8 AMARELO 10X1

Código: 38864 Fábrica: BRASILPAPERS Unidade: PT/10 F1 F4

UN: R\$ 0,97 AV: R\$ 9,75 15: R\$ 9,95
30: R\$ 10,15 45: R\$ 10,35 60: R\$ 10,56
13 cm



NUMEROS EVA 13CM 8 AZUL 10X1

Código: 38875 Fábrica: BRASILPAPERS Unidade: PT/10 F1 F4

UN: R\$ 0,97 AV: R\$ 9,75 15: R\$ 9,95
30: R\$ 10,15 45: R\$ 10,35 60: R\$ 10,56
13 cm



NUMEROS EVA 13CM 8 BRANCO 10X1

Código: 38854 Fábrica: BRASILPAPERS Unidade: PT/10 F1 F4

UN: R\$ 0,97 AV: R\$ 9,75 15: R\$ 9,95
30: R\$ 10,15 45: R\$ 10,35 60: R\$ 10,56
13 cm



NUMEROS EVA 13CM 8 PRETO 10X1

Código: 39091 Fábrica: BRASILPAPERS Unidade: PT/10 F1 F4

UN: R\$ 0,97 AV: R\$ 9,75 15: R\$ 9,95
30: R\$ 10,15 45: R\$ 10,35 60: R\$ 10,56
13 cm



NUMEROS EVA 13CM 8 ROSA 10X1

Código: 39061 Fábrica: BRASILPAPERS Unidade: PT/10 F1 F4

UN: R\$ 0,97 AV: R\$ 9,75 15: R\$ 9,95
30: R\$ 10,15 45: R\$ 10,35 60: R\$ 10,56
13 cm

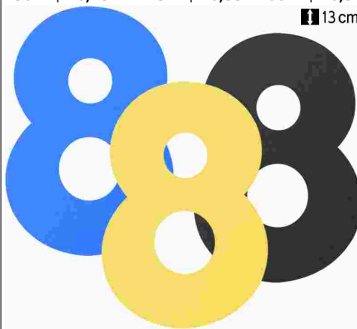

NUMEROS EVA 13CM 8 SORTIDO 10X1

Código: 39101 Fábrica: BRASILPAPERS Unidade: PT/10 F1 F4

UN: R\$ 0,97 AV: R\$ 9,75 15: R\$ 9,95
30: R\$ 10,15 45: R\$ 10,35 60: R\$ 10,56
13 cm



NUMEROS EVA 13CM 8 VERDE 10X1

Código: 39082 Fábrica: BRASILPAPERS Unidade: PT/10 F1 F4

UN: R\$ 0,97 AV: R\$ 9,75 15: R\$ 9,95
30: R\$ 10,15 45: R\$ 10,35 60: R\$ 10,56
13 cm



NUMEROS EVA 13CM 8 VERMELHO 10X1

Código: 39071 Fábrica: BRASILPAPERS Unidade: PT/10 F1 F4

UN: R\$ 0,97 AV: R\$ 9,75 15: R\$ 9,95
30: R\$ 10,15 45: R\$ 10,35 60: R\$ 10,56
13 cm



NUMEROS EVA 13CM 9 AMARELO 10X1

Código: 38865 Fábrica: BRASILPAPERS Unidade: PT/10 F1 F4

UN: R\$ 0,97 AV: R\$ 9,75 15: R\$ 9,95
30: R\$ 10,15 45: R\$ 10,35 60: R\$ 10,56
13 cm



NUMEROS EVA 13CM 9 AZUL 10X1

Código: 38876 Fábrica: BRASILPAPERS Unidade: PT/10 F1 F4

UN: R\$ 0,97 AV: R\$ 9,75 15: R\$ 9,95
30: R\$ 10,15 45: R\$ 10,35 60: R\$ 10,56
13 cm



NUMEROS EVA 13CM 9 BRANCO 10X1

Código: 38855 Fábrica: BRASILPAPERS Unidade: PT/10 F1 F4

UN: R\$ 0,97 AV: R\$ 9,75 15: R\$ 9,95
30: R\$ 10,15 45: R\$ 10,35 60: R\$ 10,56
13 cm



NUMEROS EVA 13CM 9 PRETO 10X1

Código: 39092 Fábrica: BRASILPAPERS Unidade: PT/10 F1 F4

UN: R\$ 0,97 AV: R\$ 9,75 15: R\$ 9,95
30: R\$ 10,15 45: R\$ 10,35 60: R\$ 10,56
13 cm



NUMEROS EVA 13CM 9 ROSA 10X1

Código: 39062 Fábrica: BRASILPAPERS Unidade: PT/10 F1 F4

UN: R\$ 0,97 AV: R\$ 9,75 15: R\$ 9,95
30: R\$ 10,15 45: R\$ 10,35 60: R\$ 10,56
13 cm



NUMEROS EVA 13CM 9 SORTIDO 10X1

Código: 39102 Fábrica: BRASILPAPERS Unidade: PT/10 F1 F4

UN: R\$ 0,97 AV: R\$ 9,75 15: R\$ 9,95
30: R\$ 10,15 45: R\$ 10,35 60: R\$ 10,56
13 cm



NUMEROS EVA 13CM 9 VERDE 10X1

Código: 39083 Fábrica: BRASILPAPERS Unidade: PT/10 F1 F4

UN: R\$ 0,97 AV: R\$ 9,75 15: R\$ 9,95
30: R\$ 10,15 45: R\$ 10,35 60: R\$ 10,56
13 cm



NUMEROS EVA 13CM 9 VERMELHO 10X1

Código: 39072 Fábrica: BRASILPAPERS Unidade: PT/10 F1 F4

UN: R\$ 30,81 AV: R\$ 30,81 15: R\$ 31,45
30: R\$ 32,08 45: R\$ 32,72 60: R\$ 33,37



ORGANIZADOR DIAGONAL BLACK PIANO SELADO

Código: 47594 Fábrica: MAXCRIL Unidade: UN/1 F1 F4

UN: R\$ 30,81 AV: R\$ 30,81 15: R\$ 31,45
30: R\$ 32,08 45: R\$ 32,72 60: R\$ 33,37



ORGANIZADOR DIAGONAL CINZA SELADO

Código: 47593 Fábrica: MAXCRIL Unidade: UN/1 F1 F4

UN: R\$ 30,81 AV: R\$ 30,81 15: R\$ 31,45
30: R\$ 32,08 45: R\$ 32,72 60: R\$ 33,37

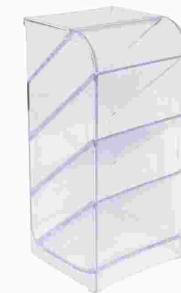

ORGANIZADOR DIAGONAL CRISTAL SELADO

Código: 47173 Fábrica: MAXCRIL Unidade: UN/1 F1 F4

UN: R\$ 97,57 AV: R\$ 97,57 15: R\$ 99,61
30: R\$ 101,60 45: R\$ 103,63 60: R\$ 105,70

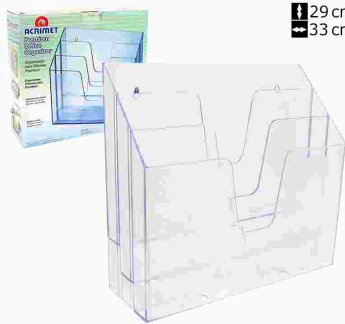

ORGANIZADOR ESCRITORIO CRISTAL 869CR
Código: Fábrika: Unidade:
40806 ACRIMET CX/1
F1 F4

UN: R\$ 33,66 AV: R\$ 33,66 15: R\$ 34,36
30: R\$ 35,05 45: R\$ 35,75 60: R\$ 36,46



ORGANIZADOR MESA ACR PTO PORTA FITA 681
Código: Fábrika: Unidade:
43220 ACRINIL UN/1
F1 F4

UN: R\$ 38,00 AV: R\$ 38,00 15: R\$ 38,79
30: R\$ 39,56 45: R\$ 40,35 60: R\$ 41,16



ORGANIZADOR MESA ARAMADO 3COMP QUAD 5122
Código: Fábrika: Unidade:
44985 BRW UN/1
F1 F4

UN: R\$ 12,58 AV: R\$ 12,58 15: R\$ 12,85
30: R\$ 13,10 45: R\$ 13,36 60: R\$ 13,63



ORGANIZADOR OBJETO MOD 8,5X8,5CM CRISTAL
Código: Fábrika: Unidade:
44682 MAXCRIL UN/1
F1 F4

UN: R\$ 0,92 AV: R\$ 22,89 15: R\$ 23,36
30: R\$ 23,83 45: R\$ 24,31 60: R\$ 24,79



PALITO DENTE EMB IND 25X80
Código: Fábrika: Unidade:
49697 ESTILO PT/25
F1 F4

UN: R\$ 0,01 AV: R\$ 29,78 15: R\$ 30,40
30: R\$ 31,01 45: R\$ 31,63 60: R\$ 32,26



PALITO DENTE EMB INDIVIDUAL 2000X1
Código: Fábrika: Unidade:
48618 BOMPACK CX/2000
F1 F4

UN: R\$ 0,09 AV: R\$ 8,72 15: R\$ 8,90
30: R\$ 9,08 45: R\$ 9,26 60: R\$ 9,45



PALITO P/PICOLE COLORIDO AMARELO 100X1
Código: Fábrika: Unidade:
39169 COPLAMIX PT/100
F1 F4

UN: R\$ 0,09 AV: R\$ 8,72 15: R\$ 8,90
30: R\$ 9,08 45: R\$ 9,26 60: R\$ 9,45



PALITO P/PICOLE COLORIDO AZUL 100X1
Código: Fábrika: Unidade:
39168 COPLAMIX PT/100
F1 F4

UN: R\$ 0,09 AV: R\$ 8,72 15: R\$ 8,90
30: R\$ 9,08 45: R\$ 9,26 60: R\$ 9,45



PALITO P/PICOLE COLORIDO VERDE 100X1
Código: Fábrika: Unidade:
39170 COPLAMIX PT/100
F1 F4

UN: R\$ 0,09 AV: R\$ 8,72 15: R\$ 8,90
30: R\$ 9,08 45: R\$ 9,26 60: R\$ 9,45



PALITO P/PICOLE COLORIDO VERMELHO 100X1
Código: Fábrika: Unidade:
39171 COPLAMIX PT/100
F1 F4

UN: R\$ 0,04 AV: R\$ 4,10 15: R\$ 4,18
30: R\$ 4,27 45: R\$ 4,35 60: R\$ 4,44



PALITO P/PICOLE QUAD 51070 100X1
Código: Fábrika: Unidade:
27864 THEOTO PT/100
F1 F4

UN: R\$ 342,06 AV: R\$ 342,06 15: R\$ 349,18
30: R\$ 356,17 45: R\$ 363,29 60: R\$ 370,56



PALITO P/PICOLE QUAD 51070 10000X1
Código: Fábrika: Unidade:
41176 THEOTO CX/1
F1 F4

UN: R\$ 0,06 AV: R\$ 5,78 15: R\$ 5,90
30: R\$ 6,02 45: R\$ 6,14 60: R\$ 6,26



PALITO P/PICOLE QUADR 100X1
Código: Fábrika: Unidade:
49695 ESTILO PT/100
F1 F4

UN: R\$ 0,11 AV: R\$ 11,29 15: R\$ 11,52
30: R\$ 11,75 45: R\$ 11,99 60: R\$ 12,23



PALITO P/PICOLE RED COLORIDO SORT 100X1
Código: Fábrika: Unidade:
30261 THEOTO PT/100
F1 F4

UN: R\$ 435,49 AV: R\$ 435,49 15: R\$ 444,56
30: R\$ 453,46 45: R\$ 462,52 60: R\$ 471,78



PALITO P/PICOLE RED 10000X1
Código: Fábrika: Unidade:
49696 ESTILO CX/1
F1 F4

UN: R\$ 0,06 AV: R\$ 6,15 15: R\$ 6,28
30: R\$ 6,41 45: R\$ 6,53 60: R\$ 6,67



PALITO P/PICOLE RED 51021 100X1
Código: Fábrika: Unidade:
41144 THEOTO PT/100
F1 F4

UN: R\$ 513,50 AV: R\$ 513,50 15: R\$ 524,20
30: R\$ 534,68 45: R\$ 545,37 60: R\$ 556,28



PALITO P/PICOLE RED 51021 10000X1

Código: Fábrica: Unidade:
41177 THEOTO CX/1
F1 F4

UN: R\$ 0,05 AV: R\$ 51,35 15: R\$ 52,42
30: R\$ 53,47 45: R\$ 54,54 60: R\$ 55,63



PALITO P/PICOLE 1000X1

Código: Fábrica: Unidade:
20231 PINHEIRO PT/1000
F1 F4

UN: R\$ 0,07 AV: R\$ 7,18 15: R\$ 7,33
30: R\$ 7,48 45: R\$ 7,63 60: R\$ 7,78



PALITO P/SORVETE 100X1

Código: Fábrica: Unidade:
42269 ESTILO PT/100
F1 F4

UN: R\$ 0,11 AV: R\$ 10,94 15: R\$ 11,17
30: R\$ 11,39 45: R\$ 11,62 60: R\$ 11,85



PALITO RED ABAIXADOR LINGUA 100X1

Código: Fábrica: Unidade:
47881 THEOTO PT/100
F1 F4

UN: R\$ 0,20 AV: R\$ 10,17 15: R\$ 10,38
30: R\$ 10,59 45: R\$ 10,80 60: R\$ 11,02



PANFLETO ALUGA-SE 50X1

Código: Fábrica: Unidade:
11440 QDAL PT/50
F1 F4

UN: R\$ 0,20 AV: R\$ 10,17 15: R\$ 10,38
30: R\$ 10,59 45: R\$ 10,80 60: R\$ 11,02



PANFLETO EXTINTOR DE INCENDIO 50X1

Código: Fábrica: Unidade:
33344 QDAL PT/50
F4

UN: R\$ 0,20 AV: R\$ 10,17 15: R\$ 10,38
30: R\$ 10,59 45: R\$ 10,80 60: R\$ 11,02



PANFLETO NAO VENDEMOS FIADO 50X1

Código: Fábrica: Unidade:
31063 QDAL PT/50
F4

UN: R\$ 0,20 AV: R\$ 10,17 15: R\$ 10,38
30: R\$ 10,59 45: R\$ 10,80 60: R\$ 11,02



PANFLETO USO OGRIGATORIO DE MASCARA 50X1

Código: Fábrica: Unidade:
38996 QDAL PT/50
F4

UN: R\$ 0,20 AV: R\$ 10,17 15: R\$ 10,38
30: R\$ 10,59 45: R\$ 10,80 60: R\$ 11,02



PANFLETO VENDE-SE 50X1

Código: Fábrica: Unidade:
11439 QDAL PT/50
F1 F4

UN: R\$ 3,49 AV: R\$ 34,91 15: R\$ 35,64
30: R\$ 36,35 45: R\$ 37,08 60: R\$ 37,82

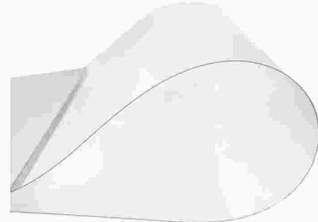

PAPEL ACETATO A3 TRANSP 10UN

Código: Fábrica: Unidade:
50169 MP PT/10
F1 F4

UN: R\$ 0,14 AV: R\$ 13,94 15: R\$ 14,23
30: R\$ 14,51 45: R\$ 14,80 60: R\$ 15,10



PAPEL ALMACO C/ PAUTA 100X1

Código: Fábrica: Unidade:
36680 MAXIMA PT/100
F1 F4

UN: R\$ 0,12 AV: R\$ 48,83 15: R\$ 49,84
30: R\$ 50,84 45: R\$ 51,86 60: R\$ 52,89

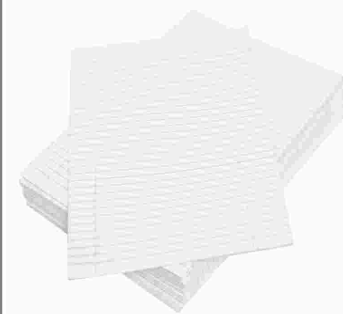

PAPEL ALMACO C/ PAUTA 400X1

Código: Fábrica: Unidade:
6427 MAXIMA/PGBRA PT/400
F1 F4

UN: R\$ 0,14 AV: R\$ 13,94 15: R\$ 14,23
30: R\$ 14,51 45: R\$ 14,80 60: R\$ 15,10



PAPEL ALMACO S/ PAUTA 100X1

Código: Fábrica: Unidade:
20378 MAXIMA PT/100
F1 F4

UN: R\$ 0,12 AV: R\$ 48,83 15: R\$ 49,84
30: R\$ 50,84 45: R\$ 51,86 60: R\$ 52,89

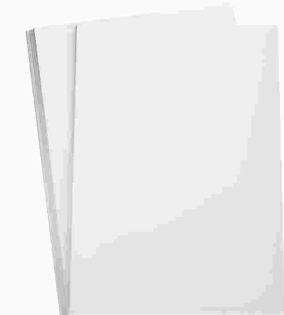

PAPEL ALMACO S/ PAUTA 400X1

Código: Fábrica: Unidade:
36679 MAXIMA/PGBRA PT/400
F1 F4

UN: R\$ 0,37 AV: R\$ 18,48 15: R\$ 18,86
30: R\$ 19,24 45: R\$ 19,63 60: R\$ 20,02



PAPEL ANTILOPE A4 180GR BRANCO 50X1

Código: Fábrica: Unidade:
45587 BRATA/OFFPAP PT/50
F1 F4

UN: R\$ 1,03 AV: R\$ 51,35 15: R\$ 52,42
30: R\$ 53,47 45: R\$ 54,54 60: R\$ 55,63

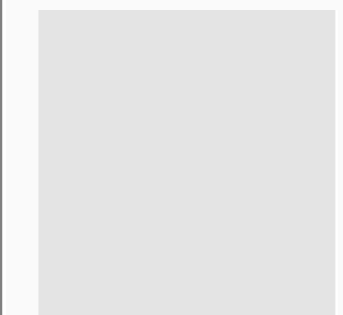

PAPEL A3 60 KG 180 GRS BRANCO 50X1

Código: Fábrica: Unidade:
37046 MINASPEL PT/50
F1 F4

UN: R\$ 0,16 AV: R\$ 16,42 15: R\$ 16,77
30: R\$ 17,10 45: R\$ 17,44 60: R\$ 17,79

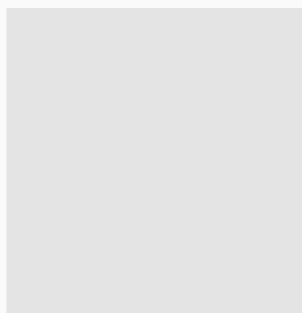

PAPEL A3 75GRS BRANCO 100X1

Código: 37074 Fábrica: MILPEL/MINAS Unidade: PT/100 F1 F4

UN: R\$ 82,17 AV: R\$ 82,17 15: R\$ 83,88
30: R\$ 85,56 45: R\$ 87,27 60: R\$ 89,01

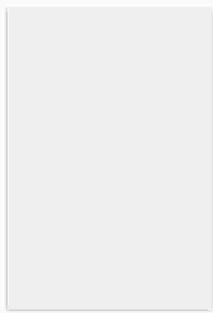

PAPEL A3 75GRS BRANCO 500X1

Código: 46994 Fábrica: MILPEL Unidade: PT/1 F1 F4

UN: R\$ 9,75 AV: R\$ 9,75 15: R\$ 9,95
30: R\$ 10,15 45: R\$ 10,35 60: R\$ 10,56



PAPEL A4 70GR CREME 210X297MM 100X1

Código: 42918 Fábrica: NEEDS Unidade: PT/1 F1 F4

UN: R\$ 9,75 AV: R\$ 9,75 15: R\$ 9,95
30: R\$ 10,15 45: R\$ 10,35 60: R\$ 10,56



PAPEL A4 75GR AMARELO 210X297MM 100X1

Código: 9506 Fábrica: MILPEL Unidade: PT/1 F1 F4

UN: R\$ 9,75 AV: R\$ 9,75 15: R\$ 9,95
30: R\$ 10,15 45: R\$ 10,35 60: R\$ 10,56

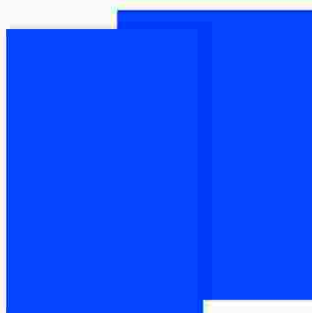

PAPEL A4 75GR AZUL 210X297MM 100X1

Código: 9505 Fábrica: MILPEL Unidade: PT/1 F1 F4

UN: R\$ 0,10 AV: R\$ 9,75 15: R\$ 9,95
30: R\$ 10,15 45: R\$ 10,35 60: R\$ 10,56

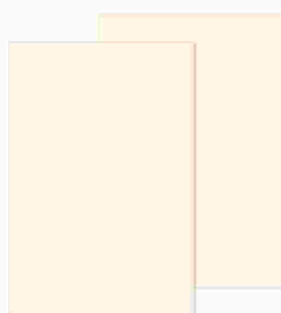

PAPEL A4 75GR CREME 210X297MM 100X1

Código: 46409 Fábrica: MINASPEL Unidade: PT/100 F1 F4

UN: R\$ 0,10 AV: R\$ 9,75 15: R\$ 9,95
30: R\$ 10,15 45: R\$ 10,35 60: R\$ 10,56



PAPEL A4 75GR LARANJA 210X297MM 100X1

Código: 46262 Fábrica: MINASPEL Unidade: PT/100 F1 F4

UN: R\$ 9,75 AV: R\$ 9,75 15: R\$ 9,95
30: R\$ 10,15 45: R\$ 10,35 60: R\$ 10,56



PAPEL A4 75GR ROSA 210X297MM 100X1

Código: 9507 Fábrica: MILPEL Unidade: PT/1 F1 F4

UN: R\$ 9,75 AV: R\$ 9,75 15: R\$ 9,95
30: R\$ 10,15 45: R\$ 10,35 60: R\$ 10,56



PAPEL A4 75GR VERDE 210X297MM 100X1

Código: 9508 Fábrica: MILPEL Unidade: PT/1 F1 F4

UN: R\$ 0,07 AV: R\$ 33,97 15: R\$ 33,97
30: R\$ 33,97 45: R\$ 33,97 60: R\$ 33,97



PAPEL A4 BCO 210X297MM 500 FLS

Código: 22253 Fábrica: PAPEX Unidade: PT/500 F1 F4

UN: R\$ 0,32 AV: R\$ 15,40 15: R\$ 15,72
30: R\$ 16,03 45: R\$ 16,35 60: R\$ 16,68

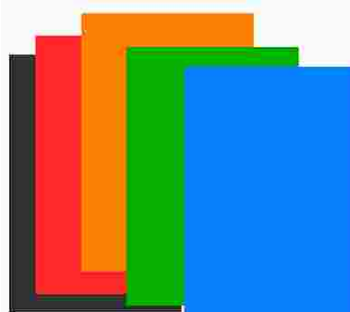

PAPEL A4 CREATIVE PAPER 48X1

Código: 7335 Fábrica: MINASPEL Unidade: PT/48 F1 F4

UN: R\$ 0,15 AV: R\$ 6,15 15: R\$ 6,28
30: R\$ 6,41 45: R\$ 6,53 60: R\$ 6,67



PAPEL A4 CRIATIVO COLOR 40X1

Código: 47716 Fábrica: REIPEL Unidade: PT/40 F1 F4

UN: R\$ 0,26 AV: R\$ 12,83 15: R\$ 13,10
30: R\$ 13,36 45: R\$ 13,63 60: R\$ 13,90

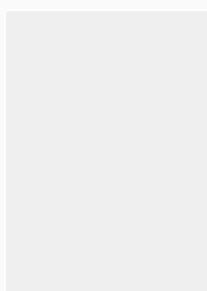

PAPEL A4 120GR 40KG BRANCO 484 50X1

Código: 34269 Fábrica: AGAPE Unidade: PT/50 F1 F4

UN: R\$ 0,39 AV: R\$ 19,51 15: R\$ 19,91
30: R\$ 20,31 45: R\$ 20,72 60: R\$ 21,13



PAPEL A4 160GR COUCHE SEMI BRILHO 50X1

Código: 45992 Fábrica: MASTERPRINT Unidade: PT/50 F1 F4

UN: R\$ 0,51 AV: R\$ 25,67 15: R\$ 26,20
30: R\$ 26,73 45: R\$ 27,26 60: R\$ 27,81



PAPEL A4 180GR MADEIRA BRANCO 50X1

Código: 45588 Fábrica: OFF PAPER Unidade: PT/50 F1 F4

UN: R\$ 0,55 AV: R\$ 27,72 15: R\$ 28,30
30: R\$ 28,87 45: R\$ 29,45 60: R\$ 30,03



PAPEL A4 180GR MADEIRA PALHA 50X1

Código: 45887 Fábrica: OFF PAPER Unidade: PT/50 F1 F4

UN: R\$ 0,37 AV: R\$ 18,48 15: R\$ 18,86
30: R\$ 19,24 45: R\$ 19,63 60: R\$ 20,02



PAPEL A4 180GR PERSICO BRANCO 50X1
Código: Fábrica: Unidade:
46046 USAPEL PT/50
F1 F4

UN: R\$ 0,35 AV: R\$ 17,45 15: R\$ 17,82
30: R\$ 18,17 45: R\$ 18,54 60: R\$ 18,91

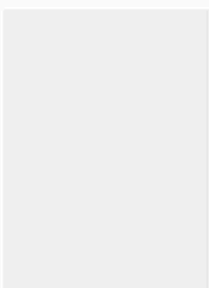

PAPEL A4 180GR 60KG BRANCO 486 50X1
Código: Fábrica: Unidade:
30962 MINAS/MILPEL PT/50
F1 F4

UN: R\$ 0,20 AV: R\$ 19,51 15: R\$ 19,91
30: R\$ 20,31 45: R\$ 20,72 60: R\$ 21,13



PAPEL A4 200GR COUCHE FOSCO 100X1
Código: Fábrica: Unidade:
49064 MASTERPRINT PT/100
F1 F4

UN: R\$ 0,49 AV: R\$ 24,29 15: R\$ 24,80
30: R\$ 25,30 45: R\$ 25,80 60: R\$ 26,32



PAPEL A4 200GR COUCHE IMP LASER 96 50X1
Código: Fábrica: Unidade:
51061 MASTERPRINT PT/50
F1 F4

UN: R\$ 10,79 AV: R\$ 10,79 15: R\$ 11,01
30: R\$ 11,23 45: R\$ 11,46 60: R\$ 11,68



PAPEL A4 75GR 8 CORES 210X297MM 45X1
Código: Fábrica: Unidade:
49278 MASTERPRINT PT/1
F1 F4

UN: R\$ 1,53 AV: R\$ 38,26 15: R\$ 39,06
30: R\$ 39,84 45: R\$ 40,64 60: R\$ 41,45



PAPEL CAMURCA AMARELO 40X60CM 25X1
Código: Fábrica: Unidade:
6332 ART FLOC PT/25
F1 F4

UN: R\$ 1,53 AV: R\$ 38,26 15: R\$ 39,06
30: R\$ 39,84 45: R\$ 40,64 60: R\$ 41,45



PAPEL CAMURCA AZUL CELESTE 40X60CM 25X1
Código: Fábrica: Unidade:
24958 ART FLOC PT/25
F1 F4

UN: R\$ 1,53 AV: R\$ 38,26 15: R\$ 39,06
30: R\$ 39,84 45: R\$ 40,64 60: R\$ 41,45



PAPEL CAMURCA AZUL CLARO 40X60CM 25X1
Código: Fábrica: Unidade:
6327 ART FLOC PT/25
F1 F4

UN: R\$ 1,53 AV: R\$ 38,26 15: R\$ 39,06
30: R\$ 39,84 45: R\$ 40,64 60: R\$ 41,45



PAPEL CAMURCA AZUL MARINHO 40X60CM 25X1
Código: Fábrica: Unidade:
6345 ART FLOC PT/25
F1 F4

UN: R\$ 1,53 AV: R\$ 38,26 15: R\$ 39,06
30: R\$ 39,84 45: R\$ 40,64 60: R\$ 41,45



PAPEL CAMURCA AZUL ROYAL 40X60CM 25X1
Código: Fábrica: Unidade:
6331 ART FLOC PT/25
F1 F4

UN: R\$ 1,53 AV: R\$ 38,26 15: R\$ 39,06
30: R\$ 39,84 45: R\$ 40,64 60: R\$ 41,45



PAPEL CAMURCA AZUL TURQUESA 40X60CM 25X1
Código: Fábrica: Unidade:
19804 ART FLOC PT/25
F1 F4

UN: R\$ 1,53 AV: R\$ 38,26 15: R\$ 39,06
30: R\$ 39,84 45: R\$ 40,64 60: R\$ 41,45

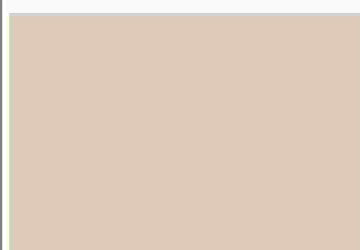

PAPEL CAMURCA BEGE 40X60CM 25X1
Código: Fábrica: Unidade:
35865 ART FLOC PT/25
F1 F4

UN: R\$ 1,53 AV: R\$ 38,26 15: R\$ 39,06
30: R\$ 39,84 45: R\$ 40,64 60: R\$ 41,45



PAPEL CAMURCA BRANCO 40X60CM 25X1
Código: Fábrica: Unidade:
4052 ART FLOC PT/25
F1 F4

UN: R\$ 1,53 AV: R\$ 38,26 15: R\$ 39,06
30: R\$ 39,84 45: R\$ 40,64 60: R\$ 41,45



PAPEL CAMURCA CINZA 40X60CM 25X1
Código: Fábrica: Unidade:
26221 ART FLOC PT/25
F1 F4

UN: R\$ 1,53 AV: R\$ 38,26 15: R\$ 39,06
30: R\$ 39,84 45: R\$ 40,64 60: R\$ 41,45



PAPEL CAMURCA GRAFITE 40X60CM 25X1
Código: Fábrica: Unidade:
16444 ART FLOC PT/25
F1 F4

UN: R\$ 1,53 AV: R\$ 38,26 15: R\$ 39,06
30: R\$ 39,84 45: R\$ 40,64 60: R\$ 41,45

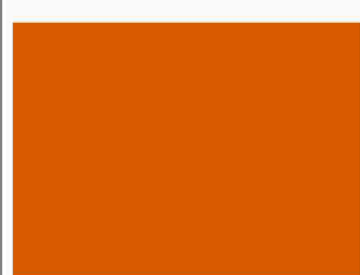

PAPEL CAMURCA LARANJA 40X60CM 25X1
Código: Fábrica: Unidade:
15594 ART FLOC PT/25
F1 F4

UN: R\$ 1,53 AV: R\$ 38,26 15: R\$ 39,06
30: R\$ 39,84 45: R\$ 40,64 60: R\$ 41,45



PAPEL CAMURCA LILAS 40X60 25X1

Código: Fábrica: Unidade:
35863 ART FLOC PT/25
F1 F4

UN: R\$ 1,53 AV: R\$ 38,26 15: R\$ 39,06
30: R\$ 39,84 45: R\$ 40,64 60: R\$ 41,45



PAPEL CAMURCA MARROM 40X60CM 25X1

Código: Fábrica: Unidade:
16445 ART FLOC PT/25
F1 F4

UN: R\$ 1,53 AV: R\$ 38,26 15: R\$ 39,06
30: R\$ 39,84 45: R\$ 40,64 60: R\$ 41,45



PAPEL CAMURCA PINK 40X60CM 25X1

Código: Fábrica: Unidade:
16446 ART FLOC PT/25
F1 F4

UN: R\$ 1,53 AV: R\$ 38,26 15: R\$ 39,06
30: R\$ 39,84 45: R\$ 40,64 60: R\$ 41,45



PAPEL CAMURCA PRETO 40X60CM 25X1

Código: Fábrica: Unidade:
6333 ART FLOC PT/25
F1 F4

UN: R\$ 1,53 AV: R\$ 38,26 15: R\$ 39,06
30: R\$ 39,84 45: R\$ 40,64 60: R\$ 41,45



PAPEL CAMURCA ROSA 40X60CM 25X1

Código: Fábrica: Unidade:
15596 ART FLOC PT/25
F1 F4

UN: R\$ 1,53 AV: R\$ 38,26 15: R\$ 39,06
30: R\$ 39,84 45: R\$ 40,64 60: R\$ 41,45

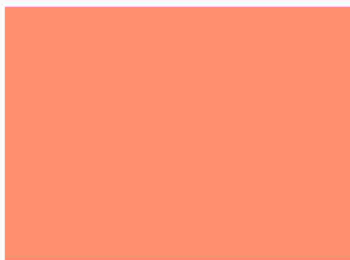

PAPEL CAMURCA SALMAO 40X60CM 25X1

Código: Fábrica: Unidade:
6334 ART FLOC PT/25
F1 F4

UN: R\$ 1,53 AV: R\$ 38,26 15: R\$ 39,06
30: R\$ 39,84 45: R\$ 40,64 60: R\$ 41,45



PAPEL CAMURCA VERDE BANDEIR 40X60CM 25X1

Código: Fábrica: Unidade:
6326 ART FLOC PT/25
F1 F4

UN: R\$ 1,53 AV: R\$ 38,26 15: R\$ 39,06
30: R\$ 39,84 45: R\$ 40,64 60: R\$ 41,45



PAPEL CAMURCA VERDE MUSGO 40X60CM 25X1

Código: Fábrica: Unidade:
16447 ART FLOC PT/25
F1 F4

UN: R\$ 1,53 AV: R\$ 38,26 15: R\$ 39,06
30: R\$ 39,84 45: R\$ 40,64 60: R\$ 41,45



PAPEL CAMURCA VERMELHO 40X60CM 25X1

Código: Fábrica: Unidade:
6329 ART FLOC PT/25
F1 F4

UN: R\$ 1,53 AV: R\$ 38,26 15: R\$ 39,06
30: R\$ 39,84 45: R\$ 40,64 60: R\$ 41,45



PAPEL CAMURCA VINHO 40X60CM 25X1

Código: Fábrica: Unidade:
26224 ART FLOC PT/25
F1 F4

UN: R\$ 1,53 AV: R\$ 38,26 15: R\$ 39,06
30: R\$ 39,84 45: R\$ 40,64 60: R\$ 41,45



PAPEL CAMURCA VIOLETA 40X60CM 25X1

Código: Fábrica: Unidade:
35864 ART FLOC PT/25
F1 F4

UN: R\$ 0,48 AV: R\$ 24,14 15: R\$ 24,64
30: R\$ 25,13 45: R\$ 25,64 60: R\$ 26,15

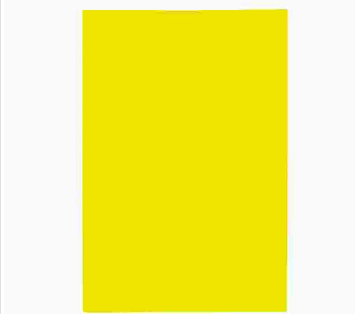

PAPEL CARTAO A4 AMARELO 50X1

Código: Fábrica: Unidade:
48884 BRASILPAPERS PT/50
F1 F4

UN: R\$ 0,48 AV: R\$ 24,14 15: R\$ 24,64
30: R\$ 25,13 45: R\$ 25,64 60: R\$ 26,15

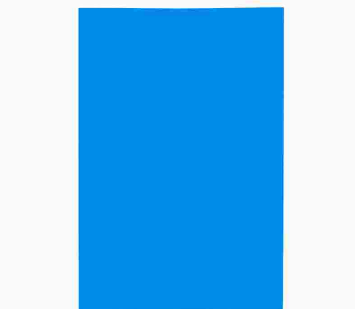

PAPEL CARTAO A4 AZUL 50X1

Código: Fábrica: Unidade:
48885 BRASILPAPERS PT/50
F1 F4

UN: R\$ 0,48 AV: R\$ 24,14 15: R\$ 24,64
30: R\$ 25,13 45: R\$ 25,64 60: R\$ 26,15

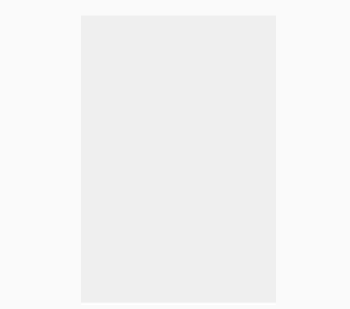

PAPEL CARTAO A4 BRANCO 50X1

Código: Fábrica: Unidade:
50782 MINASPEL PT/50
F1 F4

UN: R\$ 0,48 AV: R\$ 24,14 15: R\$ 24,64
30: R\$ 25,13 45: R\$ 25,64 60: R\$ 26,15

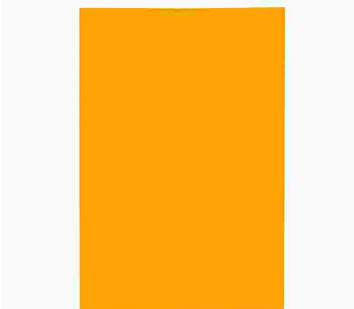

PAPEL CARTAO A4 LARANJA 50X1

Código: Fábrica: Unidade:
48888 BRASILPAPERS PT/50
F1 F4

UN: R\$ 0,48 AV: R\$ 24,14 15: R\$ 24,64
30: R\$ 25,13 45: R\$ 25,64 60: R\$ 26,15

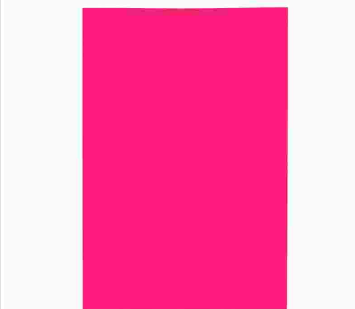

PAPEL CARTAO A4 PINK 50X1

Código: Fábrica: Unidade:
48889 BRASILPAPERS PT/50
F1 F4

UN: R\$ 0,48 AV: R\$ 24,14 15: R\$ 24,64
30: R\$ 25,13 45: R\$ 25,64 60: R\$ 26,15

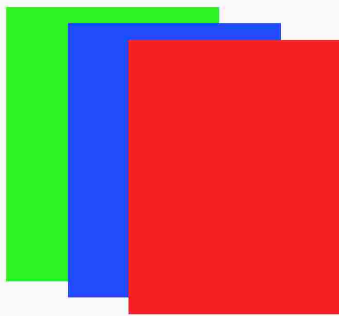

PAPEL CARTAO A4 SORT 50X1

Código: 30104 Fábrica: MINASPEL Unidade: PT/50 F1 F4

UN: R\$ 0,48 AV: R\$ 24,14 15: R\$ 24,64
30: R\$ 25,13 45: R\$ 25,64 60: R\$ 26,15



PAPEL CARTAO A4 VERDE 50X1

Código: 48887 Fábrica: BRASILPAPERS Unidade: PT/50 F1 F4

UN: R\$ 0,48 AV: R\$ 24,14 15: R\$ 24,64
30: R\$ 25,13 45: R\$ 25,64 60: R\$ 26,15



PAPEL CARTAO A4 VERMELHO 50X1

Código: 48886 Fábrica: BRASILPAPERS Unidade: PT/50 F1 F4

UN: R\$ 2,35 AV: R\$ 47,00 15: R\$ 47,98
30: R\$ 48,94 45: R\$ 49,92 60: R\$ 50,92



PAPEL CARTAO BRILHO 45X65CM AMARELO 20X1

Código: 26364 Fábrica: MINASPEL/MIL Unidade: PT/20 F1 F4

UN: R\$ 2,35 AV: R\$ 47,00 15: R\$ 47,98
30: R\$ 48,94 45: R\$ 49,92 60: R\$ 50,92

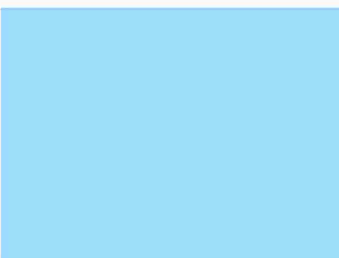

PAPEL CARTAO BRILHO 45X65CM AZUL BB 20X1

Código: 45219 Fábrica: MINASPEL Unidade: PT/20 F1 F4

UN: R\$ 2,35 AV: R\$ 47,00 15: R\$ 47,98
30: R\$ 48,94 45: R\$ 49,92 60: R\$ 50,92

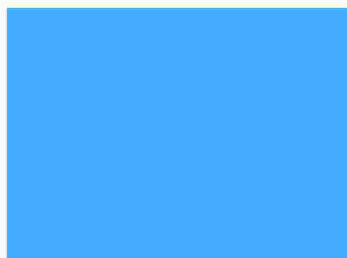

PAPEL CARTAO BRILHO 45X65CM AZUL CL 20X1

Código: 26363 Fábrica: MINASPEL Unidade: PT/20 F1 F4

UN: R\$ 2,35 AV: R\$ 47,00 15: R\$ 47,98
30: R\$ 48,94 45: R\$ 49,92 60: R\$ 50,92



PAPEL CARTAO BRILHO 45X65CM AZUL ES 20X1

Código: 26365 Fábrica: MINASPEL Unidade: PT/20 F1 F4

UN: R\$ 2,35 AV: R\$ 47,00 15: R\$ 47,98
30: R\$ 48,94 45: R\$ 49,92 60: R\$ 50,92



PAPEL CARTAO BRILHO 45X65CM AZUL RO 20X1

Código: 33428 Fábrica: MINASPEL Unidade: PT/20 F1 F4

UN: R\$ 2,35 AV: R\$ 47,00 15: R\$ 47,98
30: R\$ 48,94 45: R\$ 49,92 60: R\$ 50,92

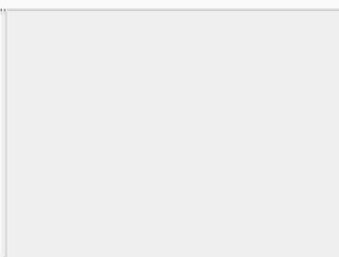

PAPEL CARTAO BRILHO 45X65CM BRANCO 20X1

Código: 26366 Fábrica: MINASPEL Unidade: PT/20 F1 F4

UN: R\$ 2,35 AV: R\$ 47,00 15: R\$ 47,98
30: R\$ 48,94 45: R\$ 49,92 60: R\$ 50,92



PAPEL CARTAO BRILHO 45X65CM LARANJA 20X1

Código: 26367 Fábrica: MINASPEL Unidade: PT/20 F1 F4

UN: R\$ 2,31 AV: R\$ 46,21 15: R\$ 47,18
30: R\$ 48,12 45: R\$ 49,08 60: R\$ 50,06



PAPEL CARTAO BRILHO 45X65CM PRATA 20X1

Código: 29043 Fábrica: LB PAPER Unidade: PT/20 F1 F4

UN: R\$ 2,35 AV: R\$ 47,00 15: R\$ 47,98
30: R\$ 48,94 45: R\$ 49,92 60: R\$ 50,92



PAPEL CARTAO BRILHO 45X65CM PRETO 20X1

Código: 26368 Fábrica: MINASPEL Unidade: PT/20 F1 F4

UN: R\$ 2,35 AV: R\$ 47,00 15: R\$ 47,98
30: R\$ 48,94 45: R\$ 49,92 60: R\$ 50,92



PAPEL CARTAO BRILHO 45X65CM ROSA 20X1

Código: 26369 Fábrica: MINASPEL Unidade: PT/20 F1 F4

UN: R\$ 1,49 AV: R\$ 29,78 15: R\$ 30,40
30: R\$ 31,01 45: R\$ 31,63 60: R\$ 32,26



PAPEL CARTAO BRILHO 45X65CM SORTIDO 20X1

Código: 29042 Fábrica: LB PAPER Unidade: PT/20 F1 F4

UN: R\$ 2,35 AV: R\$ 47,00 15: R\$ 47,98
30: R\$ 48,94 45: R\$ 49,92 60: R\$ 50,92



PAPEL CARTAO BRILHO 45X65CM VERDE B 20X1

Código: 26370 Fábrica: MINASPEL Unidade: PT/20 F1 F4

UN: R\$ 2,35 AV: R\$ 47,00 15: R\$ 47,98
30: R\$ 48,94 45: R\$ 49,92 60: R\$ 50,92



PAPEL CARTAO BRILHO 45X65CM VERDE C 20X1

Código: 26371 Fábrica: MINASPEL Unidade: PT/20 F1 F4

UN: R\$ 2,35 AV: R\$ 47,00 15: R\$ 47,98
30: R\$ 48,94 45: R\$ 49,92 60: R\$ 50,92



PAPEL CARTAO BRILHO 45X65CM VERMELH 20X1
Código: Fábrika: Unidade:
26362 MINASPEL PT/20
F1 F4

UN: R\$ 1,49 AV: R\$ 29,78 15: R\$ 30,40
30: R\$ 31,01 45: R\$ 31,63 60: R\$ 32,26



PAPEL CARTAO FOSCO 45X65CM AMARELO 20X1
Código: Fábrika: Unidade:
4051 MINASPEL PT/20
F1 F4

UN: R\$ 1,49 AV: R\$ 29,78 15: R\$ 30,40
30: R\$ 31,01 45: R\$ 31,63 60: R\$ 32,26



PAPEL CARTAO FOSCO 45X65CM AZUL CLA 20X1
Código: Fábrika: Unidade:
8092 MINASPEL PT/20
F1 F4

UN: R\$ 1,49 AV: R\$ 29,78 15: R\$ 30,40
30: R\$ 31,01 45: R\$ 31,63 60: R\$ 32,26



PAPEL CARTAO FOSCO 45X65CM AZUL ESC 20X1
Código: Fábrika: Unidade:
11242 MINASPEL PT/20
F1 F4

UN: R\$ 1,49 AV: R\$ 29,78 15: R\$ 30,40
30: R\$ 31,01 45: R\$ 31,63 60: R\$ 32,26



PAPEL CARTAO FOSCO 45X65CM AZUL ROY 20X1
Código: Fábrika: Unidade:
33176 MINASPEL PT/20
F1 F4

UN: R\$ 1,49 AV: R\$ 29,78 15: R\$ 30,40
30: R\$ 31,01 45: R\$ 31,63 60: R\$ 32,26



PAPEL CARTAO FOSCO 45X65CM AZUL 20X1
Código: Fábrika: Unidade:
47095 MINASPEL PT/20
F1 F4

UN: R\$ 1,49 AV: R\$ 29,78 15: R\$ 30,40
30: R\$ 31,01 45: R\$ 31,63 60: R\$ 32,26

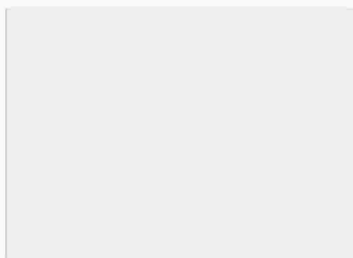

PAPEL CARTAO FOSCO 45X65CM BRANCO 20X1
Código: Fábrika: Unidade:
8094 MINASPEL PT/20
F1 F4

UN: R\$ 1,49 AV: R\$ 29,78 15: R\$ 30,40
30: R\$ 31,01 45: R\$ 31,63 60: R\$ 32,26



PAPEL CARTAO FOSCO 45X65CM CREME 20X1
Código: Fábrika: Unidade:
48261 MINASPEL PT/20
F1 F4

UN: R\$ 1,49 AV: R\$ 29,78 15: R\$ 30,40
30: R\$ 31,01 45: R\$ 31,63 60: R\$ 32,26



PAPEL CARTAO FOSCO 45X65CM LARANJA 20X1
Código: Fábrika: Unidade:
10180 MINASPEL PT/20
F1 F4

UN: R\$ 1,49 AV: R\$ 29,78 15: R\$ 30,40
30: R\$ 31,01 45: R\$ 31,63 60: R\$ 32,26



PAPEL CARTAO FOSCO 45X65CM LILAS 20X1
Código: Fábrika: Unidade:
36704 MINASPEL PT/20
F1 F4

UN: R\$ 1,49 AV: R\$ 29,78 15: R\$ 30,40
30: R\$ 31,01 45: R\$ 31,63 60: R\$ 32,26

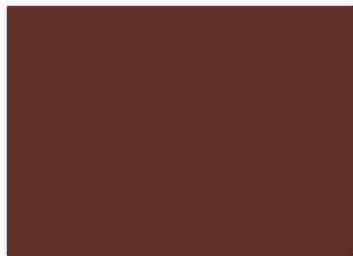

PAPEL CARTAO FOSCO 45X65CM MARROM 20X1
Código: Fábrika: Unidade:
50672 MINASPEL PT/20
F1 F4

UN: R\$ 1,49 AV: R\$ 29,78 15: R\$ 30,40
30: R\$ 31,01 45: R\$ 31,63 60: R\$ 32,26



PAPEL CARTAO FOSCO 45X65CM PRETO 20X1
Código: Fábrika: Unidade:
8097 MINASPEL PT/20
F1 F4

UN: R\$ 1,49 AV: R\$ 29,78 15: R\$ 30,40
30: R\$ 31,01 45: R\$ 31,63 60: R\$ 32,26



PAPEL CARTAO FOSCO 45X65CM ROSA PIN 20X1
Código: Fábrika: Unidade:
33352 MINASPEL PT/20
F1 F4

UN: R\$ 1,49 AV: R\$ 29,78 15: R\$ 30,40
30: R\$ 31,01 45: R\$ 31,63 60: R\$ 32,26



PAPEL CARTAO FOSCO 45X65CM ROSA 20X1
Código: Fábrika: Unidade:
8096 MINASPEL PT/20
F1 F4

UN: R\$ 1,49 AV: R\$ 29,78 15: R\$ 30,40
30: R\$ 31,01 45: R\$ 31,63 60: R\$ 32,26



PAPEL CARTAO FOSCO 45X65CM ROXO 20X1
Código: Fábrika: Unidade:
42346 MINASPEL PT/20
F1 F4

UN: R\$ 1,49 AV: R\$ 29,78 15: R\$ 30,40
30: R\$ 31,01 45: R\$ 31,63 60: R\$ 32,26



PAPEL CARTAO FOSCO 45X65CM VERDE BD 20X1
Código: Fábrika: Unidade:
8093 MINASPEL PT/20
F1 F4

UN: R\$ 1,49 AV: R\$ 29,78 15: R\$ 30,40
30: R\$ 31,01 45: R\$ 31,63 60: R\$ 32,26



PAPEL CARTAO FOSCO 45X65CM VERDE CL 20X1
Código: Fábrica: Unidade:
19268 MINASPEL PT/20
F1 F4

UN: R\$ 1,49 AV: R\$ 29,78 15: R\$ 30,40
30: R\$ 31,01 45: R\$ 31,63 60: R\$ 32,26



PAPEL CARTAO FOSCO 45X65CM VERDE LI 20X1
Código: Fábrica: Unidade:
47246 MINASPEL PT/20
F1 F4

UN: R\$ 1,49 AV: R\$ 29,78 15: R\$ 30,40
30: R\$ 31,01 45: R\$ 31,63 60: R\$ 32,26



PAPEL CARTAO FOSCO 45X65CM VERMELHO 20X1
Código: Fábrica: Unidade:
8095 MINASPEL PT/20
F1 F4

UN: R\$ 0,21 AV: R\$ 20,53 15: R\$ 20,96
30: R\$ 21,38 45: R\$ 21,81 60: R\$ 22,24



PAPEL CASCA OVO A4 90GR BRANCO 100X1
Código: Fábrica: Unidade:
51022 FILIPAPER PT/100
F1 F4

UN: R\$ 0,21 AV: R\$ 20,53 15: R\$ 20,96
30: R\$ 21,38 45: R\$ 21,81 60: R\$ 22,24

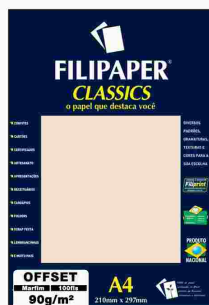

PAPEL CASCA OVO A4 90GR MARFIM 100X1
Código: Fábrica: Unidade:
51021 FILIPAPER PT/100
F1 F4

UN: R\$ 0,41 AV: R\$ 20,53 15: R\$ 20,96
30: R\$ 21,38 45: R\$ 21,81 60: R\$ 22,24



PAPEL CASCA OVO A4 180GR BRANCO 50X1
Código: Fábrica: Unidade:
48936 MASTERPRINT PT/50
F1 F4

UN: R\$ 1,39 AV: R\$ 69,75 15: R\$ 71,20
30: R\$ 72,62 45: R\$ 74,08 60: R\$ 75,56

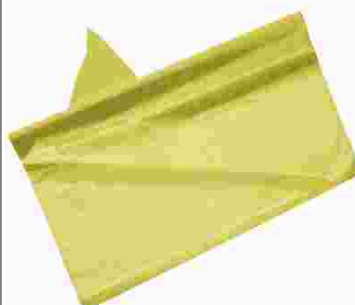

PAPEL CELOFANE 60X90CM AMARELO 50X1
Código: Fábrica: Unidade:
9921 COPLAMIX PT/50
F1 F4

UN: R\$ 1,39 AV: R\$ 69,75 15: R\$ 71,20
30: R\$ 72,62 45: R\$ 74,08 60: R\$ 75,56



PAPEL CELOFANE 60X90CM AZUL 50X1
Código: Fábrica: Unidade:
4049 COPLAMIX PT/50
F1 F4

UN: R\$ 1,13 AV: R\$ 56,49 15: R\$ 57,66
30: R\$ 58,82 45: R\$ 59,99 60: R\$ 61,19



PAPEL CELOFANE 60X90CM INCOLOR 50X1
Código: Fábrica: Unidade:
2568 COPLAMIX PT/50
F1 F4

UN: R\$ 1,40 AV: R\$ 69,84 15: R\$ 71,29
30: R\$ 72,72 45: R\$ 74,17 60: R\$ 75,66



PAPEL CELOFANE 60X90CM VERMELHO 50X1
Código: Fábrica: Unidade:
9920 COPLAMIX PT/50
F1 F4

UN: R\$ 1,40 AV: R\$ 69,84 15: R\$ 71,29
30: R\$ 72,72 45: R\$ 74,17 60: R\$ 75,66

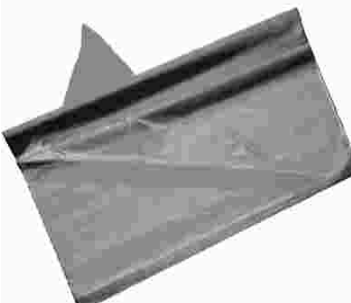

PAPEL CELOFANE 69X89CM PRETO 50X1
Código: Fábrica: Unidade:
28648 EMBALE PT/50
F1 F4

UN: R\$ 1,39 AV: R\$ 69,75 15: R\$ 71,20
30: R\$ 72,62 45: R\$ 74,08 60: R\$ 75,56



PAPEL CELOFANE 69X89CM MARROM 50X1
Código: Fábrica: Unidade:
28650 EMBALE PT/50
F1 F4

UN: R\$ 1,40 AV: R\$ 69,84 15: R\$ 71,29
30: R\$ 72,72 45: R\$ 74,17 60: R\$ 75,66



PAPEL CELOFANE 69X89CM ROXO 50X1
Código: Fábrica: Unidade:
28647 EMBALE PT/50
F1 F4

UN: R\$ 1,44 AV: R\$ 71,89 15: R\$ 73,39
30: R\$ 74,86 45: R\$ 76,36 60: R\$ 77,88



PAPEL CELOFANE 70X90CM AMARELO 50X1
Código: Fábrica: Unidade:
49680 GALA PT/50
F1 F4

UN: R\$ 1,44 AV: R\$ 71,89 15: R\$ 73,39
30: R\$ 74,86 45: R\$ 76,36 60: R\$ 77,88



PAPEL CELOFANE 70X90CM AZUL 50X1
Código: Fábrica: Unidade:
49679 GALA PT/50
F1 F4

UN: R\$ 1,13 AV: R\$ 56,49 15: R\$ 57,66
30: R\$ 58,82 45: R\$ 59,99 60: R\$ 61,19

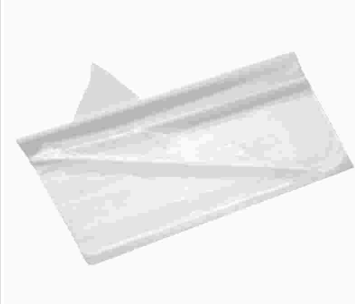

PAPEL CELOFANE 70X90CM INCOLOR 50X1
Código: Fábrica: Unidade:
49678 GALA PT/50
F1 F4

UN: R\$ 1,44 AV: R\$ 71,89 15: R\$ 73,39
30: R\$ 74,86 45: R\$ 76,36 60: R\$ 77,88

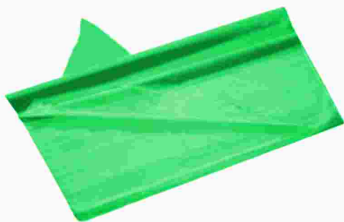

PAPEL CELOFANE 70X90CM VERDE BAND 50X1
Código: 9922 Fábrica: GALA Unidade: PT/50 F1 F4

UN: R\$ 1,44 AV: R\$ 71,89 15: R\$ 73,39
30: R\$ 74,86 45: R\$ 76,36 60: R\$ 77,88

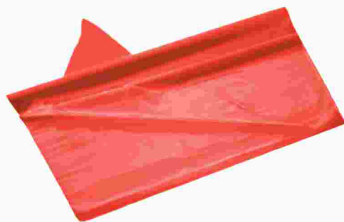

PAPEL CELOFANE 70X90CM VERMELHO 50X1
Código: 49681 Fábrica: GALA Unidade: PT/50 F1 F4

UN: R\$ 0,31 AV: R\$ 15,40 15: R\$ 15,72
30: R\$ 16,03 45: R\$ 16,35 60: R\$ 16,68



PAPEL COLORSET A4 AMARELO 50X1
Código: 15071 Fábrica: AGAPE/MINASP Unidade: PT/50 F1 F4

UN: R\$ 0,31 AV: R\$ 15,40 15: R\$ 15,72
30: R\$ 16,03 45: R\$ 16,35 60: R\$ 16,68

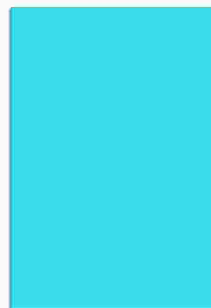

PAPEL COLORSET A4 AZUL CLARO 50X1
Código: 49390 Fábrica: AGAPE Unidade: PT/50 F1 F4

UN: R\$ 0,31 AV: R\$ 15,40 15: R\$ 15,72
30: R\$ 16,03 45: R\$ 16,35 60: R\$ 16,68



PAPEL COLORSET A4 AZUL ESCURO 50X1
Código: 30794 Fábrica: AGAPE Unidade: PT/50 F1 F4

UN: R\$ 0,31 AV: R\$ 15,40 15: R\$ 15,72
30: R\$ 16,03 45: R\$ 16,35 60: R\$ 16,68

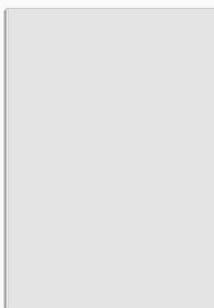

PAPEL COLORSET A4 BRANCO 50X1
Código: 30923 Fábrica: AGAPE Unidade: PT/50 F1 F4

UN: R\$ 0,31 AV: R\$ 15,40 15: R\$ 15,72
30: R\$ 16,03 45: R\$ 16,35 60: R\$ 16,68



PAPEL COLORSET A4 LARANJA 50X1
Código: 44488 Fábrica: AGAPE Unidade: PT/50 F1 F4

UN: R\$ 0,31 AV: R\$ 15,40 15: R\$ 15,72
30: R\$ 16,03 45: R\$ 16,35 60: R\$ 16,68

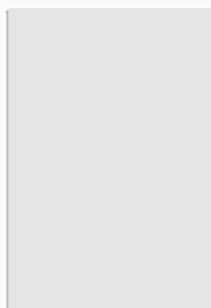

PAPEL COLORSET A4 LILAS 50X1
Código: 48087 Fábrica: AGAPE Unidade: PT/50 F1 F4

UN: R\$ 15,40 AV: R\$ 15,40 15: R\$ 15,72
30: R\$ 16,03 45: R\$ 16,35 60: R\$ 16,68



PAPEL COLORSET A4 MARRON 50X1
Código: 35574 Fábrica: AGAPE Unidade: PT/1 F1 F4

UN: R\$ 0,56 AV: R\$ 13,34 15: R\$ 13,62
30: R\$ 13,89 45: R\$ 14,17 60: R\$ 14,46

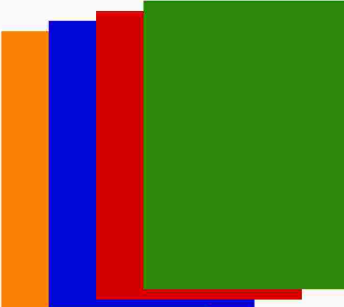

PAPEL COLORSET A4 MULTICOR 24X1
Código: 34264 Fábrica: ASSETE Unidade: PT/24 F1 F4

UN: R\$ 15,40 AV: R\$ 15,40 15: R\$ 15,72
30: R\$ 16,03 45: R\$ 16,35 60: R\$ 16,68

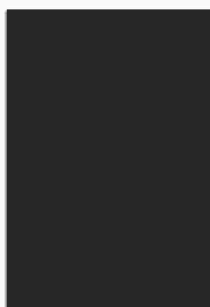

PAPEL COLORSET A4 PRETO 50X1
Código: 35575 Fábrica: AGAPE/MINASP Unidade: PT/1 F1 F4

UN: R\$ 0,31 AV: R\$ 15,41 15: R\$ 15,73
30: R\$ 16,04 45: R\$ 16,36 60: R\$ 16,69



PAPEL COLORSET A4 ROSA PINK 50X1
Código: 49391 Fábrica: AGAPE Unidade: PT/50 F1 F4

UN: R\$ 0,31 AV: R\$ 15,40 15: R\$ 15,72
30: R\$ 16,03 45: R\$ 16,35 60: R\$ 16,68



PAPEL COLORSET A4 ROSA 50X1
Código: 35896 Fábrica: AGAPE Unidade: PT/50 F1 F4

UN: R\$ 0,31 AV: R\$ 15,40 15: R\$ 15,72
30: R\$ 16,03 45: R\$ 16,35 60: R\$ 16,68

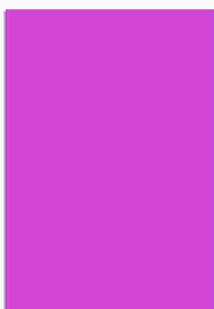

PAPEL COLORSET A4 ROXO 50X1
Código: 49392 Fábrica: AGAPE Unidade: PT/50 F1 F4

UN: R\$ 0,31 AV: R\$ 15,40 15: R\$ 15,72
30: R\$ 16,03 45: R\$ 16,35 60: R\$ 16,68

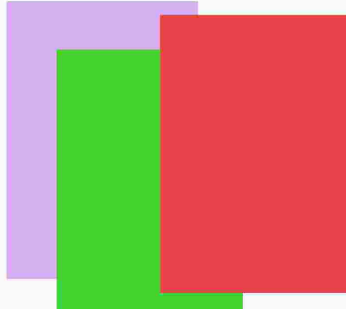

PAPEL COLORSET A4 SORT 50X1
Código: 35897 Fábrica: AGAPE/BRASIL Unidade: PT/50 F1 F4

UN: R\$ 0,31 AV: R\$ 15,40 15: R\$ 15,72
30: R\$ 16,03 45: R\$ 16,35 60: R\$ 16,68



PAPEL COLORSET A4 VERDE BAND 50X1
Código: 30793 Fábrica: AGAPE Unidade: PT/50 F1 F4

UN: R\$ 0,31 AV: R\$ 15,40 15: R\$ 15,72
30: R\$ 16,03 45: R\$ 16,35 60: R\$ 16,68

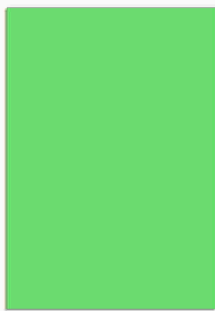

PAPEL COLORSET A4 VERDE CLA 50X1

Código: Fábrica: Unidade:
34592 MINASPEL PT/50
F1 F4

UN: R\$ 0,31 AV: R\$ 15,40 15: R\$ 15,72
30: R\$ 16,03 45: R\$ 16,35 60: R\$ 16,68

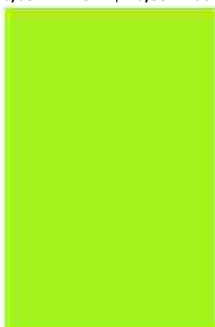

PAPEL COLORSET A4 VERDE LIMAO 50X1

Código: Fábrica: Unidade:
33079 AGAPE PT/50
F1 F4

UN: R\$ 0,31 AV: R\$ 15,40 15: R\$ 15,72
30: R\$ 16,03 45: R\$ 16,35 60: R\$ 16,68



PAPEL COLORSET A4 VERMELHO 50X1

Código: Fábrica: Unidade:
30795 AGAPE PT/50
F1 F4

UN: R\$ 0,98 AV: R\$ 0,98 15: R\$ 1,00
30: R\$ 1,02 45: R\$ 1,04 60: R\$ 1,06



PAPEL COLORSET UN

Código: Fábrica: Unidade:
42274 MINASPEL UN/1
F1 F4

UN: R\$ 1,28 AV: R\$ 25,67 15: R\$ 26,20
30: R\$ 26,73 45: R\$ 27,26 60: R\$ 27,81



PAPEL COLORSET 45X65CM AZUL ROYAL 20X1

Código: Fábrica: Unidade:
30575 MINASPEL PT/20
F1 F4

UN: R\$ 1,28 AV: R\$ 25,67 15: R\$ 26,20
30: R\$ 26,73 45: R\$ 27,26 60: R\$ 27,81



PAPEL COLORSET 45X65CM CAMELO 20X1

Código: Fábrica: Unidade:
46989 MINASPEL PT/20
F1 F4

UN: R\$ 1,28 AV: R\$ 25,67 15: R\$ 26,20
30: R\$ 26,73 45: R\$ 27,26 60: R\$ 27,81



PAPEL COLORSET 45X65CM OCRE 20X1

Código: Fábrica: Unidade:
46988 MINASPEL PT/20
F1 F4

UN: R\$ 1,28 AV: R\$ 25,67 15: R\$ 26,20
30: R\$ 26,73 45: R\$ 27,26 60: R\$ 27,81



PAPEL COLORSET 45X65CM ROSA FLUOR 20X1

Código: Fábrica: Unidade:
33177 MINASPEL PT/20
F1 F4

UN: R\$ 1,28 AV: R\$ 25,67 15: R\$ 26,20
30: R\$ 26,73 45: R\$ 27,26 60: R\$ 27,81



PAPEL COLORSET 45X65CM ROXO 20X1

Código: Fábrica: Unidade:
21635 MINASPEL/MIL PT/20
F1 F4

UN: R\$ 1,28 AV: R\$ 25,67 15: R\$ 26,20
30: R\$ 26,73 45: R\$ 27,26 60: R\$ 27,81

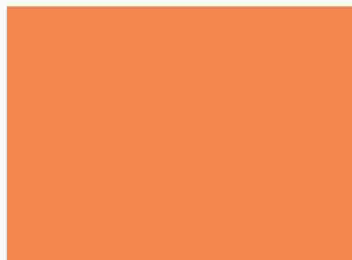

PAPEL COLORSET 45X65CM SALMAO 20X1

Código: Fábrica: Unidade:
46990 MINASPEL PT/20
F1 F4

UN: R\$ 1,28 AV: R\$ 25,67 15: R\$ 26,20
30: R\$ 26,73 45: R\$ 27,26 60: R\$ 27,81

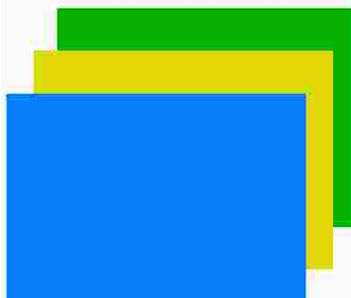

PAPEL COLORSET 45X65CM SORTIDO 20X1

Código: Fábrica: Unidade:
28718 LB PAPER PT/20
F1 F4

UN: R\$ 1,28 AV: R\$ 25,67 15: R\$ 26,20
30: R\$ 26,73 45: R\$ 27,26 60: R\$ 27,81

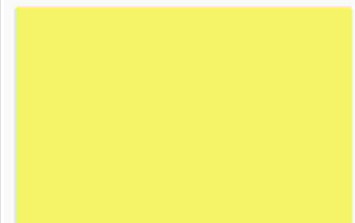

PAPEL COLORSET 45X66CM AMARELO 20X1

Código: Fábrica: Unidade:
10114 REIPEL/MINAS PT/20
F1 F4

UN: R\$ 1,28 AV: R\$ 25,67 15: R\$ 26,20
30: R\$ 26,73 45: R\$ 27,26 60: R\$ 27,81

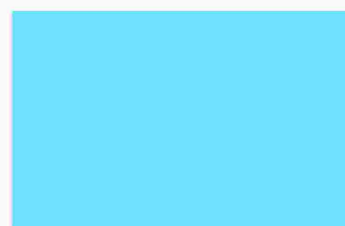

PAPEL COLORSET 45X66CM AZUL CLARO 20X1

Código: Fábrica: Unidade:
19792 REIPEL/MINAS PT/20
F1 F4

UN: R\$ 1,28 AV: R\$ 25,67 15: R\$ 26,20
30: R\$ 26,73 45: R\$ 27,26 60: R\$ 27,81



PAPEL COLORSET 45X66CM AZUL ESCURO 20X1

Código: Fábrica: Unidade:
10113 REIPEL/MINAS PT/20
F1 F4

UN: R\$ 1,28 AV: R\$ 25,67 15: R\$ 26,20
30: R\$ 26,73 45: R\$ 27,26 60: R\$ 27,81

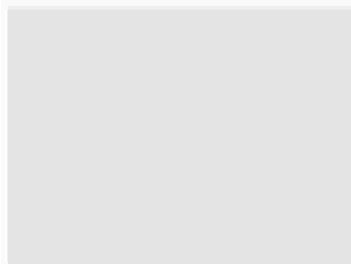

PAPEL COLORSET 45X66CM BRANCO 20X1

Código: Fábrica: Unidade:
10116 REIPEL/MINAS PT/20
F1 F4

UN: R\$ 1,28 AV: R\$ 25,67 15: R\$ 26,20
30: R\$ 26,73 45: R\$ 27,26 60: R\$ 27,81



PAPEL COLORSET 45X66CM CHAMPAGNE 20X1

Código: Fábrica: Unidade:
47721 REIPEL PT/20
F1 F4

UN: R\$ 1,28 AV: R\$ 25,67 15: R\$ 26,20
30: R\$ 26,73 45: R\$ 27,26 60: R\$ 27,81



PAPEL COLORSET 45X66CM LARANJA 20X1
Código: 10112 Fábrica: REIPEL/MINAS Unidade: PT/20 F1 F4

UN: R\$ 1,28 AV: R\$ 25,67 15: R\$ 26,20
30: R\$ 26,73 45: R\$ 27,26 60: R\$ 27,81



PAPEL COLORSET 45X66CM MARROM 20X1
Código: 10111 Fábrica: REIPEL/MINAS Unidade: PT/20 F1 F4

UN: R\$ 1,28 AV: R\$ 25,67 15: R\$ 26,20
30: R\$ 26,73 45: R\$ 27,26 60: R\$ 27,81

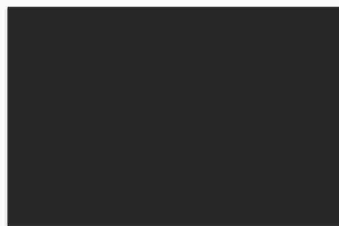

PAPEL COLORSET 45X66CM PRETO 20X1
Código: 15112 Fábrica: REIPEL/MINAS Unidade: PT/20 F1 F4

UN: R\$ 1,28 AV: R\$ 25,67 15: R\$ 26,20
30: R\$ 26,73 45: R\$ 27,26 60: R\$ 27,81



PAPEL COLORSET 45X66CM ROSA PINK 20X1
Código: 29833 Fábrica: REIPEL/MINAS Unidade: PT/20 F1 F4

UN: R\$ 1,28 AV: R\$ 25,67 15: R\$ 26,20
30: R\$ 26,73 45: R\$ 27,26 60: R\$ 27,81



PAPEL COLORSET 45X66CM ROSA 20X1
Código: 15113 Fábrica: REIPEL/MINAS Unidade: PT/20 F1 F4

UN: R\$ 1,28 AV: R\$ 25,67 15: R\$ 26,20
30: R\$ 26,73 45: R\$ 27,26 60: R\$ 27,81



PAPEL COLORSET 45X66CM VERDE BAND 20X1
Código: 4260 Fábrica: REIPEL/MINAS Unidade: PT/20 F1 F4

UN: R\$ 1,28 AV: R\$ 25,67 15: R\$ 26,20
30: R\$ 26,73 45: R\$ 27,26 60: R\$ 27,81



PAPEL COLORSET 45X66CM VERDE CLARO 20X1
Código: 19549 Fábrica: REIPEL/MINAS Unidade: PT/20 F1 F4

UN: R\$ 1,28 AV: R\$ 25,67 15: R\$ 26,20
30: R\$ 26,73 45: R\$ 27,26 60: R\$ 27,81

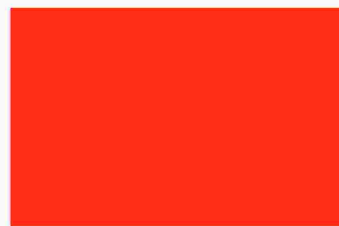

PAPEL COLORSET 45X66CM VERMELHO 20X1
Código: 10115 Fábrica: REIPEL/MINAS Unidade: PT/20 F1 F4

UN: R\$ 1,28 AV: R\$ 25,67 15: R\$ 26,20
30: R\$ 26,73 45: R\$ 27,26 60: R\$ 27,81



PAPEL COLORSET 45X66CM VIOLETA 20X1
Código: 47722 Fábrica: REIPEL Unidade: PT/20 F1 F4

UN: R\$ 2,49 AV: R\$ 49,82 15: R\$ 50,86
30: R\$ 51,87 45: R\$ 52,91 60: R\$ 53,97



PAPEL COLORSET 48X66CM ESTRELA VERM 20X1
Código: 48371 Fábrica: VMP Unidade: PT/20 F1 F4

UN: R\$ 2,49 AV: R\$ 49,82 15: R\$ 50,86
30: R\$ 51,87 45: R\$ 52,91 60: R\$ 53,97

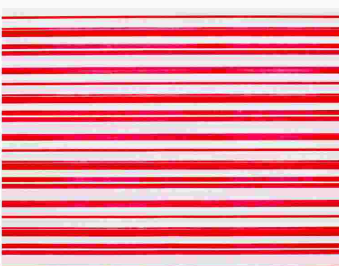

PAPEL COLORSET 48X66CM LISTRAD VERM 20X1
Código: 48376 Fábrica: VMP Unidade: PT/20 F1 F4

UN: R\$ 2,49 AV: R\$ 49,82 15: R\$ 50,86
30: R\$ 51,87 45: R\$ 52,91 60: R\$ 53,97

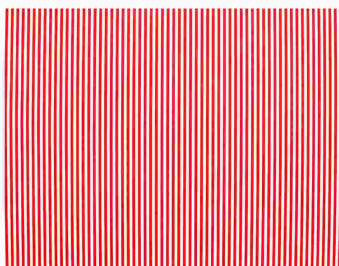

PAPEL COLORSET 48X66CM LISTRAS VERM 20X1
Código: 48375 Fábrica: VMP Unidade: PT/20 F1 F4

UN: R\$ 2,49 AV: R\$ 49,82 15: R\$ 50,86
30: R\$ 51,87 45: R\$ 52,91 60: R\$ 53,97

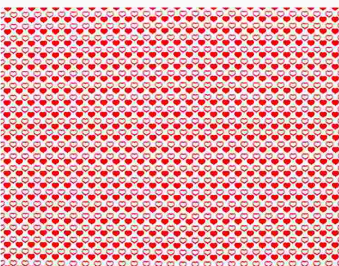

PAPEL COLORSET 48X66CM 2 CORACOES 20X1
Código: 48372 Fábrica: VMP Unidade: PT/20 F1 F4

UN: R\$ 1,28 AV: R\$ 25,67 15: R\$ 26,20
30: R\$ 26,73 45: R\$ 27,26 60: R\$ 27,81



PAPEL COLORSET 45X66CM LILAS 20X1
Código: 16640 Fábrica: REIPEL/MINAS Unidade: PT/20 F1 F4

UN: R\$ 61,62 AV: R\$ 61,62 15: R\$ 62,91
30: R\$ 64,16 45: R\$ 65,45 60: R\$ 66,76



PAPEL CONTACT 45CMX10M ADES MADEIRA CINZ
Código: 48312 Fábrica: BRW Unidade: RL/1 F1 F4

UN: R\$ 7,70 AV: R\$ 77,03 15: R\$ 78,63
30: R\$ 80,21 45: R\$ 81,81 60: R\$ 83,45



PAPEL CONTACT 45CMX10M ADESIVO BRANCO
Código: 48358 Fábrica: LEOTACK Unidade: RL/10 F1 F4

UN: R\$ 7,70 AV: R\$ 77,03 15: R\$ 78,63
30: R\$ 80,21 45: R\$ 81,81 60: R\$ 83,45



PAPEL CONTACT 45CMX10MT ADESIVO PRETO
Código: Fábrika: Unidade:
48359 LEOTACK RL/10
F1 F4

UN: R\$ 71,89 AV: R\$ 71,89 15: R\$ 73,39
30: R\$ 74,86 45: R\$ 76,36 60: R\$ 77,88



PAPEL CONTACT 45CMX10MT ADESIVO PRETO 17
Código: Fábrika: Unidade:
46147 WIN PAPER RL/1
F1 F4

UN: R\$ 71,89 AV: R\$ 71,89 15: R\$ 73,39
30: R\$ 74,86 45: R\$ 76,36 60: R\$ 77,88



PAPEL CONTACT 45CMX10MT ADESIVO VERDE 10
Código: Fábrika: Unidade:
45949 WIN PAPER RL/1
F1 F4

UN: R\$ 71,89 AV: R\$ 71,89 15: R\$ 73,39
30: R\$ 74,86 45: R\$ 76,36 60: R\$ 77,88



PAPEL CONTACT 45CMX10MT ADESIVO VERMEL 9
Código: Fábrika: Unidade:
45950 WIN PAPER RL/1
F1 F4

UN: R\$ 92,44 AV: R\$ 92,44 15: R\$ 94,36
30: R\$ 96,25 45: R\$ 98,18 60: R\$ 100,14

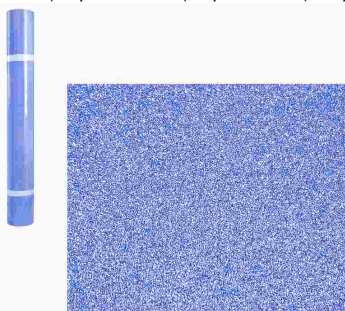

PAPEL CONTACT 45CMX10MT GLITER AZUL 1703
Código: Fábrika: Unidade:
42656 DAC RL/1
F1 F4

UN: R\$ 92,44 AV: R\$ 92,44 15: R\$ 94,36
30: R\$ 96,25 45: R\$ 98,18 60: R\$ 100,14



PAPEL CONTACT 45CMX10MT GLITER PRAT 1703
Código: Fábrika: Unidade:
37948 DAC RL/1
F1 F4

UN: R\$ 92,44 AV: R\$ 92,44 15: R\$ 94,36
30: R\$ 96,25 45: R\$ 98,18 60: R\$ 100,14



PAPEL CONTACT 45CMX10MT GLITER PRET 1703
Código: Fábrika: Unidade:
42658 DAC RL/1
F1 F4

UN: R\$ 92,44 AV: R\$ 92,44 15: R\$ 94,36
30: R\$ 96,25 45: R\$ 98,18 60: R\$ 100,14



PAPEL CONTACT 45CMX10MT GLITER ROSA 1703
Código: Fábrika: Unidade:
38030 DAC RL/1
F1 F4

UN: R\$ 92,44 AV: R\$ 92,44 15: R\$ 94,36
30: R\$ 96,25 45: R\$ 98,18 60: R\$ 100,14



PAPEL CONTACT 45CMX10MT GLITER VERM 1703
Código: Fábrika: Unidade:
42657 DAC RL/1
F1 F4

UN: R\$ 99,12 AV: R\$ 99,12 15: R\$ 101,19
30: R\$ 103,21 45: R\$ 105,28 60: R\$ 107,38



PAPEL CONTACT 45CMX10MT HOL ESTRELA 7435
Código: Fábrika: Unidade:
46410 KAZ RL/1
F1 F4

UN: R\$ 71,89 AV: R\$ 71,89 15: R\$ 73,39
30: R\$ 74,86 45: R\$ 76,36 60: R\$ 77,88



PAPEL CONTACT 45CMX10MT IMBUIA 911
Código: Fábrika: Unidade:
46411 KAZ RL/1
F1 F4

UN: R\$ 77,03 AV: R\$ 77,03 15: R\$ 78,63
30: R\$ 80,21 45: R\$ 81,81 60: R\$ 83,45



PAPEL CONTACT 45CMX10MT MADEIRA TABACO
Código: Fábrika: Unidade:
32790 VMP RL/1
F1 F4

UN: R\$ 92,44 AV: R\$ 92,44 15: R\$ 94,36
30: R\$ 96,25 45: R\$ 98,18 60: R\$ 100,14

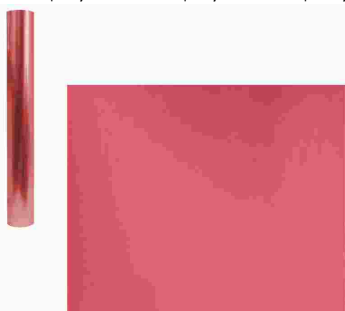

PAPEL CONTACT 45CMX10MT METAL ROSA 1751
Código: Fábrika: Unidade:
37944 DAC RL/1
F1 F4

UN: R\$ 71,89 AV: R\$ 71,89 15: R\$ 73,39
30: R\$ 74,86 45: R\$ 76,36 60: R\$ 77,88

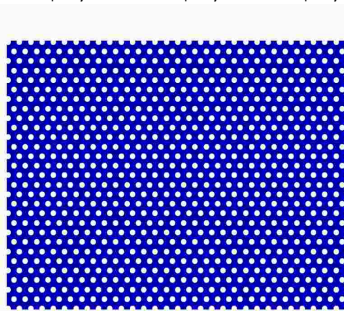

PAPEL CONTACT 45CMX10MT POA AZUL
Código: Fábrika: Unidade:
34388 VMP RL/1
F1 F4

UN: R\$ 80,74 AV: R\$ 80,74 15: R\$ 82,42
30: R\$ 84,07 45: R\$ 85,75 60: R\$ 87,47



PAPEL CONTACT 45CMX10MT PVC AZUL 1702
Código: Fábrika: Unidade:
37937 DAC RL/1
F1 F4

UN: R\$ 71,89 AV: R\$ 71,89 15: R\$ 73,39
30: R\$ 74,86 45: R\$ 76,36 60: R\$ 77,88

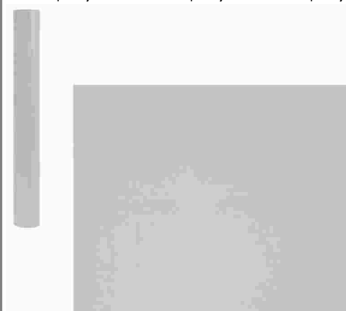

PAPEL CONTACT 45CMX10MT PVC BRANCO 1702
Código: Fábrika: Unidade:
37939 DAC RL/1
F1 F4

UN: R\$ 71,89 AV: R\$ 71,89 15: R\$ 73,39
30: R\$ 74,86 45: R\$ 76,36 60: R\$ 77,88



PAPEL CONTACT 45CMX10MT PVC PRETO 1702

Código: 37942 Fábrica: DAC Unidade: RL/1 F1 F4

UN: R\$ 71,89 AV: R\$ 71,89 15: R\$ 73,39
30: R\$ 74,86 45: R\$ 76,36 60: R\$ 77,88

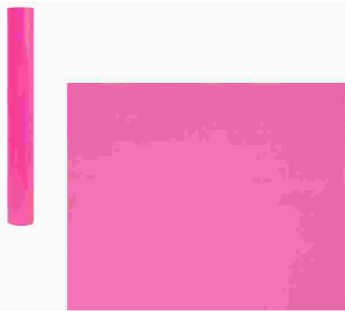

PAPEL CONTACT 45CMX10MT PVC ROSA 1702

Código: 37941 Fábrica: DAC Unidade: RL/1 F1 F4

UN: R\$ 41,78 AV: R\$ 41,78 15: R\$ 42,65
30: R\$ 43,50 45: R\$ 44,37 60: R\$ 45,26

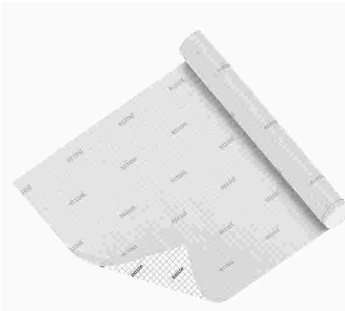

PAPEL CONTACT 45CMX10MT PVC TRANSP

Código: 50376 Fábrica: BAZZE Unidade: RL/1 F1 F4

UN: R\$ 79,08 AV: R\$ 79,08 15: R\$ 80,73
30: R\$ 82,35 45: R\$ 83,99 60: R\$ 85,67

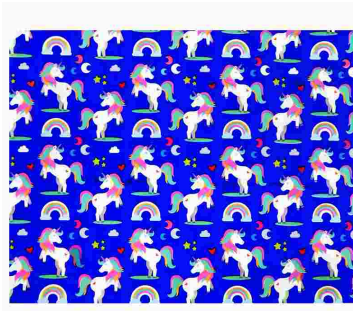

PAPEL CONTACT 45CMX10MT UNICORNIO

Código: 34389 Fábrica: VMP Unidade: RL/1 F1 F4

UN: R\$ 27,69 AV: R\$ 27,69 15: R\$ 28,26
30: R\$ 28,83 45: R\$ 29,41 60: R\$ 29,99

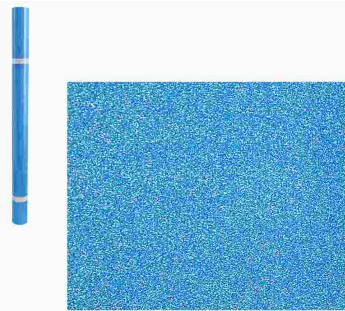

PAPEL CONTACT 45CMX2MT GLITER AZUL 1711

Código: 37950 Fábrica: DAC Unidade: RL/1 F1 F4

UN: R\$ 27,69 AV: R\$ 27,69 15: R\$ 28,26
30: R\$ 28,83 45: R\$ 29,41 60: R\$ 29,99

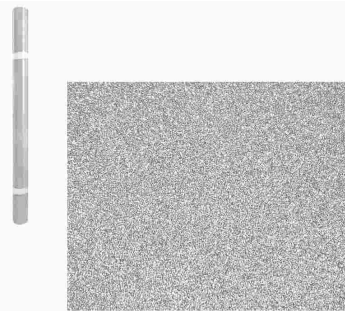

PAPEL CONTACT 45CMX2MT GLITER PRAT 1711

Código: 37954 Fábrica: DAC Unidade: RL/1 F1 F4

UN: R\$ 27,69 AV: R\$ 27,69 15: R\$ 28,26
30: R\$ 28,83 45: R\$ 29,41 60: R\$ 29,99

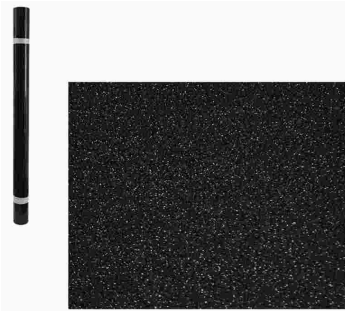

PAPEL CONTACT 45CMX2MT GLITER PRETO 1711

Código: 37953 Fábrica: DAC Unidade: RL/1 F1 F4

UN: R\$ 27,69 AV: R\$ 27,69 15: R\$ 28,26
30: R\$ 28,83 45: R\$ 29,41 60: R\$ 29,99

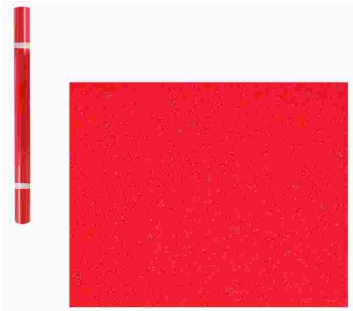

PAPEL CONTACT 45CMX2MT GLITER VERME 1711

Código: 37955 Fábrica: DAC Unidade: RL/1 F1 F4

UN: R\$ 24,34 AV: R\$ 24,34 15: R\$ 24,85
30: R\$ 25,35 45: R\$ 25,85 60: R\$ 26,37

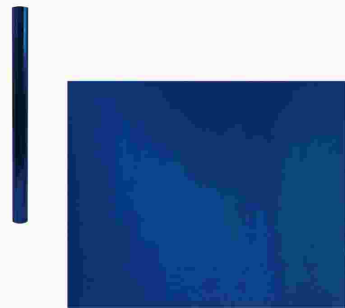

PAPEL CONTACT 45CMX2MT METAL AZUL 1750

Código: 37963 Fábrica: DAC Unidade: RL/1 F1 F4

UN: R\$ 24,34 AV: R\$ 24,34 15: R\$ 24,85
30: R\$ 25,35 45: R\$ 25,85 60: R\$ 26,37

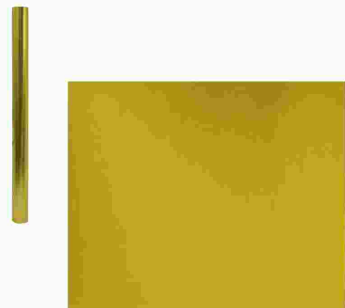

PAPEL CONTACT 45CMX2MT METAL DOURAD 1750

Código: 37961 Fábrica: DAC Unidade: RL/1 F1 F4

UN: R\$ 24,34 AV: R\$ 24,34 15: R\$ 24,85
30: R\$ 25,35 45: R\$ 25,85 60: R\$ 26,37

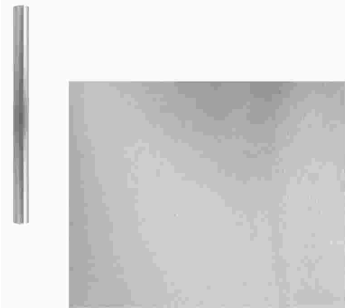

PAPEL CONTACT 45CMX2MT METAL PRATA 1750

Código: 37962 Fábrica: DAC Unidade: RL/1 F1 F4

UN: R\$ 24,34 AV: R\$ 24,34 15: R\$ 24,85
30: R\$ 25,35 45: R\$ 25,85 60: R\$ 26,37

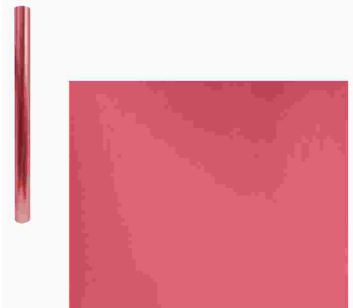

PAPEL CONTACT 45CMX2MT METAL ROSA 1750

Código: 37958 Fábrica: DAC Unidade: RL/1 F1 F4

UN: R\$ 24,34 AV: R\$ 24,34 15: R\$ 24,85
30: R\$ 25,35 45: R\$ 25,85 60: R\$ 26,37



PAPEL CONTACT 45CMX2MT METAL ROXO 1750

Código: 37959 Fábrica: DAC Unidade: RL/1 F1 F4

UN: R\$ 19,09 AV: R\$ 19,09 15: R\$ 19,49
30: R\$ 19,88 45: R\$ 20,28 60: R\$ 20,68



PAPEL CONTACT 45CMX2MT PVC AMARELO 1708

Código: 37966 Fábrica: DAC Unidade: RL/1 F1 F4

UN: R\$ 19,09 AV: R\$ 19,09 15: R\$ 19,49
30: R\$ 19,88 45: R\$ 20,28 60: R\$ 20,68



PAPEL CONTACT 45CMX2MT PVC AZUL 1708

Código: 37964 Fábrica: DAC Unidade: RL/1 F1 F4

UN: R\$ 19,09 AV: R\$ 19,09 15: R\$ 19,49
30: R\$ 19,88 45: R\$ 20,28 60: R\$ 20,68



PAPEL CONTACT 45CMX2MT PVC ROSA 1708

Código: 37969 Fábrica: DAC Unidade: RL/1 F1 F4

UN: R\$ 4,00 AV: R\$ 100,07 15: R\$ 102,15
30: R\$ 104,20 45: R\$ 106,28 60: R\$ 108,41



PAPEL CONTACT 45CMX25MT ADESIVO TRANSP

Código: Fábrica: Unidade:
46375 LEOTACK RL/25
F1 F4

UN: R\$ 3,70 AV: R\$ 92,44 15: R\$ 94,36
30: R\$ 96,25 45: R\$ 98,18 60: R\$ 100,14



PAPEL CONTACT 45CMX25MT ADESIVO TRANSP

Código: Fábrica: Unidade:
3065 DAC/POLIFIX RL/25
F1 F4

UN: R\$ 133,53 AV: R\$ 133,53 15: R\$ 136,31
30: R\$ 139,03 45: R\$ 141,81 60: R\$ 144,65



PAPEL CONTACT 45CMX25MT CRISTAL 80MIC 80

Código: Fábrica: Unidade:
46412 KAZ RL/1
F1 F4

UN: R\$ 26,70 AV: R\$ 26,70 15: R\$ 27,25
30: R\$ 27,80 45: R\$ 28,35 60: R\$ 28,92

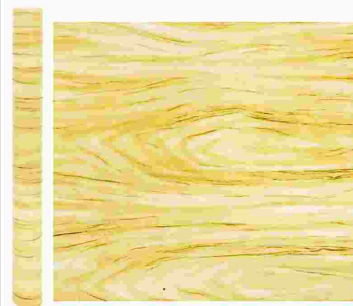

PAPEL CONTACT 45CMX5M DEC AUTOADESIV 001

Código: Fábrica: Unidade:
49371 RIOHOME RL/1
F1 F4

UN: R\$ 26,60 AV: R\$ 26,60 15: R\$ 27,16
30: R\$ 27,70 45: R\$ 28,26 60: R\$ 28,82



PAPEL CONTACT 45CMX5M DEC AUTOADESIV 002

Código: Fábrica: Unidade:
49370 RIOHOME RL/1
F1 F4

UN: R\$ 26,70 AV: R\$ 26,70 15: R\$ 27,25
30: R\$ 27,80 45: R\$ 28,35 60: R\$ 28,92



PAPEL CONTACT 45CMX5M DEC AUTOADESIV 003

Código: Fábrica: Unidade:
49374 RIOHOME RL/1
F1 F4

UN: R\$ 26,70 AV: R\$ 26,70 15: R\$ 27,25
30: R\$ 27,80 45: R\$ 28,35 60: R\$ 28,92



PAPEL CONTACT 45CMX5M DEC AUTOADESIV 004

Código: Fábrica: Unidade:
49373 RIOHOME RL/1
F1 F4

UN: R\$ 26,70 AV: R\$ 26,70 15: R\$ 27,25
30: R\$ 27,80 45: R\$ 28,35 60: R\$ 28,92



PAPEL CONTACT 45CMX5M DEC AUTOADESIV 007

Código: Fábrica: Unidade:
49369 RIOHOME RL/1
F1 F4

UN: R\$ 26,70 AV: R\$ 26,70 15: R\$ 27,25
30: R\$ 27,80 45: R\$ 28,35 60: R\$ 28,92



PAPEL CONTACT 45CMX5M DEC AUTOADESIV 011

Código: Fábrica: Unidade:
49372 RIOHOME RL/1
F1 F4

UN: R\$ 26,70 AV: R\$ 26,70 15: R\$ 27,25
30: R\$ 27,80 45: R\$ 28,35 60: R\$ 28,92



PAPEL CONTACT 45CMX5M DEC AUTOADESIV 014

Código: Fábrica: Unidade:
49367 RIOHOME RL/1
F1 F4

UN: R\$ 26,70 AV: R\$ 26,70 15: R\$ 27,25
30: R\$ 27,80 45: R\$ 28,35 60: R\$ 28,92

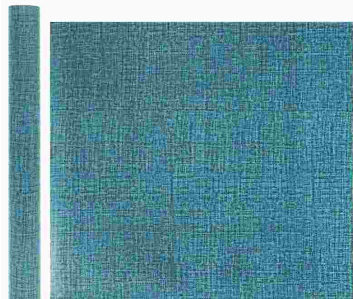

PAPEL CONTACT 45CMX5M DEC AUTOADESIV 015

Código: Fábrica: Unidade:
49368 RIOHOME RL/1
F1 F4

UN: R\$ 33,69 AV: R\$ 33,69 15: R\$ 34,39
30: R\$ 35,08 45: R\$ 35,78 60: R\$ 36,50

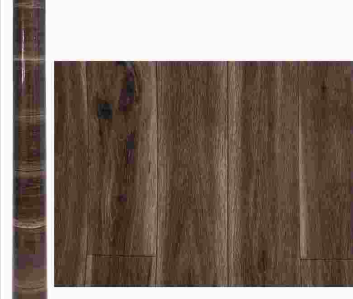

PAPEL CONTACT 45CMX5MT 50062

Código: Fábrica: Unidade:
38541 ROCIE RL/1
F1 F4

UN: R\$ 0,52 AV: R\$ 26,06 15: R\$ 26,60
30: R\$ 27,14 45: R\$ 27,68 60: R\$ 28,23



PAPEL COUCHE A4 180GR BRILHO 50X1

Código: Fábrica: Unidade:
41369 USAPEL PT/50
F1 F4

UN: R\$ 0,77 AV: R\$ 38,52 15: R\$ 39,32
30: R\$ 40,11 45: R\$ 40,91 60: R\$ 41,73



PAPEL COUCHE A4 180GR GRANITTO NT 50X1

Código: Fábrica: Unidade:
41371 USAPEL PT/50
F1 F4

UN: R\$ 0,52 AV: R\$ 26,06 15: R\$ 26,60
30: R\$ 27,14 45: R\$ 27,68 60: R\$ 28,23



PAPEL COUCHE A4 180GR MATTE BRANCO 50X1

Código: Fábrica: Unidade:
41370 USAPEL PT/50
F1 F4

UN: R\$ 0,52 AV: R\$ 26,06 15: R\$ 26,60
30: R\$ 27,14 45: R\$ 27,68 60: R\$ 28,23

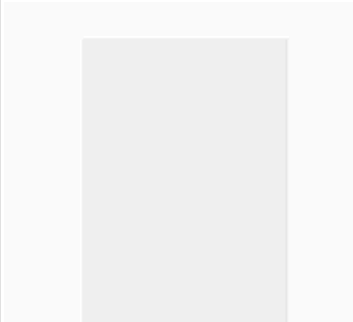

PAPEL COUCHE BRILHO A4 90GR 50X1

Código: Fábrica: Unidade:
34267 ASSETE PT/50
F1 F4

UN: R\$ 0,47 AV: R\$ 23,62 15: R\$ 24,11
30: R\$ 24,59 45: R\$ 25,08 60: R\$ 25,58

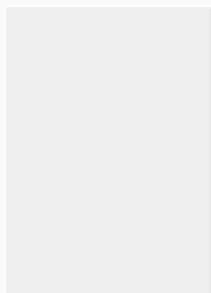

PAPEL COUCHE BRILHO A4 170GR 513 50X1

Código: Fábrica: Unidade:
34266 MASTERPINT PT/50
F1 F4

UN: R\$ 4,52 AV: R\$ 45,19 15: R\$ 46,13
30: R\$ 47,05 45: R\$ 47,99 60: R\$ 48,95



PAPEL CREPOM DEC CARROS PRETO 10X1

Código: Fábrica: Unidade:
49597 VMP PT/10
F1 F4

UN: R\$ 4,52 AV: R\$ 45,19 15: R\$ 46,13
30: R\$ 47,05 45: R\$ 47,99 60: R\$ 48,95



PAPEL CREPOM DEC FROZEN ROXO 10X1

Código: Fábrica: Unidade:
49600 VMP PT/10
F1 F4

UN: R\$ 4,52 AV: R\$ 45,19 15: R\$ 46,13
30: R\$ 47,05 45: R\$ 47,99 60: R\$ 48,95



PAPEL CREPOM DEC MARIE 10X1

Código: Fábrica: Unidade:
49602 VMP PT/10
F1 F4

UN: R\$ 4,52 AV: R\$ 45,19 15: R\$ 46,13
30: R\$ 47,05 45: R\$ 47,99 60: R\$ 48,95



PAPEL CREPOM DEC MICKEY BRANCO 10X1

Código: Fábrica: Unidade:
49596 VMP PT/10
F1 F4

UN: R\$ 4,52 AV: R\$ 45,19 15: R\$ 46,13
30: R\$ 47,05 45: R\$ 47,99 60: R\$ 48,95



PAPEL CREPOM DEC MICKEY PRETO 10X1

Código: Fábrica: Unidade:
49594 VMP PT/10
F1 F4

UN: R\$ 4,52 AV: R\$ 45,19 15: R\$ 46,13
30: R\$ 47,05 45: R\$ 47,99 60: R\$ 48,95



PAPEL CREPOM DEC MINNIE VERMELHO 10X1

Código: Fábrica: Unidade:
49601 VMP PT/10
F1 F4

UN: R\$ 4,52 AV: R\$ 45,19 15: R\$ 46,13
30: R\$ 47,05 45: R\$ 47,99 60: R\$ 48,95



PAPEL CREPOM DEC TOY STORY AZUL 10X1

Código: Fábrica: Unidade:
49592 VMP PT/10
F1 F4

UN: R\$ 4,52 AV: R\$ 45,19 15: R\$ 46,13
30: R\$ 47,05 45: R\$ 47,99 60: R\$ 48,95



PAPEL CREPOM DEC TOY STORY CINZA 10X1

Código: Fábrica: Unidade:
49593 VMP PT/10
F1 F4

UN: R\$ 3,59 AV: R\$ 35,94 15: R\$ 36,69
30: R\$ 37,42 45: R\$ 38,17 60: R\$ 38,94



PAPEL CREPOM FANT ESTRELINHAS OURO 10X1

Código: Fábrica: Unidade:
49603 VMP PT/10
F1 F4

UN: R\$ 3,59 AV: R\$ 35,94 15: R\$ 36,69
30: R\$ 37,42 45: R\$ 38,17 60: R\$ 38,94



PAPEL CREPOM FANT ESTRELINHAS PRATA 10X1

Código: Fábrica: Unidade:
49605 VMP PT/10
F1 F4

UN: R\$ 3,59 AV: R\$ 35,94 15: R\$ 36,69
30: R\$ 37,42 45: R\$ 38,17 60: R\$ 38,94



PAPEL CREPOM FANT LISTRAS PRATA 10X1

Código: Fábrica: Unidade:
49604 VMP PT/10
F1 F4

UN: R\$ 3,59 AV: R\$ 35,94 15: R\$ 36,69
30: R\$ 37,42 45: R\$ 38,17 60: R\$ 38,94



PAPEL CREPOM FANT LISTRAS ROSA 10X1

Código: Fábrica: Unidade:
49606 VMP PT/10
F1 F4

UN: R\$ 4,93 AV: R\$ 49,30 15: R\$ 50,32
30: R\$ 51,33 45: R\$ 52,36 60: R\$ 53,40



PAPEL CREPOM METAL 48CMX1M AZUL CLA 10X1

Código: Fábrica: Unidade:
50273 REIPEL PT/10
F1 F4

UN: R\$ 4,93 AV: R\$ 49,30 15: R\$ 50,32
30: R\$ 51,33 45: R\$ 52,36 60: R\$ 53,40



PAPEL CREPOM METAL 48CMX1M VERDE CL 10X1

Código: Fábrica: Unidade:
50274 REIPEL PT/10
F1 F4

UN: R\$ 6,68 AV: R\$ 66,76 15: R\$ 68,15
30: R\$ 69,51 45: R\$ 70,90 60: R\$ 72,32



PAPEL CREPOM PARAFINADO OURO 10X1

Código: Fábrica: Unidade:
47707 REIPEL PT/10
F1 F4

UN: R\$ 6,68 AV: R\$ 66,76 15: R\$ 68,15
30: R\$ 69,51 45: R\$ 70,90 60: R\$ 72,32



PAPEL CREPOM PARAFINADO PRATA 10X1

Código: Fábrica: Unidade:
47708 REIPEL PT/10
F1 F4

UN: R\$ 1,50 AV: R\$ 14,99 15: R\$ 15,30
30: R\$ 15,61 45: R\$ 15,92 60: R\$ 16,24



PAPEL CREPOM 48CMX2M AMARELO CANARI 10X1

Código: Fábrica: Unidade:
18854 REPEL/ARTFLO PT/10
F1 F4

UN: R\$ 1,50 AV: R\$ 14,99 15: R\$ 15,30
30: R\$ 15,61 45: R\$ 15,92 60: R\$ 16,24



PAPEL CREPOM 48CMX2M AMARELO OURO 10X1

Código: Fábrica: Unidade:
18861 ART FLOC PT/10
F1 F4

UN: R\$ 1,50 AV: R\$ 14,99 15: R\$ 15,30
30: R\$ 15,61 45: R\$ 15,92 60: R\$ 16,24



PAPEL CREPOM 48CMX2M AMARELO SOL 10X1

Código: Fábrica: Unidade:
6953 ART FLOC PT/10
F1 F4

UN: R\$ 1,50 AV: R\$ 14,99 15: R\$ 15,30
30: R\$ 15,61 45: R\$ 15,92 60: R\$ 16,24



PAPEL CREPOM 48CMX2M AZUL CLARO 10X1

Código: Fábrica: Unidade:
18858 ARTFLOC/NOVA PT/10
F1 F4

UN: R\$ 1,50 AV: R\$ 14,99 15: R\$ 15,30
30: R\$ 15,61 45: R\$ 15,92 60: R\$ 16,24



PAPEL CREPOM 48CMX2M AZUL ESCURO 10X1

Código: Fábrica: Unidade:
18857 NOVAPRINT PT/10
F1 F4

UN: R\$ 1,50 AV: R\$ 14,99 15: R\$ 15,30
30: R\$ 15,61 45: R\$ 15,92 60: R\$ 16,24

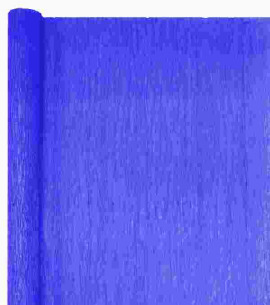

PAPEL CREPOM 48CMX2M AZUL MARINHO 10X1

Código: Fábrica: Unidade:
33198 ART FLOC PT/10
F1 F4

UN: R\$ 1,50 AV: R\$ 14,99 15: R\$ 15,30
30: R\$ 15,61 45: R\$ 15,92 60: R\$ 16,24



PAPEL CREPOM 48CMX2M AZUL PISCINA 10X1

Código: Fábrica: Unidade:
18855 ART FLOC PT/10
F1 F4

UN: R\$ 1,50 AV: R\$ 14,99 15: R\$ 15,30
30: R\$ 15,61 45: R\$ 15,92 60: R\$ 16,24

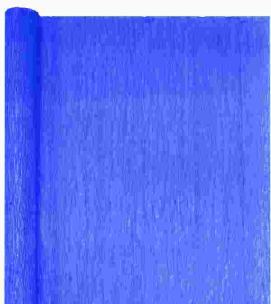

PAPEL CREPOM 48CMX2M AZUL ROYAL 10X1

Código: Fábrica: Unidade:
18856 ARTFLOC/REIP PT/10
F1 F4

UN: R\$ 1,50 AV: R\$ 14,99 15: R\$ 15,30
30: R\$ 15,61 45: R\$ 15,92 60: R\$ 16,24

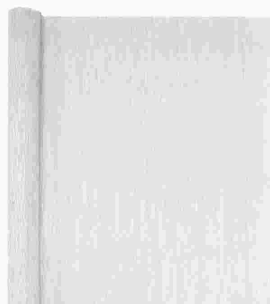

PAPEL CREPOM 48CMX2M BRANCO 10X1

Código: Fábrica: Unidade:
18865 REIPEL/ARTFL PT/10
F1 F4

UN: R\$ 1,50 AV: R\$ 14,99 15: R\$ 15,30
30: R\$ 15,61 45: R\$ 15,92 60: R\$ 16,24



PAPEL CREPOM 48CMX2M CHAMPAGNE 10X1

Código: Fábrica: Unidade:
17902 ART FLOC PT/10
F1 F4

UN: R\$ 1,50 AV: R\$ 14,99 15: R\$ 15,30
30: R\$ 15,61 45: R\$ 15,92 60: R\$ 16,24

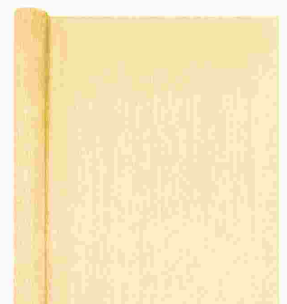

PAPEL CREPOM 48CMX2M CHAMPAGNE 10X1

Código: Fábrica: Unidade:
46887 ART FLOC PT/10
F1 F4

UN: R\$ 1,50 AV: R\$ 14,99 15: R\$ 15,30
30: R\$ 15,61 45: R\$ 15,92 60: R\$ 16,24

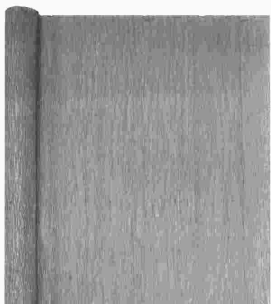

PAPEL CREPOM 48CMX2M CINZA 10X1

Código: Fábrica: Unidade:
15611 ART FLOC PT/10
F1 F4

UN: R\$ 1,49 AV: R\$ 14,94 15: R\$ 15,25
30: R\$ 15,55 45: R\$ 15,86 60: R\$ 16,18



PAPEL CREPOM 48CMX2M GELO ACINZENTA 10X1

Código: Fábrica: Unidade:
6951 VMP PT/10
F1 F4

UN: R\$ 1,50 AV: R\$ 14,99 15: R\$ 15,30
30: R\$ 15,61 45: R\$ 15,92 60: R\$ 16,24



PAPEL CREPOM 48CMX2M LARANJA 10X1

Código: Fábrica: Unidade:
18862 ARTFLOC/NOVA PT/10
F1 F4

UN: R\$ 1,50 AV: R\$ 14,99 15: R\$ 15,30
30: R\$ 15,61 45: R\$ 15,92 60: R\$ 16,24



PAPEL CREPOM 48CMX2M LILAS 10X1

Código: Fábrica: Unidade:
18869 REIPEL/ARTFL PT/10
F1 F4

UN: R\$ 1,50 AV: R\$ 14,99 15: R\$ 15,30
30: R\$ 15,61 45: R\$ 15,92 60: R\$ 16,24



PAPEL CREPOM 48CMX2M MARRON 10X1

Código: 18608 Fábrica: ARTFLOC/NOVA Unidade: PT/10 F1 F4

UN: R\$ 1,50 AV: R\$ 14,99 15: R\$ 15,30
30: R\$ 15,61 45: R\$ 15,92 60: R\$ 16,24



PAPEL CREPOM 48CMX2M PRETO 10X1

Código: 18864 Fábrica: ARTFLOC/NOVA Unidade: PT/10 F1 F4

UN: R\$ 1,50 AV: R\$ 14,99 15: R\$ 15,30
30: R\$ 15,61 45: R\$ 15,92 60: R\$ 16,24



PAPEL CREPOM 48CMX2M ROSA CLARO 10X1

Código: 18851 Fábrica: ARTFLOC%NOVA Unidade: PT/10 F1 F4

UN: R\$ 1,50 AV: R\$ 14,99 15: R\$ 15,30
30: R\$ 15,61 45: R\$ 15,92 60: R\$ 16,24



PAPEL CREPOM 48CMX2M ROSA PINK 10X1

Código: 18850 Fábrica: REIPEL/ARTFL Unidade: PT/10 F1 F4

UN: R\$ 1,50 AV: R\$ 14,99 15: R\$ 15,30
30: R\$ 15,61 45: R\$ 15,92 60: R\$ 16,24



PAPEL CREPOM 48CMX2M ROSA 10X1

Código: 18852 Fábrica: ART FLOC Unidade: PT/10 F1 F4

UN: R\$ 1,50 AV: R\$ 14,99 15: R\$ 15,30
30: R\$ 15,61 45: R\$ 15,92 60: R\$ 16,24

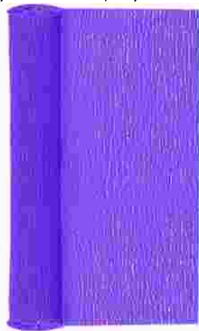

PAPEL CREPOM 48CMX2M ROXO 10X1

Código: 15612 Fábrica: ARTFLOC/NOVA Unidade: PT/10 F1 F4

UN: R\$ 1,50 AV: R\$ 14,99 15: R\$ 15,30
30: R\$ 15,61 45: R\$ 15,92 60: R\$ 16,24



PAPEL CREPOM 48CMX2M SALMAO CLARO 10X1

Código: 42595 Fábrica: ART FLOC Unidade: PT/10 F1 F4

UN: R\$ 1,50 AV: R\$ 14,99 15: R\$ 15,30
30: R\$ 15,61 45: R\$ 15,92 60: R\$ 16,24



PAPEL CREPOM 48CMX2M SALMAO 10X1

Código: 18853 Fábrica: ART FLOC Unidade: PT/10 F1 F4

UN: R\$ 1,50 AV: R\$ 60,08 15: R\$ 61,33
30: R\$ 62,56 45: R\$ 63,81 60: R\$ 65,09



PAPEL CREPOM 48CMX2M SORT 40X1

Código: 41888 Fábrica: ART FLOC Unidade: PT/40 F1 F4

UN: R\$ 1,50 AV: R\$ 14,99 15: R\$ 15,30
30: R\$ 15,61 45: R\$ 15,92 60: R\$ 16,24



PAPEL CREPOM 48CMX2M SORTIDO 10X1

Código: 42140 Fábrica: ART FLOC Unidade: PT/10 F1 F4

UN: R\$ 1,50 AV: R\$ 14,99 15: R\$ 15,30
30: R\$ 15,61 45: R\$ 15,92 60: R\$ 16,24



PAPEL CREPOM 48CMX2M VERDE BANDEIRA 10X1

Código: 18868 Fábrica: REIPEL/ARTFL Unidade: PT/10 F1 F4

UN: R\$ 1,50 AV: R\$ 14,99 15: R\$ 15,30
30: R\$ 15,61 45: R\$ 15,92 60: R\$ 16,24



PAPEL CREPOM 48CMX2M VERDE FOLHA 10X1

Código: 18867 Fábrica: ARTFLOC/NOVA Unidade: PT/10 F1 F4

UN: R\$ 1,50 AV: R\$ 14,99 15: R\$ 15,30
30: R\$ 15,61 45: R\$ 15,92 60: R\$ 16,24



PAPEL CREPOM 48CMX2M VERDE FOSCO 10X1

Código: 42597 Fábrica: ART FLOC Unidade: PT/10 F1 F4

UN: R\$ 1,50 AV: R\$ 14,99 15: R\$ 15,30
30: R\$ 15,61 45: R\$ 15,92 60: R\$ 16,24



PAPEL CREPOM 48CMX2M VERDE LIMA 10X1

Código: 6954 Fábrica: ART FLOC Unidade: PT/10 F1 F4

UN: R\$ 1,50 AV: R\$ 14,99 15: R\$ 15,30
30: R\$ 15,61 45: R\$ 15,92 60: R\$ 16,24



PAPEL CREPOM 48CMX2M VERDE LIMAO 10X1

Código: 18866 Fábrica: ART FLOC Unidade: PT/10 F1 F4

UN: R\$ 1,50 AV: R\$ 14,99 15: R\$ 15,30
30: R\$ 15,61 45: R\$ 15,92 60: R\$ 16,24



PAPEL CREPOM 48CMX2M VERDE MUSGO 10X1

Código: 6960 Fábrica: ART FLOC Unidade: PT/10 F1 F4

UN: R\$ 1,50 AV: R\$ 14,99 15: R\$ 15,30
30: R\$ 15,61 45: R\$ 15,92 60: R\$ 16,24



PAPEL CREPOM 48CMX2M VERMELHO 10X1

Código: 18863 Fábrica: REIPE/ARTFLO Unidade: PT/10 F1 F4

UN: R\$ 1,50 AV: R\$ 14,99 15: R\$ 15,30
30: R\$ 15,61 45: R\$ 15,92 60: R\$ 16,24



PAPEL CREPOM 48CMX2M VINHO 10X1

Código: 6947 Fábrica: ART FLOC Unidade: PT/10 F1 F4

UN: R\$ 1,50 AV: R\$ 14,99 15: R\$ 15,30
30: R\$ 15,61 45: R\$ 15,92 60: R\$ 16,24



PAPEL CREPOM 48CMX2M VIOLETA 10X1

Código: 18859 Fábrica: ART FLOC Unidade: PT/10 F1 F4

UN: R\$ 0,72 AV: R\$ 71,89 15: R\$ 73,39
30: R\$ 74,86 45: R\$ 76,36 60: R\$ 77,88



PAPEL FANTAS/DOBR 50X60CM AMARELO 100X1

Código: 15114 Fábrica: VMP/MILPEL Unidade: CE/100 F1 F4

UN: R\$ 0,72 AV: R\$ 71,89 15: R\$ 73,39
30: R\$ 74,86 45: R\$ 76,36 60: R\$ 77,88



PAPEL FANTAS/DOBR 50X60CM AZUL CLA 100X1

Código: 10107 Fábrica: VMP/MILPEL Unidade: CE/100 F1 F4

UN: R\$ 0,72 AV: R\$ 71,89 15: R\$ 73,39
30: R\$ 74,86 45: R\$ 76,36 60: R\$ 77,88



PAPEL FANTAS/DOBR 50X60CM AZUL ESC 100X1

Código: 46914 Fábrica: VMP Unidade: CE/100 F1 F4

UN: R\$ 0,72 AV: R\$ 71,89 15: R\$ 73,39
30: R\$ 74,86 45: R\$ 76,36 60: R\$ 77,88



PAPEL FANTAS/DOBR 50X60CM BRANCO 100X1

Código: 16639 Fábrica: VMP/MILP Unidade: CE/100 F1 F4

UN: R\$ 0,72 AV: R\$ 71,89 15: R\$ 73,39
30: R\$ 74,86 45: R\$ 76,36 60: R\$ 77,88



PAPEL FANTAS/DOBR 50X60CM LARANJA 100X1

Código: 10108 Fábrica: VMP/MILPEL Unidade: CE/100 F1 F4

UN: R\$ 0,72 AV: R\$ 71,89 15: R\$ 73,39
30: R\$ 74,86 45: R\$ 76,36 60: R\$ 77,88



PAPEL FANTAS/DOBR 50X60CM MARRM 100X1

Código: 40755 Fábrica: VMP/MILPEL Unidade: CE/100 F1 F4

UN: R\$ 0,72 AV: R\$ 71,89 15: R\$ 73,39
30: R\$ 74,86 45: R\$ 76,36 60: R\$ 77,88



PAPEL FANTAS/DOBR 50X60CM PRETO 100X1

Código: 17058 Fábrica: VMP Unidade: CE/100 F1 F4

UN: R\$ 0,72 AV: R\$ 71,89 15: R\$ 73,39
30: R\$ 74,86 45: R\$ 76,36 60: R\$ 77,88



PAPEL FANTAS/DOBR 50X60CM ROSA PIN 100X1

Código: 10109 Fábrica: VMP/MILPEL Unidade: CE/100 F1 F4

UN: R\$ 0,72 AV: R\$ 71,89 15: R\$ 73,39
30: R\$ 74,86 45: R\$ 76,36 60: R\$ 77,88



PAPEL FANTAS/DOBR 50X60CM VERDE BD100X1

Código: 15269 Fábrica: VMP/MILPEL Unidade: CE/100 F1 F4

UN: R\$ 0,72 AV: R\$ 71,89 15: R\$ 73,39
30: R\$ 74,86 45: R\$ 76,36 60: R\$ 77,88



PAPEL FANTAS/DOBR 50X60CM VERMELHO 100X1

Código: 44193 Fábrica: VMP/MILPEL Unidade: CE/100 F1 F4

UN: R\$ 71,89 AV: R\$ 71,89 15: R\$ 73,39
30: R\$ 74,86 45: R\$ 76,36 60: R\$ 77,88



PAPEL FANTASIA 48X60CM 100X1 SORTIDO

Código: 6658 Fábrica: MILPEL Unidade: CE/1 F1 F4

UN: R\$ 1,64 AV: R\$ 32,86 15: R\$ 33,54
30: R\$ 34,22 45: R\$ 34,90 60: R\$ 35,60



PAPEL FOTO A3 130GRS ADESIVO 20X1

Código: 45265 Fábrica: MASTERPRINT Unidade: PT/20 F1 F4

UN: R\$ 1,44 AV: R\$ 28,75 15: R\$ 29,35
30: R\$ 29,94 45: R\$ 30,54 60: R\$ 31,15

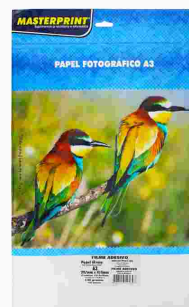

PAPEL FOTO A3 135GRS ADESIVO 10X1

Código: 48908 Fábrica: MASTERPRINT Unidade: PT/20 F1 F4

UN: R\$ 0,98 AV: R\$ 19,51 15: R\$ 19,91
30: R\$ 20,31 45: R\$ 20,72 60: R\$ 21,13



PAPER FOTO A3 180GR 20X1
Código: Fábrica: Unidade:
29748 MASTERPRINT PT/20
F1 F4

UN: R\$ 1,36 AV: R\$ 27,17 15: R\$ 27,74
30: R\$ 28,29 45: R\$ 28,86 60: R\$ 29,43



PAPER FOTO A3 180GRS DUPLA FACE 20X1
Código: Fábrica: Unidade:
46068 MASTERPRINT PT/20
F1 F4

UN: R\$ 0,28 AV: R\$ 28,14 15: R\$ 28,72
30: R\$ 29,30 45: R\$ 29,88 60: R\$ 30,48



PAPER FOTO A4 90GR MATTE FOSCO 100X1
Código: Fábrica: Unidade:
45154 MASTERPRINT PT/100
F1 F4

UN: R\$ 0,77 AV: R\$ 15,40 15: R\$ 15,72
30: R\$ 16,03 45: R\$ 16,35 60: R\$ 16,68



PAPER FOTO A4 115GR ADESIVO 20X1
Código: Fábrica: Unidade:
45111 MASTERPRINT PT/20
F1 F4

UN: R\$ 0,39 AV: R\$ 7,80 15: R\$ 7,96
30: R\$ 8,12 45: R\$ 8,28 60: R\$ 8,45

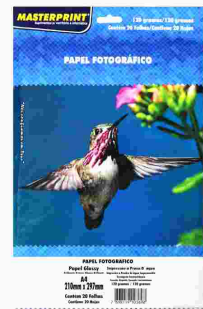

PAPER FOTO A4 115GR 20X1
Código: Fábrica: Unidade:
45266 MASTERPRINT PT/20
F1 F4

UN: R\$ 0,40 AV: R\$ 19,89 15: R\$ 20,30
30: R\$ 20,71 45: R\$ 21,12 60: R\$ 21,54



PAPER FOTO A4 115GR 50X1
Código: Fábrica: Unidade:
45110 MASTERPRINT PT/50
F1 F4

UN: R\$ 0,77 AV: R\$ 15,40 15: R\$ 15,72
30: R\$ 16,03 45: R\$ 16,35 60: R\$ 16,68



PAPER FOTO A4 130GR ADESIVO 20X1
Código: Fábrica: Unidade:
29747 MASTERPRINT PT/20
F1 F4

UN: R\$ 0,74 AV: R\$ 36,97 15: R\$ 37,74
30: R\$ 38,49 45: R\$ 39,26 60: R\$ 40,05

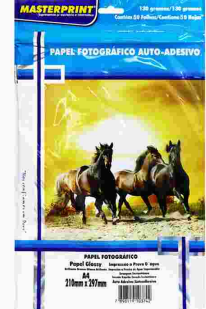

PAPER FOTO A4 130GR ADESIVO 50X1
Código: Fábrica: Unidade:
38238 MASTERPRINT PT/50
F1 F4

UN: R\$ 0,37 AV: R\$ 18,48 15: R\$ 18,86
30: R\$ 19,24 45: R\$ 19,63 60: R\$ 20,02



PAPER FOTO A4 135GR 50X1
Código: Fábrica: Unidade:
45112 MASTERPRINT PT/50
F1 F4

UN: R\$ 0,40 AV: R\$ 20,18 15: R\$ 20,61
30: R\$ 21,02 45: R\$ 21,44 60: R\$ 21,87

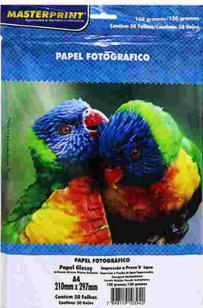

PAPER FOTO A4 150GR 50X1
Código: Fábrica: Unidade:
42234 MASTERPRINT PT/50
F1 F4

UN: R\$ 0,65 AV: R\$ 32,41 15: R\$ 33,08
30: R\$ 33,75 45: R\$ 34,42 60: R\$ 35,11



PAPER FOTO A4 180GR BRILHOSO 50X1
Código: Fábrica: Unidade:
48347 YIN'S PAPER PT/50
F1 F4

UN: R\$ 0,43 AV: R\$ 21,56 15: R\$ 22,01
30: R\$ 22,45 45: R\$ 22,90 60: R\$ 23,36



PAPER FOTO A4 180GR 50X1
Código: Fábrica: Unidade:
37956 MASTERPRINT PT/50
F1 F4

UN: R\$ 0,25 AV: R\$ 5,02 15: R\$ 5,13
30: R\$ 5,23 45: R\$ 5,33 60: R\$ 5,44

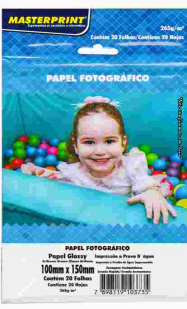

PAPER FOTO 10X15CM 265GRS GLOSSY 20X1
Código: Fábrica: Unidade:
50006 MASTERPRINT PT/20
F1 F4

UN: R\$ 35,94 AV: R\$ 35,94 15: R\$ 36,69
30: R\$ 37,42 45: R\$ 38,17 60: R\$ 38,94



PAPER HIGIENICO 10CMX30M FOLHA DUPL 16X1
Código: Fábrica: Unidade:
48510 NOBRE PT/1
F1 F4

UN: R\$ 0,21 AV: R\$ 5,13 15: R\$ 5,23
30: R\$ 5,34 45: R\$ 5,44 60: R\$ 5,55



PAPER KRAFT A4 240 GRS FILIPAPER 25X1
Código: Fábrica: Unidade:
34263 FILIPAPER PT/25
F1 F4

UN: R\$ 0,31 AV: R\$ 15,40 15: R\$ 15,72
30: R\$ 16,03 45: R\$ 16,35 60: R\$ 16,68



PAPER KRAFT A4 180GR ARTESANATO 50X1
Código: Fábrica: Unidade:
45113 MASTERPRINT PT/50
F1 F4

UN: R\$ 0,90 AV: R\$ 225,97 15: R\$ 230,68
30: R\$ 235,30 45: R\$ 240,00 60: R\$ 244,80



PAPEL KRAFT BIGNARD 80GX660MMX96CM 250X1
Código: Fábrica: Unidade:
41855 MGPAPEL PT/250
F1 F4

UN: R\$ 277,33 AV: R\$ 277,33 15: R\$ 283,11
30: R\$ 288,77 45: R\$ 294,55 60: R\$ 300,44



PAPEL KRAFT BOB 80GRS 120CM 150MTS
Código: Fábrica: Unidade:
41850 MGPAPEL RL/1
F1 F4

UN: R\$ 102,71 AV: R\$ 102,71 15: R\$ 104,85
30: R\$ 106,95 45: R\$ 109,09 60: R\$ 111,27

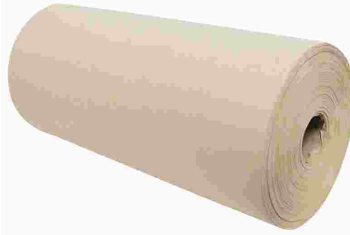

PAPEL KRAFT BOB 80GRS 40CM 140MTS 4,5KG
Código: Fábrica: Unidade:
45743 JUSSARA RL/1
F1 F4

UN: R\$ 106,32 AV: R\$ 106,32 15: R\$ 108,53
30: R\$ 110,70 45: R\$ 112,91 60: R\$ 115,17



PAPEL KRAFT BOB 100GRS 100CM 100MTS
Código: Fábrica: Unidade:
44621 RITZ RL/1
F1 F4

UN: R\$ 125,31 AV: R\$ 125,31 15: R\$ 127,92
30: R\$ 130,48 45: R\$ 133,09 60: R\$ 135,75



PAPEL KRAFT NAT BOB 60GRS 60CM 140MTS
Código: Fábrica: Unidade:
47720 REIPEL RL/1
F1 F4

UN: R\$ 1,22 AV: R\$ 48,79 15: R\$ 49,81
30: R\$ 50,80 45: R\$ 51,82 60: R\$ 52,86



PAPEL LAMINADO AZUL 49X59CM 40X1
Código: Fábrica: Unidade:
6902 EMBALE PT/40
F1 F4

UN: R\$ 1,10 AV: R\$ 10,99 15: R\$ 11,22
30: R\$ 11,44 45: R\$ 11,67 60: R\$ 11,91



PAPEL LAMINADO A4 250GR AZUL 10X1
Código: Fábrica: Unidade:
48909 MASTERPRINT PT/10
F1 F4

UN: R\$ 1,10 AV: R\$ 10,99 15: R\$ 11,22
30: R\$ 11,44 45: R\$ 11,67 60: R\$ 11,91



PAPEL LAMINADO A4 250GR COBRE 10X1
Código: Fábrica: Unidade:
48910 MASTERPRINT PT/10
F1 F4

UN: R\$ 1,10 AV: R\$ 10,99 15: R\$ 11,22
30: R\$ 11,44 45: R\$ 11,67 60: R\$ 11,91



PAPEL LAMINADO A4 250GR PRATA 10X1
Código: Fábrica: Unidade:
48912 MASTERPRINT PT/10
F1 F4

UN: R\$ 1,10 AV: R\$ 10,99 15: R\$ 11,22
30: R\$ 11,44 45: R\$ 11,67 60: R\$ 11,91



PAPEL LAMINADO A4 250GR ROSA 10X1
Código: Fábrica: Unidade:
48915 MASTERPRINT PT/10
F1 F4

UN: R\$ 1,10 AV: R\$ 10,99 15: R\$ 11,22
30: R\$ 11,44 45: R\$ 11,67 60: R\$ 11,91



PAPEL LAMINADO A4 250GR ROSE GOLD 10X1
Código: Fábrica: Unidade:
48914 MASTERPRINT PT/10
F1 F4

UN: R\$ 1,10 AV: R\$ 10,99 15: R\$ 11,22
30: R\$ 11,44 45: R\$ 11,67 60: R\$ 11,91



PAPEL LAMINADO A4 250GR VERDE 10X1
Código: Fábrica: Unidade:
48911 MASTERPRINT PT/10
F1 F4

UN: R\$ 1,10 AV: R\$ 10,99 15: R\$ 11,22
30: R\$ 11,44 45: R\$ 11,67 60: R\$ 11,91



PAPEL LAMINADO A4 250GR VERMELHO 10X1
Código: Fábrica: Unidade:
48913 MASTERPRINT PT/10
F1 F4

UN: R\$ 1,22 AV: R\$ 48,79 15: R\$ 49,81
30: R\$ 50,80 45: R\$ 51,82 60: R\$ 52,86



PAPEL LAMINADO DOURADO 49X59CM 40X1
Código: Fábrica: Unidade:
18195 EMBALE PT/40
F1 F4

UN: R\$ 1,03 AV: R\$ 41,08 15: R\$ 41,93
30: R\$ 42,77 45: R\$ 43,63 60: R\$ 44,50



PAPEL LAMINADO PRATA 49X59CM 40X1
Código: Fábrica: Unidade:
6151 EMBALE PT/40
F1 F4

UN: R\$ 1,22 AV: R\$ 48,79 15: R\$ 49,81
30: R\$ 50,80 45: R\$ 51,82 60: R\$ 52,86

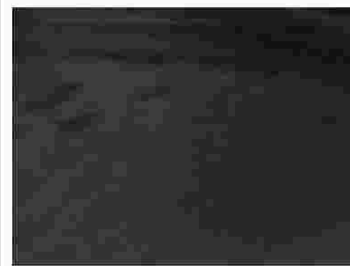

PAPEL LAMINADO PRETO 48X58CM 40X1
Código: Fábrica: Unidade:
21501 EMBALE PT/40
F1 F4

UN: R\$ 1,22 AV: R\$ 48,79 15: R\$ 49,81
30: R\$ 50,80 45: R\$ 51,82 60: R\$ 52,86



PAPEL LAMINADO ROSA PINK 49X59CM 40X1
Código: Fábrika: Unidade:
19601 EMBALE PT/40
F1 F4

UN: R\$ 1,22 AV: R\$ 48,79 15: R\$ 49,81
30: R\$ 50,80 45: R\$ 51,82 60: R\$ 52,86



PAPEL LAMINADO VERDE 49X59CM 40X1
Código: Fábrika: Unidade:
12203 EMBALE PT/40
F1 F4

UN: R\$ 1,22 AV: R\$ 48,79 15: R\$ 49,81
30: R\$ 50,80 45: R\$ 51,82 60: R\$ 52,86



PAPEL LAMINADO VERMELHO 49X59CM 40X1
Código: Fábrika: Unidade:
12202 EMBALE PT/40
F1 F4

UN: R\$ 0,37 AV: R\$ 18,48 15: R\$ 18,86
30: R\$ 19,24 45: R\$ 19,63 60: R\$ 20,02



PAPEL LINHO A4 180GR BRANCO 50X1
Código: Fábrika: Unidade:
41361 USUAL PT/50
F1 F4

UN: R\$ 0,39 AV: R\$ 19,51 15: R\$ 19,91
30: R\$ 20,31 45: R\$ 20,72 60: R\$ 21,13



PAPEL LINHO A4 180GR CREME 50X1
Código: Fábrika: Unidade:
45788 USAPEL PT/50
F1 F4

UN: R\$ 0,39 AV: R\$ 19,51 15: R\$ 19,91
30: R\$ 20,31 45: R\$ 20,72 60: R\$ 21,13



PAPEL LINHO A4 180GR PALHA 50X1
Código: Fábrika: Unidade:
41362 USAPEL PT/50
F1 F4

UN: R\$ 0,13 AV: R\$ 6,68 15: R\$ 6,82
30: R\$ 6,95 45: R\$ 7,09 60: R\$ 7,23

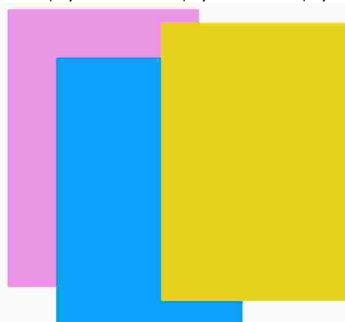

PAPEL LUMINI A4 75GR SORT 50X1
Código: Fábrika: Unidade:
35898 AGAPE PT/50
F1 F4

UN: R\$ 0,29 AV: R\$ 14,53 15: R\$ 14,84
30: R\$ 15,13 45: R\$ 15,44 60: R\$ 15,75



PAPEL LUMINI A4 80GR SORT 40X1
Código: Fábrika: Unidade:
47258 MINAPEL PT/50
F1 F4

UN: R\$ 24,19 AV: R\$ 24,19 15: R\$ 24,69
30: R\$ 25,19 45: R\$ 25,69 60: R\$ 26,21



PAPEL MACHE 100 GRS S/COR
Código: Fábrika: Unidade:
41983 ACRILEX PT/1
F1 F4

UN: R\$ 79,09 AV: R\$ 79,09 15: R\$ 80,74
30: R\$ 82,36 45: R\$ 84,00 60: R\$ 85,68

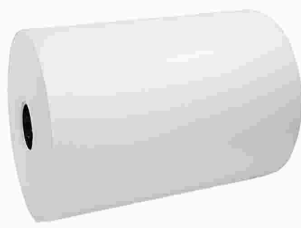

PAPEL MANILHA STRONG BOB 25CM 250 MTS
Código: Fábrika: Unidade:
43625 STRONG RL/1
F1 F4

UN: R\$ 133,53 AV: R\$ 133,53 15: R\$ 136,31
30: R\$ 139,03 45: R\$ 141,81 60: R\$ 144,65

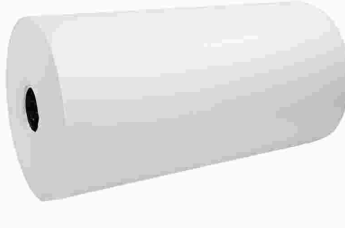

PAPEL MANILHA STRONG BOB 40CM 250 MTS
Código: Fábrika: Unidade:
43626 STRONG RL/1
F1 F4

UN: R\$ 211,60 AV: R\$ 211,60 15: R\$ 216,01
30: R\$ 220,33 45: R\$ 224,74 60: R\$ 229,23

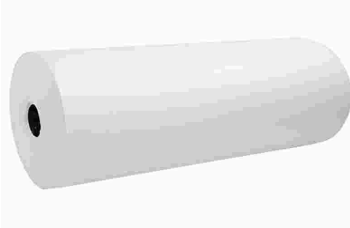

PAPEL MANILHA STRONG BOB 60CM 250 MTS
Código: Fábrika: Unidade:
43627 STRONG RL/1
F1 F4

UN: R\$ 5,13 AV: R\$ 51,35 15: R\$ 52,42
30: R\$ 53,47 45: R\$ 54,54 60: R\$ 55,63

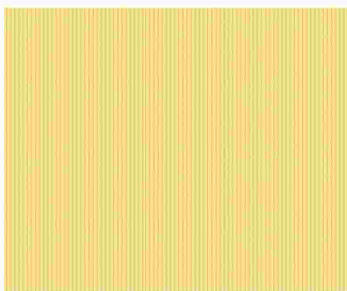

PAPEL MICROONDULADO AMARELO 48X80CM 10X1
Código: Fábrika: Unidade:
3277 REIPEL/VMP PT/10
F1 F4

UN: R\$ 5,13 AV: R\$ 51,35 15: R\$ 52,42
30: R\$ 53,47 45: R\$ 54,54 60: R\$ 55,63

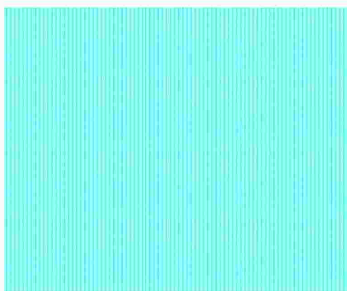

PAPEL MICROONDULADO AZUL CL 48X80CM 10X1
Código: Fábrika: Unidade:
47712 REIPEL PT/10
F1 F4

UN: R\$ 5,13 AV: R\$ 51,35 15: R\$ 52,42
30: R\$ 53,47 45: R\$ 54,54 60: R\$ 55,63

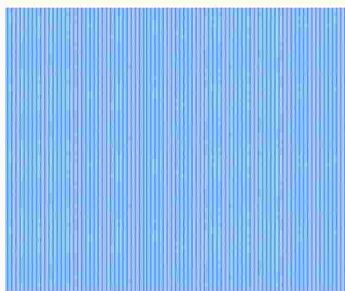

PAPEL MICROONDULADO AZUL ES 48X80CM 10X1
Código: Fábrika: Unidade:
47710 REIPEL PT/10
F1 F4

UN: R\$ 5,13 AV: R\$ 51,35 15: R\$ 52,42
30: R\$ 53,47 45: R\$ 54,54 60: R\$ 55,63

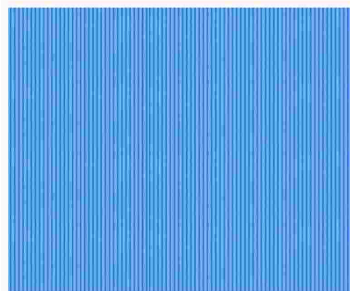

PAPEL MICROONDULADO AZUL 50X80CM 10X1
Código: Fábrika: Unidade:
28181 VMP PT/10
F1 F4

UN: R\$ 5,13 AV: R\$ 51,35 15: R\$ 52,42
30: R\$ 53,47 45: R\$ 54,54 60: R\$ 55,63

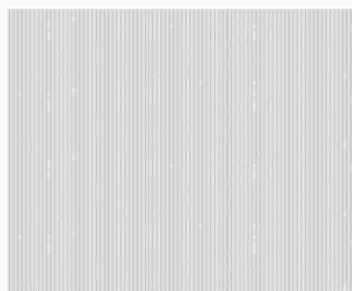

PAPEL MICROONDULADO BRANCO 48X80CM 10X1
Código: 34394 Fábrica: VMP/REIPEL Unidade: PT/10 F1 F4

UN: R\$ 5,13 AV: R\$ 51,35 15: R\$ 52,42
30: R\$ 53,47 45: R\$ 54,54 60: R\$ 55,63



PAPEL MICROONDULADO ESTAMP 50X80CM 10X1
Código: 42383 Fábrica: RST Unidade: PT/10 F1 F4

UN: R\$ 5,13 AV: R\$ 51,35 15: R\$ 52,42
30: R\$ 53,47 45: R\$ 54,54 60: R\$ 55,63

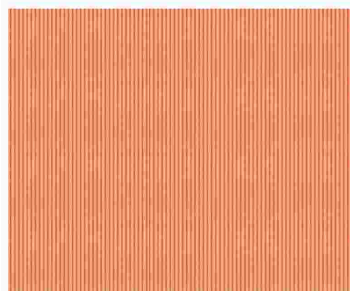

PAPEL MICROONDULADO LARANJA 50X80CM 10X1
Código: 34395 Fábrica: REIPEL/VMP Unidade: PT/10 F1 F4

UN: R\$ 5,13 AV: R\$ 51,35 15: R\$ 52,42
30: R\$ 53,47 45: R\$ 54,54 60: R\$ 55,63

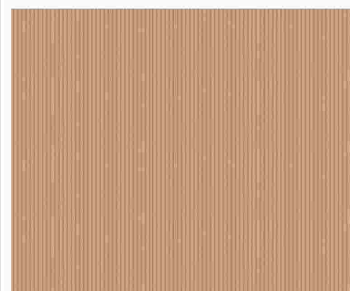

PAPEL MICROONDULADO MARROM 48X80CM 10X1
Código: 47709 Fábrica: REIPEL Unidade: PT/10 F1 F4

UN: R\$ 5,13 AV: R\$ 51,35 15: R\$ 52,42
30: R\$ 53,47 45: R\$ 54,54 60: R\$ 55,63

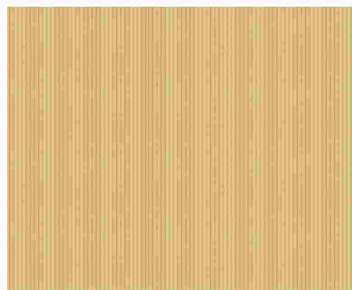

PAPEL MICROONDULADO OURO 48X80CM 10X1
Código: 47714 Fábrica: REIPEL Unidade: PT/10 F1 F4

UN: R\$ 5,13 AV: R\$ 51,35 15: R\$ 52,42
30: R\$ 53,47 45: R\$ 54,54 60: R\$ 55,63

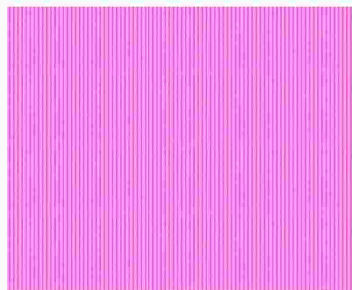

PAPEL MICROONDULADO PINK 48X80CM 10X1
Código: 47711 Fábrica: REIPEL Unidade: PT/10 F1 F4

UN: R\$ 5,13 AV: R\$ 51,35 15: R\$ 52,42
30: R\$ 53,47 45: R\$ 54,54 60: R\$ 55,63

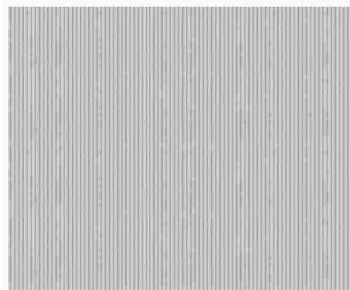

PAPEL MICROONDULADO PRATA 48X80CM 10X1
Código: 47715 Fábrica: REIPEL Unidade: PT/10 F1 F4

UN: R\$ 5,13 AV: R\$ 51,35 15: R\$ 52,42
30: R\$ 53,47 45: R\$ 54,54 60: R\$ 55,63

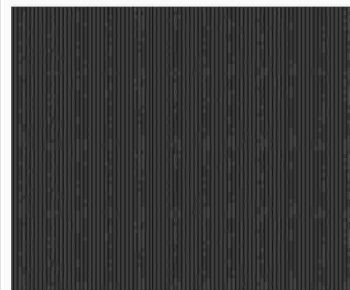

PAPEL MICROONDULADO PRETO 48X80CM 10X1
Código: 34396 Fábrica: REIPEL/VMP Unidade: PT/10 F1 F4

UN: R\$ 5,13 AV: R\$ 51,35 15: R\$ 52,42
30: R\$ 53,47 45: R\$ 54,54 60: R\$ 55,63

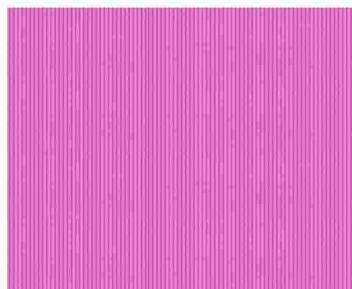

PAPEL MICROONDULADO ROSA 50X80CM 10X1
Código: 4050 Fábrica: REIPEL/VMP Unidade: PT/10 F1 F4

UN: R\$ 5,13 AV: R\$ 51,35 15: R\$ 52,42
30: R\$ 53,47 45: R\$ 54,54 60: R\$ 55,63



PAPEL MICROONDULADO ROXO 50X80CM 10X1
Código: 34397 Fábrica: VMP Unidade: PT/10 F1 F4

UN: R\$ 5,13 AV: R\$ 51,35 15: R\$ 52,42
30: R\$ 53,47 45: R\$ 54,54 60: R\$ 55,63

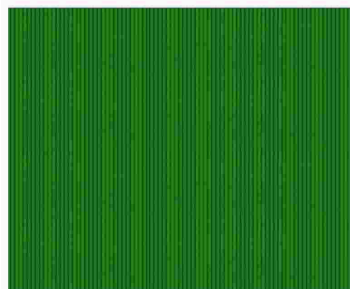

PAPEL MICROONDULADO VERDE B 48X80CM 10X1
Código: 6901 Fábrica: REIPEL/VMP Unidade: PT/10 F1 F4

UN: R\$ 5,13 AV: R\$ 51,35 15: R\$ 52,42
30: R\$ 53,47 45: R\$ 54,54 60: R\$ 55,63

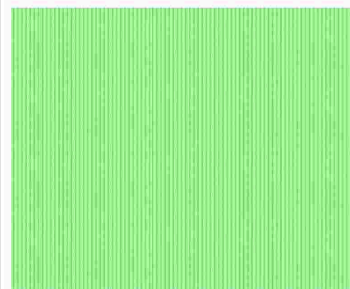

PAPEL MICROONDULADO VERDE C 48X80CM 10X1
Código: 47713 Fábrica: REIPEL Unidade: PT/10 F1 F4

UN: R\$ 5,13 AV: R\$ 51,35 15: R\$ 52,42
30: R\$ 53,47 45: R\$ 54,54 60: R\$ 55,63



PAPEL MICROONDULADO VERMELH 48X80CM 10X1
Código: 19220 Fábrica: REIPEL/VMP Unidade: PT/10 F1 F4

UN: R\$ 698,39 AV: R\$ 698,39 15: R\$ 712,94
30: R\$ 727,20 45: R\$ 741,75 60: R\$ 756,58



PAPEL NACARADO BOB TRANSP 90CMX100MTS
Código: 45815 Fábrica: CROMUS Unidade: UN/1 F1 F4

UN: R\$ 0,99 AV: R\$ 19,72 15: R\$ 20,13
30: R\$ 20,54 45: R\$ 20,95 60: R\$ 21,37



PAPEL OFF PLUS A4 180GR VERDE 20X1
Código: 45890 Fábrica: OFF PAPER Unidade: PT/20 F1 F4

UN: R\$ 0,99 AV: R\$ 19,72 15: R\$ 20,13
30: R\$ 20,54 45: R\$ 20,95 60: R\$ 21,37



PAPEL OFF PLUS A4 180GR AMARELO 20X1
Código: 45886 Fábrica: OFF PAPER Unidade: PT/20 F1 F4

UN: R\$ 0,99 AV: R\$ 19,72 15: R\$ 20,13
30: R\$ 20,54 45: R\$ 20,95 60: R\$ 21,37



PAPÉL OFF PLUS A4 180GR AZUL 20X1
Código: 45607 Fábrica: OFF PAPER Unidade: PT/20
F1 F4

UN: R\$ 0,99 AV: R\$ 19,72 15: R\$ 20,13
30: R\$ 20,54 45: R\$ 20,95 60: R\$ 21,37



PAPÉL OFF PLUS A4 180GR PRETO 20X1
Código: 45889 Fábrica: OFF PAPER Unidade: PT/20
F1 F4

UN: R\$ 0,99 AV: R\$ 19,72 15: R\$ 20,13
30: R\$ 20,54 45: R\$ 20,95 60: R\$ 21,37



PAPÉL OFF PLUS A4 180GR VERMELHO 20X1
Código: 45888 Fábrica: OFF PAPER Unidade: PT/20
F1 F4

UN: R\$ 0,48 AV: R\$ 9,66 15: R\$ 9,86
30: R\$ 10,05 45: R\$ 10,26 60: R\$ 10,46



PAPÉL OPALINE A4 120GR 40KG AMARELO 20X1
Código: 48919 Fábrica: MASTERPRINT Unidade: PT/20
F1 F4

UN: R\$ 0,48 AV: R\$ 9,66 15: R\$ 9,86
30: R\$ 10,05 45: R\$ 10,26 60: R\$ 10,46



PAPÉL OPALINE A4 120GR 40KG AZUL 20X1
Código: 48930 Fábrica: MASTERPRINT Unidade: PT/20
F1 F4

UN: R\$ 0,31 AV: R\$ 15,40 15: R\$ 15,72
30: R\$ 16,03 45: R\$ 16,35 60: R\$ 16,68



PAPÉL OPALINE A4 120GR 40KG BRANCO 50X1
Código: 45127 Fábrica: MASTERPRINT Unidade: PT/50
F1 F4

UN: R\$ 0,48 AV: R\$ 9,66 15: R\$ 9,86
30: R\$ 10,05 45: R\$ 10,26 60: R\$ 10,46



PAPÉL OPALINE A4 120GR 40KG CINZA 20X1
Código: 48924 Fábrica: MASTERPRINT Unidade: PT/20
F1 F4

UN: R\$ 0,48 AV: R\$ 9,66 15: R\$ 9,86
30: R\$ 10,05 45: R\$ 10,26 60: R\$ 10,46



PAPÉL OPALINE A4 120GR 40KG LARANJA 20X1
Código: 48931 Fábrica: MASTERPRINT Unidade: PT/20
F1 F4

UN: R\$ 0,48 AV: R\$ 9,66 15: R\$ 9,86
30: R\$ 10,05 45: R\$ 10,26 60: R\$ 10,46



PAPÉL OPALINE A4 120GR 40KG OURO 20X1
Código: 48925 Fábrica: MASTERPRINT Unidade: PT/20
F1 F4

UN: R\$ 0,48 AV: R\$ 9,66 15: R\$ 9,86
30: R\$ 10,05 45: R\$ 10,26 60: R\$ 10,46



PAPÉL OPALINE A4 120GR 40KG PRETO 20X1
Código: 48926 Fábrica: MASTERPRINT Unidade: PT/20
F1 F4

UN: R\$ 0,48 AV: R\$ 9,66 15: R\$ 9,86
30: R\$ 10,05 45: R\$ 10,26 60: R\$ 10,46



PAPÉL OPALINE A4 120GR 40KG ROSA 20X1
Código: 48929 Fábrica: MASTERPRINT Unidade: PT/20
F1 F4

UN: R\$ 0,48 AV: R\$ 9,66 15: R\$ 9,86
30: R\$ 10,05 45: R\$ 10,26 60: R\$ 10,46



PAPÉL OPALINE A4 120GR 40KG ROXO 20X1
Código: 48928 Fábrica: MASTERPRINT Unidade: PT/20
F1 F4

UN: R\$ 0,48 AV: R\$ 9,66 15: R\$ 9,86
30: R\$ 10,05 45: R\$ 10,26 60: R\$ 10,46



PAPÉL OPALINE A4 120GR 40KG VERDE 20X1
Código: 48932 Fábrica: MASTERPRINT Unidade: PT/20
F1 F4

UN: R\$ 0,48 AV: R\$ 9,66 15: R\$ 9,86
30: R\$ 10,05 45: R\$ 10,26 60: R\$ 10,46



PAPÉL OPALINE A4 120GR 40KG VERM 20X1
Código: 48927 Fábrica: MASTERPRINT Unidade: PT/20
F1 F4

UN: R\$ 0,37 AV: R\$ 18,27 15: R\$ 18,65
30: R\$ 19,03 45: R\$ 19,41 60: R\$ 19,80



PAPÉL OPALINE A4 120GR 40KG 10CORES 50X1
Código: 48918 Fábrica: MASTERPRINT Unidade: PT/50
F1 F4

UN: R\$ 0,45 AV: R\$ 22,27 15: R\$ 22,73
30: R\$ 23,19 45: R\$ 23,65 60: R\$ 24,13



PAPÉL OPALINE A4 180GR 60KG AMARELO 50X1
Código: 45989 Fábrica: MASTERPRINT Unidade: PT/50
F1 F4

UN: R\$ 0,45 AV: R\$ 22,27 15: R\$ 22,73
30: R\$ 23,19 45: R\$ 23,65 60: R\$ 24,13



PAPEL OPALINE A4 180GR 60KG AZUL 50X1
Código: Fábrica: Unidade:
45993 MASTERPRINT PT/50
F1 F4

UN: R\$ 0,41 AV: R\$ 20,53 15: R\$ 20,96
30: R\$ 21,38 45: R\$ 21,81 60: R\$ 22,24



PAPEL OPALINE A4 180GR 60KG BRANCO 50X1
Código: Fábrica: Unidade:
45114 MASTERPRINT PT/50
F1 F4

UN: R\$ 0,95 AV: R\$ 19,00 15: R\$ 19,40
30: R\$ 19,79 45: R\$ 20,18 60: R\$ 20,59



PAPEL OPALINE A4 180GR 60KG PINK NEO20X1
Código: Fábrica: Unidade:
48916 MASTERPRINT PT/20
F1 F4

UN: R\$ 0,38 AV: R\$ 19,00 15: R\$ 19,40
30: R\$ 19,79 45: R\$ 20,18 60: R\$ 20,59



PAPEL OPALINE A4 180GR 60KG PRETO 50X1
Código: Fábrica: Unidade:
49065 MASTERPRINT PT/50
F1 F4

UN: R\$ 0,45 AV: R\$ 22,27 15: R\$ 22,73
30: R\$ 23,19 45: R\$ 23,65 60: R\$ 24,13



PAPEL OPALINE A4 180GR 60KG ROSA 50X1
Código: Fábrica: Unidade:
45990 MASTERPRINT PT/50
F1 F4

UN: R\$ 0,45 AV: R\$ 22,27 15: R\$ 22,73
30: R\$ 23,19 45: R\$ 23,65 60: R\$ 24,13



PAPEL OPALINE A4 180GR 60KG VERDE 50X1
Código: Fábrica: Unidade:
45991 MASTERPRINT PT/50
F1 F4

UN: R\$ 0,48 AV: R\$ 9,66 15: R\$ 9,86
30: R\$ 10,05 45: R\$ 10,26 60: R\$ 10,46



PAPEL OPALINE A4 180GR 60KG 4CORES 20X1
Código: Fábrica: Unidade:
48917 MASTERPRINT PT/20
F1 F4

UN: R\$ 8,22 AV: R\$ 82,17 15: R\$ 83,88
30: R\$ 85,56 45: R\$ 87,27 60: R\$ 89,01



PAPEL PARANA 80X100CM N120 10 FLS
Código: Fábrica: Unidade:
34399 VMP PT/10
F1 F4

UN: R\$ 1,36 AV: R\$ 33,89 15: R\$ 34,59
30: R\$ 35,29 45: R\$ 35,99 60: R\$ 36,71

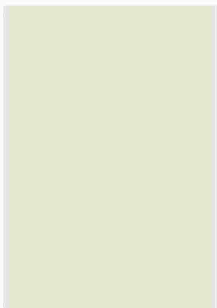

PAPEL PEROLA A4 120GR PRATA 25X1
Código: Fábrica: Unidade:
48263 AGAPE PT/25
F1 F4

UN: R\$ 1,37 AV: R\$ 41,08 15: R\$ 41,93
30: R\$ 42,77 45: R\$ 43,63 60: R\$ 44,50



PAPEL PEROLA A4 180GR AMARELO 30X1
Código: Fábrica: Unidade:
41363 USAPEL PT/30
F1 F4

UN: R\$ 1,36 AV: R\$ 33,89 15: R\$ 34,59
30: R\$ 35,29 45: R\$ 35,99 60: R\$ 36,71

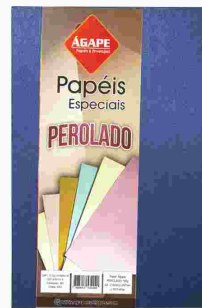

PAPEL PEROLA A4 180GR AZUL 25X1
Código: Fábrica: Unidade:
45642 AGAPE PT/25
F1 F4

UN: R\$ 1,03 AV: R\$ 20,53 15: R\$ 20,96
30: R\$ 21,38 45: R\$ 21,81 60: R\$ 22,24



PAPEL PEROLA A4 180GR BRANCO 20X1
Código: Fábrica: Unidade:
48935 MASTERPRINT PT/20
F1 F4

UN: R\$ 1,36 AV: R\$ 33,89 15: R\$ 34,59
30: R\$ 35,29 45: R\$ 35,99 60: R\$ 36,71

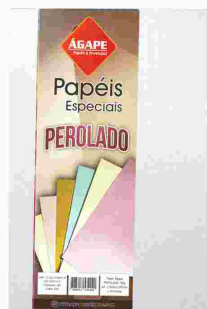

PAPEL PEROLA A4 180GR BRANCO 25X1
Código: Fábrica: Unidade:
45643 AGAPE PT/25
F1 F4

UN: R\$ 1,37 AV: R\$ 41,08 15: R\$ 41,93
30: R\$ 42,77 45: R\$ 43,63 60: R\$ 44,50



PAPEL PEROLA A4 180GR BRANCO 30X1
Código: Fábrica: Unidade:
41365 USAPEL PT/30
F1 F4

UN: R\$ 1,33 AV: R\$ 26,70 15: R\$ 27,25
30: R\$ 27,80 45: R\$ 28,35 60: R\$ 28,92



PAPEL PEROLA A4 180GR CHAMP ROSE 20X1
Código: Fábrica: Unidade:
48921 MASTERPRINT PT/20
F1 F4

UN: R\$ 1,03 AV: R\$ 20,53 15: R\$ 20,96
30: R\$ 21,38 45: R\$ 21,81 60: R\$ 22,24



PAPEL PEROLA A4 180GR DOURADO 20X1
Código: Fábrica: Unidade:
48920 MASTERPRINT PT/20
F1 F4

UN: R\$ 1,03 AV: R\$ 20,53 15: R\$ 20,96
30: R\$ 21,38 45: R\$ 21,81 60: R\$ 22,24



PAPEL PEROLA A4 180GR PRATA 20X1
Código: Fábrica: Unidade:
48923 MASTERPRINT PT/20
F1 F4

UN: R\$ 1,24 AV: R\$ 37,13 15: R\$ 37,91
30: R\$ 38,67 45: R\$ 39,44 60: R\$ 40,23



PAPEL PEROLA A4 180GR PRATA 30X1
Código: Fábrica: Unidade:
41364 USAPEL PT/30
F1 F4

UN: R\$ 1,23 AV: R\$ 30,81 15: R\$ 31,45
30: R\$ 32,08 45: R\$ 32,72 60: R\$ 33,37

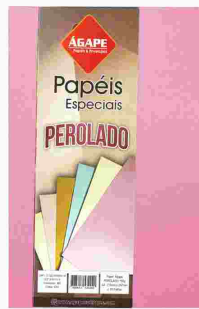

PAPEL PEROLA A4 180GR ROSA 25X1
Código: Fábrica: Unidade:
45644 AGAPE PT/25
F1 F4

UN: R\$ 1,37 AV: R\$ 41,08 15: R\$ 41,93
30: R\$ 42,77 45: R\$ 43,63 60: R\$ 44,50



PAPEL PEROLA A4 180GR ROSA 30X1
Código: Fábrica: Unidade:
41366 USAPEL PT/30
F1 F4

UN: R\$ 1,33 AV: R\$ 26,70 15: R\$ 27,25
30: R\$ 27,80 45: R\$ 28,35 60: R\$ 28,92



PAPEL PEROLA A4 180GR 4 CORES 20X1
Código: Fábrica: Unidade:
48922 MASTERPRINT PT/20
F1 F4

UN: R\$ 0,38 AV: R\$ 15,40 15: R\$ 15,72
30: R\$ 16,03 45: R\$ 16,35 60: R\$ 16,68



PAPEL PLAST PRESENTE METAL 45X65CM 40X1
Código: Fábrica: Unidade:
32398 HAI BRASIL PT/40
F1 F4

UN: R\$ 0,45 AV: R\$ 8,99 15: R\$ 8,99
30: R\$ 8,99 45: R\$ 8,99 60: R\$ 8,99



PAPEL PRES COUC ANIVERSARIO 50X60CM 20X1
Código: Fábrica: Unidade:
40336 SAO JOAO PT/20
F1 F4

UN: R\$ 82,17 AV: R\$ 82,17 15: R\$ 83,88
30: R\$ 85,56 45: R\$ 87,27 60: R\$ 89,01



PAPEL PRES COUC BOB 40CM AMARELO 100M
Código: Fábrica: Unidade:
49168 SAO JOAO RL/1
F1 F4

UN: R\$ 69,99 AV: R\$ 69,99 15: R\$ 69,99
30: R\$ 69,99 45: R\$ 69,99 60: R\$ 69,99



PAPEL PRES COUC BOB 40CM CAS 100M
Código: Fábrica: Unidade:
46680 SAO JOAO RL/1
F1 F4

UN: R\$ 69,99 AV: R\$ 69,99 15: R\$ 69,99
30: R\$ 69,99 45: R\$ 69,99 60: R\$ 69,99



PAPEL PRES COUC BOB 40CM FEM 100M
Código: Fábrica: Unidade:
34839 SAO JOAO RL/1
F1 F4

UN: R\$ 69,99 AV: R\$ 69,99 15: R\$ 69,99
30: R\$ 69,99 45: R\$ 69,99 60: R\$ 69,99



PAPEL PRES COUC BOB 40CM INF 100M
Código: Fábrica: Unidade:
43743 SAO JOAO RL/1
F1 F4

UN: R\$ 69,99 AV: R\$ 69,99 15: R\$ 69,99
30: R\$ 69,99 45: R\$ 69,99 60: R\$ 69,99



PAPEL PRES COUC BOB 40CM NATAL 100M
Código: Fábrica: Unidade:
49173 SAO JOAO RL/1
F1 F4

UN: R\$ 69,99 AV: R\$ 69,99 15: R\$ 69,99
30: R\$ 69,99 45: R\$ 69,99 60: R\$ 69,99



PAPEL PRES COUC BOB 40CM ROMANT COR 100M
Código: Fábrica: Unidade:
46698 SAO JOAO RL/1
F1 F4

UN: R\$ 69,99 AV: R\$ 69,99 15: R\$ 69,99
30: R\$ 69,99 45: R\$ 69,99 60: R\$ 69,99



PAPEL PRES COUC BOB 40CM 2 TEMAS 100M
Código: Fábrica: Unidade:
49986 SAO JOAO RL/1
F1 F4

UN: R\$ 112,98 AV: R\$ 112,98 15: R\$ 115,34
30: R\$ 117,64 45: R\$ 120,00 60: R\$ 122,40



PAPEL PRES COUC BOB 60CM AMARELO 100M
Código: Fábrica: Unidade:
49169 SAO JOAO RL/1
F1 F4

UN: R\$ 99,99 AV: R\$ 99,99 15: R\$ 99,99
30: R\$ 99,99 45: R\$ 99,99 60: R\$ 99,99



PAPEL PRES COUC BOB 60CM CAS 100M
Código: Fábrica: Unidade:
46760 SAO JOAO RL/1
F1 F4

UN: R\$ 99,99 AV: R\$ 99,99 15: R\$ 99,99
30: R\$ 99,99 45: R\$ 99,99 60: R\$ 99,99



PAPEL PRES COUC BOB 60CM FEM 100M

Código: 29095 Fábrica: SAO JOAO Unidade: RL/1 F1 F4

UN: R\$ 99,99 AV: R\$ 99,99 15: R\$ 99,99
30: R\$ 99,99 45: R\$ 99,99 60: R\$ 99,99



PAPEL PRES COUC BOB 60CM INF 70M

Código: 35309 Fábrica: SAO JOAO Unidade: RL/1 F1 F4

UN: R\$ 112,98 AV: R\$ 112,98 15: R\$ 115,34
30: R\$ 117,64 45: R\$ 120,00 60: R\$ 122,40



PAPEL PRES COUC BOB 60CM INF 100M

Código: 46755 Fábrica: SAO JOAO Unidade: RL/1 F1 F4

UN: R\$ 99,99 AV: R\$ 99,99 15: R\$ 99,99
30: R\$ 99,99 45: R\$ 99,99 60: R\$ 99,99



PAPEL PRES COUC BOB 60CM NATAL 100M

Código: 49174 Fábrica: SAO JOAO Unidade: RL/1 F1 F4

UN: R\$ 99,99 AV: R\$ 99,99 15: R\$ 99,99
30: R\$ 99,99 45: R\$ 99,99 60: R\$ 99,99



PAPEL PRES COUC BOB 60CM 2 TEMAS 100M

Código: 49982 Fábrica: SAO JOAO Unidade: RL/1 F1 F4

UN: R\$ 0,45 AV: R\$ 8,99 15: R\$ 8,99
30: R\$ 8,99 45: R\$ 8,99 60: R\$ 8,99



PAPEL PRES COUC CASUAL 50X60CM 20X1

Código: 43115 Fábrica: SAO JOAO Unidade: PT/20 F1 F4

UN: R\$ 0,45 AV: R\$ 8,99 15: R\$ 8,99
30: R\$ 8,99 45: R\$ 8,99 60: R\$ 8,99

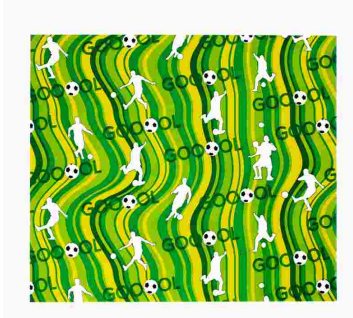

PAPEL PRES COUC COPA GOL 50X60CM 20X1

Código: 39577 Fábrica: VMP Unidade: PT/20 F1 F4

UN: R\$ 0,45 AV: R\$ 8,99 15: R\$ 8,99
30: R\$ 8,99 45: R\$ 8,99 60: R\$ 8,99

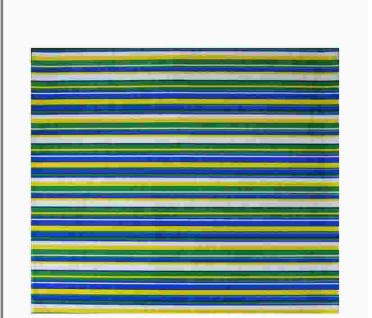

PAPEL PRES COUC COPA LISTR 50X60CM 20X1

Código: 39576 Fábrica: VMP Unidade: PT/20 F1 F4

UN: R\$ 0,45 AV: R\$ 8,99 15: R\$ 8,99
30: R\$ 8,99 45: R\$ 8,99 60: R\$ 8,99



PAPEL PRES COUC COPA R HEXA 50X60CM 20X1

Código: 39578 Fábrica: VMP Unidade: PT/20 F1 F4

UN: R\$ 0,45 AV: R\$ 8,99 15: R\$ 8,99
30: R\$ 8,99 45: R\$ 8,99 60: R\$ 8,99



PAPEL PRES COUC FEMININO 50X60CM 20X1

Código: 33065 Fábrica: SAO JOAO Unidade: PT/20 F1 F4

UN: R\$ 0,45 AV: R\$ 8,99 15: R\$ 8,99
30: R\$ 8,99 45: R\$ 8,99 60: R\$ 8,99



PAPEL PRES COUC INFANTIL 50X60CM 20X1

Código: 43135 Fábrica: SAO JOAO Unidade: PT/20 F1 F4

UN: R\$ 0,45 AV: R\$ 8,99 15: R\$ 8,99
30: R\$ 8,99 45: R\$ 8,99 60: R\$ 8,99



PAPEL PRES COUC NATAL 50X60CM 20X1

Código: 43715 Fábrica: SAO JOAO Unidade: PT/20 F1 F4

UN: R\$ 0,45 AV: R\$ 8,99 15: R\$ 8,99
30: R\$ 8,99 45: R\$ 8,99 60: R\$ 8,99



PAPEL PRES COUC ROMANTICO 50X60CM 20X1

Código: 36784 Fábrica: SAO JOAO Unidade: PT/20 F1 F4

UN: R\$ 0,45 AV: R\$ 8,99 15: R\$ 8,99
30: R\$ 8,99 45: R\$ 8,99 60: R\$ 8,99

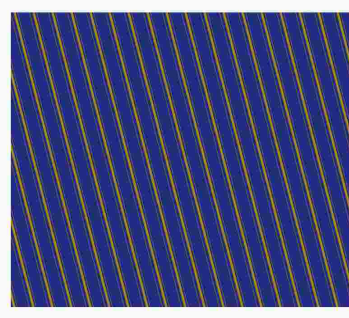

PAPEL PRES COUC 016 CAS AZUL 50X60 20X1

Código: 40962 Fábrica: SAO JOAO Unidade: PT/20 F1 F4

UN: R\$ 0,45 AV: R\$ 8,99 15: R\$ 8,99
30: R\$ 8,99 45: R\$ 8,99 60: R\$ 8,99



PAPEL PRES COUC 178 CAS VERDE 50X60 20X1

Código: 34823 Fábrica: SAO JOAO Unidade: PT/20 F1 F4

UN: R\$ 0,45 AV: R\$ 8,99 15: R\$ 8,99
30: R\$ 8,99 45: R\$ 8,99 60: R\$ 8,99

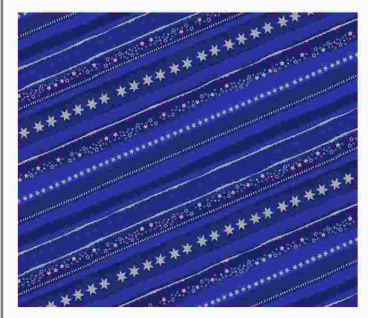

PAPEL PRES COUC 349 CAS AZUL 50X60 20X1

Código: 15810 Fábrica: SAO JOAO Unidade: PT/20 F1 F4

UN: R\$ 0,06 AV: R\$ 3,07 15: R\$ 3,14
30: R\$ 3,20 45: R\$ 3,26 60: R\$ 3,33



PAPEL SEDA P/BALA AZUL CLARO 48X1
Código: Fábrica: Unidade:
39209 PEL PLAST PT/48
F1 F4

UN: R\$ 0,06 AV: R\$ 3,07 15: R\$ 3,14
30: R\$ 3,20 45: R\$ 3,26 60: R\$ 3,33



PAPEL SEDA P/BALA AZUL ESC 48X1
Código: Fábrica: Unidade:
7995 PEL PLAST PT/48
F1 F4

UN: R\$ 0,06 AV: R\$ 3,07 15: R\$ 3,14
30: R\$ 3,20 45: R\$ 3,26 60: R\$ 3,33



PAPEL SEDA P/BALA BRANCO 48X1
Código: Fábrica: Unidade:
8000 PEL PLAST PT/48
F1 F4

UN: R\$ 0,06 AV: R\$ 3,07 15: R\$ 3,14
30: R\$ 3,20 45: R\$ 3,26 60: R\$ 3,33



PAPEL SEDA P/BALA LILAS 48X1
Código: Fábrica: Unidade:
27707 PEL PLAST PT/48
F1 F4

UN: R\$ 0,06 AV: R\$ 3,07 15: R\$ 3,14
30: R\$ 3,20 45: R\$ 3,26 60: R\$ 3,33



PAPEL SEDA P/BALA ROSA 48X1
Código: Fábrica: Unidade:
7997 PEL PLAST PT/48
F1 F4

UN: R\$ 0,06 AV: R\$ 3,07 15: R\$ 3,14
30: R\$ 3,20 45: R\$ 3,26 60: R\$ 3,33



PAPEL SEDA P/BALA VERDE LIMAO 48X1
Código: Fábrica: Unidade:
25623 PEL PLAST PT/48
F1 F4

UN: R\$ 0,06 AV: R\$ 3,07 15: R\$ 3,14
30: R\$ 3,20 45: R\$ 3,26 60: R\$ 3,33



PAPEL SEDA P/BALA VERMELHO 48X1
Código: Fábrica: Unidade:
7998 PEL PLAST PT/48
F1 F4

UN: R\$ 0,64 AV: R\$ 25,67 15: R\$ 26,20
30: R\$ 26,73 45: R\$ 27,26 60: R\$ 27,81



PAPEL SEDA ESTAMPADO MICKEY 40X1
Código: Fábrica: Unidade:
19367 JARAGUA PT/40
F1 F4

UN: R\$ 1,03 AV: R\$ 41,08 15: R\$ 41,93
30: R\$ 42,77 45: R\$ 43,63 60: R\$ 44,50



PAPEL SEDA IMPERM AZUL 48X59CM 40X1
Código: Fábrica: Unidade:
33153 EMBALE PT/40
F1 F4

UN: R\$ 0,90 AV: R\$ 35,94 15: R\$ 36,69
30: R\$ 37,42 45: R\$ 38,17 60: R\$ 38,94



PAPEL SEDA IMPERM BRANCO 48X59CM 40X1
Código: Fábrica: Unidade:
27160 EMBALE PT/40
F1 F4

UN: R\$ 1,03 AV: R\$ 41,08 15: R\$ 41,93
30: R\$ 42,77 45: R\$ 43,63 60: R\$ 44,50



PAPEL SEDA IMPERM PINK 48X59CM 40X1
Código: Fábrica: Unidade:
33234 EMBALE PT/40
F1 F4

UN: R\$ 1,03 AV: R\$ 41,08 15: R\$ 41,93
30: R\$ 42,77 45: R\$ 43,63 60: R\$ 44,50



PAPEL SEDA IMPERM VERDE 48X59CM 40X1
Código: Fábrica: Unidade:
33154 EMBALE PT/40
F1 F4

UN: R\$ 1,03 AV: R\$ 41,08 15: R\$ 41,93
30: R\$ 42,77 45: R\$ 43,63 60: R\$ 44,50



PAPEL SEDA IMPERM VERMELHO 48X59CM 40X1
Código: Fábrica: Unidade:
32409 EMBALE PT/40
F1 F4

UN: R\$ 0,31 AV: R\$ 30,81 15: R\$ 31,45
30: R\$ 32,08 45: R\$ 32,72 60: R\$ 33,37



PAPEL SEDA 48X60CM AMARELO CANARIO 100X1
Código: Fábrica: Unidade:
15613 ARTFLOC PT/100
F1 F4

UN: R\$ 0,31 AV: R\$ 30,81 15: R\$ 31,45
30: R\$ 32,08 45: R\$ 32,72 60: R\$ 33,37



PAPEL SEDA 48X60CM AMARELO OURO 100X1
Código: Fábrica: Unidade:
46888 ART FLOC PT/100
F1 F4

UN: R\$ 0,31 AV: R\$ 30,81 15: R\$ 31,45
30: R\$ 32,08 45: R\$ 32,72 60: R\$ 33,37



PAPEL SEDA 48X60CM AMARELO 100X1
Código: Fábrica: Unidade:
44779 ARTFLOC/NOVA PT/100
F1 F4

UN: R\$ 0,31 AV: R\$ 30,81 15: R\$ 31,45
30: R\$ 32,08 45: R\$ 32,72 60: R\$ 33,37



PAPEL SEDA 48X60CM AZUL CLARO 100X1
Código: Fábrica: Unidade:
15622 ARTFLOC PT/100
F1 F4

UN: R\$ 0,31 AV: R\$ 30,81 15: R\$ 31,45
30: R\$ 32,08 45: R\$ 32,72 60: R\$ 33,37



PAPEL SEDA 48X60CM AZUL ESCURO 100X1
Código: Fábrica: Unidade:
44780 ARTFLOC/NOVA PT/100
F1 F4

UN: R\$ 0,31 AV: R\$ 30,81 15: R\$ 31,45
30: R\$ 32,08 45: R\$ 32,72 60: R\$ 33,37



PAPEL SEDA 48X60CM AZUL MARINHO 100X1
Código: Fábrica: Unidade:
15617 ARTFLOC PT/100
F1 F4

UN: R\$ 0,31 AV: R\$ 30,81 15: R\$ 31,45
30: R\$ 32,08 45: R\$ 32,72 60: R\$ 33,37



PAPEL SEDA 48X60CM AZUL PISCINA 100X1
Código: Fábrica: Unidade:
22594 ARTFLOC PT/100
F1 F4

UN: R\$ 0,31 AV: R\$ 30,81 15: R\$ 31,45
30: R\$ 32,08 45: R\$ 32,72 60: R\$ 33,37



PAPEL SEDA 48X60CM AZUL ROYAL 100X1
Código: Fábrica: Unidade:
19660 ARTFLOC PT/100
F1 F4

UN: R\$ 0,27 AV: R\$ 26,70 15: R\$ 27,25
30: R\$ 27,80 45: R\$ 28,35 60: R\$ 28,92



PAPEL SEDA 48X60CM BRANCO 100X1
Código: Fábrica: Unidade:
1602 ART FLOC PT/100
F1 F4

UN: R\$ 0,31 AV: R\$ 30,81 15: R\$ 31,45
30: R\$ 32,08 45: R\$ 32,72 60: R\$ 33,37



PAPEL SEDA 48X60CM CHAMPAGNE 100X1
Código: Fábrica: Unidade:
20638 ARTFLOC PT/100
F1 F4

UN: R\$ 0,31 AV: R\$ 30,81 15: R\$ 31,45
30: R\$ 32,08 45: R\$ 32,72 60: R\$ 33,37



PAPEL SEDA 48X60CM LARANJA 100X1
Código: Fábrica: Unidade:
15618 ARTFLOC PT/100
F1 F4

UN: R\$ 0,31 AV: R\$ 30,81 15: R\$ 31,45
30: R\$ 32,08 45: R\$ 32,72 60: R\$ 33,37



PAPEL SEDA 48X60CM LILAS 100X1
Código: Fábrica: Unidade:
15616 ARTFLOC/NOVA PT/100
F1 F4

UN: R\$ 0,31 AV: R\$ 30,81 15: R\$ 31,45
30: R\$ 32,08 45: R\$ 32,72 60: R\$ 33,37



PAPEL SEDA 48X60CM MARRON 100X1
Código: Fábrica: Unidade:
15620 ARTFLOC/NOVA PT/100
F1 F4

UN: R\$ 0,31 AV: R\$ 30,81 15: R\$ 31,45
30: R\$ 32,08 45: R\$ 32,72 60: R\$ 33,37



PAPEL SEDA 48X60CM PRETO 100X1
Código: Fábrica: Unidade:
18406 ARTFLOC PT/100
F1 F4

UN: R\$ 0,31 AV: R\$ 30,81 15: R\$ 31,45
30: R\$ 32,08 45: R\$ 32,72 60: R\$ 33,37



PAPEL SEDA 48X60CM ROSA BEBE 100X1
Código: Fábrica: Unidade:
33870 EMBALE PT/100
F1 F4

UN: R\$ 0,31 AV: R\$ 30,81 15: R\$ 31,45
30: R\$ 32,08 45: R\$ 32,72 60: R\$ 33,37



PAPEL SEDA 48X60CM ROSA CLARO 100X1
Código: Fábrica: Unidade:
38342 ARTFLOC PT/100
F1 F4

UN: R\$ 0,31 AV: R\$ 30,81 15: R\$ 31,45
30: R\$ 32,08 45: R\$ 32,72 60: R\$ 33,37



PAPEL SEDA 48X60CM ROSA PINK 100X1
Código: Fábrica: Unidade:
6299 ARTFLOC PT/100
F1 F4

UN: R\$ 0,31 AV: R\$ 30,81 15: R\$ 31,45
30: R\$ 32,08 45: R\$ 32,72 60: R\$ 33,37



PAPEL SEDA 48X60CM ROSA 100X1
Código: Fábrica: Unidade:
15614 ARTFLOC PT/100
F1 F4

UN: R\$ 0,31 AV: R\$ 30,81 15: R\$ 31,45
30: R\$ 32,08 45: R\$ 32,72 60: R\$ 33,37



PAPEL SEDA 48X60CM ROXO 100X1
Código: Fábrica: Unidade:
8052 ARTFLOC PT/100
F1 F4

UN: R\$ 0,31 AV: R\$ 30,81 15: R\$ 31,45
30: R\$ 32,08 45: R\$ 32,72 60: R\$ 33,37



PAPEL SEDA 48X60CM SALMAO 100X1

Código: Fábrica: Unidade:
19369 ART FLOC PT/100
F1 F4

UN: R\$ 0,31 AV: R\$ 30,81 15: R\$ 31,45
30: R\$ 32,08 45: R\$ 32,72 60: R\$ 33,37



PAPEL SEDA 48X60CM VERDE BANDEIRA 100X1

Código: Fábrica: Unidade:
15615 ARTFLOC/NOVA PT/100
F1 F4

UN: R\$ 0,31 AV: R\$ 30,81 15: R\$ 31,45
30: R\$ 32,08 45: R\$ 32,72 60: R\$ 33,37



PAPEL SEDA 48X60CM VERDE CLARO 100X1

Código: Fábrica: Unidade:
15621 EMBALE/ARTFL PT/100
F1 F4

UN: R\$ 0,31 AV: R\$ 30,81 15: R\$ 31,45
30: R\$ 32,08 45: R\$ 32,72 60: R\$ 33,37



PAPEL SEDA 48X60CM VERDE FOLHA 100X1

Código: Fábrica: Unidade:
44778 ARTFLOC/NOVA PT/100
F1 F4

UN: R\$ 0,31 AV: R\$ 30,81 15: R\$ 31,45
30: R\$ 32,08 45: R\$ 32,72 60: R\$ 33,37



PAPEL SEDA 48X60CM VERDE LIMAO 100X1

Código: Fábrica: Unidade:
38343 ART FLOC PT/100
F1 F4

UN: R\$ 0,31 AV: R\$ 30,81 15: R\$ 31,45
30: R\$ 32,08 45: R\$ 32,72 60: R\$ 33,37



PAPEL SEDA 48X60CM VERMELHO 100X1

Código: Fábrica: Unidade:
15619 ART FLOC PT/100
F1 F4

UN: R\$ 0,31 AV: R\$ 30,81 15: R\$ 31,45
30: R\$ 32,08 45: R\$ 32,72 60: R\$ 33,37



PAPEL SEDA 48X60CM VINHO 100X1

Código: Fábrica: Unidade:
19656 ARTFLOC PT/100
F1 F4

UN: R\$ 0,31 AV: R\$ 30,81 15: R\$ 31,45
30: R\$ 32,08 45: R\$ 32,72 60: R\$ 33,37



PAPEL SEDA 48X60CM VIOLETA 100X1

Código: Fábrica: Unidade:
38344 ARTFLOC PT/100
F1 F4

UN: R\$ 349,24 AV: R\$ 349,24 15: R\$ 356,51
30: R\$ 363,64 45: R\$ 370,92 60: R\$ 378,34



PAPEL SEMI KRAFT BOB 80G 120CMX200MX20KG

Código: Fábrica: Unidade:
47304 JUSSARA RL/1
F1 F4

UN: R\$ 0,82 AV: R\$ 164,34 15: R\$ 167,77
30: R\$ 171,12 45: R\$ 174,54 60: R\$ 178,03



PAPEL SEMI KRAFT 80GRS 66X96CM 400 200X1

Código: Fábrica: Unidade:
39981 SANTECK PT/200
F1 F4

UN: R\$ 0,08 AV: R\$ 39,02 15: R\$ 39,84
30: R\$ 40,63 45: R\$ 41,45 60: R\$ 42,27



PAPEL SULFITE BCO 216X279MM 500 FLS

Código: Fábrica: Unidade:
50698 CHAMEX PT/500
F1 F4

UN: R\$ 0,04 AV: R\$ 3,99 15: R\$ 3,99
30: R\$ 3,99 45: R\$ 3,99 60: R\$ 3,99

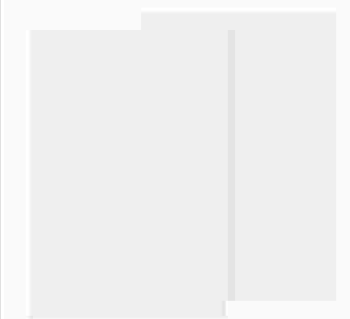

PAPEL SULFITE BRANCO 216X279MM 100X1

Código: Fábrica: Unidade:
7314 CHAMEX PT/100
F1 F4

UN: R\$ 6,16 AV: R\$ 30,81 15: R\$ 31,45
30: R\$ 32,08 45: R\$ 32,72 60: R\$ 33,37



PAPEL TRANSFER A4 160GR TECIDO CLA 5X1

Código: Fábrica: Unidade:
40674 MASTERPRINT PT/5
F1 F4

UN: R\$ 10,96 AV: R\$ 54,80 15: R\$ 55,94
30: R\$ 57,06 45: R\$ 58,20 60: R\$ 59,37



PAPEL TRANSFER A4 235GR TECIDO ESC 5X1

Código: Fábrica: Unidade:
40673 MASTERPRINT PT/5
F1 F4

UN: R\$ 1,03 AV: R\$ 51,35 15: R\$ 52,42
30: R\$ 53,47 45: R\$ 54,54 60: R\$ 55,63

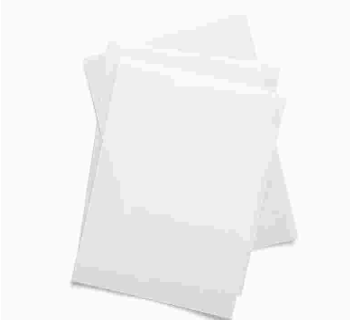

PAPEL VEGETAL A4 90/95GRS 50X1

Código: Fábrica: Unidade:
51023 MARES PT/50
F1 F4

UN: R\$ 0,37 AV: R\$ 18,48 15: R\$ 18,86
30: R\$ 19,24 45: R\$ 19,63 60: R\$ 20,02



PAPEL VERGE A4 120GR BRANCO 50X1

Código: Fábrica: Unidade:
48765 USAPPEL PT/50
F1 F4

UN: R\$ 0,33 AV: R\$ 16,42 15: R\$ 16,77
30: R\$ 17,10 45: R\$ 17,44 60: R\$ 17,79



PAPEL VERGE A4 120GR BRANCO 50X1
Código: 48934 Fábrica: MASTERPRINT Unidade: PT/50 F1 F4

UN: R\$ 0,34 AV: R\$ 17,14 15: R\$ 17,50
30: R\$ 17,85 45: R\$ 18,21 60: R\$ 18,57



PAPEL VERGE A4 120GR CREME 50X1
Código: 48767 Fábrica: USAPEL Unidade: PT/50 F1 F4

UN: R\$ 0,34 AV: R\$ 17,14 15: R\$ 17,50
30: R\$ 17,85 45: R\$ 18,21 60: R\$ 18,57



PAPEL VERGE A4 120GR MADRE PEROLA 50X1
Código: 48766 Fábrica: USAPEL Unidade: PT/50 F1 F4

UN: R\$ 0,34 AV: R\$ 17,14 15: R\$ 17,50
30: R\$ 17,85 45: R\$ 18,21 60: R\$ 18,57

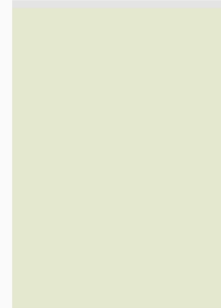

PAPEL VERGE A4 120GR MARFIM 50X1
Código: 33695 Fábrica: USAPEL Unidade: PT/50 F1 F4

UN: R\$ 0,41 AV: R\$ 20,53 15: R\$ 20,96
30: R\$ 21,38 45: R\$ 21,81 60: R\$ 22,24



PAPEL VERGE A4 180GR AZUL CLARO 50X1
Código: 38559 Fábrica: USAPEL Unidade: PT/50 F1 F4

UN: R\$ 0,41 AV: R\$ 20,53 15: R\$ 20,96
30: R\$ 21,38 45: R\$ 21,81 60: R\$ 22,24

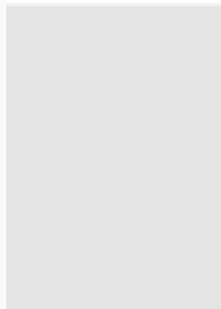

PAPEL VERGE A4 180GR BRANCO 50X1
Código: 4259 Fábrica: USAPEL Unidade: PT/50 F1 F4

UN: R\$ 0,41 AV: R\$ 20,53 15: R\$ 20,96
30: R\$ 21,38 45: R\$ 21,81 60: R\$ 22,24



PAPEL VERGE A4 180GR CINZA 50X1
Código: 43325 Fábrica: USAPEL Unidade: PT/50 F1 F4

UN: R\$ 0,41 AV: R\$ 20,53 15: R\$ 20,96
30: R\$ 21,38 45: R\$ 21,81 60: R\$ 22,24

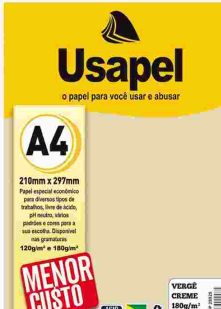

PAPEL VERGE A4 180GR CREME 50X1
Código: 41367 Fábrica: USAPEL Unidade: PT/50 F1 F4

UN: R\$ 0,41 AV: R\$ 20,53 15: R\$ 20,96
30: R\$ 21,38 45: R\$ 21,81 60: R\$ 22,24

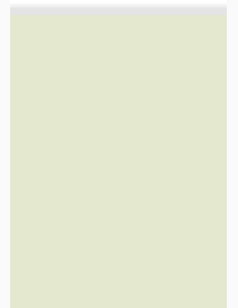

PAPEL VERGE A4 180GR MARFIM 50X1
Código: 31684 Fábrica: USAPEL Unidade: PT/50 F1 F4

UN: R\$ 0,41 AV: R\$ 20,53 15: R\$ 20,96
30: R\$ 21,38 45: R\$ 21,81 60: R\$ 22,24



PAPEL VERGE A4 180GR PALHA 50X1
Código: 41368 Fábrica: USAPEL Unidade: PT/50 F1 F4

UN: R\$ 0,41 AV: R\$ 20,53 15: R\$ 20,96
30: R\$ 21,38 45: R\$ 21,81 60: R\$ 22,24



PAPEL VERGE A4 180GR SALMAO 50X1
Código: 31682 Fábrica: USAPEL Unidade: PT/50 F1 F4

UN: R\$ 0,39 AV: R\$ 19,51 15: R\$ 19,91
30: R\$ 20,31 45: R\$ 20,72 60: R\$ 21,13



PAPEL VERGE A4 180GR TEXTU BRANCO 50X1
Código: 45115 Fábrica: MASTERPRINT Unidade: PT/50 F1 F4

UN: R\$ 0,41 AV: R\$ 20,53 15: R\$ 20,96
30: R\$ 21,38 45: R\$ 21,81 60: R\$ 22,24



PAPEL VERGE A4 180GR VERDE 50X1
Código: 31683 Fábrica: USAPEL Unidade: PT/50 F1 F4

UN: R\$ 24,76 AV: R\$ 24,76 15: R\$ 25,28
30: R\$ 25,78 45: R\$ 26,30 60: R\$ 26,82



PASTA AZ REG ARQ OF LOMBO ESTR PRETO
Código: 42387 Fábrica: POLYCARD Unidade: UN/1 F1 F4

UN: R\$ 24,76 AV: R\$ 24,76 15: R\$ 25,28
30: R\$ 25,78 45: R\$ 26,30 60: R\$ 26,82



PASTA AZ REG ARQ OF LOMBO ESTR TEXTURA
Código: 42606 Fábrica: POLYCARD Unidade: UN/1 F1 F4

UN: R\$ 23,58 AV: R\$ 23,58 15: R\$ 24,07
30: R\$ 24,55 45: R\$ 25,04 60: R\$ 25,54



PASTA AZ REG ARQ OF LOMBO LARGO PRETO
Código: 45237 Fábrica: ECONOMIC Unidade: UN/1 F1 F4

UN: R\$ 25,94 AV: R\$ 25,94 15: R\$ 26,48
30: R\$ 27,01 45: R\$ 27,55 60: R\$ 28,10



PASTA AZ REG ARQ OF LOMBO LARGO TEXTURA
Código: Fábrica: Unidade:
42607 POLYCART UN/1
F1 F4

UN: R\$ 24,18 AV: R\$ 24,18 15: R\$ 24,69
30: R\$ 25,18 45: R\$ 25,68 60: R\$ 26,20



PASTA AZ REG ARQ OFIC LOMBO ESTR TIGRADO
Código: Fábrica: Unidade:
42605 FRAMA UN/1
F1 F4

UN: R\$ 27,12 AV: R\$ 27,12 15: R\$ 27,68
30: R\$ 28,24 45: R\$ 28,80 60: R\$ 29,38

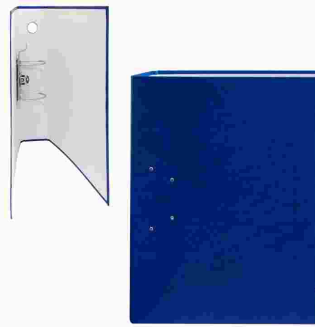

PASTA AZ REG ARQ OFIC LOMBO LARGO AZUL
Código: Fábrica: Unidade:
13241 FRAMA UN/1
F1 F4

UN: R\$ 25,94 AV: R\$ 25,94 15: R\$ 26,48
30: R\$ 27,01 45: R\$ 27,55 60: R\$ 28,10



PASTA AZ REG ARQ OFIC LOMBO LARGO GRAFIT
Código: Fábrica: Unidade:
41680 FRAMA UN/1
F1 F4

UN: R\$ 65,09 AV: R\$ 65,09 15: R\$ 66,45
30: R\$ 67,77 45: R\$ 69,13 60: R\$ 70,51

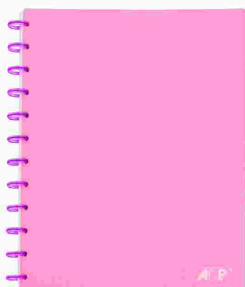

PASTA CANDY A4 C/30 ENVELOPE DESTAC AZUL
Código: Fábrica: Unidade:
46097 ACP UN/1
F1 F4

UN: R\$ 65,09 AV: R\$ 65,09 15: R\$ 66,45
30: R\$ 67,77 45: R\$ 69,13 60: R\$ 70,51



PASTA CANDY A4 C/30 ENVELOPE DESTAC ROSA
Código: Fábrica: Unidade:
46096 ACP UN/1
F1 F4

UN: R\$ 14,31 AV: R\$ 14,31 15: R\$ 14,61
30: R\$ 14,90 45: R\$ 15,20 60: R\$ 15,50



PASTA CATALOGO OFIC 10 PLAST 0,06 123
Código: Fábrica: Unidade:
909 ACP UN/1
F1 F4

UN: R\$ 18,29 AV: R\$ 18,29 15: R\$ 18,67
30: R\$ 19,05 45: R\$ 19,43 60: R\$ 19,82

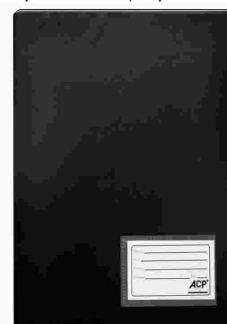

PASTA CATALOGO OFIC 30 PLAST 0,06 123/3
Código: Fábrica: Unidade:
15378 ACP UN/1
F1 F4

UN: R\$ 22,00 AV: R\$ 22,00 15: R\$ 22,46
30: R\$ 22,91 45: R\$ 23,36 60: R\$ 23,83



PASTA CATALOGO OFIC 50 PLAST 0,06 122
Código: Fábrica: Unidade:
1703 ACP/DAC UN/1
F1 F4

UN: R\$ 31,27 AV: R\$ 31,27 15: R\$ 31,92
30: R\$ 32,56 45: R\$ 33,21 60: R\$ 33,87



PASTA CATALOGO OFIC 100 PLAST 0,06 130
Código: Fábrica: Unidade:
7051 ACP UN/1
F1 F4

UN: R\$ 11,57 AV: R\$ 11,57 15: R\$ 11,82
30: R\$ 12,06 45: R\$ 12,29 60: R\$ 12,54

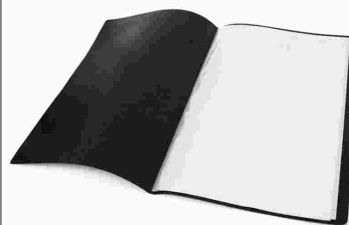

PASTA CATALOGO PP OF 10 PLAST PRETA
Código: Fábrica: Unidade:
27130 AD UN/1
F1 F4

UN: R\$ 7,91 AV: R\$ 79,08 15: R\$ 80,73
30: R\$ 82,35 45: R\$ 83,99 60: R\$ 85,67



PASTA CLASSIFICADORA AZUL 10X1
Código: Fábrica: Unidade:
11195 TP PASTAS PT/10
F1 F4

UN: R\$ 7,91 AV: R\$ 79,08 15: R\$ 80,73
30: R\$ 82,35 45: R\$ 83,99 60: R\$ 85,67



PASTA CLASSIFICADORA CINZA 10X1
Código: Fábrica: Unidade:
11199 TP PASTAS PT/10
F1 F4

UN: R\$ 9,08 AV: R\$ 181,51 15: R\$ 185,29
30: R\$ 188,99 45: R\$ 192,77 60: R\$ 196,63

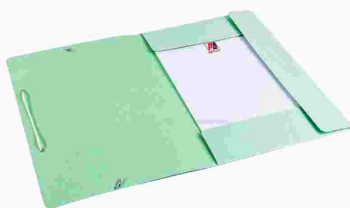

PASTA CLASSIFICADORA DUPLO PLAST 20X1
Código: Fábrica: Unidade:
51134 POLYCART PT/20
F1 F4

UN: R\$ 7,91 AV: R\$ 79,08 15: R\$ 80,73
30: R\$ 82,35 45: R\$ 83,99 60: R\$ 85,67

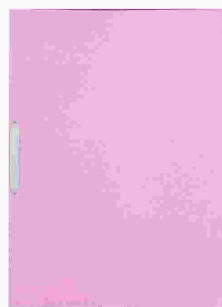

PASTA CLASSIFICADORA ROSA 10X1
Código: Fábrica: Unidade:
47773 TP PASTAS PT/10
F1 F4

UN: R\$ 9,43 AV: R\$ 9,43 15: R\$ 9,62
30: R\$ 9,81 45: R\$ 10,01 60: R\$ 10,21



PASTA CLASSIFICADORA VERDE UN
Código: Fábrica: Unidade:
43506 DELUCAS UN/1
F1 F4

UN: R\$ 7,91 AV: R\$ 79,08 15: R\$ 80,73
30: R\$ 82,35 45: R\$ 83,99 60: R\$ 85,67



PASTA CLASSIFICADORA VERDE 10X1

Código: Fábrica: Unidade:
11196 TT PASTAS PT/10
F1 F4

UN: R\$ 7,99 AV: R\$ 79,92 15: R\$ 81,58
30: R\$ 83,22 45: R\$ 84,88 60: R\$ 86,58



PASTA ENVELOP PP OF VAI VEM CRISTAL 10X1

Código: Fábrica: Unidade:
41606 DAC/ACP PT/10
F1 F4

UN: R\$ 7,99 AV: R\$ 79,92 15: R\$ 81,58
30: R\$ 83,22 45: R\$ 84,88 60: R\$ 86,58



PASTA ENVELOPE PP OF VAI VEM FUME 10X1

Código: Fábrica: Unidade:
41607 DAC/ACP PT/10
F1 F4

UN: R\$ 52,12 AV: R\$ 52,12 15: R\$ 53,20
30: R\$ 54,27 45: R\$ 55,35 60: R\$ 56,46



PASTA LONA EXECUTIVA DETALH MARROM 52203

Código: Fábrica: Unidade:
33850 HOLLYCLASSIC UN/1
F1 F4

UN: R\$ 52,12 AV: R\$ 52,12 15: R\$ 53,20
30: R\$ 54,27 45: R\$ 55,35 60: R\$ 56,46



PASTA LONA EXECUTIVA PRETA 52203

Código: Fábrica: Unidade:
34038 HOLLYCLASSIC UN/1
F1 F4

UN: R\$ 20,53 AV: R\$ 20,53 15: R\$ 20,96
30: R\$ 21,38 45: R\$ 21,81 60: R\$ 22,24



PASTA LONA HELLO KITTY 001

Código: Fábrica: Unidade:
12815 LOMY UN/1
F1 F4

UN: R\$ 34,74 AV: R\$ 34,74 15: R\$ 35,46
30: R\$ 36,17 45: R\$ 36,90 60: R\$ 37,64



PASTA LONA SILKADA

Código: Fábrica: Unidade:
15242 A2WORKS UN/1
F1 F4

UN: R\$ 4,62 AV: R\$ 46,21 15: R\$ 47,18
30: R\$ 48,12 45: R\$ 49,08 60: R\$ 50,06



PASTA PAPEL ABA ELAST C/ILHOS AMARE 10X1

Código: Fábrica: Unidade:
45393 TP PASTAS PT/10
F1 F4

UN: R\$ 4,62 AV: R\$ 46,21 15: R\$ 47,18
30: R\$ 48,12 45: R\$ 49,08 60: R\$ 50,06

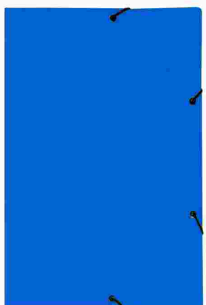

PASTA PAPEL ABA ELAST C/ILHOS AZUL 10X1

Código: Fábrica: Unidade:
44336 TP PASTAS PT/10
F1 F4

UN: R\$ 4,62 AV: R\$ 46,21 15: R\$ 47,18
30: R\$ 48,12 45: R\$ 49,08 60: R\$ 50,06



PASTA PAPEL ABA ELAST C/ILHOS PRETO 10X1

Código: Fábrica: Unidade:
44337 TP PASTAS PT/10
F1 F4

UN: R\$ 4,62 AV: R\$ 46,21 15: R\$ 47,18
30: R\$ 48,12 45: R\$ 49,08 60: R\$ 50,06



PASTA PAPEL ABA ELAST C/ILHOS ROSA 10X1

Código: Fábrica: Unidade:
45394 TP PASTAS PT/10
F1 F4

UN: R\$ 4,62 AV: R\$ 46,21 15: R\$ 47,18
30: R\$ 48,12 45: R\$ 49,08 60: R\$ 50,06

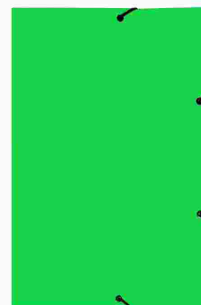

PASTA PAPEL ABA ELAST C/ILHOS VERDE 10X1

Código: Fábrica: Unidade:
44338 TP PASTAS PT/10
F1 F4

UN: R\$ 4,62 AV: R\$ 46,21 15: R\$ 47,18
30: R\$ 48,12 45: R\$ 49,08 60: R\$ 50,06

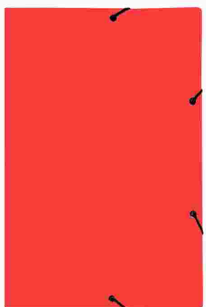

PASTA PAPEL ABA ELAST C/ILHOS VERM 10X1

Código: Fábrica: Unidade:
44339 TP PASTAS PT/10
F1 F4

UN: R\$ 3,79 AV: R\$ 37,88 15: R\$ 38,67
30: R\$ 39,45 45: R\$ 40,23 60: R\$ 41,04

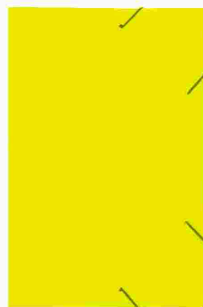

PASTA PAPEL ABA ELAST S/ILHOS AMARE 10X1

Código: Fábrica: Unidade:
8652 TP PASTAS PT/10
F1 F4

UN: R\$ 3,79 AV: R\$ 37,88 15: R\$ 38,67
30: R\$ 39,45 45: R\$ 40,23 60: R\$ 41,04

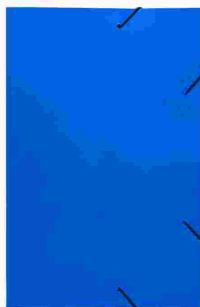

PASTA PAPEL ABA ELAST S/ILHOS AZUL 10X1

Código: Fábrica: Unidade:
18084 TP PAST/BRAS PT/10
F1 F4

UN: R\$ 3,79 AV: R\$ 37,88 15: R\$ 38,67
30: R\$ 39,45 45: R\$ 40,23 60: R\$ 41,04

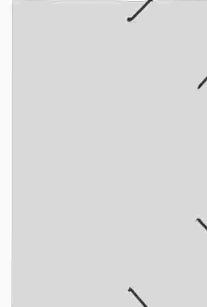

PASTA PAPEL ABA ELAST S/ILHOS BRANC 10X1

Código: Fábrica: Unidade:
47774 TP PASTAS PT/10
F1 F4

UN: R\$ 3,79 AV: R\$ 37,88 15: R\$ 38,67
30: R\$ 39,45 45: R\$ 40,23 60: R\$ 41,04

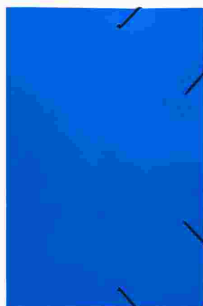

PASTA PAPEL ABA ELAST S/ILHOS LARAN 10X1

Código: 47775 Fábrica: TP PASTAS Unidade: PT/10 F1 F4

UN: R\$ 3,79 AV: R\$ 37,88 15: R\$ 38,67
30: R\$ 39,45 45: R\$ 40,23 60: R\$ 41,04



PASTA PAPEL ABA ELAST S/ILHOS PRETO 10X1

Código: 8661 Fábrica: TP PASTAS Unidade: PT/10 F1 F4

UN: R\$ 3,79 AV: R\$ 37,88 15: R\$ 38,67
30: R\$ 39,45 45: R\$ 40,23 60: R\$ 41,04



PASTA PAPEL ABA ELAST S/ILHOS ROSA 10X1

Código: 27877 Fábrica: TP PASTAS Unidade: PT/10 F1 F4

UN: R\$ 3,79 AV: R\$ 37,88 15: R\$ 38,67
30: R\$ 39,45 45: R\$ 40,23 60: R\$ 41,04



PASTA PAPEL ABA ELAST S/ILHOS VERM 10X1

Código: 8650 Fábrica: TP PASTAS Unidade: PT/10 F1 F4

UN: R\$ 3,89 AV: R\$ 3,89 15: R\$ 3,97
30: R\$ 4,05 45: R\$ 4,13 60: R\$ 4,22

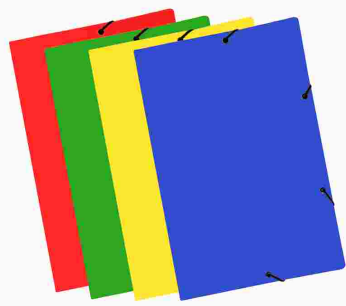

PASTA PAPEL ABA ELASTICA

Código: 11201 Fábrica: ACP Unidade: UN/1 F1 F4

UN: R\$ 2,98 AV: R\$ 29,78 15: R\$ 30,40
30: R\$ 31,01 45: R\$ 31,63 60: R\$ 32,26



PASTA PAPEL C/GRAMPO METAL BRANCA 10X1

Código: 44218 Fábrica: TP PASTAS Unidade: PT/10 F1 F4

UN: R\$ 2,98 AV: R\$ 29,78 15: R\$ 30,40
30: R\$ 31,01 45: R\$ 31,63 60: R\$ 32,26



PASTA PAPEL C/GRAMPO METAL 10X1

Código: 45401 Fábrica: TP PASTAS Unidade: PT/10 F1 F4

UN: R\$ 2,98 AV: R\$ 29,78 15: R\$ 30,40
30: R\$ 31,01 45: R\$ 31,63 60: R\$ 32,26



PASTA PAPEL C/GRAMPO PLAST AMARELO 10X1

Código: 11197 Fábrica: TP PASTAS Unidade: PT/10 F1 F4

UN: R\$ 2,98 AV: R\$ 29,78 15: R\$ 30,40
30: R\$ 31,01 45: R\$ 31,63 60: R\$ 32,26

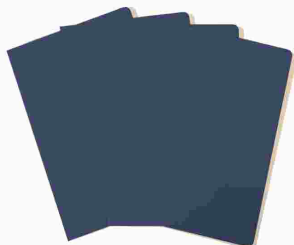

PASTA PAPEL C/GRAMPO PLAST AZUL 10X1

Código: 44216 Fábrica: TP PASTAS Unidade: PT/10 F1 F4

UN: R\$ 2,98 AV: R\$ 29,78 15: R\$ 30,40
30: R\$ 31,01 45: R\$ 31,63 60: R\$ 32,26



PASTA PAPEL C/GRAMPO PLAST BRANCA 10X1

Código: 48047 Fábrica: TP PASTAS Unidade: PT/10 F1 F4

UN: R\$ 2,98 AV: R\$ 29,78 15: R\$ 30,40
30: R\$ 31,01 45: R\$ 31,63 60: R\$ 32,26



PASTA PAPEL C/GRAMPO PLAST LARANJA 10X1

Código: 48048 Fábrica: TP PASTAS Unidade: PT/10 F1 F4

UN: R\$ 2,98 AV: R\$ 29,78 15: R\$ 30,40
30: R\$ 31,01 45: R\$ 31,63 60: R\$ 32,26



PASTA PAPEL C/GRAMPO PLAST LILAS 10X1

Código: 48049 Fábrica: TP PASTAS Unidade: PT/10 F1 F4

UN: R\$ 2,98 AV: R\$ 29,78 15: R\$ 30,40
30: R\$ 31,01 45: R\$ 31,63 60: R\$ 32,26



PASTA PAPEL C/GRAMPO PLAST ROSA 10X1

Código: 48046 Fábrica: TP PASTAS Unidade: PT/10 F1 F4

UN: R\$ 2,98 AV: R\$ 29,78 15: R\$ 30,40
30: R\$ 31,01 45: R\$ 31,63 60: R\$ 32,26



PASTA PAPEL C/GRAMPO PLAST VERDE 10X1

Código: 44215 Fábrica: TP PASTAS Unidade: PT/10 F1 F4

UN: R\$ 2,98 AV: R\$ 29,78 15: R\$ 30,40
30: R\$ 31,01 45: R\$ 31,63 60: R\$ 32,26



PASTA PAPEL C/GRAMPO PLAST VERMELHO 10X1

Código: 11198 Fábrica: TP PAS/BRAS Unidade: PT/10 F1 F4

UN: R\$ 2,98 AV: R\$ 29,78 15: R\$ 30,40
30: R\$ 31,01 45: R\$ 31,63 60: R\$ 32,26

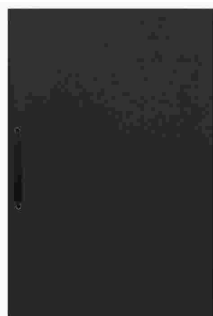

PASTA PAPEL C/GRAMPO PRETA 10X1

Código: 43862 Fábrica: TP PASTAS Unidade: PT/10 F1 F4

UN: R\$ 2,98 AV: R\$ 29,78 15: R\$ 30,40
30: R\$ 31,01 45: R\$ 31,63 60: R\$ 32,26



PASTA PAPEL C/GRAMPO ROSA 10X1

Código: Fábrica: Unidade:
44219 TP PASTAS PT/10
F1 F4

UN: R\$ 3,08 AV: R\$ 61,62 15: R\$ 62,91
30: R\$ 64,16 45: R\$ 65,45 60: R\$ 66,76

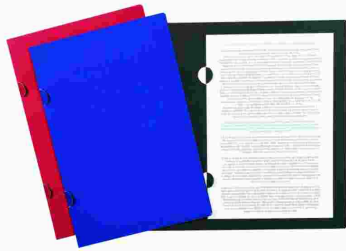

PASTA PAPEL C/ORELHA DUPLEX COLOR 20X1

Código: Fábrica: Unidade:
51028 POLYCART PT/20
F1 F4

UN: R\$ 2,05 AV: R\$ 20,53 15: R\$ 20,96
30: R\$ 21,38 45: R\$ 21,81 60: R\$ 22,24



PASTA PAPEL PROCESSO 10X1

Código: Fábrica: Unidade:
45400 DELUCAS PT/10
F1 F4

UN: R\$ 2,67 AV: R\$ 26,70 15: R\$ 27,25
30: R\$ 27,80 45: R\$ 28,35 60: R\$ 28,92



PASTA PAPEL S/GRAMPO AMARELO 10X1

Código: Fábrica: Unidade:
48050 TP PASTAS PT/10
F1 F4

UN: R\$ 2,67 AV: R\$ 26,70 15: R\$ 27,25
30: R\$ 27,80 45: R\$ 28,35 60: R\$ 28,92

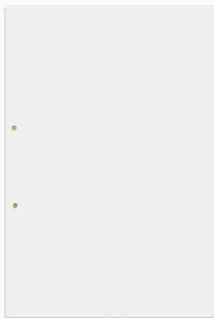

PASTA PAPEL S/GRAMPO BRANCA10X1

Código: Fábrica: Unidade:
48051 TP PASTAS PT/10
F1 F4

UN: R\$ 2,67 AV: R\$ 26,70 15: R\$ 27,25
30: R\$ 27,80 45: R\$ 28,35 60: R\$ 28,92



PASTA PAPEL S/GRAMPO CINZA 10X1

Código: Fábrica: Unidade:
48053 TP PASTAS PT/10
F1 F4

UN: R\$ 2,67 AV: R\$ 26,70 15: R\$ 27,25
30: R\$ 27,80 45: R\$ 28,35 60: R\$ 28,92



PASTA PAPEL S/GRAMPO LARANJA 10X1

Código: Fábrica: Unidade:
48052 TP PASTAS PT/10
F1 F4

UN: R\$ 2,67 AV: R\$ 26,70 15: R\$ 27,25
30: R\$ 27,80 45: R\$ 28,35 60: R\$ 28,92

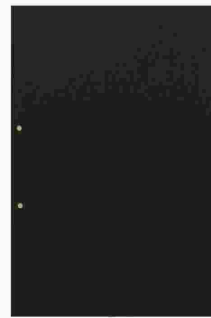

PASTA PAPEL S/GRAMPO PRETA 10X1

Código: Fábrica: Unidade:
48054 TP PASTAS PT/10
F1 F4

UN: R\$ 2,67 AV: R\$ 26,70 15: R\$ 27,25
30: R\$ 27,80 45: R\$ 28,35 60: R\$ 28,92



PASTA PAPEL S/GRAMPO ROSA 10X1

Código: Fábrica: Unidade:
48055 TP PASTAS PT/10
F1 F4

UN: R\$ 4,45 AV: R\$ 44,48 15: R\$ 45,40
30: R\$ 46,31 45: R\$ 47,24 60: R\$ 48,18



PASTA PAPEL 250G GRAMPO PLAST AZUL 10X1

Código: Fábrica: Unidade:
49778 TP PASTAS PT/10
F1 F4

UN: R\$ 4,45 AV: R\$ 44,48 15: R\$ 45,40
30: R\$ 46,31 45: R\$ 47,24 60: R\$ 48,18



PASTA PAPEL 250G GRAMPO PLAST VERM 10X1

Código: Fábrica: Unidade:
49777 TP PASTAS PT/10
F1 F4

UN: R\$ 5,19 AV: R\$ 51,90 15: R\$ 52,98
30: R\$ 54,04 45: R\$ 55,12 60: R\$ 56,22

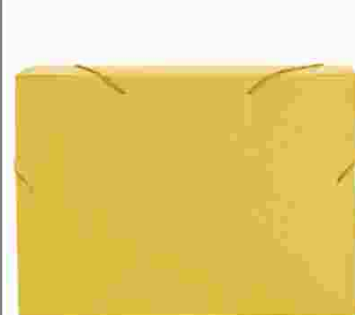

PASTA POLIONDA OF 2 CM AMARELA 10X1

Código: Fábrica: Unidade:
9868 ALAPLAST PT/10
F1 F4

UN: R\$ 5,19 AV: R\$ 51,90 15: R\$ 52,98
30: R\$ 54,04 45: R\$ 55,12 60: R\$ 56,22



PASTA POLIONDA OF 2 CM AZUL 10X1

Código: Fábrica: Unidade:
25628 ALAPLAST PT/10
F1 F4

UN: R\$ 5,19 AV: R\$ 51,90 15: R\$ 52,98
30: R\$ 54,04 45: R\$ 55,12 60: R\$ 56,22



PASTA POLIONDA OF 2 CM CINZA 10X1

Código: Fábrica: Unidade:
43863 ALAPLAST PT/10
F1 F4

UN: R\$ 5,19 AV: R\$ 51,90 15: R\$ 52,98
30: R\$ 54,04 45: R\$ 55,12 60: R\$ 56,22



PASTA POLIONDA OF 2 CM PRETA 10X1

Código: Fábrica: Unidade:
18372 ALAPLAST PT/10
F1 F4

UN: R\$ 5,19 AV: R\$ 51,90 15: R\$ 52,98
30: R\$ 54,04 45: R\$ 55,12 60: R\$ 56,22

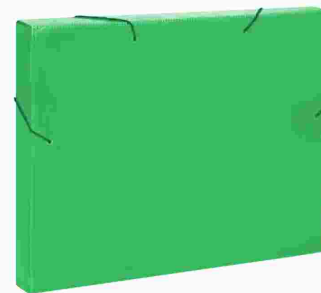

PASTA POLIONDA OF 2 CM VERDE 10X1

Código: Fábrica: Unidade:
25627 ALAPLAST PT/10
F1 F4

UN: R\$ 5,19 AV: R\$ 51,90 15: R\$ 52,98
30: R\$ 54,04 45: R\$ 55,12 60: R\$ 56,22



PASTA POLIONDA OF 2 CM VERMELHA 10X1

Código: 42427 Fábrica: ALAPLAST Unidade: PT/10 F1 F4

UN: R\$ 5,57 AV: R\$ 55,72 15: R\$ 56,88
30: R\$ 58,02 45: R\$ 59,18 60: R\$ 60,36

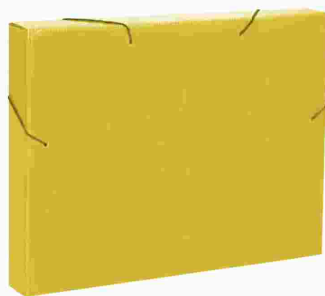

PASTA POLIONDA OF 3,5 CM AMARELA 10X1

Código: 28201 Fábrica: ALAPLAST Unidade: PT/10 F1 F4

UN: R\$ 5,57 AV: R\$ 55,72 15: R\$ 56,88
30: R\$ 58,02 45: R\$ 59,18 60: R\$ 60,36



PASTA POLIONDA OF 3,5 CM AZUL 10X1

Código: 28202 Fábrica: ALAPLAST Unidade: PT/10 F1 F4

UN: R\$ 5,57 AV: R\$ 55,72 15: R\$ 56,88
30: R\$ 58,02 45: R\$ 59,18 60: R\$ 60,36



PASTA POLIONDA OF 3,5 CM PRETA 10X1

Código: 28204 Fábrica: ALAPLAST Unidade: PT/10 F1 F4

UN: R\$ 5,57 AV: R\$ 55,72 15: R\$ 56,88
30: R\$ 58,02 45: R\$ 59,18 60: R\$ 60,36



PASTA POLIONDA OF 3,5 CM VERDE 10X1

Código: 28203 Fábrica: ALAPLAST Unidade: PT/10 F1 F4

UN: R\$ 5,57 AV: R\$ 55,72 15: R\$ 56,88
30: R\$ 58,02 45: R\$ 59,18 60: R\$ 60,36



PASTA POLIONDA OF 3,5 CM VERMELHA 10X1

Código: 42428 Fábrica: ALAPLAST Unidade: PT/10 F1 F4

UN: R\$ 7,30 AV: R\$ 72,97 15: R\$ 74,49
30: R\$ 75,98 45: R\$ 77,50 60: R\$ 79,05

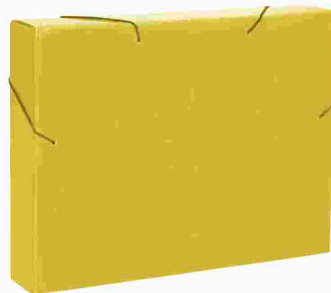

PASTA POLIONDA OF 5,5 CM AMARELA 10X1

Código: 43865 Fábrica: ALAPLAST Unidade: PT/10 F1 F4

UN: R\$ 7,30 AV: R\$ 72,97 15: R\$ 74,49
30: R\$ 75,98 45: R\$ 77,50 60: R\$ 79,05

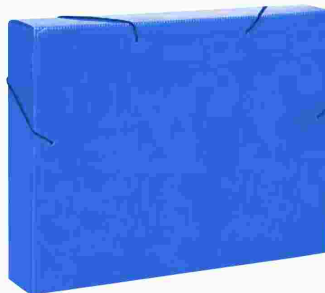

PASTA POLIONDA OF 5,5 CM AZUL 10X1

Código: 43864 Fábrica: ALAPLAST Unidade: PT/10 F1 F4

UN: R\$ 7,30 AV: R\$ 72,97 15: R\$ 74,49
30: R\$ 75,98 45: R\$ 77,50 60: R\$ 79,05



PASTA POLIONDA OF 5,5 CM CINZA 10X1

Código: 43867 Fábrica: ALAPLAST Unidade: PT/10 F1 F4

UN: R\$ 7,30 AV: R\$ 72,97 15: R\$ 74,49
30: R\$ 75,98 45: R\$ 77,50 60: R\$ 79,05

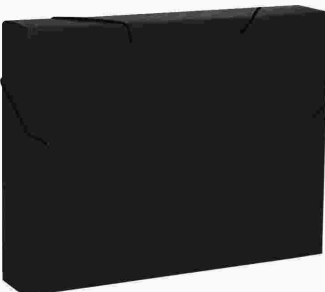

PASTA POLIONDA OF 5,5 CM PRETA 10X1

Código: 43868 Fábrica: ALAPLAST Unidade: PT/10 F1 F4

UN: R\$ 7,30 AV: R\$ 72,97 15: R\$ 74,49
30: R\$ 75,98 45: R\$ 77,50 60: R\$ 79,05



PASTA POLIONDA OF 5,5 CM VERDE 10X1

Código: 43866 Fábrica: ALAPLAST Unidade: PT/10 F1 F4

UN: R\$ 7,30 AV: R\$ 72,97 15: R\$ 74,49
30: R\$ 75,98 45: R\$ 77,50 60: R\$ 79,05



PASTA POLIONDA OF 5,5 CM VERMELHO 10X1

Código: 42429 Fábrica: ALAPLAST Unidade: PT/10 F1 F4

UN: R\$ 2,49 AV: R\$ 24,94 15: R\$ 24,94
30: R\$ 24,94 45: R\$ 24,94 60: R\$ 24,94



PASTA PP OF AMARELO TRANSP 10X1

Código: 9760 Fábrica: ALAPLAST Unidade: PT/10 F1 F4

UN: R\$ 2,49 AV: R\$ 24,94 15: R\$ 24,94
30: R\$ 24,94 45: R\$ 24,94 60: R\$ 24,94

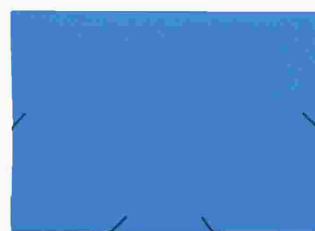

PASTA PP OF AZUL FOSCA 20104A 10X1

Código: 43185 Fábrica: ALAPLAST Unidade: PT/10 F1 F4

UN: R\$ 2,49 AV: R\$ 24,94 15: R\$ 24,94
30: R\$ 24,94 45: R\$ 24,94 60: R\$ 24,94

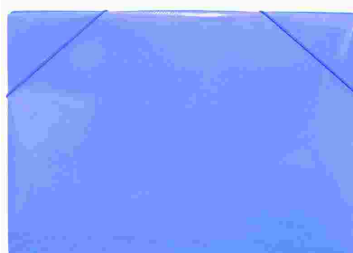

PASTA PP OF AZUL TRANSP 10X1

Código: 46000 Fábrica: ALAPLAST Unidade: PT/10 F1 F4

UN: R\$ 2,49 AV: R\$ 24,94 15: R\$ 24,94
30: R\$ 24,94 45: R\$ 24,94 60: R\$ 24,94



PASTA PP OF AZUL 1021 10X1

Código: 9757 Fábrica: ACP Unidade: PT/10 F1 F4

UN: R\$ 2,49 AV: R\$ 24,94 15: R\$ 24,94
30: R\$ 24,94 45: R\$ 24,94 60: R\$ 24,94

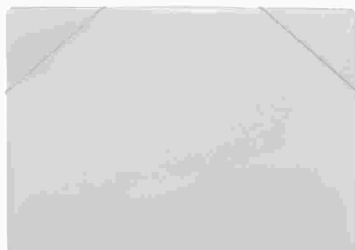

PASTA PP OF CRISTAL TRANSP 10X1

Código: 13089 Fábrica: ALAPLAST Unidade: PT/10 F1 F4

UN: R\$ 2,49 AV: R\$ 24,94 15: R\$ 24,94
30: R\$ 24,94 45: R\$ 24,94 60: R\$ 24,94

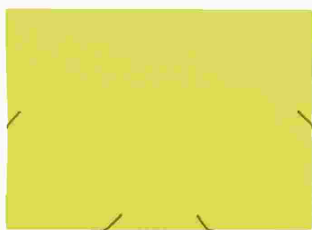

PASTA PP OF ELAST AMARELO FOSCA 10X1

Código: 44326 Fábrica: ALAPLAST Unidade: PT/10 F1 F4

UN: R\$ 2,49 AV: R\$ 24,94 15: R\$ 24,94
30: R\$ 24,94 45: R\$ 24,94 60: R\$ 24,94

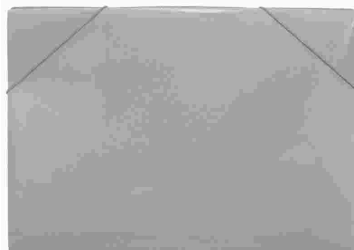

PASTA PP OF FUME TRANSP 10X1

Código: 10031 Fábrica: ALAPLAST Unidade: PT/10 F1 F4

UN: R\$ 2,49 AV: R\$ 24,94 15: R\$ 24,94
30: R\$ 24,94 45: R\$ 24,94 60: R\$ 24,94

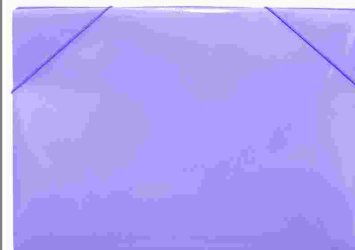

PASTA PP OF LILAS TRANSP 10X1

Código: 38317 Fábrica: ALAPLAST Unidade: PT/10 F1 F4

UN: R\$ 2,49 AV: R\$ 24,94 15: R\$ 24,94
30: R\$ 24,94 45: R\$ 24,94 60: R\$ 24,94

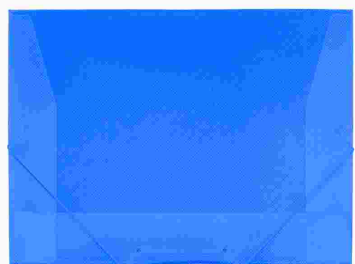

PASTA PP OF LILAS 1021 10X1

Código: 46167 Fábrica: ACP Unidade: PT/10 F1 F4

UN: R\$ 2,49 AV: R\$ 24,94 15: R\$ 24,94
30: R\$ 24,94 45: R\$ 24,94 60: R\$ 24,94



PASTA PP OF ROSA TRANSP 10X1

Código: 41286 Fábrica: ALAPLAST Unidade: PT/10 F1 F4

UN: R\$ 2,49 AV: R\$ 24,94 15: R\$ 24,94
30: R\$ 24,94 45: R\$ 24,94 60: R\$ 24,94

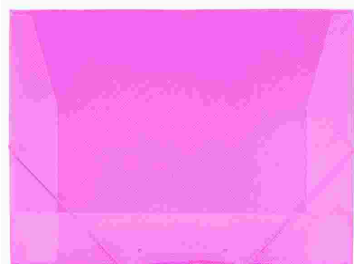

PASTA PP OF ROSA 1021 10X1

Código: 46166 Fábrica: ACP Unidade: PT/10 F1 F4

UN: R\$ 2,49 AV: R\$ 24,94 15: R\$ 24,94
30: R\$ 24,94 45: R\$ 24,94 60: R\$ 24,94



PASTA PP OF VERDE TRANSP 10X1

Código: 46001 Fábrica: ALAPLAST Unidade: PT/10 F1 F4

UN: R\$ 2,49 AV: R\$ 24,94 15: R\$ 24,94
30: R\$ 24,94 45: R\$ 24,94 60: R\$ 24,94



PASTA PP OF VERDE 1021 10X1

Código: 46165 Fábrica: ACP Unidade: PT/10 F1 F4

UN: R\$ 2,49 AV: R\$ 24,94 15: R\$ 24,94
30: R\$ 24,94 45: R\$ 24,94 60: R\$ 24,94



PASTA PP OF VERMELHO TRANSP 10X1

Código: 29784 Fábrica: ALAPLAST Unidade: PT/10 F1 F4

UN: R\$ 2,49 AV: R\$ 24,94 15: R\$ 24,94
30: R\$ 24,94 45: R\$ 24,94 60: R\$ 24,94



PASTA PP OF VERMELHO 1021 10X1

Código: 46169 Fábrica: ACP Unidade: PT/10 F1 F4

UN: R\$ 3,47 AV: R\$ 34,74 15: R\$ 35,46
30: R\$ 36,17 45: R\$ 36,90 60: R\$ 37,64

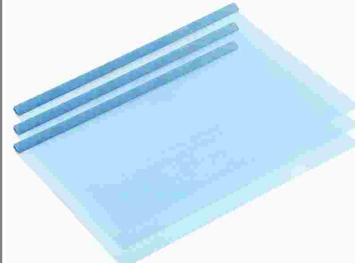

PASTA PP CANALETA A4 AZUL TRANSP 10X1

Código: 43858 Fábrica: ALAPLAST Unidade: PT/10 F1 F4

UN: R\$ 3,47 AV: R\$ 34,74 15: R\$ 35,46
30: R\$ 36,17 45: R\$ 36,90 60: R\$ 37,64



PASTA PP CANALETA A4 CRISTAL TRANSP 10X1

Código: 43857 Fábrica: DAC Unidade: PT/10 F1 F4

UN: R\$ 3,47 AV: R\$ 34,74 15: R\$ 35,46
30: R\$ 36,17 45: R\$ 36,90 60: R\$ 37,64



PASTA PP CANALETA A4 CRISTAL TRANSP 10X1

Código: 46002 Fábrica: ALAPLAST Unidade: PT/10 F1 F4

UN: R\$ 3,47 AV: R\$ 34,74 15: R\$ 35,46
30: R\$ 36,17 45: R\$ 36,90 60: R\$ 37,64



PASTA PP CANALETA A4 FUME TRANSP 10X1

Código: 43860 Fábrica: DAC Unidade: PT/10 F1 F4

UN: R\$ 3,47 AV: R\$ 34,74 15: R\$ 35,46
30: R\$ 36,17 45: R\$ 36,90 60: R\$ 37,64

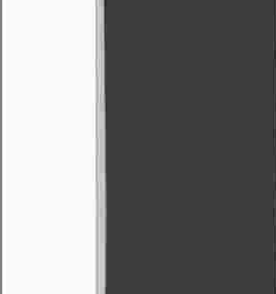

PASTA PP CANALETA A4 PRETO 10X1

Código: 15373 Fábrica: SUPER LINE Unidade: PT/10 F1 F4

UN: R\$ 3,47 AV: R\$ 34,74 15: R\$ 35,46
30: R\$ 36,17 45: R\$ 36,90 60: R\$ 37,64

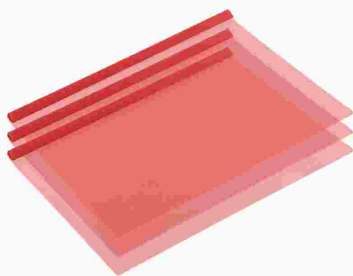

PASTA PP CANALETA A4 VERMELHO TRANS 10X1

Código: Fábrica: Unidade:
43861 ALAPLAST PT/10
F1 F4

UN: R\$ 2,32 AV: R\$ 23,15 15: R\$ 23,64
30: R\$ 24,11 45: R\$ 24,60 60: R\$ 25,08



PASTA PP L A4 AMARELA 042-AM 10X1

Código: Fábrica: Unidade:
50018 DAC PT/10
F1 F4

UN: R\$ 2,32 AV: R\$ 23,15 15: R\$ 23,64
30: R\$ 24,11 45: R\$ 24,60 60: R\$ 25,08



PASTA PP L A4 AZUL 042-AZ 10X1

Código: Fábrica: Unidade:
50019 DAC PT/10
F1 F4

UN: R\$ 1,74 AV: R\$ 17,36 15: R\$ 17,73
30: R\$ 18,08 45: R\$ 18,44 60: R\$ 18,81

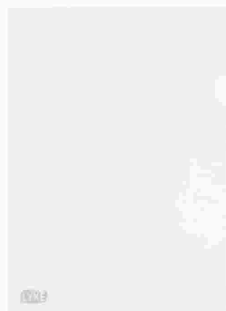

PASTA PP L A4 CRISTAL 371 10X1

Código: Fábrica: Unidade:
24136 LIKE PT/10
F1 F4

UN: R\$ 2,32 AV: R\$ 23,15 15: R\$ 23,64
30: R\$ 24,11 45: R\$ 24,60 60: R\$ 25,08



PASTA PP L A4 ROSA 10X1

Código: Fábrica: Unidade:
50054 DAC PT/10
F1 F4

UN: R\$ 2,32 AV: R\$ 23,15 15: R\$ 23,64
30: R\$ 24,11 45: R\$ 24,60 60: R\$ 25,08



PASTA PP L A4 VERDE 042-VD 10X1

Código: Fábrica: Unidade:
50020 DAC PT/10
F1 F4

UN: R\$ 2,55 AV: R\$ 25,47 15: R\$ 26,00
30: R\$ 26,52 45: R\$ 27,06 60: R\$ 27,60

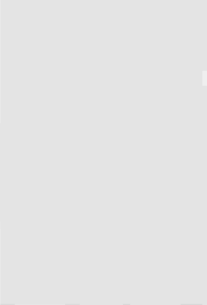

PASTA PP L OF CRISTAL 271/113 10X1

Código: Fábrica: Unidade:
24135 DELLO/LIKE PT/10
F1 F4

UN: R\$ 2,87 AV: R\$ 2,87 15: R\$ 2,93
30: R\$ 2,98 45: R\$ 3,04 60: R\$ 3,10



PASTA PP OF GRAMPO PLAST OF

Código: Fábrica: Unidade:
41617 ALAPLAST UN/1
F1 F4

UN: R\$ 3,08 AV: R\$ 30,81 15: R\$ 31,45
30: R\$ 32,08 45: R\$ 32,72 60: R\$ 33,37



PASTA PP OF GRAMPO TRILHO CRISTAL 10X1

Código: Fábrica: Unidade:
9772 DAC PT/10
F1 F4

UN: R\$ 3,30 AV: R\$ 33,02 15: R\$ 33,70
30: R\$ 34,38 45: R\$ 35,06 60: R\$ 35,77



PASTA PP OF GRAMPO TRILHO CRISTAL 10X1

Código: Fábrica: Unidade:
46215 ACP PT/10
F1 F4

UN: R\$ 3,24 AV: R\$ 32,42 15: R\$ 33,10
30: R\$ 33,76 45: R\$ 34,44 60: R\$ 35,13



PASTA PP OF GRAMPO TRILHO FUME TRAN 10X1

Código: Fábrica: Unidade:
29196 ALAPLAST PT/10
F1 F4

UN: R\$ 3,08 AV: R\$ 30,81 15: R\$ 31,45
30: R\$ 32,08 45: R\$ 32,72 60: R\$ 33,37

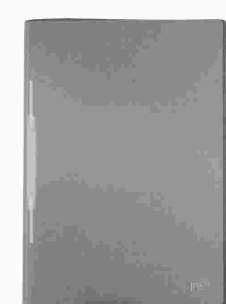

PASTA PP OF GRAMPO TRILHO FUME 10X1

Código: Fábrica: Unidade:
8932 DAC PT/10
F1 F4

UN: R\$ 3,30 AV: R\$ 33,02 15: R\$ 33,70
30: R\$ 34,38 45: R\$ 35,06 60: R\$ 35,77

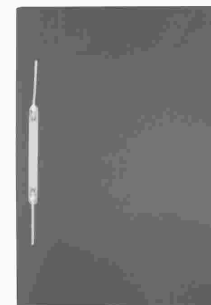

PASTA PP OF GRAMPO TRILHO FUME 10X1

Código: Fábrica: Unidade:
46216 ACP PT/10
F1 F4

UN: R\$ 28,95 AV: R\$ 28,95 15: R\$ 29,55
30: R\$ 30,14 45: R\$ 30,75 60: R\$ 31,36



PASTA PP SANFONA A4 12 DIV AZUL 1027

Código: Fábrica: Unidade:
34127 ACP UN/1
F1 F4

UN: R\$ 28,95 AV: R\$ 28,95 15: R\$ 29,55
30: R\$ 30,14 45: R\$ 30,75 60: R\$ 31,36



PASTA PP SANFONA A4 12 DIV CRISTAL 1027

Código: Fábrica: Unidade:
15847 ACP UN/1
F1 F4

UN: R\$ 28,95 AV: R\$ 28,95 15: R\$ 29,55
30: R\$ 30,14 45: R\$ 30,75 60: R\$ 31,36



PASTA PP SANFONA A4 12 DIV FUME 1027

Código: Fábrica: Unidade:
8972 ACP UN/1
F1 F4

UN: R\$ 28,95 AV: R\$ 28,95 15: R\$ 29,55
30: R\$ 30,14 45: R\$ 30,75 60: R\$ 31,36



PASTA PP SANFONA A4 12 DIV LILAS 1027
Código: Fábrica: Unidade:
46170 ACP UN/1
F1 F4

UN: R\$ 69,49 AV: R\$ 69,49 15: R\$ 70,94
30: R\$ 72,36 45: R\$ 73,81 60: R\$ 75,28



PASTA PP SANFONA A4 31 DIV FUME 1045
Código: Fábrica: Unidade:
15856 ACP UN/1
F1 F4

UN: R\$ 19,11 AV: R\$ 19,11 15: R\$ 19,51
30: R\$ 19,90 45: R\$ 20,30 60: R\$ 20,71



PASTA PP SANFONA CHEQUE 12 DIV CRISTAL
Código: Fábrica: Unidade:
32383 ACP/POLIBRA UN/1
F1 F4

UN: R\$ 42,34 AV: R\$ 42,34 15: R\$ 43,22
30: R\$ 44,09 45: R\$ 44,97 60: R\$ 45,87



PASTA PP SANFONA CHEQUE 31 DIV CRISTAL
Código: Fábrica: Unidade:
8975 ACP UN/1
F1 F4

UN: R\$ 42,34 AV: R\$ 42,34 15: R\$ 43,22
30: R\$ 44,09 45: R\$ 44,97 60: R\$ 45,87



PASTA PP SANFONA CHEQUE 31 DIV FUME
Código: Fábrica: Unidade:
31610 ACP PLASCONY UN/1
F1 F4

UN: R\$ 22,00 AV: R\$ 22,00 15: R\$ 22,46
30: R\$ 22,91 45: R\$ 23,36 60: R\$ 23,83

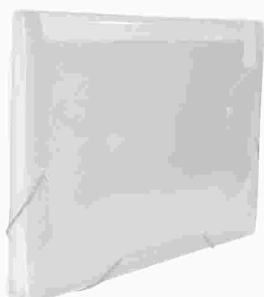

PASTA PP SANFONA DUPLIC 12 DIV CRISTAL
Código: Fábrica: Unidade:
34122 ACP UN/1
F1 F4

UN: R\$ 22,00 AV: R\$ 22,00 15: R\$ 22,46
30: R\$ 22,91 45: R\$ 23,36 60: R\$ 23,83

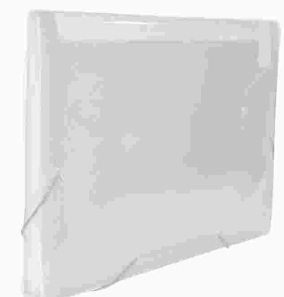

PASTA PP SANFONA DUPLIC 12 DIV FUME
Código: Fábrica: Unidade:
46171 ACP UN/1
F1 F4

UN: R\$ 49,23 AV: R\$ 49,23 15: R\$ 50,26
30: R\$ 51,26 45: R\$ 52,29 60: R\$ 53,34



PASTA PP SANFONA DUPLIC 31 DIV CRISTAL
Código: Fábrica: Unidade:
8973 ACP UN/1
F1 F4

UN: R\$ 49,23 AV: R\$ 49,23 15: R\$ 50,26
30: R\$ 51,26 45: R\$ 52,29 60: R\$ 53,34



PASTA PP SANFONA DUPLIC 31 DIV FUME
Código: Fábrica: Unidade:
14352 ACP UN/1
F1 F4

UN: R\$ 36,59 AV: R\$ 36,59 15: R\$ 37,36
30: R\$ 38,10 45: R\$ 38,87 60: R\$ 39,64



PASTA PP SANFONADA OF 12 DIV CRISTAL
Código: Fábrica: Unidade:
32395 ACP UN/1
F1 F4

UN: R\$ 43,44 AV: R\$ 173,75 15: R\$ 177,37
30: R\$ 180,92 45: R\$ 184,54 60: R\$ 188,23



PASTA PP SANFONADA A4 12 DIV CRISTAL 6X1
Código: Fábrica: Unidade:
42013 PLASCONY CX/4
F1 F4

UN: R\$ 85,06 AV: R\$ 340,23 15: R\$ 347,32
30: R\$ 354,26 45: R\$ 361,35 60: R\$ 368,58

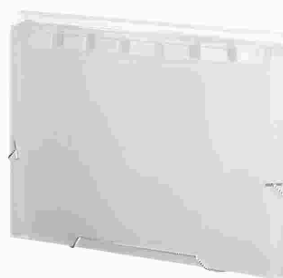

PASTA PP SANFONADA A4 31 DIV CRISTAL 4X1
Código: Fábrica: Unidade:
42883 PLASCONY CX/4
F1 F4

UN: R\$ 52,13 AV: R\$ 208,50 15: R\$ 212,85
30: R\$ 217,11 45: R\$ 221,45 60: R\$ 225,88

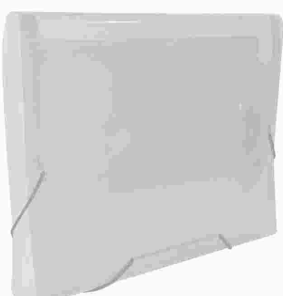

PASTA PP SANFONADA SLIM 31 DIV CRIS 4X1
Código: Fábrica: Unidade:
42009 PLASCONY CX/4
F1 F4

UN: R\$ 52,13 AV: R\$ 208,50 15: R\$ 212,85
30: R\$ 217,11 45: R\$ 221,45 60: R\$ 225,88



PASTA PP SANFONADA SLIM 31 DIV FUME 4X1
Código: Fábrica: Unidade:
42010 PLASCONY CX/4
F1 F4

UN: R\$ 27,61 AV: R\$ 165,64 15: R\$ 169,09
30: R\$ 172,48 45: R\$ 175,93 60: R\$ 179,44

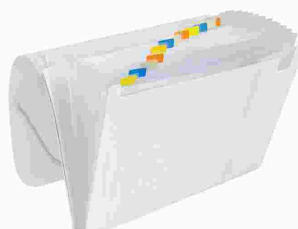

PASTA PP SANFONADA 1/2 OF 12 DIV CRI 6X1
Código: Fábrica: Unidade:
42012 PLASCONY CX/6
F1 F4

UN: R\$ 7,18 AV: R\$ 35,90 15: R\$ 36,65
30: R\$ 37,38 45: R\$ 38,13 60: R\$ 38,89

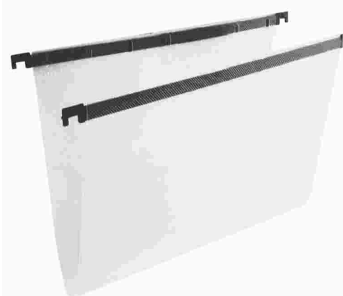

PASTA PP SUSPensa TRANSP CRISTAL 155 5X1
Código: Fábrica: Unidade:
9017 ACP PT/5
F1 F4

UN: R\$ 2,19 AV: R\$ 21,94 15: R\$ 21,94
30: R\$ 21,94 45: R\$ 21,94 60: R\$ 21,94



PASTA PP 1/2 OF AZUL OPACA 10X1

Código: 30443 Fábrica: SUPER LINE Unidade: PT/10 F1 F4

UN: R\$ 2,19 AV: R\$ 21,94 15: R\$ 21,94
30: R\$ 21,94 45: R\$ 21,94 60: R\$ 21,94

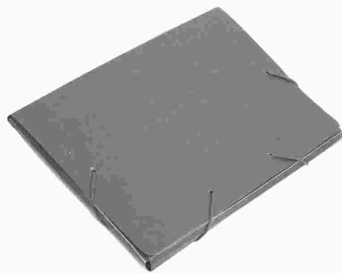

PASTA PP 1/2 OF CINZA OPACA 10X1

Código: 30441 Fábrica: SUPER LINE Unidade: PT/10 F1 F4

UN: R\$ 2,19 AV: R\$ 21,94 15: R\$ 21,94
30: R\$ 21,94 45: R\$ 21,94 60: R\$ 21,94

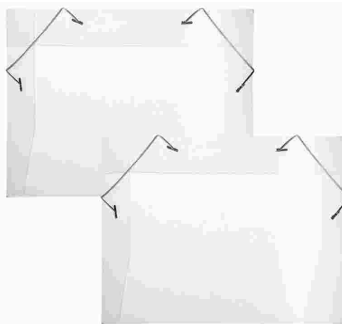

PASTA PP 1/2 OF CRISTAL 10X1

Código: 3066 Fábrica: ALAPLAST Unidade: PT/10 F1 F4

UN: R\$ 2,19 AV: R\$ 21,94 15: R\$ 21,94
30: R\$ 21,94 45: R\$ 21,94 60: R\$ 21,94

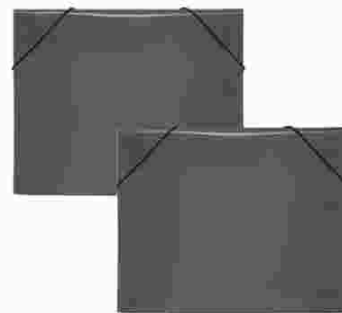

PASTA PP 1/2 OF FUME 10X1

Código: 9755 Fábrica: ALAPLAST Unidade: PT/10 F1 F4

UN: R\$ 2,19 AV: R\$ 21,94 15: R\$ 21,94
30: R\$ 21,94 45: R\$ 21,94 60: R\$ 21,94



PASTA PP 1/2 OF LARANJA OPACA 10X1

Código: 12596 Fábrica: SUPER LINE Unidade: PT/10 F1 F4

UN: R\$ 2,19 AV: R\$ 21,94 15: R\$ 21,94
30: R\$ 21,94 45: R\$ 21,94 60: R\$ 21,94

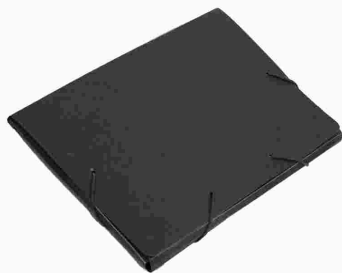

PASTA PP 1/2 OF PRETO OPACA 10X1

Código: 30442 Fábrica: SUPER LINE Unidade: PT/10 F1 F4

UN: R\$ 2,19 AV: R\$ 21,94 15: R\$ 21,94
30: R\$ 21,94 45: R\$ 21,94 60: R\$ 21,94



PASTA PP 1/2 OF SORTIDO 10X1

Código: 30446 Fábrica: ALAPLAST Unidade: PT/10 F1 F4

UN: R\$ 2,19 AV: R\$ 21,94 15: R\$ 21,94
30: R\$ 21,94 45: R\$ 21,94 60: R\$ 21,94



PASTA PP 1/2 OF VERDE CIT OPACA 10X1

Código: 30493 Fábrica: SUPER LINE Unidade: PT/10 F1 F4

UN: R\$ 2,19 AV: R\$ 21,94 15: R\$ 21,94
30: R\$ 21,94 45: R\$ 21,94 60: R\$ 21,94



PASTA PP 1/2 OF VERMELHO 10X1

Código: 19480 Fábrica: SUPER LINE Unidade: PT/10 F1 F4

UN: R\$ 2,29 AV: R\$ 22,94 15: R\$ 22,94
30: R\$ 22,94 45: R\$ 22,94 60: R\$ 22,94

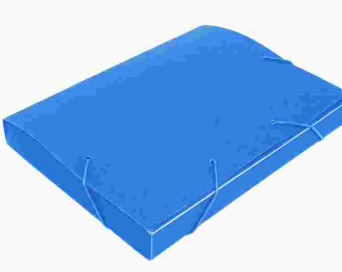

PASTA PP 1/2 OF 2 CM AZUL OPACA 10X1

Código: 27749 Fábrica: SUPER LINE Unidade: PT/10 F1 F4

UN: R\$ 2,29 AV: R\$ 22,94 15: R\$ 22,94
30: R\$ 22,94 45: R\$ 22,94 60: R\$ 22,94

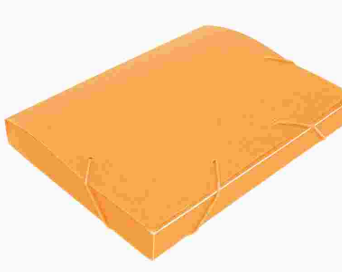

PASTA PP 1/2 OF 2 CM LARANJA OPACA 10X1

Código: 27745 Fábrica: SUPER LINE Unidade: PT/10 F1 F4

UN: R\$ 2,29 AV: R\$ 22,94 15: R\$ 22,94
30: R\$ 22,94 45: R\$ 22,94 60: R\$ 22,94



PASTA PP 1/2 OF 2 CM LILAS OPACA 10X1

Código: 27746 Fábrica: SUPER LINE Unidade: PT/10 F1 F4

UN: R\$ 2,29 AV: R\$ 22,94 15: R\$ 22,94
30: R\$ 22,94 45: R\$ 22,94 60: R\$ 22,94



PASTA PP 1/2 OF 2 CM LILAS 10X1

Código: 8936 Fábrica: ALAPLAST Unidade: PT/10 F1 F4

UN: R\$ 2,29 AV: R\$ 22,94 15: R\$ 22,94
30: R\$ 22,94 45: R\$ 22,94 60: R\$ 22,94



PASTA PP 1/2 OF 2 CM ROSA OPACA 10X1

Código: 27748 Fábrica: SUPER LINE Unidade: PT/10 F1 F4

UN: R\$ 2,29 AV: R\$ 22,94 15: R\$ 22,94
30: R\$ 22,94 45: R\$ 22,94 60: R\$ 22,94



PASTA PP 1/2 OF 2 CM ROSA 10X1

Código: 43844 Fábrica: ALAPLAST Unidade: PT/10 F1 F4

UN: R\$ 2,29 AV: R\$ 22,94 15: R\$ 22,94
30: R\$ 22,94 45: R\$ 22,94 60: R\$ 22,94

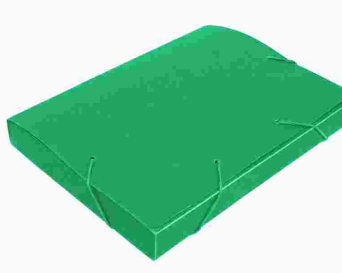

PASTA PP 1/2 OF 2 CM VERDE OPACA 10X1

Código: 30491 Fábrica: SUPER LINE Unidade: PT/10 F1 F4

UN: R\$ 2,29 AV: R\$ 22,94 15: R\$ 22,94
30: R\$ 22,94 45: R\$ 22,94 60: R\$ 22,94



PASTA PP 1/2 OF 2 CM VERDE 10X1

Código: 43845 Fábrica: ALAPLAST Unidade: PT/10 F1 F4

UN: R\$ 2,29 AV: R\$ 22,94 15: R\$ 22,94
30: R\$ 22,94 45: R\$ 22,94 60: R\$ 22,94



PASTA PP 1/2 OF 2 CM VERMELHO OPACA 10X1

Código: 27753 Fábrica: SUPER LINE Unidade: PT/10 F1 F4

UN: R\$ 4,49 AV: R\$ 44,94 15: R\$ 44,94
30: R\$ 44,94 45: R\$ 44,94 60: R\$ 44,94

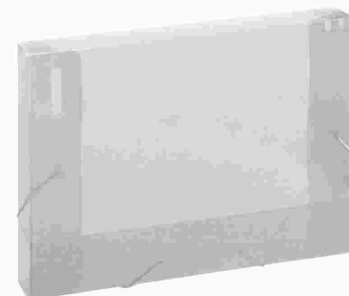

PASTA PP 1,7 CM CRISTAL TRANSP 10X1

Código: 46074 Fábrica: ALAPLAST Unidade: PT/10 F1 F4

UN: R\$ 4,49 AV: R\$ 44,94 15: R\$ 44,94
30: R\$ 44,94 45: R\$ 44,94 60: R\$ 44,94

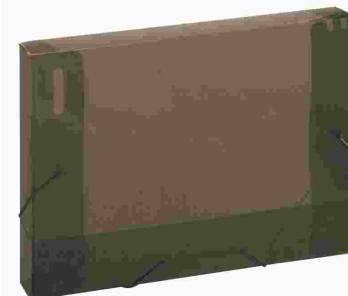

PASTA PP 1,7 CM FUME TRANSP 10X1

Código: 46075 Fábrica: ALAPLAST Unidade: PT/10 F1 F4

UN: R\$ 4,99 AV: R\$ 49,94 15: R\$ 49,94
30: R\$ 49,94 45: R\$ 49,94 60: R\$ 49,94

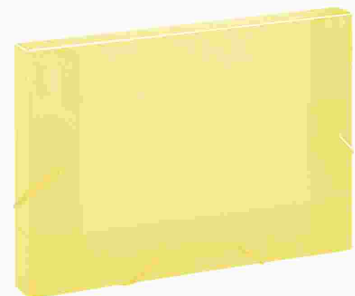

PASTA PP 2 CM AMARELA 10X1

Código: 15872 Fábrica: ALAPLAST Unidade: PT/10 F1 F4

UN: R\$ 4,99 AV: R\$ 49,94 15: R\$ 49,94
30: R\$ 49,94 45: R\$ 49,94 60: R\$ 49,94

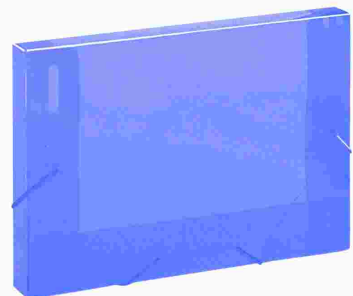

PASTA PP 2 CM AZUL 1022 10X1

Código: 15875 Fábrica: ACP Unidade: PT/10 F1 F4

UN: R\$ 4,99 AV: R\$ 49,94 15: R\$ 49,94
30: R\$ 49,94 45: R\$ 49,94 60: R\$ 49,94

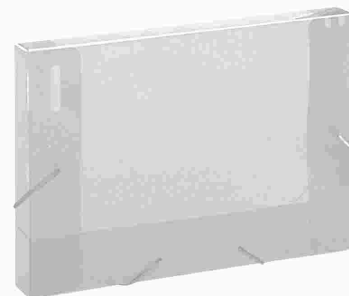

PASTA PP 2 CM CRISTAL 1022 10X1

Código: 9761 Fábrica: ACP Unidade: PT/10 F1 F4

UN: R\$ 4,99 AV: R\$ 49,94 15: R\$ 49,94
30: R\$ 49,94 45: R\$ 49,94 60: R\$ 49,94

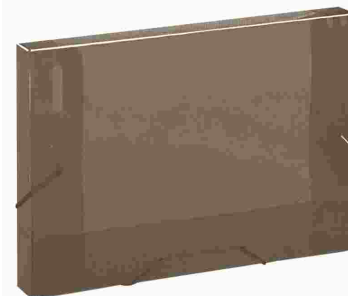

PASTA PP 2 CM FUME 1022 10X1

Código: 9763 Fábrica: ACP/ALAPLAST Unidade: PT/10 F1 F4

UN: R\$ 4,99 AV: R\$ 49,94 15: R\$ 49,94
30: R\$ 49,94 45: R\$ 49,94 60: R\$ 49,94

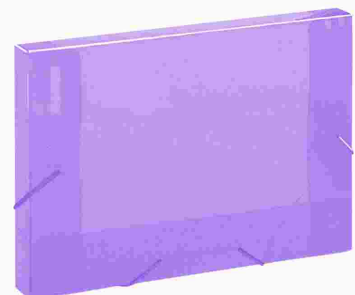

PASTA PP 2 CM LILAS 10X1

Código: 42935 Fábrica: ALAPLAST Unidade: PT/10 F1 F4

UN: R\$ 4,99 AV: R\$ 49,94 15: R\$ 49,94
30: R\$ 49,94 45: R\$ 49,94 60: R\$ 49,94

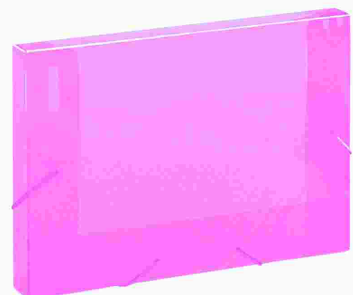

PASTA PP 2 CM ROSA 1022 10X1

Código: 19481 Fábrica: ACP Unidade: PT/10 F1 F4

UN: R\$ 4,99 AV: R\$ 49,94 15: R\$ 49,94
30: R\$ 49,94 45: R\$ 49,94 60: R\$ 49,94

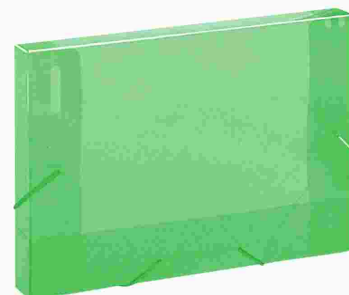

PASTA PP 2 CM VERDE 10X1

Código: 9762 Fábrica: ALAPLAST Unidade: PT/10 F1 F4

UN: R\$ 4,99 AV: R\$ 49,94 15: R\$ 49,94
30: R\$ 49,94 45: R\$ 49,94 60: R\$ 49,94

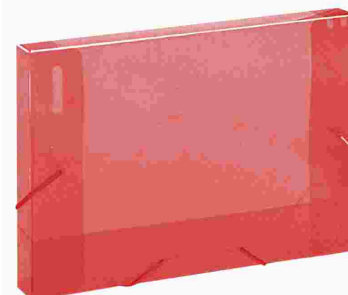

PASTA PP 2 CM VERMELHA 1022 10X1

Código: 9765 Fábrica: ACP/ALA Unidade: PT/10 F1 F4

UN: R\$ 5,29 AV: R\$ 52,94 15: R\$ 52,94
30: R\$ 52,94 45: R\$ 52,94 60: R\$ 52,94

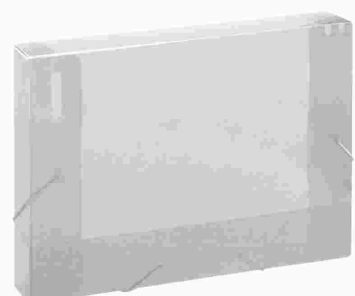

PASTA PP 3 CM CRISTAL TRANSP 10X1

Código: 14355 Fábrica: ALAPLAST Unidade: PT/10 F1 F4

UN: R\$ 5,29 AV: R\$ 52,94 15: R\$ 52,94
30: R\$ 52,94 45: R\$ 52,94 60: R\$ 52,94

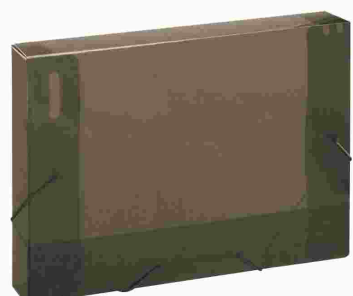

PASTA PP 3 CM FUME TRANSP 10X1

Código: 14356 Fábrica: ALAPLAST Unidade: PT/10 F1 F4

UN: R\$ 5,69 AV: R\$ 56,94 15: R\$ 56,94
30: R\$ 56,94 45: R\$ 56,94 60: R\$ 56,94

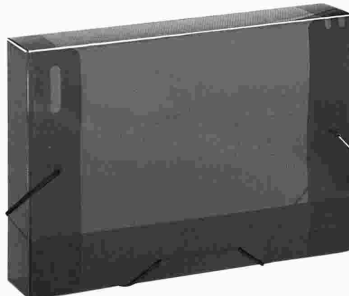

PASTA PP 4 CM PRETA 10X1

Código: 15865 Fábrica: ALAPLAST Unidade: PT/10 F1 F4

UN: R\$ 5,69 AV: R\$ 56,94 15: R\$ 56,94
30: R\$ 56,94 45: R\$ 56,94 60: R\$ 56,94



PASTA PP 4 CM AMARELO 10X1

Código: 15863 Fábrica: ALAPLAST Unidade: PT/10 F1 F4

UN: R\$ 5,69 AV: R\$ 56,94 15: R\$ 56,94
30: R\$ 56,94 45: R\$ 56,94 60: R\$ 56,94



PASTA PP 4 CM AZUL 1024 10X1

Código: **15885** Fábrica: ACP/ALAPLAST Unidade: PT/10
F1 F4

UN: R\$ 5,69 AV: R\$ 56,94 15: R\$ 56,94
30: R\$ 56,94 45: R\$ 56,94 60: R\$ 56,94

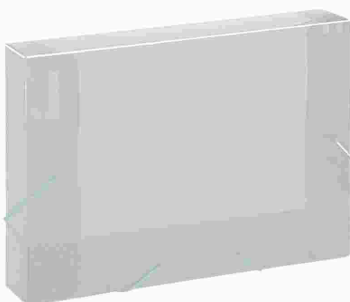

PASTA PP 4 CM CRISTAL TRANSP 10X1

Código: **9768** Fábrica: ALAPLAST Unidade: PT/10
F1 F4

UN: R\$ 5,69 AV: R\$ 56,94 15: R\$ 56,94
30: R\$ 56,94 45: R\$ 56,94 60: R\$ 56,94

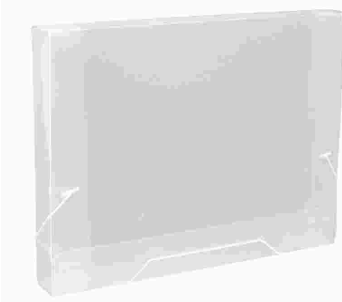

PASTA PP 4 CM CRISTAL 1024 10X1

Código: **15886** Fábrica: ACP Unidade: PT/10
F1 F4

UN: R\$ 6,81 AV: R\$ 68,06 15: R\$ 69,48
30: R\$ 70,86 45: R\$ 72,28 60: R\$ 73,73

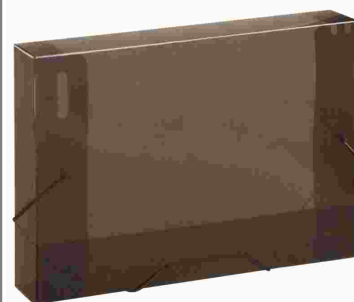

PASTA PP 4 CM FUME TRANSP 10X1

Código: **34124** Fábrica: ALAPLAST Unidade: PT/10
F1 F4

UN: R\$ 5,69 AV: R\$ 56,94 15: R\$ 56,94
30: R\$ 56,94 45: R\$ 56,94 60: R\$ 56,94

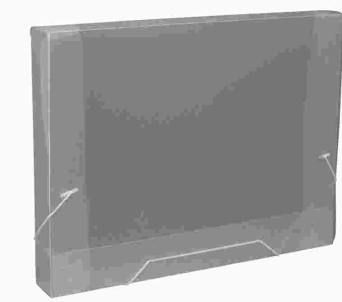

PASTA PP 4 CM FUME 1024 10X1

Código: **15889** Fábrica: ACP Unidade: PT/10
F1 F4

UN: R\$ 5,69 AV: R\$ 56,94 15: R\$ 56,94
30: R\$ 56,94 45: R\$ 56,94 60: R\$ 56,94

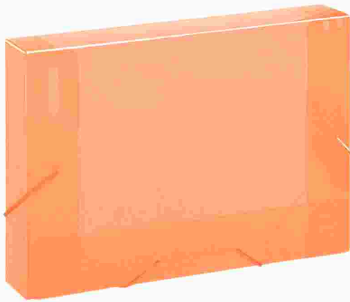

PASTA PP 4 CM LARANJA 10X1

Código: **42067** Fábrica: ALAPLAST Unidade: PT/10
F1 F4

UN: R\$ 5,69 AV: R\$ 56,94 15: R\$ 56,94
30: R\$ 56,94 45: R\$ 56,94 60: R\$ 56,94

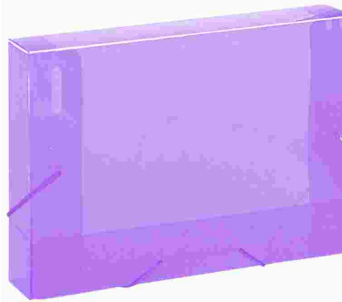

PASTA PP 4 CM LILAS 10X1

Código: **42039** Fábrica: ALAPLAST Unidade: PT/10
F1 F4

UN: R\$ 5,69 AV: R\$ 56,94 15: R\$ 56,94
30: R\$ 56,94 45: R\$ 56,94 60: R\$ 56,94



PASTA PP 4 CM ROSA 1024 10X1

Código: **41946** Fábrica: ACP Unidade: PT/10
F1 F4

UN: R\$ 5,69 AV: R\$ 56,94 15: R\$ 56,94
30: R\$ 56,94 45: R\$ 56,94 60: R\$ 56,94

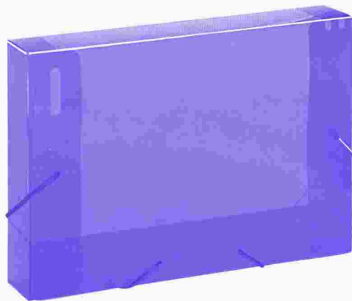

PASTA PP 4 CM ROXO 10X1

Código: **41985** Fábrica: ALAPLAST Unidade: PT/10
F1 F4

UN: R\$ 5,69 AV: R\$ 56,94 15: R\$ 56,94
30: R\$ 56,94 45: R\$ 56,94 60: R\$ 56,94

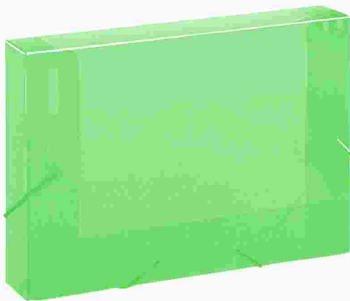

PASTA PP 4 CM VERDE 10X1

Código: **15867** Fábrica: ALAPLAST Unidade: PT/10
F1 F4

UN: R\$ 5,69 AV: R\$ 56,94 15: R\$ 56,94
30: R\$ 56,94 45: R\$ 56,94 60: R\$ 56,94

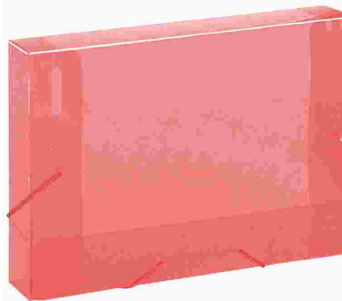

PASTA PP 4 CM VERMELHO 1024 10X1

Código: **15868** Fábrica: ACP Unidade: PT/10
F1 F4

UN: R\$ 8,10 AV: R\$ 8,10 15: R\$ 8,27
30: R\$ 8,43 45: R\$ 8,60 60: R\$ 8,77

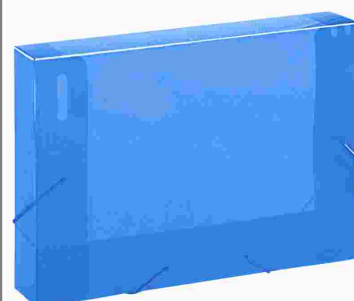

PASTA PP 5,5 CM UN

Código: **14358** Fábrica: VMP Unidade: UN/1
F1 F4

UN: R\$ 6,79 AV: R\$ 67,94 15: R\$ 67,94
30: R\$ 67,94 45: R\$ 67,94 60: R\$ 67,94

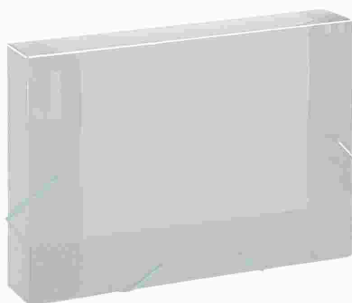

PASTA PP 5,5 CM CRISTAL TRANS 10X1

Código: **34123** Fábrica: ALAPLAST Unidade: PT/10
F1 F4

UN: R\$ 6,79 AV: R\$ 67,94 15: R\$ 67,94
30: R\$ 67,94 45: R\$ 67,94 60: R\$ 67,94

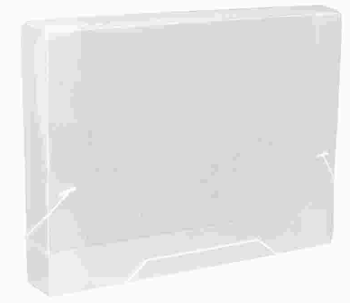

PASTA PP 5,5 CM CRISTAL 1025 10X1

Código: **46205** Fábrica: ACP Unidade: PT/10
F1 F4

UN: R\$ 6,79 AV: R\$ 67,94 15: R\$ 67,94
30: R\$ 67,94 45: R\$ 67,94 60: R\$ 67,94

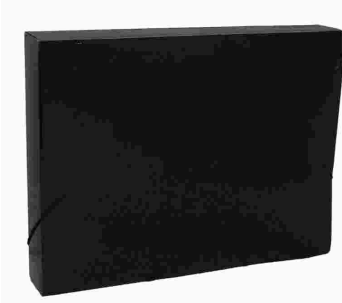

PASTA PP 5,5 CM FUME TRANSP 10X1

Código: **44331** Fábrica: ALAPLAST Unidade: PT/10
F1 F4

UN: R\$ 6,79 AV: R\$ 67,94 15: R\$ 67,94
30: R\$ 67,94 45: R\$ 67,94 60: R\$ 67,94

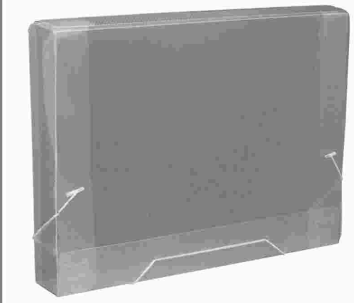

PASTA PP 5,5 CM FUME 1025 10X1

Código: **46206** Fábrica: ACP Unidade: PT/10
F1 F4

UN: R\$ 6,88 AV: R\$ 68,82 15: R\$ 70,26
30: R\$ 71,66 45: R\$ 73,09 60: R\$ 74,56



PASTA PP 6 CM CRISTAL 10X1

Código: 30434 Fábrica: ALAPLAST Unidade: PT/10 F1 F4

UN: R\$ 86,27 AV: R\$ 86,27 15: R\$ 88,07
30: R\$ 89,83 45: R\$ 91,63 60: R\$ 93,46



PASTA SANFONA PAPELAO OFIC A-Z

Código: 45963 Fábrica: DELUCAS Unidade: UN/1 F1 F4

UN: R\$ 3,08 AV: R\$ 154,07 15: R\$ 157,28
30: R\$ 160,43 45: R\$ 163,63 60: R\$ 166,91



PASTA SUSPENSA HT PVC KRAFT KC 50X1

Código: 18085 Fábrica: TP PASTAS Unidade: CX/50 F1 F4

UN: R\$ 3,70 AV: R\$ 184,89 15: R\$ 188,74
30: R\$ 192,51 45: R\$ 196,36 60: R\$ 200,29



PASTA SUSPENSA HT PVC MARM CAST MC 50X1

Código: 44636 Fábrica: TP PASTAS Unidade: CX/50 F1 F4

UN: R\$ 5,34 AV: R\$ 267,06 15: R\$ 272,63
30: R\$ 278,08 45: R\$ 283,64 60: R\$ 289,31



PASTA SUSPENSA HT PVC MARM PL CAST 50X1

Código: 42854 Fábrica: DELLO/TPPAST Unidade: CX/50 F1 F4

UN: R\$ 4,25 AV: R\$ 106,15 15: R\$ 108,36
30: R\$ 110,53 45: R\$ 112,74 60: R\$ 115,00



PASTA SUSPENSA KRAFT NATURAL 25X1

Código: 37444 Fábrica: ACRIMET Unidade: PT/25 F1 F4

UN: R\$ 5,03 AV: R\$ 50,32 15: R\$ 51,37
30: R\$ 52,40 45: R\$ 53,45 60: R\$ 54,52



PASTA SUSPENSA MARM HT PLAST 10X1

Código: 51133 Fábrica: POLYCART Unidade: PT/10 F1 F4

UN: R\$ 3,70 AV: R\$ 36,97 15: R\$ 37,74
30: R\$ 38,49 45: R\$ 39,26 60: R\$ 40,05



PASTA SUSPENSA MARM LISA HT PLAST 10X1

Código: 27075 Fábrica: POLYCART Unidade: PT/10 F1 F4

UN: R\$ 4,11 AV: R\$ 41,08 15: R\$ 41,93
30: R\$ 42,77 45: R\$ 43,63 60: R\$ 44,50



PASTA SUSPENSA MARM PLAST HT PLAST 10X1

Código: 49996 Fábrica: POLYCART Unidade: PT/10 F1 F4

UN: R\$ 5,45 AV: R\$ 54,54 15: R\$ 55,68
30: R\$ 56,79 45: R\$ 57,93 60: R\$ 59,09



PASTA SUSPENSA MARM PLAST HT PLAST 10X1

Código: 51131 Fábrica: POLYCART Unidade: PT/10 F1 F4

UN: R\$ 4,75 AV: R\$ 47,46 15: R\$ 48,45
30: R\$ 49,41 45: R\$ 50,40 60: R\$ 51,41



PASTA SUSPENSA MARM PLAST HT PLAST 10X1

Código: 51135 Fábrica: POLYCART Unidade: PT/10 F1 F4

UN: R\$ 5,90 AV: R\$ 147,44 15: R\$ 150,51
30: R\$ 153,52 45: R\$ 156,59 60: R\$ 159,72



PASTA SUSPENSA MARM PLAST HT PVC 25X1

Código: 47804 Fábrica: POLYCART Unidade: PT/25 F1 F4

UN: R\$ 3,41 AV: R\$ 170,50 15: R\$ 174,06
30: R\$ 177,54 45: R\$ 181,09 60: R\$ 184,71



PASTA SUSPENSA MARM S KRAF HT PLAST 50X1

Código: 49995 Fábrica: POLYCART Unidade: PT/50 F1 F4

UN: R\$ 4,23 AV: R\$ 211,34 15: R\$ 215,74
30: R\$ 220,05 45: R\$ 224,45 60: R\$ 228,94



PASTA SUSPENSA MARM S KRAF HT PLAST 50X1

Código: 51132 Fábrica: POLYCART Unidade: PT/50 F1 F4

UN: R\$ 7,08 AV: R\$ 70,76 15: R\$ 72,24
30: R\$ 73,68 45: R\$ 75,16 60: R\$ 76,66



PASTA SUSPENSA MARMORE GRAMPO METAL 10X1

Código: 44447 Fábrica: POLYCART Unidade: PT/10 F1 F4

UN: R\$ 3,30 AV: R\$ 3,30 15: R\$ 3,37
30: R\$ 3,44 45: R\$ 3,51 60: R\$ 3,58

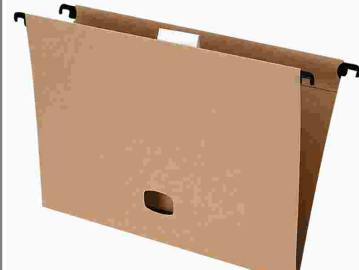

PASTA SUSPENSA MARMORIZADA UN

Código: 42141 Fábrica: TP Unidade: UN/1 F1 F4

UN: R\$ 30,81 AV: R\$ 30,81 15: R\$ 31,45
30: R\$ 32,08 45: R\$ 32,72 60: R\$ 33,37



PEN DRIVE 4 GB USB 2.0
Código: Fábrica: Unidade:
20790 MULTILASER UN/1
F1 F4

UN: R\$ 34,91 AV: R\$ 34,91 15: R\$ 35,64
30: R\$ 36,35 45: R\$ 37,08 60: R\$ 37,82



PEN DRIVE 8 GB USB 2.0
Código: Fábrica: Unidade:
25947 INOVA UN/1
F1 F4

UN: R\$ 41,08 AV: R\$ 41,08 15: R\$ 41,93
30: R\$ 42,77 45: R\$ 43,63 60: R\$ 44,50



PEN DRIVE 16 GB USB 2.0
Código: Fábrica: Unidade:
35870 MAKETECH UN/1
F1 F4

UN: R\$ 51,35 AV: R\$ 51,35 15: R\$ 52,42
30: R\$ 53,47 45: R\$ 54,54 60: R\$ 55,63



PEN DRIVE 32 GB USB 2.0
Código: Fábrica: Unidade:
35871 MAKETECH UN/1
F1 F4

UN: R\$ 69,84 AV: R\$ 69,84 15: R\$ 71,29
30: R\$ 72,72 45: R\$ 74,17 60: R\$ 75,66



PEN DRIVE 64 GB USB 2.0 METAL DIAMOND
Código: Fábrica: Unidade:
42432 MULTILASER UN/1
F1 F4

UN: R\$ 174,61 AV: R\$ 174,61 15: R\$ 178,25
30: R\$ 181,82 45: R\$ 185,45 60: R\$ 189,16



PEN DRIVE 128 GB USB 2.0
Código: Fábrica: Unidade:
42430 MULTILASER UN/1
F1 F4

UN: R\$ 0,04 AV: R\$ 3,89 15: R\$ 3,97
30: R\$ 4,05 45: R\$ 4,13 60: R\$ 4,22



PERCEVEJO LATONADO DOURADO 96036 100X1
Código: Fábrica: Unidade:
40974 JOCAROFFICE CX/100
F1 F4

UN: R\$ 0,04 AV: R\$ 3,89 15: R\$ 3,97
30: R\$ 4,05 45: R\$ 4,13 60: R\$ 4,22



PERCEVEJO LATONADO 100X1
Código: Fábrica: Unidade:
13243 BRW CE/100
F1 F4

UN: R\$ 8,21 AV: R\$ 8,21 15: R\$ 8,38
30: R\$ 8,55 45: R\$ 8,72 60: R\$ 8,89



PERFURADOR METAL FURO UNICO 6MM 6FLS 804
Código: Fábrica: Unidade:
39779 MASTERPRINT CR/1
F1 F4

UN: R\$ 28,75 AV: R\$ 28,75 15: R\$ 29,35
30: R\$ 29,94 45: R\$ 30,54 60: R\$ 31,15



PERFURADOR METAL MED 2 FUROS 20FLS 2000
Código: Fábrica: Unidade:
14670 BRW/EASYOFFI UN/1
F1 F4

UN: R\$ 9,23 AV: R\$ 9,23 15: R\$ 9,43
30: R\$ 9,62 45: R\$ 9,81 60: R\$ 10,00



PERFURADOR METAL PQ 2 FUROS 5FLS 808
Código: Fábrica: Unidade:
41950 YING FA UN/1
F1 F4

UN: R\$ 12,32 AV: R\$ 12,32 15: R\$ 12,57
30: R\$ 12,82 45: R\$ 13,08 60: R\$ 13,34



PERFURADOR METAL 2 FUROS 10FLS V082
Código: Fábrica: Unidade:
39925 VMP UN/1
F1 F4

UN: R\$ 14,12 AV: R\$ 14,12 15: R\$ 14,42
30: R\$ 14,71 45: R\$ 15,00 60: R\$ 15,30



PERFURADOR METAL 2 FUROS 10FLS 7131
Código: Fábrica: Unidade:
46942 YIN'S PAPER UN/1
F1 F4

UN: R\$ 301,99 AV: R\$ 301,99 15: R\$ 308,28
30: R\$ 314,44 45: R\$ 320,73 60: R\$ 327,15



PERFURADOR METAL 2 FUROS 100FLS GUIA 91
Código: Fábrica: Unidade:
46921 YIN'S PAPER UN/1
F1 F4

UN: R\$ 25,67 AV: R\$ 25,67 15: R\$ 26,20
30: R\$ 26,73 45: R\$ 27,26 60: R\$ 27,81



PERFURADOR METAL 2 FUROS 20FLS 801
Código: Fábrica: Unidade:
39783 MASTERPRINT UN/1
F1 F4

UN: R\$ 44,38 AV: R\$ 44,38 15: R\$ 45,30
30: R\$ 46,21 45: R\$ 47,13 60: R\$ 48,07



PERFURADOR METAL 2 FUROS 25FLS C/GUIA
Código: Fábrica: Unidade:
46431 KAZ UN/1
F1 F4

UN: R\$ 27,72 AV: R\$ 27,72 15: R\$ 28,30
30: R\$ 28,87 45: R\$ 29,45 60: R\$ 30,03



PERFURADOR METAL 2 FUROS 25FLS GUIA 790
Código: Fábrica: Unidade:
46928 YIN'S PAPER UN/1
F1 F4

UN: R\$ 59,57 AV: R\$ 59,57 15: R\$ 60,81
30: R\$ 62,02 45: R\$ 63,27 60: R\$ 64,53



PERFURADOR METAL 2 FUROS 35FLS C/GUIA
Código: Fábrica: Unidade:
6565 BRW UN/1
F1 F4

UN: R\$ 56,49 AV: R\$ 56,49 15: R\$ 57,66
30: R\$ 58,82 45: R\$ 59,99 60: R\$ 61,19



PERFURADOR METAL 2 FUROS 35FLS 083
Código: Fábrica: Unidade:
42408 VMP UN/1
F1 F4

UN: R\$ 49,30 AV: R\$ 49,30 15: R\$ 50,32
30: R\$ 51,33 45: R\$ 52,36 60: R\$ 53,40



PERFURADOR METAL 2 FUROS 40FLS 802
Código: Fábrica: Unidade:
41957 MASTERPRINT UN/1
F1 F4

UN: R\$ 143,80 AV: R\$ 143,80 15: R\$ 146,79
30: R\$ 149,73 45: R\$ 152,72 60: R\$ 155,78



PERFURADOR METAL 2 FUROS 50 FLS 93022
Código: Fábrica: Unidade:
46368 JOCAROFFICE UN/1
F1 F4

UN: R\$ 136,38 AV: R\$ 136,38 15: R\$ 139,22
30: R\$ 142,01 45: R\$ 144,85 60: R\$ 147,74



PERFURADOR METAL 2 FUROS 60FL GDE C/GUIA
Código: Fábrica: Unidade:
42235 MASTERPRINT UN/1
F1 F4

UN: R\$ 95,52 AV: R\$ 95,52 15: R\$ 97,51
30: R\$ 99,46 45: R\$ 101,45 60: R\$ 103,48



PERFURADOR METAL 2 FUROS 60FLS BM2149
Código: Fábrica: Unidade:
48851 FIRST UN/1
F1 F4

UN: R\$ 186,94 AV: R\$ 186,94 15: R\$ 190,83
30: R\$ 194,65 45: R\$ 198,54 60: R\$ 202,52



PERFURADOR METAL 2 FUROS 70FLS 282205
Código: Fábrica: Unidade:
43019 FUTURO UN/1
F1 F4

UN: R\$ 77,03 AV: R\$ 77,03 15: R\$ 78,63
30: R\$ 80,21 45: R\$ 81,81 60: R\$ 83,45



PERFURADOR PAPEL 2 FUROS 30FLS FUNDIDO
Código: Fábrica: Unidade:
42328 CAVIA UN/1
F1 F4

UN: R\$ 133,53 AV: R\$ 133,53 15: R\$ 136,31
30: R\$ 139,03 45: R\$ 141,81 60: R\$ 144,65



PERFURADOR PAPEL 2 FUROS 60FLS FUNDIDO
Código: Fábrica: Unidade:
42466 CAVIA UN/1
F1 F4

UN: R\$ 338,97 AV: R\$ 338,97 15: R\$ 346,03
30: R\$ 352,95 45: R\$ 360,01 60: R\$ 367,21



PERFURADOR PAPEL 2 FUROS 100FLS FUNDIDO
Código: Fábrica: Unidade:
42318 CAVIA UN/1
F1 F4

UN: R\$ 82,17 AV: R\$ 82,17 15: R\$ 83,88
30: R\$ 85,56 45: R\$ 87,27 60: R\$ 89,01



PERFURADOR PLAST P/EVA EXTRA GIGANTE
Código: Fábrica: Unidade:
48579 RENK UN/1
F1 F4

UN: R\$ 19,51 AV: R\$ 19,51 15: R\$ 19,91
30: R\$ 20,31 45: R\$ 20,72 60: R\$ 21,13



PERFURADOR PLAST P/EVA PEQ FIGURAS SORT
Código: Fábrica: Unidade:
41973 VMP UN/1
F1 F4

UN: R\$ 18,80 AV: R\$ 18,80 15: R\$ 19,19
30: R\$ 19,57 45: R\$ 19,96 60: R\$ 20,36



PERFURADOR PLAST P/EVA 16MM 8438
Código: Fábrica: Unidade:
48139 YIN'S PAPER UN/1
F1 F4

UN: R\$ 30,81 AV: R\$ 30,81 15: R\$ 31,45
30: R\$ 32,08 45: R\$ 32,72 60: R\$ 33,37



PERFURADOR PLAST P/EVA 25MM 8439
Código: Fábrica: Unidade:
46929 YIN'S PAPER UN/1
F1 F4

UN: R\$ 82,17 AV: R\$ 82,17 15: R\$ 83,88
30: R\$ 85,56 45: R\$ 87,27 60: R\$ 89,01



PERFURADOR PLAST P/EVA 38MM 12052
Código: Fábrica: Unidade:
51005 MAKE+ UN/1
F1 F4

UN: R\$ 123,25 AV: R\$ 123,25 15: R\$ 125,82
30: R\$ 128,34 45: R\$ 130,90 60: R\$ 133,52



PERFURADOR PLAST P/EVA 50MM 8440
Código: 46930 Fábrica: YIN'S/MAKE Unidade: UN/1 F1 F4

UN: R\$ 8,21 AV: R\$ 8,21 15: R\$ 8,38
30: R\$ 8,55 45: R\$ 8,72 60: R\$ 8,89

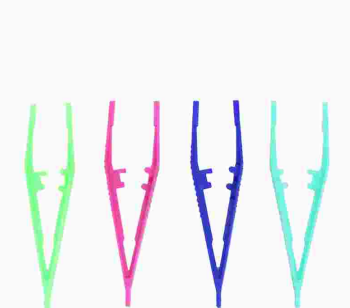

PINÇA PLAST COORDENACAO MOTORA 10,5X1X3C
Código: 44114 Fábrica: PAPIMUNI Unidade: UN/1 F1 F4

UN: R\$ 11,98 AV: R\$ 71,89 15: R\$ 73,39
30: R\$ 74,86 45: R\$ 76,36 60: R\$ 77,88



PINCEL ARTIS CHANF LONG AMA 18 C517 6X1
Código: 50970 Fábrica: CASTELO Unidade: PT/6 F1 F4

UN: R\$ 19,52 AV: R\$ 117,10 15: R\$ 119,54
30: R\$ 121,93 45: R\$ 124,37 60: R\$ 126,86



PINCEL ARTIS LEQUE LONG AMA 04 C513 6X1
Código: 50971 Fábrica: CASTELO Unidade: PT/6 F1 F4

UN: R\$ 23,97 AV: R\$ 143,80 15: R\$ 146,79
30: R\$ 149,73 45: R\$ 152,72 60: R\$ 155,78



PINCEL ARTIS LEQUE LONG AMA 06 C513 6X1
Código: 50972 Fábrica: CASTELO Unidade: PT/6 F1 F4

UN: R\$ 4,79 AV: R\$ 57,52 15: R\$ 58,72
30: R\$ 59,90 45: R\$ 61,09 60: R\$ 62,32



PINCEL ARTIS RED LONG AMA 6 87891 12X1
Código: 45480 Fábrica: CONDOR Unidade: PT/12 F1 F4

UN: R\$ 5,48 AV: R\$ 65,74 15: R\$ 67,11
30: R\$ 68,45 45: R\$ 69,82 60: R\$ 71,22



PINCEL ARTIS RED LONG AMA 8 970927 12X1
Código: 45481 Fábrica: CONDOR Unidade: PT/12 F1 F4

UN: R\$ 5,92 AV: R\$ 71,05 15: R\$ 72,53
30: R\$ 73,98 45: R\$ 75,46 60: R\$ 76,97



PINCEL ARTIS RED LONG AMA 10 970928 12X1
Código: 45482 Fábrica: CONDOR Unidade: PT/12 F1 F4

UN: R\$ 6,71 AV: R\$ 80,52 15: R\$ 82,20
30: R\$ 83,84 45: R\$ 85,52 60: R\$ 87,23



PINCEL ARTIS RED LONG AMA 12 970929 12X1
Código: 45483 Fábrica: CONDOR Unidade: PT/12 F1 F4

UN: R\$ 10,02 AV: R\$ 120,18 15: R\$ 122,69
30: R\$ 125,14 45: R\$ 127,64 60: R\$ 130,20



PINCEL ARTIS RED LONG AMA 18 970932 12X1
Código: 45484 Fábrica: CONDOR Unidade: PT/12 F1 F4

UN: R\$ 17,55 AV: R\$ 105,29 15: R\$ 107,48
30: R\$ 109,63 45: R\$ 111,82 60: R\$ 114,06



PINCEL ARTIS RED LONG AMA 24 970935 6X1
Código: 51042 Fábrica: CONDOR Unidade: PT/6 F1 F4

UN: R\$ 15,11 AV: R\$ 181,30 15: R\$ 185,08
30: R\$ 188,78 45: R\$ 192,56 60: R\$ 196,41



PINCEL ARTIST LINGUA GATO 2 88669 12X1
Código: 42901 Fábrica: CONDOR Unidade: PT/12 F1 F4

UN: R\$ 20,54 AV: R\$ 246,52 15: R\$ 251,65
30: R\$ 256,69 45: R\$ 261,82 60: R\$ 267,06



PINCEL ARTIST LINGUA GATO 6 88671 12X1
Código: 42900 Fábrica: CONDOR Unidade: PT/12 F1 F4

UN: R\$ 9,81 AV: R\$ 117,72 15: R\$ 120,17
30: R\$ 122,57 45: R\$ 125,02 60: R\$ 127,52



PINCEL ARTIST P/PINTURA 0 86836 12X1
Código: 45449 Fábrica: CONDOR Unidade: PT/12 F1 F4

UN: R\$ 10,17 AV: R\$ 122,00 15: R\$ 124,54
30: R\$ 127,03 45: R\$ 129,57 60: R\$ 132,17



PINCEL ARTIST P/PINTURA 00 86837 12X1
Código: 45450 Fábrica: CONDOR Unidade: PT/12 F1 F4

UN: R\$ 9,99 AV: R\$ 119,85 15: R\$ 122,35
30: R\$ 124,80 45: R\$ 127,29 60: R\$ 129,84



PINCEL ARTIST P/PINTURA 000 86838 12X1
Código: 45451 Fábrica: CONDOR Unidade: PT/12 F1 F4

UN: R\$ 2,99 AV: R\$ 35,88 15: R\$ 35,88
30: R\$ 35,88 45: R\$ 35,88 60: R\$ 35,88



PINCEL AT BOLD REC QUAD BCO AZU 679 12X1
Código: Fábrica: Unidade:
42965 GOLLER DZ/12
F1 F4

UN: R\$ 2,99 AV: R\$ 35,88 15: R\$ 35,88
30: R\$ 35,88 45: R\$ 35,88 60: R\$ 35,88



PINCEL AT BOLD REC QUAD BCO PT 6080 12X1
Código: Fábrica: Unidade:
42964 GOLLER DZ/12
F1 F4

UN: R\$ 2,90 AV: R\$ 34,82 15: R\$ 35,55
30: R\$ 36,26 45: R\$ 36,98 60: R\$ 37,72



PINCEL AT COMPACTOR AZUL 12X1
Código: Fábrica: Unidade:
2570 COMPACTOR DZ/12
F1 F4

UN: R\$ 2,90 AV: R\$ 34,82 15: R\$ 35,55
30: R\$ 36,26 45: R\$ 36,98 60: R\$ 37,72



PINCEL AT COMPACTOR PRETO 12X1
Código: Fábrica: Unidade:
3275 COMPACTOR DZ/12
F1 F4

UN: R\$ 2,90 AV: R\$ 34,82 15: R\$ 35,55
30: R\$ 36,26 45: R\$ 36,98 60: R\$ 37,72



PINCEL AT COMPACTOR SORTIDO 12X1
Código: Fábrica: Unidade:
3819 COMPACTOR DZ/12
F1 F4

UN: R\$ 2,56 AV: R\$ 61,53 15: R\$ 62,81
30: R\$ 64,07 45: R\$ 65,35 60: R\$ 66,65



PINCEL AT COMPACTOR SORTIDO 24X1
Código: Fábrica: Unidade:
48157 COMPACTOR CR/24
F1 F4

UN: R\$ 2,90 AV: R\$ 34,82 15: R\$ 35,55
30: R\$ 36,26 45: R\$ 36,98 60: R\$ 37,72



PINCEL AT COMPACTOR VERMELHO 12X1
Código: Fábrica: Unidade:
3276 COMPACTOR DZ/12
F1 F4

UN: R\$ 17,41 AV: R\$ 17,41 15: R\$ 17,77
30: R\$ 18,12 45: R\$ 18,49 60: R\$ 18,86



PINCEL AT COMPACTOR 6 CORES SORT
Código: Fábrica: Unidade:
40911 COMPACTOR UN/1
F1 F4

UN: R\$ 1,97 AV: R\$ 19,73 15: R\$ 20,14
30: R\$ 20,54 45: R\$ 20,95 60: R\$ 21,37



PINCEL AT MARC PERM AZUL 2116 10X1
Código: Fábrica: Unidade:
49774 FIRST CX/10
F1 F4

UN: R\$ 4,35 AV: R\$ 52,22 15: R\$ 53,30
30: R\$ 54,37 45: R\$ 55,46 60: R\$ 56,57



PINCEL AT MARC PERM DESTAQ AMAREL 12X1
Código: Fábrica: Unidade:
48161 COMPACTOR CX/12
F1 F4

UN: R\$ 4,35 AV: R\$ 52,22 15: R\$ 53,30
30: R\$ 54,37 45: R\$ 55,46 60: R\$ 56,57



PINCEL AT MARC PERM DESTAQ AZUL 12X1
Código: Fábrica: Unidade:
48158 COMPACTOR CX/12
F1 F4

UN: R\$ 4,35 AV: R\$ 52,22 15: R\$ 53,30
30: R\$ 54,37 45: R\$ 55,46 60: R\$ 56,57



PINCEL AT MARC PERM DESTAQ LARANJ 12X1
Código: Fábrica: Unidade:
48165 COMPACTOR CX/12
F1 F4

UN: R\$ 4,35 AV: R\$ 52,22 15: R\$ 53,30
30: R\$ 54,37 45: R\$ 55,46 60: R\$ 56,57



PINCEL AT MARC PERM DESTAQ MAGE 12X1
Código: Fábrica: Unidade:
48164 COMPACTOR CX/12
F1 F4

UN: R\$ 4,35 AV: R\$ 52,22 15: R\$ 53,30
30: R\$ 54,37 45: R\$ 55,46 60: R\$ 56,57



PINCEL AT MARC PERM DESTAQ MARROM 12X1
Código: Fábrica: Unidade:
48163 COMPACTOR CX/12
F1 F4

UN: R\$ 4,35 AV: R\$ 52,22 15: R\$ 53,30
30: R\$ 54,37 45: R\$ 55,46 60: R\$ 56,57



PINCEL AT MARC PERM DESTAQ ROSA 12X1
Código: Fábrica: Unidade:
48166 COMPACTOR CX/12
F1 F4

UN: R\$ 4,35 AV: R\$ 52,22 15: R\$ 53,30
30: R\$ 54,37 45: R\$ 55,46 60: R\$ 56,57



PINCEL AT MARC PERM DESTAQ VERDE 12X1
Código: Fábrica: Unidade:
48162 COMPACTOR CX/12
F1 F4

UN: R\$ 4,35 AV: R\$ 52,22 15: R\$ 53,30
30: R\$ 54,37 45: R\$ 55,46 60: R\$ 56,57



PINCEL AT MARC PERM DESTAQ VERMEL 12X1
Código: 48160 Fábrica: COMPACTOR Unidade: CX/12 F1 F4

UN: R\$ 1,97 AV: R\$ 19,73 15: R\$ 20,14
30: R\$ 20,54 45: R\$ 20,95 60: R\$ 21,37



PINCEL AT MARC PERM PRETO 2115 10X1
Código: 49776 Fábrica: FIRST Unidade: CX/10 F1 F4

UN: R\$ 5,61 AV: R\$ 67,33 15: R\$ 68,74
30: R\$ 70,11 45: R\$ 71,51 60: R\$ 72,94



PINCEL AT MARC PERM REC AZUL 12X1
Código: 35996 Fábrica: COMPACTOR Unidade: CX/12 F1 F4

UN: R\$ 3,17 AV: R\$ 38,05 15: R\$ 38,84
30: R\$ 39,62 45: R\$ 40,41 60: R\$ 41,22



PINCEL AT MARC PERM REC AZUL 616 12X1
Código: 39788 Fábrica: MASTERPRINT Unidade: DZ/12 F1 F4

UN: R\$ 4,11 AV: R\$ 49,35 15: R\$ 50,38
30: R\$ 51,38 45: R\$ 52,41 60: R\$ 53,46



PINCEL AT MARC PERM REC AZUL 7011 12X1
Código: 40915 Fábrica: BRW Unidade: DZ/12 F1 F4

UN: R\$ 6,00 AV: R\$ 71,98 15: R\$ 73,48
30: R\$ 74,95 45: R\$ 76,45 60: R\$ 77,97



PINCEL AT MARC PERM REC PRETO 12X1
Código: 35997 Fábrica: COMPACTOR Unidade: CX/12 F1 F4

UN: R\$ 5,61 AV: R\$ 67,33 15: R\$ 68,74
30: R\$ 70,11 45: R\$ 71,51 60: R\$ 72,94



PINCEL AT MARC PERM REC VERDE 12X1
Código: 48153 Fábrica: COMPACTOR Unidade: DZ/12 F1 F4

UN: R\$ 3,17 AV: R\$ 38,05 15: R\$ 38,84
30: R\$ 39,62 45: R\$ 40,41 60: R\$ 41,22



PINCEL AT MARC PERM REC VERDE 616 12X1
Código: 42892 Fábrica: MASTERPRINT Unidade: DZ/12 F1 F4

UN: R\$ 2,81 AV: R\$ 33,66 15: R\$ 34,36
30: R\$ 35,05 45: R\$ 35,75 60: R\$ 36,47



PINCEL AT MARC PERM REC VERMEL 616 12X1
Código: 39790 Fábrica: MASTERPRINT Unidade: DZ/12 F1 F4

UN: R\$ 2,01 AV: R\$ 24,09 15: R\$ 24,59
30: R\$ 25,08 45: R\$ 25,58 60: R\$ 26,09



PINCEL AT MARC PERM SLIM AZUL 615 12X1
Código: 51059 Fábrica: MASTERPRINT Unidade: DZ/12 F1 F4

UN: R\$ 2,01 AV: R\$ 24,09 15: R\$ 24,59
30: R\$ 25,08 45: R\$ 25,58 60: R\$ 26,09



PINCEL AT MARC PERM SLIM PRETO 615 12X1
Código: 51058 Fábrica: MASTERPRINT Unidade: DZ/12 F1 F4

UN: R\$ 1,97 AV: R\$ 19,73 15: R\$ 20,14
30: R\$ 20,54 45: R\$ 20,95 60: R\$ 21,37



PINCEL AT MARC PERM VERMELHO 2117 10X1
Código: 49775 Fábrica: FIRST Unidade: CX/10 F1 F4

UN: R\$ 3,60 AV: R\$ 43,14 15: R\$ 44,04
30: R\$ 44,92 45: R\$ 45,82 60: R\$ 46,74



PINCEL AT MARC PERM VERMELHO 616 12X1
Código: 39787 Fábrica: MASTERPRINT Unidade: DZ/12 F1 F4

UN: R\$ 4,93 AV: R\$ 59,22 15: R\$ 60,45
30: R\$ 61,66 45: R\$ 62,89 60: R\$ 64,15



PINCEL AT MARC QUAD BCO AZU REC 601 12X1
Código: 37651 Fábrica: BRW Unidade: DZ/12 F1 F4

UN: R\$ 17,88 AV: R\$ 17,88 15: R\$ 17,88
30: R\$ 17,88 45: R\$ 17,88 60: R\$ 17,88



PINCEL AT MARC QUAD BCO AZUL BM2112 12X1
Código: 48844 Fábrica: FIRST Unidade: UN/1 F1 F4

UN: R\$ 8,71 AV: R\$ 87,07 15: R\$ 88,89
30: R\$ 90,66 45: R\$ 92,48 60: R\$ 94,33



PINCEL AT MARC QUAD BCO AZUL REC RF 10X1
Código: 48181 Fábrica: JOCAROFFICE Unidade: CX/10 F1 F4

UN: R\$ 5,80 AV: R\$ 69,66 15: R\$ 71,11
30: R\$ 72,53 45: R\$ 73,98 60: R\$ 75,46



PINCEL AT MARC QUAD BCO AZUL REC 12X1
Código: 51015 Fábrica: JOCAROFFICE Unidade: F1 F4

UN: R\$ 7,74 AV: R\$ 92,88 15: R\$ 94,81
30: R\$ 96,71 45: R\$ 98,64 60: R\$ 100,62



PINCEL AT MARC QUAD BCO AZUL REC 12X1
Código: 40913 Fábrica: COMPACTOR Unidade: DZ/12 F1 F4

UN: R\$ 3,68 AV: R\$ 44,11 15: R\$ 45,03
30: R\$ 45,93 45: R\$ 46,85 60: R\$ 47,79



PINCEL AT MARC QUAD BCO AZUL 3001 12X1
Código: 9909 Fábrica: BRW Unidade: DZ/12 F1 F4

UN: R\$ 3,68 AV: R\$ 44,11 15: R\$ 45,03
30: R\$ 45,93 45: R\$ 46,85 60: R\$ 47,79



PINCEL AT MARC QUAD BCO AZUL 5981 12X1
Código: 40679 Fábrica: GOLLER Unidade: DZ/12 F1 F4

UN: R\$ 3,33 AV: R\$ 39,99 15: R\$ 39,99
30: R\$ 39,99 45: R\$ 39,99 60: R\$ 39,99



PINCEL AT MARC QUAD BCO AZUL 80003 12X1
Código: 48211 Fábrica: EXPO TANK Unidade: CX/12 F1 F4

UN: R\$ 3,28 AV: R\$ 39,35 15: R\$ 40,17
30: R\$ 40,97 45: R\$ 41,79 60: R\$ 42,63



PINCEL AT MARC QUAD BCO AZUL 96020 12X1
Código: 48179 Fábrica: JOCAROFFICE Unidade: DZ/12 F1 F4

UN: R\$ 3,74 AV: R\$ 14,95 15: R\$ 15,26
30: R\$ 15,56 45: R\$ 15,87 60: R\$ 16,19



PINCEL AT MARC QUAD BCO COLORS 4X1
Código: 47391 Fábrica: JOCAROFFICE Unidade: CJ/4 F1 F4

UN: R\$ 8,71 AV: R\$ 87,07 15: R\$ 88,89
30: R\$ 90,66 45: R\$ 92,48 60: R\$ 94,33



PINCEL AT MARC QUAD BCO PRET REC RF 10X1
Código: 48182 Fábrica: JOCAROFFICE Unidade: CX/10 F1 F4

UN: R\$ 3,68 AV: R\$ 44,11 15: R\$ 45,03
30: R\$ 45,93 45: R\$ 46,85 60: R\$ 47,79



PINCEL AT MARC QUAD BCO PRETO 12X1
Código: 9910 Fábrica: BRW Unidade: DZ/12 F1 F4

UN: R\$ 17,88 AV: R\$ 17,88 15: R\$ 17,88
30: R\$ 17,88 45: R\$ 17,88 60: R\$ 17,88



PINCEL AT MARC QUAD BCO PRETO 2113 12X1
Código: 48845 Fábrica: FIRST Unidade: UN/1 F1 F4

UN: R\$ 3,33 AV: R\$ 39,99 15: R\$ 39,99
30: R\$ 39,99 45: R\$ 39,99 60: R\$ 39,99



PINCEL AT MARC QUAD BCO PRETO 80001 12X1
Código: 48212 Fábrica: EXPO TANK Unidade: CX/12 F1 F4

UN: R\$ 3,28 AV: R\$ 39,35 15: R\$ 40,17
30: R\$ 40,97 45: R\$ 41,79 60: R\$ 42,63



PINCEL AT MARC QUAD BCO PRETO 96019 12X1
Código: 48180 Fábrica: JOCAROFFICE Unidade: DZ/12 F1 F4

UN: R\$ 6,48 AV: R\$ 77,78 15: R\$ 79,41
30: R\$ 80,99 45: R\$ 82,61 60: R\$ 84,27



PINCEL AT MARC QUAD BCO ROSA 12X1
Código: 48565 Fábrica: NEWPEN Unidade: DZ/12 F1 F4

UN: R\$ 3,68 AV: R\$ 44,11 15: R\$ 45,03
30: R\$ 45,93 45: R\$ 46,85 60: R\$ 47,79



PINCEL AT MARC QUAD BCO VERDE 12X1
Código: 43800 Fábrica: BRW Unidade: DZ/12 F1 F4

UN: R\$ 17,88 AV: R\$ 17,88 15: R\$ 17,88
30: R\$ 17,88 45: R\$ 17,88 60: R\$ 17,88



PINCEL AT MARC QUAD BCO VERM BM2114 12X1
Código: 48846 Fábrica: FIRST Unidade: UN/1 F1 F4

UN: R\$ 8,71 AV: R\$ 87,07 15: R\$ 88,89
30: R\$ 90,66 45: R\$ 92,48 60: R\$ 94,33



PINCEL AT MARC QUAD BCO VERM REC10X1
Código: 48183 Fábrica: JOCAROFFICE Unidade: CX/10 F1 F4

UN: R\$ 3,33 AV: R\$ 39,99 15: R\$ 39,99
30: R\$ 39,99 45: R\$ 39,99 60: R\$ 39,99



PINCEL AT MARC QUAD BCO VERM 80002 12X1
Código: Fábrika: Unidade:
48213 EXPO TANK CX/12 F1 F4

UN: R\$ 6,48 AV: R\$ 77,78 15: R\$ 79,41
30: R\$ 80,99 45: R\$ 82,61 60: R\$ 84,27



PINCEL AT MARC QUAD BCO VERMELHO 12X1
Código: Fábrika: Unidade:
48566 NEWPEN DZ/12 F1 F4

UN: R\$ 6,66 AV: R\$ 79,97 15: R\$ 79,97
30: R\$ 79,97 45: R\$ 79,97 60: R\$ 79,97



PINCEL AT QUAD BCO CARTUCH REC AZUL 12X1
Código: Fábrika: Unidade:
45216 BRW DZ/12 F1 F4

UN: R\$ 6,66 AV: R\$ 79,97 15: R\$ 79,97
30: R\$ 79,97 45: R\$ 79,97 60: R\$ 79,97



PINCEL AT QUAD BCO CARTUCH REC VERM 12X1
Código: Fábrika: Unidade:
45218 BRW DZ/12 F1 F4

UN: R\$ 6,66 AV: R\$ 79,97 15: R\$ 79,97
30: R\$ 79,97 45: R\$ 79,97 60: R\$ 79,97



PINCEL AT QUAD BCO CARTUCHO REC PTO 12X1
Código: Fábrika: Unidade:
45217 BRW DZ/12 F1 F4

UN: R\$ 3,29 AV: R\$ 39,47 15: R\$ 40,29
30: R\$ 41,09 45: R\$ 41,92 60: R\$ 42,75



PINCEL AT QUAD BCO REC AZUL 619 12X1
Código: Fábrika: Unidade:
43231 MASTERPRINT DZ/12 F1 F4

UN: R\$ 3,29 AV: R\$ 39,47 15: R\$ 40,29
30: R\$ 41,09 45: R\$ 41,92 60: R\$ 42,75



PINCEL AT QUAD BCO REC PRETO 619 12X1
Código: Fábrika: Unidade:
43233 MASTERPRINT DZ/12 F1 F4

UN: R\$ 3,29 AV: R\$ 39,47 15: R\$ 40,29
30: R\$ 41,09 45: R\$ 41,92 60: R\$ 42,75



PINCEL AT QUAD BCO REC VERDE 619 12X1
Código: Fábrika: Unidade:
42890 MASTERPRINT DZ/12 F1 F4

UN: R\$ 3,29 AV: R\$ 39,47 15: R\$ 40,29
30: R\$ 41,09 45: R\$ 41,92 60: R\$ 42,75



PINCEL AT QUAD BCO REC VERMELHO 619 12X1
Código: Fábrika: Unidade:
43232 MASTERPRINT DZ/12 F1 F4

UN: R\$ 2,05 AV: R\$ 24,65 15: R\$ 25,17
30: R\$ 25,67 45: R\$ 26,18 60: R\$ 26,71



PINCEL ESC CHAT AMAR 0 7164 12X1
Código: Fábrika: Unidade:
33840 GOLLER CR/12 F1 F4

UN: R\$ 2,14 AV: R\$ 25,67 15: R\$ 26,20
30: R\$ 26,73 45: R\$ 27,26 60: R\$ 27,81



PINCEL ESC CHAT AMAR 0 98733 12X1
Código: Fábrika: Unidade:
42895 CONDOR PT/12 F1 F4

UN: R\$ 6,42 AV: R\$ 77,03 15: R\$ 78,63
30: R\$ 80,21 45: R\$ 81,81 60: R\$ 83,45



PINCEL ESC CHAT AMAR 20 98743 12X1
Código: Fábrika: Unidade:
42898 CONDOR PT/12 F1 F4

UN: R\$ 9,76 AV: R\$ 58,54 15: R\$ 59,76
30: R\$ 60,95 45: R\$ 62,17 60: R\$ 63,42



PINCEL ESC CHAT AMAR 22 4169 6X1
Código: Fábrika: Unidade:
33846 LEO&LEO/GOLL CR/6 F1 F4

UN: R\$ 9,24 AV: R\$ 55,46 15: R\$ 56,61
30: R\$ 57,75 45: R\$ 58,90 60: R\$ 60,08



PINCEL ESC CHAT AMAR 24 98745 6X1
Código: Fábrika: Unidade:
42899 CONDOR PT/6 F1 F4

UN: R\$ 1,07 AV: R\$ 12,84 15: R\$ 13,11
30: R\$ 13,37 45: R\$ 13,64 60: R\$ 13,91



PINCEL ESC CHAT CURTO AMAR 0 4263 12X1
Código: Fábrika: Unidade:
48943 LEO&LEO CR/12 F1 F4

UN: R\$ 2,87 AV: R\$ 34,46 15: R\$ 35,18
30: R\$ 35,88 45: R\$ 36,60 60: R\$ 37,33



PINCEL ESC CHAT CURTO AMAR 2 88221 12X1
Código: Fábrika: Unidade:
45470 CONDOR PT/12 F1 F4

UN: R\$ 3,16 AV: R\$ 37,88 15: R\$ 38,67
30: R\$ 39,45 45: R\$ 40,23 60: R\$ 41,04



PINCEL ESC CHAT CURTO AMAR 4 88222 12X1
Código: Fábrica: Unidade:
45471 CONDOR PT/12
F1 F4

UN: R\$ 1,07 AV: R\$ 12,84 15: R\$ 13,11
30: R\$ 13,37 45: R\$ 13,64 60: R\$ 13,91



PINCEL ESC CHAT CURTO AMAR 02 4264 12X1
Código: Fábrica: Unidade:
48944 LEO&LEO CR/12
F1 F4

UN: R\$ 1,22 AV: R\$ 14,69 15: R\$ 15,00
30: R\$ 15,29 45: R\$ 15,60 60: R\$ 15,91



PINCEL ESC CHAT CURTO AMAR 04 4265 12X1
Código: Fábrica: Unidade:
43286 LEO&LEO CR/12
F1 F4

UN: R\$ 1,23 AV: R\$ 14,79 15: R\$ 15,10
30: R\$ 15,40 45: R\$ 15,71 60: R\$ 16,02



PINCEL ESC CHAT CURTO AMAR 06 4266 12X1
Código: Fábrica: Unidade:
43285 LEO&LEO CR/12
F1 F4

UN: R\$ 1,28 AV: R\$ 15,40 15: R\$ 15,72
30: R\$ 16,03 45: R\$ 16,35 60: R\$ 16,68



PINCEL ESC CHAT CURTO AMAR 10 4341 12X1
Código: Fábrica: Unidade:
43287 LEO&LEO CR/12
F1 F4

UN: R\$ 1,54 AV: R\$ 18,48 15: R\$ 18,86
30: R\$ 19,24 45: R\$ 19,63 60: R\$ 20,02



PINCEL ESC CHAT CURTO AMAR 14 4344 12X1
Código: Fábrica: Unidade:
48947 LEO&LEO CR/12
F1 F4

UN: R\$ 5,26 AV: R\$ 63,16 15: R\$ 64,48
30: R\$ 65,77 45: R\$ 67,08 60: R\$ 68,43



PINCEL ESC CHAT CURTO AMAR 14 88227 12X1
Código: Fábrica: Unidade:
45476 CONDOR PT/12
F1 F4

UN: R\$ 1,73 AV: R\$ 20,80 15: R\$ 21,23
30: R\$ 21,66 45: R\$ 22,09 60: R\$ 22,53



PINCEL ESC CHAT CURTO AMAR 16 4267 12X1
Código: Fábrica: Unidade:
49135 LEO&LEO CR/12
F1 F4

UN: R\$ 5,95 AV: R\$ 71,39 15: R\$ 72,88
30: R\$ 74,34 45: R\$ 75,82 60: R\$ 77,34



PINCEL ESC CHAT CURTO AMAR 16 90695 12X1
Código: Fábrica: Unidade:
45477 CONDOR PT/12
F1 F4

UN: R\$ 2,05 AV: R\$ 24,64 15: R\$ 25,16
30: R\$ 25,66 45: R\$ 26,17 60: R\$ 26,70



PINCEL ESC CHAT CURTO AMAR 18 4268 12X1
Código: Fábrica: Unidade:
48948 LEO&LEO CR/12
F1 F4

UN: R\$ 6,79 AV: R\$ 81,46 15: R\$ 83,15
30: R\$ 84,82 45: R\$ 86,51 60: R\$ 88,24



PINCEL ESC CHAT CURTO AMAR 18 90696 12X1
Código: Fábrica: Unidade:
45478 CONDOR PT/12
F1 F4

UN: R\$ 2,40 AV: R\$ 28,75 15: R\$ 29,35
30: R\$ 29,94 45: R\$ 30,54 60: R\$ 31,15



PINCEL ESC CHAT CURTO AMAR 20 4269 12X1
Código: Fábrica: Unidade:
48949 LEO&LEO CR/12
F1 F4

UN: R\$ 2,22 AV: R\$ 26,70 15: R\$ 27,25
30: R\$ 27,80 45: R\$ 28,35 60: R\$ 28,92



PINCEL ESC CHAT LONGO AMAR 2 98734 12X1
Código: Fábrica: Unidade:
42894 CONDOR PT/12
F1 F4

UN: R\$ 1,90 AV: R\$ 22,86 15: R\$ 23,33
30: R\$ 23,80 45: R\$ 24,27 60: R\$ 24,76



PINCEL ESC CHAT LONGO AMAR 02 4211 12X1
Código: Fábrica: Unidade:
41709 LEO&LEO CR/12
F1 F4

UN: R\$ 3,18 AV: R\$ 3,18 15: R\$ 3,25
30: R\$ 3,32 45: R\$ 3,38 60: R\$ 3,45



PINCEL ESC CHAT LONGO AMAR 036 12
Código: Fábrica: Unidade:
37899 LYKE UN/1
F1 F4

UN: R\$ 1,94 AV: R\$ 23,32 15: R\$ 23,80
30: R\$ 24,28 45: R\$ 24,76 60: R\$ 25,26



PINCEL ESC CHAT LONGO AMAR 04 4212 12X1
Código: Fábrica: Unidade:
31820 LEO&LEO CR/12
F1 F4

UN: R\$ 2,11 AV: R\$ 25,37 15: R\$ 25,90
30: R\$ 26,42 45: R\$ 26,95 60: R\$ 27,49



PINCEL ESC CHAT LONGO AMAR 06 4213 12X1
Código: Fábrica: Unidade:
31821 LEO&LEO CR/12
F1 F4

UN: R\$ 2,37 AV: R\$ 28,45 15: R\$ 29,05
30: R\$ 29,63 45: R\$ 30,22 60: R\$ 30,82



PINCEL ESC CHAT LONGO AMAR 08 4214 12X1
Código: Fábrica: Unidade:
42586 LEO&LEO CR/12
F1 F4

UN: R\$ 3,18 AV: R\$ 3,18 15: R\$ 3,25
30: R\$ 3,32 45: R\$ 3,38 60: R\$ 3,45



PINCEL ESC CHAT LONGO AMAR 10
Código: Fábrica: Unidade:
37898 LYKE UN/1
F1 F4

UN: R\$ 2,37 AV: R\$ 28,45 15: R\$ 29,05
30: R\$ 29,63 45: R\$ 30,22 60: R\$ 30,82



PINCEL ESC CHAT LONGO AMAR 10 4215 12X1
Código: Fábrica: Unidade:
42588 LEO&LEO CR/12
F1 F4

UN: R\$ 3,19 AV: R\$ 38,26 15: R\$ 39,06
30: R\$ 39,84 45: R\$ 40,64 60: R\$ 41,45



PINCEL ESC CHAT LONGO AMAR 10 98738 12X1
Código: Fábrica: Unidade:
43364 CONDOR PT/12
F1 F4

UN: R\$ 3,07 AV: R\$ 36,86 15: R\$ 37,62
30: R\$ 38,38 45: R\$ 39,14 60: R\$ 39,93



PINCEL ESC CHAT LONGO AMAR 12 4216 12X1
Código: Fábrica: Unidade:
41710 LEO&LEO CR/12
F1 F4

UN: R\$ 3,56 AV: R\$ 42,73 15: R\$ 43,62
30: R\$ 44,49 45: R\$ 45,38 60: R\$ 46,29



PINCEL ESC CHAT LONGO AMAR 12 98739 12X1
Código: Fábrica: Unidade:
43260 CONDOR PT/12
F1 F4

UN: R\$ 2,48 AV: R\$ 29,78 15: R\$ 30,40
30: R\$ 31,01 45: R\$ 31,63 60: R\$ 32,26



PINCEL ESC CHAT LONGO AMAR 14 4217 12X1
Código: Fábrica: Unidade:
31824 LEO&LEO CR/12
F1 F4

UN: R\$ 4,24 AV: R\$ 50,92 15: R\$ 51,98
30: R\$ 53,02 45: R\$ 54,08 60: R\$ 55,16



PINCEL ESC CHAT LONGO AMAR 14 98740 12X1
Código: Fábrica: Unidade:
43361 CONDOR PT/12
F1 F4

UN: R\$ 3,42 AV: R\$ 20,53 15: R\$ 20,96
30: R\$ 21,38 45: R\$ 21,81 60: R\$ 22,24



PINCEL ESC CHAT LONGO AMAR 16 4171 6X1
Código: Fábrica: Unidade:
42142 LEO&LEO CR/6
F1 F4

UN: R\$ 4,79 AV: R\$ 57,51 15: R\$ 58,71
30: R\$ 59,89 45: R\$ 61,08 60: R\$ 62,30



PINCEL ESC CHAT LONGO AMAR 16 98741 12X1
Código: Fábrica: Unidade:
43362 CONDOR PT/12
F1 F4

UN: R\$ 4,52 AV: R\$ 27,12 15: R\$ 27,68
30: R\$ 28,24 45: R\$ 28,80 60: R\$ 29,38



PINCEL ESC CHAT LONGO AMAR 18 4172 6X1
Código: Fábrica: Unidade:
41707 LEO&LEO CR/6
F1 F4

UN: R\$ 5,22 AV: R\$ 31,33 15: R\$ 31,98
30: R\$ 32,62 45: R\$ 33,27 60: R\$ 33,94



PINCEL ESC CHAT LONGO AMAR 20 4173 6X1
Código: Fábrica: Unidade:
41708 LEO&LEO CR/6
F1 F4

UN: R\$ 7,85 AV: R\$ 47,13 15: R\$ 48,11
30: R\$ 49,07 45: R\$ 50,05 60: R\$ 51,05



PINCEL ESC CHAT LONGO AMAR 24 4170 6X1
Código: Fábrica: Unidade:
33845 LEO&LEO CR/6
F1 F4

UN: R\$ 8,13 AV: R\$ 97,57 15: R\$ 99,61
30: R\$ 101,60 45: R\$ 103,63 60: R\$ 105,70

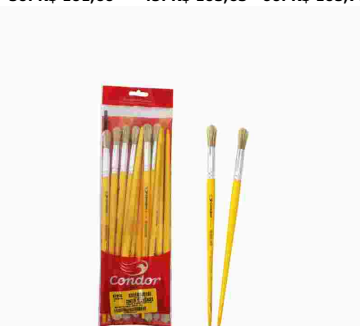

PINCEL ESC RED AMARELO 16 87896 12X1
Código: Fábrica: Unidade:
42896 CONDOR PT/12
F1 F4

UN: R\$ 10,74 AV: R\$ 128,91 15: R\$ 131,60
30: R\$ 134,23 45: R\$ 136,92 60: R\$ 139,65

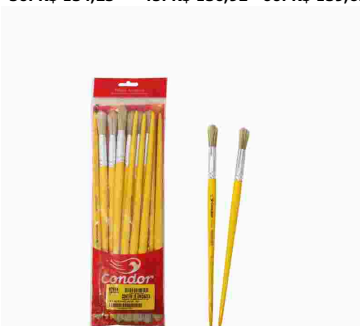

PINCEL ESC RED AMARELO 20 87898 12X1
Código: Fábrica: Unidade:
42897 CONDOR PT/12
F1 F4

UN: R\$ 1,20 AV: R\$ 14,37 15: R\$ 14,67
30: R\$ 14,96 45: R\$ 15,26 60: R\$ 15,57



PINCEL ESC RED CURTO AMAR 0 4961 12X1
Código: Fábrica: Unidade:
42713 LEO&LEO CR/12
F1 F4

UN: R\$ 2,73 AV: R\$ 32,77 15: R\$ 33,45
30: R\$ 34,12 45: R\$ 34,80 60: R\$ 35,50



PINCEL ESC RED CURTO AMAR 0 88220 12X1
Código: Fábrica: Unidade:
45469 CONDOR PT/12
F1 F4

UN: R\$ 1,20 AV: R\$ 14,37 15: R\$ 14,67
30: R\$ 14,96 45: R\$ 15,26 60: R\$ 15,57



PINCEL ESC RED CURTO AMAR 00 4960 12X1
Código: Fábrica: Unidade:
20763 LEO&LEO CR/12
F1 F4

UN: R\$ 1,53 AV: R\$ 18,37 15: R\$ 18,75
30: R\$ 19,12 45: R\$ 19,51 60: R\$ 19,90



PINCEL ESC RED CURTO AMAR 02 4962 12X1
Código: Fábrica: Unidade:
23158 LEO&LEO CR/12
F1 F4

UN: R\$ 1,37 AV: R\$ 16,42 15: R\$ 16,77
30: R\$ 17,10 45: R\$ 17,44 60: R\$ 17,79



PINCEL ESC RED CURTO AMAR 04 4963 12X1
Código: Fábrica: Unidade:
42717 LEO&LEO CR/12
F1 F4

UN: R\$ 1,54 AV: R\$ 18,48 15: R\$ 18,86
30: R\$ 19,24 45: R\$ 19,63 60: R\$ 20,02



PINCEL ESC RED CURTO AMAR 06 4964 12X1
Código: Fábrica: Unidade:
41712 LEO&LEO CR/12
F1 F4

UN: R\$ 1,53 AV: R\$ 18,37 15: R\$ 18,75
30: R\$ 19,12 45: R\$ 19,51 60: R\$ 19,90



PINCEL ESC RED CURTO AMAR 08 4966 12X1
Código: Fábrica: Unidade:
24766 LEO&LEO CR/12
F1 F4

UN: R\$ 1,63 AV: R\$ 19,51 15: R\$ 19,91
30: R\$ 20,31 45: R\$ 20,72 60: R\$ 21,13



PINCEL ESC RED CURTO AMAR 10 4967 12X1
Código: Fábrica: Unidade:
48353 LEO&LEO CR/12
F1 F4

UN: R\$ 1,63 AV: R\$ 19,51 15: R\$ 19,91
30: R\$ 20,31 45: R\$ 20,72 60: R\$ 21,13



PINCEL ESC RED CURTO AMAR 12 4968 12X1
Código: Fábrica: Unidade:
48352 LEO&LEO CR/12
F1 F4

UN: R\$ 1,93 AV: R\$ 23,11 15: R\$ 23,59
30: R\$ 24,07 45: R\$ 24,55 60: R\$ 25,04



PINCEL ESC RED CURTO AMAR 16 4270 12X1
Código: Fábrica: Unidade:
48350 LEO&LEO CR/12
F1 F4

UN: R\$ 2,40 AV: R\$ 28,75 15: R\$ 29,35
30: R\$ 29,94 45: R\$ 30,54 60: R\$ 31,15



PINCEL ESC RED CURTO AMAR 18 4271 12X1
Código: Fábrica: Unidade:
46367 LEO&LEO CR/12
F1 F4

UN: R\$ 2,48 AV: R\$ 29,78 15: R\$ 30,40
30: R\$ 31,01 45: R\$ 31,63 60: R\$ 32,26



PINCEL ESC RED CURTO AMAR 20 4272 12X1
Código: Fábrica: Unidade:
42144 LEO&LEO CR/12
F1 F4

UN: R\$ 2,48 AV: R\$ 29,71 15: R\$ 30,33
30: R\$ 30,93 45: R\$ 31,55 60: R\$ 32,18



PINCEL ESC RED CURTO VERM 0 85275 12X1
Código: Fábrica: Unidade:
45452 CONDOR PT/12
F1 F4

UN: R\$ 2,55 AV: R\$ 30,58 15: R\$ 31,22
30: R\$ 31,84 45: R\$ 32,48 60: R\$ 33,13



PINCEL ESC RED CURTO VERM 2 85276 12X1
Código: Fábrica: Unidade:
45453 CONDOR PT/12
F1 F4

UN: R\$ 2,63 AV: R\$ 31,62 15: R\$ 32,28
30: R\$ 32,92 45: R\$ 33,58 60: R\$ 34,25



PINCEL ESC RED CURTO VERM 4 85277 12X1
Código: Fábrica: Unidade:
45454 CONDOR PT/12
F1 F4

UN: R\$ 2,71 AV: R\$ 32,51 15: R\$ 33,19
30: R\$ 33,85 45: R\$ 34,53 60: R\$ 35,22



PINCEL ESC RED CURTO VERM 6 85278 12X1
Código: Fábrica: Unidade:
45455 CONDOR PT/12
F1 F4

UN: R\$ 3,03 AV: R\$ 36,30 15: R\$ 37,06
30: R\$ 37,80 45: R\$ 38,55 60: R\$ 39,33



PINCEL ESC RED CURTO VERM 8 85279 12X1
Código: 45456 Fábrica: CONDOR Unidade: PT/12 F1 F4

UN: R\$ 2,44 AV: R\$ 29,24 15: R\$ 29,85
30: R\$ 30,45 45: R\$ 31,06 60: R\$ 31,68



PINCEL ESC RED CURTO VERM 10 85280 12X1
Código: 45457 Fábrica: CONDOR Unidade: PT/12 F1 F4

UN: R\$ 3,63 AV: R\$ 43,60 15: R\$ 44,51
30: R\$ 45,40 45: R\$ 46,31 60: R\$ 47,24



PINCEL ESC RED CURTO VERM 12 85281 12X1
Código: 45458 Fábrica: CONDOR Unidade: PT/12 F1 F4

UN: R\$ 4,10 AV: R\$ 49,14 15: R\$ 50,17
30: R\$ 51,17 45: R\$ 52,19 60: R\$ 53,24



PINCEL ESC RED CURTO VERM 14 85282 12X1
Código: 45459 Fábrica: CONDOR Unidade: PT/12 F1 F4

UN: R\$ 4,80 AV: R\$ 57,63 15: R\$ 58,83
30: R\$ 60,00 45: R\$ 61,20 60: R\$ 62,43



PINCEL ESC RED CURTO VERM 16 85283 12X1
Código: 45460 Fábrica: CONDOR Unidade: PT/12 F1 F4

UN: R\$ 5,95 AV: R\$ 71,39 15: R\$ 72,88
30: R\$ 74,34 45: R\$ 75,82 60: R\$ 77,34



PINCEL ESC RED CURTO VERM 18 85284 12X1
Código: 45461 Fábrica: CONDOR Unidade: PT/12 F1 F4

UN: R\$ 6,26 AV: R\$ 75,14 15: R\$ 76,71
30: R\$ 78,24 45: R\$ 79,80 60: R\$ 81,40



PINCEL ESC RED CURTO VERM 20 85285 12X1
Código: 45462 Fábrica: CONDOR Unidade: PT/12 F1 F4

UN: R\$ 8,41 AV: R\$ 100,95 15: R\$ 103,06
30: R\$ 105,12 45: R\$ 107,22 60: R\$ 109,36



PINCEL ESC RED CURTO VERM 22 85286 12X1
Código: 45463 Fábrica: CONDOR Unidade: PT/12 F1 F4

UN: R\$ 8,81 AV: R\$ 105,71 15: R\$ 107,91
30: R\$ 110,07 45: R\$ 112,27 60: R\$ 114,52



PINCEL ESC RED CURTO VERM 24 85287 12X1
Código: 45464 Fábrica: CONDOR Unidade: PT/12 F1 F4

UN: R\$ 1,93 AV: R\$ 23,11 15: R\$ 23,59
30: R\$ 24,07 45: R\$ 24,55 60: R\$ 25,04



PINCEL ESC RED LONGO AMAR 14 4969 12X1
Código: 41711 Fábrica: LEO&LEO Unidade: CR/12 F1 F4

UN: R\$ 4,11 AV: R\$ 49,31 15: R\$ 50,33
30: R\$ 51,34 45: R\$ 52,37 60: R\$ 53,41



PINCEL ESC RED MARROM 22 7188 12X1
Código: 33838 Fábrica: GOLLER Unidade: CR/12 F1 F4

UN: R\$ 4,45 AV: R\$ 53,41 15: R\$ 54,53
30: R\$ 55,62 45: R\$ 56,73 60: R\$ 57,86



PINCEL ESC RED MARROM 24 7189 12X1
Código: 33839 Fábrica: GOLLER Unidade: CR/12 F1 F4

UN: R\$ 6,68 AV: R\$ 80,11 15: R\$ 81,77
30: R\$ 83,41 45: R\$ 85,08 60: R\$ 86,78



PINCEL MARC PERM AZUL 3210 12X1
Código: 48567 Fábrica: NEWPEN Unidade: DZ/12 F1 F4

UN: R\$ 6,68 AV: R\$ 80,11 15: R\$ 81,77
30: R\$ 83,41 45: R\$ 85,08 60: R\$ 86,78



PINCEL MARC PERM MARROM 3217 12X1
Código: 48571 Fábrica: NEWPEN Unidade: DZ/12 F1 F4

UN: R\$ 6,68 AV: R\$ 80,11 15: R\$ 81,77
30: R\$ 83,41 45: R\$ 85,08 60: R\$ 86,78



PINCEL MARC PERM PRETO 3211 12X1
Código: 48568 Fábrica: NEWPEN Unidade: DZ/12 F1 F4

UN: R\$ 3,01 AV: R\$ 36,17 15: R\$ 36,92
30: R\$ 37,66 45: R\$ 38,41 60: R\$ 39,18



PINCEL MARC PERM REC AZUL 96070 12X1
Código: 48184 Fábrica: JOCAROFFICE Unidade: DZ/12 F1 F4

UN: R\$ 3,01 AV: R\$ 36,17 15: R\$ 36,92
30: R\$ 37,66 45: R\$ 38,41 60: R\$ 39,18



PINCEL MARC PERM REC PRETO 96071 12X1
Código: Fábrica: Unidade:
48185 JOCAROFFICE DZ/12
F1 F4

UN: R\$ 3,01 AV: R\$ 36,17 15: R\$ 36,92
30: R\$ 37,66 45: R\$ 38,41 60: R\$ 39,18



PINCEL MARC PERM REC VERMELHO 96072 12X1
Código: Fábrica: Unidade:
48186 JOCAROFFICE DZ/12
F1 F4

UN: R\$ 2,86 AV: R\$ 34,29 15: R\$ 35,00
30: R\$ 35,70 45: R\$ 36,42 60: R\$ 37,14



PINCEL MARC PERM TOP VERMELHO 4687 12X1
Código: Fábrica: Unidade:
48195 JOCAROFFICE DZ/12
F1 F4

UN: R\$ 6,68 AV: R\$ 80,11 15: R\$ 81,77
30: R\$ 83,41 45: R\$ 85,08 60: R\$ 86,78



PINCEL MARC PERM VERDE 3213 12X1
Código: Fábrica: Unidade:
48570 NEWPEN DZ/12
F1 F4

UN: R\$ 6,68 AV: R\$ 80,11 15: R\$ 81,77
30: R\$ 83,41 45: R\$ 85,08 60: R\$ 86,78



PINCEL MARC PERM VERMELHO 3212 12X1
Código: Fábrica: Unidade:
48569 NEWPEN DZ/12
F1 F4

UN: R\$ 6,68 AV: R\$ 80,11 15: R\$ 81,77
30: R\$ 83,41 45: R\$ 85,08 60: R\$ 86,78



PINCEL MARC PERM VIOLETA 3218 12X1
Código: Fábrica: Unidade:
48572 NEWPEN DZ/12
F1 F4

UN: R\$ 2,00 AV: R\$ 2,00 15: R\$ 2,04
30: R\$ 2,09 45: R\$ 2,13 60: R\$ 2,17



PINCEL P/PINTURA N00 UN
Código: Fábrica: Unidade:
41943 GOLLER UN/1
F1 F4

UN: R\$ 5,29 AV: R\$ 5,29 15: R\$ 5,40
30: R\$ 5,51 45: R\$ 5,62 60: R\$ 5,73



PINCEL P/PINTURA 1 1/2" 38MM 721
Código: Fábrica: Unidade:
48686 PLANETA UN/1
F1 F4

UN: R\$ 2,78 AV: R\$ 2,78 15: R\$ 2,84
30: R\$ 2,90 45: R\$ 2,96 60: R\$ 3,02



PINCEL P/PINTURA 1/2" 13MM 718
Código: Fábrica: Unidade:
48683 PLANETA UN/1
F1 F4

UN: R\$ 8,89 AV: R\$ 8,89 15: R\$ 9,07
30: R\$ 9,25 45: R\$ 9,44 60: R\$ 9,63



PINCEL P/PINTURA 2 1/2" 63MM 723
Código: Fábrica: Unidade:
48687 PLANETA UN/1
F1 F4

UN: R\$ 3,44 AV: R\$ 3,44 15: R\$ 3,51
30: R\$ 3,58 45: R\$ 3,65 60: R\$ 3,73



PINCEL P/PINTURA 3/4" 19MM 719
Código: Fábrica: Unidade:
48684 PLANETA UN/1
F1 F4

UN: R\$ 123,25 AV: R\$ 123,25 15: R\$ 125,82
30: R\$ 128,34 45: R\$ 130,90 60: R\$ 133,52



PIROGRAFO 5 PONTAS
Código: Fábrica: Unidade:
47339 WESTERN UN/1
F1 F4

UN: R\$ 20,53 AV: R\$ 20,53 15: R\$ 20,96
30: R\$ 21,38 45: R\$ 21,81 60: R\$ 22,24



PISTOLA COLA QUENTE BIV 20W PEQ 1001
Código: Fábrica: Unidade:
23761 HAIBRASI/FUT UN/1
F1 F4

UN: R\$ 51,35 AV: R\$ 51,35 15: R\$ 52,42
30: R\$ 53,47 45: R\$ 54,54 60: R\$ 55,63



PISTOLA COLA QUENTE BIV 10W PQ BOTAO OFF
Código: Fábrica: Unidade:
42458 GATTE UN/1
F1 F4

UN: R\$ 46,21 AV: R\$ 46,21 15: R\$ 47,18
30: R\$ 48,12 45: R\$ 49,08 60: R\$ 50,06



PISTOLA COLA QUENTE BIV 100W G BOTAO OFF
Código: Fábrica: Unidade:
50223 FUTURO UN/1
F1 F4

UN: R\$ 28,00 AV: R\$ 28,00 15: R\$ 28,58
30: R\$ 29,16 45: R\$ 29,74 60: R\$ 30,33



PISTOLA COLA QUENTE BIV 20W P BOTAO OFF
Código: Fábrica: Unidade:
50224 FUTURO UN/1
F1 F4

UN: R\$ 50,73 AV: R\$ 50,73 15: R\$ 51,79
30: R\$ 52,83 45: R\$ 53,88 60: R\$ 54,96



PISTOLA COLA QUENTE BIV 40W GD BOTAO OFF
Código: Fábrica: Unidade:
46430 KAZ UN/1
F1 F4

UN: R\$ 26,70 AV: R\$ 26,70 15: R\$ 27,25
30: R\$ 27,80 45: R\$ 28,35 60: R\$ 28,92



PISTOLA COLA QUENTE BIV 40W GDE 103
Código: Fábrica: Unidade:
18998 WIN/FU/ET/AL UN/1
F1 F4

UN: R\$ 1,33 AV: R\$ 13,33 15: R\$ 13,61
30: R\$ 13,88 45: R\$ 14,16 60: R\$ 14,44

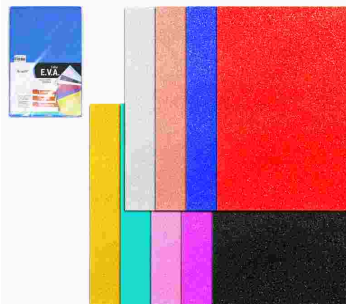

PLACA EVA A4 20X30CM GLITER CORES 10X1
Código: Fábrica: Unidade:
46444 ITERPONTE PT/10
F1 F4

UN: R\$ 2,36 AV: R\$ 23,62 15: R\$ 24,11
30: R\$ 24,59 45: R\$ 25,08 60: R\$ 25,58

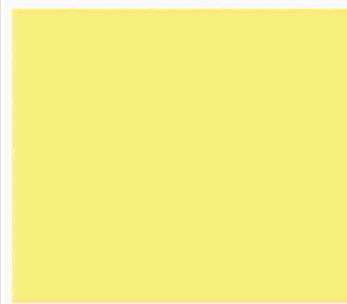

PLACA EVA 39X59CM ECON AMARELO 10X1
Código: Fábrica: Unidade:
48394 IBEL PT/10
F1 F4

UN: R\$ 2,36 AV: R\$ 23,62 15: R\$ 24,11
30: R\$ 24,59 45: R\$ 25,08 60: R\$ 25,58



PLACA EVA 39X59CM ECON AZUL BB 10X1
Código: Fábrica: Unidade:
44175 IBEL PT/10
F1 F4

UN: R\$ 2,36 AV: R\$ 23,62 15: R\$ 24,11
30: R\$ 24,59 45: R\$ 25,08 60: R\$ 25,58



PLACA EVA 39X59CM ECON CENOURA 10X1
Código: Fábrica: Unidade:
44171 IBEL PT/10
F1 F4

UN: R\$ 2,36 AV: R\$ 23,62 15: R\$ 24,11
30: R\$ 24,59 45: R\$ 25,08 60: R\$ 25,58



PLACA EVA 39X59CM ECON MARROM 10X1
Código: Fábrica: Unidade:
12579 IBEL PT/10
F1 F4

UN: R\$ 2,36 AV: R\$ 23,62 15: R\$ 24,11
30: R\$ 24,59 45: R\$ 25,08 60: R\$ 25,58



PLACA EVA 39X59CM ECON VERDE GRAMA 10X1
Código: Fábrica: Unidade:
44178 IBEL PT/10
F1 F4

UN: R\$ 1,54 AV: R\$ 15,40 15: R\$ 15,72
30: R\$ 16,03 45: R\$ 16,35 60: R\$ 16,68

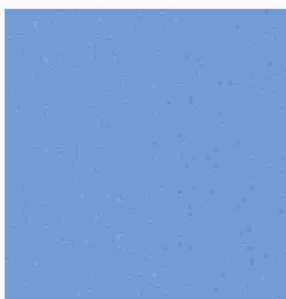

PLACA EVA 40X40CM AZUL BEBE 10X1
Código: Fábrica: Unidade:
39990 DUBFLEX PT/10
F1 F4

UN: R\$ 1,54 AV: R\$ 15,40 15: R\$ 15,72
30: R\$ 16,03 45: R\$ 16,35 60: R\$ 16,68

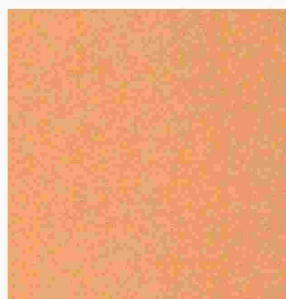

PLACA EVA 40X40CM BEGE 10X1
Código: Fábrica: Unidade:
39991 DUBFLEX PT/10
F1 F4

UN: R\$ 1,54 AV: R\$ 15,40 15: R\$ 15,72
30: R\$ 16,03 45: R\$ 16,35 60: R\$ 16,68

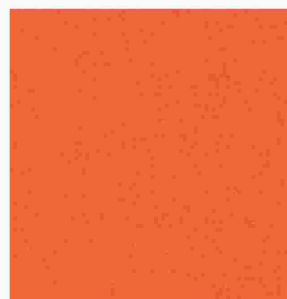

PLACA EVA 40X40CM LARANJA 10X1
Código: Fábrica: Unidade:
39992 DUBFLEX PT/10
F1 F4

UN: R\$ 1,54 AV: R\$ 15,40 15: R\$ 15,72
30: R\$ 16,03 45: R\$ 16,35 60: R\$ 16,68

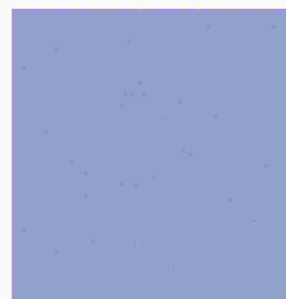

PLACA EVA 40X40CM LILAS 10X1
Código: Fábrica: Unidade:
39993 DUBFLEX PT/10
F1 F4

UN: R\$ 1,54 AV: R\$ 15,40 15: R\$ 15,72
30: R\$ 16,03 45: R\$ 16,35 60: R\$ 16,68

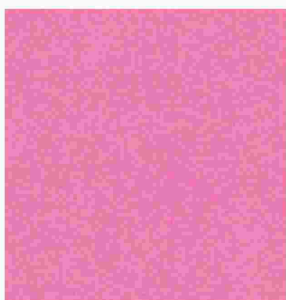

PLACA EVA 40X40CM ROSA PINK 10X1
Código: Fábrica: Unidade:
39996 DUBFLEX PT/10
F1 F4

UN: R\$ 1,54 AV: R\$ 15,40 15: R\$ 15,72
30: R\$ 16,03 45: R\$ 16,35 60: R\$ 16,68



PLACA EVA 40X40CM ROSA 10X1
Código: Fábrica: Unidade:
39995 DUBFLEX PT/10
F1 F4

UN: R\$ 1,54 AV: R\$ 15,40 15: R\$ 15,72
30: R\$ 16,03 45: R\$ 16,35 60: R\$ 16,68

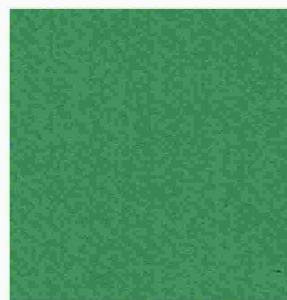

PLACA EVA 40X40CM VERDE BANDEIRA 10X1
Código: Fábrica: Unidade:
39997 DUBFLEX PT/10
F1 F4

UN: R\$ 1,54 AV: R\$ 15,40 15: R\$ 15,72
30: R\$ 16,03 45: R\$ 16,35 60: R\$ 16,68



PLACA EVA 40X40CM VERDE CLARO 10X1
Código: Fábrica: Unidade:
39998 DUBFLEX PT/10
F1 F4

UN: R\$ 2,05 AV: R\$ 20,48 15: R\$ 20,91
30: R\$ 21,33 45: R\$ 21,75 60: R\$ 22,19



PLACA EVA 40X45CM BORDO 10X1

Código: 44323 Fábrica: RABER Unidade: PT/10 F1 F4

UN: R\$ 2,05 AV: R\$ 20,48 15: R\$ 20,91
30: R\$ 21,33 45: R\$ 21,75 60: R\$ 22,19



PLACA EVA 40X47CM AMARELO ESC 011 10X1

Código: 7113 Fábrica: DUB FLEX Unidade: PT/10 F1 F4

UN: R\$ 2,05 AV: R\$ 20,48 15: R\$ 20,91
30: R\$ 21,33 45: R\$ 21,75 60: R\$ 22,19



PLACA EVA 40X47CM AZUL ROYAL 10X1

Código: 49141 Fábrica: EVAMAX Unidade: PT/10 F1 F4

UN: R\$ 2,05 AV: R\$ 20,48 15: R\$ 20,91
30: R\$ 21,33 45: R\$ 21,75 60: R\$ 22,19



PLACA EVA 40X47CM AZUL ROYAL 10X1

Código: 22359 Fábrica: DUB FLEX Unidade: PT/10 F1 F4

UN: R\$ 2,05 AV: R\$ 20,48 15: R\$ 20,91
30: R\$ 21,33 45: R\$ 21,75 60: R\$ 22,19

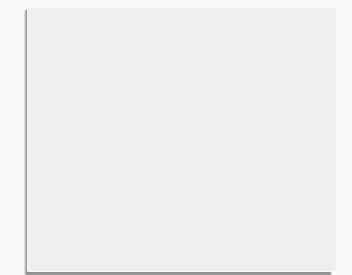

PLACA EVA 40X47CM BRANCO 10X1

Código: 4261 Fábrica: SANTA FE/IBEL Unidade: PT/10 F1 F4

UN: R\$ 2,05 AV: R\$ 20,48 15: R\$ 20,91
30: R\$ 21,33 45: R\$ 21,75 60: R\$ 22,19



PLACA EVA 40X47CM VERDE AGUA 10X1

Código: 18972 Fábrica: MW PLUS/BRW Unidade: PT/10 F1 F4

UN: R\$ 2,05 AV: R\$ 20,48 15: R\$ 20,91
30: R\$ 21,33 45: R\$ 21,75 60: R\$ 22,19



PLACA EVA 40X47CM VERDE CLARO 015 10X1

Código: 18966 Fábrica: IB/W Unidade: PT/10 F1 F4

UN: R\$ 2,05 AV: R\$ 20,48 15: R\$ 20,91
30: R\$ 21,33 45: R\$ 21,75 60: R\$ 22,19



PLACA EVA 40X47CM VERMELHO 10X1

Código: 50854 Fábrica: DUB FLEX Unidade: PT/10 F1 F4

UN: R\$ 2,05 AV: R\$ 20,48 15: R\$ 20,91
30: R\$ 21,33 45: R\$ 21,75 60: R\$ 22,19



PLACA EVA 40X48CM AMARELO 10X1

Código: 39777 Fábrica: SANTA FE Unidade: PT/10 F1 F4

UN: R\$ 7,19 AV: R\$ 35,94 15: R\$ 36,69
30: R\$ 37,42 45: R\$ 38,17 60: R\$ 38,94



PLACA EVA 40X48CM ATOALH AMARELO ESC 5X1

Código: 33717 Fábrica: DUBFLEX Unidade: PT/5 F1 F4

UN: R\$ 7,19 AV: R\$ 35,94 15: R\$ 36,69
30: R\$ 37,42 45: R\$ 38,17 60: R\$ 38,94



PLACA EVA 40X48CM ATOALH AZUL BB 5X1

Código: 33718 Fábrica: DUBFLEX Unidade: PT/5 F1 F4

UN: R\$ 2,05 AV: R\$ 20,48 15: R\$ 20,91
30: R\$ 21,33 45: R\$ 21,75 60: R\$ 22,19



PLACA EVA 40X48CM AZUL CLARO 10X1

Código: 18954 Fábrica: BRW Unidade: PT/10 F1 F4

UN: R\$ 2,05 AV: R\$ 20,48 15: R\$ 20,91
30: R\$ 21,33 45: R\$ 21,75 60: R\$ 22,19



PLACA EVA 40X48CM AZUL ROYAL 10X1

Código: 21650 Fábrica: BRW Unidade: PT/10 F1 F4

UN: R\$ 2,05 AV: R\$ 20,48 15: R\$ 20,91
30: R\$ 21,33 45: R\$ 21,75 60: R\$ 22,19



PLACA EVA 40X48CM BEGE 10X1

Código: 18970 Fábrica: BRW Unidade: PT/10 F1 F4

UN: R\$ 4,42 AV: R\$ 44,16 15: R\$ 45,08
30: R\$ 45,98 45: R\$ 46,90 60: R\$ 47,84



PLACA EVA 40X48CM GLITER AZUL CLARO 10X1

Código: 22354 Fábrica: YIN'S/IBEL Unidade: PT/10 F1 F4

UN: R\$ 4,42 AV: R\$ 44,16 15: R\$ 45,08
30: R\$ 45,98 45: R\$ 46,90 60: R\$ 47,84

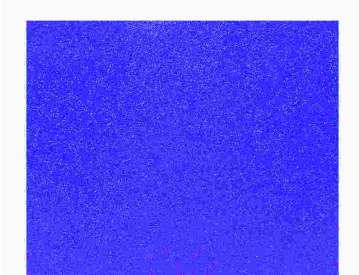

PLACA EVA 40X48CM GLITER AZUL ESC 10X1

Código: 45139 Fábrica: YIN'S PAPER Unidade: PT/10 F1 F4

UN: R\$ 4,42 AV: R\$ 44,16 15: R\$ 45,08
30: R\$ 45,98 45: R\$ 46,90 60: R\$ 47,84

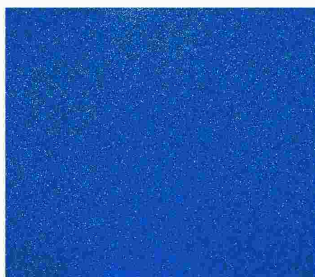

PLACA EVA 40X48CM GLITER AZUL PETRO 10X1
Código: Fábrica: Unidade:
45428 IBEL PT/10
F1 F4

UN: R\$ 4,42 AV: R\$ 44,16 15: R\$ 45,08
30: R\$ 45,98 45: R\$ 46,90 60: R\$ 47,84

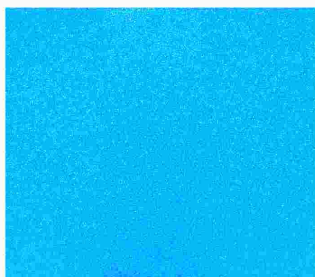

PLACA EVA 40X48CM GLITER AZUL 10X1
Código: Fábrica: Unidade:
48151 YIN'S PAPER PT/10
F1 F4

UN: R\$ 4,42 AV: R\$ 44,16 15: R\$ 45,08
30: R\$ 45,98 45: R\$ 46,90 60: R\$ 47,84

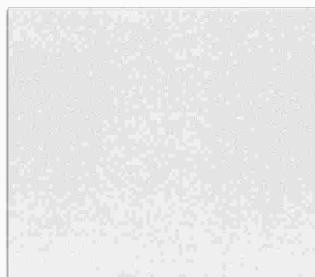

PLACA EVA 40X48CM GLITER BRANCO 10X1
Código: Fábrica: Unidade:
28908 YIN'S/IBEL PT/10
F1 F4

UN: R\$ 4,42 AV: R\$ 44,16 15: R\$ 45,08
30: R\$ 45,98 45: R\$ 46,90 60: R\$ 47,84



PLACA EVA 40X48CM GLITER BRONZE 10X1
Código: Fábrica: Unidade:
46958 YIN'S PAPER PT/10
F1 F4

UN: R\$ 4,42 AV: R\$ 44,16 15: R\$ 45,08
30: R\$ 45,98 45: R\$ 46,90 60: R\$ 47,84

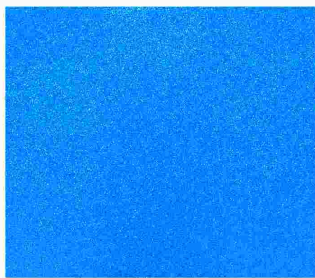

PLACA EVA 40X48CM GLITER ESP AZUL 10X1
Código: Fábrica: Unidade:
44163 YIN'S/IBEL PT/10
F1 F4

UN: R\$ 4,42 AV: R\$ 44,16 15: R\$ 45,08
30: R\$ 45,98 45: R\$ 46,90 60: R\$ 47,84



PLACA EVA 40X48CM GLITER ESP MARROM 10X1
Código: Fábrica: Unidade:
45430 IBEL PT/10
F1 F4

UN: R\$ 4,42 AV: R\$ 44,16 15: R\$ 45,08
30: R\$ 45,98 45: R\$ 46,90 60: R\$ 47,84

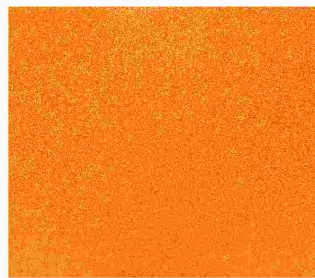

PLACA EVA 40X48CM GLITER LARANJA 10X1
Código: Fábrica: Unidade:
22355 YIN'S PAPER PT/10
F1 F4

UN: R\$ 4,42 AV: R\$ 44,16 15: R\$ 45,08
30: R\$ 45,98 45: R\$ 46,90 60: R\$ 47,84

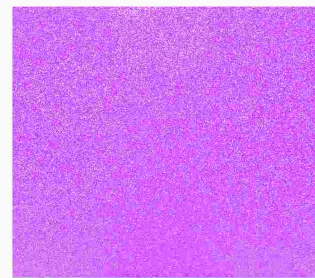

PLACA EVA 40X48CM GLITER LILAS 10X1
Código: Fábrica: Unidade:
32382 YIN'S PAPER PT/10
F1 F4

UN: R\$ 4,42 AV: R\$ 44,16 15: R\$ 45,08
30: R\$ 45,98 45: R\$ 46,90 60: R\$ 47,84



PLACA EVA 40X48CM GLITER MARROM 10X1
Código: Fábrica: Unidade:
28909 YIN'S PAPER PT/10
F1 F4

UN: R\$ 4,55 AV: R\$ 45,48 15: R\$ 46,43
30: R\$ 47,36 45: R\$ 48,31 60: R\$ 49,27

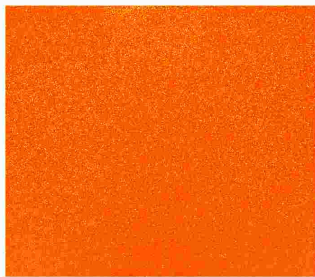

PLACA EVA 40X48CM GLITER NEON LARAN 10X1
Código: Fábrica: Unidade:
46961 YIN'S PAPER PT/10
F1 F4

UN: R\$ 4,42 AV: R\$ 44,16 15: R\$ 45,08
30: R\$ 45,98 45: R\$ 46,90 60: R\$ 47,84

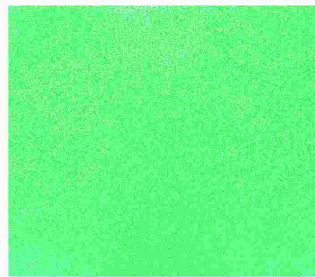

PLACA EVA 40X48CM GLITER NEON VERDE 10X1
Código: Fábrica: Unidade:
46959 YIN'S PAPER PT/10
F1 F4

UN: R\$ 4,42 AV: R\$ 44,16 15: R\$ 45,08
30: R\$ 45,98 45: R\$ 46,90 60: R\$ 47,84



PLACA EVA 40X48CM GLITER OURO 10X1
Código: Fábrica: Unidade:
46240 IBEL PT/10
F1 F4

UN: R\$ 4,72 AV: R\$ 23,62 15: R\$ 24,11
30: R\$ 24,59 45: R\$ 25,08 60: R\$ 25,58



PLACA EVA 40X48CM GLITER OURO 5X1
Código: Fábrica: Unidade:
50318 SANTA FE PT/5
F1 F4

UN: R\$ 4,42 AV: R\$ 44,16 15: R\$ 45,08
30: R\$ 45,98 45: R\$ 46,90 60: R\$ 47,84

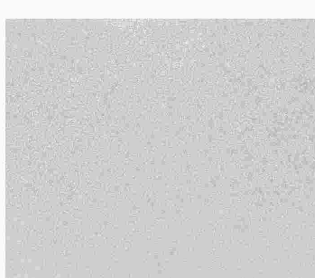

PLACA EVA 40X48CM GLITER PRATA 10X1
Código: Fábrica: Unidade:
32381 YIN'S/IBEL PT/10
F1 F4

UN: R\$ 4,42 AV: R\$ 44,16 15: R\$ 45,08
30: R\$ 45,98 45: R\$ 46,90 60: R\$ 47,84



PLACA EVA 40X48CM GLITER PRETO 10X1
Código: Fábrica: Unidade:
28913 IBEL PT/10
F1 F4

UN: R\$ 4,72 AV: R\$ 23,62 15: R\$ 24,11
30: R\$ 24,59 45: R\$ 25,08 60: R\$ 25,58



PLACA EVA 40X48CM GLITER PRETO 5X1
Código: Fábrica: Unidade:
50319 SANTA FE PT/5
F1 F4

UN: R\$ 4,42 AV: R\$ 44,16 15: R\$ 45,08
30: R\$ 45,98 45: R\$ 46,90 60: R\$ 47,84

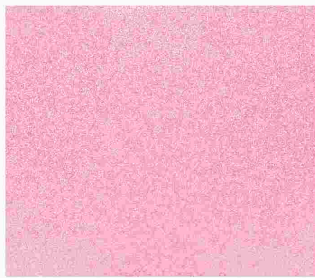

PLACA EVA 40X48CM GLITER ROSA CLARO 10X1
Código: 22357 Fábrica: YIN'S PAPER Unidade: PT/10 F1 F4

UN: R\$ 4,42 AV: R\$ 44,16 15: R\$ 45,08
30: R\$ 45,98 45: R\$ 46,90 60: R\$ 47,84

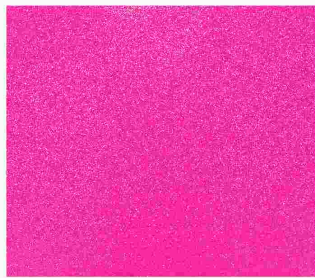

PLACA EVA 40X48CM GLITER ROSA PINK 10X1
Código: 46957 Fábrica: YIN'S PAPER Unidade: PT/10 F1 F4

UN: R\$ 4,42 AV: R\$ 44,16 15: R\$ 45,08
30: R\$ 45,98 45: R\$ 46,90 60: R\$ 47,84

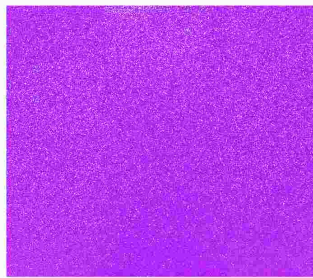

PLACA EVA 40X48CM GLITER ROXO 10X1
Código: 32380 Fábrica: YIN'S PAPER Unidade: PT/10 F1 F4

UN: R\$ 4,42 AV: R\$ 44,16 15: R\$ 45,08
30: R\$ 45,98 45: R\$ 46,90 60: R\$ 47,84

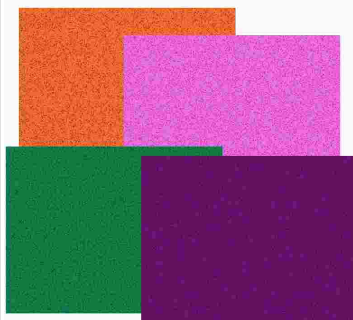

PLACA EVA 40X48CM GLITER SORT 10X1
Código: 35987 Fábrica: MAKE Unidade: PT/10 F1 F4

UN: R\$ 4,42 AV: R\$ 44,16 15: R\$ 45,08
30: R\$ 45,98 45: R\$ 46,90 60: R\$ 47,84

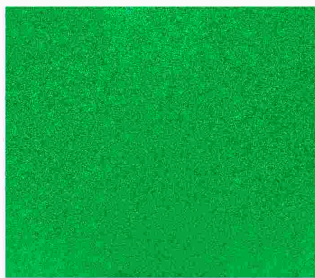

PLACA EVA 40X48CM GLITER VERDE BAND 10X1
Código: 32379 Fábrica: YIN'S/IBEL Unidade: PT/10 F1 F4

UN: R\$ 4,42 AV: R\$ 44,16 15: R\$ 45,08
30: R\$ 45,98 45: R\$ 46,90 60: R\$ 47,84

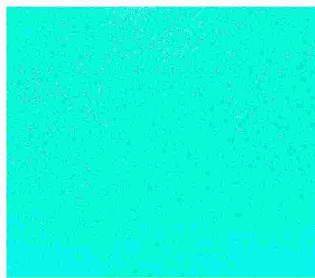

PLACA EVA 40X48CM GLITER VERDE CLAR 10X1
Código: 45138 Fábrica: YIN'S PAPER Unidade: PT/10 F1 F4

UN: R\$ 4,42 AV: R\$ 44,16 15: R\$ 45,08
30: R\$ 45,98 45: R\$ 46,90 60: R\$ 47,84



PLACA EVA 40X48CM GLITER VERMELHO 10X1
Código: 7119 Fábrica: IBEL Unidade: PT/10 F1 F4

UN: R\$ 4,72 AV: R\$ 23,62 15: R\$ 24,11
30: R\$ 24,59 45: R\$ 25,08 60: R\$ 25,58



PLACA EVA 40X48CM GLITER VERMELHO 5X1
Código: 49137 Fábrica: SANTA FE Unidade: PT/5 F1 F4

UN: R\$ 4,42 AV: R\$ 44,16 15: R\$ 45,08
30: R\$ 45,98 45: R\$ 46,90 60: R\$ 47,84

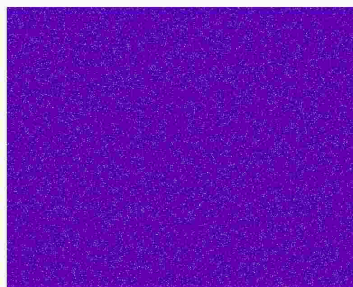

PLACA EVA 40X48CM GLITER VIOLETA 10X1
Código: 37348 Fábrica: DUB FLEX Unidade: PT/10 F1 F4

UN: R\$ 2,05 AV: R\$ 20,48 15: R\$ 20,91
30: R\$ 21,33 45: R\$ 21,75 60: R\$ 22,19



PLACA EVA 40X48CM LARANJA 10X1
Código: 18959 Fábrica: SANTA FE/LEO Unidade: PT/10 F1 F4

UN: R\$ 2,05 AV: R\$ 20,48 15: R\$ 20,91
30: R\$ 21,33 45: R\$ 21,75 60: R\$ 22,19



PLACA EVA 40X48CM LILAS 10X1
Código: 18964 Fábrica: SANTA FE Unidade: PT/10 F1 F4

UN: R\$ 7,19 AV: R\$ 71,89 15: R\$ 73,39
30: R\$ 74,86 45: R\$ 76,36 60: R\$ 77,88

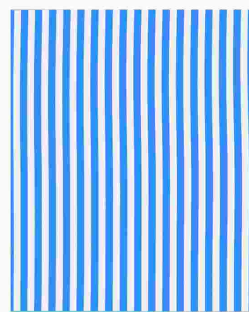

PLACA EVA 40X48CM LISTR AZUL BRANCO 10X1
Código: 48313 Fábrica: BRW Unidade: PT/10 F1 F4

UN: R\$ 7,19 AV: R\$ 71,89 15: R\$ 73,39
30: R\$ 74,86 45: R\$ 76,36 60: R\$ 77,88

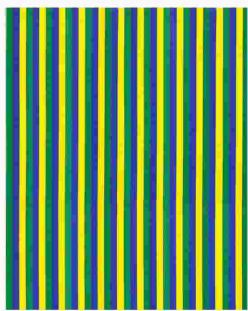

PLACA EVA 40X48CM LISTR BRASIL 10X1
Código: 48314 Fábrica: BRW Unidade: PT/10 F1 F4

UN: R\$ 2,05 AV: R\$ 20,48 15: R\$ 20,91
30: R\$ 21,33 45: R\$ 21,75 60: R\$ 22,19



PLACA EVA 40X48CM MARRON 10X1
Código: 18948 Fábrica: SANTA FE Unidade: PT/10 F1 F4

UN: R\$ 2,05 AV: R\$ 20,48 15: R\$ 20,91
30: R\$ 21,33 45: R\$ 21,75 60: R\$ 22,19



PLACA EVA 40X48CM PRETO 10X1
Código: 48952 Fábrica: SANTA FE/LEOA Unidade: PT/10 F1 F4

UN: R\$ 2,05 AV: R\$ 20,48 15: R\$ 20,91
30: R\$ 21,33 45: R\$ 21,75 60: R\$ 22,19



PLACA EVA 40X48CM ROSA CLARO 10X1
Código: 7115 Fábrica: BRW/IBEL Unidade: PT/10 F1 F4

UN: R\$ 2,05 AV: R\$ 20,48 15: R\$ 20,91
30: R\$ 21,33 45: R\$ 21,75 60: R\$ 22,19



PLACA EVA 40X48CM ROSA PINK 10X1

Código: 18961 Fábrica: BRW Unidade: PT/10 F1 F4

UN: R\$ 2,05 AV: R\$ 20,48 15: R\$ 20,91
30: R\$ 21,33 45: R\$ 21,75 60: R\$ 22,19



PLACA EVA 40X48CM ROXO 10X1

Código: 22360 Fábrica: SANTAFE/BRW Unidade: PT/10 F1 F4

UN: R\$ 2,05 AV: R\$ 20,48 15: R\$ 20,91
30: R\$ 21,33 45: R\$ 21,75 60: R\$ 22,19



PLACA EVA 40X48CM SALMAO 10X1

Código: 18957 Fábrica: BRW Unidade: PT/10 F1 F4

UN: R\$ 2,05 AV: R\$ 20,48 15: R\$ 20,91
30: R\$ 21,33 45: R\$ 21,75 60: R\$ 22,19



PLACA EVA 40X48CM SORTIDO 10X1

Código: 18973 Fábrica: MAKE Unidade: PT/10 F1 F4

UN: R\$ 2,05 AV: R\$ 20,48 15: R\$ 20,91
30: R\$ 21,33 45: R\$ 21,75 60: R\$ 22,19



PLACA EVA 40X48CM TERRA 022 10X1

Código: 38016 Fábrica: BRW Unidade: PT/10 F1 F4

UN: R\$ 2,05 AV: R\$ 20,48 15: R\$ 20,91
30: R\$ 21,33 45: R\$ 21,75 60: R\$ 22,19



PLACA EVA 40X48CM VERDE BANDEIRA 10X1

Código: 44164 Fábrica: BRW Unidade: PT/10 F1 F4

UN: R\$ 2,05 AV: R\$ 20,48 15: R\$ 20,91
30: R\$ 21,33 45: R\$ 21,75 60: R\$ 22,19



PLACA EVA 40X48CM VERDE CLARO 10X1

Código: 7117 Fábrica: LEONORA Unidade: PT/10 F1 F4

UN: R\$ 2,05 AV: R\$ 20,48 15: R\$ 20,91
30: R\$ 21,33 45: R\$ 21,75 60: R\$ 22,19

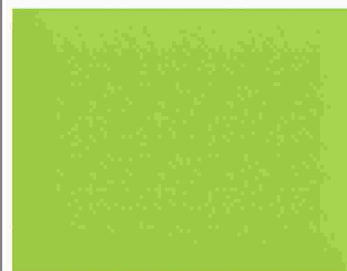

PLACA EVA 40X48CM VERDE FLUORES 017 10X1

Código: 18967 Fábrica: BRW Unidade: PT/10 F1 F4

UN: R\$ 2,05 AV: R\$ 20,48 15: R\$ 20,91
30: R\$ 21,33 45: R\$ 21,75 60: R\$ 22,19



PLACA EVA 40X48CM VERDE FOLHA 016 10X1

Código: 22362 Fábrica: BRW Unidade: PT/10 F1 F4

UN: R\$ 2,05 AV: R\$ 20,48 15: R\$ 20,91
30: R\$ 21,33 45: R\$ 21,75 60: R\$ 22,19



PLACA EVA 40X48CM VERDE MUSGO 019 10X1

Código: 18969 Fábrica: BRW Unidade: PT/10 F1 F4

UN: R\$ 2,05 AV: R\$ 20,48 15: R\$ 20,91
30: R\$ 21,33 45: R\$ 21,75 60: R\$ 22,19



PLACA EVA 40X48CM VERDE PETROLEO 10X1

Código: 48876 Fábrica: IBEL Unidade: PT/10 F1 F4

UN: R\$ 2,05 AV: R\$ 20,48 15: R\$ 20,91
30: R\$ 21,33 45: R\$ 21,75 60: R\$ 22,19



PLACA EVA 40X48CM VERMELHO 10X1

Código: 18962 Fábrica: SANTA FE Unidade: PT/10 F1 F4

UN: R\$ 4,11 AV: R\$ 41,08 15: R\$ 41,93
30: R\$ 42,77 45: R\$ 43,63 60: R\$ 44,50

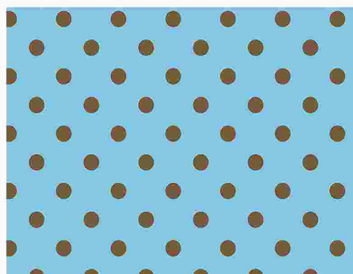

PLACA EVA 40X50CM EST POA AZUL/MARR 10X1

Código: 34139 Fábrica: BRW Unidade: PT/10 F1 F4

UN: R\$ 4,11 AV: R\$ 41,08 15: R\$ 41,93
30: R\$ 42,77 45: R\$ 43,63 60: R\$ 44,50

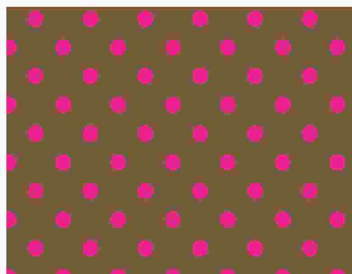

PLACA EVA 40X50CM EST POA MARR/ROSA 10X1

Código: 34136 Fábrica: BRW Unidade: PT/10 F1 F4

UN: R\$ 4,11 AV: R\$ 41,08 15: R\$ 41,93
30: R\$ 42,77 45: R\$ 43,63 60: R\$ 44,50

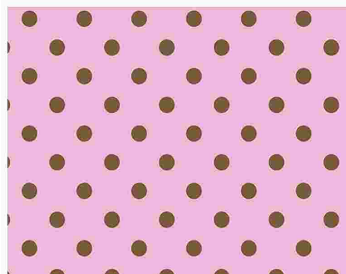

PLACA EVA 40X50CM EST POA ROSA/MARR 10X1

Código: 34135 Fábrica: BRW Unidade: PT/10 F1 F4

UN: R\$ 2,57 AV: R\$ 25,67 15: R\$ 26,20
30: R\$ 26,73 45: R\$ 27,26 60: R\$ 27,81



PLACA EVA 40X60CM AMARELO 10X1

Código: 43707 Fábrica: BRW Unidade: PT/10 F1 F4

UN: R\$ 2,57 AV: R\$ 25,67 15: R\$ 26,20
30: R\$ 26,73 45: R\$ 27,26 60: R\$ 27,81



PLACA EVA 40X60CM AZUL CLARO 4907 10X1
Código: Fábrika: Unidade:
48721 LEOARTE PT/10
F1 F4

UN: R\$ 2,46 AV: R\$ 24,64 15: R\$ 25,16
30: R\$ 25,66 45: R\$ 26,17 60: R\$ 26,70



PLACA EVA 40X60CM AZUL ROYAL 10X1
Código: Fábrika: Unidade:
49140 EVAMAX PT/10
F1 F4

UN: R\$ 2,57 AV: R\$ 25,67 15: R\$ 26,20
30: R\$ 26,73 45: R\$ 27,26 60: R\$ 27,81

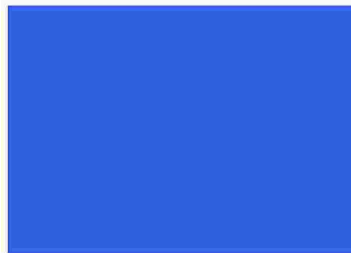

PLACA EVA 40X60CM AZUL ROYAL 10X1
Código: Fábrika: Unidade:
45379 BRW PT/10
F1 F4

UN: R\$ 2,57 AV: R\$ 25,67 15: R\$ 26,20
30: R\$ 26,73 45: R\$ 27,26 60: R\$ 27,81

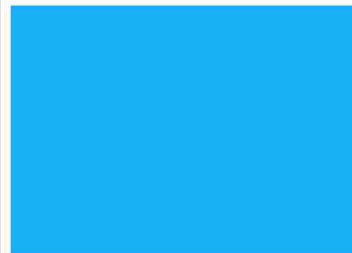

PLACA EVA 40X60CM AZUL 10X1
Código: Fábrika: Unidade:
43697 BRW PT/10
F1 F4

UN: R\$ 2,57 AV: R\$ 25,67 15: R\$ 26,20
30: R\$ 26,73 45: R\$ 27,26 60: R\$ 27,81

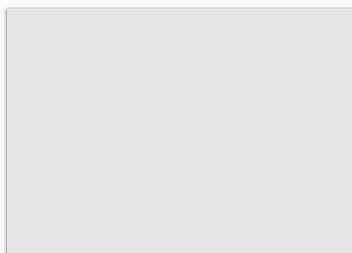

PLACA EVA 40X60CM BRANCO 4906 10X1
Código: Fábrika: Unidade:
43689 LEOARTE PT/10
F1 F4

UN: R\$ 5,13 AV: R\$ 25,67 15: R\$ 26,20
30: R\$ 26,73 45: R\$ 27,26 60: R\$ 27,81



PLACA EVA 40X60CM CIRCULO AZUL 3D 5X1
Código: Fábrika: Unidade:
38573 MAKE PT/5
F4

UN: R\$ 5,13 AV: R\$ 51,35 15: R\$ 52,42
30: R\$ 53,47 45: R\$ 54,54 60: R\$ 55,63

40 cm
60 cm

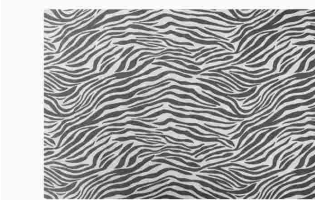

PLACA EVA 40X60CM ESTAMP BOLA 10X1
Código: Fábrika: Unidade:
43766 WIN PAPER PT/10
F1 F4

UN: R\$ 5,13 AV: R\$ 25,67 15: R\$ 26,20
30: R\$ 26,73 45: R\$ 27,26 60: R\$ 27,81



PLACA EVA 40X60CM ESTAMP FLORES ROSA 5X1
Código: Fábrika: Unidade:
38578 MAKE PT/5
F4

UN: R\$ 5,13 AV: R\$ 25,67 15: R\$ 26,20
30: R\$ 26,73 45: R\$ 27,26 60: R\$ 27,81



PLACA EVA 40X60CM ESTAMP FLORES VERM 5X1
Código: Fábrika: Unidade:
38577 MAKE PT/5
F1 F4

UN: R\$ 5,13 AV: R\$ 25,67 15: R\$ 26,20
30: R\$ 26,73 45: R\$ 27,26 60: R\$ 27,81



PLACA EVA 40X60CM ESTAMP FRUTAS 5X1
Código: Fábrika: Unidade:
38574 MAKE PT/5
F1 F4

UN: R\$ 5,13 AV: R\$ 25,67 15: R\$ 26,20
30: R\$ 26,73 45: R\$ 27,26 60: R\$ 27,81



PLACA EVA 40X60CM ESTAMP INF AMARELO 5X1
Código: Fábrika: Unidade:
38579 MAKE PT/5
F4

UN: R\$ 5,13 AV: R\$ 25,67 15: R\$ 26,20
30: R\$ 26,73 45: R\$ 27,26 60: R\$ 27,81



PLACA EVA 40X60CM ESTAMP MESC AZUL 5X1
Código: Fábrika: Unidade:
38575 MAKE PT/5
F1 F4

UN: R\$ 5,13 AV: R\$ 25,67 15: R\$ 26,20
30: R\$ 26,73 45: R\$ 27,26 60: R\$ 27,81



PLACA EVA 40X60CM ESTAMP MESC VERMEL 5X1
Código: Fábrika: Unidade:
38576 MAKE PT/5
F4

UN: R\$ 5,13 AV: R\$ 25,67 15: R\$ 26,20
30: R\$ 26,73 45: R\$ 27,26 60: R\$ 27,81

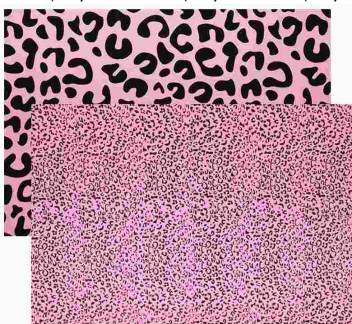

PLACA EVA 40X60CM ESTAMP ONCA ROSA 5X1
Código: Fábrika: Unidade:
38583 MAKE PT/5
F1 F4

UN: R\$ 5,13 AV: R\$ 51,35 15: R\$ 52,42
30: R\$ 53,47 45: R\$ 54,54 60: R\$ 55,63

40 cm
60 cm



PLACA EVA 40X60CM ESTAMP ONCA 10X1
Código: Fábrika: Unidade:
43764 WIN PAPER PT/10
F1 F4

UN: R\$ 6,16 AV: R\$ 30,81 15: R\$ 31,45
30: R\$ 32,08 45: R\$ 32,72 60: R\$ 33,37

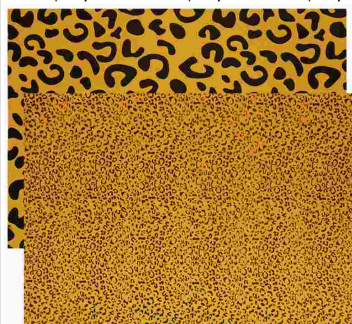

PLACA EVA 40X60CM ESTAMP ONCA 5X1
Código: Fábrika: Unidade:
38584 MAKE PT/5
F4

UN: R\$ 5,13 AV: R\$ 51,35 15: R\$ 52,42
 30: R\$ 53,47 45: R\$ 54,54 60: R\$ 55,63

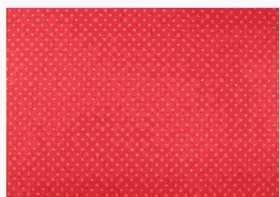

PLACA EVA 40X60CM ESTAMP POA 10X1
 Código: Fábrica: Unidade:
43769 WIN PAPER PT/10
 F1 F4

UN: R\$ 5,13 AV: R\$ 25,67 15: R\$ 26,20
 30: R\$ 26,73 45: R\$ 27,26 60: R\$ 27,81



PLACA EVA 40X60CM ESTAMP VAQUINHA 5X1
 Código: Fábrica: Unidade:
38581 MAKE PT/5
 F4

UN: R\$ 5,13 AV: R\$ 25,67 15: R\$ 26,20
 30: R\$ 26,73 45: R\$ 27,26 60: R\$ 27,81

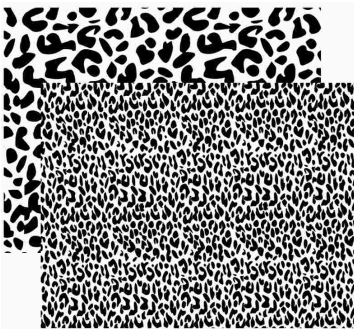

PLACA EVA 40X60CM ESTAMP VAQUINHA 5X1
 Código: Fábrica: Unidade:
38582 MAKE PT/5
 F4

UN: R\$ 5,13 AV: R\$ 51,35 15: R\$ 52,42
 30: R\$ 53,47 45: R\$ 54,54 60: R\$ 55,63



PLACA EVA 40X60CM ESTAMP ZEBRA 10X1
 Código: Fábrica: Unidade:
43765 WIN PAPER PT/10
 F1 F4

UN: R\$ 6,16 AV: R\$ 61,62 15: R\$ 62,91
 30: R\$ 64,16 45: R\$ 65,45 60: R\$ 66,76

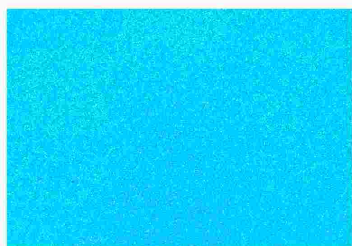

PLACA EVA 40X60CM GLITER AZUL CLARO 10X1
 Código: Fábrica: Unidade:
46239 YIN'S PAPER PT/10
 F1 F4

UN: R\$ 6,16 AV: R\$ 61,62 15: R\$ 62,91
 30: R\$ 64,16 45: R\$ 65,45 60: R\$ 66,76

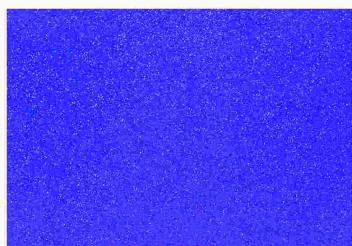

PLACA EVA 40X60CM GLITER AZUL ESCUR 10X1
 Código: Fábrica: Unidade:
46956 YIN'S/IBEL PT/10
 F1 F4

UN: R\$ 6,16 AV: R\$ 61,62 15: R\$ 62,91
 30: R\$ 64,16 45: R\$ 65,45 60: R\$ 66,76

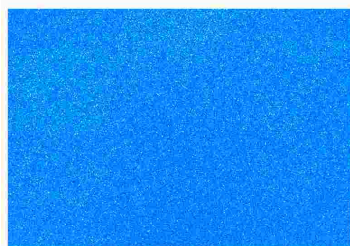

PLACA EVA 40X60CM GLITER AZUL 10X1
 Código: Fábrica: Unidade:
46222 YIN'S/IBEL PT/10
 F1 F4

UN: R\$ 6,16 AV: R\$ 61,62 15: R\$ 62,91
 30: R\$ 64,16 45: R\$ 65,45 60: R\$ 66,76

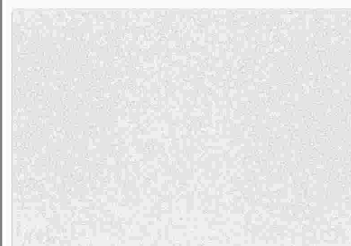

PLACA EVA 40X60CM GLITER BRANCO 10X1
 Código: Fábrica: Unidade:
46221 YIN'S/IBEL PT/10
 F1 F4

UN: R\$ 6,16 AV: R\$ 61,62 15: R\$ 62,91
 30: R\$ 64,16 45: R\$ 65,45 60: R\$ 66,76



PLACA EVA 40X60CM GLITER BRONZE 10X1
 Código: Fábrica: Unidade:
46954 YIN'S PAPER PT/10
 F1 F4

UN: R\$ 6,16 AV: R\$ 61,62 15: R\$ 62,91
 30: R\$ 64,16 45: R\$ 65,45 60: R\$ 66,76



PLACA EVA 40X60CM GLITER ECON AZUL 10X1
 Código: Fábrica: Unidade:
45427 IBEL PT/10
 F1 F4

UN: R\$ 6,16 AV: R\$ 61,62 15: R\$ 62,91
 30: R\$ 64,16 45: R\$ 65,45 60: R\$ 66,76



PLACA EVA 40X60CM GLITER ESP COBRE 10X1
 Código: Fábrica: Unidade:
46230 IBEL PT/10
 F1 F4

UN: R\$ 6,16 AV: R\$ 30,81 15: R\$ 31,45
 30: R\$ 32,08 45: R\$ 32,72 60: R\$ 33,37



PLACA EVA 40X60CM GLITER LARANJA 5X1
 Código: Fábrica: Unidade:
41839 ONDA PT/5
 F1 F4

UN: R\$ 6,16 AV: R\$ 61,62 15: R\$ 62,91
 30: R\$ 64,16 45: R\$ 65,45 60: R\$ 66,76

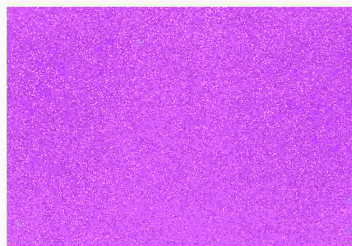

PLACA EVA 40X60CM GLITER LILAS 10X1
 Código: Fábrica: Unidade:
46223 YIN'S/IBEL PT/10
 F1 F4

UN: R\$ 6,16 AV: R\$ 30,81 15: R\$ 31,45
 30: R\$ 32,08 45: R\$ 32,72 60: R\$ 33,37



PLACA EVA 40X60CM GLITER LILAS 5X1
 Código: Fábrica: Unidade:
41840 ONDA PT/5
 F1 F4

UN: R\$ 6,16 AV: R\$ 61,62 15: R\$ 62,91
 30: R\$ 64,16 45: R\$ 65,45 60: R\$ 66,76

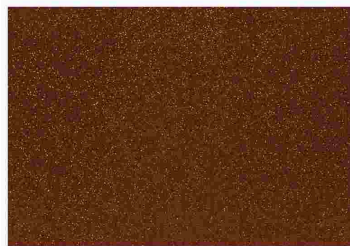

PLACA EVA 40X60CM GLITER MARROM 10X1
 Código: Fábrica: Unidade:
46232 YIN'S/IBEL PT/10
 F1 F4

UN: R\$ 6,16 AV: R\$ 30,81 15: R\$ 31,45
 30: R\$ 32,08 45: R\$ 32,72 60: R\$ 33,37

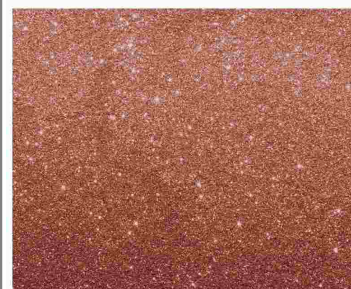

PLACA EVA 40X60CM GLITER MARROM 5X1
 Código: Fábrica: Unidade:
41836 ONDA PT/5
 F1 F4

UN: R\$ 6,16 AV: R\$ 61,62 15: R\$ 62,91
30: R\$ 64,16 45: R\$ 65,45 60: R\$ 66,76

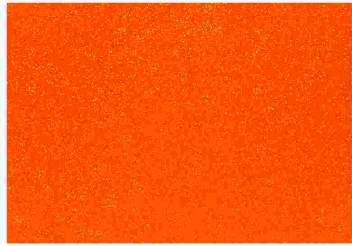

PLACA EVA 40X60CM GLITER NEON LARAN 10X1
Código: Fábrica: Unidade:
46953 YIN'S PAPER PT/10
F1 F4

UN: R\$ 6,16 AV: R\$ 61,62 15: R\$ 62,91
30: R\$ 64,16 45: R\$ 65,45 60: R\$ 66,76

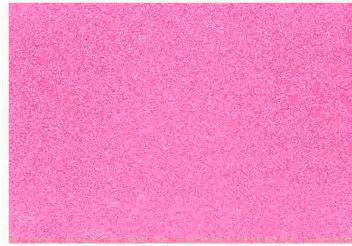

PLACA EVA 40X60CM GLITER NEON ROSA 10X1
Código: Fábrica: Unidade:
46952 YIN'S PAPER PT/10
F1 F4

UN: R\$ 6,16 AV: R\$ 61,62 15: R\$ 62,91
30: R\$ 64,16 45: R\$ 65,45 60: R\$ 66,76

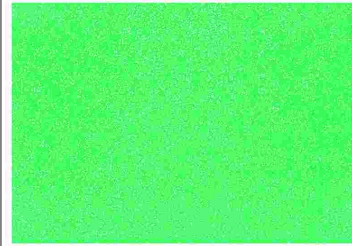

PLACA EVA 40X60CM GLITER NEON VERDE 10X1
Código: Fábrica: Unidade:
46951 YIN'S PAPER PT/10
F1 F4

UN: R\$ 6,16 AV: R\$ 61,62 15: R\$ 62,91
30: R\$ 64,16 45: R\$ 65,45 60: R\$ 66,76

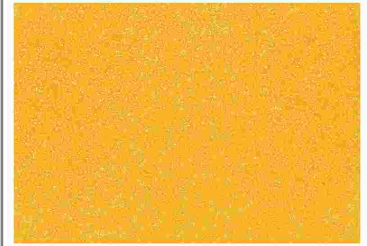

PLACA EVA 40X60CM GLITER OURO 10X1
Código: Fábrica: Unidade:
46233 YIN'S PAPER PT/10
F1 F4

UN: R\$ 6,16 AV: R\$ 61,62 15: R\$ 62,91
30: R\$ 64,16 45: R\$ 65,45 60: R\$ 66,76

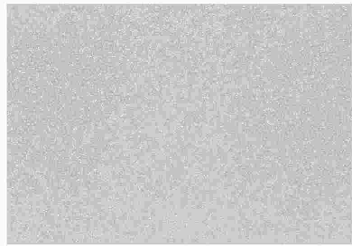

PLACA EVA 40X60CM GLITER PRATA 10X1
Código: Fábrica: Unidade:
46237 YIN'S PAPER PT/10
F1 F4

UN: R\$ 6,16 AV: R\$ 30,81 15: R\$ 31,45
30: R\$ 32,08 45: R\$ 32,72 60: R\$ 33,37



PLACA EVA 40X60CM GLITER PRATA 5X1
Código: Fábrica: Unidade:
41842 ONDA PT/5
F1 F4

UN: R\$ 6,16 AV: R\$ 61,62 15: R\$ 62,91
30: R\$ 64,16 45: R\$ 65,45 60: R\$ 66,76

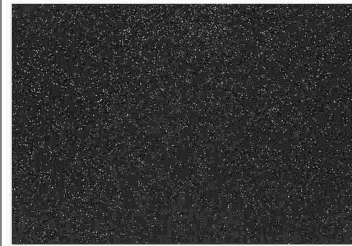

PLACA EVA 40X60CM GLITER PRETO 10X1
Código: Fábrica: Unidade:
46217 YIN'S/IBEL PT/10
F1 F4

UN: R\$ 6,16 AV: R\$ 61,62 15: R\$ 62,91
30: R\$ 64,16 45: R\$ 65,45 60: R\$ 66,76

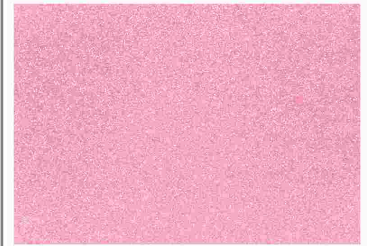

PLACA EVA 40X60CM GLITER ROSA CLARO 10X1
Código: Fábrica: Unidade:
46234 YIN'S PAPER PT/10
F1 F4

UN: R\$ 6,16 AV: R\$ 30,81 15: R\$ 31,45
30: R\$ 32,08 45: R\$ 32,72 60: R\$ 33,37



PLACA EVA 40X60CM GLITER ROSA PINK 5X1
Código: Fábrica: Unidade:
49138 EVAMAX PT/5
F1 F4

UN: R\$ 6,16 AV: R\$ 61,62 15: R\$ 62,91
30: R\$ 64,16 45: R\$ 65,45 60: R\$ 66,76



PLACA EVA 40X60CM GLITER ROSA 10X1
Código: Fábrica: Unidade:
46238 YIN'S PAPER PT/10
F1 F4

UN: R\$ 6,16 AV: R\$ 30,81 15: R\$ 31,45
30: R\$ 32,08 45: R\$ 32,72 60: R\$ 33,37



PLACA EVA 40X60CM GLITER ROSA 5X1
Código: Fábrica: Unidade:
41838 ONDA PT/5
F1 F4

UN: R\$ 6,16 AV: R\$ 30,81 15: R\$ 31,45
30: R\$ 32,08 45: R\$ 32,72 60: R\$ 33,37



PLACA EVA 40X60CM GLITER SKIN 5X1
Código: Fábrica: Unidade:
41843 ONDA PT/5
F1 F4

UN: R\$ 6,16 AV: R\$ 61,62 15: R\$ 62,91
30: R\$ 64,16 45: R\$ 65,45 60: R\$ 66,76



PLACA EVA 40X60CM GLITER VERDE BAND 10X1
Código: Fábrica: Unidade:
46236 YIN'S PAPER PT/10
F1 F4

UN: R\$ 6,16 AV: R\$ 30,81 15: R\$ 31,45
30: R\$ 32,08 45: R\$ 32,72 60: R\$ 33,37



PLACA EVA 40X60CM GLITER VERDE CLARO 5X1
Código: Fábrica: Unidade:
41841 ONDA PT/5
F1 F4

UN: R\$ 6,16 AV: R\$ 61,62 15: R\$ 62,91
30: R\$ 64,16 45: R\$ 65,45 60: R\$ 66,76

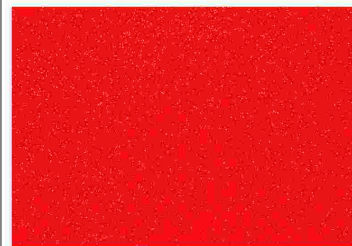

PLACA EVA 40X60CM GLITER VERM 10X1
Código: Fábrica: Unidade:
46220 YIN'S/IBEL PT/10
F1 F4

UN: R\$ 2,57 AV: R\$ 25,67 15: R\$ 26,20
30: R\$ 26,73 45: R\$ 27,26 60: R\$ 27,81



PLACA EVA 40X60CM LARANJA 4903 10X1
Código: Fábrica: Unidade:
22527 LEOARTE PT/10
F1 F4

UN: R\$ 2,57 AV: R\$ 25,67 15: R\$ 26,20
30: R\$ 26,73 45: R\$ 27,26 60: R\$ 27,81



PLACA EVA 40X60CM LILAS 10X1

Código: Fábrica: Unidade:
43698 IBEL PT/10
F1 F4

UN: R\$ 2,57 AV: R\$ 25,67 15: R\$ 26,20
30: R\$ 26,73 45: R\$ 27,26 60: R\$ 27,81



PLACA EVA 40X60CM LILAS 4908 10X1

Código: Fábrica: Unidade:
48366 LEOARTE PT/10
F1 F4

UN: R\$ 2,57 AV: R\$ 25,67 15: R\$ 26,20
30: R\$ 26,73 45: R\$ 27,26 60: R\$ 27,81



PLACA EVA 40X60CM MARROM 4909 10X1

Código: Fábrica: Unidade:
48364 LEOARTE PT/10
F1 F4

UN: R\$ 6,16 AV: R\$ 30,81 15: R\$ 31,45
30: R\$ 32,08 45: R\$ 32,72 60: R\$ 33,37

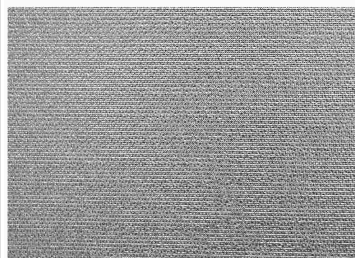

PLACA EVA 40X60CM METALICO PRATA 5X1

Código: Fábrica: Unidade:
38570 MAKE PT/5
F1 F4

UN: R\$ 6,16 AV: R\$ 30,81 15: R\$ 31,45
30: R\$ 32,08 45: R\$ 32,72 60: R\$ 33,37

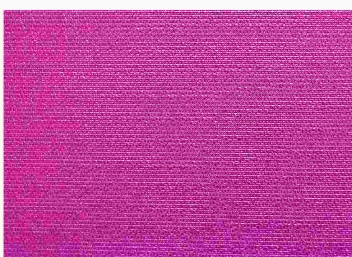

PLACA EVA 40X60CM METALICO ROSA PINK 5X1

Código: Fábrica: Unidade:
38571 MAKE PT/5
F1 F4

UN: R\$ 2,57 AV: R\$ 25,67 15: R\$ 26,20
30: R\$ 26,73 45: R\$ 27,26 60: R\$ 27,81

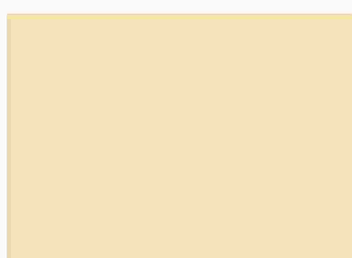

PLACA EVA 40X60CM PELE 4753 10X1

Código: Fábrica: Unidade:
45383 LEOARTE PT/10
F1 F4

UN: R\$ 2,57 AV: R\$ 25,67 15: R\$ 26,20
30: R\$ 26,73 45: R\$ 27,26 60: R\$ 27,81



PLACA EVA 40X60CM PRETO 4905 10X1

Código: Fábrica: Unidade:
43706 LEOARTE PT/10
F1 F4

UN: R\$ 2,57 AV: R\$ 25,67 15: R\$ 26,20
30: R\$ 26,73 45: R\$ 27,26 60: R\$ 27,81



PLACA EVA 40X60CM ROSA BEBE 4707 10X1

Código: Fábrica: Unidade:
45382 LEOARTE PT/10
F1 F4

UN: R\$ 2,46 AV: R\$ 24,64 15: R\$ 25,16
30: R\$ 25,66 45: R\$ 26,17 60: R\$ 26,70



PLACA EVA 40X60CM ROSA PINK 4930 10X1

Código: Fábrica: Unidade:
45381 LEOARTE PT/10
F1 F4

UN: R\$ 2,57 AV: R\$ 25,67 15: R\$ 26,20
30: R\$ 26,73 45: R\$ 27,26 60: R\$ 27,81



PLACA EVA 40X60CM ROSA 4911 10X1

Código: Fábrica: Unidade:
48363 LEOARTE PT/10
F1 F4

UN: R\$ 2,57 AV: R\$ 25,67 15: R\$ 26,20
30: R\$ 26,73 45: R\$ 27,26 60: R\$ 27,81



PLACA EVA 40X60CM ROXO 4914 10X1

Código: Fábrica: Unidade:
48365 LEOARTE PT/10
F1 F4

UN: R\$ 2,57 AV: R\$ 25,67 15: R\$ 26,20
30: R\$ 26,73 45: R\$ 27,26 60: R\$ 27,81



PLACA EVA 40X60CM VERDE BANDEIRA 10X1

Código: Fábrica: Unidade:
43695 BRW PT/10
F1 F4

UN: R\$ 2,46 AV: R\$ 24,64 15: R\$ 25,16
30: R\$ 25,66 45: R\$ 26,17 60: R\$ 26,70



PLACA EVA 40X60CM VERDE CLARO 10X1

Código: Fábrica: Unidade:
49139 EVAMAX PT/10
F1 F4

UN: R\$ 2,57 AV: R\$ 25,67 15: R\$ 26,20
30: R\$ 26,73 45: R\$ 27,26 60: R\$ 27,81



PLACA EVA 40X60CM VERDE GRAMA 4705 10X1

Código: Fábrica: Unidade:
48361 LEOARTE PT/10
F1 F4

UN: R\$ 2,57 AV: R\$ 25,67 15: R\$ 26,20
30: R\$ 26,73 45: R\$ 27,26 60: R\$ 27,81



PLACA EVA 40X60CM VERDE 4902 10X1

Código: Fábrica: Unidade:
48722 LEOARTE PT/10
F1 F4

UN: R\$ 2,57 AV: R\$ 25,67 15: R\$ 26,20
30: R\$ 26,73 45: R\$ 27,26 60: R\$ 27,81



PLACA EVA 40X60CM VERMELHO FOG 4710 10X1

Código: Fábrica: Unidade:
48362 LEOARTE PT/10
F1 F4

UN: R\$ 2,67 AV: R\$ 133,53 15: R\$ 136,31
30: R\$ 139,03 45: R\$ 141,81 60: R\$ 144,65

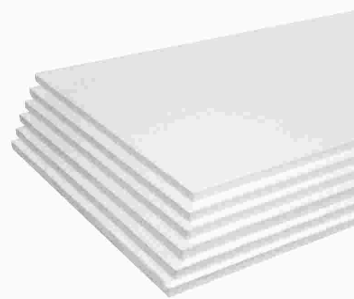

PLACA ISOPOR 1000X500X5MM 50X1

Código: 42395 Fábrica: ISOMAX Unidade: PT/50 F1 F4

UN: R\$ 4,42 AV: R\$ 110,42 15: R\$ 112,72
30: R\$ 114,98 45: R\$ 117,28 60: R\$ 119,62

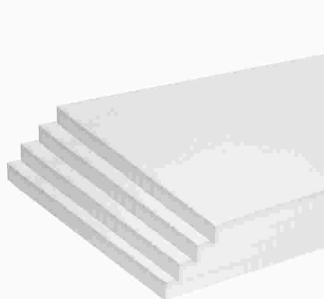

PLACA ISOPOR 1000X500X10MM 25X1

Código: 7111 Fábrica: ISOMAX Unidade: PT/25 F1 F4

UN: R\$ 6,90 AV: R\$ 110,42 15: R\$ 112,72
30: R\$ 114,98 45: R\$ 117,28 60: R\$ 119,62

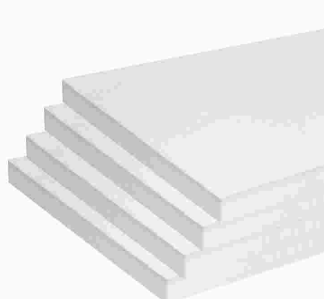

PLACA ISOPOR 1000X500X15MM 16X1

Código: 29881 Fábrica: ISOMAX Unidade: PT/16 F1 F4

UN: R\$ 9,20 AV: R\$ 110,42 15: R\$ 112,72
30: R\$ 114,98 45: R\$ 117,28 60: R\$ 119,62

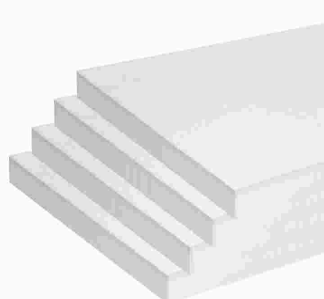

PLACA ISOPOR 1000X500X20MM 12X1

Código: 31928 Fábrica: ISOMAX Unidade: PT/12 F1 F4

UN: R\$ 11,04 AV: R\$ 110,42 15: R\$ 112,72
30: R\$ 114,98 45: R\$ 117,28 60: R\$ 119,62



PLACA ISOPOR 1000X500X25MM 10X1

Código: 12578 Fábrica: ISOMAX Unidade: PT/10 F1 F4

UN: R\$ 13,80 AV: R\$ 110,42 15: R\$ 112,72
30: R\$ 114,98 45: R\$ 117,28 60: R\$ 119,62



PLACA ISOPOR 1000X500X30MM 8X1

Código: 30091 Fábrica: ISOMAX Unidade: PT/8 F1 F4

UN: R\$ 22,08 AV: R\$ 110,42 15: R\$ 112,72
30: R\$ 114,98 45: R\$ 117,28 60: R\$ 119,62

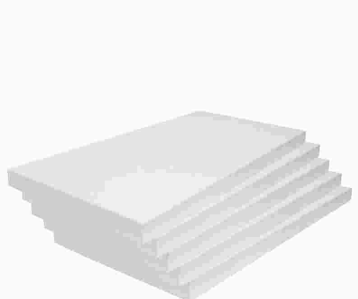

PLACA ISOPOR 1000X500X45MM 5X1

Código: 43776 Fábrica: ISOMAX Unidade: PT/5 F1 F4

UN: R\$ 22,08 AV: R\$ 110,42 15: R\$ 112,72
30: R\$ 114,98 45: R\$ 117,28 60: R\$ 119,62

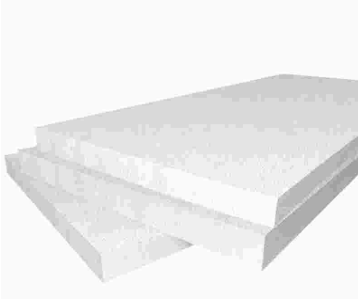

PLACA ISOPOR 1000X500X50MM 5X1

Código: 41761 Fábrica: ISOMAX Unidade: PT/5 F1 F4

UN: R\$ 110,42 AV: R\$ 110,42 15: R\$ 112,72
30: R\$ 114,98 45: R\$ 117,28 60: R\$ 119,62



PLACA ISOPOR 1000X500X75MM 3X1

Código: 42345 Fábrica: ISOMAX Unidade: PT/1 F1 F4

UN: R\$ 3,59 AV: R\$ 35,94 15: R\$ 36,69
30: R\$ 37,42 45: R\$ 38,17 60: R\$ 38,94

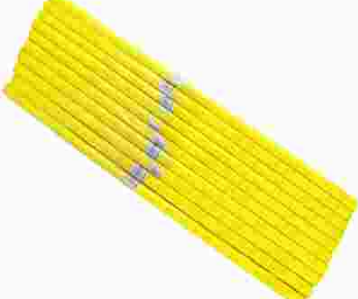

PLASTICO ENCAPAR 2MX45CM AMARELO 10X1

Código: 2533 Fábrica: DDL Unidade: PT/10 F1 F4

UN: R\$ 3,59 AV: R\$ 35,94 15: R\$ 36,69
30: R\$ 37,42 45: R\$ 38,17 60: R\$ 38,94



PLASTICO ENCAPAR 2MX45CM AZUL 10X1

Código: 2532 Fábrica: DDL Unidade: PT/10 F1 F4

UN: R\$ 3,60 AV: R\$ 35,95 15: R\$ 36,70
30: R\$ 37,43 45: R\$ 38,18 60: R\$ 38,95

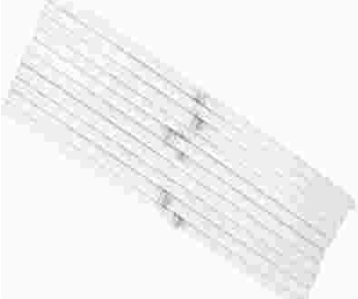

PLASTICO ENCAPAR 2MX45CM BRANCO 10X1

Código: 44377 Fábrica: DDL Unidade: PT/10 F1 F4

UN: R\$ 3,59 AV: R\$ 35,94 15: R\$ 36,69
30: R\$ 37,42 45: R\$ 38,17 60: R\$ 38,94

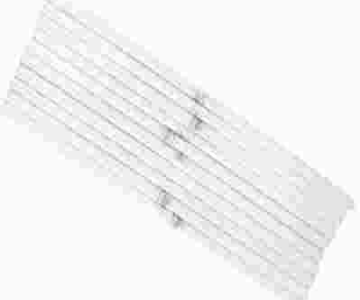

PLASTICO ENCAPAR 2MX45CM INCOLOR 10X1

Código: 14136 Fábrica: DDL Unidade: PT/10 F1 F4

UN: R\$ 3,59 AV: R\$ 35,94 15: R\$ 36,69
30: R\$ 37,42 45: R\$ 38,17 60: R\$ 38,94



PLASTICO ENCAPAR 2MX45CM ROSA 10X1

Código: 44371 Fábrica: DDL Unidade: PT/10 F1 F4

UN: R\$ 3,59 AV: R\$ 35,94 15: R\$ 36,69
30: R\$ 37,42 45: R\$ 38,17 60: R\$ 38,94



PLASTICO ENCAPAR 2MX45CM SORT 10X1

Código: 13136 Fábrica: DDL Unidade: PT/10 F1 F4

UN: R\$ 3,59 AV: R\$ 35,94 15: R\$ 36,69
30: R\$ 37,42 45: R\$ 38,17 60: R\$ 38,94



PLASTICO ENCAPAR 2MX45CM VERDE 10X1

Código: 3969 Fábrica: DDL Unidade: PT/10 F1 F4

UN: R\$ 3,59 AV: R\$ 35,94 15: R\$ 36,69
30: R\$ 37,42 45: R\$ 38,17 60: R\$ 38,94



PLASTICO ENCAPAR 2MX45CM VERMELH 10X1

Código: 2534 Fábrica: DDL Unidade: PT/10 F1 F4

UN: R\$ 1,64 AV: R\$ 41,08 15: R\$ 41,93
30: R\$ 42,77 45: R\$ 43,63 60: R\$ 44,50



PLASTICO ENCAPAR 25MX45CM AZUL CORACAO

Código: 3973 Fábrica: FA Unidade: RL/25 F1 F4

UN: R\$ 1,64 AV: R\$ 41,08 15: R\$ 41,93
30: R\$ 42,77 45: R\$ 43,63 60: R\$ 44,50



PLASTICO ENCAPAR 25MX45CM INF

Código: 42833 Fábrica: FA Unidade: RL/25 F1 F4

UN: R\$ 1,64 AV: R\$ 41,08 15: R\$ 41,93
30: R\$ 42,77 45: R\$ 43,63 60: R\$ 44,50



PLASTICO ENCAPAR 25MX45CM INF FEMININO

Código: 42832 Fábrica: FA Unidade: RL/25 F1 F4

UN: R\$ 1,64 AV: R\$ 41,08 15: R\$ 41,93
30: R\$ 42,77 45: R\$ 43,63 60: R\$ 44,50



PLASTICO ENCAPAR 25MX45CM LISO AZUL

Código: 27953 Fábrica: NEW MAGIC Unidade: RL/25 F1 F4

UN: R\$ 1,64 AV: R\$ 41,08 15: R\$ 41,93
30: R\$ 42,77 45: R\$ 43,63 60: R\$ 44,50



PLASTICO ENCAPAR 25MX45CM TRANSP DEC

Código: 42837 Fábrica: FA Unidade: RL/25 F1 F4

UN: R\$ 2,32 AV: R\$ 58,04 15: R\$ 59,25
30: R\$ 60,43 45: R\$ 61,64 60: R\$ 62,87



PLASTICO ENCAPAR 25MX45CM TRANSP 04

Código: 45604 Fábrica: DAC Unidade: RL/25 F1 F4

UN: R\$ 1,64 AV: R\$ 41,08 15: R\$ 41,93
30: R\$ 42,77 45: R\$ 43,63 60: R\$ 44,50



PLASTICO ENCAPAR 25MX45CM VERMELHO

Código: 3966 Fábrica: FA Unidade: RL/25 F1 F4

UN: R\$ 1,64 AV: R\$ 41,08 15: R\$ 41,93
30: R\$ 42,77 45: R\$ 43,63 60: R\$ 44,50

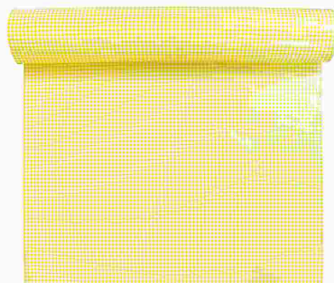

PLASTICO ENCAPAR 25MX45CM XADREZ AMARE

Código: 3965 Fábrica: FA Unidade: RL/25 F1 F4

UN: R\$ 1,64 AV: R\$ 41,08 15: R\$ 41,93
30: R\$ 42,77 45: R\$ 43,63 60: R\$ 44,50

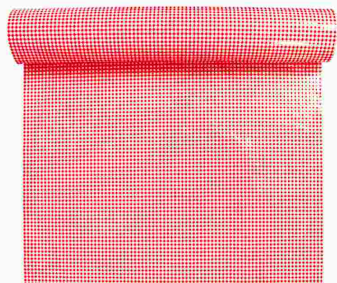

PLASTICO ENCAPAR 25MX45CM XADREZ VERME

Código: 42851 Fábrica: FA Unidade: RL/25 F1 F4

UN: R\$ 63,05 AV: R\$ 63,05 15: R\$ 64,36
30: R\$ 65,65 45: R\$ 66,96 60: R\$ 68,30



PLASTICO ENCAPAR 35X50CM PICOT AMAR 75X1

Código: 7229 Fábrica: NEW MAGIC Unidade: RL/1 F1 F4

UN: R\$ 63,05 AV: R\$ 63,05 15: R\$ 64,36
30: R\$ 65,65 45: R\$ 66,96 60: R\$ 68,30



PLASTICO ENCAPAR 35X50CM PICOT VERD 75X1

Código: 7231 Fábrica: APLICOLA Unidade: RL/1 F1 F4

UN: R\$ 63,05 AV: R\$ 63,05 15: R\$ 64,36
30: R\$ 65,65 45: R\$ 66,96 60: R\$ 68,30



PLASTICO ENCAPAR 35X50CM PICOT VERM 75X1

Código: 7230 Fábrica: APLICOLA Unidade: RL/1 F1 F4

UN: R\$ 63,05 AV: R\$ 63,05 15: R\$ 64,36
30: R\$ 65,65 45: R\$ 66,96 60: R\$ 68,30



PLASTICO ENCAPAR 35X50CMPICOT INCOL 75X1

Código: 7233 Fábrica: APLICOLA Unidade: RL/1 F1 F4

UN: R\$ 0,82 AV: R\$ 41,08 15: R\$ 41,93
30: R\$ 42,77 45: R\$ 43,63 60: R\$ 44,50



PLASTICO ENCAPAR 50MX35CM LISO AMARELO

Código: 47445 Fábrica: PLASVIPEL Unidade: RL/50 F1 F4

UN: R\$ 0,82 AV: R\$ 41,08 15: R\$ 41,93
30: R\$ 42,77 45: R\$ 43,63 60: R\$ 44,50



PLASTICO ENCAPAR 50MX35CM LISO VERMELHO

Código: 47447 Fábrica: PLASVIPEL Unidade: RL/50 F1 F4

UN: R\$ 0,82 AV: R\$ 41,08 15: R\$ 41,93
30: R\$ 42,77 45: R\$ 43,63 60: R\$ 44,50



PLASTICO ENCAPAR 50MX35CM PICOT INF
Código: Fábrica: Unidade:
48000 PLASVIPEL RL/50
F1 F4

UN: R\$ 1,03 AV: R\$ 51,35 15: R\$ 52,42
30: R\$ 53,47 45: R\$ 54,54 60: R\$ 55,63

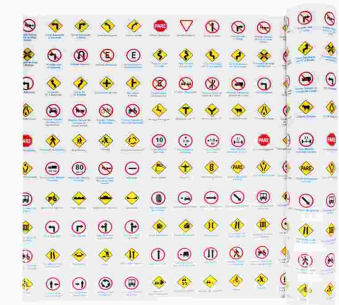

PLASTICO ENCAPAR 50MX45CM EST TRANSITO
Código: Fábrica: Unidade:
47999 FA RL/50
F1 F4

UN: R\$ 1,03 AV: R\$ 51,35 15: R\$ 52,42
30: R\$ 53,47 45: R\$ 54,54 60: R\$ 55,63



PLASTICO ENCAPAR 50MX45CM ESTAMP ABC
Código: Fábrica: Unidade:
42849 FA RL/50
F1 F4

UN: R\$ 1,03 AV: R\$ 51,35 15: R\$ 52,42
30: R\$ 53,47 45: R\$ 54,54 60: R\$ 55,63



PLASTICO ENCAPAR 50MX45CM ESTAMP NUM/LET
Código: Fábrica: Unidade:
45626 FA RL/50
F1 F4

UN: R\$ 2,05 AV: R\$ 51,35 15: R\$ 52,42
30: R\$ 53,47 45: R\$ 54,54 60: R\$ 55,63



PLASTICO ENCAPAR 50MX45CM INF MASCULIN
Código: Fábrica: Unidade:
42838 FA RL/25
F1 F4

UN: R\$ 1,03 AV: R\$ 51,35 15: R\$ 52,42
30: R\$ 53,47 45: R\$ 54,54 60: R\$ 55,63



PLASTICO ENCAPAR 50MX45CM TRANSP DEC
Código: Fábrica: Unidade:
42846 FA RL/50
F1 F4

UN: R\$ 1,03 AV: R\$ 51,35 15: R\$ 52,42
30: R\$ 53,47 45: R\$ 54,54 60: R\$ 55,63



PLASTICO ENCAPAR 50MX45CM XADREZ AMARE
Código: Fábrica: Unidade:
42850 DAC RL/50
F1 F4

UN: R\$ 0,18 AV: R\$ 178,72 15: R\$ 182,45
30: R\$ 186,09 45: R\$ 189,82 60: R\$ 193,61

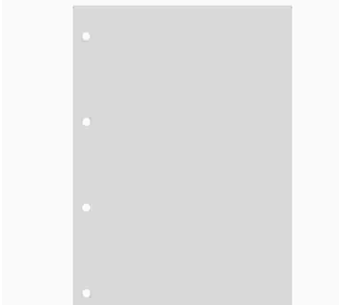

PLASTICO PASTA CATALOG OF 0,06 4F 1000X1
Código: Fábrica: Unidade:
42414 ACP MI/1000
F1 F4

UN: R\$ 0,20 AV: R\$ 19,51 15: R\$ 19,91
30: R\$ 20,31 45: R\$ 20,72 60: R\$ 21,13



PLASTICO PASTA CATALAGO A4 FINO 4F 100X1
Código: Fábrica: Unidade:
13177 MAXIPLASTICO CE/100
F1 F4

UN: R\$ 0,21 AV: R\$ 20,53 15: R\$ 20,96
30: R\$ 21,38 45: R\$ 21,81 60: R\$ 22,24



PLASTICO PASTA CATALAGO OF 0,06 4F 100X1
Código: Fábrica: Unidade:
3603 ACP CE/100
F1 F4

UN: R\$ 0,36 AV: R\$ 178,72 15: R\$ 182,45
30: R\$ 186,09 45: R\$ 189,82 60: R\$ 193,61

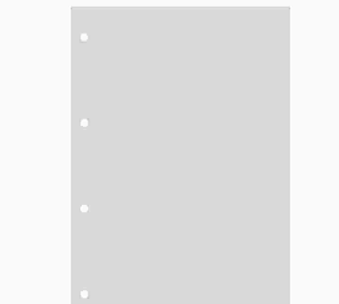

PLASTICO PASTA CATALAGO OF 0,12 4F 500X1
Código: Fábrica: Unidade:
42417 ACP CX/500
F1 F4

UN: R\$ 0,45 AV: R\$ 178,72 15: R\$ 182,45
30: R\$ 186,09 45: R\$ 189,82 60: R\$ 193,61

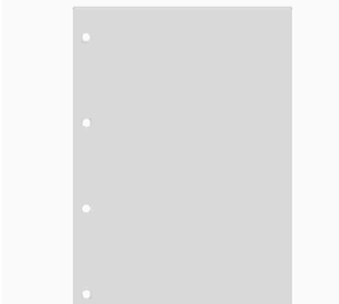

PLASTICO PASTA CATALAGO OF 0,15 4F 400X1
Código: Fábrica: Unidade:
42416 ACP CX/400
F1 F4

UN: R\$ 2,36 AV: R\$ 236,25 15: R\$ 241,17
30: R\$ 245,99 45: R\$ 250,91 60: R\$ 255,93

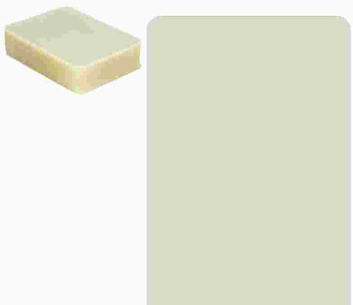

PLASTICO POLASEAL A3 303X426MM 05 100X1
Código: Fábrica: Unidade:
37809 PIC10 CE/100
F1 F4

UN: R\$ 0,92 AV: R\$ 92,44 15: R\$ 94,36
30: R\$ 96,25 45: R\$ 98,18 60: R\$ 100,14



PLASTICO POLASEAL A4 220X307MM 05 100X1
Código: Fábrica: Unidade:
45267 MASTERPRINT CE/100
F1 F4

UN: R\$ 0,13 AV: R\$ 13,34 15: R\$ 13,62
30: R\$ 13,89 45: R\$ 14,17 60: R\$ 14,46





PLASTICO POLASEAL CPF/TI 5 66X99MM 100X1
Código: Fábrica: Unidade:
27095 MASTER/PLAST CE/100
F1 F4

UN: R\$ 0,10 AV: R\$ 10,26 15: R\$ 10,48
30: R\$ 10,69 45: R\$ 10,90 60: R\$ 11,12



PLASTICO POLASEAL CRACH 05 59X86MM 100X1
Código: Fábrica: Unidade:
45124 MASTERPRINT CE/100
F1 F4

<p>UN: R\$ 0,16 AV: R\$ 16,02 15: R\$ 16,36 30: R\$ 16,69 45: R\$ 17,02 60: R\$ 17,36</p>  <p>PLASTICO POLASEAL CRACH 5 73X106MM 100X1 Código: Fábrica: Unidade: 27169 LIDER CE/100 F1 F4</p>	<p>UN: R\$ 1,64 AV: R\$ 164,34 15: R\$ 167,77 30: R\$ 171,12 45: R\$ 174,54 60: R\$ 178,03</p>  <p>PLASTICO POLASEAL OFI 222X336MM 05 100X1 Código: Fábrica: Unidade: 20787 PLASTIFIX CE/100 F1 F4</p>	<p>UN: R\$ 1,23 AV: R\$ 123,16 15: R\$ 125,73 30: R\$ 128,24 45: R\$ 130,81 60: R\$ 133,42</p>  <p>PLASTICO POLASEAL OFI 226X340MM 05 100X1 Código: Fábrica: Unidade: 47214 MASTERPRINT CE/100 F1 F4</p>	<p>UN: R\$ 0,17 AV: R\$ 17,45 15: R\$ 17,82 30: R\$ 18,17 45: R\$ 18,54 60: R\$ 18,91</p>  <p>PLASTICO POLASEAL RG 79X108MM 05 100X1 Código: Fábrica: Unidade: 22613 MASTERPRINT CE/100 F1 F4</p>
<p>UN: R\$ 0,17 AV: R\$ 17,45 15: R\$ 17,82 30: R\$ 18,17 45: R\$ 18,54 60: R\$ 18,91</p>  <p>PLASTICO POLASEAL RG 80X110MM 05 100X1 Código: Fábrica: Unidade: 20785 MASTERPRINT CE/100 F1 F4</p>	<p>UN: R\$ 0,62 AV: R\$ 61,62 15: R\$ 62,91 30: R\$ 64,16 45: R\$ 65,45 60: R\$ 66,76</p>  <p>PLASTICO POLASEAL 1/2 OFI 170X226MM 100X1 Código: Fábrica: Unidade: 28213 MASTERPRINT CE/100 F1 F4</p>	<p>UN: R\$ 698,49 AV: R\$ 698,49 15: R\$ 713,04 30: R\$ 727,30 45: R\$ 741,84 60: R\$ 756,68</p>  <p>PLASTICO PP CRISTAL 0,10X1380MMX50MTS Código: Fábrica: Unidade: 42030 PLAST CO RL/1 F1 F4</p>	<p>UN: R\$ 1438,07 AV: R\$ 1438,07 15: R\$ 1468,03 30: R\$ 1497,39 45: R\$ 1527,34 60: R\$ 1557,88</p>  <p>PLASTICO PP CRISTAL 0,20X1380MMX50MTS Código: Fábrica: Unidade: 42032 PLAST CO RL/1 F1 F4</p>
<p>UN: R\$ 0,46 AV: R\$ 46,33 15: R\$ 47,29 30: R\$ 48,24 45: R\$ 49,20 60: R\$ 50,19</p>  <p>PLASTICO PROT IDENTIDADE 10X7,4CM 100X1 Código: Fábrica: Unidade: 26708 PLADL CE/100 F1 F4</p>	<p>UN: R\$ 23,21 AV: R\$ 23,21 15: R\$ 23,69 30: R\$ 24,17 45: R\$ 24,65 60: R\$ 25,14</p>  <p>PORTA CANETAS TRIPLO CRISTAL 240X70X80MM Código: Fábrica: Unidade: 42739 DELLO UN/1 F1 F4</p>	<p>UN: R\$ 23,21 AV: R\$ 23,21 15: R\$ 23,69 30: R\$ 24,17 45: R\$ 24,65 60: R\$ 25,14</p>  <p>PORTA CANETAS TRIPLO FUME 240X70X80MM Código: Fábrica: Unidade: 42740 DELLO UN/1 F1 F4</p>	<p>UN: R\$ 22,70 AV: R\$ 22,70 15: R\$ 23,17 30: R\$ 23,63 45: R\$ 24,11 60: R\$ 24,59</p>  <p>PORTA CARIMBOS ACRIL CRISTAL 6 LUG 3060 Código: Fábrica: Unidade: 46005 ACRINIL UN/1 F1 F4</p>
<p>UN: R\$ 22,70 AV: R\$ 22,70 15: R\$ 23,17 30: R\$ 23,63 45: R\$ 24,11 60: R\$ 24,59</p>  <p>PORTA CARIMBOS ACRIL FUME 6 LUG 3061 Código: Fábrica: Unidade: 46006 ACRINIL UN/1 F1 F4</p>	<p>UN: R\$ 49,91 AV: R\$ 49,91 15: R\$ 50,95 30: R\$ 51,97 45: R\$ 53,01 60: R\$ 54,07</p>  <p>PORTA CARIMBOS GIRATORIO 8LUGA METAL 165 Código: Fábrica: Unidade: 43748 CARBRINK UN/1 F1 F4</p>	<p>UN: R\$ 7,70 AV: R\$ 7,70 15: R\$ 7,86 30: R\$ 8,02 45: R\$ 8,18 60: R\$ 8,35</p>  <p>PORTA CARTOES TELEFONICO 10 PLASTICOS Código: Fábrica: Unidade: 7052 DAC. UN/1 F1 F4</p>	<p>UN: R\$ 5,79 AV: R\$ 5,79 15: R\$ 5,91 30: R\$ 6,03 45: R\$ 6,15 60: R\$ 6,28</p>  <p>PORTA CLIPS ACR FUME MAGNET 42X62MM 7123 Código: Fábrica: Unidade: 42811 YIN'S PAPER UN/1 F1 F4</p>

UN: R\$ 8,21 AV: R\$ 8,21 15: R\$ 8,38
30: R\$ 8,55 45: R\$ 8,72 60: R\$ 8,89



PORTA CLIPS 42MMX62MM 2041
Código: Fábrika: Unidade:
42064 MASTERPRINT UN/1
F1 F4

UN: R\$ 0,79 AV: R\$ 0,79 15: R\$ 0,81
30: R\$ 0,82 45: R\$ 0,84 60: R\$ 0,86

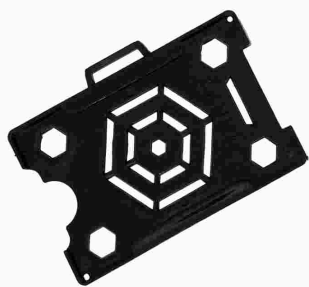

PORTA CRACHA PLAST PRETO UN
Código: Fábrika: Unidade:
44274 ITALY'S UN/1
F1 F4

UN: R\$ 0,79 AV: R\$ 0,79 15: R\$ 0,81
30: R\$ 0,82 45: R\$ 0,84 60: R\$ 0,86

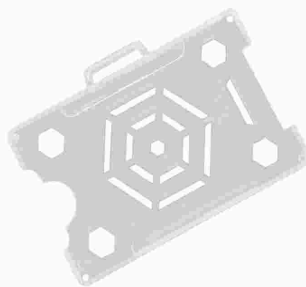

PORTA CRACHA PLAST TRANSPARENTE UN
Código: Fábrika: Unidade:
44273 ITALY'S UN/1
F1 F4

UN: R\$ 20,53 AV: R\$ 20,53 15: R\$ 20,96
30: R\$ 21,38 45: R\$ 21,81 60: R\$ 22,24



PORTA LAPIS ACRIL DUPLO CRISTAL 939.3
Código: Fábrika: Unidade:
40883 ACRIMET UN/1
F1 F4

UN: R\$ 51,35 AV: R\$ 51,35 15: R\$ 52,42
30: R\$ 53,47 45: R\$ 54,54 60: R\$ 55,63



PORTA LAPIS CARROS 00952
Código: Fábrika: Unidade:
48589 WIN PAPER UN/1
F1 F4

UN: R\$ 10,26 AV: R\$ 10,26 15: R\$ 10,48
30: R\$ 10,69 45: R\$ 10,90 60: R\$ 11,12

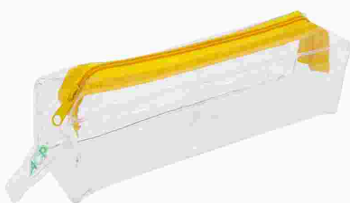

PORTA LAPIS CRISTAL JOY 22CM AMARE 21974
Código: Fábrika: Unidade:
46116 ACP UN/1
F1 F4

UN: R\$ 10,26 AV: R\$ 10,26 15: R\$ 10,48
30: R\$ 10,69 45: R\$ 10,90 60: R\$ 11,12



PORTA LAPIS CRISTAL JOY 22CM LARA 21974
Código: Fábrika: Unidade:
46118 ACP UN/1
F1 F4

UN: R\$ 10,26 AV: R\$ 10,26 15: R\$ 10,48
30: R\$ 10,69 45: R\$ 10,90 60: R\$ 11,12

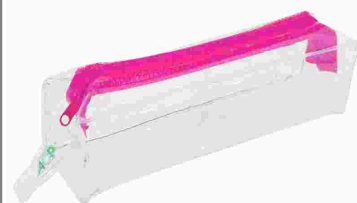

PORTA LAPIS CRISTAL JOY 22CM PINK 21974
Código: Fábrika: Unidade:
46117 ACP UN/1
F1 F4

UN: R\$ 25,67 AV: R\$ 25,67 15: R\$ 26,20
30: R\$ 26,73 45: R\$ 27,26 60: R\$ 27,81



PORTA LAPIS GAME 00948
Código: Fábrika: Unidade:
48587 WIN PAPER UN/1
F1 F4

UN: R\$ 16,99 AV: R\$ 16,99 15: R\$ 16,99
30: R\$ 16,99 45: R\$ 16,99 60: R\$ 16,99



PORTA LAPIS INF BRANCA DE NEVE ES4629
Código: Fábrika: Unidade:
49027 PONTO VERDE UN/1
F1 F4

UN: R\$ 21,56 AV: R\$ 21,56 15: R\$ 22,01
30: R\$ 22,45 45: R\$ 22,90 60: R\$ 23,36



PORTA LAPIS INF FEM BEE FRIENDS ES4805
Código: Fábrika: Unidade:
49073 PONTO VERDE UN/1
F1 F4

UN: R\$ 17,86 AV: R\$ 17,86 15: R\$ 18,24
30: R\$ 18,60 45: R\$ 18,97 60: R\$ 19,35



PORTA LAPIS INF FEM CANDY GIRL ES4609
Código: Fábrika: Unidade:
49198 PONTO VERDE UN/1
F1 F4

UN: R\$ 38,00 AV: R\$ 38,00 15: R\$ 38,79
30: R\$ 39,56 45: R\$ 40,35 60: R\$ 41,16



PORTA LAPIS INF FEM FAMILY SHARK 4193
Código: Fábrika: Unidade:
44051 PONTO VERDE UN/1
F1 F4

UN: R\$ 21,56 AV: R\$ 21,56 15: R\$ 22,01
30: R\$ 22,45 45: R\$ 22,90 60: R\$ 23,36



PORTA LAPIS INF FEM RAINBOW ES4962
Código: Fábrika: Unidade:
49075 PONTO VERDE UN/1
F1 F4

UN: R\$ 21,56 AV: R\$ 21,56 15: R\$ 22,01
30: R\$ 22,45 45: R\$ 22,90 60: R\$ 23,36



PORTA LAPIS INF FEM SEREIA ES4811
Código: Fábrika: Unidade:
49076 PONTO VERDE UN/1
F1 F4

UN: R\$ 21,56 AV: R\$ 21,56 15: R\$ 22,01
30: R\$ 22,45 45: R\$ 22,90 60: R\$ 23,36



PORTA LAPIS INF FEM 3 PRINCESAS ES4827
Código: Fábrika: Unidade:
49071 PONTO VERDE UN/1
F1 F4

UN: R\$ 21,56 AV: R\$ 21,56 15: R\$ 22,01
30: R\$ 22,45 45: R\$ 22,90 60: R\$ 23,36



PORTA LAPIS INF KIDS PLAY ES4821

Código: Fábrica: Unidade:
49074 PONTO VERDE UN/1
F1 F4

UN: R\$ 21,56 AV: R\$ 21,56 15: R\$ 22,01
30: R\$ 22,45 45: R\$ 22,90 60: R\$ 23,36



PORTA LAPIS INF LINHA SETINADO ES4875

Código: Fábrica: Unidade:
49029 PONTO VERDE UN/1
F1 F4

UN: R\$ 21,56 AV: R\$ 21,56 15: R\$ 22,01
30: R\$ 22,45 45: R\$ 22,90 60: R\$ 23,36



PORTA LAPIS INF MASC BATTLE ES4849

Código: Fábrica: Unidade:
49072 PONTO VERDE UN/1
F1 F4

UN: R\$ 25,67 AV: R\$ 25,67 15: R\$ 26,20
30: R\$ 26,73 45: R\$ 27,26 60: R\$ 27,81



PORTA LAPIS INF MASC BLOCK GAME ES4853

Código: Fábrica: Unidade:
49026 PONTO VERDE UN/1
F1 F4

UN: R\$ 34,91 AV: R\$ 34,91 15: R\$ 35,64
30: R\$ 36,35 45: R\$ 37,08 60: R\$ 37,82



PORTA LAPIS INF MASC BLOCK GAME 4188

Código: Fábrica: Unidade:
44052 PONTO VERDE UN/1
F1 F4

UN: R\$ 29,78 AV: R\$ 29,78 15: R\$ 30,40
30: R\$ 31,01 45: R\$ 31,63 60: R\$ 32,26



PORTA LAPIS INF MASC GUARDIAN NIGHT 4179

Código: Fábrica: Unidade:
44406 PONTO VERDE UN/1
F1 F4

UN: R\$ 25,67 AV: R\$ 25,67 15: R\$ 26,20
30: R\$ 26,73 45: R\$ 27,26 60: R\$ 27,81



PORTA LAPIS INF MASC KARKS KIDS ES4669

Código: Fábrica: Unidade:
48987 PONTO VERDE UN/1
F1 F4

UN: R\$ 16,99 AV: R\$ 16,99 15: R\$ 16,99
30: R\$ 16,99 45: R\$ 16,99 60: R\$ 16,99



PORTA LAPIS INF MASC SPEED WEB ES4649

Código: Fábrica: Unidade:
48988 PONTO VERDE UN/1
F1 F4

UN: R\$ 32,86 AV: R\$ 32,86 15: R\$ 33,54
30: R\$ 34,22 45: R\$ 34,90 60: R\$ 35,60



PORTA LAPIS INF PRINCESS EVA 3D ES5041

Código: Fábrica: Unidade:
49028 PONTO VERDE UN/1
F1 F4

UN: R\$ 22,59 AV: R\$ 22,59 15: R\$ 23,06
30: R\$ 23,52 45: R\$ 23,99 60: R\$ 24,47



PORTA LAPIS INF SEREIA ES4619

Código: Fábrica: Unidade:
49030 PONTO VERDE UN/1
F1 F4

UN: R\$ 31,83 AV: R\$ 31,83 15: R\$ 32,50
30: R\$ 33,15 45: R\$ 33,81 60: R\$ 34,49



PORTA LAPIS JUVENIL FEM ES4289

Código: Fábrica: Unidade:
48955 PONTO VERDE UN/1
F1 F4

UN: R\$ 28,61 AV: R\$ 28,61 15: R\$ 29,20
30: R\$ 29,79 45: R\$ 30,38 60: R\$ 30,99



PORTA LAPIS JUVENIL FEM MH 4321

Código: Fábrica: Unidade:
44027 PONTO VERDE UN/1
F1 F4

UN: R\$ 34,91 AV: R\$ 34,91 15: R\$ 35,64
30: R\$ 36,35 45: R\$ 37,08 60: R\$ 37,82



PORTA LAPIS JUVENIL FEM TOP MODEL TM28ES

Código: Fábrica: Unidade:
48958 PONTO VERDE UN/1
F1 F4

UN: R\$ 35,94 AV: R\$ 35,94 15: R\$ 36,69
30: R\$ 37,42 45: R\$ 38,17 60: R\$ 38,94



PORTA LAPIS JUVENIL FEM VKG ES4299

Código: Fábrica: Unidade:
49180 PONTO VERDE UN/1
F1 F4

UN: R\$ 32,86 AV: R\$ 32,86 15: R\$ 33,54
30: R\$ 34,22 45: R\$ 34,90 60: R\$ 35,60



PORTA LAPIS JUVENIL FEM VKG 4261ES

Código: Fábrica: Unidade:
48959 PONTO VERDE UN/1
F1 F4

UN: R\$ 34,91 AV: R\$ 34,91 15: R\$ 35,64
30: R\$ 36,35 45: R\$ 37,08 60: R\$ 37,82



PORTA LAPIS JUVENIL FEM VKG 4262ES

Código: Fábrica: Unidade:
48957 PONTO VERDE UN/1
F1 F4

UN: R\$ 50,32 AV: R\$ 50,32 15: R\$ 51,37
30: R\$ 52,40 45: R\$ 53,45 60: R\$ 54,52



PORTA LAPIS JUVENIL FEM VKG 4310

Código: Fábrica: Unidade:
44399 PONTO VERDE UN/1
F1 F4

UN: R\$ 25,67 AV: R\$ 25,67 15: R\$ 26,20
30: R\$ 26,73 45: R\$ 27,26 60: R\$ 27,81



PORTA LAPIS JUVENIL SUPER HOT SBC ES3440

Código: Fábrica: Unidade:
34221 SBC UN/1
F1 F4

UN: R\$ 26,70 AV: R\$ 26,70 15: R\$ 27,25
30: R\$ 27,80 45: R\$ 28,35 60: R\$ 28,92



PORTA LAPIS JUVENIL WOOKEY ES3467

Código: Fábrica: Unidade:
34233 SBC UN/1
F1 F4

UN: R\$ 25,67 AV: R\$ 25,67 15: R\$ 26,20
30: R\$ 26,73 45: R\$ 27,26 60: R\$ 27,81



PORTA LAPIS JUVENIL WOOKEY ES3696

Código: Fábrica: Unidade:
34224 SBC UN/1
F1 F4

UN: R\$ 11,08 AV: R\$ 11,08 15: R\$ 11,31
30: R\$ 11,54 45: R\$ 11,77 60: R\$ 12,01

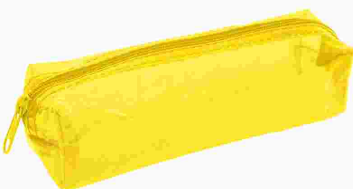

PORTA LAPIS LIGHTS TEEN 22CM AMARE 21966

Código: Fábrica: Unidade:
46112 ACP UN/1
F1 F4

UN: R\$ 11,08 AV: R\$ 11,08 15: R\$ 11,31
30: R\$ 11,54 45: R\$ 11,77 60: R\$ 12,01

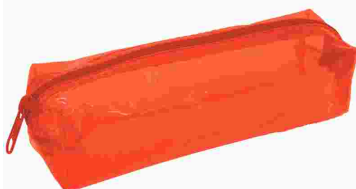

PORTA LAPIS LIGHTS TEEN 22CM LARAN 21966

Código: Fábrica: Unidade:
46113 ACP UN/1
F1 F4

UN: R\$ 11,08 AV: R\$ 11,08 15: R\$ 11,31
30: R\$ 11,54 45: R\$ 11,77 60: R\$ 12,01

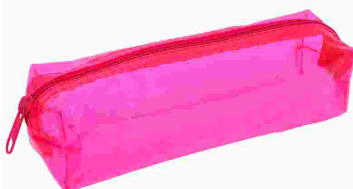

PORTA LAPIS LIGHTS TEEN 22CM PINK 21966

Código: Fábrica: Unidade:
46115 ACP UN/1
F1 F4

UN: R\$ 11,08 AV: R\$ 11,08 15: R\$ 11,31
30: R\$ 11,54 45: R\$ 11,77 60: R\$ 12,01



PORTA LAPIS LIGHTS TEEN 22CM VERDE 21966

Código: Fábrica: Unidade:
46114 ACP UN/1
F1 F4

UN: R\$ 15,40 AV: R\$ 15,40 15: R\$ 15,72
30: R\$ 16,03 45: R\$ 16,35 60: R\$ 16,68



PORTA LAPIS LONA C/VIVO GDE AZUL BCO

Código: Fábrica: Unidade:
30523 JC UN/1
F1 F4

UN: R\$ 15,40 AV: R\$ 15,40 15: R\$ 15,72
30: R\$ 16,03 45: R\$ 16,35 60: R\$ 16,68



PORTA LAPIS LONA C/VIVO GDE PTO BCO

Código: Fábrica: Unidade:
30522 JC UN/1
F1 F4

UN: R\$ 26,70 AV: R\$ 26,70 15: R\$ 27,25
30: R\$ 27,80 45: R\$ 28,35 60: R\$ 28,92



PORTA LAPIS LONA ESTAMP 1 DIV 146

Código: Fábrica: Unidade:
46700 AC BAG UN/1
F1 F4

UN: R\$ 38,00 AV: R\$ 38,00 15: R\$ 38,79
30: R\$ 39,56 45: R\$ 40,35 60: R\$ 41,16



PORTA LAPIS LONA ESTAMP 2 DIV 147

Código: Fábrica: Unidade:
46701 AC BAG UN/1
F1 F4

UN: R\$ 7,18 AV: R\$ 7,18 15: R\$ 7,33
30: R\$ 7,48 45: R\$ 7,63 60: R\$ 7,78



PORTA LAPIS LONA LISO 1 DIV 149/132

Código: Fábrica: Unidade:
46702 AC BAG UN/1
F1 F4

UN: R\$ 25,67 AV: R\$ 25,67 15: R\$ 26,20
30: R\$ 26,73 45: R\$ 27,26 60: R\$ 27,81



PORTA LAPIS LONA PRETO 125004

Código: Fábrica: Unidade:
37792 BAD BOY UN/1
F1 F4

UN: R\$ 30,81 AV: R\$ 30,81 15: R\$ 31,45
30: R\$ 32,08 45: R\$ 32,72 60: R\$ 33,37



PORTA LAPIS LONA PRETO 125204

Código: Fábrica: Unidade:
37791 BAD BOY UN/1
F1 F4

UN: R\$ 28,75 AV: R\$ 28,75 15: R\$ 29,35
30: R\$ 29,94 45: R\$ 30,54 60: R\$ 31,15



PORTA LAPIS LONA PRETO 125304

Código: Fábrica: Unidade:
37790 BAD BOY UN/1
F1 F4

UN: R\$ 28,75 AV: R\$ 28,75 15: R\$ 29,35
30: R\$ 29,94 45: R\$ 30,54 60: R\$ 31,15



PORTA LAPIS LONA PRETO 125504

Código: 37793 Fábrica: BAD BOY Unidade: UN/1 F1 F4

UN: R\$ 8,47 AV: R\$ 8,47 15: R\$ 8,65
30: R\$ 8,82 45: R\$ 9,00 60: R\$ 9,18



PORTA LAPIS LONA 1 DIV CAMUFLADO

Código: 21403 Fábrica: KADU Unidade: UN/1 F1 F4

UN: R\$ 8,47 AV: R\$ 8,47 15: R\$ 8,65
30: R\$ 8,82 45: R\$ 9,00 60: R\$ 9,18



PORTA LAPIS LONA 1 DIV CORES

Código: 30514 Fábrica: KADU Unidade: UN/1 F1 F4

UN: R\$ 15,40 AV: R\$ 15,40 15: R\$ 15,72
30: R\$ 16,03 45: R\$ 16,35 60: R\$ 16,68



PORTA LAPIS LONA 2 DIV ATLETICO

Código: 28051 Fábrica: KADU Unidade: UN/1 F1 F4

UN: R\$ 15,40 AV: R\$ 15,40 15: R\$ 15,72
30: R\$ 16,03 45: R\$ 16,35 60: R\$ 16,68



PORTA LAPIS LONA 2 DIV BARBIE

Código: 23373 Fábrica: KADU Unidade: UN/1 F1 F4

UN: R\$ 15,40 AV: R\$ 15,40 15: R\$ 15,72
30: R\$ 16,03 45: R\$ 16,35 60: R\$ 16,68



PORTA LAPIS LONA 2 DIV BAT MAN

Código: 21523 Fábrica: KADU Unidade: UN/1 F1 F4

UN: R\$ 15,40 AV: R\$ 15,40 15: R\$ 15,72
30: R\$ 16,03 45: R\$ 16,35 60: R\$ 16,68



PORTA LAPIS LONA 2 DIV BEN 10

Código: 23369 Fábrica: KADU Unidade: UN/1 F1 F4

UN: R\$ 15,40 AV: R\$ 15,40 15: R\$ 15,72
30: R\$ 16,03 45: R\$ 16,35 60: R\$ 16,68



PORTA LAPIS LONA 2 DIV CARROS

Código: 26644 Fábrica: KADU Unidade: UN/1 F1 F4

UN: R\$ 15,40 AV: R\$ 15,40 15: R\$ 15,72
30: R\$ 16,03 45: R\$ 16,35 60: R\$ 16,68



PORTA LAPIS LONA 2 DIV CRUZEIRO

Código: 29819 Fábrica: KADU Unidade: UN/1 F1 F4

UN: R\$ 15,40 AV: R\$ 15,40 15: R\$ 15,72
30: R\$ 16,03 45: R\$ 16,35 60: R\$ 16,68



PORTA LAPIS LONA 2 DIV FEM LILO & STITCH

Código: 49262 Fábrica: KADU Unidade: UN/1 F1 F4

UN: R\$ 15,40 AV: R\$ 15,40 15: R\$ 15,72
30: R\$ 16,03 45: R\$ 16,35 60: R\$ 16,68



PORTA LAPIS LONA 2 DIV FEM PATRULH CANIN

Código: 49257 Fábrica: KADU Unidade: UN/1 F1 F4

UN: R\$ 15,40 AV: R\$ 15,40 15: R\$ 15,72
30: R\$ 16,03 45: R\$ 16,35 60: R\$ 16,68



PORTA LAPIS LONA 2 DIV FEM UNICORNIO

Código: 49260 Fábrica: KADU Unidade: UN/1 F1 F4

UN: R\$ 15,40 AV: R\$ 15,40 15: R\$ 15,72
30: R\$ 16,03 45: R\$ 16,35 60: R\$ 16,68



PORTA LAPIS LONA 2 DIV FLAMENGO

Código: 46927 Fábrica: KADU Unidade: UN/1 F1 F4

UN: R\$ 15,40 AV: R\$ 15,40 15: R\$ 15,72
30: R\$ 16,03 45: R\$ 16,35 60: R\$ 16,68



PORTA LAPIS LONA 2 DIV FROZEN

Código: 49258 Fábrica: KADU Unidade: UN/1 F1 F4

UN: R\$ 15,40 AV: R\$ 15,40 15: R\$ 15,72
30: R\$ 16,03 45: R\$ 16,35 60: R\$ 16,68



PORTA LAPIS LONA 2 DIV HOMEM ARANHA

Código: 23370 Fábrica: KADU Unidade: UN/1 F1 F4

UN: R\$ 15,40 AV: R\$ 15,40 15: R\$ 15,72
30: R\$ 16,03 45: R\$ 16,35 60: R\$ 16,68



PORTA LAPIS LONA 2 DIV HOT WHEELS

Código: 23371 Fábrica: KADU Unidade: UN/1 F1 F4

UN: R\$ 15,40 AV: R\$ 15,40 15: R\$ 15,72
30: R\$ 16,03 45: R\$ 16,35 60: R\$ 16,68



PORTA LAPIS LONA 2 DIV LIGA DA JUSTICA
Código: Fábrica: Unidade:
21524 KADU UN/1
F1 F4

UN: R\$ 15,40 AV: R\$ 15,40 15: R\$ 15,72
30: R\$ 16,03 45: R\$ 16,35 60: R\$ 16,68



PORTA LAPIS LONA 2 DIV LOL
Código: Fábrica: Unidade:
49259 KADU UN/1
F1 F4

UN: R\$ 15,40 AV: R\$ 15,40 15: R\$ 15,72
30: R\$ 16,03 45: R\$ 16,35 60: R\$ 16,68



PORTA LAPIS LONA 2 DIV MARIE
Código: Fábrica: Unidade:
24749 KADU UN/1
F1 F4

UN: R\$ 15,40 AV: R\$ 15,40 15: R\$ 15,72
30: R\$ 16,03 45: R\$ 16,35 60: R\$ 16,68



PORTA LAPIS LONA 2 DIV MARIO
Código: Fábrica: Unidade:
49248 KADU UN/1
F1 F4

UN: R\$ 15,40 AV: R\$ 15,40 15: R\$ 15,72
30: R\$ 16,03 45: R\$ 16,35 60: R\$ 16,68



PORTA LAPIS LONA 2 DIV MASC COLOR
Código: Fábrica: Unidade:
31801 KADU UN/1
F1 F4

UN: R\$ 15,40 AV: R\$ 15,40 15: R\$ 15,72
30: R\$ 16,03 45: R\$ 16,35 60: R\$ 16,68



PORTA LAPIS LONA 2 DIV MASC DIVERTIDAMEN
Código: Fábrica: Unidade:
49378 KADU UN/1
F1 F4

UN: R\$ 15,40 AV: R\$ 15,40 15: R\$ 15,72
30: R\$ 16,03 45: R\$ 16,35 60: R\$ 16,68



PORTA LAPIS LONA 2 DIV MASC PATRULHA CAN
Código: Fábrica: Unidade:
49252 KADU UN/1
F1 F4

UN: R\$ 15,40 AV: R\$ 15,40 15: R\$ 15,72
30: R\$ 16,03 45: R\$ 16,35 60: R\$ 16,68



PORTA LAPIS LONA 2 DIV MASC STITCH
Código: Fábrica: Unidade:
49251 KADU UN/1
F1 F4

UN: R\$ 15,40 AV: R\$ 15,40 15: R\$ 15,72
30: R\$ 16,03 45: R\$ 16,35 60: R\$ 16,68



PORTA LAPIS LONA 2 DIV MASC YUGIOH
Código: Fábrica: Unidade:
49253 KADU UN/1
F1 F4

UN: R\$ 15,40 AV: R\$ 15,40 15: R\$ 15,72
30: R\$ 16,03 45: R\$ 16,35 60: R\$ 16,68



PORTA LAPIS LONA 2 DIV MINECRAFT
Código: Fábrica: Unidade:
49246 KADU UN/1
F1 F4

UN: R\$ 15,40 AV: R\$ 15,40 15: R\$ 15,72
30: R\$ 16,03 45: R\$ 16,35 60: R\$ 16,68



PORTA LAPIS LONA 2 DIV MINNIE
Código: Fábrica: Unidade:
49256 KADU UN/1
F1 F4

UN: R\$ 15,40 AV: R\$ 15,40 15: R\$ 15,72
30: R\$ 16,03 45: R\$ 16,35 60: R\$ 16,68



PORTA LAPIS LONA 2 DIV MORANGUINHO
Código: Fábrica: Unidade:
23377 KADU UN/1
F1 F4

UN: R\$ 15,40 AV: R\$ 15,40 15: R\$ 15,72
30: R\$ 16,03 45: R\$ 16,35 60: R\$ 16,68



PORTA LAPIS LONA 2 DIV NARUTO
Código: Fábrica: Unidade:
23372 KADU UN/1
F1 F4

UN: R\$ 15,40 AV: R\$ 15,40 15: R\$ 15,72
30: R\$ 16,03 45: R\$ 16,35 60: R\$ 16,68



PORTA LAPIS LONA 2 DIV PEQUENA SEREIA
Código: Fábrica: Unidade:
49254 KADU UN/1
F1 F4

UN: R\$ 15,40 AV: R\$ 15,40 15: R\$ 15,72
30: R\$ 16,03 45: R\$ 16,35 60: R\$ 16,68



PORTA LAPIS LONA 2 DIV PJ MASK
Código: Fábrica: Unidade:
21534 KADU UN/1
F1 F4

UN: R\$ 15,40 AV: R\$ 15,40 15: R\$ 15,72
30: R\$ 16,03 45: R\$ 16,35 60: R\$ 16,68



PORTA LAPIS LONA 2 DIV POKEMON
Código: Fábrica: Unidade:
25549 KADU UN/1
F1 F4

UN: R\$ 15,40 AV: R\$ 15,40 15: R\$ 15,72
30: R\$ 16,03 45: R\$ 16,35 60: R\$ 16,68



PORTA LAPIS LONA 2 DIV PRINCESAS

Código: Fábrica: Unidade:
21525 KADU UN/1
F1 F4

UN: R\$ 15,40 AV: R\$ 15,40 15: R\$ 15,72
30: R\$ 16,03 45: R\$ 16,35 60: R\$ 16,68



PORTA LAPIS LONA 2 DIV PRINCESINHA SOFIA

Código: Fábrica: Unidade:
49261 KADU UN/1
F1 F4

UN: R\$ 15,40 AV: R\$ 15,40 15: R\$ 15,72
30: R\$ 16,03 45: R\$ 16,35 60: R\$ 16,68



PORTA LAPIS LONA 2 DIV SONIC

Código: Fábrica: Unidade:
49249 KADU UN/1
F1 F4

UN: R\$ 15,40 AV: R\$ 15,40 15: R\$ 15,72
30: R\$ 16,03 45: R\$ 16,35 60: R\$ 16,68



PORTA LAPIS LONA 2 DIV SUPER MAN

Código: Fábrica: Unidade:
21668 KADU UN/1
F1 F4

UN: R\$ 15,40 AV: R\$ 15,40 15: R\$ 15,72
30: R\$ 16,03 45: R\$ 16,35 60: R\$ 16,68



PORTA LAPIS LONA 2 DIV VINGADORES

Código: Fábrica: Unidade:
49250 KADU UN/1
F1 F4

UN: R\$ 15,40 AV: R\$ 15,40 15: R\$ 15,72
30: R\$ 16,03 45: R\$ 16,35 60: R\$ 16,68



PORTA LAPIS LONA 2 DIV WANDINHA

Código: Fábrica: Unidade:
49255 KADU UN/1
F1 F4

UN: R\$ 15,40 AV: R\$ 15,40 15: R\$ 15,72
30: R\$ 16,03 45: R\$ 16,35 60: R\$ 16,68



PORTA LAPIS LONA 3 DIV CAMUFLADO

Código: Fábrica: Unidade:
23415 KADU UN/1
F1 F4

UN: R\$ 15,40 AV: R\$ 15,40 15: R\$ 15,72
30: R\$ 16,03 45: R\$ 16,35 60: R\$ 16,68



PORTA LAPIS LONA 3 DIV FEM COLOR

Código: Fábrica: Unidade:
23413 KADU UN/1
F1 F4

UN: R\$ 15,40 AV: R\$ 15,40 15: R\$ 15,72
30: R\$ 16,03 45: R\$ 16,35 60: R\$ 16,68



PORTA LAPIS LONA 3 DIV MASC

Código: Fábrica: Unidade:
31800 KADU UN/1
F1 F4

UN: R\$ 35,44 AV: R\$ 35,44 15: R\$ 36,18
30: R\$ 36,90 45: R\$ 37,64 60: R\$ 38,39



PORTA LAPIS MASC PATCHES 20021

Código: Fábrica: Unidade:
45945 WINTH TEEN UN/1
F1 F4

UN: R\$ 4,20 AV: R\$ 4,20 15: R\$ 4,29
30: R\$ 4,37 45: R\$ 4,46 60: R\$ 4,55



PORTA LAPIS MINI PU 692

Código: Fábrica: Unidade:
44806 WIN PAPER UN/1
F1 F4

UN: R\$ 4,20 AV: R\$ 4,20 15: R\$ 4,29
30: R\$ 4,37 45: R\$ 4,46 60: R\$ 4,55



PORTA LAPIS MINI PU 694

Código: Fábrica: Unidade:
44807 WIN PAPER UN/1
F1 F4

UN: R\$ 25,67 AV: R\$ 25,67 15: R\$ 26,20
30: R\$ 26,73 45: R\$ 27,26 60: R\$ 27,81



PORTA LAPIS NYLON 00953

Código: Fábrica: Unidade:
48585 WIN PAPER UN/1
F1 F4

UN: R\$ 9,23 AV: R\$ 9,23 15: R\$ 9,43
30: R\$ 9,62 45: R\$ 9,81 60: R\$ 10,00

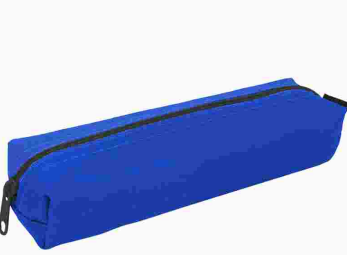

PORTA LAPIS NYLON 22CM AZUL 21975AZ

Código: Fábrica: Unidade:
46119 ACP UN/1
F1 F4

UN: R\$ 9,23 AV: R\$ 9,23 15: R\$ 9,43
30: R\$ 9,62 45: R\$ 9,81 60: R\$ 10,00



PORTA LAPIS NYLON 22CM PRETO 21975PT

Código: Fábrica: Unidade:
46120 ACP UN/1
F1 F4

UN: R\$ 10,46 AV: R\$ 10,46 15: R\$ 10,67
30: R\$ 10,89 45: R\$ 11,11 60: R\$ 11,33

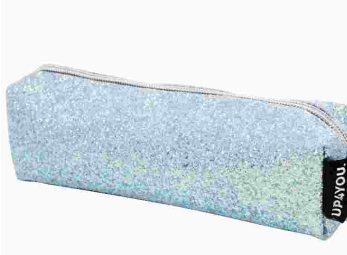

PORTA LAPIS PVC AZUL 55042UP-AZ

Código: Fábrica: Unidade:
47702 LUXCEL UN/1
F1 F4

UN: R\$ 8,21 AV: R\$ 8,21 15: R\$ 8,38
30: R\$ 8,55 45: R\$ 8,72 60: R\$ 8,89



PORTA LAPIS PVC NEON COLOR 27099

Código: Fábrica: Unidade:
43449 CONVOY UN/1
F1 F4

UN: R\$ 10,46 AV: R\$ 10,46 15: R\$ 10,67
30: R\$ 10,89 45: R\$ 11,11 60: R\$ 11,33

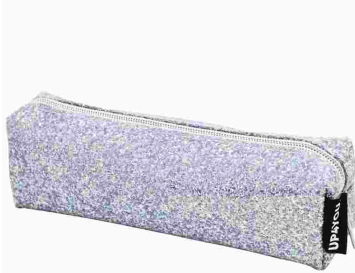

PORTA LAPIS PVC PRATA 55042UP-PR

Código: Fábrica: Unidade:
47704 LUXCEL UN/1
F1 F4

UN: R\$ 10,46 AV: R\$ 10,46 15: R\$ 10,67
30: R\$ 10,89 45: R\$ 11,11 60: R\$ 11,33



PORTA LAPIS PVC ROSA 55042UP-RA

Código: Fábrica: Unidade:
47703 LUXCEL UN/1
F1 F4

UN: R\$ 30,46 AV: R\$ 30,46 15: R\$ 31,09
30: R\$ 31,71 45: R\$ 32,35 60: R\$ 32,99



PORTA LAPIS SILICONE 20CM AZUL 21976AZ

Código: Fábrica: Unidade:
46108 ACP UN/1
F1 F4

UN: R\$ 30,46 AV: R\$ 30,46 15: R\$ 31,09
30: R\$ 31,71 45: R\$ 32,35 60: R\$ 32,99

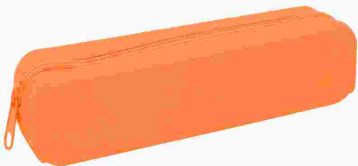

PORTA LAPIS SILICONE 20CM LARANJA 21976L

Código: Fábrica: Unidade:
46111 ACP UN/1
F1 F4

UN: R\$ 30,46 AV: R\$ 30,46 15: R\$ 31,09
30: R\$ 31,71 45: R\$ 32,35 60: R\$ 32,99

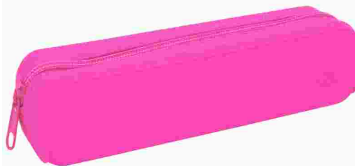

PORTA LAPIS SILICONE 20CM PINK 21976PK

Código: Fábrica: Unidade:
46109 ACP UN/1
F1 F4

UN: R\$ 30,46 AV: R\$ 30,46 15: R\$ 31,09
30: R\$ 31,71 45: R\$ 32,35 60: R\$ 32,99

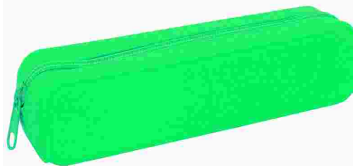

PORTA LAPIS SILICONE 20CM VERDE 21976VD

Código: Fábrica: Unidade:
46110 ACP UN/1
F1 F4

UN: R\$ 25,67 AV: R\$ 25,67 15: R\$ 26,20
30: R\$ 26,73 45: R\$ 27,26 60: R\$ 27,81



PORTA LAPIS SPORT 00955

Código: Fábrica: Unidade:
48584 WIN PAPER UN/1
F1 F4

UN: R\$ 25,67 AV: R\$ 25,67 15: R\$ 26,20
30: R\$ 26,73 45: R\$ 27,26 60: R\$ 27,81



PORTA LAPIS SPORTS 00946

Código: Fábrica: Unidade:
48586 WIN PAPER UN/1
F1 F4

UN: R\$ 11,91 AV: R\$ 11,91 15: R\$ 12,15
30: R\$ 12,40 45: R\$ 12,64 60: R\$ 12,90

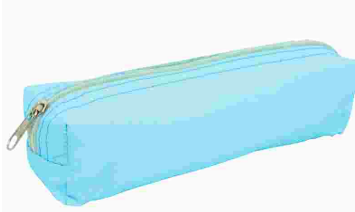

PORTA LAPIS TEEN CAIRO 20CM AZUL 21964

Código: Fábrica: Unidade:
46122 ACP UN/1
F1 F4

UN: R\$ 11,91 AV: R\$ 11,91 15: R\$ 12,15
30: R\$ 12,40 45: R\$ 12,64 60: R\$ 12,90

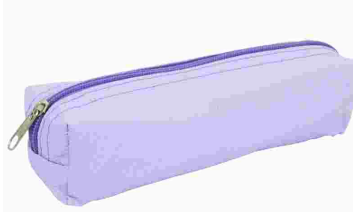

PORTA LAPIS TEEN CAIRO 20CM LILAS 21964

Código: Fábrica: Unidade:
46123 ACP UN/1
F1 F4

UN: R\$ 11,91 AV: R\$ 11,91 15: R\$ 12,15
30: R\$ 12,40 45: R\$ 12,64 60: R\$ 12,90

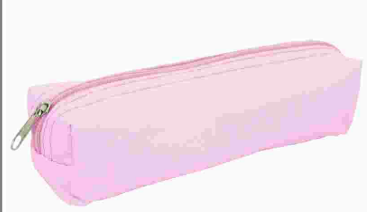

PORTA LAPIS TEEN CAIRO 20CM ROSA 21964

Código: Fábrica: Unidade:
46124 ACP UN/1
F1 F4

UN: R\$ 11,91 AV: R\$ 11,91 15: R\$ 12,15
30: R\$ 12,40 45: R\$ 12,64 60: R\$ 12,90

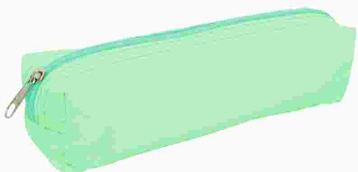

PORTA LAPIS TEEN CAIRO 20CM VERDE 21964

Código: Fábrica: Unidade:
46125 ACP UN/1
F1 F4

UN: R\$ 10,26 AV: R\$ 10,26 15: R\$ 10,48
30: R\$ 10,69 45: R\$ 10,90 60: R\$ 11,12



PORTA LAPIS TEEN SINT AZUL 19949

Código: Fábrica: Unidade:
35695 ACP UN/1
F1 F4

UN: R\$ 10,26 AV: R\$ 10,26 15: R\$ 10,48
30: R\$ 10,69 45: R\$ 10,90 60: R\$ 11,12



PORTA LAPIS TEEN SINT BEGE 19955

Código: Fábrica: Unidade:
35690 ACP UN/1
F1 F4

UN: R\$ 6,15 AV: R\$ 6,15 15: R\$ 6,28
30: R\$ 6,41 45: R\$ 6,53 60: R\$ 6,67

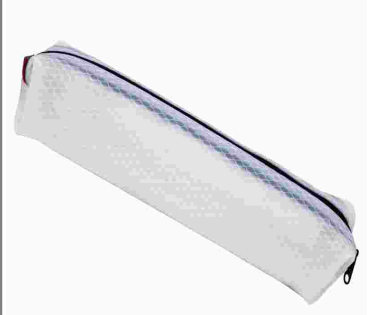

PORTA LAPIS 1Z TELA 552

Código: Fábrica: Unidade:
44804 WINTH UN/1
F1 F4

UN: R\$ 13,34 AV: R\$ 13,34 15: R\$ 13,62
30: R\$ 13,89 45: R\$ 14,17 60: R\$ 14,46



PORTA LAPIS 2 DIV JEANS FEM EST DET COR
Código: Fábriça: Unidade:
34385 LITA UN/1
F1 F4

UN: R\$ 14,37 AV: R\$ 14,37 15: R\$ 14,67
30: R\$ 14,96 45: R\$ 15,26 60: R\$ 15,57



PORTA LAPIS 2 DIV LONA COLOR LISO 801
Código: Fábriça: Unidade:
26984 LITA UN/1
F1 F4

UN: R\$ 13,34 AV: R\$ 13,34 15: R\$ 13,62
30: R\$ 13,89 45: R\$ 14,17 60: R\$ 14,46



PORTA LAPIS 2 DIV LONA C/VIVO
Código: Fábriça: Unidade:
21402 JC UN/1
F1 F4

UN: R\$ 14,37 AV: R\$ 14,37 15: R\$ 14,67
30: R\$ 14,96 45: R\$ 15,26 60: R\$ 15,57



PORTA LAPIS 2 DIV LONA C/VIVO FEM PERS
Código: Fábriça: Unidade:
30515 JC UN/1
F1 F4

UN: R\$ 14,37 AV: R\$ 14,37 15: R\$ 14,67
30: R\$ 14,96 45: R\$ 15,26 60: R\$ 15,57



PORTA LAPIS 2 DIV LONA C/VIVO MASC PERS
Código: Fábriça: Unidade:
30516 JC UN/1
F1 F4

UN: R\$ 10,26 AV: R\$ 10,26 15: R\$ 10,48
30: R\$ 10,69 45: R\$ 10,90 60: R\$ 11,12



PORTA LAPIS 9CM ARAMADO RED PRETO 8244PT
Código: Fábriça: Unidade:
46334 KAZ UN/1
F1 F4

UN: R\$ 8,10 AV: R\$ 8,10 15: R\$ 8,27
30: R\$ 8,44 45: R\$ 8,61 60: R\$ 8,78



PORTA OBJETOS PLAST 10X8CM PRETO 289
Código: Fábriça: Unidade:
50157 CARBRINK UN/1
F1 F4

UN: R\$ 44,11 AV: R\$ 44,11 15: R\$ 45,03
30: R\$ 45,93 45: R\$ 46,85 60: R\$ 47,78



PORTA REVISTAS 25X8,5X30CM CRISTAL 046
Código: Fábriça: Unidade:
44681 MAXCRIL UN/1
F1 F4

UN: R\$ 6,15 AV: R\$ 6,15 15: R\$ 6,28
30: R\$ 6,41 45: R\$ 6,53 60: R\$ 6,67



POST-IT BL ADES 37X50MM 100FLS NEON 4X1
Código: Fábriça: Unidade:
42799 INTERPONTE PT/1
F1 F4

UN: R\$ 0,07 AV: R\$ 6,77 15: R\$ 6,91
30: R\$ 7,05 45: R\$ 7,19 60: R\$ 7,33



POST-IT BL ADES 37,5X50MM NEO 100FL 4X1
Código: Fábriça: Unidade:
46069 MASTERPRINT PT/100
F1 F4

UN: R\$ 0,06 AV: R\$ 5,84 15: R\$ 5,97
30: R\$ 6,09 45: R\$ 6,21 60: R\$ 6,33



POST-IT BL ADES 37,5X50MM 100FL AMAR 4X1
Código: Fábriça: Unidade:
42891 MASTERPRINT PT/100
F1 F4

UN: R\$ 5,55 AV: R\$ 5,55 15: R\$ 5,66
30: R\$ 5,78 45: R\$ 5,89 60: R\$ 6,01

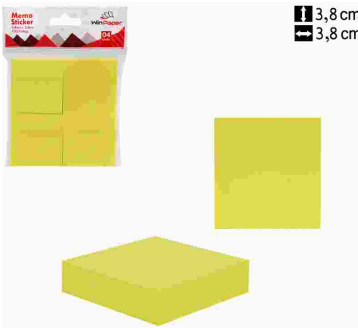

POST-IT BL ADES 38X38MM 100F 4X1
Código: Fábriça: Unidade:
40320 WINCY PT/1
F1 F4

UN: R\$ 7,18 AV: R\$ 7,18 15: R\$ 7,33
30: R\$ 7,48 45: R\$ 7,63 60: R\$ 7,78



POST-IT BL ADES 38X38MM 85406 4X1
Código: Fábriça: Unidade:
42800 INTERPONTE PT/1
F1 F4

UN: R\$ 2,44 AV: R\$ 9,75 15: R\$ 9,95
30: R\$ 10,15 45: R\$ 10,35 60: R\$ 10,56



POST-IT BL ADES 38X50MM 100FLS ROSA 4X1
Código: Fábriça: Unidade:
46372 JOCAROFFICE PT/4
F1 F4

UN: R\$ 2,44 AV: R\$ 9,75 15: R\$ 9,95
30: R\$ 10,15 45: R\$ 10,35 60: R\$ 10,56



POST-IT BL ADES 38X50MM 100FLS VERDE 4X1
Código: Fábriça: Unidade:
46371 JOCAROFFICE PT/4
F1 F4

UN: R\$ 1,90 AV: R\$ 7,59 15: R\$ 7,75
30: R\$ 7,90 45: R\$ 8,06 60: R\$ 8,22



POST-IT BL ADES 38X50MM 100FLS 4X1
Código: Fábriça: Unidade:
41945 OFF PAPER PT/4
F1 F4

UN: R\$ 1,71 AV: R\$ 6,84 15: R\$ 6,98
30: R\$ 7,12 45: R\$ 7,27 60: R\$ 7,41



POST-IT BL ADES 38X50MM 100FLS 4X1
Código: Fábrica: Unidade:
45227 JOCAROFFICE PT/4
F1 F4

UN: R\$ 1,65 AV: R\$ 6,62 15: R\$ 6,75
30: R\$ 6,89 45: R\$ 7,03 60: R\$ 7,17

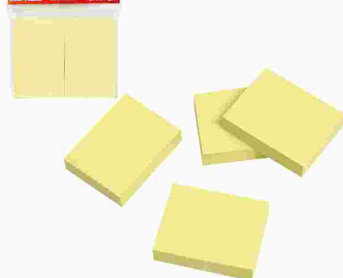

POST-IT BL ADES 38X50MM 100FLS 4X1
Código: Fábrica: Unidade:
43090 PLANETA PT/4
F1 F4

UN: R\$ 1,68 AV: R\$ 6,73 15: R\$ 6,87
30: R\$ 7,01 45: R\$ 7,15 60: R\$ 7,29

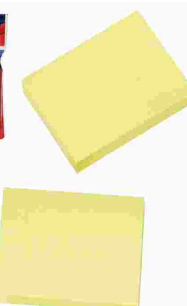

POST-IT BL ADES 38X50MM 100FLS 4X1
Código: Fábrica: Unidade:
44106 FUTURO PT/4
F1 F4

UN: R\$ 0,01 AV: R\$ 4,26 15: R\$ 4,35
30: R\$ 4,44 45: R\$ 4,53 60: R\$ 4,62



POST-IT BL ADES 38X50MM 3CORES 400FLS
Código: Fábrica: Unidade:
48327 BAZZE PT/400
F1 F4

UN: R\$ 1,28 AV: R\$ 5,13 15: R\$ 5,23
30: R\$ 5,34 45: R\$ 5,44 60: R\$ 5,55



POST-IT BL ADES 38X51MM 100F 3801 4X1
Código: Fábrica: Unidade:
34129 BRW PT/4
F1 F4

UN: R\$ 1,00 AV: R\$ 4,00 15: R\$ 4,08
30: R\$ 4,16 45: R\$ 4,24 60: R\$ 4,33



POST-IT BL ADES 38X51MM 50FL 3850 4X1
Código: Fábrica: Unidade:
38014 BRW PT/4
F1 F4

UN: R\$ 1,29 AV: R\$ 6,46 15: R\$ 6,60
30: R\$ 6,73 45: R\$ 6,86 60: R\$ 7,00



POST-IT BL ADES 50X50MM 250FL 5050 5X1
Código: Fábrica: Unidade:
46828 BRW PT/5
F1 F4

UN: R\$ 2,62 AV: R\$ 10,48 15: R\$ 10,70
30: R\$ 10,91 45: R\$ 11,13 60: R\$ 11,35



POST-IT BL ADES 50X50MM 400FL COSMOS 4X1
Código: Fábrica: Unidade:
49500 TRIS PT/4
F1 F4

UN: R\$ 1,80 AV: R\$ 7,18 15: R\$ 7,33
30: R\$ 7,48 45: R\$ 7,63 60: R\$ 7,78



POST-IT BL ADES 50X50MM 400FL KRAFT 4X1
Código: Fábrica: Unidade:
49499 TRIS PT/4
F1 F4

UN: R\$ 3,07 AV: R\$ 3,07 15: R\$ 3,14
30: R\$ 3,20 45: R\$ 3,26 60: R\$ 3,33



POST-IT BL ADES 75X75MM 100FL AMARE 2010
Código: Fábrica: Unidade:
45122 MASTERPRINT UN/1
F1 F4

UN: R\$ 3,07 AV: R\$ 3,07 15: R\$ 3,14
30: R\$ 3,20 45: R\$ 3,26 60: R\$ 3,33



POST-IT BL ADES 75X75MM 100FL AZUL 2013
Código: Fábrica: Unidade:
47209 MASTERPRINT UN/1
F1 F4

UN: R\$ 3,07 AV: R\$ 3,07 15: R\$ 3,14
30: R\$ 3,20 45: R\$ 3,26 60: R\$ 3,33



POST-IT BL ADES 75X75MM 100FL ROSA 2011
Código: Fábrica: Unidade:
47210 MASTERPRINT UN/1
F1 F4

UN: R\$ 3,07 AV: R\$ 3,07 15: R\$ 3,14
30: R\$ 3,20 45: R\$ 3,26 60: R\$ 3,33



POST-IT BL ADES 75X75MM 100FL VERDE 2012
Código: Fábrica: Unidade:
47211 MASTERPRINT UN/1
F1 F4

UN: R\$ 26,70 AV: R\$ 26,70 15: R\$ 27,25
30: R\$ 27,80 45: R\$ 28,35 60: R\$ 28,92

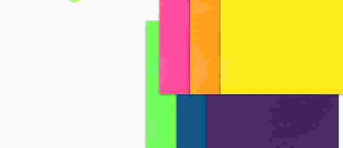

POST-IT BL ADES 75X75MM 495FLS 53105
Código: Fábrica: Unidade:
46445 INTERPONTE PT/1
F1 F4

UN: R\$ 3,07 AV: R\$ 3,07 15: R\$ 3,14
30: R\$ 3,20 45: R\$ 3,26 60: R\$ 3,33



POST-IT BL ADES 75X75MM 50FL TRANSP 584
Código: Fábrica: Unidade:
49504 TRIS PT/1
F1 F4

UN: R\$ 4,58 AV: R\$ 4,58 15: R\$ 4,68
30: R\$ 4,77 45: R\$ 4,87 60: R\$ 4,96

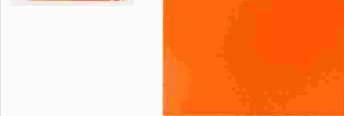
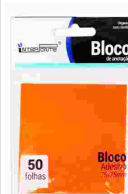

POST-IT BL ADES 75X75MM 50FLS TRANSP 415
Código: Fábrica: Unidade:
46443 INTERPONTE PT/1
F1 F4

UN: R\$ 0,04 AV: R\$ 3,69 15: R\$ 3,76
30: R\$ 3,84 45: R\$ 3,92 60: R\$ 3,99

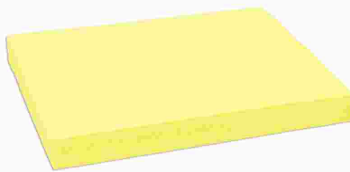

POST-IT BL ADES 76X102MM AMARELO 100FLS
Código: Fábrica: Unidade:
48328 BAZZE PT/100
F1 F4

UN: R\$ 8,10 AV: R\$ 8,10 15: R\$ 8,27
30: R\$ 8,44 45: R\$ 8,61 60: R\$ 8,78

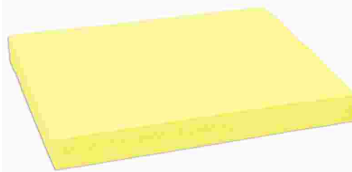

POST-IT BL ADES 76X102MM 100FLS
Código: Fábrica: Unidade:
46373 JOCAROFFICE UN/1
F1 F4

UN: R\$ 8,21 AV: R\$ 8,21 15: R\$ 8,38
30: R\$ 8,55 45: R\$ 8,72 60: R\$ 8,89



POST-IT BL ADES 76X102MM 100FLS
Código: Fábrica: Unidade:
41904 LIKE UN/1
F1 F4

UN: R\$ 4,41 AV: R\$ 4,41 15: R\$ 4,50
30: R\$ 4,59 45: R\$ 4,68 60: R\$ 4,77



POST-IT BL ADES 76X102MM 100FLS 2020
Código: Fábrica: Unidade:
45121 MASTERPRINT UN/1
F1 F4

UN: R\$ 6,43 AV: R\$ 6,43 15: R\$ 6,56
30: R\$ 6,70 45: R\$ 6,83 60: R\$ 6,97

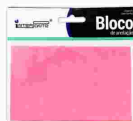

POST-IT BL ADES 76X127MM 100FLS CORES
Código: Fábrica: Unidade:
46442 INTERPONTE PT/1
F1 F4

UN: R\$ 0,03 AV: R\$ 3,07 15: R\$ 3,14
30: R\$ 3,20 45: R\$ 3,26 60: R\$ 3,33



POST-IT BL ADES 76X76MM AMARELO 100FLS
Código: Fábrica: Unidade:
48326 BAZZE PT/100
F1 F4

UN: R\$ 0,05 AV: R\$ 9,23 15: R\$ 9,43
30: R\$ 9,62 45: R\$ 9,81 60: R\$ 10,00



POST-IT BL ADES 76X76MM 200FLS 7601
Código: Fábrica: Unidade:
46829 BRW PT/200
F1 F4

UN: R\$ 0,04 AV: R\$ 14,12 15: R\$ 14,42
30: R\$ 14,71 45: R\$ 15,00 60: R\$ 15,30



POST-IT BL ADES 76X76MM 4CORES 400FLS
Código: Fábrica: Unidade:
48325 BAZZE PT/400
F1 F4

UN: R\$ 0,02 AV: R\$ 2,46 15: R\$ 2,51
30: R\$ 2,56 45: R\$ 2,61 60: R\$ 2,66



POST-IT MARCA PAG NEON RETO 25F 2030 5X1
Código: Fábrica: Unidade:
42245 MASTERPRINT PT/125
F1 F4

UN: R\$ 0,49 AV: R\$ 2,46 15: R\$ 2,51
30: R\$ 2,56 45: R\$ 2,61 60: R\$ 2,66

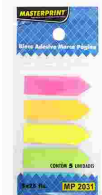

POST-IT MARCA PAG NEON SETA 25F 2031 5X1
Código: Fábrica: Unidade:
43615 MASTERPRINT PT/5
F1 F4

UN: R\$ 5,13 AV: R\$ 5,13 15: R\$ 5,23
30: R\$ 5,34 45: R\$ 5,44 60: R\$ 5,55



POST-IT MARCA PAG SETA NEON 125F 12X44MM
Código: Fábrica: Unidade:
43196 BRW CR/1
F1 F4

UN: R\$ 2,26 AV: R\$ 2,26 15: R\$ 2,31
30: R\$ 2,35 45: R\$ 2,40 60: R\$ 2,45



POST-IT MARCA PAG SETA 125F 4.4X1,2CM
Código: Fábrica: Unidade:
50965 IMPORIENTE CR/1
F1 F4

UN: R\$ 10,26 AV: R\$ 10,26 15: R\$ 10,48
30: R\$ 10,69 45: R\$ 10,90 60: R\$ 11,12



POST-IT MARCA PAG SETA 15F 91128 10X1
Código: Fábrica: Unidade:
46374 JOCAROFFICE CR/1
F1 F4

UN: R\$ 3,69 AV: R\$ 3,69 15: R\$ 3,76
30: R\$ 3,84 45: R\$ 3,92 60: R\$ 3,99



POST-IT MARCA PAG SETA 25F 49032 6X1
Código: Fábrica: Unidade:
46251 IMPORIENTE CR/1
F1 F4

UN: R\$ 1,10 AV: R\$ 5,51 15: R\$ 5,62
30: R\$ 5,73 45: R\$ 5,85 60: R\$ 5,96



POST-IT MARCA PAG 20FLS 5X1
Código: Fábrica: Unidade:
43091 PLANETA PT/5
F1 F4

UN: R\$ 5,51 AV: R\$ 5,51 15: R\$ 5,62
30: R\$ 5,73 45: R\$ 5,85 60: R\$ 5,96

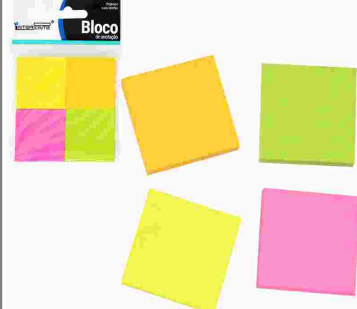

POST-IT MARCA PAG 25X76MM 100FLS 4X1
Código: Fábrica: Unidade:
42801 INTERPONTE PT/1
F1 F4

UN: R\$ 1,37 AV: R\$ 5,50 15: R\$ 5,61
30: R\$ 5,72 45: R\$ 5,84 60: R\$ 5,95



POST-IT MARCA PAGINAS AD 19X76MM 4X1

Código: Fábrika: Unidade:
42409 BRW PT/4
F1 F4

UN: R\$ 0,05 AV: R\$ 9,03 15: R\$ 9,22
30: R\$ 9,40 45: R\$ 9,59 60: R\$ 9,78

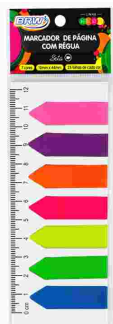

POST-IT MARCA PAG+REGUA 12X44MM 02 175X1

Código: Fábrika: Unidade:
36115 BRW PT/175
F1 F4

UN: R\$ 0,03 AV: R\$ 5,13 15: R\$ 5,23
30: R\$ 5,34 45: R\$ 5,44 60: R\$ 5,55



POST-IT MARCA PAG+REGUA 12X45MM 8X25

Código: Fábrika: Unidade:
48142 YIN'S PAPER PT/200
F1 F4

UN: R\$ 21,58 AV: R\$ 21,58 15: R\$ 22,03
30: R\$ 22,47 45: R\$ 22,92 60: R\$ 23,37



PRANCHETA ACR A4 CRISTAL PREND METAL 120

Código: Fábrika: Unidade:
43211 ACRINIL UN/1
F1 F4

UN: R\$ 27,04 AV: R\$ 27,04 15: R\$ 27,61
30: R\$ 28,16 45: R\$ 28,72 60: R\$ 29,30



PRANCHETA ACR A4 POP PREND PLAST 131

Código: Fábrika: Unidade:
37441 ACRIMET UN/1
F1 F4

UN: R\$ 26,46 AV: R\$ 26,46 15: R\$ 27,01
30: R\$ 27,55 45: R\$ 28,10 60: R\$ 28,66



PRANCHETA ACR A4 PREND METAL 131

Código: Fábrika: Unidade:
21130 NOVACR/ACRIM UN/1
F1 F4

UN: R\$ 22,33 AV: R\$ 22,33 15: R\$ 22,79
30: R\$ 23,25 45: R\$ 23,71 60: R\$ 24,19

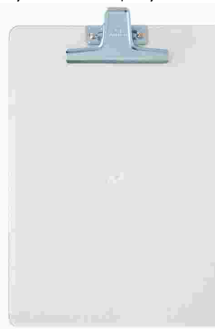

PRANCHETA ACR OF CRISTAL PREND MET 930.3

Código: Fábrika: Unidade:
40478 MAXCRIL UN/1
F1 F4

UN: R\$ 28,21 AV: R\$ 28,21 15: R\$ 28,80
30: R\$ 29,37 45: R\$ 29,96 60: R\$ 30,56

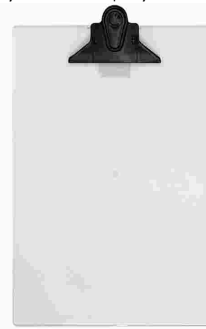

PRANCHETA ACR OF CRISTAL PREND PLAST

Código: Fábrika: Unidade:
41965 CARBRINK UN/1
F1 F4

UN: R\$ 22,33 AV: R\$ 22,33 15: R\$ 22,79
30: R\$ 23,25 45: R\$ 23,71 60: R\$ 24,19



PRANCHETA ACR OF FUME PREND METAL 930.1

Código: Fábrika: Unidade:
40479 MAXCRIL UN/1
F1 F4

UN: R\$ 14,10 AV: R\$ 14,10 15: R\$ 14,39
30: R\$ 14,68 45: R\$ 14,97 60: R\$ 15,27



PRANCHETA ACR OF PRETA PREND PLAST C/RE

Código: Fábrika: Unidade:
42411 CARBRINK UN/1
F1 F4

UN: R\$ 20,28 AV: R\$ 20,28 15: R\$ 20,71
30: R\$ 21,12 45: R\$ 21,54 60: R\$ 21,97

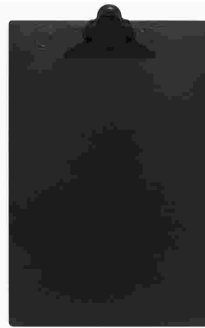

PRANCHETA ACR OF PRETA PREND PLAST 5038

Código: Fábrika: Unidade:
41796 CARBRINK UN/1
F1 F4

UN: R\$ 19,87 AV: R\$ 19,87 15: R\$ 20,29
30: R\$ 20,69 45: R\$ 21,10 60: R\$ 21,53



PRANCHETA ACR 1/2 OF CRISTAL P METAL 130

Código: Fábrika: Unidade:
46004 ACRINIL UN/1
F1 F4

UN: R\$ 23,52 AV: R\$ 23,52 15: R\$ 24,01
30: R\$ 24,49 45: R\$ 24,98 60: R\$ 25,48



PRANCHETA ACR 1/2 OF FUME P METAL 920.1

Código: Fábrika: Unidade:
40879 ACRIMET UN/1
F1 F4

UN: R\$ 8,21 AV: R\$ 8,21 15: R\$ 8,38
30: R\$ 8,55 45: R\$ 8,72 60: R\$ 8,89



PRANCHETA EUCATEX OF PREND METAL

Código: Fábrika: Unidade:
42186 BACCHI UN/1
F1 F4

UN: R\$ 7,32 AV: R\$ 7,32 15: R\$ 7,48
30: R\$ 7,63 45: R\$ 7,78 60: R\$ 7,93



PRANCHETA EUCATEX OF PREND METAL 501

Código: Fábrika: Unidade:
49833 CAVIA UN/1
F1 F4

UN: R\$ 6,26 AV: R\$ 6,26 15: R\$ 6,39
30: R\$ 6,51 45: R\$ 6,64 60: R\$ 6,78



PRANCHETA EUCATEX 1/2 OF PREND METAL 502

Código: Fábrika: Unidade:
49832 CAVIA UN/1
F1 F4

UN: R\$ 10,57 AV: R\$ 10,57 15: R\$ 10,79
30: R\$ 11,01 45: R\$ 11,23 60: R\$ 11,45



PRANCHETA INF CANET+PAPEL 16X23CM 603397

Código: Fábriça: Unidade:
32579 MAX PING UN/1
F1 F4

UN: R\$ 8,21 AV: R\$ 8,21 15: R\$ 8,38
30: R\$ 8,55 45: R\$ 8,72 60: R\$ 8,89



PRANCHETA MDF CRU OF PREND METAL 8289

Código: Fábriça: Unidade:
44671 STALO UN/1
F1 F4

UN: R\$ 14,61 AV: R\$ 14,61 15: R\$ 14,91
30: R\$ 15,21 45: R\$ 15,51 60: R\$ 15,82

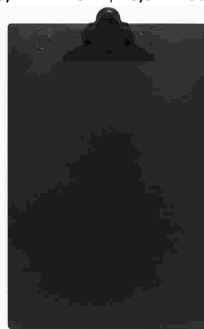

PRANCHETA PLAST A4 PRETA PREND METAL 050

Código: Fábriça: Unidade:
50155 CARBRINK UN/1
F1 F4

UN: R\$ 8,99 AV: R\$ 8,99 15: R\$ 9,18
30: R\$ 9,36 45: R\$ 9,55 60: R\$ 9,74



PRANCHETA POLIONDA CRISTAL

Código: Fábriça: Unidade:
46076 ALAPLAST UN/1
F1 F4

UN: R\$ 8,99 AV: R\$ 8,99 15: R\$ 9,18
30: R\$ 9,36 45: R\$ 9,55 60: R\$ 9,74



PRANCHETA POLIONDA FUME

Código: Fábriça: Unidade:
46078 ALAPLAST UN/1
F1 F4

UN: R\$ 8,99 AV: R\$ 8,99 15: R\$ 9,18
30: R\$ 9,36 45: R\$ 9,55 60: R\$ 9,74



PRANCHETA POLIONDA PRETA

Código: Fábriça: Unidade:
46077 ALAPLAST UN/1
F1 F4

UN: R\$ 18,80 AV: R\$ 18,80 15: R\$ 19,19
30: R\$ 19,58 45: R\$ 19,97 60: R\$ 20,37



PRANCHETA PS A4 CRISTAL PREND METAL 8358

Código: Fábriça: Unidade:
48149 YIN'S PAPER UN/1
F1 F4

UN: R\$ 18,80 AV: R\$ 18,80 15: R\$ 19,19
30: R\$ 19,58 45: R\$ 19,97 60: R\$ 20,37



PRANCHETA PS A4 FUME PREND METAL 8356

Código: Fábriça: Unidade:
48150 YIN'S PAPER UN/1
F1 F4

UN: R\$ 5,23 AV: R\$ 62,71 15: R\$ 64,02
30: R\$ 65,30 45: R\$ 66,60 60: R\$ 67,94



PRENDADOR ZINCADO P/PAPEL 75MM 175 12X1

Código: Fábriça: Unidade:
49834 CAVIA PT/12
F1 F4

UN: R\$ 7,70 AV: R\$ 92,44 15: R\$ 94,36
30: R\$ 96,25 45: R\$ 98,18 60: R\$ 100,14



PRENDADOR ZINCADO P/PAPEL 75MM 192 12X1

Código: Fábriça: Unidade:
45415 CARBRINK PT/12
F1 F4

UN: R\$ 12,67 AV: R\$ 152,03 15: R\$ 155,19
30: R\$ 158,30 45: R\$ 161,46 60: R\$ 164,69



PRENDADOR ZINCADO P/PAPEL 95MM 190 12X1

Código: Fábriça: Unidade:
45414 CARBRINK PT/12
F1 F4

UN: R\$ 22,86 AV: R\$ 22,86 15: R\$ 23,33
30: R\$ 23,80 45: R\$ 24,27 60: R\$ 24,76



PRIMER P/METAL/PET/VIDR 100 ML 519 BCO

Código: Fábriça: Unidade:
44113 ACRILEX UN/1
F1 F4

UN: R\$ 5,65 AV: R\$ 112,98 15: R\$ 115,34
30: R\$ 117,64 45: R\$ 120,00 60: R\$ 122,40



PROTETOR ACRILICO P/RG 0,050MM 20X1

Código: Fábriça: Unidade:
44604 MAXIPLASTICO PT/20
F1 F4

UN: R\$ 3,08 AV: R\$ 30,82 15: R\$ 31,46
30: R\$ 32,09 45: R\$ 32,73 60: R\$ 33,38



PROTETOR ACRILICO RIGIDO CNH 10X1

Código: Fábriça: Unidade:
30085 MP PT/10
F1 F4

UN: R\$ 0,67 AV: R\$ 13,34 15: R\$ 13,62
30: R\$ 13,89 45: R\$ 14,17 60: R\$ 14,46



PROTETOR A1 P/CRACHA CRISTAL 10X7CM 20X1

Código: Fábriça: Unidade:
41975 VMP PT/20
F1 F4

UN: R\$ 0,72 AV: R\$ 7,18 15: R\$ 7,33
30: R\$ 7,48 45: R\$ 7,63 60: R\$ 7,78



PROTETOR PLAST P/CD 13X13CM P-17 10X1

Código: Fábriça: Unidade:
46176 ACP PT/10
F1 F4

UN: R\$ 0,49 AV: R\$ 49,30 15: R\$ 50,32
30: R\$ 51,33 45: R\$ 52,36 60: R\$ 53,40



PROTETOR PORTA DOCUMEN 70X105CM P7 100X1
Código: Fábrica: Unidade:
46203 ACP PT/100
F1 F4

UN: R\$ 0,37 AV: R\$ 36,88 15: R\$ 37,64
30: R\$ 38,40 45: R\$ 39,17 60: R\$ 39,95



PROTETOR PORTA DOCUMENT 65X90CM P6 100X1
Código: Fábrica: Unidade:
46202 ACP PT/100
F1 F4

UN: R\$ 12,32 AV: R\$ 12,32 15: R\$ 12,57
30: R\$ 12,82 45: R\$ 13,08 60: R\$ 13,34



PROTETOR PORTIF A4 10 PLAST PRETO
Código: Fábrica: Unidade:
44595 MAXIPLASTICO UN/1
F1 F4

UN: R\$ 17,98 AV: R\$ 17,98 15: R\$ 18,35
30: R\$ 18,72 45: R\$ 19,09 60: R\$ 19,47



PROTETOR PORTIF A4 30 PLAST PRETO
Código: Fábrica: Unidade:
44596 MAXIPLASTICO UN/1
F1 F4

UN: R\$ 20,53 AV: R\$ 20,53 15: R\$ 20,96
30: R\$ 21,38 45: R\$ 21,81 60: R\$ 22,24



PROTETOR PORTIF A4 50 PLAST PRETO
Código: Fábrica: Unidade:
44597 MAXIPLASTICO UN/1
F1 F4

UN: R\$ 22,59 AV: R\$ 22,59 15: R\$ 23,06
30: R\$ 23,52 45: R\$ 23,99 60: R\$ 24,47



PROTETOR PORTIF A4 50 PLAST VERMELHO
Código: Fábrica: Unidade:
44601 MAXIPLASTICO UN/1
F1 F4

UN: R\$ 30,81 AV: R\$ 30,81 15: R\$ 31,45
30: R\$ 32,08 45: R\$ 32,72 60: R\$ 33,37



PROTETOR PORTIF A4 100 PLAST PRETO
Código: Fábrica: Unidade:
44598 MAXIPLASTICO UN/1
F1 F4

UN: R\$ 6,16 AV: R\$ 123,25 15: R\$ 125,82
30: R\$ 128,34 45: R\$ 130,90 60: R\$ 133,52



PROTETOR ACRILICO P/DUTA 0,050MM 20X1
Código: Fábrica: Unidade:
44602 MAXIPLASTICO PT/20
F1 F4

UN: R\$ 2,04 AV: R\$ 24,53 15: R\$ 25,04
30: R\$ 25,54 45: R\$ 26,05 60: R\$ 26,57



PURPURINA 3 GRS DOURADO 12X1
Código: Fábrica: Unidade:
15075 CITY BRILHO CX/12
F1 F4

UN: R\$ 2,04 AV: R\$ 24,53 15: R\$ 25,04
30: R\$ 25,54 45: R\$ 26,05 60: R\$ 26,57



PURPURINA 3 GRS PRATA 12X1
Código: Fábrica: Unidade:
15076 CITY BRILHO CX/12
F1 F4

UN: R\$ 112,98 AV: R\$ 112,98 15: R\$ 115,34
30: R\$ 117,64 45: R\$ 120,00 60: R\$ 122,40



PURPURINA 500 GRS DOURADO
Código: Fábrica: Unidade:
44253 TOK BIJOUXS PT/1
F1 F4

UN: R\$ 112,98 AV: R\$ 112,98 15: R\$ 115,34
30: R\$ 117,64 45: R\$ 120,00 60: R\$ 122,40



PURPURINA 500 GRS PRATA
Código: Fábrica: Unidade:
44254 TOK BIJOUXS PT/1
F1 F4

UN: R\$ 225,97 AV: R\$ 225,97 15: R\$ 230,68
30: R\$ 235,30 45: R\$ 240,00 60: R\$ 244,80

90cm
120cm



QUADRO AVISO CORTIC ALUM A 120X90CM 8213
Código: Fábrica: Unidade:
45817 STALO UN/1
F1 F4

UN: R\$ 251,65 AV: R\$ 251,65 15: R\$ 256,90
30: R\$ 262,03 45: R\$ 267,28 60: R\$ 272,62



QUADRO AVISO CORTIC ALUM 120X90CM
Código: Fábrica: Unidade:
42601 STALO UN/1
F1 F4

UN: R\$ 187,18 AV: R\$ 187,18 15: R\$ 191,08
30: R\$ 194,90 45: R\$ 198,80 60: R\$ 202,77

90cm
120cm

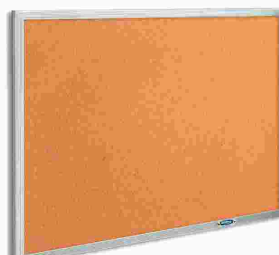

QUADRO AVISO CORTIC ALUM 120X90CM 2012
Código: Fábrica: Unidade:
46803 CORTIARTE UN/1
F1 F4

UN: R\$ 143,80 AV: R\$ 143,80 15: R\$ 146,79
30: R\$ 149,73 45: R\$ 152,72 60: R\$ 155,78

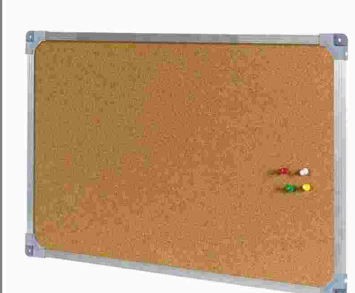

QUADRO AVISO CORTIC ALUM 90X60CM 9329
Código: Fábrica: Unidade:
42600 STALO UN/1
F1 F4

UN: R\$ 112,98 AV: R\$ 112,98 15: R\$ 115,34
30: R\$ 117,64 45: R\$ 120,00 60: R\$ 122,40
↑ 70 cm
↔ 100 cm

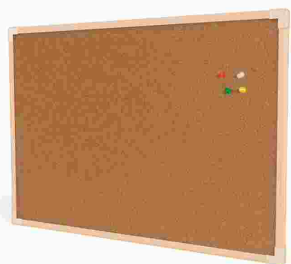

QUADRO AVISO CORTIC MAD 100X70CM

Código: Fábrica: Unidade:
42853 STALO UN/1
F1 F4

UN: R\$ 431,41 AV: R\$ 431,41 15: R\$ 440,40
30: R\$ 449,21 45: R\$ 458,19 60: R\$ 467,36
↔ 200cm
↑ 120cm



QUADRO AVISO CORTIC MAD 120X200CM 1024

Código: Fábrica: Unidade:
49218 CORTIARTE UN/1
F1 F4

UN: R\$ 179,75 AV: R\$ 179,75 15: R\$ 183,49
30: R\$ 187,16 45: R\$ 190,91 60: R\$ 194,73
↔ 90cm
↑ 120cm



QUADRO AVISO CORTIC MAD 120X90CM 1021

Código: Fábrica: Unidade:
45635 CORTIARTE UN/1
F1 F4

UN: R\$ 183,86 AV: R\$ 183,86 15: R\$ 187,69
30: R\$ 191,44 45: R\$ 195,27 60: R\$ 199,18
↑ 90 cm
↔ 120 cm

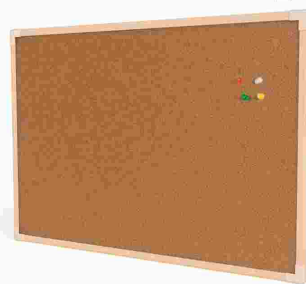

QUADRO AVISO CORTIC MAD 120X90CM 9341

Código: Fábrica: Unidade:
41954 STALO UN/1
F1 F4

UN: R\$ 64,20 AV: R\$ 64,20 15: R\$ 65,54
30: R\$ 66,85 45: R\$ 68,19 60: R\$ 69,55
↑ 40 cm
↔ 60 cm

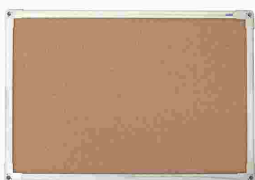

QUADRO AVISO CORTIC MAD 60X40CM 9333

Código: Fábrica: Unidade:
44150 STALO UN/1
F1 F4

UN: R\$ 92,44 AV: R\$ 92,44 15: R\$ 94,36
30: R\$ 96,25 45: R\$ 98,18 60: R\$ 100,14
↑ 60 cm
↔ 90 cm

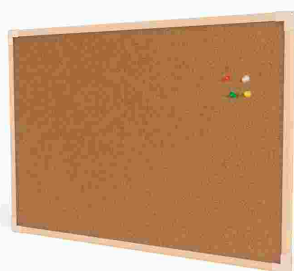

QUADRO AVISO CORTIC MAD 90X60CM

Código: Fábrica: Unidade:
42084 STALO UN/1
F1 F4

UN: R\$ 68,31 AV: R\$ 68,31 15: R\$ 69,73
30: R\$ 71,13 45: R\$ 72,55 60: R\$ 74,00
↑ 40 cm
↔ 60 cm

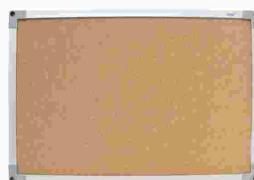

QUADRO AVISO CORTIC MDF ALUM 060X040CM

Código: Fábrica: Unidade:
44146 STALO UN/1
F1 F4

UN: R\$ 80,79 AV: R\$ 80,79 15: R\$ 82,47
30: R\$ 84,12 45: R\$ 85,80 60: R\$ 87,52
↑ 50 cm
↔ 70 cm

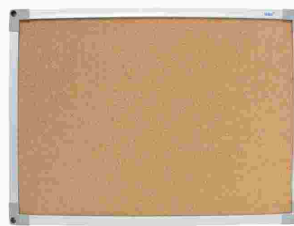

QUADRO AVISO CORTIC MDF ALUM 070X050CM

Código: Fábrica: Unidade:
44148 STALO UN/1
F1 F4

UN: R\$ 106,82 AV: R\$ 106,82 15: R\$ 109,04
30: R\$ 111,22 45: R\$ 113,45 60: R\$ 115,72



QUADRO AVISO CORTIC MDF ALUM 090X060CM

Código: Fábrica: Unidade:
42602 STALO UN/1
F1 F4

UN: R\$ 171,54 AV: R\$ 171,54 15: R\$ 175,12
30: R\$ 178,62 45: R\$ 182,19 60: R\$ 185,83
↑ 70 cm
↔ 100 cm



QUADRO AVISO CORTIC MDF ALUM 100X70CM

Código: Fábrica: Unidade:
44145 STALO UN/1
F1 F4

UN: R\$ 236,25 AV: R\$ 236,25 15: R\$ 241,17
30: R\$ 245,99 45: R\$ 250,91 60: R\$ 255,93
↑ 90 cm
↔ 120 cm

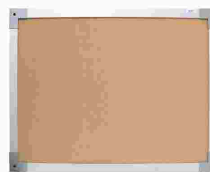

QUADRO AVISO CORTIC MDF ALUM 120X90CM

Código: Fábrica: Unidade:
44153 STALO UN/1
F1 F4

UN: R\$ 98,60 AV: R\$ 98,60 15: R\$ 100,66
30: R\$ 102,67 45: R\$ 104,72 60: R\$ 106,82

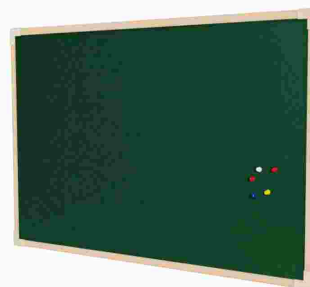

QUADRO AVISO FELTRO MAD 90X60CM

Código: Fábrica: Unidade:
43005 STALO UN/1
F1 F4

UN: R\$ 221,98 AV: R\$ 221,98 15: R\$ 226,60
30: R\$ 231,13 45: R\$ 235,76 60: R\$ 240,47
↔ 120cm
↑ 90cm



QUADRO AVISO FELTRO MDF AL 120X90CM 5095

Código: Fábrica: Unidade:
50158 STALO UN/1
F1 F4

UN: R\$ 118,49 AV: R\$ 118,49 15: R\$ 120,96
30: R\$ 123,38 45: R\$ 125,84 60: R\$ 128,36
↑ 60cm
↔ 90cm



QUADRO AVISO FELTRO STD ALUM 90X60CM

Código: Fábrica: Unidade:
45637 CORTIARTE UN/1
F1 F4

UN: R\$ 323,29 AV: R\$ 323,29 15: R\$ 330,03
30: R\$ 336,63 45: R\$ 343,36 60: R\$ 350,23
↑ 90cm
↔ 120cm



QUADRO BCO MAGN MDF ALUM 120X90CM 4062

Código: Fábrica: Unidade:
44673 STALO UN/1
F1 F4

UN: R\$ 513,59 AV: R\$ 513,59 15: R\$ 524,29
30: R\$ 534,78 45: R\$ 545,47 60: R\$ 556,38
↔ 150cm
↑ 120cm

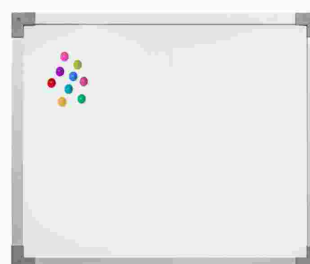

QUADRO BCO MAGN MDF ALUM 150X120CM 4243

Código: Fábrica: Unidade:
50159 STALO UN/1
F1 F4

UN: R\$ 156,10 AV: R\$ 156,10 15: R\$ 159,36
30: R\$ 162,54 45: R\$ 165,79 60: R\$ 169,11

↑ 60cm
↔ 90cm



QUADRO BCO MAGN MDF ALUM 90X60CM 4061
Código: Fábrica: Unidade:
44672 STALO UN/1
F1 F4

UN: R\$ 82,17 AV: R\$ 82,17 15: R\$ 83,88
30: R\$ 85,56 45: R\$ 87,27 60: R\$ 89,01



QUADRO BCO PLANEJ MENSAL MAD 90X60CM
Código: Fábrica: Unidade:
50335 SOUZA UN/1
F1 F4

UN: R\$ 243,44 AV: R\$ 243,44 15: R\$ 248,51
30: R\$ 253,48 45: R\$ 258,55 60: R\$ 263,72

↑ 200cm
↔ 120cm



QUADRO BRANCO MADEIRA 200X120CM 1323
Código: Fábrica: Unidade:
49472 CORTIARTE UN/1
F1 F4

UN: R\$ 321,65 AV: R\$ 321,65 15: R\$ 328,35
30: R\$ 334,92 45: R\$ 341,61 60: R\$ 348,45

↑ 60cm
↔ 90cm



QUADRO BRANCO MAG POP ALUM 120X90CM 64
Código: Fábrica: Unidade:
49131 CORTIARTE UN/1
F1 F4

UN: R\$ 125,46 AV: R\$ 125,46 15: R\$ 128,08
30: R\$ 130,64 45: R\$ 133,25 60: R\$ 135,92

↑ 90cm
↔ 120cm



QUADRO BRANCO POP ALUM 120X90CM 2321
Código: Fábrica: Unidade:
46802 CORTIARTE UN/1
F1 F4

UN: R\$ 285,11 AV: R\$ 285,11 15: R\$ 291,05
30: R\$ 296,87 45: R\$ 302,81 60: R\$ 308,86

↑ 120cm
↔ 200cm



QUADRO BRANCO POP ALUM 200X120CM 2327
Código: Fábrica: Unidade:
45636 CORTIARTE UN/1
F1 F4

UN: R\$ 131,47 AV: R\$ 131,47 15: R\$ 134,21
30: R\$ 136,89 45: R\$ 139,63 60: R\$ 142,43

↑ 70 cm
↔ 100 cm



QUADRO BRANCO UV ALUM 100X70CM 9123
Código: Fábrica: Unidade:
44144 STALO UN/1
F1 F4

UN: R\$ 143,80 AV: R\$ 143,80 15: R\$ 146,79
30: R\$ 149,73 45: R\$ 152,72 60: R\$ 155,78

↑ 90 cm
↔ 120 cm



QUADRO BRANCO UV ALUM 120X90CM 9124
Código: Fábrica: Unidade:
44152 STALO UN/1
F1 F4

UN: R\$ 359,51 AV: R\$ 359,51 15: R\$ 367,00
30: R\$ 374,34 45: R\$ 381,83 60: R\$ 389,46

↑ 120 cm
↔ 200 cm

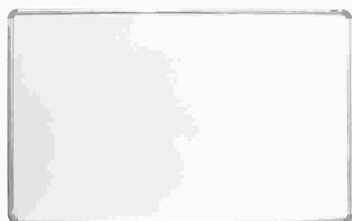

QUADRO BRANCO UV ALUM 200X120CM 8365
Código: Fábrica: Unidade:
44143 STALO UN/1
F1 F4

UN: R\$ 36,51 AV: R\$ 36,51 15: R\$ 37,27
30: R\$ 38,01 45: R\$ 38,77 60: R\$ 39,55

↑ 30 cm
↔ 40 cm



QUADRO BRANCO UV ALUM 40X30CM 9120
Código: Fábrica: Unidade:
50193 STALO UN/1
F1 F4

UN: R\$ 39,02 AV: R\$ 39,02 15: R\$ 39,84
30: R\$ 40,63 45: R\$ 41,45 60: R\$ 42,27

↑ 30 cm
↔ 40 cm



QUADRO BRANCO UV ALUM 40X30CM 9120
Código: Fábrica: Unidade:
44142 STALO UN/1
F1 F4

UN: R\$ 71,39 AV: R\$ 71,39 15: R\$ 72,88
30: R\$ 74,34 45: R\$ 75,82 60: R\$ 77,34

↑ 40 cm
↔ 60 cm



QUADRO BRANCO UV ALUM 60X40CM 9121
Código: Fábrica: Unidade:
44147 STALO UN/1
F1 F4

UN: R\$ 86,27 AV: R\$ 86,27 15: R\$ 88,07
30: R\$ 89,83 45: R\$ 91,63 60: R\$ 93,46

↑ 50 cm
↔ 70 cm



QUADRO BRANCO UV ALUM 70X50CM 9125
Código: Fábrica: Unidade:
44151 STALO UN/1
F1 F4

UN: R\$ 112,98 AV: R\$ 112,98 15: R\$ 115,34
30: R\$ 117,64 45: R\$ 120,00 60: R\$ 122,40

↑ 60 cm
↔ 90 cm



QUADRO BRANCO UV ALUM 90X60CM 9122
Código: Fábrica: Unidade:
44149 STALO UN/1
F1 F4

UN: R\$ 61,62 AV: R\$ 61,62 15: R\$ 62,91
30: R\$ 64,16 45: R\$ 65,45 60: R\$ 66,76

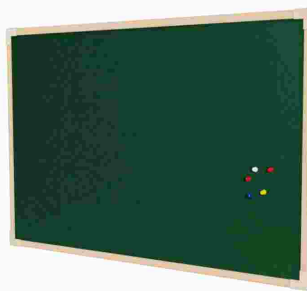

QUADRO BRANCO UV MAD 90X60CM 9329
Código: Fábrica: Unidade:
43006 STALO UN/1
F1 F4

UN: R\$ 331,27 AV: R\$ 331,27 15: R\$ 338,17
30: R\$ 344,94 45: R\$ 351,84 60: R\$ 358,87

↑ 120cm
↔ 200cm



QUADRO BRANCO UV MDF ALUM 200X120CM 4019
Código: Fábrica: Unidade:
45622 STALO UN/1
F1 F4

UN: R\$ 205,61 AV: R\$ 205,61 15: R\$ 209,90
30: R\$ 214,10 45: R\$ 218,38 60: R\$ 222,75

60cm
90cm



QUADRO FELTRO POP ALUM 120X90CM 1141
Código: Fábrica: Unidade:
49128 CORTIARTE UN/1
F1 F4

UN: R\$ 10,45 AV: R\$ 10,45 15: R\$ 10,67
30: R\$ 10,88 45: R\$ 11,10 60: R\$ 11,32



QUADRO PP A4 0,40MM MULTI USO CRISTAL
Código: Fábrica: Unidade:
34128 PLASCONY UN/1
F1 F4

UN: R\$ 12,58 AV: R\$ 12,58 15: R\$ 12,85
30: R\$ 13,10 45: R\$ 13,36 60: R\$ 13,63



QUADRO VERDE (LOUSA) 25X35CM 260
Código: Fábrica: Unidade:
13173 P A SOUZA UN/1
F1 F4

UN: R\$ 16,42 AV: R\$ 16,42 15: R\$ 16,77
30: R\$ 17,10 45: R\$ 17,44 60: R\$ 17,79

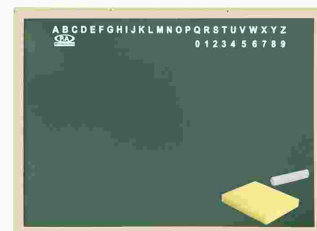

QUADRO VERDE (LOUSA) 35X45CM 261
Código: Fábrica: Unidade:
36392 P A SOUZA UN/1
F1 F4

UN: R\$ 22,34 AV: R\$ 22,34 15: R\$ 22,81
30: R\$ 23,26 45: R\$ 23,73 60: R\$ 24,20

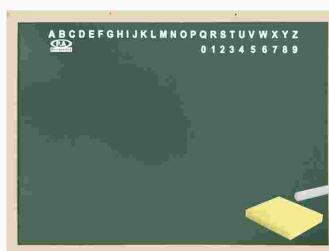

QUADRO VERDE (LOUSA) 37X50CM 262
Código: Fábrica: Unidade:
6834 P A SOUZA UN/1
F1 F4

UN: R\$ 2,71 AV: R\$ 54,26 15: R\$ 55,39
30: R\$ 56,50 45: R\$ 57,63 60: R\$ 58,78



RECIBO SERVICO TAXI 105X150MM 50FLS 20X1
Código: Fábrica: Unidade:
39291 TAMOIO PT/20
F1 F4

UN: R\$ 1,95 AV: R\$ 19,51 15: R\$ 19,91
30: R\$ 20,31 45: R\$ 20,72 60: R\$ 21,13



REFIL APAGADOR QUADRO BCO MAGN 10X1
Código: Fábrica: Unidade:
45633 CORTIARTE PT/10
F1 F4

UN: R\$ 3,69 AV: R\$ 3,69 15: R\$ 3,76
30: R\$ 3,84 45: R\$ 3,92 60: R\$ 3,99



REFIL P/ MARCADOR QUADRO BCO AZUL 1001
Código: Fábrica: Unidade:
34131 BRW UN/1
F1 F4

UN: R\$ 3,07 AV: R\$ 3,07 15: R\$ 3,14
30: R\$ 3,20 45: R\$ 3,26 60: R\$ 3,33



REFIL P/ MARCADOR QUADRO BCO AZUL 991006
Código: Fábrica: Unidade:
48190 JOCAROFFICE UN/1
F1 F4

UN: R\$ 3,07 AV: R\$ 3,07 15: R\$ 3,14
30: R\$ 3,20 45: R\$ 3,26 60: R\$ 3,33



REFIL P/ MARCADOR QUADRO BCO PRET 991006
Código: Fábrica: Unidade:
48191 JOCAROFFICE UN/1
F1 F4

UN: R\$ 3,69 AV: R\$ 3,69 15: R\$ 3,76
30: R\$ 3,84 45: R\$ 3,92 60: R\$ 3,99



REFIL P/ MARCADOR QUADRO BCO PRETO 1002
Código: Fábrica: Unidade:
34130 BRW UN/1
F1 F4

UN: R\$ 3,07 AV: R\$ 3,07 15: R\$ 3,14
30: R\$ 3,20 45: R\$ 3,26 60: R\$ 3,33



REFIL P/ MARCADOR QUADRO BCO VERM 991006
Código: Fábrica: Unidade:
48192 JOCAROFFICE UN/1
F1 F4

UN: R\$ 4,10 AV: R\$ 4,10 15: R\$ 4,18
30: R\$ 4,27 45: R\$ 4,35 60: R\$ 4,44



REFIL P/ MARCADOR QUADRO BCO VERMEL 1003
Código: Fábrica: Unidade:
44161 BRW UN/1
F1 F4

UN: R\$ 6,94 AV: R\$ 6,94 15: R\$ 7,16
30: R\$ 7,38 45: R\$ 7,60 60: R\$ 7,83



REFIL P/FICHARIO 96 FLS BRANCO
Código: Fábrica: Unidade:
19581 TILIBRA UN/1
F1 F4

UN: R\$ 8,72 AV: R\$ 87,18 15: R\$ 88,99
30: R\$ 90,77 45: R\$ 92,59 60: R\$ 94,44

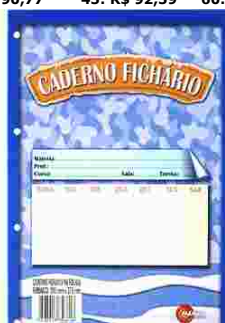

REFIL P/FICHARIO 96 FLS BRANCO 10X1
Código: Fábrica: Unidade:
33257 MAXIMA PT/10
F1 F4

UN: R\$ 10,46 AV: R\$ 104,61 15: R\$ 106,79
30: R\$ 108,93 45: R\$ 111,11 60: R\$ 113,33

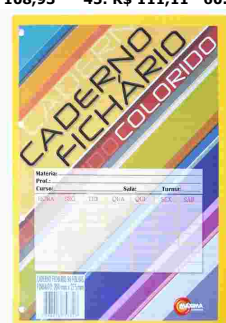

REFIL P/FICHARIO 96 FLS COLORIDO 10X1
Código: Fábrica: Unidade:
15285 MAXIMA PT/10
F1 F4

UN: R\$ 3,48 AV: R\$ 34,81 15: R\$ 35,53
30: R\$ 36,24 45: R\$ 36,97 60: R\$ 37,71



REFIL 1/4 P/FICHARIO 96 FLS PEQ 10X1
Código: Fábrika: Unidade:
9647 SULAMERICANA PT/10
F1 F4

UN: R\$ 205,43 AV: R\$ 205,43 15: R\$ 209,71
30: R\$ 213,90 45: R\$ 218,18 60: R\$ 222,55



REFILADORA DE PAPEL A4/A5 10 FLS
Código: Fábrika: Unidade:
44123 YIN'S PAPER UN/1
F1 F4

UN: R\$ 18,48 AV: R\$ 18,48 15: R\$ 18,86
30: R\$ 19,24 45: R\$ 19,63 60: R\$ 20,02



REGUA DE PULSO 20 CM MARIA CLARA &JP
Código: Fábrika: Unidade:
50328 FIRST UN/1
F1 F4

UN: R\$ 4,35 AV: R\$ 4,35 15: R\$ 4,44
30: R\$ 4,53 45: R\$ 4,62 60: R\$ 4,72

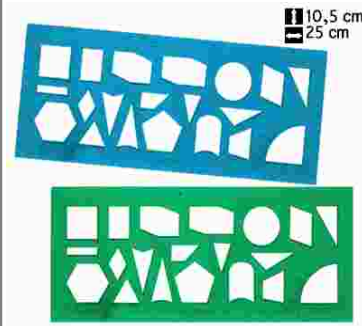

REGUA GEOMETRICA 10,5X25CM RG029
Código: Fábrika: Unidade:
33057 BUDEPLAST UN/1
F1 F4

UN: R\$ 5,56 AV: R\$ 5,56 15: R\$ 5,68
30: R\$ 5,79 45: R\$ 5,91 60: R\$ 6,02

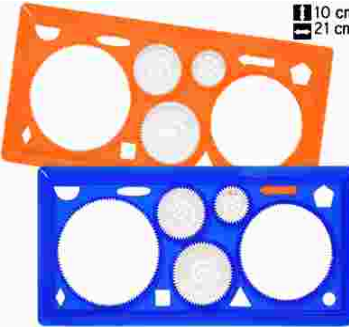

REGUA MAGICA 10X21CM RG029/032
Código: Fábrika: Unidade:
33058 BUDEPLAST UN/1
F1 F4

UN: R\$ 23,62 AV: R\$ 23,62 15: R\$ 24,11
30: R\$ 24,59 45: R\$ 25,08 60: R\$ 25,58



REGUA 1 METRO MADEIRA C/PEGADOR
Código: Fábrika: Unidade:
45184 STALO/SOUSA UN/1
F1 F4

UN: R\$ 41,08 AV: R\$ 41,08 15: R\$ 41,93
30: R\$ 42,77 45: R\$ 43,63 60: R\$ 44,50



REGUA 1 METRO METAL ACO INOX ESCALA 300
Código: Fábrika: Unidade:
45079 NYBC UN/1
F1 F4

UN: R\$ 4,37 AV: R\$ 43,66 15: R\$ 44,57
30: R\$ 45,46 45: R\$ 46,37 60: R\$ 47,29

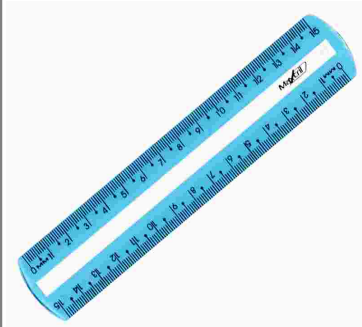

REGUA 15 CM GUIA LEITURA AZUL EMB IN10X1
Código: Fábrika: Unidade:
50763 MAXCRIL PT/10
F1 F4

UN: R\$ 0,71 AV: R\$ 25,68 15: R\$ 26,22
30: R\$ 26,74 45: R\$ 27,27 60: R\$ 27,82



REGUA 15 CM POWER RANGERS JUNGLE 36X1
Código: Fábrika: Unidade:
35684 TRIS C//36
F4

UN: R\$ 3,58 AV: R\$ 3,58 15: R\$ 3,66
30: R\$ 3,73 45: R\$ 3,81 60: R\$ 3,88

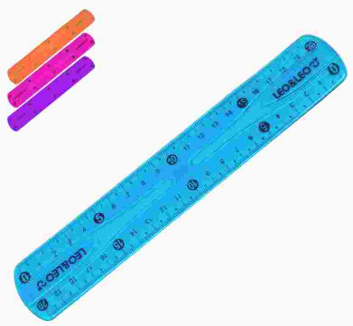

REGUA 20 CM FLEXIVEL COLOR 4567
Código: Fábrika: Unidade:
49114 LEO&LEO UN/1
F1 F4

UN: R\$ 2,52 AV: R\$ 25,17 15: R\$ 25,69
30: R\$ 26,20 45: R\$ 26,73 60: R\$ 27,26

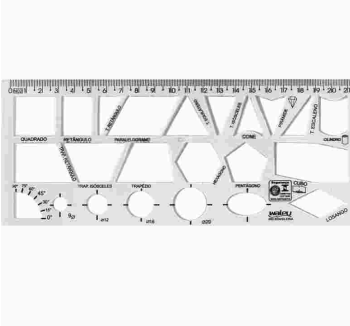

REGUA 21 CM GEOMETRICA CRISTAL 10X1
Código: Fábrika: Unidade:
21493 WALEU PT/10
F1 F4

UN: R\$ 4,57 AV: R\$ 4,57 15: R\$ 4,67
30: R\$ 4,76 45: R\$ 4,85 60: R\$ 4,95

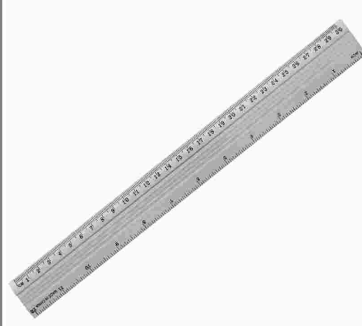

REGUA 30 CM ALUMINIO 1002810
Código: Fábrika: Unidade:
43088 PLANETA UN/1
F1 F4

UN: R\$ 5,84 AV: R\$ 5,84 15: R\$ 5,97
30: R\$ 6,09 45: R\$ 6,21 60: R\$ 6,33

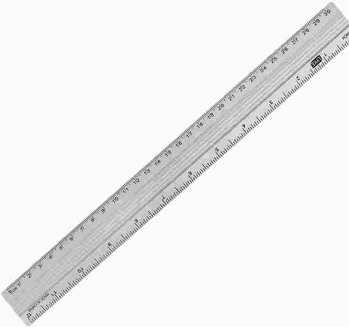

REGUA 30 CM ALUMINIO 101-014
Código: Fábrika: Unidade:
14678 LYKE UN/1
F1 F4

UN: R\$ 5,95 AV: R\$ 5,95 15: R\$ 6,07
30: R\$ 6,19 45: R\$ 6,32 60: R\$ 6,44



REGUA 30 CM BAIXA VISAO CRISTAL UN
Código: Fábrika: Unidade:
50767 MAXCRIL UN/1
F1 F4

UN: R\$ 5,95 AV: R\$ 59,47 15: R\$ 60,71
30: R\$ 61,93 45: R\$ 63,17 60: R\$ 64,43



REGUA 30 CM BAIXA VISAO CRISTAL 10X1
Código: Fábrika: Unidade:
50765 MAXCRIL PT/10
F1 F4

UN: R\$ 3,25 AV: R\$ 32,51 15: R\$ 33,19
30: R\$ 33,85 45: R\$ 34,53 60: R\$ 35,22

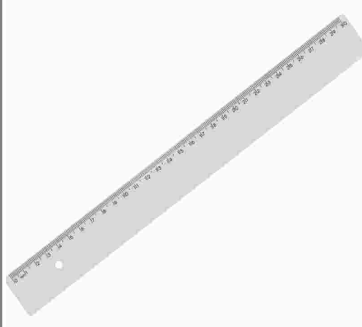

REGUA 30 CM BRANCA EMB IND 987.2 10X1
Código: Fábrika: Unidade:
40885 ACRIMET PT/10
F1 F4

UN: R\$ 2,90 AV: R\$ 29,03 15: R\$ 29,63
30: R\$ 30,22 45: R\$ 30,83 60: R\$ 31,44

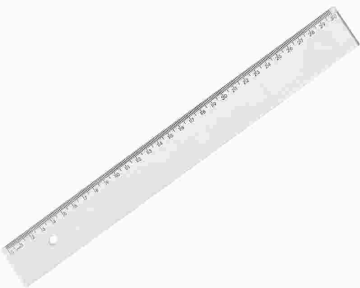

REGUA 30 CM CRISTAL EMB IND 984 10X1
Código: 37445 Fábrica: ACRIMET Unidade: PT/10 F1 F4

UN: R\$ 4,62 AV: R\$ 110,88 15: R\$ 113,19
30: R\$ 115,45 45: R\$ 117,76 60: R\$ 120,12

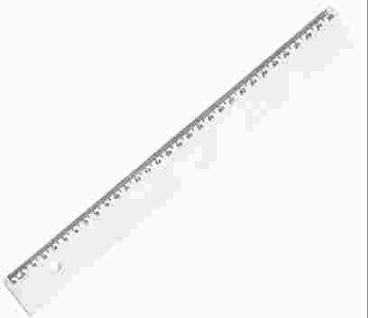

REGUA 30 CM CRISTAL EMBAL IND 981 24X1
Código: 32389 Fábrica: ACRIMET Unidade: CX/24 F1 F4

UN: R\$ 2,67 AV: R\$ 26,70 15: R\$ 27,25
30: R\$ 27,80 45: R\$ 28,35 60: R\$ 28,92

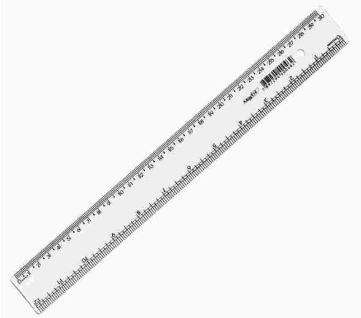

REGUA 30 CM CRISTAL SUPER 10X1
Código: 22911 Fábrica: MAXCRIL Unidade: PT/10 F1 F4

UN: R\$ 1,23 AV: R\$ 30,81 15: R\$ 31,45
30: R\$ 32,08 45: R\$ 32,72 60: R\$ 33,37



REGUA 30 CM CRISTAL 10270012 25X1
Código: 215 Fábrica: MAXCRIL Unidade: PT/25 F1 F4

UN: R\$ 1,03 AV: R\$ 102,71 15: R\$ 104,85
30: R\$ 106,95 45: R\$ 109,09 60: R\$ 111,27



REGUA 30 CM CRISTAL 10270086 100X1
Código: 35737 Fábrica: MAXCRIL Unidade: CX/100 F1 F4

UN: R\$ 2,05 AV: R\$ 20,54 15: R\$ 20,97
30: R\$ 21,39 45: R\$ 21,82 60: R\$ 22,26



REGUA 30 CM EMB IND BANG ON THE DOOR 10X1
Código: 38562 Fábrica: POLIBRAS Unidade: PT/10 F1 F4

UN: R\$ 2,05 AV: R\$ 20,54 15: R\$ 20,97
30: R\$ 21,39 45: R\$ 21,82 60: R\$ 22,26



REGUA 30 CM EMB IND BARBIE 10X1
Código: 38567 Fábrica: POLIBRAS Unidade: PT/10 F1 F4

UN: R\$ 2,05 AV: R\$ 20,54 15: R\$ 20,97
30: R\$ 21,39 45: R\$ 21,82 60: R\$ 22,26



REGUA 30 CM EMB IND CHEVROLET 10X1
Código: 38564 Fábrica: POLIBRAS Unidade: PT/10 F4

UN: R\$ 2,40 AV: R\$ 28,76 15: R\$ 29,36
30: R\$ 29,95 45: R\$ 30,55 60: R\$ 31,16



REGUA 30 CM EMB IND HIGH SCHHOL MUS 12X1
Código: 38568 Fábrica: SUMMIT Unidade: PT/12 F1 F4

UN: R\$ 2,90 AV: R\$ 29,01 15: R\$ 29,62
30: R\$ 30,21 45: R\$ 30,82 60: R\$ 31,43



REGUA 30 CM EMB IND HOT WHEELS 10X1
Código: 38563 Fábrica: POLIBRAS Unidade: PT/10 F1 F4

UN: R\$ 2,05 AV: R\$ 20,54 15: R\$ 20,97
30: R\$ 21,39 45: R\$ 21,82 60: R\$ 22,26



REGUA 30 CM EMB IND POLLY 10X1
Código: 38560 Fábrica: POLIBRAS Unidade: PT/10 F1 F4

UN: R\$ 2,05 AV: R\$ 20,54 15: R\$ 20,97
30: R\$ 21,39 45: R\$ 21,82 60: R\$ 22,26



REGUA 30 CM EMB IND PRINCESAS 10X1
Código: 38561 Fábrica: POLIBRAS Unidade: PT/10 F1 F4

UN: R\$ 2,05 AV: R\$ 20,54 15: R\$ 20,97
30: R\$ 21,39 45: R\$ 21,82 60: R\$ 22,26



REGUA 30 CM EMB IND RUBY GLOOM 10X1
Código: 38565 Fábrica: POLIBRAS Unidade: PT/10 F1 F4

UN: R\$ 3,24 AV: R\$ 3,24 15: R\$ 3,30
30: R\$ 3,37 45: R\$ 3,44 60: R\$ 3,51

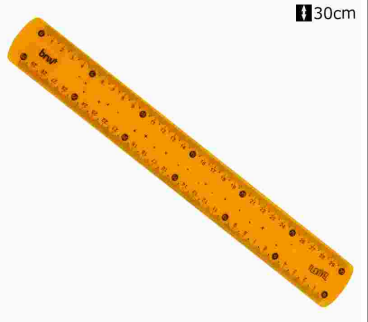

REGUA 30 CM FLEXIVEL COLOR 0001 UN
Código: 46844 Fábrica: BRW Unidade: UN/1 F1 F4

UN: R\$ 4,10 AV: R\$ 4,10 15: R\$ 4,18
30: R\$ 4,27 45: R\$ 4,35 60: R\$ 4,44

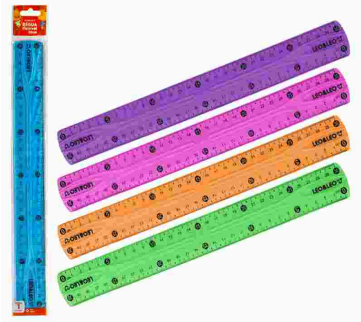

REGUA 30 CM FLEXIVEL COLOR 4365
Código: 50647 Fábrica: LEO&LEO Unidade: UN/1 F1 F4

UN: R\$ 6,16 AV: R\$ 61,62 15: R\$ 62,91
30: R\$ 64,16 45: R\$ 65,45 60: R\$ 66,76

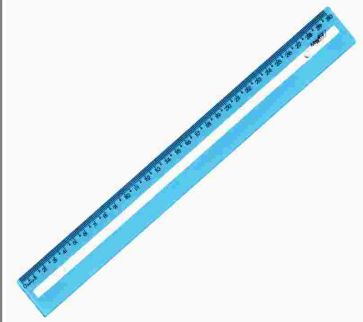

REGUA 30 CM GUIA LEITURA AZUL EMB IN10X1
Código: 50764 Fábrica: MAXCRIL Unidade: PT/10 F1 F4

UN: R\$ 6,15 AV: R\$ 6,15 15: R\$ 6,28
30: R\$ 6,41 45: R\$ 6,53 60: R\$ 6,67



REGUA 30 CM GUIA LEITURA AZUL UN

Código: 50766 Fábrica: MAXCRIL Unidade: UN/1
F1 F4

UN: R\$ 9,24 AV: R\$ 92,44 15: R\$ 94,36
30: R\$ 96,25 45: R\$ 98,18 60: R\$ 100,14



REGUA 30 CM METAL ACO INOX ESCALA 10X1

Código: 49943 Fábrica: BAZZE Unidade: CX/10
F1 F4

UN: R\$ 6,15 AV: R\$ 6,15 15: R\$ 6,28
30: R\$ 6,41 45: R\$ 6,53 60: R\$ 6,67

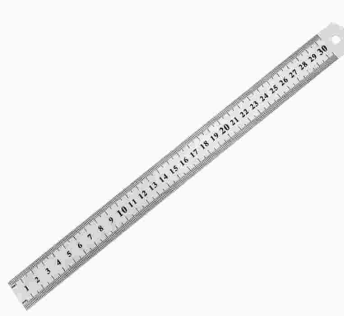

REGUA 30 CM METAL ACO INOX ESCALA 7403

Código: 46943 Fábrica: YIN'S PAPER Unidade: UN/1
F1 F4

UN: R\$ 2,82 AV: R\$ 28,25 15: R\$ 28,84
30: R\$ 29,41 45: R\$ 30,00 60: R\$ 30,60



REGUA 30 CM NEW LINE CRISTAL EMB IND10X1

Código: 35738 Fábrica: MAXCRI/WALEU Unidade: PT/10
F1 F4

UN: R\$ 2,82 AV: R\$ 2,82 15: R\$ 2,88
30: R\$ 2,94 45: R\$ 3,00 60: R\$ 3,06



REGUA 30 CM NEW LINE CRISTAL UN

Código: 18924 Fábrica: MAXCRIL Unidade: UN/1
F1 F4

UN: R\$ 2,25 AV: R\$ 2,25 15: R\$ 2,30
30: R\$ 2,34 45: R\$ 2,39 60: R\$ 2,44

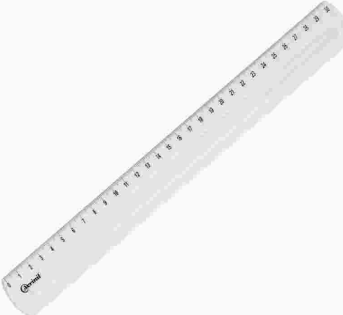

REGUA 30 CM PLAST CRISTAL 300

Código: 43219 Fábrica: ACRINIL Unidade: UN/1
F1 F4

UN: R\$ 2,35 AV: R\$ 2,35 15: R\$ 2,40
30: R\$ 2,45 45: R\$ 2,50 60: R\$ 2,55



REGUA 30 CM PLAST PRATA 305

Código: 43218 Fábrica: ACRINIL Unidade: UN/1
F1 F4

UN: R\$ 2,35 AV: R\$ 2,35 15: R\$ 2,40
30: R\$ 2,45 45: R\$ 2,50 60: R\$ 2,55



REGUA 30 CM PLAST PRETA 306

Código: 43217 Fábrica: ACRINIL Unidade: UN/1
F1 F4

UN: R\$ 2,35 AV: R\$ 2,35 15: R\$ 2,40
30: R\$ 2,45 45: R\$ 2,50 60: R\$ 2,55



REGUA 30 CM PLAST TRANSP FUME 301

Código: 43216 Fábrica: ACRINIL Unidade: UN/1
F1 F4

UN: R\$ 2,35 AV: R\$ 2,35 15: R\$ 2,40
30: R\$ 2,45 45: R\$ 2,50 60: R\$ 2,55



REGUA 30 CM PLAST TRANSP ROSA 3098

Código: 43212 Fábrica: ACRINIL Unidade: UN/1
F1 F4

UN: R\$ 2,35 AV: R\$ 2,35 15: R\$ 2,40
30: R\$ 2,45 45: R\$ 2,50 60: R\$ 2,55



REGUA 30 CM PLAST TRANSP VERDE 303

Código: 43214 Fábrica: ACRINIL Unidade: UN/1
F1 F4

UN: R\$ 2,35 AV: R\$ 2,35 15: R\$ 2,40
30: R\$ 2,45 45: R\$ 2,50 60: R\$ 2,55



REGUA 30 CM PLAST TRANSP VERMELHO 304

Código: 43213 Fábrica: ACRINIL Unidade: UN/1
F1 F4

UN: R\$ 3,25 AV: R\$ 32,51 15: R\$ 33,19
30: R\$ 33,85 45: R\$ 34,53 60: R\$ 35,22



REGUA 30 CM PRETO EMB IND 987.7 10X1

Código: 40886 Fábrica: ACRIMET Unidade: PT/10
F1 F4

UN: R\$ 3,25 AV: R\$ 32,51 15: R\$ 33,19
30: R\$ 33,85 45: R\$ 34,53 60: R\$ 35,22

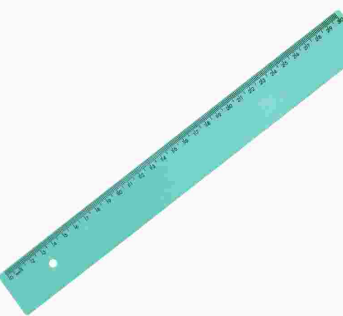

REGUA 30 CM VERDE EMB IND 987.4 10X1

Código: 40887 Fábrica: ACRIMET Unidade: PT/10
F1 F4

UN: R\$ 4,42 AV: R\$ 44,16 15: R\$ 45,08
30: R\$ 45,98 45: R\$ 46,90 60: R\$ 47,84

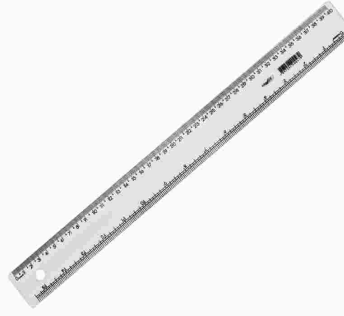

REGUA 40 CM CRISTAL SUPER 10X1

Código: 49200 Fábrica: MAXCRIL Unidade: PT/10
F1 F4

UN: R\$ 13,34 AV: R\$ 13,34 15: R\$ 13,62
30: R\$ 13,89 45: R\$ 14,17 60: R\$ 14,46



REGUA 50 CM ACR CRISTAL 515

Código: 43533 Fábrica: ACRIMET Unidade: UN/1
F1 F4

UN: R\$ 13,34 AV: R\$ 13,34 15: R\$ 13,62
30: R\$ 13,89 45: R\$ 14,17 60: R\$ 14,46



REGUA 50 CM ALUMINIO 10270125

Código: Fábrika: Unidade:
50762 MAXCRIL UN/1
F1 F4

UN: R\$ 17,45 AV: R\$ 17,45 15: R\$ 17,82
30: R\$ 18,17 45: R\$ 18,54 60: R\$ 18,91



REGUA 60 CM ACR CRISTAL 516

Código: Fábrika: Unidade:
43532 ACRIMET UN/1
F1 F4

UN: R\$ 20,53 AV: R\$ 20,53 15: R\$ 20,96
30: R\$ 21,38 45: R\$ 21,81 60: R\$ 22,24



REGUA 60 CM METAL ACO INOX 300

Código: Fábrika: Unidade:
45077 NYBC UN/1
F1 F4

UN: R\$ 0,84 AV: R\$ 41,88 15: R\$ 42,75
30: R\$ 43,60 45: R\$ 44,48 60: R\$ 45,37



RIFA GRANDE CTL C/50 NOMES 6011 50X1

Código: Fábrika: Unidade:
10299 TAMOIO PT/50
F1 F4

UN: R\$ 0,35 AV: R\$ 17,68 15: R\$ 18,05
30: R\$ 18,41 45: R\$ 18,78 60: R\$ 19,16



RIFA GRANDE CTL NUMEROS 1A100 6015 50X1

Código: Fábrika: Unidade:
37042 TAMOIO PT/50
F1 F4

UN: R\$ 7,03 AV: R\$ 35,13 15: R\$ 35,86
30: R\$ 36,58 45: R\$ 37,31 60: R\$ 38,06

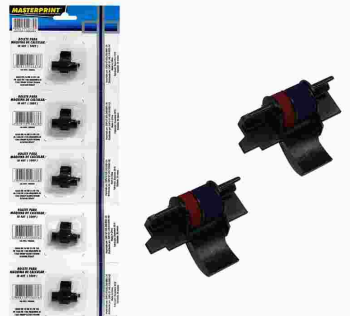

ROLETE BICOLOR P/MAQUINA CALCULAR 5X1

Código: Fábrika: Unidade:
38247 MASTERPRINT CR/5
F1 F4

UN: R\$ 12,32 AV: R\$ 12,32 15: R\$ 12,57
30: R\$ 12,82 45: R\$ 13,08 60: R\$ 13,34



ROLINHO MINI 3,5CM C/ESPUMA+4REFI 971950

Código: Fábrika: Unidade:
51102 CONDOR PT/1
F1 F4

UN: R\$ 25,67 AV: R\$ 25,67 15: R\$ 26,20
30: R\$ 26,73 45: R\$ 27,26 60: R\$ 27,81



SACO PAPEL KRAFT MIX 0,5 KG 500X1

Código: Fábrika: Unidade:
41443 SACOPEL PT/1
F1 F4

UN: R\$ 35,75 AV: R\$ 35,75 15: R\$ 36,49
30: R\$ 37,22 45: R\$ 37,97 60: R\$ 38,72



SACO PAPEL KRAFT MIX 1 KG 500X1

Código: Fábrika: Unidade:
41444 SACOPEL PT/1
F1 F4

UN: R\$ 0,26 AV: R\$ 128,40 15: R\$ 131,07
30: R\$ 133,70 45: R\$ 136,37 60: R\$ 139,10



SACO PAPEL KRAFT MIX 10 KG 500X1

Código: Fábrika: Unidade:
48668 SACOPEL PT/500
F1 F4

UN: R\$ 53,93 AV: R\$ 53,93 15: R\$ 55,05
30: R\$ 56,15 45: R\$ 57,28 60: R\$ 58,42



SACO PAPEL KRAFT MIX 2 KG 500X1

Código: Fábrika: Unidade:
46270 SACOPEL PT/1
F1 F4

UN: R\$ 0,24 AV: R\$ 118,13 15: R\$ 120,59
30: R\$ 123,00 45: R\$ 125,46 60: R\$ 127,97



SACO PAPEL KRAFT MIX 7,5 KG 500X1

Código: Fábrika: Unidade:
48667 SACOPEL PT/500
F1 F4

UN: R\$ 0,06 AV: R\$ 31,83 15: R\$ 32,50
30: R\$ 33,15 45: R\$ 33,81 60: R\$ 34,49

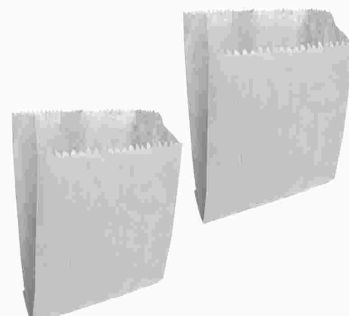

SACO PAPEL PIPOCA BRANCO 12X12CM 500X1

Código: Fábrika: Unidade:
47261 STRONG PT/500
F1 F4

UN: R\$ 17,45 AV: R\$ 17,45 15: R\$ 17,82
30: R\$ 18,17 45: R\$ 18,54 60: R\$ 18,91

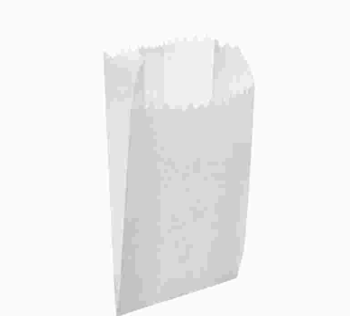

SACO PAPEL PIPOCA 2 7,5X12CM 500X1

Código: Fábrika: Unidade:
31026 STRONG PT/1
F1 F4

UN: R\$ 23,62 AV: R\$ 23,62 15: R\$ 24,11
30: R\$ 24,59 45: R\$ 25,08 60: R\$ 25,58

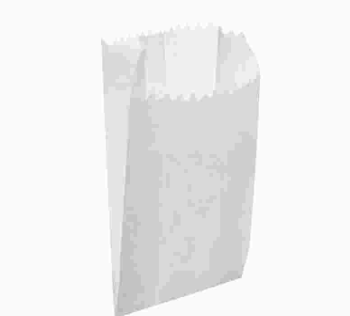

SACO PAPEL PIPOCA 3 7,5X15,5CM 500X1

Código: Fábrika: Unidade:
31027 STRONG PT/1
F1 F4

UN: R\$ 0,06 AV: R\$ 28,75 15: R\$ 29,35
30: R\$ 29,94 45: R\$ 30,54 60: R\$ 31,15

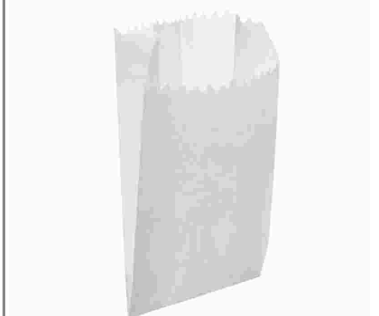

SACO PAPEL PIPOCA 4 7,5X17,5CM 500X1

Código: Fábrika: Unidade:
31651 STRONG PT/500
F1 F4

UN: R\$ 0,07 AV: R\$ 32,86 15: R\$ 33,54
30: R\$ 34,22 45: R\$ 34,90 60: R\$ 35,60



SACO PAPEL PIPOCA 5 10,5X15CM 500X1

Código: Fábrika: Unidade:
35938 STRONG PT/500
F1 F4

UN: R\$ 0,02 AV: R\$ 16,42 15: R\$ 16,77
30: R\$ 17,10 45: R\$ 17,44 60: R\$ 17,79



SACO PLAST 5X23CM CHUP CHUP 1000X1

Código: Fábrika: Unidade:
31028 SILVANI/KROM PT/1000
F1 F4

UN: R\$ 0,02 AV: R\$ 17,45 15: R\$ 17,82
30: R\$ 18,17 45: R\$ 18,54 60: R\$ 18,91



SACO PLAST 6X24CM CHUP CHUP 1000X1

Código: Fábrika: Unidade:
47892 SILVANI PT/1000
F1 F4

UN: R\$ 0,03 AV: R\$ 26,70 15: R\$ 27,25
30: R\$ 27,80 45: R\$ 28,35 60: R\$ 28,92



SACO PLAST 8X25CM P/TALHER 1000X1

Código: Fábrika: Unidade:
44378 KROMASA PT/1000
F1 F4

UN: R\$ 25,58 AV: R\$ 25,58 15: R\$ 26,11
30: R\$ 26,63 45: R\$ 27,17 60: R\$ 27,71



SACO PLAST BOB 16X30CM PICOTADO 500X1

Código: Fábrika: Unidade:
44295 ECO ROLL RL/1
F1 F4

UN: R\$ 0,37 AV: R\$ 36,97 15: R\$ 37,74
30: R\$ 38,49 45: R\$ 39,26 60: R\$ 40,05



SACO PLAST TRANSP 25X37CM 100X1

Código: Fábrika: Unidade:
41919 COPLAMIX PT/100
F1 F4

UN: R\$ 0,02 AV: R\$ 17,98 15: R\$ 18,35
30: R\$ 18,72 45: R\$ 19,09 60: R\$ 19,47



SACO PLAST 10X15CM TRANSP 1000X1

Código: Fábrika: Unidade:
47893 SILVANI PT/1000
F1 F4

UN: R\$ 0,03 AV: R\$ 25,94 15: R\$ 26,48
30: R\$ 27,01 45: R\$ 27,55 60: R\$ 28,10



SACO PLAST 12X18CM TRANSP 1000X1

Código: Fábrika: Unidade:
47894 SILVANI PT/1000
F1 F4

UN: R\$ 41,08 AV: R\$ 41,08 15: R\$ 41,93
30: R\$ 42,77 45: R\$ 43,63 60: R\$ 44,50



SACO PLAST 15X30CM TRANSP 05 1 KG

Código: Fábrika: Unidade:
48890 DIFFATTO KG/1
F1 F4

UN: R\$ 0,02 AV: R\$ 22,08 15: R\$ 22,54
30: R\$ 23,00 45: R\$ 23,46 60: R\$ 23,92



SACO PLAST 20X10CM HOT DOG 1000X1

Código: Fábrika: Unidade:
47896 SILVANI PT/1000
F1 F4

UN: R\$ 0,03 AV: R\$ 30,81 15: R\$ 31,45
30: R\$ 32,08 45: R\$ 32,72 60: R\$ 33,37



SACO PLAST 20X14CM HAMBURGER 1000X1

Código: Fábrika: Unidade:
47895 SILVANI PT/1000
F1 F4

UN: R\$ 0,03 AV: R\$ 15,40 15: R\$ 15,72
30: R\$ 16,03 45: R\$ 16,35 60: R\$ 16,68

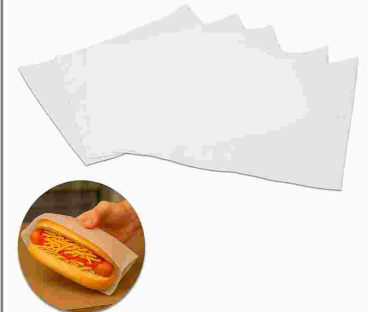

SACO PLAST 20X14CM HAMBURGUER 500X1

Código: Fábrika: Unidade:
46995 KROMASA PT/500
F1 F4

UN: R\$ 41,08 AV: R\$ 41,08 15: R\$ 41,93
30: R\$ 42,77 45: R\$ 43,63 60: R\$ 44,50



SACO PLAST 20X30CM 06 TRANSP 1KG

Código: Fábrika: Unidade:
46980 DIFFATTO KG/1
F1 F4

UN: R\$ 35,95 AV: R\$ 35,95 15: R\$ 36,70
30: R\$ 37,44 45: R\$ 38,18 60: R\$ 38,95



SACO PLAST 22X48CM 0,6 TRANSP KG

Código: Fábrika: Unidade:
45067 KROMASA KG/1
F1 F4

UN: R\$ 40,99 AV: R\$ 40,99 15: R\$ 41,84
30: R\$ 42,68 45: R\$ 43,53 60: R\$ 44,40



SACO PLAST 25X35CM TRANSP BOBINA PICOT

Código: Fábrika: Unidade:
44297 HIPERROLL RL/1
F1 F4

UN: R\$ 44,16 AV: R\$ 44,16 15: R\$ 45,08
30: R\$ 45,98 45: R\$ 46,90 60: R\$ 47,84



SACO PLAST 25X35CM TRANSP 06 1KG

Código: Fábrika: Unidade:
48895 DIFFATTO KG/1
F1 F4

UN: R\$ 41,08 AV: R\$ 41,08 15: R\$ 41,93
30: R\$ 42,77 45: R\$ 43,63 60: R\$ 44,50



SACO PLAST 30X40CM TRANSP 06 1KG

Código: Fábrica: Unidade:
48896 DIFFATTO KG/1
F1 F4

UN: R\$ 41,08 AV: R\$ 41,08 15: R\$ 41,93
30: R\$ 42,77 45: R\$ 43,63 60: R\$ 44,50

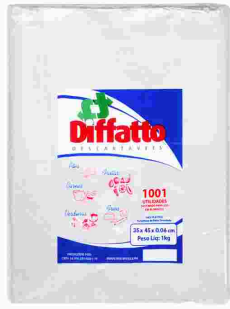

SACO PLAST 35X45CM 06 TRANSP 1 KG

Código: Fábrica: Unidade:
48897 DIFFATTO KG/1
F1 F4

UN: R\$ 41,08 AV: R\$ 41,08 15: R\$ 41,93
30: R\$ 42,77 45: R\$ 43,63 60: R\$ 44,50



SACO PLAST 40X60CM TRANSP 1 KG

Código: Fábrica: Unidade:
48898 DIFFATTO KG/1
F1 F4

UN: R\$ 0,36 AV: R\$ 35,95 15: R\$ 36,70
30: R\$ 37,44 45: R\$ 38,18 60: R\$ 38,95



SACO PLAST 40X60CM TRANSP 100X1

Código: Fábrica: Unidade:
31029 KROMASA PT/100
F1 F4

UN: R\$ 0,07 AV: R\$ 7,18 15: R\$ 7,33
30: R\$ 7,48 45: R\$ 7,63 60: R\$ 7,78



SACO PP 4X4X3CM AUTOCOLANTE 100X1

Código: Fábrica: Unidade:
26912 RDE PT/100
F1 F4

UN: R\$ 0,09 AV: R\$ 9,23 15: R\$ 9,43
30: R\$ 9,62 45: R\$ 9,81 60: R\$ 10,00



SACO PP 4X7X3CM AUTOCOLANTE 100X1

Código: Fábrica: Unidade:
26913 RDE PT/100
F1 F4

UN: R\$ 0,17 AV: R\$ 16,95 15: R\$ 17,30
30: R\$ 17,65 45: R\$ 18,00 60: R\$ 18,36



SACO PP 5X12X3CM AUTOCOLANTE 100X1

Código: Fábrica: Unidade:
26915 RDE PT/100
F1 F4

UN: R\$ 0,18 AV: R\$ 18,48 15: R\$ 18,86
30: R\$ 19,24 45: R\$ 19,63 60: R\$ 20,02



SACO PP 5X22X3CM AUTOCOLANTE 10X1

Código: Fábrica: Unidade:
34953 RDE PT/100
F1 F4

UN: R\$ 0,12 AV: R\$ 12,43 15: R\$ 12,69
30: R\$ 12,94 45: R\$ 13,20 60: R\$ 13,46



SACO PP 5X7X3CM AUTOCOLANTE 100X1

Código: Fábrica: Unidade:
26914 RDE PT/100
F1 F4

UN: R\$ 0,19 AV: R\$ 18,72 15: R\$ 19,11
30: R\$ 19,49 45: R\$ 19,88 60: R\$ 20,27



SACO PP 6X12X3CM AUTOCOLANTE 100X1

Código: Fábrica: Unidade:
26253 RDE PT/100
F1 F4

UN: R\$ 0,18 AV: R\$ 17,57 15: R\$ 17,93
30: R\$ 18,29 45: R\$ 18,66 60: R\$ 19,03



SACO PP 6,5X9X3CM AUTOCOLANTE 100X1

Código: Fábrica: Unidade:
26328 RDE PT/100
F1 F4

UN: R\$ 0,19 AV: R\$ 19,00 15: R\$ 19,40
30: R\$ 19,79 45: R\$ 20,18 60: R\$ 20,59



SACO PP 7X12X3CM AUTOCOLANTE 100X1

Código: Fábrica: Unidade:
32559 RDE PT/100
F1 F4

UN: R\$ 0,15 AV: R\$ 14,64 15: R\$ 14,94
30: R\$ 15,24 45: R\$ 15,55 60: R\$ 15,86



SACO PP 7X7X3CM AUTOCOLANTE 100X1

Código: Fábrica: Unidade:
26916 RDE PT/100
F1 F4

UN: R\$ 0,21 AV: R\$ 20,53 15: R\$ 20,96
30: R\$ 21,38 45: R\$ 21,81 60: R\$ 22,24



SACO PP 7,5X13CM AUTOCOLANTE 100X1

Código: Fábrica: Unidade:
23058 RDE PT/100
F1 F4

UN: R\$ 0,21 AV: R\$ 20,53 15: R\$ 20,96
30: R\$ 21,38 45: R\$ 21,81 60: R\$ 22,24



SACO PP 8X25X3CM AUTOCOLANTE 100X1

Código: Fábrica: Unidade:
26918 RDE PT/100
F1 F4

UN: R\$ 0,25 AV: R\$ 24,64 15: R\$ 25,16
30: R\$ 25,66 45: R\$ 26,17 60: R\$ 26,70



SACO PP 9X13X3CM AUTOCOLANTE 100X1

Código: Fábrica: Unidade:
26919 RDE PT/100
F1 F4

UN: R\$ 0,16 AV: R\$ 16,42 15: R\$ 16,77
30: R\$ 17,10 45: R\$ 17,44 60: R\$ 17,79



SACO PP 20X30CM TRANSP INCOLOR 100X1
Código: 48787 Fábrica: KROMASA Unidade: PT/100 F1 F4

UN: R\$ 0,27 AV: R\$ 13,34 15: R\$ 13,62
30: R\$ 13,89 45: R\$ 14,17 60: R\$ 14,46



SACO PP 20X30CM TRANSP INCOLOR 50X1
Código: 41970 Fábrica: NOVO TEMPO Unidade: PT/50 F1 F4

UN: R\$ 0,51 AV: R\$ 51,35 15: R\$ 52,42
30: R\$ 53,47 45: R\$ 54,54 60: R\$ 55,63



SACO PP 25X35X3CM AUTOCOLANTE 100X1
Código: 26924 Fábrica: CG PACK Unidade: PT/100 F1 F4

UN: R\$ 0,40 AV: R\$ 19,92 15: R\$ 20,33
30: R\$ 20,74 45: R\$ 21,15 60: R\$ 21,58



SACO PP 25X36CM TRANSP INCOLOR 50X1
Código: 31640 Fábrica: NOVO TEMPO Unidade: PT/50 F1 F4

UN: R\$ 0,66 AV: R\$ 16,42 15: R\$ 16,77
30: R\$ 17,10 45: R\$ 17,44 60: R\$ 17,79

44 cm
30 cm



SACO PP 30X44CM TRANSP INCOLOR 25X1
Código: 43582 Fábrica: CROMUS Unidade: PT/25 F1 F4

UN: R\$ 0,57 AV: R\$ 28,73 15: R\$ 29,33
30: R\$ 29,92 45: R\$ 30,51 60: R\$ 31,12



SACO PP 30X45CM TRANSP INCOLOR 50X1
Código: 33865 Fábrica: NOVO TEMPO Unidade: PT/50 F1 F4

UN: R\$ 0,82 AV: R\$ 40,83 15: R\$ 41,68
30: R\$ 42,52 45: R\$ 43,37 60: R\$ 44,23



SACO PP 35X54CM TRANSP INCOLOR 50X1
Código: 41158 Fábrica: NOVO TEMPO Unidade: PT/50 F1 F4

UN: R\$ 2,71 AV: R\$ 67,78 15: R\$ 69,20
30: R\$ 70,58 45: R\$ 71,99 60: R\$ 73,43



SACO PP 60X89CM TRANSP 25X1
Código: 33867 Fábrica: EMBALE Unidade: PT/25 F1 F4

UN: R\$ 2,10 AV: R\$ 52,59 15: R\$ 53,69
30: R\$ 54,76 45: R\$ 55,86 60: R\$ 56,97



SACO PP 60X90CM TRANSP 25X1
Código: 41159 Fábrica: CROMUS Unidade: PT/25 F1 F4

UN: R\$ 1,97 AV: R\$ 49,30 15: R\$ 50,32
30: R\$ 51,33 45: R\$ 52,36 60: R\$ 53,40



SACO PP 60X90CM TRANSP 25X1
Código: 41630 Fábrica: CG PACK Unidade: PT/25 F1 F4

UN: R\$ 1,31 AV: R\$ 32,87 15: R\$ 33,56
30: R\$ 34,23 45: R\$ 34,91 60: R\$ 35,61



SACO PP 70X89CM TRANSP 25X1
Código: 33868 Fábrica: EMBALE Unidade: PT/25 F1 F4

UN: R\$ 1,52 AV: R\$ 38,01 15: R\$ 38,80
30: R\$ 39,57 45: R\$ 40,37 60: R\$ 41,17



SACO PP 80X89CM TRANSP 25X1
Código: 33869 Fábrica: EMBALE Unidade: PT/25 F1 F4

UN: R\$ 1,74 AV: R\$ 17,36 15: R\$ 17,72
30: R\$ 18,08 45: R\$ 18,44 60: R\$ 18,81



SACO PRES 8X10CM VELUDO PRETO 10X1
Código: 36620 Fábrica: SOLIDER Unidade: PT/10 F1 F4

UN: R\$ 1,64 AV: R\$ 16,42 15: R\$ 16,77
30: R\$ 17,10 45: R\$ 17,44 60: R\$ 17,79



SACO PRES 8X10CM VELUDO VERMELHO 10X1
Código: 36595 Fábrica: SOLIDER Unidade: PT/10 F1 F4

UN: R\$ 8,39 AV: R\$ 8,39 15: R\$ 8,57
30: R\$ 8,74 45: R\$ 8,91 60: R\$ 9,09

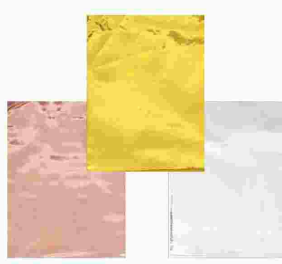

SACO PRES 8X8CM CASUAL AUT COLAN 100X1
Código: 44046 Fábrica: CROMUS Unidade: UN/1 F1 F4

UN: R\$ 3,79 AV: R\$ 3,79 15: R\$ 3,87
30: R\$ 3,95 45: R\$ 4,03 60: R\$ 4,11



SACO PRES 10X14CM FEM METAL 50X1
Código: 37676 Fábrica: VILLA PACK Unidade: UN/1 F1 F4

UN: R\$ 0,08 AV: R\$ 3,79 15: R\$ 3,87
30: R\$ 3,95 45: R\$ 4,03 60: R\$ 4,11



SACO PRES 10X14CM INF METAL 50X1

Código: Fábrica: Unidade:
37675 VILLA PACK PT/50
F1 F4

UN: R\$ 0,82 AV: R\$ 8,21 15: R\$ 8,38
30: R\$ 8,55 45: R\$ 8,72 60: R\$ 8,89



SACO PRES 10X15CM ORGANZA OURO 10X1

Código: Fábrica: Unidade:
36589 SOLIDER PT/10
F1 F4

UN: R\$ 0,82 AV: R\$ 8,21 15: R\$ 8,38
30: R\$ 8,55 45: R\$ 8,72 60: R\$ 8,89



SACO PRES 10X15CM ORGANZA PRATA 10X1

Código: Fábrica: Unidade:
36590 SOLIDER PT/10
F1 F4

UN: R\$ 0,08 AV: R\$ 4,10 15: R\$ 4,18
30: R\$ 4,27 45: R\$ 4,35 60: R\$ 4,44



SACO PRES 11X20CM FEM METAL 50X1

Código: Fábrica: Unidade:
33854 EMBALE PT/50
F1 F4

UN: R\$ 0,92 AV: R\$ 9,23 15: R\$ 9,43
30: R\$ 9,62 45: R\$ 9,81 60: R\$ 10,00

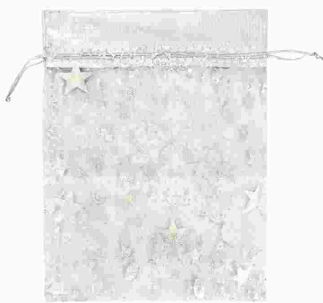

SACO PRES 15X18CM ORGANZA PRATA 10X1

Código: Fábrica: Unidade:
36602 SOLIDER PT/10
F1 F4

UN: R\$ 0,92 AV: R\$ 9,23 15: R\$ 9,43
30: R\$ 9,62 45: R\$ 9,81 60: R\$ 10,00



SACO PRES 15X18CM ORGANZA AZUL/DOUR 10X1

Código: Fábrica: Unidade:
36605 SOLIDER PT/10
F1 F4

UN: R\$ 0,92 AV: R\$ 9,23 15: R\$ 9,43
30: R\$ 9,62 45: R\$ 9,81 60: R\$ 10,00



SACO PRES 15X18CM ORGANZA DOURADO 10X1

Código: Fábrica: Unidade:
36606 SOLIDER PT/10
F1 F4

UN: R\$ 0,23 AV: R\$ 11,29 15: R\$ 11,52
30: R\$ 11,75 45: R\$ 11,99 60: R\$ 12,23



SACO PRES 15X22CM CAS VIBE SORT MET 50X1

Código: Fábrica: Unidade:
43565 CROMUS PT/50
F1 F4

UN: R\$ 0,23 AV: R\$ 11,29 15: R\$ 11,52
30: R\$ 11,75 45: R\$ 11,99 60: R\$ 12,23



SACO PRES 15X22CM CASUAL SORT 0037 50X1

Código: Fábrica: Unidade:
43568 CROMUS PT/50
F1 F4

UN: R\$ 0,17 AV: R\$ 8,52 15: R\$ 8,69
30: R\$ 8,87 45: R\$ 9,04 60: R\$ 9,23



SACO PRES 15X22CM INF METAL 50X1

Código: Fábrica: Unidade:
23419 VMP PT/50
F1 F4

UN: R\$ 0,25 AV: R\$ 12,32 15: R\$ 12,57
30: R\$ 12,82 45: R\$ 13,08 60: R\$ 13,34



SACO PRES 15X22CM LISO COLOR MET 50X1

Código: Fábrica: Unidade:
45794 CROMUS PT/50
F1 F4

UN: R\$ 0,21 AV: R\$ 10,26 15: R\$ 10,48
30: R\$ 10,69 45: R\$ 10,90 60: R\$ 11,12

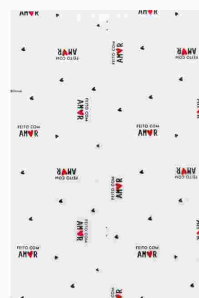

SACO PRES 15X22CM TRANSP STARS 50X1

Código: Fábrica: Unidade:
45795 GALA PT/50
F1 F4

UN: R\$ 0,37 AV: R\$ 18,39 15: R\$ 18,77
30: R\$ 19,15 45: R\$ 19,53 60: R\$ 19,92



SACO PRES 15X29CM BEBE MET/PER 50X1

Código: Fábrica: Unidade:
45798 CROMUS PT/50
F1 F4

UN: R\$ 0,33 AV: R\$ 16,42 15: R\$ 16,77
30: R\$ 17,10 45: R\$ 17,44 60: R\$ 17,79



SACO PRES 15X29CM CAS LISO COLO MET 50X1

Código: Fábrica: Unidade:
43570 CROMUS PT/50
F1 F4

UN: R\$ 0,29 AV: R\$ 14,37 15: R\$ 14,67
30: R\$ 14,96 45: R\$ 15,26 60: R\$ 15,57



SACO PRES 15X29CM CAS MET 50X1

Código: Fábrica: Unidade:
46190 GALA PT/50
F1 F4

UN: R\$ 0,31 AV: R\$ 15,40 15: R\$ 15,72
30: R\$ 16,03 45: R\$ 16,35 60: R\$ 16,68



SACO PRES 15X29CM CAS VIBE SORT MET 50X1

Código: Fábrica: Unidade:
43569 CROMUS PT/50
F1 F4

UN: R\$ 0,29 AV: R\$ 14,37 15: R\$ 14,67
30: R\$ 14,96 45: R\$ 15,26 60: R\$ 15,57

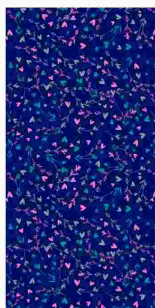

SACO PRES 15X29CM FEM MET 50X1
Código: 46189 Fábrica: GALA Unidade: PT/50 F1 F4

UN: R\$ 0,29 AV: R\$ 14,37 15: R\$ 14,67
30: R\$ 14,96 45: R\$ 15,26 60: R\$ 15,57



SACO PRES 15X29CM INF MET 50X1
Código: 46191 Fábrica: GALA Unidade: PT/50 F1 F4

UN: R\$ 0,37 AV: R\$ 18,39 15: R\$ 18,77
30: R\$ 19,15 45: R\$ 19,53 60: R\$ 19,92



SACO PRES 15X29CM JUV MET/PER 50X1
Código: 45797 Fábrica: CROMUS Unidade: PT/50 F1 F4

UN: R\$ 0,23 AV: R\$ 11,29 15: R\$ 11,52
30: R\$ 11,75 45: R\$ 11,99 60: R\$ 12,23



SACO PRES 15X30CM FEM METAL 50X1
Código: 27476 Fábrica: EMBALE Unidade: PT/50 F1 F4

UN: R\$ 0,51 AV: R\$ 25,62 15: R\$ 26,15
30: R\$ 26,68 45: R\$ 27,21 60: R\$ 27,75



SACO PRES 15X44CM LISO MET SORT 50X1
Código: 45804 Fábrica: CROMUS Unidade: PT/50 F1 F4

UN: R\$ 1,03 AV: R\$ 10,26 15: R\$ 10,48
30: R\$ 10,69 45: R\$ 10,90 60: R\$ 11,12

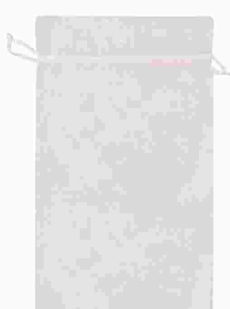

SACO PRES 17X30CM ORGANZA COLOR 10X1
Código: 36593 Fábrica: SOLIDER Unidade: PT/10 F1 F4

UN: R\$ 1,13 AV: R\$ 11,29 15: R\$ 11,52
30: R\$ 11,75 45: R\$ 11,99 60: R\$ 12,23



SACO PRES 18X25CM ORGANZA PRATA 10X1
Código: 36592 Fábrica: SOLIDER Unidade: PT/10 F1 F4

UN: R\$ 0,41 AV: R\$ 20,53 15: R\$ 20,96
30: R\$ 21,38 45: R\$ 21,81 60: R\$ 22,24



SACO PRES 20X29CM CASUAL METAL 50X1
Código: 27571 Fábrica: NOVO TEMPO Unidade: PT/50 F1 F4

UN: R\$ 0,51 AV: R\$ 25,54 15: R\$ 26,07
30: R\$ 26,59 45: R\$ 27,12 60: R\$ 27,66



SACO PRES 20X29CM FEM MET/PER 50X1
Código: 33568 Fábrica: GALA Unidade: PT/50 F1 F4

UN: R\$ 0,41 AV: R\$ 20,53 15: R\$ 20,96
30: R\$ 21,38 45: R\$ 21,81 60: R\$ 22,24



SACO PRES 20X30CM FEM METAL 50X1
Código: 30725 Fábrica: NOVO TEMPO Unidade: PT/50 F1 F4

UN: R\$ 0,41 AV: R\$ 20,53 15: R\$ 20,96
30: R\$ 21,38 45: R\$ 21,81 60: R\$ 22,24

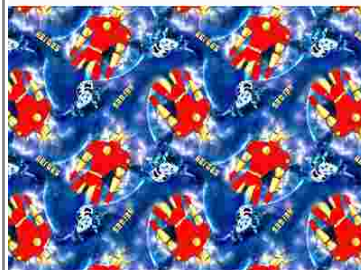

SACO PRES 20X30CM INF METAL 50X1
Código: 30722 Fábrica: VMP/NOVOTEMP Unidade: PT/50 F1 F4

UN: R\$ 0,41 AV: R\$ 20,53 15: R\$ 20,96
30: R\$ 21,38 45: R\$ 21,81 60: R\$ 22,24



SACO PRES 20X30CM LISO COLOR METAL 50X1
Código: 45803 Fábrica: NOVO TEMPO Unidade: PT/50 F1 F4

UN: R\$ 0,47 AV: R\$ 23,62 15: R\$ 24,11
30: R\$ 24,59 45: R\$ 25,08 60: R\$ 25,58



SACO PRES 20X30CM TRANSP ESTRELA AM 50X1
Código: 50021 Fábrica: MHP Unidade: PT/50 F1 F4

UN: R\$ 0,47 AV: R\$ 23,62 15: R\$ 24,11
30: R\$ 24,59 45: R\$ 25,08 60: R\$ 25,58

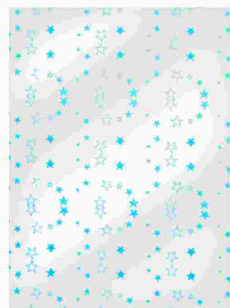

SACO PRES 20X30CM TRANSP ESTRELA AZ 50X1
Código: 50771 Fábrica: MHP Unidade: PT/50 F1 F4

UN: R\$ 0,47 AV: R\$ 23,62 15: R\$ 24,11
30: R\$ 24,59 45: R\$ 25,08 60: R\$ 25,58

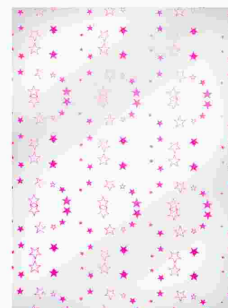

SACO PRES 20X30CM TRANSP ESTRELA RS 50X1
Código: 50025 Fábrica: MHP Unidade: PT/50 F1 F4

UN: R\$ 0,47 AV: R\$ 23,62 15: R\$ 24,11
30: R\$ 24,59 45: R\$ 25,08 60: R\$ 25,58

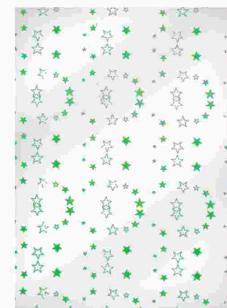

SACO PRES 20X30CM TRANSP ESTRELA VD 50X1
Código: 50026 Fábrica: MHP Unidade: PT/50 F1 F4

UN: R\$ 0,47 AV: R\$ 23,62 15: R\$ 24,11
30: R\$ 24,59 45: R\$ 25,08 60: R\$ 25,58

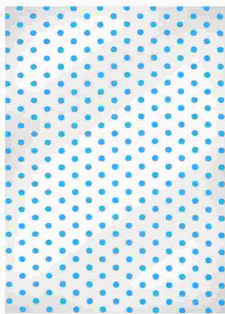

SACO PRES 20X30CM TRANSP POA AZ CL 50X1
Código: Fábrica: Unidade:
50022 MHP PT/50
F1 F4

UN: R\$ 0,47 AV: R\$ 23,62 15: R\$ 24,11
30: R\$ 24,59 45: R\$ 25,08 60: R\$ 25,58

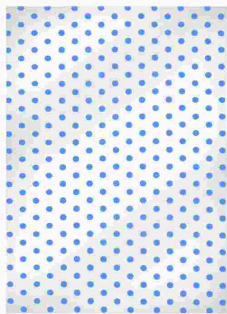

SACO PRES 20X30CM TRANSP POA AZ ES 50X1
Código: Fábrica: Unidade:
50023 MHP PT/50
F1 F4

UN: R\$ 0,47 AV: R\$ 23,62 15: R\$ 24,11
30: R\$ 24,59 45: R\$ 25,08 60: R\$ 25,58

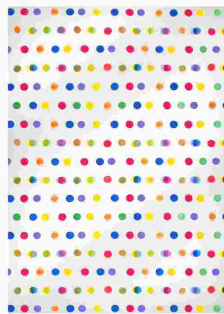

SACO PRES 20X30CM TRANSP POA COLOR 50X1
Código: Fábrica: Unidade:
50024 MHP PT/50
F1 F4

UN: R\$ 0,47 AV: R\$ 23,62 15: R\$ 24,11
30: R\$ 24,59 45: R\$ 25,08 60: R\$ 25,58

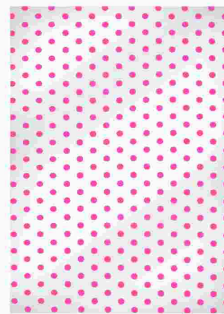

SACO PRES 20X30CM TRANSP POA ROSA 50X1
Código: Fábrica: Unidade:
50117 MHP PT/50
F1 F4

UN: R\$ 0,62 AV: R\$ 30,81 15: R\$ 31,45
30: R\$ 32,08 45: R\$ 32,72 60: R\$ 33,37

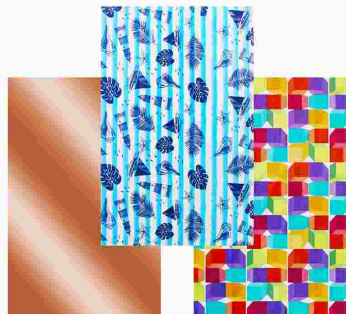

SACO PRES 25X36CM CAS METAL 50X1
Código: Fábrica: Unidade:
49675 NOVO TEMPO PT/50
F1 F4

UN: R\$ 0,62 AV: R\$ 30,81 15: R\$ 31,45
30: R\$ 32,08 45: R\$ 32,72 60: R\$ 33,37



SACO PRES 25X36CM FEM METAL 50X1
Código: Fábrica: Unidade:
27478 NOVO TEMPO PT/50
F1 F4

UN: R\$ 0,62 AV: R\$ 30,81 15: R\$ 31,45
30: R\$ 32,08 45: R\$ 32,72 60: R\$ 33,37



SACO PRES 25X36CM INF METAL 50X1
Código: Fábrica: Unidade:
30462 NOVO TEMPO PT/50
F1 F4

UN: R\$ 0,62 AV: R\$ 30,81 15: R\$ 31,45
30: R\$ 32,08 45: R\$ 32,72 60: R\$ 33,37



SACO PRES 25X36CM LISO COLOR METAL 50X1
Código: Fábrica: Unidade:
45805 NOVO TEMPO PT/50
F1 F4

UN: R\$ 0,44 AV: R\$ 22,03 15: R\$ 22,49
30: R\$ 22,94 45: R\$ 23,40 60: R\$ 23,87

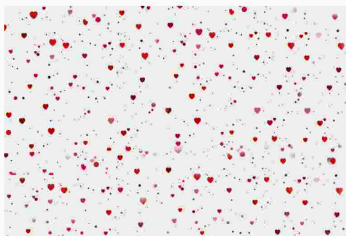

SACO PRES 25X36CM TRANSP DEC 50X1
Código: Fábrica: Unidade:
13129 NOVO TEMPO PT/50
F1 F4

UN: R\$ 0,76 AV: R\$ 38,00 15: R\$ 38,79
30: R\$ 39,56 45: R\$ 40,35 60: R\$ 41,16



SACO PRES 25X37CM SORT MET 50X1
Código: Fábrica: Unidade:
45806 CROMUS PT/50
F1 F4

UN: R\$ 0,62 AV: R\$ 30,81 15: R\$ 31,45
30: R\$ 32,08 45: R\$ 32,72 60: R\$ 33,37



SACO PRES 25X40CM COPA METAL 50X1
Código: Fábrica: Unidade:
39573 VMP PT/50
F1 F4

UN: R\$ 1,03 AV: R\$ 51,35 15: R\$ 52,42
30: R\$ 53,47 45: R\$ 54,54 60: R\$ 55,63

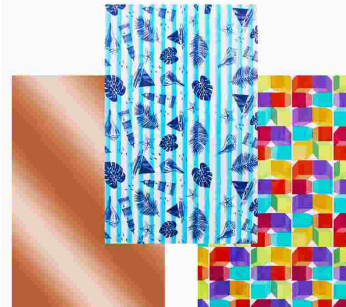

SACO PRES 30X45CM CAS METAL 50X1
Código: Fábrica: Unidade:
41633 NOVO TEMPO PT/50
F1 F4

UN: R\$ 1,03 AV: R\$ 51,35 15: R\$ 52,42
30: R\$ 53,47 45: R\$ 54,54 60: R\$ 55,63



SACO PRES 30X45CM FEM METAL 50X1
Código: Fábrica: Unidade:
22438 NOVO TEMPO PT/50
F1 F4

UN: R\$ 1,03 AV: R\$ 51,35 15: R\$ 52,42
30: R\$ 53,47 45: R\$ 54,54 60: R\$ 55,63



SACO PRES 30X45CM INF METAL 50X1
Código: Fábrica: Unidade:
22436 NOVO TEMPO PT/50
F1 F4

UN: R\$ 1,44 AV: R\$ 71,89 15: R\$ 73,39
30: R\$ 74,86 45: R\$ 76,36 60: R\$ 77,88

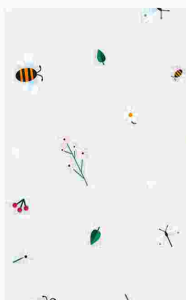

SACO PRES 35X53CM INF TRANSP 50X1
Código: Fábrica: Unidade:
46196 GALA PT/50
F1 F4

UN: R\$ 1,44 AV: R\$ 71,89 15: R\$ 73,39
30: R\$ 74,86 45: R\$ 76,36 60: R\$ 77,88



SACO PRES 35X53CM TRANSP STARS 50X1
Código: Fábrica: Unidade:
49670 GALA PT/50
F1 F4

UN: R\$ 1,50 AV: R\$ 74,98 15: R\$ 76,54
30: R\$ 78,07 45: R\$ 79,63 60: R\$ 81,22



SACO PRES 35X54CM BEBE MET/PER SORT 50X1

Código: 45812 Fábrica: CROMUS Unidade: PT/50 F1 F4

UN: R\$ 1,44 AV: R\$ 71,89 15: R\$ 73,39
30: R\$ 74,86 45: R\$ 76,36 60: R\$ 77,88



SACO PRES 35X54CM FEM MET 50X1

Código: 30052 Fábrica: NOVO TEMPO Unidade: PT/50 F1 F4

UN: R\$ 1,44 AV: R\$ 71,89 15: R\$ 73,39
30: R\$ 74,86 45: R\$ 76,36 60: R\$ 77,88



SACO PRES 35X54CM LISO COLOR METAL 50X1

Código: 45813 Fábrica: NOVO TEMPO Unidade: PT/50 F1 F4

UN: R\$ 1,44 AV: R\$ 71,89 15: R\$ 73,39
30: R\$ 74,86 45: R\$ 76,36 60: R\$ 77,88



SACO PRES 35X54CM NATAL METAL 50X1

Código: 40092 Fábrica: NOVO TEMPO Unidade: PT/50 F1 F4

UN: R\$ 1,46 AV: R\$ 72,93 15: R\$ 74,45
30: R\$ 75,94 45: R\$ 77,46 60: R\$ 79,01



SACO PRES 45X60CM FEM METAL 50X1

Código: 22437 Fábrica: VMP Unidade: PT/50 F1 F4

UN: R\$ 2,47 AV: R\$ 123,25 15: R\$ 125,82
30: R\$ 128,34 45: R\$ 130,90 60: R\$ 133,52



SACO PRES 50X69CM FEM MET 50X1

Código: 46199 Fábrica: GALA Unidade: PT/50 F1 F4

UN: R\$ 2,47 AV: R\$ 123,25 15: R\$ 125,82
30: R\$ 128,34 45: R\$ 130,90 60: R\$ 133,52



SACO PRES 50X69CM INF MET 50X1

Código: 46198 Fábrica: GALA Unidade: PT/50 F1 F4

UN: R\$ 3,45 AV: R\$ 86,27 15: R\$ 88,07
30: R\$ 89,83 45: R\$ 91,63 60: R\$ 93,46



SACO PRES 50X70CM DOURADO LISO MET 25X1

Código: 43797 Fábrica: CROMUS Unidade: PT/25 F1 F4

UN: R\$ 3,08 AV: R\$ 77,03 15: R\$ 78,63
30: R\$ 80,21 45: R\$ 81,81 60: R\$ 83,45



SACO PRES 50X70CM FEM FLORAL 25X1

Código: 44048 Fábrica: CROMUS Unidade: PT/25 F1 F4

UN: R\$ 3,29 AV: R\$ 82,17 15: R\$ 83,88
30: R\$ 85,56 45: R\$ 87,27 60: R\$ 89,01



SACO PRES 50X70CM FEM/ROM MET/PEROL 25X1

Código: 40111 Fábrica: CROMUS Unidade: PT/25 F1 F4

UN: R\$ 3,45 AV: R\$ 86,27 15: R\$ 88,07
30: R\$ 89,83 45: R\$ 91,63 60: R\$ 93,46

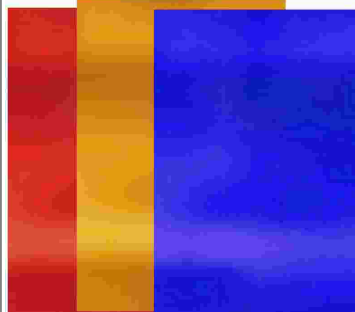

SACO PRES 50X70CM LISO SORT MET 25X1

Código: 40090 Fábrica: CROMUS Unidade: PT/25 F1 F4

UN: R\$ 3,38 AV: R\$ 84,61 15: R\$ 86,37
30: R\$ 88,10 45: R\$ 89,86 60: R\$ 91,66



SACO PRES 50X70CM POA MET 25X1

Código: 44999 Fábrica: CROMUS Unidade: PT/25 F1 F4

UN: R\$ 3,70 AV: R\$ 92,44 15: R\$ 94,36
30: R\$ 96,25 45: R\$ 98,18 60: R\$ 100,14



SACO PRES 50X70CM SORT MET 25X1

Código: 40112 Fábrica: CROMUS Unidade: PT/25 F1 F4

UN: R\$ 3,08 AV: R\$ 154,07 15: R\$ 157,28
30: R\$ 160,43 45: R\$ 163,63 60: R\$ 166,91

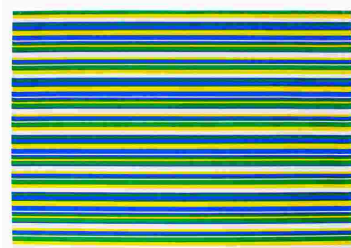

SACO PRES 50X74CM PRATA METAL 50X1

Código: 39575 Fábrica: VMP Unidade: PT/50 F1 F4

UN: R\$ 4,11 AV: R\$ 102,71 15: R\$ 104,85
30: R\$ 106,95 45: R\$ 109,09 60: R\$ 111,27

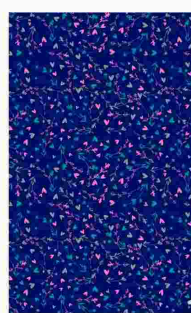

SACO PRES 58X89CM FEM MET 25X1

Código: 46192 Fábrica: GALA Unidade: PT/25 F1 F4

UN: R\$ 4,11 AV: R\$ 102,71 15: R\$ 104,85
30: R\$ 106,95 45: R\$ 109,09 60: R\$ 111,27



SACO PRES 58X89CM INF MET 25X1

Código: 46194 Fábrica: GALA Unidade: PT/25 F1 F4

UN: R\$ 4,11 AV: R\$ 102,71 15: R\$ 104,85
30: R\$ 106,95 45: R\$ 109,09 60: R\$ 111,27

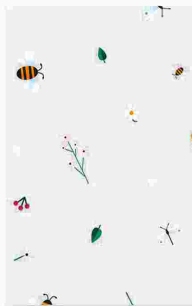

SACO PRES 58X89CM INF TRANSP 25X1
Código: Fábrika: Unidade:
46195 GALA PT/25
F1 F4

UN: R\$ 4,93 AV: R\$ 123,25 15: R\$ 125,82
30: R\$ 128,34 45: R\$ 130,90 60: R\$ 133,52



SACO PRES 60X90CM FEM MET 25X1
Código: Fábrika: Unidade:
40520 CROMUS PT/25
F1 F4

UN: R\$ 3,90 AV: R\$ 97,57 15: R\$ 99,61
30: R\$ 101,60 45: R\$ 103,63 60: R\$ 105,70



SACO PRES 60X90CM FEM METAL 25X1
Código: Fábrika: Unidade:
41628 CG PACK PT/25
F1 F4

UN: R\$ 4,11 AV: R\$ 102,71 15: R\$ 104,85
30: R\$ 106,95 45: R\$ 109,09 60: R\$ 111,27



SACO PRES 60X90CM FEM METAL 25X1
Código: Fábrika: Unidade:
40097 CROMUS PT/25
F1 F4

UN: R\$ 3,90 AV: R\$ 97,57 15: R\$ 99,61
30: R\$ 101,60 45: R\$ 103,63 60: R\$ 105,70



SACO PRES 60X90CM INF METAL 25X1
Código: Fábrika: Unidade:
42736 CG PACK PT/25
F1 F4

UN: R\$ 5,34 AV: R\$ 133,53 15: R\$ 136,31
30: R\$ 139,03 45: R\$ 141,81 60: R\$ 144,65

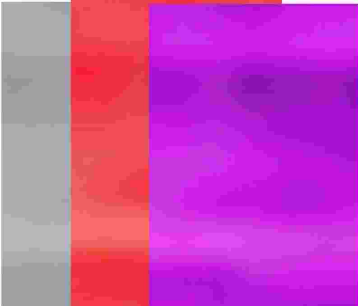

SACO PRES 60X90CM LISO SORT MET 25X1
Código: Fábrika: Unidade:
40095 CROMUS PT/25
F1 F4

UN: R\$ 4,93 AV: R\$ 123,25 15: R\$ 125,82
30: R\$ 128,34 45: R\$ 130,90 60: R\$ 133,52



SACO PRES 60X90CM SORT MET 25X1
Código: Fábrika: Unidade:
40521 CROMUS PT/25
F1 F4

UN: R\$ 9,86 AV: R\$ 246,52 15: R\$ 251,65
30: R\$ 256,69 45: R\$ 261,82 60: R\$ 267,06



SACO PRES 89X1,20M BEBE/INF/JUV MET 25X1
Código: Fábrika: Unidade:
45810 CROMUS PT/25
F1 F4

UN: R\$ 9,86 AV: R\$ 246,52 15: R\$ 251,65
30: R\$ 256,69 45: R\$ 261,82 60: R\$ 267,06



SACO PRES 89X1,20M FEM METAL 25X1
Código: Fábrika: Unidade:
21047 CROMUS PT/25
F1 F4

UN: R\$ 9,04 AV: R\$ 225,97 15: R\$ 230,68
30: R\$ 235,30 45: R\$ 240,00 60: R\$ 244,80



SACO PRES 90X1,18M CASUAL METAL 25X1
Código: Fábrika: Unidade:
42734 CG PACK PT/25
F1 F4

UN: R\$ 2,98 AV: R\$ 2,98 15: R\$ 3,04
30: R\$ 3,10 45: R\$ 3,16 60: R\$ 3,23



SACO TNT LISO 25X35CM UN
Código: Fábrika: Unidade:
46749 ALINE UN/1
F1 F4

UN: R\$ 1,13 AV: R\$ 11,29 15: R\$ 11,52
30: R\$ 11,75 45: R\$ 11,99 60: R\$ 12,23



SACOLA KRAFT 13,5X8X16CM 1116 10X1
Código: Fábrika: Unidade:
41684 SCRITY PT/10
F1 F4

UN: R\$ 2,89 AV: R\$ 34,67 15: R\$ 35,39
30: R\$ 36,10 45: R\$ 36,82 60: R\$ 37,56



SACOLA PAP PRES 18X23CM FITA 625 12X1
Código: Fábrika: Unidade:
45951 WINMAX PT/12
F1 F4

UN: R\$ 10,29 AV: R\$ 123,47 15: R\$ 126,04
30: R\$ 128,56 45: R\$ 131,13 60: R\$ 133,76



SACOLA PAP PRES 26X32CM FITA 626 12X1
Código: Fábrika: Unidade:
45953 WINMAX PT/12
F1 F4

UN: R\$ 12,75 AV: R\$ 152,95 15: R\$ 156,14
30: R\$ 159,26 45: R\$ 162,44 60: R\$ 165,69



SACOLA PAP PRES 30X41,5CM FITA 627 12X1
Código: Fábrika: Unidade:
45954 WINMAX PT/12
F1 F4

UN: R\$ 251,66 AV: R\$ 251,66 15: R\$ 256,91
30: R\$ 262,05 45: R\$ 267,29 60: R\$ 272,63



SELADORA MESA P/PLASTICO 30CM L 110V
Código: Fábrika: Unidade:
32225 BRASQUENT UN/1
F1 F4

UN: R\$ 0,41 AV: R\$ 10,27 15: R\$ 10,49
30: R\$ 10,70 45: R\$ 10,91 60: R\$ 11,13



STENCIL ROXO 25X1

Código: 4302 Fábrica: FRANKLIN Unidade: C//25 F1 F4

UN: R\$ 22,59 AV: R\$ 22,59 15: R\$ 23,06
30: R\$ 23,52 45: R\$ 23,99 60: R\$ 24,47



SUPORTE DISPLAY DE PAREDE A4/OF 227

Código: 50156 Fábrica: ACRINIL Unidade: UN/1 F1 F4

UN: R\$ 25,67 AV: R\$ 25,67 15: R\$ 26,20
30: R\$ 26,73 45: R\$ 27,26 60: R\$ 27,81



SUPORTE FITA ADESIVA GDE PRETO 526

Código: 41802 Fábrica: CARBRINK Unidade: UN/1 F1 F4

UN: R\$ 52,24 AV: R\$ 52,24 15: R\$ 53,32
30: R\$ 54,39 45: R\$ 55,48 60: R\$ 56,59



SUPORTE FITA ADESIVA GDE 19,5CM PRETO

Código: 38255 Fábrica: MAXCRIL Unidade: CX/1 F1 F4

UN: R\$ 23,21 AV: R\$ 23,21 15: R\$ 23,69
30: R\$ 24,17 45: R\$ 24,65 60: R\$ 25,14



SUPORTE FITA ADESIVA PEQ 12CM AZUL 1011



Código: 44058 Fábrica: MAXCRIL Unidade: CX/1 F1 F4

UN: R\$ 23,21 AV: R\$ 23,21 15: R\$ 23,69
30: R\$ 24,17 45: R\$ 24,65 60: R\$ 25,14



SUPORTE FITA ADESIVA PEQ 12CM PRETO 1009



Código: 50760 Fábrica: MAXCRIL Unidade: CX/1 F1 F4

UN: R\$ 35,94 AV: R\$ 35,94 15: R\$ 36,69
30: R\$ 37,42 45: R\$ 38,17 60: R\$ 38,94



SUPORTE METAL FITA LACRADORA 901



Código: 39786 Fábrica: MASTERPRINT Unidade: UN/1 F1 F4

UN: R\$ 132,51 AV: R\$ 132,51 15: R\$ 135,27
30: R\$ 137,97 45: R\$ 140,73 60: R\$ 143,55



SUPORTE P/BOBINA 40CM

Código: 33499 Fábrica: STALO Unidade: UN/1 F1 F4

UN: R\$ 362,93 AV: R\$ 362,93 15: R\$ 370,49
30: R\$ 377,90 45: R\$ 385,46 60: R\$ 393,17



SUPORTE P/BOBINA 60CM

Código: 33500 Fábrica: SAO JOAO Unidade: UN/1 F1 F4

UN: R\$ 1,90 AV: R\$ 1,90 15: R\$ 1,94
30: R\$ 1,98 45: R\$ 2,02 60: R\$ 2,06



TABELA PERIODICA ATUALIZADA

Código: 48482 Fábrica: BRASILEITURA Unidade: UN/1 F1 F4

UN: R\$ 2,05 AV: R\$ 61,60 15: R\$ 62,88
30: R\$ 64,14 45: R\$ 65,43 60: R\$ 66,73

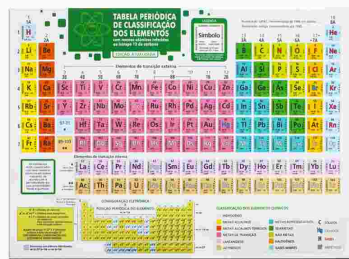

TABUADA COMPLETA 10X15CM 16 PAG 30X1

Código: 29636 Fábrica: PARRKE Unidade: PT/30 F1 F4

UN: R\$ 3,69 AV: R\$ 73,84 15: R\$ 75,38
30: R\$ 76,89 45: R\$ 78,43 60: R\$ 80,00



TALAO COMANDO 2 CORPOS NUM 100FLS 20X1

Código: 17966 Fábrica: PARRKE Unidade: PT/20 F1 F4

UN: R\$ 20,76 AV: R\$ 103,79 15: R\$ 105,96
30: R\$ 108,07 45: R\$ 110,23 60: R\$ 112,44



TALAO CONTRATO LOCAÇÃO 100FLS 5X1

Código: 12553 Fábrica: PARRKE Unidade: PT/5 F1 F4

UN: R\$ 10,55 AV: R\$ 52,73 15: R\$ 53,83
30: R\$ 54,90 45: R\$ 56,00 60: R\$ 57,12



TALAO MOVIMENTO CX 100FLS PEQ 5X1

Código: 14431 Fábrica: PARRKE Unidade: PT/5 F1 F4

UN: R\$ 16,43 AV: R\$ 82,17 15: R\$ 83,88
30: R\$ 85,56 45: R\$ 87,27 60: R\$ 89,01



TALAO MOVIMENTO CX 100FLS 215X315MM 5X1

Código: 14432 Fábrica: PARRKE Unidade: PT/5 F1 F4

UN: R\$ 2,12 AV: R\$ 42,43 15: R\$ 43,31
30: R\$ 44,18 45: R\$ 45,06 60: R\$ 45,97



TALAO NOTA NEUTRA 1/36 C/CÓPIA 25X2 20X1

Código: 17123 Fábrica: PARRKE Unidade: PT/20 F1 F4

UN: R\$ 2,12 AV: R\$ 42,43 15: R\$ 43,31
30: R\$ 44,18 45: R\$ 45,06 60: R\$ 45,97



TALAO NOTA NEUTRA 1/36 S/COP 50FLS 20X1

Código: Fábrica: Unidade:
17512 PARRKE PT/20
F1 F4

UN: R\$ 1,54 AV: R\$ 30,81 15: R\$ 31,45
30: R\$ 32,08 45: R\$ 32,72 60: R\$ 33,37



TALAO NOTA PROMISSORIA MINI 50 FLS 20X1

Código: Fábrica: Unidade:
12551 PARRKE PT/20
F1 F4

UN: R\$ 2,77 AV: R\$ 55,43 15: R\$ 56,58
30: R\$ 57,72 45: R\$ 58,87 60: R\$ 60,05



TALAO NOTA PROMISSORIA 50FLS 20X1

Código: Fábrica: Unidade:
12550 PARRKE PT/20
F1 F4

UN: R\$ 2,18 AV: R\$ 43,63 15: R\$ 44,54
30: R\$ 45,43 45: R\$ 46,34 60: R\$ 47,27

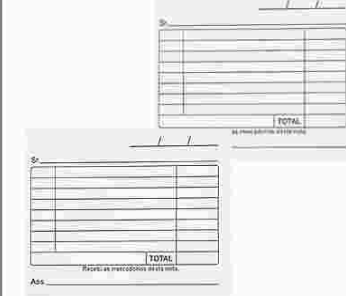

TALAO NOTINHA 1/72 100FLS 7,5X10,5 20X1

Código: Fábrica: Unidade:
17965 PARRKE PT/20
F1 F4

UN: R\$ 4,21 AV: R\$ 84,20 15: R\$ 85,95
30: R\$ 87,67 45: R\$ 89,43 60: R\$ 91,22



TALAO PEDIDO 1/18 25X2 FL 15X21 C/C 20X1

Código: Fábrica: Unidade:
12546 PARRKE PT/20
F1 F4

UN: R\$ 4,21 AV: R\$ 84,20 15: R\$ 85,95
30: R\$ 87,67 45: R\$ 89,43 60: R\$ 91,22



TALAO PEDIDO 1/18 50FLS 15X21 S/C 20X1

Código: Fábrica: Unidade:
19007 PARRKE PT/20
F1 F4

UN: R\$ 8,14 AV: R\$ 81,38 15: R\$ 83,08
30: R\$ 84,74 45: R\$ 86,43 60: R\$ 88,16



TALAO PEDIDO 1/9 S/COPIA 50FLS 10X1

Código: Fábrica: Unidade:
12549 PARRKE PT/10
F1 F4

UN: R\$ 7,49 AV: R\$ 74,91 15: R\$ 76,47
30: R\$ 77,99 45: R\$ 79,55 60: R\$ 81,15



TALAO PEDIDO 1/9 25X2 210X310MM 10X1

Código: Fábrica: Unidade:
12548 PARRKE PT/10
F1 F4

UN: R\$ 2,89 AV: R\$ 57,79 15: R\$ 58,99
30: R\$ 60,17 45: R\$ 61,38 60: R\$ 62,60



TALAO RECIBO ALUGUEL 50FLS C/CANHOTO 20X1

Código: Fábrica: Unidade:
14420 PARRKE PT/20
F1 F4

UN: R\$ 2,80 AV: R\$ 56,03 15: R\$ 57,20
30: R\$ 58,34 45: R\$ 59,51 60: R\$ 60,70



TALAO RECIBO COMERCIAL C/CANH 50FLS 20X1

Código: Fábrica: Unidade:
6136 PARRKE PT/20
F1 F4

UN: R\$ 2,18 AV: R\$ 43,63 15: R\$ 44,54
30: R\$ 45,43 45: R\$ 46,34 60: R\$ 47,27



TALAO RECIBO COMERCIAL S/CANH 50FLS 20X1

Código: Fábrica: Unidade:
12552 PARRKE PT/20
F1 F4

UN: R\$ 1,89 AV: R\$ 37,74 15: R\$ 38,52
30: R\$ 39,29 45: R\$ 40,08 60: R\$ 40,88



TALAO RECIBO CONDOMINIO C/CANH 50FL 50X1

Código: Fábrica: Unidade:
14421 PARRKE PT/20
F1 F4

UN: R\$ 2,89 AV: R\$ 57,79 15: R\$ 58,99
30: R\$ 60,17 45: R\$ 61,38 60: R\$ 62,60



TALAO RECIBO PGTO EMPREG DOMEST 50FLS

Código: Fábrica: Unidade:
14419 PARRKE PT/20
F1 F4

UN: R\$ 3,08 AV: R\$ 61,63 15: R\$ 62,92
30: R\$ 64,17 45: R\$ 65,46 60: R\$ 66,77



TALAO RECIBO SALARIOS OUTR PROV 50F 20X1

Código: Fábrica: Unidade:
14422 MINASPEL PT/20
F1 F4

UN: R\$ 3,18 AV: R\$ 31,82 15: R\$ 32,49
30: R\$ 33,14 45: R\$ 33,80 60: R\$ 34,48



TALAO TRANSF VEICULO DOC DE CADAST DET

Código: Fábrica: Unidade:
14430 PARRKE PT/10
F1 F4

UN: R\$ 0,61 AV: R\$ 12,11 15: R\$ 12,50
30: R\$ 12,87 45: R\$ 13,26 60: R\$ 13,66



TALAO VALE C/CANHOTO 50 FLS 20X1

Código: Fábrica: Unidade:
14417 PARRKE PT/20
F1 F4

UN: R\$ 1,13 AV: R\$ 11,30 15: R\$ 11,53
30: R\$ 11,77 45: R\$ 12,00 60: R\$ 12,24



TALAO VALE S/CANHOTO C/AZUREE 50FLS 10X1

Código: Fábrica: Unidade:
6138 SAO DOMINGOS PT/10
F1 F4

UN: R\$ 1,05 AV: R\$ 21,06 15: R\$ 21,50
30: R\$ 21,93 45: R\$ 22,36 60: R\$ 22,81



TALAO VALE S/CANHOTO 50FLS 20X1

Código: Fábrica: Unidade:
12545 PARRKE PT/20
F1 F4

UN: R\$ 44,16 AV: R\$ 44,16 15: R\$ 45,08
30: R\$ 45,98 45: R\$ 46,90 60: R\$ 47,84



TECLADO USB DESIGN A PROVA D'ÁGUA 74327

Código: Fábrica: Unidade:
35800 LETRON UN/1
F1 F4

UN: R\$ 513,59 AV: R\$ 513,59 15: R\$ 524,29
30: R\$ 534,78 45: R\$ 545,47 60: R\$ 556,38



TELA JUTA ABERTA P9 1000MM 25MTS

Código: Fábrica: Unidade:
42029 PLAST CO RL/1
F1 F4

UN: R\$ 22,58 AV: R\$ 1128,89 15: R\$ 1152,41
30: R\$ 1175,46 45: R\$ 1198,97 60: R\$ 1222,95



TELA JUTA NATURAL P9 50MTS

Código: Fábrica: Unidade:
50951 ABL RL/50
F1 F4

UN: R\$ 9,54 AV: R\$ 9,54 15: R\$ 9,74
30: R\$ 9,94 45: R\$ 10,14 60: R\$ 10,34



TELA PINTURA C/CHASSI MDF 16X22CM 001

Código: Fábrica: Unidade:
46319 PAPER TOYS UN/1
F1 F4

UN: R\$ 17,04 AV: R\$ 17,04 15: R\$ 17,40
30: R\$ 17,74 45: R\$ 18,10 60: R\$ 18,46



TELA PINTURA C/CHASSI MDF 30X30CM 004

Código: Fábrica: Unidade:
46316 PAPER TOYS UN/1
F1 F4

UN: R\$ 19,99 AV: R\$ 19,99 15: R\$ 20,41
30: R\$ 20,81 45: R\$ 21,23 60: R\$ 21,65



TELA PINTURA C/CHASSI MDF 30X40CM 005

Código: Fábrica: Unidade:
46315 PAPER TOYS UN/1
F1 F4

UN: R\$ 28,84 AV: R\$ 28,84 15: R\$ 29,44
30: R\$ 30,03 45: R\$ 30,63 60: R\$ 31,25

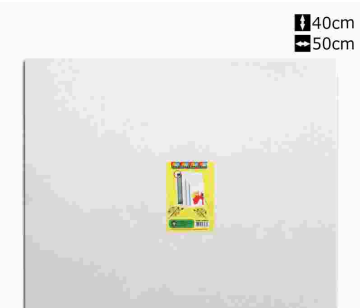

TELA PINTURA C/CHASSI MDF 40X50CM 006

Código: Fábrica: Unidade:
46314 PAPER TOYS UN/1
F1 F4

UN: R\$ 8,93 AV: R\$ 8,93 15: R\$ 9,11
30: R\$ 9,29 45: R\$ 9,48 60: R\$ 9,67



TELA P/PINTURA 15X22CM 4758

Código: Fábrica: Unidade:
49326 STALO UN/1
F1 F4

UN: R\$ 10,02 AV: R\$ 10,02 15: R\$ 10,22
30: R\$ 10,43 45: R\$ 10,64 60: R\$ 10,85



TELA P/PINTURA 18X24CM 4818

Código: Fábrica: Unidade:
50775 STALO UN/1
F1 F4

UN: R\$ 11,29 AV: R\$ 11,29 15: R\$ 11,52
30: R\$ 11,75 45: R\$ 11,99 60: R\$ 12,23



TELA P/PINTURA 20X20CM 4760/8626

Código: Fábrica: Unidade:
49327 STALO UN/1
F1 F4

UN: R\$ 15,40 AV: R\$ 15,40 15: R\$ 15,72
30: R\$ 16,03 45: R\$ 16,35 60: R\$ 16,68



TELA P/PINTURA 20X29CM PAPEL 010060

Código: Fábrica: Unidade:
47885 RIDET UN/1
F1 F4

UN: R\$ 12,68 AV: R\$ 12,68 15: R\$ 12,94
30: R\$ 13,20 45: R\$ 13,46 60: R\$ 13,73



TELA P/PINTURA 20X30CM 8167/8604

Código: Fábrica: Unidade:
45634 STALO UN/1
F1 F4

UN: R\$ 15,36 AV: R\$ 15,36 15: R\$ 15,68
30: R\$ 15,99 45: R\$ 16,31 60: R\$ 16,64



TELA P/PINTURA 30X30CM 8627

Código: Fábrica: Unidade:
49328 CORTIARTE UN/1
F1 F4

UN: R\$ 17,80 AV: R\$ 17,80 15: R\$ 18,17
30: R\$ 18,54 45: R\$ 18,91 60: R\$ 19,28



TELA P/PINTURA 30X40CM 8606

Código: Fábrica: Unidade:
49329 CORTIARTE UN/1
F1 F4

UN: R\$ 55,93 AV: R\$ 55,93 15: R\$ 57,10
30: R\$ 58,24 45: R\$ 59,40 60: R\$ 60,59



TELA P/PINTURA 50X70CM 8627/9584

Código: Fábrica: Unidade:
50149 STALO/CORTIA UN/1
F1 F4

UN: R\$ 10,98 AV: R\$ 10,98 15: R\$ 11,21
30: R\$ 11,43 45: R\$ 11,66 60: R\$ 11,90



TERMOLINA LEITOSA 100 ML 16510

Código: Fábrica: Unidade:
44820 ACRILEX UN/1
F1 F4

UN: R\$ 22,08 AV: R\$ 22,08 15: R\$ 22,54
30: R\$ 23,00 45: R\$ 23,46 60: R\$ 23,92



TERMOLINA LEITOSA 250 ML 16525

Código: Fábrica: Unidade:
44817 ACRILEX UN/1
F1 F4

UN: R\$ 59,57 AV: R\$ 59,57 15: R\$ 60,81
30: R\$ 62,02 45: R\$ 63,27 60: R\$ 64,53



TERMOLINA LEITOSA 500 ML

Código: Fábrica: Unidade:
47876 ACRILEX UN/1
F1 F4

UN: R\$ 2,25 AV: R\$ 26,99 15: R\$ 27,56
30: R\$ 28,11 45: R\$ 28,67 60: R\$ 29,24



TESOURA ESC ACO GALV 13CM 2199 CTL 12X1

Código: Fábrica: Unidade:
44118 PLANETA CR/12
F1 F4

UN: R\$ 2,74 AV: R\$ 164,34 15: R\$ 167,77
30: R\$ 171,12 45: R\$ 174,54 60: R\$ 178,03



TESOURA ESC CB PLAST PTO 13CM 4195 60X1

Código: Fábrica: Unidade:
45228 LEO&LEO CX/60
F1 F4

UN: R\$ 6,15 AV: R\$ 6,15 15: R\$ 6,28
30: R\$ 6,41 45: R\$ 6,53 60: R\$ 6,67



TESOURA ESC INOX S/PON CB PRETO CTL 4592

Código: Fábrica: Unidade:
24963 LEO&LEO CR/1
F1 F4

UN: R\$ 3,42 AV: R\$ 82,17 15: R\$ 83,88
30: R\$ 85,56 45: R\$ 87,27 60: R\$ 89,01



TESOURA ESC INOX 13CM BLACK EMB IND 24X1

Código: Fábrica: Unidade:
40917 LEO&LEO CX/24
F1 F4

UN: R\$ 3,85 AV: R\$ 92,44 15: R\$ 94,36
30: R\$ 96,25 45: R\$ 98,18 60: R\$ 100,14



TESOURA ESC INOX 13CM CLUB COLOR 24X1

Código: Fábrica: Unidade:
48318 BAZZE CX/24
F1 F4

UN: R\$ 3,24 AV: R\$ 3,24 15: R\$ 3,30
30: R\$ 3,37 45: R\$ 3,44 60: R\$ 3,51



TESOURA ESC 13CM CAB PLAST PONTA RED SOL

Código: Fábrica: Unidade:
48594 WIN PAPER UN/1
F1 F4

UN: R\$ 3,00 AV: R\$ 71,89 15: R\$ 73,39
30: R\$ 74,86 45: R\$ 76,36 60: R\$ 77,88



TESOURA ESC 13CM CB COLOR 501 24X1

Código: Fábrica: Unidade:
42239 MASTERPRINT CX/24
F1 F4

UN: R\$ 3,00 AV: R\$ 71,89 15: R\$ 73,39
30: R\$ 74,86 45: R\$ 76,36 60: R\$ 77,88



TESOURA ESC 13CM CB COLOR 503 24X1

Código: Fábrica: Unidade:
51050 MASTERPRINT CX/24
F1 F4

UN: R\$ 3,25 AV: R\$ 195,16 15: R\$ 199,22
30: R\$ 203,21 45: R\$ 207,27 60: R\$ 211,42



TESOURA ESC 13CM CB PLAST 103 60X1

Código: Fábrica: Unidade:
42456 GATTE CX/60
F1 F4

UN: R\$ 3,00 AV: R\$ 71,89 15: R\$ 73,39
30: R\$ 74,86 45: R\$ 76,36 60: R\$ 77,88



TESOURA ESC 13CM CB PRETO 502 24X1

Código: Fábrica: Unidade:
42238 MASTERPRINT CX/24
F1 F4

UN: R\$ 5,64 AV: R\$ 5,64 15: R\$ 5,76
30: R\$ 5,87 45: R\$ 5,99 60: R\$ 6,11



TESOURA ESC 13CM PIC CORTE CRIATIV 15127

Código: Fábrica: Unidade:
33752 WIN PAPER UN/1
F1 F4

UN: R\$ 4,10 AV: R\$ 4,10 15: R\$ 4,18
30: R\$ 4,27 45: R\$ 4,35 60: R\$ 4,44



TESOURA ESC 16,5CM 6,5" CB PLAST 13717

Código: Fábrica: Unidade:
41446 MABEL UN/1
F1 F4

UN: R\$ 8,21 AV: R\$ 8,21 15: R\$ 8,38
30: R\$ 8,55 45: R\$ 8,72 60: R\$ 8,89



TESOURA INOX ESC COLOR 11,5CM 167M

Código: 44099 Fábrica: MUNDIAL Unidade: UN/1 F1 F4

UN: R\$ 8,21 AV: R\$ 8,21 15: R\$ 8,38
30: R\$ 8,55 45: R\$ 8,72 60: R\$ 8,89



TESOURA INOX ESC PRETA 11,5CM 167BK

Código: 44100 Fábrica: MUNDIAL Unidade: UN/1 F1 F4

UN: R\$ 4,71 AV: R\$ 4,71 15: R\$ 4,81
30: R\$ 4,91 45: R\$ 5,01 60: R\$ 5,11

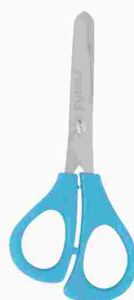

TESOURA INOX ESCOLAR PUMAX 10,5CM ' 900

Código: 41615 Fábrica: MUNDIAL Unidade: UN/1 F1 F4

UN: R\$ 46,21 AV: R\$ 46,21 15: R\$ 47,18
30: R\$ 48,12 45: R\$ 49,08 60: R\$ 50,06



TESOURA INOX MULTIUSO PROF 23,5CM 91018

Código: 48360 Fábrica: LEO&LEO Unidade: UN/1 F1 F4

UN: R\$ 6,84 AV: R\$ 6,84 15: R\$ 6,98
30: R\$ 7,12 45: R\$ 7,27 60: R\$ 7,41



TESOURA INOX 13,5CM PONTA RETA CTL 15006

Código: 48357 Fábrica: WIN PAPER Unidade: CR/1 F1 F4

UN: R\$ 8,72 AV: R\$ 8,72 15: R\$ 8,90
30: R\$ 9,08 45: R\$ 9,26 60: R\$ 9,45



TESOURA INOX 20 CM MULTIUSO SOL 2413015

Código: 41096 Fábrica: ONDA Unidade: UN/1 F1 F4

UN: R\$ 9,76 AV: R\$ 9,76 15: R\$ 9,96
30: R\$ 10,16 45: R\$ 10,36 60: R\$ 10,57



TESOURA INOX 21 CM MULTIUSO 61

Código: 45392 Fábrica: NOX Unidade: CR/1 F1 F4

UN: R\$ 10,07 AV: R\$ 10,07 15: R\$ 10,28
30: R\$ 10,48 45: R\$ 10,69 60: R\$ 10,91



TESOURA INOX 21 CM MULTIUSO 720

Código: 40888 Fábrica: JOCAROFFICE Unidade: CR/1 F1 F4

UN: R\$ 8,83 AV: R\$ 8,83 15: R\$ 9,02
30: R\$ 9,20 45: R\$ 9,38 60: R\$ 9,57



TESOURA PIC CORTE CRIATIVO CTL 141204

Código: 46383 Fábrica: FUTURO Unidade: UN/1 F1 F4

UN: R\$ 10,12 AV: R\$ 10,12 15: R\$ 10,33
30: R\$ 10,54 45: R\$ 10,75 60: R\$ 10,96



TESOURA PICO CORTE CRIATIVO ZIG ZAG 1001

Código: 9556 Fábrica: BRW Unidade: UN/1 F1 F4

UN: R\$ 7,10 AV: R\$ 85,25 15: R\$ 87,02
30: R\$ 88,76 45: R\$ 90,54 60: R\$ 92,35



TESOURA PICOTAR INOX 13CM 2299 12X1

Código: 40788 Fábrica: PLANETA Unidade: CX/12 F1 F4

UN: R\$ 102,71 AV: R\$ 102,71 15: R\$ 104,85
30: R\$ 106,95 45: R\$ 109,09 60: R\$ 111,27



TESOURA PICOTAR INOX 23CM ONDA 1418 9"

Código: 43855 Fábrica: LIKE Unidade: CR/1 F1 F4

UN: R\$ 69,84 AV: R\$ 69,84 15: R\$ 71,29
30: R\$ 72,72 45: R\$ 74,17 60: R\$ 75,66

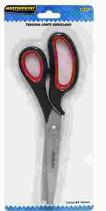

TESOURA PICOTAR INOX 9" 23CM ONDA 513

Código: 42241 Fábrica: MASTERPRINT Unidade: CR/1 F1 F4

UN: R\$ 71,89 AV: R\$ 71,89 15: R\$ 73,39
30: R\$ 74,86 45: R\$ 76,36 60: R\$ 77,88



TESOURA PICOTAR 24CM CTL 4375

Código: 31535 Fábrica: LEO&LEO Unidade: CR/1 F1 F4

UN: R\$ 4,28 AV: R\$ 51,35 15: R\$ 52,42
30: R\$ 53,47 45: R\$ 54,54 60: R\$ 55,63



TESOURINHA DOBRAVEL 12X1

Código: 3253 Fábrica: NYBC Unidade: CX/12 F1 F4

UN: R\$ 15,03 AV: R\$ 90,19 15: R\$ 92,07
30: R\$ 93,91 45: R\$ 95,79 60: R\$ 97,70



TINTA A OLEO P/TELA 20ML SORTIDO 6X1

Código: 49307 Fábrica: ACRILEX Unidade: CX/6 F1 F4

UN: R\$ 15,03 AV: R\$ 90,19 15: R\$ 92,07
30: R\$ 93,91 45: R\$ 95,79 60: R\$ 97,70



TINTA A OLEO P/TELA 20ML 304 AMARELO 6X1
Código: Fábrica: Unidade:
48223 ACRILEX CX/6
F1 F4

UN: R\$ 15,03 AV: R\$ 90,19 15: R\$ 92,07
30: R\$ 93,91 45: R\$ 95,79 60: R\$ 97,70



TINTA A OLEO P/TELA 20ML 307 ALARANJ 6X1
Código: Fábrica: Unidade:
48224 ACRILEX CX/6
F1 F4

UN: R\$ 15,03 AV: R\$ 90,19 15: R\$ 92,07
30: R\$ 93,91 45: R\$ 95,79 60: R\$ 97,70



TINTA A OLEO P/TELA 20ML 309 AZUL CE 6X1
Código: Fábrica: Unidade:
48225 ACRILEX CX/6
F1 F4

UN: R\$ 15,03 AV: R\$ 90,19 15: R\$ 92,07
30: R\$ 93,91 45: R\$ 95,79 60: R\$ 97,70



TINTA A OLEO P/TELA 20ML 312 VERMELH 6X1
Código: Fábrica: Unidade:
48226 ACRILEX CX/6
F1 F4

UN: R\$ 15,03 AV: R\$ 90,19 15: R\$ 92,07
30: R\$ 93,91 45: R\$ 95,79 60: R\$ 97,70



TINTA A OLEO P/TELA 20ML 313 VERMELH 6X1
Código: Fábrica: Unidade:
48227 ACRILEX CX/6
F1 F4

UN: R\$ 15,03 AV: R\$ 90,19 15: R\$ 92,07
30: R\$ 93,91 45: R\$ 95,79 60: R\$ 97,70



TINTA A OLEO P/TELA 20ML 316 ROSA ES 6X1
Código: Fábrica: Unidade:
48228 ACRILEX CX/6
F1 F4

UN: R\$ 15,03 AV: R\$ 90,19 15: R\$ 92,07
30: R\$ 93,91 45: R\$ 95,79 60: R\$ 97,70



TINTA A OLEO P/TELA 20ML 319 BRANCO 6X1
Código: Fábrica: Unidade:
48229 ACRILEX CX/6
F1 F4

UN: R\$ 15,03 AV: R\$ 90,19 15: R\$ 92,07
30: R\$ 93,91 45: R\$ 95,79 60: R\$ 97,70



TINTA A OLEO P/TELA 20ML 320 PRETO 6X1
Código: Fábrica: Unidade:
48230 ACRILEX CX/6
F1 F4

UN: R\$ 15,03 AV: R\$ 90,19 15: R\$ 92,07
30: R\$ 93,91 45: R\$ 95,79 60: R\$ 97,70



TINTA A OLEO P/TELA 20ML 321 VIOLETA 6X1
Código: Fábrica: Unidade:
48231 ACRILEX CX/6
F1 F4

UN: R\$ 15,03 AV: R\$ 90,19 15: R\$ 92,07
30: R\$ 93,91 45: R\$ 95,79 60: R\$ 97,70



TINTA A OLEO P/TELA 20ML 322 VERDE M 6X1
Código: Fábrica: Unidade:
48232 ACRILEX CX/6
F1 F4

UN: R\$ 15,03 AV: R\$ 90,19 15: R\$ 92,07
30: R\$ 93,91 45: R\$ 95,79 60: R\$ 97,70



TINTA A OLEO P/TELA 20ML 323 AMARELO 6X1
Código: Fábrica: Unidade:
48233 ACRILEX CX/6
F1 F4

UN: R\$ 15,03 AV: R\$ 90,19 15: R\$ 92,07
30: R\$ 93,91 45: R\$ 95,79 60: R\$ 97,70



TINTA A OLEO P/TELA 20ML 363 AZUL TU 6X1
Código: Fábrica: Unidade:
48234 ACRILEX CX/6
F1 F4

UN: R\$ 71,89 AV: R\$ 71,89 15: R\$ 73,39
30: R\$ 74,86 45: R\$ 76,36 60: R\$ 77,88



TINTA ACRILICA 250ML BRILHANTE 513 VERDE
Código: Fábrica: Unidade:
50360 ACRILEX UN/1
F1 F4

UN: R\$ 71,89 AV: R\$ 71,89 15: R\$ 73,39
30: R\$ 74,86 45: R\$ 76,36 60: R\$ 77,88



TINTA ACRILICA 250ML BRILHANTE 519 BRANC
Código: Fábrica: Unidade:
50359 ACRILEX UN/1
F1 F4

UN: R\$ 51,35 AV: R\$ 51,35 15: R\$ 52,42
30: R\$ 53,47 45: R\$ 54,54 60: R\$ 55,63



TINTA ACRILICA 250ML FOSCA 501 AZUL TURQ
Código: Fábrica: Unidade:
50361 ACRILEX UN/1
F1 F4

UN: R\$ 51,35 AV: R\$ 51,35 15: R\$ 52,42
30: R\$ 53,47 45: R\$ 54,54 60: R\$ 55,63



TINTA ACRILICA 250ML FOSCA 507 VERMELHO
Código: Fábrica: Unidade:
50363 ACRILEX UN/1
F1 F4

UN: R\$ 51,35 AV: R\$ 51,35 15: R\$ 52,42
30: R\$ 53,47 45: R\$ 54,54 60: R\$ 55,63



TINTA ACRILICA 250ML FOSCA 516 VIOLETA
Código: 50364 Fábrica: ACRILEX Unidade: UN/1
F1 F4

UN: R\$ 51,35 AV: R\$ 51,35 15: R\$ 52,42
30: R\$ 53,47 45: R\$ 54,54 60: R\$ 55,63



TINTA ACRILICA 250ML FOSCA 517 LARANJA
Código: 50366 Fábrica: ACRILEX Unidade: UN/1
F1 F4

UN: R\$ 51,35 AV: R\$ 51,35 15: R\$ 52,42
30: R\$ 53,47 45: R\$ 54,54 60: R\$ 55,63



TINTA ACRILICA 250ML FOSCA 520 PRETO
Código: 50362 Fábrica: ACRILEX Unidade: UN/1
F1 F4

UN: R\$ 51,35 AV: R\$ 51,35 15: R\$ 52,42
30: R\$ 53,47 45: R\$ 54,54 60: R\$ 55,63



TINTA ACRILICA 250ML FOSCA 531 MARROM
Código: 50365 Fábrica: ACRILEX Unidade: UN/1
F1 F4

UN: R\$ 11,29 AV: R\$ 11,29 15: R\$ 11,52
30: R\$ 11,75 45: R\$ 11,99 60: R\$ 12,23



TINTA AQUARELA 12 CORES C/PINCEL
Código: 49273 Fábrica: COLORARE Unidade: UN/1
F1 F4

UN: R\$ 14,97 AV: R\$ 14,97 15: R\$ 15,28
30: R\$ 15,58 45: R\$ 15,90 60: R\$ 16,21



TINTA ARTES 100ML FOSCA 501 AZUL TURQUES
Código: 40926 Fábrica: ACRILEX Unidade: UN/1
F1 F4

UN: R\$ 14,97 AV: R\$ 14,97 15: R\$ 15,28
30: R\$ 15,58 45: R\$ 15,90 60: R\$ 16,21



TINTA ARTES 100ML FOSCA 503 AZUL CELESTE
Código: 48410 Fábrica: ACRILEX Unidade: UN/1
F1 F4

UN: R\$ 14,97 AV: R\$ 14,97 15: R\$ 15,28
30: R\$ 15,58 45: R\$ 15,90 60: R\$ 16,21



TINTA ARTES 100ML FOSCA 505 AMARELO OURO
Código: 48413 Fábrica: ACRILEX Unidade: UN/1
F1 F4

UN: R\$ 14,97 AV: R\$ 14,97 15: R\$ 15,28
30: R\$ 15,58 45: R\$ 15,90 60: R\$ 16,21



TINTA ARTES 100ML FOSCA 507 VERMELHO FOG
Código: 48412 Fábrica: ACRILEX Unidade: UN/1
F1 F4

UN: R\$ 14,97 AV: R\$ 14,97 15: R\$ 15,28
30: R\$ 15,58 45: R\$ 15,90 60: R\$ 16,21



TINTA ARTES 100ML FOSCA 510 VERDE FOLHA
Código: 48414 Fábrica: ACRILEX Unidade: UN/1
F1 F4

UN: R\$ 14,97 AV: R\$ 14,97 15: R\$ 15,28
30: R\$ 15,58 45: R\$ 15,90 60: R\$ 16,21



TINTA ARTES 100ML FOSCA 511 VERDE BANDEI
Código: 48415 Fábrica: ACRILEX Unidade: UN/1
F1 F4

UN: R\$ 14,97 AV: R\$ 14,97 15: R\$ 15,28
30: R\$ 15,58 45: R\$ 15,90 60: R\$ 16,21



TINTA ARTES 100ML FOSCA 516 VIOLETA
Código: 48416 Fábrica: ACRILEX Unidade: UN/1
F1 F4

UN: R\$ 14,97 AV: R\$ 14,97 15: R\$ 15,28
30: R\$ 15,58 45: R\$ 15,90 60: R\$ 16,21



TINTA ARTES 100ML FOSCA 517 LARANJA
Código: 40927 Fábrica: ACRILEX Unidade: UN/1
F1 F4

UN: R\$ 14,97 AV: R\$ 14,97 15: R\$ 15,28
30: R\$ 15,58 45: R\$ 15,90 60: R\$ 16,21



TINTA ARTES 100ML FOSCA 519 BRANCO
Código: 48411 Fábrica: ACRILEX Unidade: UN/1
F1 F4

UN: R\$ 14,97 AV: R\$ 14,97 15: R\$ 15,28
30: R\$ 15,58 45: R\$ 15,90 60: R\$ 16,21



TINTA ARTES 100ML FOSCA 520 PRETO
Código: 48418 Fábrica: ACRILEX Unidade: UN/1
F1 F4

UN: R\$ 14,97 AV: R\$ 14,97 15: R\$ 15,28
30: R\$ 15,58 45: R\$ 15,90 60: R\$ 16,21



TINTA ARTES 100ML FOSCA 531 MARROM
Código: 48417 Fábrica: ACRILEX Unidade: UN/1
F1 F4

UN: R\$ 14,97 AV: R\$ 14,97 15: R\$ 15,28
30: R\$ 15,58 45: R\$ 15,90 60: R\$ 16,21



TINTA ARTES 100ML FOSCA 537 ROSA
Código: Fábrica: Unidade:
40928 ACRILEX UN/1
F1 F4

UN: R\$ 14,97 AV: R\$ 14,97 15: R\$ 15,28
30: R\$ 15,58 45: R\$ 15,90 60: R\$ 16,21



TINTA ARTESANATO 100ML FOSCA
Código: Fábrica: Unidade:
40930 ACRILEX UN/1
F1 F4

UN: R\$ 8,17 AV: R\$ 8,17 15: R\$ 8,34
30: R\$ 8,50 45: R\$ 8,67 60: R\$ 8,85



TINTA CRAQUELEX 37ML 501 AZUL TURQUESA
Código: Fábrica: Unidade:
44832 ACRILEX UN/1
F1 F4

UN: R\$ 8,17 AV: R\$ 8,17 15: R\$ 8,34
30: R\$ 8,50 45: R\$ 8,67 60: R\$ 8,85



TINTA CRAQUELEX 37ML 505 AMARELO OURO
Código: Fábrica: Unidade:
44835 ACRILEX UN/1
F1 F4

UN: R\$ 8,17 AV: R\$ 8,17 15: R\$ 8,34
30: R\$ 8,50 45: R\$ 8,67 60: R\$ 8,85



TINTA CRAQUELEX 37ML 507 VERMELHO FOGO
Código: Fábrica: Unidade:
44834 ACRILEX UN/1
F1 F4

UN: R\$ 8,17 AV: R\$ 8,17 15: R\$ 8,34
30: R\$ 8,50 45: R\$ 8,67 60: R\$ 8,85



TINTA CRAQUELEX 37ML 513 VERDE MUSGO
Código: Fábrica: Unidade:
44833 ACRILEX UN/1
F1 F4

UN: R\$ 8,17 AV: R\$ 8,17 15: R\$ 8,34
30: R\$ 8,50 45: R\$ 8,67 60: R\$ 8,85



TINTA CRAQUELEX 37ML 519 BRANCO
Código: Fábrica: Unidade:
44830 ACRILEX UN/1
F1 F4

UN: R\$ 8,17 AV: R\$ 8,17 15: R\$ 8,34
30: R\$ 8,50 45: R\$ 8,67 60: R\$ 8,85

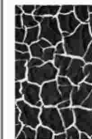

TINTA CRAQUELEX 37ML 520 PRETO
Código: Fábrica: Unidade:
44831 ACRILEX UN/1
F1 F4

UN: R\$ 8,17 AV: R\$ 8,17 15: R\$ 8,34
30: R\$ 8,50 45: R\$ 8,67 60: R\$ 8,85



TINTA CRAQUELEX 37ML 531 MARROM
Código: Fábrica: Unidade:
44836 ACRILEX UN/1
F1 F4

UN: R\$ 7,18 AV: R\$ 7,18 15: R\$ 7,33
30: R\$ 7,48 45: R\$ 7,63 60: R\$ 7,78



TINTA DIMENSIONAL 35ML BRILLIAN 501 AZUL
Código: Fábrica: Unidade:
44825 ACRILEX UN/1
F1 F4

UN: R\$ 7,18 AV: R\$ 7,18 15: R\$ 7,33
30: R\$ 7,48 45: R\$ 7,63 60: R\$ 7,78



TINTA DIMENSIONAL 35ML BRILLIAN 505 AMAR
Código: Fábrica: Unidade:
44828 ACRILEX UN/1
F1 F4

UN: R\$ 7,18 AV: R\$ 7,18 15: R\$ 7,33
30: R\$ 7,48 45: R\$ 7,63 60: R\$ 7,78



TINTA DIMENSIONAL 35ML BRILLIAN 507 VERM
Código: Fábrica: Unidade:
44829 ACRILEX UN/1
F1 F4

UN: R\$ 7,18 AV: R\$ 7,18 15: R\$ 7,33
30: R\$ 7,48 45: R\$ 7,63 60: R\$ 7,78



TINTA DIMENSIONAL 35ML BRILLIAN 513 VERD
Código: Fábrica: Unidade:
44827 ACRILEX UN/1
F1 F4

UN: R\$ 7,18 AV: R\$ 7,18 15: R\$ 7,33
30: R\$ 7,48 45: R\$ 7,63 60: R\$ 7,78



TINTA DIMENSIONAL 35ML BRILLIAN 519 BCO
Código: Fábrica: Unidade:
44823 ACRILEX UN/1
F1 F4

UN: R\$ 7,18 AV: R\$ 7,18 15: R\$ 7,33
30: R\$ 7,48 45: R\$ 7,63 60: R\$ 7,78



TINTA DIMENSIONAL 35ML BRILLIAN 520 PTO
Código: Fábrica: Unidade:
44824 ACRILEX UN/1
F1 F4

UN: R\$ 7,18 AV: R\$ 7,18 15: R\$ 7,33
30: R\$ 7,48 45: R\$ 7,63 60: R\$ 7,78



TINTA DIMENSIONAL 35ML BRILLIAN 531 MARR
Código: Fábrica: Unidade:
44826 ACRILEX UN/1
F1 F4

UN: R\$ 5,74 AV: R\$ 5,74 15: R\$ 5,86
30: R\$ 5,98 45: R\$ 6,10 60: R\$ 6,22



TINTA FACIAL 15 ML AMARELO 1002

Código: 46557 Fábrica: COR&ARTE Unidade: UN/1 F1 F4

UN: R\$ 5,74 AV: R\$ 5,74 15: R\$ 5,86
30: R\$ 5,98 45: R\$ 6,10 60: R\$ 6,22



TINTA FACIAL 15 ML AZUL CLARO 1007

Código: 46558 Fábrica: COR&ARTE Unidade: UN/1 F1 F4

UN: R\$ 5,74 AV: R\$ 5,74 15: R\$ 5,86
30: R\$ 5,98 45: R\$ 6,10 60: R\$ 6,22



TINTA FACIAL 15 ML AZUL 1004

Código: 46550 Fábrica: COR&ARTE Unidade: UN/1 F1 F4

UN: R\$ 5,74 AV: R\$ 5,74 15: R\$ 5,86
30: R\$ 5,98 45: R\$ 6,10 60: R\$ 6,22



TINTA FACIAL 15 ML BRANCA 1001

Código: 46549 Fábrica: COR&ARTE Unidade: UN/1 F1 F4

UN: R\$ 5,74 AV: R\$ 5,74 15: R\$ 5,86
30: R\$ 5,98 45: R\$ 6,10 60: R\$ 6,22



TINTA FACIAL 15 ML LARANJA 1009

Código: 46551 Fábrica: COR&ARTE Unidade: UN/1 F1 F4

UN: R\$ 7,48 AV: R\$ 7,48 15: R\$ 7,63
30: R\$ 7,79 45: R\$ 7,94 60: R\$ 8,10



TINTA FACIAL 15 ML LILAS LAVANDA 1022

Código: 46559 Fábrica: COR&ARTE Unidade: UN/1 F1 F4

UN: R\$ 5,74 AV: R\$ 5,74 15: R\$ 5,86
30: R\$ 5,98 45: R\$ 6,10 60: R\$ 6,22



TINTA FACIAL 15 ML MARRROM 1008

Código: 46552 Fábrica: COR&ARTE Unidade: UN/1 F1 F4

UN: R\$ 7,48 AV: R\$ 7,48 15: R\$ 7,63
30: R\$ 7,79 45: R\$ 7,94 60: R\$ 8,10



TINTA FACIAL 15 ML PINK FLUOR 1016

Código: 46553 Fábrica: COR&ARTE Unidade: UN/1 F1 F4

UN: R\$ 5,74 AV: R\$ 5,74 15: R\$ 5,86
30: R\$ 5,98 45: R\$ 6,10 60: R\$ 6,22



TINTA FACIAL 15 ML PRETO 1005

Código: 46554 Fábrica: COR&ARTE Unidade: UN/1 F1 F4

UN: R\$ 5,74 AV: R\$ 5,74 15: R\$ 5,86
30: R\$ 5,98 45: R\$ 6,10 60: R\$ 6,22



TINTA FACIAL 15 ML VERDE 1006

Código: 46555 Fábrica: COR&ARTE Unidade: UN/1 F1 F4

UN: R\$ 5,74 AV: R\$ 5,74 15: R\$ 5,86
30: R\$ 5,98 45: R\$ 6,10 60: R\$ 6,22



TINTA FACIAL 15 ML VERMELHO 1003

Código: 46556 Fábrica: COR&ARTE Unidade: UN/1 F1 F4

UN: R\$ 51,35 AV: R\$ 51,35 15: R\$ 52,42
30: R\$ 53,47 45: R\$ 54,54 60: R\$ 55,63



TINTA FACIAL 15 ML 6 CORES+PINCEL+GLITER

Código: 46546 Fábrica: COR&ARTE Unidade: CJ/1 F1 F4

UN: R\$ 37,68 AV: R\$ 37,68 15: R\$ 38,46
30: R\$ 39,23 45: R\$ 40,02 60: R\$ 40,82



TINTA FACIAL 15 ML 6 CORES+PINCEL+GLITER

Código: 44637 Fábrica: COR&ARTE Unidade: CJ/1 F1 F4

UN: R\$ 4,07 AV: R\$ 20,34 15: R\$ 20,76
30: R\$ 21,18 45: R\$ 21,60 60: R\$ 22,03



TINTA FACIAL 4 GR GLITER CREMOS 4011 5X1

Código: 46548 Fábrica: COR&ARTE Unidade: CJ/5 F1 F4

UN: R\$ 1,37 AV: R\$ 8,21 15: R\$ 8,38
30: R\$ 8,55 45: R\$ 8,72 60: R\$ 8,90



TINTA GUACHE 15ML 6 CORES SORT 6X1

Código: 19150 Fábrica: MAXCRIL Unidade: CX/6 F1 F4

UN: R\$ 1,05 AV: R\$ 12,58 15: R\$ 12,85
30: R\$ 13,10 45: R\$ 13,36 60: R\$ 13,63



TINTA GUACHE 15ML AMARELO 12X1

Código: 5929 Fábrica: MARIPEL Unidade: DZ/12 F1 F4

UN: R\$ 1,05 AV: R\$ 12,58 15: R\$ 12,85
30: R\$ 13,10 45: R\$ 13,36 60: R\$ 13,63



TINTA GUACHE 15ML AZUL CLARO 12X1
Código: 5816 Fábrica: MARIPEL Unidade: DZ/12 F1 F4

UN: R\$ 1,05 AV: R\$ 12,58 15: R\$ 12,85
30: R\$ 13,10 45: R\$ 13,36 60: R\$ 13,63



TINTA GUACHE 15ML AZUL ESCURO 12X1
Código: 19035 Fábrica: MARIPEL Unidade: DZ/12 F1 F4

UN: R\$ 1,05 AV: R\$ 12,58 15: R\$ 12,85
30: R\$ 13,10 45: R\$ 13,36 60: R\$ 13,63



TINTA GUACHE 15ML BRANCO 12X1
Código: 5818 Fábrica: MARIPEL Unidade: DZ/12 F1 F4

UN: R\$ 1,05 AV: R\$ 12,58 15: R\$ 12,85
30: R\$ 13,10 45: R\$ 13,36 60: R\$ 13,63



TINTA GUACHE 15ML LARANJA 12X1
Código: 15283 Fábrica: MARIPEL Unidade: DZ/12 F1 F4

UN: R\$ 1,05 AV: R\$ 12,58 15: R\$ 12,85
30: R\$ 13,10 45: R\$ 13,36 60: R\$ 13,63



TINTA GUACHE 15ML MARROM 12X1
Código: 10033 Fábrica: MARIPEL Unidade: DZ/12 F1 F4

UN: R\$ 1,05 AV: R\$ 12,58 15: R\$ 12,85
30: R\$ 13,10 45: R\$ 13,36 60: R\$ 13,63



TINTA GUACHE 15ML PESSEGO 12X1
Código: 5820 Fábrica: MARIPEL Unidade: DZ/12 F1 F4

UN: R\$ 1,05 AV: R\$ 12,58 15: R\$ 12,85
30: R\$ 13,10 45: R\$ 13,36 60: R\$ 13,63



TINTA GUACHE 15ML PRETO 12X1
Código: 19199 Fábrica: MARIPEL Unidade: DZ/12 F1 F4

UN: R\$ 1,05 AV: R\$ 12,58 15: R\$ 12,85
30: R\$ 13,10 45: R\$ 13,36 60: R\$ 13,63



TINTA GUACHE 15ML ROSA 12X1
Código: 21879 Fábrica: MARIPEL Unidade: DZ/12 F1 F4

UN: R\$ 1,05 AV: R\$ 12,58 15: R\$ 12,85
30: R\$ 13,10 45: R\$ 13,36 60: R\$ 13,63



TINTA GUACHE 15ML VERDE BAND 12X1
Código: 5823 Fábrica: MARIPEL Unidade: DZ/12 F1 F4

UN: R\$ 1,05 AV: R\$ 12,58 15: R\$ 12,85
30: R\$ 13,10 45: R\$ 13,36 60: R\$ 13,63



TINTA GUACHE 15ML VERDE CLARO 12X1
Código: 5824 Fábrica: MARIPEL Unidade: DZ/12 F1 F4

UN: R\$ 1,05 AV: R\$ 12,58 15: R\$ 12,85
30: R\$ 13,10 45: R\$ 13,36 60: R\$ 13,63



TINTA GUACHE 15ML VERMELHO 12X1
Código: 7429 Fábrica: MARIPEL Unidade: DZ/12 F1 F4

UN: R\$ 1,05 AV: R\$ 12,58 15: R\$ 12,85
30: R\$ 13,10 45: R\$ 13,36 60: R\$ 13,63



TINTA GUACHE 15ML 12 CORES SORT 12X1
Código: 50519 Fábrica: MARIPEL Unidade: DZ/12 F1 F4

UN: R\$ 1,11 AV: R\$ 6,67 15: R\$ 6,81
30: R\$ 6,94 45: R\$ 7,08 60: R\$ 7,22



TINTA GUACHE 15ML 6 CORES SORT 6X1 K04
Código: 45145 Fábrica: COLA MAIS Unidade: CX/6 F1 F4

UN: R\$ 1,20 AV: R\$ 7,18 15: R\$ 7,33
30: R\$ 7,48 45: R\$ 7,63 60: R\$ 7,78



TINTA GUACHE 30ML 6 CORES SORT 6X1
Código: 14667 Fábrica: MARIPEL Unidade: CX/6 F1 F4

UN: R\$ 1,20 AV: R\$ 7,18 15: R\$ 7,33
30: R\$ 7,48 45: R\$ 7,63 60: R\$ 7,78



TINTA GUACHE PINTURA DEDO 6 CORES SORT
Código: 14673 Fábrica: MARIPEL Unidade: CX/6 F1 F4

UN: R\$ 5,99 AV: R\$ 5,99 15: R\$ 5,99
30: R\$ 5,99 45: R\$ 5,99 60: R\$ 5,99



TINTA GUACHE 250ML AMARELO
Código: 45149 Fábrica: COLA MAIS Unidade: UN/1 F1 F4

UN: R\$ 5,99 AV: R\$ 5,99 15: R\$ 5,99
30: R\$ 5,99 45: R\$ 5,99 60: R\$ 5,99



TINTA GUACHE 250ML AZUL

Código: Fábrika: Unidade:
45147 COLA MAIS UN/1
F1 F4

UN: R\$ 11,15 AV: R\$ 11,15 15: R\$ 11,38
30: R\$ 11,61 45: R\$ 11,84 60: R\$ 12,08



TINTA GUACHE 250ML AZUL CELESTE

Código: Fábrika: Unidade:
33046 EVIDENT UN/1
F1 F4

UN: R\$ 5,99 AV: R\$ 5,99 15: R\$ 5,99
30: R\$ 5,99 45: R\$ 5,99 60: R\$ 5,99



TINTA GUACHE 250ML AZUL CELESTE

Código: Fábrika: Unidade:
39914 VMP UN/1
F1 F4

UN: R\$ 5,99 AV: R\$ 5,99 15: R\$ 5,99
30: R\$ 5,99 45: R\$ 5,99 60: R\$ 5,99



TINTA GUACHE 250ML AZUL ESCURO

Código: Fábrika: Unidade:
50842 MARIPEL UN/1
F1 F4

UN: R\$ 5,99 AV: R\$ 5,99 15: R\$ 5,99
30: R\$ 5,99 45: R\$ 5,99 60: R\$ 5,99



TINTA GUACHE 250ML AZUL TURQUEZA

Código: Fábrika: Unidade:
39915 VMP UN/1
F1 F4

UN: R\$ 5,99 AV: R\$ 5,99 15: R\$ 5,99
30: R\$ 5,99 45: R\$ 5,99 60: R\$ 5,99



TINTA GUACHE 250ML BRANCO

Código: Fábrika: Unidade:
45146 COLA MAIS UN/1
F1 F4

UN: R\$ 5,99 AV: R\$ 5,99 15: R\$ 5,99
30: R\$ 5,99 45: R\$ 5,99 60: R\$ 5,99



TINTA GUACHE 250ML LARANJA

Código: Fábrika: Unidade:
39917 VMP UN/1
F1 F4

UN: R\$ 5,99 AV: R\$ 5,99 15: R\$ 5,99
30: R\$ 5,99 45: R\$ 5,99 60: R\$ 5,99



TINTA GUACHE 250ML MARROM

Código: Fábrika: Unidade:
39922 COLA MAIS UN/1
F1 F4

UN: R\$ 11,15 AV: R\$ 11,15 15: R\$ 11,38
30: R\$ 11,61 45: R\$ 11,84 60: R\$ 12,08



TINTA GUACHE 250ML PRETO

Código: Fábrika: Unidade:
39921 EVIDENT UN/1
F1 F4

UN: R\$ 5,99 AV: R\$ 5,99 15: R\$ 5,99
30: R\$ 5,99 45: R\$ 5,99 60: R\$ 5,99



TINTA GUACHE 250ML ROSA

Código: Fábrika: Unidade:
39918 VMP UN/1
F1 F4

UN: R\$ 5,99 AV: R\$ 5,99 15: R\$ 5,99
30: R\$ 5,99 45: R\$ 5,99 60: R\$ 5,99



TINTA GUACHE 250ML ROSA

Código: Fábrika: Unidade:
49176 COLA MAIS UN/1
F1 F4

UN: R\$ 5,99 AV: R\$ 5,99 15: R\$ 5,99
30: R\$ 5,99 45: R\$ 5,99 60: R\$ 5,99



TINTA GUACHE 250ML VERDE BANDEIRA

Código: Fábrika: Unidade:
39919 VMP UN/1
F1 F4

UN: R\$ 11,16 AV: R\$ 11,16 15: R\$ 11,39
30: R\$ 11,62 45: R\$ 11,86 60: R\$ 12,09



TINTA GUACHE 250ML VERDE BANDEIRA

Código: Fábrika: Unidade:
33313 EVIDENT UN/1
F1 F4

UN: R\$ 5,99 AV: R\$ 5,99 15: R\$ 5,99
30: R\$ 5,99 45: R\$ 5,99 60: R\$ 5,99



TINTA GUACHE 250ML VERDE ESCURO

Código: Fábrika: Unidade:
45150 MARIPEL/COLA UN/1
F1 F4

UN: R\$ 5,99 AV: R\$ 5,99 15: R\$ 5,99
30: R\$ 5,99 45: R\$ 5,99 60: R\$ 5,99



TINTA GUACHE 250ML VERMELHO

Código: Fábrika: Unidade:
45151 COLA MAIS UN/1
F1 F4

UN: R\$ 5,99 AV: R\$ 5,99 15: R\$ 5,99
30: R\$ 5,99 45: R\$ 5,99 60: R\$ 5,99



TINTA GUACHE 250ML VERMELHO ESC

Código: Fábrika: Unidade:
49175 COLA MAIS UN/1
F1 F4

UN: R\$ 11,74 AV: R\$ 11,74 15: R\$ 11,98
30: R\$ 12,22 45: R\$ 12,47 60: R\$ 12,72



TINTA GUACHE 250ML 501 AZUL TURQUESA
Código: 45038 Fábrica: ACRILEX Unidade: UN/1 F1 F4

UN: R\$ 11,74 AV: R\$ 11,74 15: R\$ 11,98
30: R\$ 12,22 45: R\$ 12,47 60: R\$ 12,72



TINTA GUACHE 250ML 503 AZUL CELESTE
Código: 45040 Fábrica: ACRILEX Unidade: UN/1 F1 F4

UN: R\$ 11,74 AV: R\$ 11,74 15: R\$ 11,98
30: R\$ 12,22 45: R\$ 12,47 60: R\$ 12,72



TINTA GUACHE 250ML 504 AMARELO LIMA
Código: 45044 Fábrica: ACRILEX Unidade: UN/1 F1 F4

UN: R\$ 11,74 AV: R\$ 11,74 15: R\$ 11,98
30: R\$ 12,22 45: R\$ 12,47 60: R\$ 12,72



TINTA GUACHE 250ML 505 AMARELO OURO
Código: 45045 Fábrica: ACRILEX Unidade: UN/1 F1 F4

UN: R\$ 11,74 AV: R\$ 11,74 15: R\$ 11,98
30: R\$ 12,22 45: R\$ 12,47 60: R\$ 12,72



TINTA GUACHE 250ML 507 VERMELHO FOGO
Código: 45042 Fábrica: ACRILEX Unidade: UN/1 F1 F4

UN: R\$ 11,74 AV: R\$ 11,74 15: R\$ 11,98
30: R\$ 12,22 45: R\$ 12,47 60: R\$ 12,72



TINTA GUACHE 250ML 510 VERDE FOLHA
Código: 45051 Fábrica: ACRILEX Unidade: UN/1 F1 F4

UN: R\$ 11,74 AV: R\$ 11,74 15: R\$ 11,98
30: R\$ 12,22 45: R\$ 12,47 60: R\$ 12,72



TINTA GUACHE 250ML 511 VERDE BANDEIRA
Código: 45043 Fábrica: ACRILEX Unidade: UN/1 F1 F4

UN: R\$ 11,74 AV: R\$ 11,74 15: R\$ 11,98
30: R\$ 12,22 45: R\$ 12,47 60: R\$ 12,72



TINTA GUACHE 250ML 516 VIOLETA
Código: 45052 Fábrica: ACRILEX Unidade: UN/1 F1 F4

UN: R\$ 11,74 AV: R\$ 11,74 15: R\$ 11,98
30: R\$ 12,22 45: R\$ 12,47 60: R\$ 12,72



TINTA GUACHE 250ML 517 LARANJA
Código: 45053 Fábrica: ACRILEX Unidade: UN/1 F1 F4

UN: R\$ 11,74 AV: R\$ 11,74 15: R\$ 11,98
30: R\$ 12,22 45: R\$ 12,47 60: R\$ 12,72



TINTA GUACHE 250ML 519 BRANCO
Código: 45037 Fábrica: ACRILEX Unidade: UN/1 F1 F4

UN: R\$ 11,74 AV: R\$ 11,74 15: R\$ 11,98
30: R\$ 12,22 45: R\$ 12,47 60: R\$ 12,72



TINTA GUACHE 250ML 520 PRETO
Código: 45039 Fábrica: ACRILEX Unidade: UN/1 F1 F4

UN: R\$ 11,74 AV: R\$ 11,74 15: R\$ 11,98
30: R\$ 12,22 45: R\$ 12,47 60: R\$ 12,72



TINTA GUACHE 250ML 528 LILAS
Código: 45049 Fábrica: ACRILEX Unidade: UN/1 F1 F4

UN: R\$ 11,74 AV: R\$ 11,74 15: R\$ 11,98
30: R\$ 12,22 45: R\$ 12,47 60: R\$ 12,72



TINTA GUACHE 250ML 531 MARROM
Código: 45047 Fábrica: ACRILEX Unidade: UN/1 F1 F4

UN: R\$ 11,74 AV: R\$ 11,74 15: R\$ 11,98
30: R\$ 12,22 45: R\$ 12,47 60: R\$ 12,72



TINTA GUACHE 250ML 537 ROSA
Código: 45054 Fábrica: ACRILEX Unidade: UN/1 F1 F4

UN: R\$ 11,74 AV: R\$ 11,74 15: R\$ 11,98
30: R\$ 12,22 45: R\$ 12,47 60: R\$ 12,72



TINTA GUACHE 250ML 538 AMARELO PESSEGO
Código: 45046 Fábrica: ACRILEX Unidade: UN/1 F1 F4

UN: R\$ 11,74 AV: R\$ 11,74 15: R\$ 11,98
30: R\$ 12,22 45: R\$ 12,47 60: R\$ 12,72



TINTA GUACHE 250ML 549 MAGENTA
Código: 45050 Fábrica: ACRILEX Unidade: UN/1 F1 F4

UN: R\$ 11,74 AV: R\$ 11,74 15: R\$ 11,98
30: R\$ 12,22 45: R\$ 12,47 60: R\$ 12,72



TINTA GUACHE 250ML 559 AZUL

Código: 45041 Fábrica: ACRILEX Unidade: UN/1 F1 F4

UN: R\$ 11,74 AV: R\$ 11,74 15: R\$ 11,98
30: R\$ 12,22 45: R\$ 12,47 60: R\$ 12,72



TINTA GUACHE 250ML 565 VINHO

Código: 45048 Fábrica: ACRILEX Unidade: UN/1 F1 F4

UN: R\$ 11,74 AV: R\$ 11,74 15: R\$ 11,98
30: R\$ 12,22 45: R\$ 12,47 60: R\$ 12,72



TINTA GUACHE 250ML 933 CINZA

Código: 45055 Fábrica: ACRILEX Unidade: UN/1 F1 F4

UN: R\$ 8,52 AV: R\$ 8,52 15: R\$ 8,69
30: R\$ 8,87 45: R\$ 9,04 60: R\$ 9,23



TINTA IMP CANON REFIL 100ML BK

Código: 42236 Fábrica: MASTERPRINT Unidade: UN/1 F1 F4

UN: R\$ 22,86 AV: R\$ 22,86 15: R\$ 23,33
30: R\$ 23,80 45: R\$ 24,27 60: R\$ 24,76



TINTA IMP EPSON REFIL 70ML BK 544120

Código: 44196 Fábrica: MAXPRINT Unidade: UN/1 F1 F4

UN: R\$ 22,86 AV: R\$ 22,86 15: R\$ 23,33
30: R\$ 23,80 45: R\$ 24,27 60: R\$ 24,76



TINTA IMP EPSON REFIL 70ML CIANO 544220

Código: 44197 Fábrica: MAXPRINT Unidade: UN/1 F1 F4

UN: R\$ 22,86 AV: R\$ 22,86 15: R\$ 23,33
30: R\$ 23,80 45: R\$ 24,27 60: R\$ 24,76



TINTA IMP EPSON REFIL 70ML MAGEN 544320

Código: 44198 Fábrica: MAXPRINT Unidade: UN/1 F1 F4

UN: R\$ 8,73 AV: R\$ 8,73 15: R\$ 8,91
30: R\$ 9,09 45: R\$ 9,27 60: R\$ 9,46



TINTA IMP EPSON REFIL 70ML 504/544 CYAN

Código: 45116 Fábrica: MASTERPRINT Unidade: UN/1 F1 F4

UN: R\$ 8,73 AV: R\$ 8,73 15: R\$ 8,91
30: R\$ 9,09 45: R\$ 9,27 60: R\$ 9,46



TINTA IMP EPSON REFIL 70ML 504/544 MAG

Código: 45118 Fábrica: MASTERPRINT Unidade: UN/1 F1 F4

UN: R\$ 8,73 AV: R\$ 8,73 15: R\$ 8,91
30: R\$ 9,09 45: R\$ 9,27 60: R\$ 9,46



TINTA IMP EPSON REFIL 70ML 504/544 YELL

Código: 45117 Fábrica: MASTERPRINT Unidade: UN/1 F1 F4

UN: R\$ 7,18 AV: R\$ 7,18 15: R\$ 7,33
30: R\$ 7,48 45: R\$ 7,63 60: R\$ 7,78



TINTA IMP EPSON REFIL 100ML BK 664/672/6

Código: 38242 Fábrica: MASTERPRINT Unidade: UN/1 F1 F4

UN: R\$ 9,23 AV: R\$ 9,23 15: R\$ 9,43
30: R\$ 9,62 45: R\$ 9,81 60: R\$ 10,00



TINTA IMP EPSON REFIL 100ML CYA

Código: 41737 Fábrica: MASTERPRINT Unidade: UN/1 F1 F4

UN: R\$ 7,18 AV: R\$ 7,18 15: R\$ 7,33
30: R\$ 7,48 45: R\$ 7,63 60: R\$ 7,78



TINTA IMP EPSON REFIL 100ML CYA 664/673

Código: 38241 Fábrica: MASTERPRINT Unidade: UN/1 F1 F4

UN: R\$ 7,18 AV: R\$ 7,18 15: R\$ 7,33
30: R\$ 7,48 45: R\$ 7,63 60: R\$ 7,78



TINTA IMP EPSON REFIL 100ML MAG 664/673

Código: 38240 Fábrica: MASTERPRINT Unidade: UN/1 F1 F4

UN: R\$ 8,47 AV: R\$ 8,47 15: R\$ 8,65
30: R\$ 8,82 45: R\$ 9,00 60: R\$ 9,18



TINTA IMP EPSON REFIL 100ML MAG 673

Código: 45119 Fábrica: MASTERPRINT Unidade: UN/1 F1 F4

UN: R\$ 7,18 AV: R\$ 7,18 15: R\$ 7,33
30: R\$ 7,48 45: R\$ 7,63 60: R\$ 7,78



TINTA IMP EPSON REFIL 100ML YEL 664/673

Código: 38239 Fábrica: MASTERPRINT Unidade: UN/1 F1 F4

UN: R\$ 11,17 AV: R\$ 11,17 15: R\$ 11,40
30: R\$ 11,63 45: R\$ 11,86 60: R\$ 12,10



TINTA IMP EPSON REFIL 127ML 504/544 BK

Código: 45120 Fábrica: MASTERPRINT Unidade: UN/1 F1 F4

UN: R\$ 36,97 AV: R\$ 36,97 15: R\$ 37,74
30: R\$ 38,49 45: R\$ 39,26 60: R\$ 40,05



TINTA IMP EPSON 1 LT UNIVER BK

Código: 38246 Fábrica: MASTERPRINT Unidade: UN/1 F1 F4

UN: R\$ 38,70 AV: R\$ 38,70 15: R\$ 39,51
30: R\$ 40,30 45: R\$ 41,11 60: R\$ 41,93



TINTA IMP EPSON 1 LT UNIVER CYAN

Código: 38245 Fábrica: MASTERPRINT Unidade: UN/1 F1 F4

UN: R\$ 38,70 AV: R\$ 38,70 15: R\$ 39,51
30: R\$ 40,30 45: R\$ 41,11 60: R\$ 41,93



TINTA IMP EPSON 1 LT UNIVER MAGENTA

Código: 38243 Fábrica: MASTERPRINT Unidade: UN/1 F1 F4

UN: R\$ 38,70 AV: R\$ 38,70 15: R\$ 39,51
30: R\$ 40,30 45: R\$ 41,11 60: R\$ 41,93



TINTA IMP EPSON 1 LT UNIVER YELLOW

Código: 38244 Fábrica: MASTERPRINT Unidade: UN/1 F1 F4

UN: R\$ 8,21 AV: R\$ 8,21 15: R\$ 8,38
30: R\$ 8,55 45: R\$ 8,72 60: R\$ 8,89



TINTA IMP HP REFIL 100ML UNIVER BK

Código: 46177 Fábrica: MASTERPRINT Unidade: UN/1 F1 F4

UN: R\$ 8,21 AV: R\$ 8,21 15: R\$ 8,38
30: R\$ 8,55 45: R\$ 8,72 60: R\$ 8,89



TINTA IMP HP REFIL 100ML UNIVER CYAN

Código: 46178 Fábrica: MASTERPRINT Unidade: UN/1 F1 F4

UN: R\$ 8,21 AV: R\$ 8,21 15: R\$ 8,38
30: R\$ 8,55 45: R\$ 8,72 60: R\$ 8,89



TINTA IMP HP REFIL 100ML UNIVER MAGENTA

Código: 46179 Fábrica: MASTERPRINT Unidade: UN/1 F1 F4

UN: R\$ 8,21 AV: R\$ 8,21 15: R\$ 8,38
30: R\$ 8,55 45: R\$ 8,72 60: R\$ 8,89



TINTA IMP HP REFIL 100ML UNIVER YELLOW

Código: 46180 Fábrica: MASTERPRINT Unidade: UN/1 F1 F4

UN: R\$ 63,69 AV: R\$ 63,69 15: R\$ 65,01
30: R\$ 66,31 45: R\$ 67,64 60: R\$ 68,99



TINTA IMP HP 1 LT UNIVERSAL BK

Código: 40889 Fábrica: MASTERPRINT Unidade: UN/1 F1 F4

UN: R\$ 6,46 AV: R\$ 6,46 15: R\$ 6,60
30: R\$ 6,73 45: R\$ 6,86 60: R\$ 7,00



TINTA P/CARIMBO 40 ML AZUL 132 UN

Código: 41959 Fábrica: CARBRINK Unidade: UN/1 F1 F4

UN: R\$ 6,46 AV: R\$ 6,46 15: R\$ 6,60
30: R\$ 6,73 45: R\$ 6,86 60: R\$ 7,00



TINTA P/CARIMBO 40 ML PRETO 133 UN

Código: 41958 Fábrica: CARBRINK Unidade: UN/1 F1 F4

UN: R\$ 6,42 AV: R\$ 77,04 15: R\$ 78,65
30: R\$ 80,22 45: R\$ 81,82 60: R\$ 83,46



TINTA P/CARIMBO 40 ML PRETO 133 12X1

Código: 12583 Fábrica: CARBRINK Unidade: DZ/12 F1 F4

UN: R\$ 6,46 AV: R\$ 6,46 15: R\$ 6,60
30: R\$ 6,73 45: R\$ 6,86 60: R\$ 7,00



TINTA P/CARIMBO 40 ML VERMELHO 134 UN

Código: 41960 Fábrica: CARBRI/RADEX Unidade: UN/1 F1 F4

UN: R\$ 4,71 AV: R\$ 4,71 15: R\$ 4,81
30: R\$ 4,91 45: R\$ 5,01 60: R\$ 5,11



TINTA PINCEL MARC PERM 20ML AZUL UN

Código: 47139 Fábrica: BRW Unidade: UN/1 F1 F4

UN: R\$ 4,28 AV: R\$ 51,35 15: R\$ 52,42
30: R\$ 53,47 45: R\$ 54,54 60: R\$ 55,63



TINTA PINCEL MARC PERM 20ML AZUL 12X1

Código: 23188 Fábrica: BRW Unidade: DZ/12 F1 F4

UN: R\$ 4,71 AV: R\$ 4,71 15: R\$ 4,81
30: R\$ 4,91 45: R\$ 5,01 60: R\$ 5,11



TINTA PINCEL MARC PERM 20ML PRETO UN
Código: Fábrika: Unidade:
47172 BRW UN/1
F1 F4

UN: R\$ 4,28 AV: R\$ 51,35 15: R\$ 52,42
30: R\$ 53,47 45: R\$ 54,54 60: R\$ 55,63



TINTA PINCEL MARC PERM 20ML PRETO 12X1
Código: Fábrika: Unidade:
12584 BRW DZ/12
F1 F4

UN: R\$ 4,28 AV: R\$ 51,35 15: R\$ 52,42
30: R\$ 53,47 45: R\$ 54,54 60: R\$ 55,63



TINTA PINCEL MARC PERM 20ML VERDE 12X1
Código: Fábrika: Unidade:
44997 BRW DZ/12
F1 F4

UN: R\$ 4,28 AV: R\$ 51,35 15: R\$ 52,42
30: R\$ 53,47 45: R\$ 54,54 60: R\$ 55,63



TINTA PINCEL MARC PERM 20ML VERMEL 12X1
Código: Fábrika: Unidade:
19881 BRW DZ/12
F1 F4

UN: R\$ 4,71 AV: R\$ 4,71 15: R\$ 4,81
30: R\$ 4,91 45: R\$ 5,01 60: R\$ 5,11



TINTA PINCEL MARC PERM 20ML VERMELHO UN
Código: Fábrika: Unidade:
47140 BRW UN/1
F1 F4

UN: R\$ 9,80 AV: R\$ 9,80 15: R\$ 10,00
30: R\$ 10,20 45: R\$ 10,41 60: R\$ 10,62



TINTA PINCEL MARC PERM 40ML AZUL UN
Código: Fábrika: Unidade:
45141 CARBRINK UN/1
F1 F4

UN: R\$ 5,90 AV: R\$ 70,83 15: R\$ 72,30
30: R\$ 73,75 45: R\$ 75,22 60: R\$ 76,73



TINTA PINCEL MARC QDO BCO 20ML AZU 12X1
Código: Fábrika: Unidade:
33683 BRW DZ/12
F1 F4

UN: R\$ 5,90 AV: R\$ 70,83 15: R\$ 72,30
30: R\$ 73,75 45: R\$ 75,22 60: R\$ 76,73



TINTA PINCEL MARC QDO BCO 20ML PTO 12X1
Código: Fábrika: Unidade:
33682 BRW DZ/12
F1 F4

UN: R\$ 5,90 AV: R\$ 70,83 15: R\$ 72,30
30: R\$ 73,75 45: R\$ 75,22 60: R\$ 76,73



TINTA PINCEL MARC QDO BCO 20ML VD 12X1
Código: Fábrika: Unidade:
44998 BRW DZ/12
F1 F4

UN: R\$ 5,90 AV: R\$ 70,83 15: R\$ 72,30
30: R\$ 73,75 45: R\$ 75,22 60: R\$ 76,73



TINTA PINCEL MARC QDO BCO 20ML VM 12X1
Código: Fábrika: Unidade:
38015 BRW DZ/12
F1 F4

UN: R\$ 84,56 AV: R\$ 84,56 15: R\$ 86,32
30: R\$ 88,05 45: R\$ 89,81 60: R\$ 91,60



TINTA PINCEL MARC QDO BCO 500ML AZUL UN
Código: Fábrika: Unidade:
44157 BRW UN/1
F1 F4

UN: R\$ 84,56 AV: R\$ 84,56 15: R\$ 86,32
30: R\$ 88,05 45: R\$ 89,81 60: R\$ 91,60



TINTA PINCEL MARC QDO BCO 500ML PRETO UN
Código: Fábrika: Unidade:
44158 BRW UN/1
F1 F4

UN: R\$ 84,56 AV: R\$ 84,56 15: R\$ 86,32
30: R\$ 88,05 45: R\$ 89,81 60: R\$ 91,60



TINTA PINCEL MARC QDO BCO 500ML VERM UN
Código: Fábrika: Unidade:
44159 BRW UN/1
F1 F4

UN: R\$ 3,75 AV: R\$ 45,00 15: R\$ 45,94
30: R\$ 46,86 45: R\$ 47,80 60: R\$ 48,75



TINTA PINCEL MARC QDO BCO 5,5ML AZU 12X1
Código: Fábrika: Unidade:
47479 BRW CX/12
F1 F4

UN: R\$ 3,75 AV: R\$ 45,00 15: R\$ 45,94
30: R\$ 46,86 45: R\$ 47,80 60: R\$ 48,75



TINTA PINCEL MARC QDO BCO 5,5ML PTO 12X1
Código: Fábrika: Unidade:
47785 BRW CX/12
F1 F4

UN: R\$ 3,75 AV: R\$ 45,00 15: R\$ 45,94
30: R\$ 46,86 45: R\$ 47,80 60: R\$ 48,75



TINTA PINCEL MARC QDO BCO 5,5ML VM 12X1
Código: Fábrika: Unidade:
47506 BRW CX/12
F1 F4

UN: R\$ 1,53 AV: R\$ 9,15 15: R\$ 9,34
30: R\$ 9,53 45: R\$ 9,72 60: R\$ 9,92



TINTA PINTURA DEDO 15ML 6 CORES SORT

Código: Fábrica: Unidade:
45498 ACRILEX CX/6
F1 F4

UN: R\$ 4,18 AV: R\$ 25,10 15: R\$ 25,63
30: R\$ 26,14 45: R\$ 26,66 60: R\$ 27,20



TINTA PINTURA FACIAL 4GR COR CREMOSA 6X1

Código: Fábrica: Unidade:
50761 MARIPEL CR/6
F1 F4

UN: R\$ 7,04 AV: R\$ 7,04 15: R\$ 7,19
30: R\$ 7,33 45: R\$ 7,48 60: R\$ 7,63



TINTA PVA 37ML FOSCA 501 AZUL TURQUESA

Código: Fábrica: Unidade:
48237 ACRILEX UN/1
F1 F4

UN: R\$ 6,15 AV: R\$ 6,15 15: R\$ 6,28
30: R\$ 6,41 45: R\$ 6,53 60: R\$ 6,67



TINTA PVA 37ML FOSCA 503 AZUL CELESTE

Código: Fábrica: Unidade:
48238 ACRILEX UN/1
F1 F4

UN: R\$ 6,15 AV: R\$ 6,15 15: R\$ 6,28
30: R\$ 6,41 45: R\$ 6,53 60: R\$ 6,67



TINTA PVA 37ML FOSCA 504 AMARELO LIMAO

Código: Fábrica: Unidade:
48239 ACRILEX UN/1
F1 F4

UN: R\$ 6,15 AV: R\$ 6,15 15: R\$ 6,28
30: R\$ 6,41 45: R\$ 6,53 60: R\$ 6,67



TINTA PVA 37ML FOSCA 505 AMARELO OURO

Código: Fábrica: Unidade:
48240 ACRILEX UN/1
F1 F4

UN: R\$ 6,15 AV: R\$ 6,15 15: R\$ 6,28
30: R\$ 6,41 45: R\$ 6,53 60: R\$ 6,67



TINTA PVA 37ML FOSCA 507 VERMELHO FOGO

Código: Fábrica: Unidade:
48241 ACRILEX UN/1
F1 F4

UN: R\$ 6,15 AV: R\$ 6,15 15: R\$ 6,28
30: R\$ 6,41 45: R\$ 6,53 60: R\$ 6,67



TINTA PVA 37ML FOSCA 508 VERMELHO ESCAR

Código: Fábrica: Unidade:
48242 ACRILEX UN/1
F1 F4

UN: R\$ 6,15 AV: R\$ 6,15 15: R\$ 6,28
30: R\$ 6,41 45: R\$ 6,53 60: R\$ 6,67



TINTA PVA 37ML FOSCA 510 VERDE FOLHA

Código: Fábrica: Unidade:
48243 ACRILEX UN/1
F1 F4

UN: R\$ 6,15 AV: R\$ 6,15 15: R\$ 6,28
30: R\$ 6,41 45: R\$ 6,53 60: R\$ 6,67



TINTA PVA 37ML FOSCA 511 VERDE BANDEIRA

Código: Fábrica: Unidade:
48244 ACRILEX UN/1
F1 F4

UN: R\$ 6,15 AV: R\$ 6,15 15: R\$ 6,28
30: R\$ 6,41 45: R\$ 6,53 60: R\$ 6,67



TINTA PVA 37ML FOSCA 513 VERDE MUSGO

Código: Fábrica: Unidade:
48245 ACRILEX UN/1
F1 F4

UN: R\$ 6,15 AV: R\$ 6,15 15: R\$ 6,28
30: R\$ 6,41 45: R\$ 6,53 60: R\$ 6,67



TINTA PVA 37ML FOSCA 516 VIOLETA

Código: Fábrica: Unidade:
48246 ACRILEX UN/1
F1 F4

UN: R\$ 6,15 AV: R\$ 6,15 15: R\$ 6,28
30: R\$ 6,41 45: R\$ 6,53 60: R\$ 6,67



TINTA PVA 37ML FOSCA 517 LARANJA

Código: Fábrica: Unidade:
48247 ACRILEX UN/1
F1 F4

UN: R\$ 6,15 AV: R\$ 6,15 15: R\$ 6,28
30: R\$ 6,41 45: R\$ 6,53 60: R\$ 6,67



TINTA PVA 37ML FOSCA 519 BRANCO

Código: Fábrica: Unidade:
48235 ACRILEX UN/1
F1 F4

UN: R\$ 6,15 AV: R\$ 6,15 15: R\$ 6,28
30: R\$ 6,41 45: R\$ 6,53 60: R\$ 6,67



TINTA PVA 37ML FOSCA 520 PRETO

Código: Fábrica: Unidade:
48262 ACRILEX UN/1
F1 F4

UN: R\$ 6,15 AV: R\$ 6,15 15: R\$ 6,28
30: R\$ 6,41 45: R\$ 6,53 60: R\$ 6,67



TINTA PVA 37ML FOSCA 528 LILAS

Código: Fábrica: Unidade:
48248 ACRILEX UN/1
F1 F4

UN: R\$ 6,15 AV: R\$ 6,15 15: R\$ 6,28
30: R\$ 6,41 45: R\$ 6,53 60: R\$ 6,67



TINTA PVA 37ML FOSCA 531 MARRON
Código: Fábrica: Unidade:
48249 ACRILEX UN/1
F1 F4

UN: R\$ 6,15 AV: R\$ 6,15 15: R\$ 6,28
30: R\$ 6,41 45: R\$ 6,53 60: R\$ 6,67



TINTA PVA 37ML FOSCA 535 AZUL MAR
Código: Fábrica: Unidade:
48250 ACRILEX UN/1
F1 F4

UN: R\$ 6,15 AV: R\$ 6,15 15: R\$ 6,28
30: R\$ 6,41 45: R\$ 6,53 60: R\$ 6,67



TINTA PVA 37ML FOSCA 537 ROSA
Código: Fábrica: Unidade:
48251 ACRILEX UN/1
F1 F4

UN: R\$ 6,15 AV: R\$ 6,15 15: R\$ 6,28
30: R\$ 6,41 45: R\$ 6,53 60: R\$ 6,67



TINTA PVA 37ML FOSCA 538 AMARELO PESSEG
Código: Fábrica: Unidade:
48252 ACRILEX UN/1
F1 F4

UN: R\$ 6,15 AV: R\$ 6,15 15: R\$ 6,28
30: R\$ 6,41 45: R\$ 6,53 60: R\$ 6,67



TINTA PVA 37ML FOSCA 541 VERMELHO VIVO
Código: Fábrica: Unidade:
48253 ACRILEX UN/1
F1 F4

UN: R\$ 6,15 AV: R\$ 6,15 15: R\$ 6,28
30: R\$ 6,41 45: R\$ 6,53 60: R\$ 6,67



TINTA PVA 37ML FOSCA 542 ROSA ESCURO
Código: Fábrica: Unidade:
48254 ACRILEX UN/1
F1 F4

UN: R\$ 6,15 AV: R\$ 6,15 15: R\$ 6,28
30: R\$ 6,41 45: R\$ 6,53 60: R\$ 6,67



TINTA PVA 37ML FOSCA 549 MAGENTA
Código: Fábrica: Unidade:
48255 ACRILEX UN/1
F1 F4

UN: R\$ 6,15 AV: R\$ 6,15 15: R\$ 6,28
30: R\$ 6,41 45: R\$ 6,53 60: R\$ 6,67



TINTA PVA 37ML FOSCA 565 VINHO
Código: Fábrica: Unidade:
48256 ACRILEX UN/1
F1 F4

UN: R\$ 6,15 AV: R\$ 6,15 15: R\$ 6,28
30: R\$ 6,41 45: R\$ 6,53 60: R\$ 6,67



TINTA PVA 37ML FOSCA 567 ROSA CHA
Código: Fábrica: Unidade:
48406 ACRILEX UN/1
F1 F4

UN: R\$ 7,04 AV: R\$ 7,04 15: R\$ 7,19
30: R\$ 7,33 45: R\$ 7,48 60: R\$ 7,63



TINTA PVA 37ML FOSCA 574 CINZA LUNAR
Código: Fábrica: Unidade:
48405 ACRILEX UN/1
F1 F4

UN: R\$ 6,15 AV: R\$ 6,15 15: R\$ 6,28
30: R\$ 6,41 45: R\$ 6,53 60: R\$ 6,67



TINTA PVA 37ML FOSCA 577 TURQUESA
Código: Fábrica: Unidade:
48257 ACRILEX UN/1
F1 F4

UN: R\$ 6,15 AV: R\$ 6,15 15: R\$ 6,28
30: R\$ 6,41 45: R\$ 6,53 60: R\$ 6,67



TINTA PVA 37ML FOSCA 813 ROSA BB
Código: Fábrica: Unidade:
48258 ACRILEX UN/1
F1 F4

UN: R\$ 6,15 AV: R\$ 6,15 15: R\$ 6,28
30: R\$ 6,41 45: R\$ 6,53 60: R\$ 6,67



TINTA PVA 37ML FOSCA 817 AREIA
Código: Fábrica: Unidade:
48259 ACRILEX UN/1
F1 F4

UN: R\$ 6,15 AV: R\$ 6,15 15: R\$ 6,28
30: R\$ 6,41 45: R\$ 6,53 60: R\$ 6,67



TINTA PVA 37ML FOSCA 829 FLAMINGO
Código: Fábrica: Unidade:
48260 ACRILEX UN/1
F1 F4

UN: R\$ 28,73 AV: R\$ 28,73 15: R\$ 29,32
30: R\$ 29,91 45: R\$ 30,51 60: R\$ 31,12



































TINTA SPRAY 350ML 250G ALUMINIO
Código: Fábrica: Unidade:
42226 TEK BOND UN/1
F1 F4

UN: R\$ 25,20 AV: R\$ 25,20 15: R\$ 25,73
30: R\$ 26,24 45: R\$ 26,77 60: R\$ 27,30



TINTA SPRAY 350ML 250G AMARELO
Código: Fábrica: Unidade:
42220 TEK BOND UN/1
F1 F4

<p>UN: R\$ 25,20 AV: R\$ 25,20 15: R\$ 25,73 30: R\$ 26,24 45: R\$ 26,77 60: R\$ 27,30</p>  <p>TINTA SPRAY 350ML 250G AZUL</p> <p>Código: Fábrica: Unidade: 42222 TEK BOND UN/1 F1 F4</p>	<p>UN: R\$ 22,76 AV: R\$ 22,76 15: R\$ 23,24 30: R\$ 23,70 45: R\$ 24,18 60: R\$ 24,66</p>  <p>TINTA SPRAY 350ML 250G BRANCO BRILHANTE</p> <p>Código: Fábrica: Unidade: 42214 TEK BOND UN/1 F1 F4</p>	<p>UN: R\$ 22,76 AV: R\$ 22,76 15: R\$ 23,24 30: R\$ 23,70 45: R\$ 24,18 60: R\$ 24,66</p>  <p>TINTA SPRAY 350ML 250G BRANCO FOSCO</p> <p>Código: Fábrica: Unidade: 42215 TEK BOND UN/1 F1 F4</p>	<p>UN: R\$ 39,79 AV: R\$ 39,79 15: R\$ 40,62 30: R\$ 41,44 45: R\$ 42,26 60: R\$ 43,11</p>  <p>TINTA SPRAY 350ML 250G DOURADO</p> <p>Código: Fábrica: Unidade: 42218 TEK BOND UN/1 F1 F4</p>
<p>UN: R\$ 25,20 AV: R\$ 25,20 15: R\$ 25,73 30: R\$ 26,24 45: R\$ 26,77 60: R\$ 27,30</p>  <p>TINTA SPRAY 350ML 250G GELO</p> <p>Código: Fábrica: Unidade: 48646 TEK BOND UN/1 F1 F4</p>	<p>UN: R\$ 25,20 AV: R\$ 25,20 15: R\$ 25,73 30: R\$ 26,24 45: R\$ 26,77 60: R\$ 27,30</p>  <p>TINTA SPRAY 350ML 250G GRAFITE</p> <p>Código: Fábrica: Unidade: 48645 TEK BOND UN/1 F1 F4</p>	<p>UN: R\$ 25,20 AV: R\$ 25,20 15: R\$ 25,73 30: R\$ 26,24 45: R\$ 26,77 60: R\$ 27,30</p>  <p>TINTA SPRAY 350ML 250G LARANJA</p> <p>Código: Fábrica: Unidade: 42224 TEK BOND UN/1 F1 F4</p>	<p>UN: R\$ 25,20 AV: R\$ 25,20 15: R\$ 25,73 30: R\$ 26,24 45: R\$ 26,77 60: R\$ 27,30</p>  <p>TINTA SPRAY 350ML 250G PLATINA</p> <p>Código: Fábrica: Unidade: 48647 TEK BOND UN/1 F1 F4</p>
<p>UN: R\$ 25,20 AV: R\$ 25,20 15: R\$ 25,73 30: R\$ 26,24 45: R\$ 26,77 60: R\$ 27,30</p>  <p>TINTA SPRAY 350ML 250G PREMIER FUNDO</p> <p>Código: Fábrica: Unidade: 42227 TEK BOND UN/1 F1 F4</p>	<p>UN: R\$ 22,76 AV: R\$ 22,76 15: R\$ 23,24 30: R\$ 23,70 45: R\$ 24,18 60: R\$ 24,66</p>  <p>TINTA SPRAY 350ML 250G PRETO BRILHANTE</p> <p>Código: Fábrica: Unidade: 42216 TEK BOND UN/1 F1 F4</p>	<p>UN: R\$ 22,76 AV: R\$ 22,76 15: R\$ 23,24 30: R\$ 23,70 45: R\$ 24,18 60: R\$ 24,66</p>  <p>TINTA SPRAY 350ML 250G PRETO FOSCO</p> <p>Código: Fábrica: Unidade: 42217 TEK BOND UN/1 F1 F4</p>	<p>UN: R\$ 25,20 AV: R\$ 25,20 15: R\$ 25,73 30: R\$ 26,24 45: R\$ 26,77 60: R\$ 27,30</p>  <p>TINTA SPRAY 350ML 250G ROSA</p> <p>Código: Fábrica: Unidade: 42225 TEK BOND UN/1 F1 F4</p>
<p>UN: R\$ 28,42 AV: R\$ 28,42 15: R\$ 29,01 30: R\$ 29,59 45: R\$ 30,18 60: R\$ 30,79</p>  <p>TINTA SPRAY 350ML 250G VERDE</p> <p>Código: Fábrica: Unidade: 42223 TEK BOND UN/1 F1 F4</p>	<p>UN: R\$ 28,42 AV: R\$ 28,42 15: R\$ 29,01 30: R\$ 29,59 45: R\$ 30,18 60: R\$ 30,79</p>  <p>TINTA SPRAY 350ML 250G VERMELHO</p> <p>Código: Fábrica: Unidade: 42219 TEK BOND UN/1 F1 F4</p>	<p>UN: R\$ 10,26 AV: R\$ 10,26 15: R\$ 10,48 30: R\$ 10,69 45: R\$ 10,90 60: R\$ 11,12</p>  <p>TINTA TECIDO 35ML ACRIPUFF 501 AZUL TUR</p> <p>Código: Fábrica: Unidade: 44838 ACRILEX UN/1 F1 F4</p>	<p>UN: R\$ 10,26 AV: R\$ 10,26 15: R\$ 10,48 30: R\$ 10,69 45: R\$ 10,90 60: R\$ 11,12</p>  <p>TINTA TECIDO 35ML ACRIPUFF 505 AMARELO</p> <p>Código: Fábrica: Unidade: 44840 ACRILEX UN/1 F1 F4</p>

<p>UN: R\$ 10,26 AV: R\$ 10,26 15: R\$ 10,48 30: R\$ 10,69 45: R\$ 10,90 60: R\$ 11,12</p>  <p>TINTA TECIDO 35ML ACRIPUFF 507 VERMELHO Código: Fábrika: Unidade: 44841 ACRILEX UN/1 F1 F4</p>	<p>UN: R\$ 10,26 AV: R\$ 10,26 15: R\$ 10,48 30: R\$ 10,69 45: R\$ 10,90 60: R\$ 11,12</p>  <p>TINTA TECIDO 35ML ACRIPUFF 513 VERDE MU Código: Fábrika: Unidade: 44845 ACRILEX UN/1 F1 F4</p>	<p>UN: R\$ 10,26 AV: R\$ 10,26 15: R\$ 10,48 30: R\$ 10,69 45: R\$ 10,90 60: R\$ 11,12</p>  <p>TINTA TECIDO 35ML ACRIPUFF 519 BRANCO Código: Fábrika: Unidade: 44837 ACRILEX UN/1 F1 F4</p>	<p>UN: R\$ 10,26 AV: R\$ 10,26 15: R\$ 10,48 30: R\$ 10,69 45: R\$ 10,90 60: R\$ 11,12</p>  <p>TINTA TECIDO 35ML ACRIPUFF 520 PRETO Código: Fábrika: Unidade: 44839 ACRILEX UN/1 F1 F4</p>
<p>UN: R\$ 10,26 AV: R\$ 10,26 15: R\$ 10,48 30: R\$ 10,69 45: R\$ 10,90 60: R\$ 11,12</p>  <p>TINTA TECIDO 35ML ACRIPUFF 531 MARRON Código: Fábrika: Unidade: 44842 ACRILEX UN/1 F1 F4</p>	<p>UN: R\$ 10,26 AV: R\$ 10,26 15: R\$ 10,48 30: R\$ 10,69 45: R\$ 10,90 60: R\$ 11,12</p>  <p>TINTA TECIDO 35ML ACRIPUFF 537 ROSA Código: Fábrika: Unidade: 44843 ACRILEX UN/1 F1 F4</p>	<p>UN: R\$ 10,26 AV: R\$ 10,26 15: R\$ 10,48 30: R\$ 10,69 45: R\$ 10,90 60: R\$ 11,12</p>  <p>TINTA TECIDO 35ML ACRIPUFF 540 VIOLETA Código: Fábrika: Unidade: 44844 ACRILEX UN/1 F1 F4</p>	<p>UN: R\$ 4,61 AV: R\$ 4,61 15: R\$ 4,71 30: R\$ 4,80 45: R\$ 4,90 60: R\$ 5,00</p>  <p>TINTA TECIDO 37ML AMARELO SOL Código: Fábrika: Unidade: 48632 TEK BOND UN/1 F1 F4</p>
<p>UN: R\$ 4,61 AV: R\$ 4,61 15: R\$ 4,71 30: R\$ 4,80 45: R\$ 4,90 60: R\$ 5,00</p>  <p>TINTA TECIDO 37ML AZUL CARIBE Código: Fábrika: Unidade: 50727 TEK BOND UN/1 F1 F4</p>	<p>UN: R\$ 4,61 AV: R\$ 4,61 15: R\$ 4,71 30: R\$ 4,80 45: R\$ 4,90 60: R\$ 5,00</p>  <p>TINTA TECIDO 37ML AZUL ROYAL Código: Fábrika: Unidade: 48636 TEK BOND UN/1 F1 F4</p>	<p>UN: R\$ 4,61 AV: R\$ 4,61 15: R\$ 4,71 30: R\$ 4,80 45: R\$ 4,90 60: R\$ 5,00</p>  <p>TINTA TECIDO 37ML BRANCO Código: Fábrika: Unidade: 48629 TEK BOND UN/1 F1 F4</p>	<p>UN: R\$ 4,61 AV: R\$ 4,61 15: R\$ 4,71 30: R\$ 4,80 45: R\$ 4,90 60: R\$ 5,00</p>  <p>TINTA TECIDO 37ML LILAS Código: Fábrika: Unidade: 48637 TEK BOND UN/1 F1 F4</p>
<p>UN: R\$ 4,61 AV: R\$ 4,61 15: R\$ 4,71 30: R\$ 4,80 45: R\$ 4,90 60: R\$ 5,00</p>  <p>TINTA TECIDO 37ML MARRON Código: Fábrika: Unidade: 48635 TEK BOND UN/1 F1 F4</p>	<p>UN: R\$ 4,61 AV: R\$ 4,61 15: R\$ 4,71 30: R\$ 4,80 45: R\$ 4,90 60: R\$ 5,00</p>  <p>TINTA TECIDO 37ML PINK Código: Fábrika: Unidade: 48638 TEK BOND UN/1 F1 F4</p>	<p>UN: R\$ 4,61 AV: R\$ 4,61 15: R\$ 4,71 30: R\$ 4,80 45: R\$ 4,90 60: R\$ 5,00</p>  <p>TINTA TECIDO 37ML PRETO Código: Fábrika: Unidade: 48630 TEK BOND UN/1 F1 F4</p>	<p>UN: R\$ 4,61 AV: R\$ 4,61 15: R\$ 4,71 30: R\$ 4,80 45: R\$ 4,90 60: R\$ 5,00</p>  <p>TINTA TECIDO 37ML ROSA CRUSH Código: Fábrika: Unidade: 50732 TEK BOND UN/1 F1 F4</p>

UN: R\$ 4,61 AV: R\$ 4,61 15: R\$ 4,71
30: R\$ 4,80 45: R\$ 4,90 60: R\$ 5,00



TINTA TECIDO 37ML ROXO

Código: 48633 Fábrica: TEK BOND Unidade: UN/1 F1 F4

UN: R\$ 4,61 AV: R\$ 4,61 15: R\$ 4,71
30: R\$ 4,80 45: R\$ 4,90 60: R\$ 5,00



TINTA TECIDO 37ML VERDE FLORESTA

Código: 48634 Fábrica: TEK BOND Unidade: UN/1 F1 F4

UN: R\$ 4,61 AV: R\$ 4,61 15: R\$ 4,71
30: R\$ 4,80 45: R\$ 4,90 60: R\$ 5,00



TINTA TECIDO 37ML VERDE GRAMA

Código: 50729 Fábrica: TEK BOND Unidade: UN/1 F1 F4

UN: R\$ 4,61 AV: R\$ 4,61 15: R\$ 4,71
30: R\$ 4,80 45: R\$ 4,90 60: R\$ 5,00



TINTA TECIDO 37ML VERMELHO

Código: 48631 Fábrica: TEK BOND Unidade: UN/1 F1 F4

UN: R\$ 4,61 AV: R\$ 4,61 15: R\$ 4,71
30: R\$ 4,80 45: R\$ 4,90 60: R\$ 5,00



TINTA TECIDO 37ML VERMELHO AMOR

Código: 50724 Fábrica: TEK BOND Unidade: UN/1 F1 F4

UN: R\$ 4,61 AV: R\$ 4,61 15: R\$ 4,71
30: R\$ 4,80 45: R\$ 4,90 60: R\$ 5,00



TINTA TECIDO 37ML VERMELHO CARMESIM

Código: 50730 Fábrica: TEK BOND Unidade: UN/1 F1 F4

UN: R\$ 4,61 AV: R\$ 4,61 15: R\$ 4,71
30: R\$ 4,80 45: R\$ 4,90 60: R\$ 5,00



TINTA TECIDO 37ML VERMELHO PIMENTA

Código: 50726 Fábrica: TEK BOND Unidade: UN/1 F1 F4

UN: R\$ 4,61 AV: R\$ 4,61 15: R\$ 4,71
30: R\$ 4,80 45: R\$ 4,90 60: R\$ 5,00



TINTA TECIDO 37ML VERMELHO SANGUE

Código: 50725 Fábrica: TEK BOND Unidade: UN/1 F1 F4

UN: R\$ 4,61 AV: R\$ 4,61 15: R\$ 4,71
30: R\$ 4,80 45: R\$ 4,90 60: R\$ 5,00



TINTA TECIDO 37ML VERMELHO TELHA

Código: 50731 Fábrica: TEK BOND Unidade: UN/1 F1 F4

UN: R\$ 7,04 AV: R\$ 7,04 15: R\$ 7,19
30: R\$ 7,33 45: R\$ 7,48 60: R\$ 7,63



TINTA TECIDO 37ML 500 CLAREADOR

Código: 44854 Fábrica: ACRILEX Unidade: UN/1 F1 F4

UN: R\$ 7,04 AV: R\$ 7,04 15: R\$ 7,19
30: R\$ 7,33 45: R\$ 7,48 60: R\$ 7,63



TINTA TECIDO 37ML 501 AZUL TURQUESA

Código: 45022 Fábrica: ACRILEX Unidade: UN/1 F1 F4

UN: R\$ 7,04 AV: R\$ 7,04 15: R\$ 7,19
30: R\$ 7,33 45: R\$ 7,48 60: R\$ 7,63



TINTA TECIDO 37ML 502 AZUL COBALTO

Código: 44937 Fábrica: ACRILEX Unidade: UN/1 F1 F4

UN: R\$ 7,04 AV: R\$ 7,04 15: R\$ 7,19
30: R\$ 7,33 45: R\$ 7,48 60: R\$ 7,63



TINTA TECIDO 37ML 503 AZUL CELESTE

Código: 44856 Fábrica: ACRILEX Unidade: UN/1 F1 F4

UN: R\$ 7,04 AV: R\$ 7,04 15: R\$ 7,19
30: R\$ 7,33 45: R\$ 7,48 60: R\$ 7,63



TINTA TECIDO 37ML 504 AMARELO LIMAO

Código: 44893 Fábrica: ACRILEX Unidade: UN/1 F1 F4

UN: R\$ 7,04 AV: R\$ 7,04 15: R\$ 7,19
30: R\$ 7,33 45: R\$ 7,48 60: R\$ 7,63



TINTA TECIDO 37ML 505 AMARELO OURO

Código: 44896 Fábrica: ACRILEX Unidade: UN/1 F1 F4

UN: R\$ 7,04 AV: R\$ 7,04 15: R\$ 7,19
30: R\$ 7,33 45: R\$ 7,48 60: R\$ 7,63



TINTA TECIDO 37ML 506 CERAMICA

Código: 44952 Fábrica: ACRILEX Unidade: UN/1 F1 F4

UN: R\$ 7,04 AV: R\$ 7,04 15: R\$ 7,18
30: R\$ 7,33 45: R\$ 7,47 60: R\$ 7,63



TINTA TECIDO 37ML 507 VERMELHO FOGO
Código: Fábrica: Unidade:
44920 ACRILEX UN/1
F1 F4

UN: R\$ 7,04 AV: R\$ 7,04 15: R\$ 7,19
30: R\$ 7,33 45: R\$ 7,48 60: R\$ 7,63



TINTA TECIDO 37ML 508 VERMELHO ESCARLAT
Código: Fábrica: Unidade:
44912 ACRILEX UN/1
F1 F4

UN: R\$ 7,04 AV: R\$ 7,04 15: R\$ 7,19
30: R\$ 7,33 45: R\$ 7,48 60: R\$ 7,63



TINTA TECIDO 37ML 509 VERMELHO CARMIN
Código: Fábrica: Unidade:
44913 ACRILEX UN/1
F1 F4

UN: R\$ 7,04 AV: R\$ 7,04 15: R\$ 7,19
30: R\$ 7,33 45: R\$ 7,48 60: R\$ 7,63



TINTA TECIDO 37ML 510 VERDE FOLHA
Código: Fábrica: Unidade:
44933 ACRILEX UN/1
F1 F4

UN: R\$ 7,04 AV: R\$ 7,04 15: R\$ 7,19
30: R\$ 7,33 45: R\$ 7,48 60: R\$ 7,63



TINTA TECIDO 37ML 511 VERDE BANDEIRA
Código: Fábrica: Unidade:
44930 ACRILEX UN/1
F1 F4

UN: R\$ 7,04 AV: R\$ 7,04 15: R\$ 7,19
30: R\$ 7,33 45: R\$ 7,48 60: R\$ 7,63



TINTA TECIDO 37ML 512 VERDE VERONESE
Código: Fábrica: Unidade:
44961 ACRILEX UN/1
F1 F4

UN: R\$ 7,04 AV: R\$ 7,04 15: R\$ 7,19
30: R\$ 7,33 45: R\$ 7,48 60: R\$ 7,63



TINTA TECIDO 37ML 513 VERDE MUSGO
Código: Fábrica: Unidade:
44935 ACRILEX UN/1
F1 F4

UN: R\$ 7,04 AV: R\$ 7,04 15: R\$ 7,19
30: R\$ 7,33 45: R\$ 7,48 60: R\$ 7,63



TINTA TECIDO 37ML 514 TERRA QUEI
Código: Fábrica: Unidade:
44964 ACRILEX UN/1
F1 F4

UN: R\$ 7,04 AV: R\$ 7,04 15: R\$ 7,19
30: R\$ 7,33 45: R\$ 7,48 60: R\$ 7,63



TINTA TECIDO 37ML 516 VIOLETA
Código: Fábrica: Unidade:
44874 ACRILEX UN/1
F1 F4

UN: R\$ 7,04 AV: R\$ 7,04 15: R\$ 7,19
30: R\$ 7,33 45: R\$ 7,48 60: R\$ 7,63



TINTA TECIDO 37ML 517 LARANJA
Código: Fábrica: Unidade:
44942 ACRILEX UN/1
F1 F4

UN: R\$ 7,04 AV: R\$ 7,04 15: R\$ 7,19
30: R\$ 7,33 45: R\$ 7,48 60: R\$ 7,63



TINTA TECIDO 37ML 518 SALMAO
Código: Fábrica: Unidade:
44885 ACRILEX UN/1
F1 F4

UN: R\$ 7,04 AV: R\$ 7,04 15: R\$ 7,19
30: R\$ 7,33 45: R\$ 7,48 60: R\$ 7,63



TINTA TECIDO 37ML 519 BRANCO
Código: Fábrica: Unidade:
44851 ACRILEX UN/1
F1 F4

UN: R\$ 7,04 AV: R\$ 7,04 15: R\$ 7,19
30: R\$ 7,33 45: R\$ 7,48 60: R\$ 7,63



TINTA TECIDO 37ML 520 PRETO
Código: Fábrica: Unidade:
44852 ACRILEX UN/1
F1 F4

UN: R\$ 7,04 AV: R\$ 7,04 15: R\$ 7,19
30: R\$ 7,33 45: R\$ 7,48 60: R\$ 7,63



TINTA TECIDO 37ML 525 CAMURÇA
Código: Fábrica: Unidade:
44870 ACRILEX UN/1
F1 F4

UN: R\$ 7,04 AV: R\$ 7,04 15: R\$ 7,19
30: R\$ 7,33 45: R\$ 7,48 60: R\$ 7,63



TINTA TECIDO 37ML 527 ROSA PINK
Código: Fábrica: Unidade:
44903 ACRILEX UN/1
F1 F4

UN: R\$ 7,04 AV: R\$ 7,04 15: R\$ 7,19
30: R\$ 7,33 45: R\$ 7,48 60: R\$ 7,63



TINTA TECIDO 37ML 528 LILAS
Código: Fábrica: Unidade:
44888 ACRILEX UN/1
F1 F4

UN: R\$ 7,04 AV: R\$ 7,04 15: R\$ 7,19
30: R\$ 7,33 45: R\$ 7,48 60: R\$ 7,63



TINTA TECIDO 37ML 529 MARFIM

Código: 44891 Fábrica: ACRILEX Unidade: UN/1 F1 F4

UN: R\$ 7,04 AV: R\$ 7,04 15: R\$ 7,19
30: R\$ 7,33 45: R\$ 7,48 60: R\$ 7,63



TINTA TECIDO 37ML 531 MARROM

Código: 44882 Fábrica: ACRILEX Unidade: UN/1 F1 F4

UN: R\$ 7,04 AV: R\$ 7,04 15: R\$ 7,19
30: R\$ 7,33 45: R\$ 7,48 60: R\$ 7,63



TINTA TECIDO 37ML 535 AZUL MAR

Código: 45023 Fábrica: ACRILEX Unidade: UN/1 F1 F4

UN: R\$ 7,04 AV: R\$ 7,04 15: R\$ 7,19
30: R\$ 7,33 45: R\$ 7,48 60: R\$ 7,63



TINTA TECIDO 37ML 536 AMARELO CADMIO

Código: 44898 Fábrica: ACRILEX Unidade: UN/1 F1 F4

UN: R\$ 7,04 AV: R\$ 7,04 15: R\$ 7,19
30: R\$ 7,33 45: R\$ 7,48 60: R\$ 7,63



TINTA TECIDO 37ML 537 ROSA

Código: 44901 Fábrica: ACRILEX Unidade: UN/1 F1 F4

UN: R\$ 7,04 AV: R\$ 7,04 15: R\$ 7,19
30: R\$ 7,33 45: R\$ 7,48 60: R\$ 7,63



TINTA TECIDO 37ML 538 AMARELO PESSEGO

Código: 44895 Fábrica: ACRILEX Unidade: UN/1 F1 F4

UN: R\$ 7,04 AV: R\$ 7,04 15: R\$ 7,19
30: R\$ 7,33 45: R\$ 7,48 60: R\$ 7,63



TINTA TECIDO 37ML 539 SIENA NATURAL

Código: 44965 Fábrica: ACRILEX Unidade: UN/1 F1 F4

UN: R\$ 7,04 AV: R\$ 7,04 15: R\$ 7,19
30: R\$ 7,33 45: R\$ 7,48 60: R\$ 7,63



TINTA TECIDO 37ML 540 VIOLETA COBALTO

Código: 44958 Fábrica: ACRILEX Unidade: UN/1 F1 F4

UN: R\$ 7,04 AV: R\$ 7,04 15: R\$ 7,19
30: R\$ 7,33 45: R\$ 7,48 60: R\$ 7,63



TINTA TECIDO 37ML 541 VERMELHO VIVO

Código: 44915 Fábrica: ACRILEX Unidade: UN/1 F1 F4

UN: R\$ 7,04 AV: R\$ 7,04 15: R\$ 7,19
30: R\$ 7,33 45: R\$ 7,48 60: R\$ 7,63



TINTA TECIDO 37ML 542 ROSA ESCURO

Código: 44906 Fábrica: ACRILEX Unidade: UN/1 F1 F4

UN: R\$ 7,04 AV: R\$ 7,04 15: R\$ 7,19
30: R\$ 7,33 45: R\$ 7,48 60: R\$ 7,63



TINTA TECIDO 37ML 543 AZUL ULTRAMAR

Código: 44940 Fábrica: ACRILEX Unidade: UN/1 F1 F4

UN: R\$ 7,04 AV: R\$ 7,04 15: R\$ 7,19
30: R\$ 7,33 45: R\$ 7,48 60: R\$ 7,63



TINTA TECIDO 37ML 544 AZUL MARINHO

Código: 44865 Fábrica: ACRILEX Unidade: UN/1 F1 F4

UN: R\$ 7,04 AV: R\$ 7,04 15: R\$ 7,19
30: R\$ 7,33 45: R\$ 7,48 60: R\$ 7,63



TINTA TECIDO 37ML 545 VERDE OLIVA

Código: 44934 Fábrica: ACRILEX Unidade: UN/1 F1 F4

UN: R\$ 7,04 AV: R\$ 7,04 15: R\$ 7,19
30: R\$ 7,33 45: R\$ 7,48 60: R\$ 7,63



TINTA TECIDO 37ML 546 VERDE PINHEIRO

Código: 44947 Fábrica: ACRILEX Unidade: UN/1 F1 F4

UN: R\$ 7,04 AV: R\$ 7,04 15: R\$ 7,19
30: R\$ 7,33 45: R\$ 7,48 60: R\$ 7,63



TINTA TECIDO 37ML 549 MAGENTA

Código: 44910 Fábrica: ACRILEX Unidade: UN/1 F1 F4

UN: R\$ 7,04 AV: R\$ 7,04 15: R\$ 7,19
30: R\$ 7,33 45: R\$ 7,48 60: R\$ 7,63



TINTA TECIDO 37ML 550 VERMELHO PURPURA

Código: 44917 Fábrica: ACRILEX Unidade: UN/1 F1 F4

UN: R\$ 7,04 AV: R\$ 7,04 15: R\$ 7,19
30: R\$ 7,33 45: R\$ 7,48 60: R\$ 7,63



TINTA TECIDO 37ML 551 SEPIA

Código: 44869 Fábrica: ACRILEX Unidade: UN/1 F1 F4

UN: R\$ 7,04 AV: R\$ 7,04 15: R\$ 7,19
30: R\$ 7,33 45: R\$ 7,48 60: R\$ 7,63



TINTA TECIDO 37ML 552 VERDE GLACIAL

Código: 44931 Fábrica: ACRILEX Unidade: UN/1 F1 F4

UN: R\$ 7,04 AV: R\$ 7,04 15: R\$ 7,19
30: R\$ 7,33 45: R\$ 7,48 60: R\$ 7,63



TINTA TECIDO 37ML 560 AZUL CARIBE

Código: 44859 Fábrica: ACRILEX Unidade: UN/1 F1 F4

UN: R\$ 7,04 AV: R\$ 7,04 15: R\$ 7,19
30: R\$ 7,33 45: R\$ 7,48 60: R\$ 7,63



TINTA TECIDO 37ML 565 VINHO

Código: 44954 Fábrica: ACRILEX Unidade: UN/1 F1 F4

UN: R\$ 7,04 AV: R\$ 7,04 15: R\$ 7,19
30: R\$ 7,33 45: R\$ 7,48 60: R\$ 7,63



TINTA TECIDO 37ML 566 PÊSSEGO

Código: 44957 Fábrica: ACRILEX Unidade: UN/1 F1 F4

UN: R\$ 7,04 AV: R\$ 7,04 15: R\$ 7,19
30: R\$ 7,33 45: R\$ 7,48 60: R\$ 7,63



TINTA TECIDO 37ML 567 ROSA CHA

Código: 44904 Fábrica: ACRILEX Unidade: UN/1 F1 F4

UN: R\$ 7,04 AV: R\$ 7,04 15: R\$ 7,19
30: R\$ 7,33 45: R\$ 7,48 60: R\$ 7,63



TINTA TECIDO 37ML 568 AZUL CERULEO

Código: 44858 Fábrica: ACRILEX Unidade: UN/1 F1 F4

UN: R\$ 7,04 AV: R\$ 7,04 15: R\$ 7,19
30: R\$ 7,33 45: R\$ 7,48 60: R\$ 7,63



TINTA TECIDO 37ML 569 CARAMELO

Código: 45002 Fábrica: ACRILEX Unidade: UN/1 F1 F4

UN: R\$ 7,04 AV: R\$ 7,04 15: R\$ 7,19
30: R\$ 7,33 45: R\$ 7,48 60: R\$ 7,63



TINTA TECIDO 37ML 570 VERDE PISTA

Código: 44936 Fábrica: ACRILEX Unidade: UN/1 F1 F4

UN: R\$ 7,04 AV: R\$ 7,04 15: R\$ 7,19
30: R\$ 7,33 45: R\$ 7,48 60: R\$ 7,63



TINTA TECIDO 37ML 572 VERDE ABACATE

Código: 44932 Fábrica: ACRILEX Unidade: UN/1 F1 F4

UN: R\$ 7,04 AV: R\$ 7,04 15: R\$ 7,19
30: R\$ 7,33 45: R\$ 7,48 60: R\$ 7,63



TINTA TECIDO 37ML 573 OCRES OURO

Código: 44899 Fábrica: ACRILEX Unidade: UN/1 F1 F4

UN: R\$ 7,04 AV: R\$ 7,04 15: R\$ 7,19
30: R\$ 7,33 45: R\$ 7,48 60: R\$ 7,63



TINTA TECIDO 37ML 574 CINZA LUNAR

Código: 44867 Fábrica: ACRILEX Unidade: UN/1 F1 F4

UN: R\$ 7,04 AV: R\$ 7,04 15: R\$ 7,19
30: R\$ 7,33 45: R\$ 7,48 60: R\$ 7,63



TINTA TECIDO 37ML 576 CENOURA

Código: 44949 Fábrica: ACRILEX Unidade: UN/1 F1 F4

UN: R\$ 7,04 AV: R\$ 7,04 15: R\$ 7,19
30: R\$ 7,33 45: R\$ 7,48 60: R\$ 7,63



TINTA TECIDO 37ML 577 TURQUESA

Código: 44863 Fábrica: ACRILEX Unidade: UN/1 F1 F4

UN: R\$ 7,04 AV: R\$ 7,04 15: R\$ 7,19
30: R\$ 7,33 45: R\$ 7,48 60: R\$ 7,63



TINTA TECIDO 37ML 579 AZUL HORTENSIA

Código: 44857 Fábrica: ACRILEX Unidade: UN/1 F1 F4

UN: R\$ 7,04 AV: R\$ 7,04 15: R\$ 7,19
30: R\$ 7,33 45: R\$ 7,48 60: R\$ 7,63



TINTA TECIDO 37ML 581 ROSA CICLAME

Código: 44968 Fábrica: ACRILEX Unidade: UN/1 F1 F4

UN: R\$ 7,04 AV: R\$ 7,04 15: R\$ 7,19
30: R\$ 7,33 45: R\$ 7,48 60: R\$ 7,63



TINTA TECIDO 37ML 582 VERDE GRAMA
Código: Fábrica: Unidade:
44929 ACRILEX UN/1
F1 F4

UN: R\$ 7,04 AV: R\$ 7,04 15: R\$ 7,19
30: R\$ 7,33 45: R\$ 7,48 60: R\$ 7,63



TINTA TECIDO 37ML 583 VERMELHO TOMATE
Código: Fábrica: Unidade:
44960 ACRILEX UN/1
F1 F4

UN: R\$ 7,04 AV: R\$ 7,04 15: R\$ 7,19
30: R\$ 7,33 45: R\$ 7,48 60: R\$ 7,63



TINTA TECIDO 37ML 584 AZUL INVERNO
Código: Fábrica: Unidade:
44855 ACRILEX UN/1
F1 F4

UN: R\$ 7,04 AV: R\$ 7,04 15: R\$ 7,19
30: R\$ 7,33 45: R\$ 7,48 60: R\$ 7,63



TINTA TECIDO 37ML 586 CORAL
Código: Fábrica: Unidade:
44956 ACRILEX UN/1
F1 F4

UN: R\$ 7,04 AV: R\$ 7,04 15: R\$ 7,19
30: R\$ 7,33 45: R\$ 7,48 60: R\$ 7,63



TINTA TECIDO 37ML 587 LAVANDA
Código: Fábrica: Unidade:
44890 ACRILEX UN/1
F1 F4

UN: R\$ 7,04 AV: R\$ 7,04 15: R\$ 7,19
30: R\$ 7,33 45: R\$ 7,48 60: R\$ 7,63



TINTA TECIDO 37ML 588 VERMELHO QU
Código: Fábrica: Unidade:
44969 ACRILEX UN/1
F1 F4

UN: R\$ 7,04 AV: R\$ 7,04 15: R\$ 7,19
30: R\$ 7,33 45: R\$ 7,48 60: R\$ 7,63



TINTA TECIDO 37ML 589 AMARELO CANARIO
Código: Fábrica: Unidade:
44894 ACRILEX UN/1
F1 F4

UN: R\$ 7,04 AV: R\$ 7,04 15: R\$ 7,19
30: R\$ 7,33 45: R\$ 7,48 60: R\$ 7,63



TINTA TECIDO 37ML 593 MOSTARDA
Código: Fábrica: Unidade:
44872 ACRILEX UN/1
F1 F4

UN: R\$ 7,04 AV: R\$ 7,04 15: R\$ 7,19
30: R\$ 7,33 45: R\$ 7,48 60: R\$ 7,63



TINTA TECIDO 37ML 594 VERDE SECO
Código: Fábrica: Unidade:
44928 ACRILEX UN/1
F1 F4

UN: R\$ 7,04 AV: R\$ 7,04 15: R\$ 7,19
30: R\$ 7,33 45: R\$ 7,48 60: R\$ 7,63



TINTA TECIDO 37ML 596 AZUL PETROLEO
Código: Fábrica: Unidade:
44860 ACRILEX UN/1
F1 F4

UN: R\$ 7,04 AV: R\$ 7,04 15: R\$ 7,19
30: R\$ 7,33 45: R\$ 7,48 60: R\$ 7,63



TINTA TECIDO 37ML 627 CINZA CLARO
Código: Fábrica: Unidade:
44950 ACRILEX UN/1
F1 F4

UN: R\$ 7,04 AV: R\$ 7,04 15: R\$ 7,19
30: R\$ 7,33 45: R\$ 7,48 60: R\$ 7,63



TINTA TECIDO 37ML 629 CINZA ONIX
Código: Fábrica: Unidade:
44866 ACRILEX UN/1
F1 F4

UN: R\$ 7,04 AV: R\$ 7,04 15: R\$ 7,19
30: R\$ 7,33 45: R\$ 7,48 60: R\$ 7,63



TINTA TECIDO 37ML 630 VERDE MAR
Código: Fábrica: Unidade:
44922 ACRILEX UN/1
F1 F4

UN: R\$ 7,04 AV: R\$ 7,04 15: R\$ 7,19
30: R\$ 7,33 45: R\$ 7,48 60: R\$ 7,63



TINTA TECIDO 37ML 631 PAPAYA
Código: Fábrica: Unidade:
44884 ACRILEX UN/1
F1 F4

UN: R\$ 7,04 AV: R\$ 7,04 15: R\$ 7,19
30: R\$ 7,33 45: R\$ 7,48 60: R\$ 7,63



TINTA TECIDO 37ML 632 VERMELHO PROFUNDO
Código: Fábrica: Unidade:
44921 ACRILEX UN/1
F1 F4

UN: R\$ 7,04 AV: R\$ 7,04 15: R\$ 7,19
30: R\$ 7,33 45: R\$ 7,48 60: R\$ 7,63



TINTA TECIDO 37ML 633 LILAS SECO
Código: Fábrica: Unidade:
44887 ACRILEX UN/1
F1 F4

UN: R\$ 7,04 AV: R\$ 7,04 15: R\$ 7,19
30: R\$ 7,33 45: R\$ 7,48 60: R\$ 7,63



TINTA TECIDO 37ML 634 ROSTINHO BONECA
Código: Fábrica: Unidade:
44908 ACRILEX UN/1
F1 F4

UN: R\$ 7,04 AV: R\$ 7,04 15: R\$ 7,19
30: R\$ 7,33 45: R\$ 7,48 60: R\$ 7,63



TINTA TECIDO 37ML 635 ROSA CANDY
Código: Fábrica: Unidade:
44900 ACRILEX UN/1
F1 F4

UN: R\$ 7,04 AV: R\$ 7,04 15: R\$ 7,19
30: R\$ 7,33 45: R\$ 7,48 60: R\$ 7,63



TINTA TECIDO 37ML 636 ROSA INGLES
Código: Fábrica: Unidade:
44902 ACRILEX UN/1
F1 F4

UN: R\$ 7,04 AV: R\$ 7,04 15: R\$ 7,19
30: R\$ 7,33 45: R\$ 7,48 60: R\$ 7,63



TINTA TECIDO 37ML 638 FLOR MALV
Código: Fábrica: Unidade:
44889 ACRILEX UN/1
F1 F4

UN: R\$ 7,04 AV: R\$ 7,04 15: R\$ 7,19
30: R\$ 7,33 45: R\$ 7,48 60: R\$ 7,63



TINTA TECIDO 37ML 639 MAUVE
Código: Fábrica: Unidade:
44879 ACRILEX UN/1
F1 F4

UN: R\$ 7,04 AV: R\$ 7,04 15: R\$ 7,19
30: R\$ 7,33 45: R\$ 7,48 60: R\$ 7,63



TINTA TECIDO 37ML 640 PITAYA
Código: Fábrica: Unidade:
44911 ACRILEX UN/1
F1 F4

UN: R\$ 7,04 AV: R\$ 7,04 15: R\$ 7,19
30: R\$ 7,33 45: R\$ 7,48 60: R\$ 7,63



TINTA TECIDO 37ML 643 TIJOLO
Código: Fábrica: Unidade:
45001 ACRILEX UN/1
F1 F4

UN: R\$ 7,04 AV: R\$ 7,04 15: R\$ 7,19
30: R\$ 7,33 45: R\$ 7,48 60: R\$ 7,63



TINTA TECIDO 37ML 800 VERMELHO BEBE
Código: Fábrica: Unidade:
44914 ACRILEX UN/1
F1 F4

UN: R\$ 7,04 AV: R\$ 7,04 15: R\$ 7,19
30: R\$ 7,33 45: R\$ 7,48 60: R\$ 7,63



TINTA TECIDO 37ML 801 VERMELHO TANGERIN
Código: Fábrica: Unidade:
44919 ACRILEX UN/1
F1 F4

UN: R\$ 7,04 AV: R\$ 7,04 15: R\$ 7,19
30: R\$ 7,33 45: R\$ 7,48 60: R\$ 7,63



TINTA TECIDO 37ML 802 VERDE MACA
Código: Fábrica: Unidade:
44925 ACRILEX UN/1
F1 F4

UN: R\$ 7,04 AV: R\$ 7,04 15: R\$ 7,19
30: R\$ 7,33 45: R\$ 7,48 60: R\$ 7,63



TINTA TECIDO 37ML 803 ACQUA MARINA
Código: Fábrica: Unidade:
44943 ACRILEX UN/1
F1 F4

UN: R\$ 7,04 AV: R\$ 7,04 15: R\$ 7,19
30: R\$ 7,33 45: R\$ 7,48 60: R\$ 7,63



TINTA TECIDO 37ML 804 FUCHSIA
Código: Fábrica: Unidade:
44876 ACRILEX UN/1
F1 F4

UN: R\$ 7,04 AV: R\$ 7,04 15: R\$ 7,19
30: R\$ 7,33 45: R\$ 7,48 60: R\$ 7,63



TINTA TECIDO 37ML 805 VERMELHO GOIABA Q
Código: Fábrica: Unidade:
44918 ACRILEX UN/1
F1 F4

UN: R\$ 7,04 AV: R\$ 7,04 15: R\$ 7,19
30: R\$ 7,33 45: R\$ 7,48 60: R\$ 7,63



TINTA TECIDO 37ML 807 JACARANDA
Código: Fábrica: Unidade:
44953 ACRILEX UN/1
F1 F4

UN: R\$ 7,04 AV: R\$ 7,04 15: R\$ 7,19
30: R\$ 7,33 45: R\$ 7,48 60: R\$ 7,63



TINTA TECIDO 37ML 808 AMARELO BEBE
Código: Fábrica: Unidade:
44892 ACRILEX UN/1
F1 F4

UN: R\$ 7,04 AV: R\$ 7,04 15: R\$ 7,19
30: R\$ 7,33 45: R\$ 7,48 60: R\$ 7,63



TINTA TECIDO 37ML 809 LILAS
Código: Fábrica: Unidade:
44938 ACRILEX UN/1
F1 F4

UN: R\$ 7,04 AV: R\$ 7,04 15: R\$ 7,19
30: R\$ 7,33 45: R\$ 7,48 60: R\$ 7,63



TINTA TECIDO 37ML 810 VERDE BEBE

Código: 44926 Fábrica: ACRILEX Unidade: UN/1 F1 F4

UN: R\$ 7,04 AV: R\$ 7,04 15: R\$ 7,19
30: R\$ 7,33 45: R\$ 7,48 60: R\$ 7,63



TINTA TECIDO 37ML 811 AZUL BEBE

Código: 44861 Fábrica: ACRILEX Unidade: UN/1 F1 F4

UN: R\$ 7,04 AV: R\$ 7,04 15: R\$ 7,19
30: R\$ 7,33 45: R\$ 7,48 60: R\$ 7,63



TINTA TECIDO 37ML 812 SALMAO BEBE

Código: 44945 Fábrica: ACRILEX Unidade: UN/1 F1 F4

UN: R\$ 7,04 AV: R\$ 7,04 15: R\$ 7,19
30: R\$ 7,33 45: R\$ 7,48 60: R\$ 7,63



TINTA TECIDO 37ML 813 ROSA BEBE

Código: 44966 Fábrica: ACRILEX Unidade: UN/1 F1 F4

UN: R\$ 7,04 AV: R\$ 7,04 15: R\$ 7,19
30: R\$ 7,33 45: R\$ 7,48 60: R\$ 7,63



TINTA TECIDO 37ML 814 CHOCOLATE

Código: 44941 Fábrica: ACRILEX Unidade: UN/1 F1 F4

UN: R\$ 7,04 AV: R\$ 7,04 15: R\$ 7,19
30: R\$ 7,33 45: R\$ 7,48 60: R\$ 7,63



TINTA TECIDO 37ML 815 CASTANHO

Código: 44878 Fábrica: ACRILEX Unidade: UN/1 F1 F4

UN: R\$ 7,04 AV: R\$ 7,04 15: R\$ 7,19
30: R\$ 7,33 45: R\$ 7,48 60: R\$ 7,63



TINTA TECIDO 37ML 817 AREIA

Código: 44877 Fábrica: ACRILEX Unidade: UN/1 F1 F4

UN: R\$ 7,04 AV: R\$ 7,04 15: R\$ 7,19
30: R\$ 7,33 45: R\$ 7,48 60: R\$ 7,63



TINTA TECIDO 37ML 822 VERDE COUNTRY

Código: 44923 Fábrica: ACRILEX Unidade: UN/1 F1 F4

UN: R\$ 7,04 AV: R\$ 7,04 15: R\$ 7,19
30: R\$ 7,33 45: R\$ 7,48 60: R\$ 7,63



TINTA TECIDO 37ML 825 AZUL COUNTRY

Código: 44862 Fábrica: ACRILEX Unidade: UN/1 F1 F4

UN: R\$ 7,04 AV: R\$ 7,04 15: R\$ 7,19
30: R\$ 7,33 45: R\$ 7,48 60: R\$ 7,63



TINTA TECIDO 37ML 828 ROSA ANTIGO

Código: 44905 Fábrica: ACRILEX Unidade: UN/1 F1 F4

UN: R\$ 7,04 AV: R\$ 7,04 15: R\$ 7,19
30: R\$ 7,33 45: R\$ 7,48 60: R\$ 7,63



TINTA TECIDO 37ML 829 FLAMINGO

Código: 44909 Fábrica: ACRILEX Unidade: UN/1 F1 F4

UN: R\$ 7,04 AV: R\$ 7,04 15: R\$ 7,19
30: R\$ 7,33 45: R\$ 7,48 60: R\$ 7,63



TINTA TECIDO 37ML 833 AMARELO GEMA

Código: 44897 Fábrica: ACRILEX Unidade: UN/1 F1 F4

UN: R\$ 7,04 AV: R\$ 7,04 15: R\$ 7,19
30: R\$ 7,33 45: R\$ 7,48 60: R\$ 7,63



TINTA TECIDO 37ML 834 PALHA

Código: 44951 Fábrica: ACRILEX Unidade: UN/1 F1 F4

UN: R\$ 7,04 AV: R\$ 7,04 15: R\$ 7,19
30: R\$ 7,33 45: R\$ 7,48 60: R\$ 7,63



TINTA TECIDO 37ML 860 VERDE PANTANO

Código: 44924 Fábrica: ACRILEX Unidade: UN/1 F1 F4

UN: R\$ 7,04 AV: R\$ 7,04 15: R\$ 7,19
30: R\$ 7,33 45: R\$ 7,48 60: R\$ 7,63



TINTA TECIDO 37ML 895 MELAO

Código: 44873 Fábrica: ACRILEX Unidade: UN/1 F1 F4

UN: R\$ 7,04 AV: R\$ 7,04 15: R\$ 7,19
30: R\$ 7,33 45: R\$ 7,48 60: R\$ 7,63



TINTA TECIDO 37ML 896 RUSTICO

Código: 44871 Fábrica: ACRILEX Unidade: UN/1 F1 F4

UN: R\$ 7,04 AV: R\$ 7,04 15: R\$ 7,19
30: R\$ 7,33 45: R\$ 7,48 60: R\$ 7,63



TINTA TECIDO 37ML 897 VERDE SOFT

Código: 44927 Fábrica: ACRILEX Unidade: UN/1 F1 F4

UN: R\$ 7,04 AV: R\$ 7,04 15: R\$ 7,19
30: R\$ 7,33 45: R\$ 7,48 60: R\$ 7,63



TINTA TECIDO 37ML 909 TUTTI FRUTTI

Código: 44907 Fábrica: ACRILEX Unidade: UN/1 F1 F4

UN: R\$ 7,04 AV: R\$ 7,04 15: R\$ 7,19
30: R\$ 7,33 45: R\$ 7,48 60: R\$ 7,63



TINTA TECIDO 37ML 926 VERDE MUSGO

Código: 44970 Fábrica: ACRILEX Unidade: UN/1 F1 F4

UN: R\$ 7,04 AV: R\$ 7,04 15: R\$ 7,19
30: R\$ 7,33 45: R\$ 7,48 60: R\$ 7,63



TINTA TECIDO 37ML 932 TELHA

Código: 44959 Fábrica: ACRILEX Unidade: UN/1 F1 F4

UN: R\$ 7,04 AV: R\$ 7,04 15: R\$ 7,19
30: R\$ 7,33 45: R\$ 7,48 60: R\$ 7,63



TINTA TECIDO 37ML 933 CINZA

Código: 44868 Fábrica: ACRILEX Unidade: UN/1 F1 F4

UN: R\$ 7,04 AV: R\$ 7,04 15: R\$ 7,19
30: R\$ 7,33 45: R\$ 7,48 60: R\$ 7,63



TINTA TECIDO 37ML 953 MARRON

Código: 44883 Fábrica: ACRILEX Unidade: UN/1 F1 F4

UN: R\$ 7,04 AV: R\$ 7,04 15: R\$ 7,19
30: R\$ 7,33 45: R\$ 7,48 60: R\$ 7,63



TINTA TECIDO 37ML 984 VERMELHO NATAL

Código: 44916 Fábrica: ACRILEX Unidade: UN/1 F1 F4

UN: R\$ 7,04 AV: R\$ 7,04 15: R\$ 7,19
30: R\$ 7,33 45: R\$ 7,48 60: R\$ 7,63



TINTA TECIDO 37ML 985 VERDE KIWI

Código: 44962 Fábrica: ACRILEX Unidade: UN/1 F1 F4

UN: R\$ 7,04 AV: R\$ 7,04 15: R\$ 7,19
30: R\$ 7,33 45: R\$ 7,48 60: R\$ 7,63



TINTA TECIDO 37ML 986 CAQUI

Código: 44948 Fábrica: ACRILEX Unidade: UN/1 F1 F4

UN: R\$ 7,04 AV: R\$ 7,04 15: R\$ 7,19
30: R\$ 7,33 45: R\$ 7,48 60: R\$ 7,63



TINTA TECIDO 37ML 988 ROSE

Código: 44946 Fábrica: ACRILEX Unidade: UN/1 F1 F4

UN: R\$ 7,04 AV: R\$ 7,04 15: R\$ 7,19
30: R\$ 7,33 45: R\$ 7,48 60: R\$ 7,63



TINTA TECIDO 37ML 989 ERVA DOCE

Código: 44955 Fábrica: ACRILEX Unidade: UN/1 F1 F4

UN: R\$ 7,04 AV: R\$ 7,04 15: R\$ 7,19
30: R\$ 7,33 45: R\$ 7,48 60: R\$ 7,63



TINTA TECIDO 37ML 990 MENTA

Código: 44967 Fábrica: ACRILEX Unidade: UN/1 F1 F4

UN: R\$ 7,04 AV: R\$ 7,04 15: R\$ 7,19
30: R\$ 7,33 45: R\$ 7,48 60: R\$ 7,63



TINTA TECIDO 37ML 992 AZUL SOFT

Código: 44864 Fábrica: ACRILEX Unidade: UN/1 F1 F4

UN: R\$ 7,04 AV: R\$ 7,04 15: R\$ 7,19
30: R\$ 7,33 45: R\$ 7,48 60: R\$ 7,63



TINTA TECIDO 37ML 993 AZUL ARDOSIA

Código: 44939 Fábrica: ACRILEX Unidade: UN/1 F1 F4

UN: R\$ 7,04 AV: R\$ 7,04 15: R\$ 7,19
30: R\$ 7,33 45: R\$ 7,48 60: R\$ 7,63



TINTA TECIDO 37ML 994 CINZA CHUMBO

Código: 44944 Fábrica: ACRILEX Unidade: UN/1 F1 F4

UN: R\$ 7,04 AV: R\$ 7,04 15: R\$ 7,19
30: R\$ 7,33 45: R\$ 7,48 60: R\$ 7,63



TINTA TECIDO 37ML 995 UVA

Código: 44875 Fábrica: ACRILEX Unidade: UN/1 F1 F4

UN: R\$ 7,04 AV: R\$ 7,04 15: R\$ 7,19
30: R\$ 7,33 45: R\$ 7,48 60: R\$ 7,63



TINTA TECIDO 37ML 996 BERINJELA
Código: 44963 Fábrica: ACRILEX Unidade: UN/1 F1 F4

UN: R\$ 7,04 AV: R\$ 7,04 15: R\$ 7,19
30: R\$ 7,33 45: R\$ 7,48 60: R\$ 7,63



TINTA TECIDO 37ML 997 JATOBA
Código: 44881 Fábrica: ACRILEX Unidade: UN/1 F1 F4

UN: R\$ 7,04 AV: R\$ 7,04 15: R\$ 7,19
30: R\$ 7,33 45: R\$ 7,48 60: R\$ 7,63



TINTA TECIDO 37ML 998 AMORA
Código: 44886 Fábrica: ACRILEX Unidade: UN/1 F1 F4

UN: R\$ 30,81 AV: R\$ 30,81 15: R\$ 31,45
30: R\$ 32,08 45: R\$ 32,72 60: R\$ 33,37



TINTA TECIDO 250ML AMARELO SOL
Código: 48623 Fábrica: TEK BOND Unidade: UN/1 F1 F4

UN: R\$ 30,81 AV: R\$ 30,81 15: R\$ 31,45
30: R\$ 32,08 45: R\$ 32,72 60: R\$ 33,37



TINTA TECIDO 250ML AZUL ROYAL
Código: 48621 Fábrica: TEK BOND Unidade: UN/1 F1 F4

UN: R\$ 30,81 AV: R\$ 30,81 15: R\$ 31,45
30: R\$ 32,08 45: R\$ 32,72 60: R\$ 33,37



TINTA TECIDO 250ML BRANCO
Código: 48619 Fábrica: TEK BOND Unidade: UN/1 F1 F4

UN: R\$ 30,81 AV: R\$ 30,81 15: R\$ 31,45
30: R\$ 32,08 45: R\$ 32,72 60: R\$ 33,37



TINTA TECIDO 250ML LILAS
Código: 48625 Fábrica: TEK BOND Unidade: UN/1 F1 F4

UN: R\$ 30,81 AV: R\$ 30,81 15: R\$ 31,45
30: R\$ 32,08 45: R\$ 32,72 60: R\$ 33,37



TINTA TECIDO 250ML MARROM
Código: 48624 Fábrica: TEK BOND Unidade: UN/1 F1 F4

UN: R\$ 30,81 AV: R\$ 30,81 15: R\$ 31,45
30: R\$ 32,08 45: R\$ 32,72 60: R\$ 33,37



TINTA TECIDO 250ML PINK
Código: 48626 Fábrica: TEK BOND Unidade: UN/1 F1 F4

UN: R\$ 30,81 AV: R\$ 30,81 15: R\$ 31,45
30: R\$ 32,08 45: R\$ 32,72 60: R\$ 33,37



TINTA TECIDO 250ML PRETO
Código: 48620 Fábrica: TEK BOND Unidade: UN/1 F1 F4

UN: R\$ 30,81 AV: R\$ 30,81 15: R\$ 31,45
30: R\$ 32,08 45: R\$ 32,72 60: R\$ 33,37



TINTA TECIDO 250ML ROXO
Código: 48627 Fábrica: TEK BOND Unidade: UN/1 F1 F4

UN: R\$ 30,81 AV: R\$ 30,81 15: R\$ 31,45
30: R\$ 32,08 45: R\$ 32,72 60: R\$ 33,37



TINTA TECIDO 250ML VERDE FLORESTA
Código: 48628 Fábrica: TEK BOND Unidade: UN/1 F1 F4

UN: R\$ 30,81 AV: R\$ 30,81 15: R\$ 31,45
30: R\$ 32,08 45: R\$ 32,72 60: R\$ 33,37



TINTA TECIDO 250ML VERMELHO
Código: 48622 Fábrica: TEK BOND Unidade: UN/1 F1 F4

UN: R\$ 36,97 AV: R\$ 36,97 15: R\$ 37,74
30: R\$ 38,49 45: R\$ 39,26 60: R\$ 40,05



TINTA TECIDO 250ML 501 AZUL TURQUESA
Código: 45004 Fábrica: ACRILEX Unidade: UN/1 F1 F4

UN: R\$ 36,97 AV: R\$ 36,97 15: R\$ 37,74
30: R\$ 38,49 45: R\$ 39,26 60: R\$ 40,05



TINTA TECIDO 250ML 503 AZUL CELESTE
Código: 45005 Fábrica: ACRILEX Unidade: UN/1 F1 F4

UN: R\$ 36,97 AV: R\$ 36,97 15: R\$ 37,74
30: R\$ 38,49 45: R\$ 39,26 60: R\$ 40,05



TINTA TECIDO 250ML 505 AMARELO OURO
Código: 45006 Fábrica: ACRILEX Unidade: UN/1 F1 F4

UN: R\$ 36,97 AV: R\$ 36,97 15: R\$ 37,74
30: R\$ 38,49 45: R\$ 39,26 60: R\$ 40,05



TINTA TECIDO 250ML 507 VERMELHO FOGO

Código: 45007 Fábrica: ACRILEX Unidade: UN/1
F1 F4

UN: R\$ 36,97 AV: R\$ 36,97 15: R\$ 37,74
30: R\$ 38,49 45: R\$ 39,26 60: R\$ 40,05



TINTA TECIDO 250ML 510 VERDE FOLHA

Código: 50959 Fábrica: ACRILEX Unidade: UN/1
F1 F4

UN: R\$ 36,97 AV: R\$ 36,97 15: R\$ 37,74
30: R\$ 38,49 45: R\$ 39,26 60: R\$ 40,05



TINTA TECIDO 250ML 511 VERDE BANDEIRA

Código: 45008 Fábrica: ACRILEX Unidade: UN/1
F1 F4

UN: R\$ 36,97 AV: R\$ 36,97 15: R\$ 37,74
30: R\$ 38,49 45: R\$ 39,26 60: R\$ 40,05



TINTA TECIDO 250ML 516 VIOLETA

Código: 45009 Fábrica: ACRILEX Unidade: UN/1
F1 F4

UN: R\$ 36,97 AV: R\$ 36,97 15: R\$ 37,74
30: R\$ 38,49 45: R\$ 39,26 60: R\$ 40,05



TINTA TECIDO 250ML 517 LARANJA

Código: 45010 Fábrica: ACRILEX Unidade: UN/1
F1 F4

UN: R\$ 36,97 AV: R\$ 36,97 15: R\$ 37,74
30: R\$ 38,49 45: R\$ 39,26 60: R\$ 40,05



TINTA TECIDO 250ML 519 BRANCO

Código: 45003 Fábrica: ACRILEX Unidade: UN/1
F1 F4

UN: R\$ 36,97 AV: R\$ 36,97 15: R\$ 37,74
30: R\$ 38,49 45: R\$ 39,26 60: R\$ 40,05



TINTA TECIDO 250ML 520 PRETO

Código: 45011 Fábrica: ACRILEX Unidade: UN/1
F1 F4

UN: R\$ 36,97 AV: R\$ 36,97 15: R\$ 37,74
30: R\$ 38,49 45: R\$ 39,26 60: R\$ 40,05



TINTA TECIDO 250ML 528 LILAS

Código: 47455 Fábrica: ACRILEX Unidade: UN/1
F1 F4

UN: R\$ 36,97 AV: R\$ 36,97 15: R\$ 37,74
30: R\$ 38,49 45: R\$ 39,26 60: R\$ 40,05



TINTA TECIDO 250ML 529 MARFIM

Código: 47459 Fábrica: ACRILEX Unidade: UN/1
F1 F4

UN: R\$ 36,97 AV: R\$ 36,97 15: R\$ 37,74
30: R\$ 38,49 45: R\$ 39,26 60: R\$ 40,05



TINTA TECIDO 250ML 531 MARROM

Código: 45012 Fábrica: ACRILEX Unidade: UN/1
F1 F4

UN: R\$ 36,97 AV: R\$ 36,97 15: R\$ 37,74
30: R\$ 38,49 45: R\$ 39,26 60: R\$ 40,05



TINTA TECIDO 250ML 537 ROSA

Código: 45013 Fábrica: ACRILEX Unidade: UN/1
F1 F4

UN: R\$ 36,97 AV: R\$ 36,97 15: R\$ 37,74
30: R\$ 38,49 45: R\$ 39,26 60: R\$ 40,05



TINTA TECIDO 250ML 538 AMARELO PES

Código: 45036 Fábrica: ACRILEX Unidade: UN/1
F1 F4

UN: R\$ 36,97 AV: R\$ 36,97 15: R\$ 37,74
30: R\$ 38,49 45: R\$ 39,26 60: R\$ 40,05



TINTA TECIDO 250ML 541 VERMELHO

Código: 51224 Fábrica: ACRILEX Unidade: UN/1
F1 F4

UN: R\$ 36,97 AV: R\$ 36,97 15: R\$ 37,74
30: R\$ 38,49 45: R\$ 39,26 60: R\$ 40,05



TINTA TECIDO 250ML 546 VERDE PINHEIRO

Código: 47457 Fábrica: ACRILEX Unidade: UN/1
F1 F4

UN: R\$ 36,97 AV: R\$ 36,97 15: R\$ 37,74
30: R\$ 38,49 45: R\$ 39,26 60: R\$ 40,05



TINTA TECIDO 250ML 584 AZUL INVERNO

Código: 47454 Fábrica: ACRILEX Unidade: UN/1
F1 F4

UN: R\$ 36,97 AV: R\$ 36,97 15: R\$ 37,74
30: R\$ 38,49 45: R\$ 39,26 60: R\$ 40,05



TINTA TECIDO 250ML 586 CORAL

Código: 47460 Fábrica: ACRILEX Unidade: UN/1
F1 F4

UN: R\$ 462,23 AV: R\$ 462,23 15: R\$ 471,86
30: R\$ 481,30 45: R\$ 490,92 60: R\$ 500,74

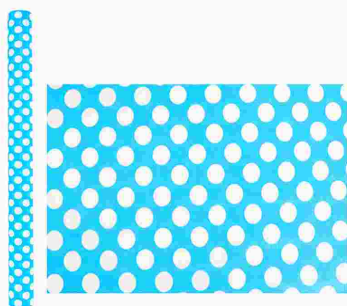

TNT 50 MTS EST 1,40 MTSX40GRS CHAPADO A
Código: Fábrika: Unidade:
45180 SUPPER RL/1
F1 F4

UN: R\$ 462,23 AV: R\$ 462,23 15: R\$ 471,86
30: R\$ 481,30 45: R\$ 490,92 60: R\$ 500,74



TNT 50 MTS EST 1,40 MTSX40GRS FORMATURA
Código: Fábrika: Unidade:
45170 SUPPER RL/1
F1 F4

UN: R\$ 462,23 AV: R\$ 462,23 15: R\$ 471,86
30: R\$ 481,30 45: R\$ 490,92 60: R\$ 500,74

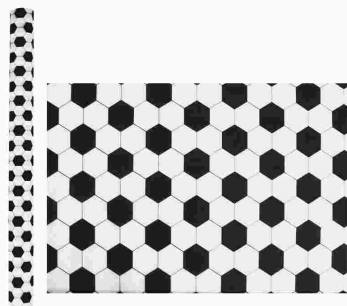

TNT 50 MTS EST 1,40 MTSX40GRS G FUTEBOL
Código: Fábrika: Unidade:
45171 SUPPER RL/1
F1 F4

UN: R\$ 462,23 AV: R\$ 462,23 15: R\$ 471,86
30: R\$ 481,30 45: R\$ 490,92 60: R\$ 500,74



TNT 50 MTS EST 1,40 MTSX40GRS POA VERM
Código: Fábrika: Unidade:
45175 SUPPER RL/1
F1 F4

UN: R\$ 462,23 AV: R\$ 462,23 15: R\$ 471,86
30: R\$ 481,30 45: R\$ 490,92 60: R\$ 500,74



TNT 50 MTS EST 1,40 MTSX40GRS TEIAS
Código: Fábrika: Unidade:
45177 SUPPER RL/1
F1 F4

UN: R\$ 2,26 AV: R\$ 112,98 15: R\$ 115,34
30: R\$ 117,64 45: R\$ 120,00 60: R\$ 122,40



TNT 50 MTS 1,40 MTSX40GRS AMARELO
Código: Fábrika: Unidade:
41620 SANTA FE RL/50
F1 F4

UN: R\$ 2,26 AV: R\$ 112,98 15: R\$ 115,34
30: R\$ 117,64 45: R\$ 120,00 60: R\$ 122,40

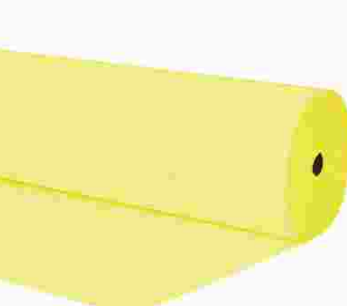

TNT 50 MTS 1,40 MTSX40GRS AMARELO CLARO
Código: Fábrika: Unidade:
27307 SANTA FE RL/50
F1 F4

UN: R\$ 2,26 AV: R\$ 112,98 15: R\$ 115,34
30: R\$ 117,64 45: R\$ 120,00 60: R\$ 122,40



TNT 50 MTS 1,40 MTSX40GRS AMARELO PADRA
Código: Fábrika: Unidade:
39810 SANTA FE RL/50
F1 F4

UN: R\$ 2,26 AV: R\$ 112,98 15: R\$ 115,34
30: R\$ 117,64 45: R\$ 120,00 60: R\$ 122,40



TNT 50 MTS 1,40 MTSX40GRS AZUL ANIL
Código: Fábrika: Unidade:
30056 SANTA FE RL/50
F1 F4

UN: R\$ 2,26 AV: R\$ 112,98 15: R\$ 115,34
30: R\$ 117,64 45: R\$ 120,00 60: R\$ 122,40



TNT 50 MTS 1,40 MTSX40GRS AZUL CELESTE
Código: Fábrika: Unidade:
30058 SANTA FE RL/50
F1 F4

UN: R\$ 2,26 AV: R\$ 112,98 15: R\$ 115,34
30: R\$ 117,64 45: R\$ 120,00 60: R\$ 122,40



TNT 50 MTS 1,40 MTSX40GRS AZUL CLARO
Código: Fábrika: Unidade:
41622 GATE 72 RL/50
F1 F4

UN: R\$ 2,26 AV: R\$ 112,98 15: R\$ 115,34
30: R\$ 117,64 45: R\$ 120,00 60: R\$ 122,40



TNT 50 MTS 1,40 MTSX40GRS AZUL IBIZA
Código: Fábrika: Unidade:
39807 SANTA FE RL/50
F1 F4

UN: R\$ 2,26 AV: R\$ 112,98 15: R\$ 115,34
30: R\$ 117,64 45: R\$ 120,00 60: R\$ 122,40



TNT 50 MTS 1,40 MTSX40GRS AZUL MARINHO
Código: Fábrika: Unidade:
33716 SANTA FE RL/50
F1 F4

UN: R\$ 2,26 AV: R\$ 112,98 15: R\$ 115,34
30: R\$ 117,64 45: R\$ 120,00 60: R\$ 122,40



TNT 50 MTS 1,40 MTSX40GRS AZUL OCEANO
Código: Fábrika: Unidade:
39819 SANTA FE RL/50
F1 F4

UN: R\$ 2,26 AV: R\$ 112,98 15: R\$ 115,34
30: R\$ 117,64 45: R\$ 120,00 60: R\$ 122,40



TNT 50 MTS 1,40 MTSX40GRS AZUL PADRAO
Código: Fábrika: Unidade:
39808 SANTA FE RL/50
F1 F4

UN: R\$ 2,26 AV: R\$ 112,98 15: R\$ 115,34
30: R\$ 117,64 45: R\$ 120,00 60: R\$ 122,40



TNT 50 MTS 1,40 MTSX40GRS AZUL ROYAL
Código: Fábrika: Unidade:
27309 SANTA FE RL/50
F1 F4

UN: R\$ 2,26 AV: R\$ 112,98 15: R\$ 115,34
30: R\$ 117,64 45: R\$ 120,00 60: R\$ 122,40



TNT 50 MTS 1,40 MTSX40GRS BEGE CLARO
Código: 39811 Fábrica: SANTA FE Unidade: RL/50 F1 F4

UN: R\$ 2,26 AV: R\$ 112,98 15: R\$ 115,34
30: R\$ 117,64 45: R\$ 120,00 60: R\$ 122,40



TNT 50 MTS 1,40 MTSX40GRS BEGE PADRAO
Código: 39812 Fábrica: SANTA FE Unidade: RL/50 F1 F4

UN: R\$ 2,26 AV: R\$ 112,98 15: R\$ 115,34
30: R\$ 117,64 45: R\$ 120,00 60: R\$ 122,40



TNT 50 MTS 1,40 MTSX40GRS BRANCO
Código: 27306 Fábrica: SANTA FE Unidade: RL/50 F1 F4

UN: R\$ 2,26 AV: R\$ 112,98 15: R\$ 115,34
30: R\$ 117,64 45: R\$ 120,00 60: R\$ 122,40

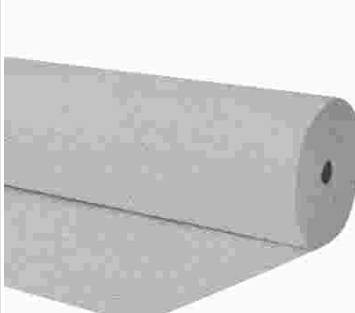

TNT 50 MTS 1,40 MTSX40GRS CINZA
Código: 33175 Fábrica: SANTA FE Unidade: RL/50 F1 F4

UN: R\$ 2,26 AV: R\$ 112,98 15: R\$ 115,34
30: R\$ 117,64 45: R\$ 120,00 60: R\$ 122,40



TNT 50 MTS 1,40 MTSX40GRS CINZA ESC
Código: 39806 Fábrica: SANTA FE Unidade: RL/50 F1 F4

UN: R\$ 2,26 AV: R\$ 112,98 15: R\$ 115,34
30: R\$ 117,64 45: R\$ 120,00 60: R\$ 122,40



TNT 50 MTS 1,40 MTSX40GRS GOIABA
Código: 39817 Fábrica: SANTA FE Unidade: RL/50 F1 F4

UN: R\$ 2,26 AV: R\$ 112,98 15: R\$ 115,34
30: R\$ 117,64 45: R\$ 120,00 60: R\$ 122,40



TNT 50 MTS 1,40 MTSX40GRS LARANJA
Código: 27312 Fábrica: SANTA FE Unidade: RL/50 F1 F4

UN: R\$ 2,26 AV: R\$ 112,98 15: R\$ 115,34
30: R\$ 117,64 45: R\$ 120,00 60: R\$ 122,40



TNT 50 MTS 1,40 MTSX40GRS LILAS
Código: 27308 Fábrica: SANTA FE Unidade: RL/50 F1 F4

UN: R\$ 2,26 AV: R\$ 112,98 15: R\$ 115,34
30: R\$ 117,64 45: R\$ 120,00 60: R\$ 122,40



TNT 50 MTS 1,40 MTSX40GRS MARROM
Código: 27311 Fábrica: SANTA FE Unidade: RL/50 F1 F4

UN: R\$ 2,26 AV: R\$ 112,98 15: R\$ 115,34
30: R\$ 117,64 45: R\$ 120,00 60: R\$ 122,40



TNT 50 MTS 1,40 MTSX40GRS PALHA PADRAO
Código: 39813 Fábrica: SANTA FE Unidade: RL/50 F1 F4

UN: R\$ 2,26 AV: R\$ 112,98 15: R\$ 115,34
30: R\$ 117,64 45: R\$ 120,00 60: R\$ 122,40



TNT 50 MTS 1,40 MTSX40GRS PRETO
Código: 27304 Fábrica: SANTA FE Unidade: RL/50 F1 F4

UN: R\$ 2,26 AV: R\$ 112,98 15: R\$ 115,34
30: R\$ 117,64 45: R\$ 120,00 60: R\$ 122,40



TNT 50 MTS 1,40 MTSX40GRS ROSA
Código: 27314 Fábrica: SANTA FE Unidade: RL/50 F1 F4

UN: R\$ 2,26 AV: R\$ 112,98 15: R\$ 115,34
30: R\$ 117,64 45: R\$ 120,00 60: R\$ 122,40



TNT 50 MTS 1,40 MTSX40GRS ROSA BB
Código: 41621 Fábrica: GATE 72 Unidade: RL/50 F1 F4

UN: R\$ 2,26 AV: R\$ 112,98 15: R\$ 115,34
30: R\$ 117,64 45: R\$ 120,00 60: R\$ 122,40



TNT 50 MTS 1,40 MTSX40GRS ROSA PADRAO
Código: 39809 Fábrica: SANTA FE Unidade: RL/50 F1 F4

UN: R\$ 2,26 AV: R\$ 112,98 15: R\$ 115,34
30: R\$ 117,64 45: R\$ 120,00 60: R\$ 122,40



TNT 50 MTS 1,40 MTSX40GRS ROSA PINK
Código: 33174 Fábrica: SANTA FE Unidade: RL/50 F1 F4

UN: R\$ 2,26 AV: R\$ 112,98 15: R\$ 115,34
30: R\$ 117,64 45: R\$ 120,00 60: R\$ 122,40



TNT 50 MTS 1,40 MTSX40GRS SALMAO
Código: 39816 Fábrica: SANTA FE Unidade: RL/50 F1 F4

UN: R\$ 2,26 AV: R\$ 112,98 15: R\$ 115,34
30: R\$ 117,64 45: R\$ 120,00 60: R\$ 122,40



TNT 50 MTS 1,40 MTSX40GRS VERDE
Código: 27310 Fábrica: SANTA FE Unidade: RL/50 F1 F4

UN: R\$ 2,26 AV: R\$ 112,98 15: R\$ 115,34
30: R\$ 117,64 45: R\$ 120,00 60: R\$ 122,40



TNT 50 MTS 1,40 MTSX40GRS VERDE BILHAR
Código: 39815 Fábrica: SANTA FE Unidade: RL/50 F1 F4

UN: R\$ 2,26 AV: R\$ 112,98 15: R\$ 115,34
30: R\$ 117,64 45: R\$ 120,00 60: R\$ 122,40

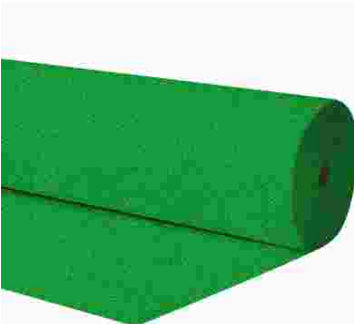

TNT 50 MTS 1,40 MTSX40GRS VERDE CLARO
Código: 30057 Fábrica: SANTA FE Unidade: RL/50 F1 F4

UN: R\$ 2,26 AV: R\$ 112,98 15: R\$ 115,34
30: R\$ 117,64 45: R\$ 120,00 60: R\$ 122,40



TNT 50 MTS 1,40 MTSX40GRS VERDE LIMAO
Código: 30054 Fábrica: SANTA FE Unidade: RL/50 F1 F4

UN: R\$ 2,26 AV: R\$ 112,98 15: R\$ 115,34
30: R\$ 117,64 45: R\$ 120,00 60: R\$ 122,40



TNT 50 MTS 1,40 MTSX40GRS VERDE MUSGO
Código: 39814 Fábrica: SANTA FE Unidade: RL/50 F1 F4

UN: R\$ 2,26 AV: R\$ 112,98 15: R\$ 115,34
30: R\$ 117,64 45: R\$ 120,00 60: R\$ 122,40



TNT 50 MTS 1,40 MTSX40GRS VERMELHO
Código: 27313 Fábrica: SANTA FE Unidade: RL/50 F1 F4

UN: R\$ 2,26 AV: R\$ 112,98 15: R\$ 115,34
30: R\$ 117,64 45: R\$ 120,00 60: R\$ 122,40



TNT 50 MTS 1,40 MTSX40GRS VINHO
Código: 39805 Fábrica: SANTA FE Unidade: RL/50 F1 F4

UN: R\$ 2,26 AV: R\$ 112,98 15: R\$ 115,34
30: R\$ 117,64 45: R\$ 120,00 60: R\$ 122,40



TNT 50 MTS 1,40 MTSX40GRS VIOLETA
Código: 39818 Fábrica: SANTA FE Unidade: RL/50 F1 F4

UN: R\$ 410,87 AV: R\$ 410,87 15: R\$ 419,43
30: R\$ 427,82 45: R\$ 436,37 60: R\$ 445,10



TNT EST LAM 50MTX1,40 MTX40GRS XADR AZUL
Código: 42725 Fábrica: SANTA FE Unidade: RL/1 F1 F4

UN: R\$ 410,87 AV: R\$ 410,87 15: R\$ 419,43
30: R\$ 427,82 45: R\$ 436,37 60: R\$ 445,10



TNT EST LAM 50MTX1,40 MTX40GRS XADR PTO
Código: 42726 Fábrica: SANTA FE Unidade: RL/1 F1 F4

UN: R\$ 410,87 AV: R\$ 410,87 15: R\$ 419,43
30: R\$ 427,82 45: R\$ 436,37 60: R\$ 445,10



TNT EST LAM 50MTX1,40 MTX40GRS XADR VERD
Código: 42723 Fábrica: SANTA FE Unidade: RL/1 F1 F4

UN: R\$ 410,87 AV: R\$ 410,87 15: R\$ 419,43
30: R\$ 427,82 45: R\$ 436,37 60: R\$ 445,10



TNT EST LAM 50MTX1,40 MTX40GRS XADR VERM
Código: 42724 Fábrica: SANTA FE Unidade: RL/1 F1 F4

UN: R\$ 1,44 AV: R\$ 14,37 15: R\$ 14,67
30: R\$ 14,96 45: R\$ 15,26 60: R\$ 15,57

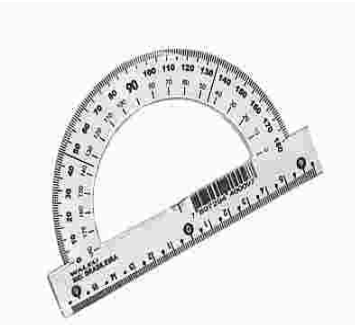

TRANSFERIDOR CHANFRADO 180 GRAUS 10X1
Código: 14481 Fábrica: WALEU Unidade: PT/10 F1 F4

UN: R\$ 1,78 AV: R\$ 17,82 15: R\$ 18,19
30: R\$ 18,56 45: R\$ 18,93 60: R\$ 19,31

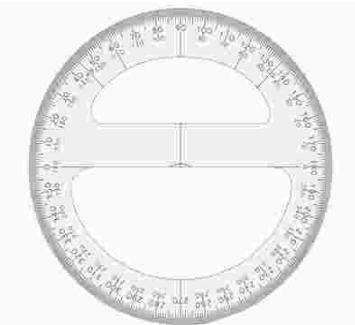

TRANSFERIDOR CHANFRADO 360 GRAUS 10X1
Código: 453 Fábrica: WALEU Unidade: PT/10 F1 F4

UN: R\$ 20,53 AV: R\$ 20,53 15: R\$ 20,96
30: R\$ 21,38 45: R\$ 21,81 60: R\$ 22,24

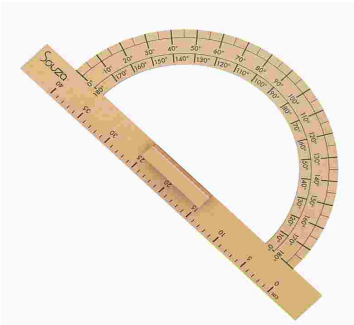

TRANSFERIDOR MDF 180 GRAUS
Código: 49904 Fábrica: SOUZA Unidade: UN/1 F1 F4

UN: R\$ 24,37 AV: R\$ 24,37 15: R\$ 24,88
30: R\$ 25,38 45: R\$ 25,88 60: R\$ 26,40



TRIO DE MESA ACR QUAD CRISTAL 550
Código: 41962 Fábrica: CARBRINK Unidade: UN/1 F1 F4

UN: R\$ 24,37 AV: R\$ 24,37 15: R\$ 24,88
30: R\$ 25,38 45: R\$ 25,88 60: R\$ 26,40



TRIO DE MESA ACR QUAD FUME 551

Código: Fábrica: Unidade:
41961 CARBRINK UN/1
F1 F4

UN: R\$ 11,76 AV: R\$ 11,76 15: R\$ 12,01
30: R\$ 12,25 45: R\$ 12,49 60: R\$ 12,74



TRIO DE MESA PLAST QUAD PRETO 555

Código: Fábrica: Unidade:
45413 CARBRINK UN/1
F1 F4

UN: R\$ 15,68 AV: R\$ 15,68 15: R\$ 16,00
30: R\$ 16,32 45: R\$ 16,65 60: R\$ 16,98



TRIO PORTA CANETAS CLIPS LEMBRETES CRIST

Código: Fábrica: Unidade:
47592 MAXCRIL UN/1
F1 F4

UN: R\$ 15,68 AV: R\$ 15,68 15: R\$ 16,00
30: R\$ 16,32 45: R\$ 16,65 60: R\$ 16,98



TRIO PORTA CANETAS CLIPS LEMBRETES FUME

Código: Fábrica: Unidade:
29763 MAXCRIL UN/1
F1 F4

UN: R\$ 2,81 AV: R\$ 2,81 15: R\$ 2,87
30: R\$ 2,93 45: R\$ 2,99 60: R\$ 3,05



UMEDCEDOR MOLHA DEDOS ESPUMA 01

Código: Fábrica: Unidade:
43328 CARBRINK UN/1
F1 F4

UN: R\$ 2,46 AV: R\$ 2,46 15: R\$ 2,51
30: R\$ 2,56 45: R\$ 2,61 60: R\$ 2,66



UMIDIFICADOR DEDOS 12 GRS (CREME) 206

Código: Fábrica: Unidade:
22994 CARBRINK UN/1
F1 F4

UN: R\$ 0,56 AV: R\$ 112,98 15: R\$ 115,34
30: R\$ 117,64 45: R\$ 120,00 60: R\$ 122,40



VARETA P/PASTA SUSPensa 200UN

Código: Fábrica: Unidade:
47193 POLYCART PT/200
F1 F4

UN: R\$ 16,42 AV: R\$ 16,42 15: R\$ 16,76
30: R\$ 17,09 45: R\$ 17,44 60: R\$ 17,78



VERNIZ ACRILICO BRILHANTE 100ML 15010

Código: Fábrica: Unidade:
41952 ACRILEX UN/1
F1 F4

UN: R\$ 35,24 AV: R\$ 35,24 15: R\$ 35,97
30: R\$ 36,69 45: R\$ 37,43 60: R\$ 38,18



VERNIZ GERAL 100ML 16010

Código: Fábrica: Unidade:
45818 ACRILEX UN/1
F1 F4

UN: R\$ 23,62 AV: R\$ 23,62 15: R\$ 24,11
30: R\$ 24,59 45: R\$ 25,08 60: R\$ 25,58



VERNIZ SPRAY 350ML 250G BRILHANTE

Código: Fábrica: Unidade:
42228 TEK BOND UN/1
F1 F4

UN: R\$ 34,11 AV: R\$ 34,11 15: R\$ 34,82
30: R\$ 35,52 45: R\$ 36,23 60: R\$ 36,95



VERNIZ SPRAY 350ML 250G FOSCO

Código: Fábrica: Unidade:
48648 TEK BOND UN/1
F1 F4

UN: R\$ 0,15 AV: R\$ 7,69 15: R\$ 7,85
30: R\$ 8,01 45: R\$ 8,17 60: R\$ 8,33



VISOR E ETIQU P/PASTA SUSPensa 50X1

Código: Fábrica: Unidade:
42699 DELUCAS PT/50
F1 F4

UN: R\$ 0,13 AV: R\$ 30,81 15: R\$ 31,45
30: R\$ 32,08 45: R\$ 32,72 60: R\$ 33,37



ETIQUETA ADESIVA CARTA 42,33 6093 240X1

Código: Fábrica: Unidade:
48144 PIMACO PT/240
F1 F4