

UN: R\$ 2,87 AV: R\$ 2,87 15: R\$ 2,93
30: R\$ 2,98 45: R\$ 3,04 60: R\$ 3,10

16 cm



ABRIDOR ALUM LATA BORBOLETA 16CM 3092
Código: Fábrica: Unidade:
44736 WINCY UN/1
F1 F4

UN: R\$ 5,13 AV: R\$ 61,51 15: R\$ 62,79
30: R\$ 64,05 45: R\$ 65,33 60: R\$ 66,63



ABRIDOR COMBIN INOX LATA/GARR 1004 12X1
Código: Fábrica: Unidade:
14382 JWC DZ/12
F1 F4

UN: R\$ 3,48 AV: R\$ 3,48 15: R\$ 3,55
30: R\$ 3,63 45: R\$ 3,70 60: R\$ 3,77



ABRIDOR COMBINADO INOX LATA/GARRAFA 147
Código: Fábrica: Unidade:
44771 NICOBEM CT/1
F1 F4

UN: R\$ 2,98 AV: R\$ 2,98 15: R\$ 3,04
30: R\$ 3,10 45: R\$ 3,16 60: R\$ 3,23



ABRIDOR COMBINADO INOX LATA/GARRAFA 279
Código: Fábrica: Unidade:
44503 PLANETA CT/1
F1 F4

UN: R\$ 2,06 AV: R\$ 24,72 15: R\$ 25,24
30: R\$ 25,74 45: R\$ 26,26 60: R\$ 26,78



ABRIDOR COMBINADO LATA/GARRAFA 1001 12X1
Código: Fábrica: Unidade:
1915 JWC DZ/12
F1 F4

UN: R\$ 4,61 AV: R\$ 4,61 15: R\$ 4,71
30: R\$ 4,80 45: R\$ 4,90 60: R\$ 5,00



ABRIDOR COMBINADO+SACA ROLHA CTL 2028
Código: Fábrica: Unidade:
33288 JWC CR/1
F1 F4

UN: R\$ 2,28 AV: R\$ 27,36 15: R\$ 27,93
30: R\$ 28,49 45: R\$ 29,06 60: R\$ 29,64



ABRIDOR GARRAFA NA CX 1002 12X1
Código: Fábrica: Unidade:
13925 JWC DZ/12
F1 F4

UN: R\$ 1,53 AV: R\$ 18,37 15: R\$ 18,75
30: R\$ 19,12 45: R\$ 19,51 60: R\$ 19,90



ABRIDOR INOX GARRAFAS GARCON 280 12X1
Código: Fábrica: Unidade:
48691 PLANETA DZ/12
F1 F4

UN: R\$ 2,59 AV: R\$ 2,59 15: R\$ 2,64
30: R\$ 2,70 45: R\$ 2,75 60: R\$ 2,80



ABRIDOR INOX GARRAFAS GARCON 281 CTL
Código: Fábrica: Unidade:
48694 PLANETA CR/1
F1 F4

UN: R\$ 2,22 AV: R\$ 26,70 15: R\$ 27,25
30: R\$ 27,80 45: R\$ 28,35 60: R\$ 28,92



ABRIDOR SACA ROLHA CABO PLAST 1006 12X1
Código: Fábrica: Unidade:
2886 JWC DZ/12
F1 F4

UN: R\$ 7,59 AV: R\$ 7,59 15: R\$ 7,75
30: R\$ 7,90 45: R\$ 8,06 60: R\$ 8,22



ABRIDOR SACA ROLHA INOX MULTIUSOCTL 5385
Código: Fábrica: Unidade:
43270 MEGAGIFT UN/1
F1 F4

UN: R\$ 10,27 AV: R\$ 123,25 15: R\$ 125,82
30: R\$ 128,34 45: R\$ 130,90 60: R\$ 133,52



ABRIDOR SACA ROLHAS INOX DUPLO EST 12X1
Código: Fábrica: Unidade:
46585 HERCULES CX/12
F1 F4

UN: R\$ 1,53 AV: R\$ 1,53 15: R\$ 1,56
30: R\$ 1,59 45: R\$ 1,63 60: R\$ 1,66



ADAPTADOR PORTA FILTRO PLAST 5026 UN
Código: Fábrica: Unidade:
49399 SBRISSA UN/1
F1 F4

UN: R\$ 1,46 AV: R\$ 29,28 15: R\$ 29,89
30: R\$ 30,48 45: R\$ 31,09 60: R\$ 31,71



ADAPTADOR PORTA FILTRO PLAST 5026 20X1
Código: Fábrica: Unidade:
31283 SBRISSA PT/20
F1 F4

UN: R\$ 0,62 AV: R\$ 30,81 15: R\$ 31,45
30: R\$ 32,08 45: R\$ 32,72 60: R\$ 33,37



ADAPTADOR 1/2 TORNEI/MANG PTO AD51N 50X1
Código: Fábrica: Unidade:
40147 REBOUCAS PT/50
F1 F4

UN: R\$ 1,03 AV: R\$ 51,35 15: R\$ 52,42
30: R\$ 53,47 45: R\$ 54,54 60: R\$ 55,63



ADAPTADOR 3/4 TORNEI/MANG PTO AD52N 50X1
Código: Fábrica: Unidade:
40148 REBOUCAS PT/50
F1 F4

UN: R\$ 7,69 AV: R\$ 7,69 15: R\$ 7,85
30: R\$ 8,01 45: R\$ 8,17 60: R\$ 8,33



AFIADOR DE FACA C/VENTOSA PLAST 371

Código: Fábrica: Unidade:
48689 PLANETA UN/1
F1 F4

UN: R\$ 4,92 AV: R\$ 4,92 15: R\$ 5,02
30: R\$ 5,12 45: R\$ 5,23 60: R\$ 5,33



AGUA SANITARIA MAIS 1 LT

Código: Fábrica: Unidade:
48940 MAIS UN/1
F1 F4

UN: R\$ 0,61 AV: R\$ 3,07 15: R\$ 3,14
30: R\$ 3,20 45: R\$ 3,26 60: R\$ 3,33



AGULHA P/DESENTUPIR FOGAO CTL 2023 5X1

Código: Fábrica: Unidade:
33290 JWC CR/5
F1 F4

UN: R\$ 2,40 AV: R\$ 28,75 15: R\$ 29,35
30: R\$ 29,94 45: R\$ 30,54 60: R\$ 31,15

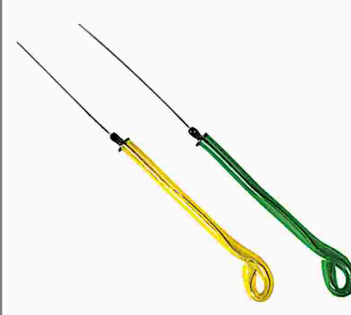

AGULHA P/DESENTUPIR FOGAO 12X1

Código: Fábrica: Unidade:
7374 ALE DZ/12
F1 F4

UN: R\$ 16,42 AV: R\$ 16,42 15: R\$ 16,77
30: R\$ 17,10 45: R\$ 17,44 60: R\$ 17,79



AMASSADOR ALUM INTEIRICO BATATA 2007 UN

Código: Fábrica: Unidade:
48030 COFAX UN/1
F1 F4

UN: R\$ 14,00 AV: R\$ 14,00 15: R\$ 14,29
30: R\$ 14,58 45: R\$ 14,87 60: R\$ 15,17



AMASSADOR INOX ALHO PRIME 061

Código: Fábrica: Unidade:
49376 RIOHOME UN/1
F1 F4

UN: R\$ 10,26 AV: R\$ 10,26 15: R\$ 10,48
30: R\$ 10,69 45: R\$ 10,90 60: R\$ 11,12



AMERICANO P/MESA 24X24CM TM-2424

Código: Fábrica: Unidade:
39280 XHADAY UN/1
F1 F4

UN: R\$ 6,42 AV: R\$ 6,42 15: R\$ 6,55
30: R\$ 6,68 45: R\$ 6,82 60: R\$ 6,95

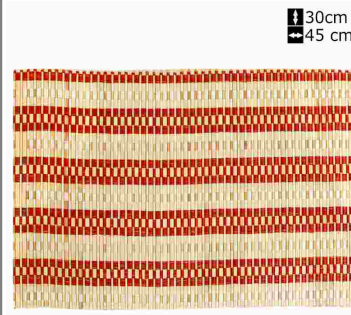

AMERICANO P/MESA 30X45CM 10221

Código: Fábrica: Unidade:
45882 ALMEGA UN/1
F1 F4

UN: R\$ 2,31 AV: R\$ 9,23 15: R\$ 9,43
30: R\$ 9,62 45: R\$ 9,81 60: R\$ 10,00



AMERICANO P/MESA 35X48CM JOGO 4PCS

Código: Fábrica: Unidade:
29116 FERREIRA PT/4
F1 F4

UN: R\$ 5,14 AV: R\$ 5,14 15: R\$ 5,24
30: R\$ 5,35 45: R\$ 5,45 60: R\$ 5,56



ARCO ALUMINIO N1 P/PLANTA 1011

Código: Fábrica: Unidade:
37169 PAIOL UN/1
F1 F4

UN: R\$ 6,78 AV: R\$ 6,78 15: R\$ 6,92
30: R\$ 7,06 45: R\$ 7,20 60: R\$ 7,34



ARCO ALUMINIO N2 P/PLANTA 3000

Código: Fábrica: Unidade:
37170 PAIOL UN/1
F1 F4

UN: R\$ 8,42 AV: R\$ 8,42 15: R\$ 8,60
30: R\$ 8,77 45: R\$ 8,95 60: R\$ 9,12

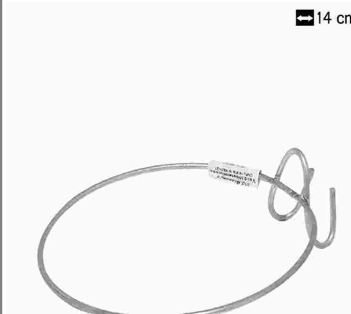

ARCO ALUMINIO N3 P/PLANTA 3001

Código: Fábrica: Unidade:
37172 PAIOL UN/1
F1 F4

UN: R\$ 15,41 AV: R\$ 15,41 15: R\$ 15,73
30: R\$ 16,04 45: R\$ 16,36 60: R\$ 16,69

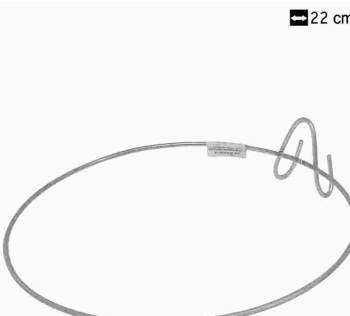

ARCO ALUMINIO N5 P/PLANTA 3003

Código: Fábrica: Unidade:
37173 PAIOL UN/1
F1 F4

UN: R\$ 6,15 AV: R\$ 6,15 15: R\$ 6,28
30: R\$ 6,41 45: R\$ 6,53 60: R\$ 6,67



ARRANJO BAMBU QUAD 6X6CM 8058

Código: Fábrica: Unidade:
40590 PAIOL UN/1
F1 F4

UN: R\$ 9,05 AV: R\$ 9,05 15: R\$ 9,24
30: R\$ 9,42 45: R\$ 9,61 60: R\$ 9,80



ARRANJO BAMBU RED 5X5CM 8062

Código: Fábrica: Unidade:
40591 PAIOL UN/1
F1 F4

UN: R\$ 17,45 AV: R\$ 17,45 15: R\$ 17,82
30: R\$ 18,17 45: R\$ 18,54 60: R\$ 18,91



ASSADEIRA ALUM CORACA0 01 1263

Código: Fábrica: Unidade:
37513 MSR UN/1
F1 F4

UN: R\$ 25,67 AV: R\$ 25,67 15: R\$ 26,20
30: R\$ 26,73 45: R\$ 27,26 60: R\$ 27,81



ASSADEIRA ALUM CORACAO 02 1264
Código: 37254 Fábrica: MSR Unidade: UN/1
F1 F4

UN: R\$ 42,63 AV: R\$ 42,63 15: R\$ 43,52
30: R\$ 44,39 45: R\$ 45,28 60: R\$ 46,18



ASSADEIRA ALUM CORACAO 03 1265
Código: 37252 Fábrica: MSR Unidade: UN/1
F1 F4

UN: R\$ 31,83 AV: R\$ 31,83 15: R\$ 32,50
30: R\$ 33,15 45: R\$ 33,81 60: R\$ 34,49



ASSADEIRA ALUM FUNDO FALSO 01 648
Código: 35257 Fábrica: MSR Unidade: UN/1
F1 F4

UN: R\$ 42,21 AV: R\$ 42,21 15: R\$ 43,09
30: R\$ 43,95 45: R\$ 44,83 60: R\$ 45,72



ASSADEIRA ALUM FUNDO FALSO 02 649
Código: 35258 Fábrica: MSR Unidade: UN/1
F1 F4

UN: R\$ 52,38 AV: R\$ 52,38 15: R\$ 53,47
30: R\$ 54,54 45: R\$ 55,63 60: R\$ 56,74



ASSADEIRA ALUM FUNDO FALSO 03 650
Código: 37523 Fábrica: MSR Unidade: UN/1
F1 F4

UN: R\$ 20,53 AV: R\$ 20,53 15: R\$ 20,96
30: R\$ 21,38 45: R\$ 21,81 60: R\$ 22,24



ASSADEIRA ALUM OVAL 01 651
Código: 37519 Fábrica: MSR Unidade: UN/1
F1 F4

UN: R\$ 29,99 AV: R\$ 29,99 15: R\$ 30,62
30: R\$ 31,23 45: R\$ 31,86 60: R\$ 32,49



ASSADEIRA ALUM OVAL 02 652
Código: 37520 Fábrica: MSR Unidade: UN/1
F1 F4

UN: R\$ 43,83 AV: R\$ 43,83 15: R\$ 44,74
30: R\$ 45,64 45: R\$ 46,55 60: R\$ 47,48



ASSADEIRA ALUM OVAL 03 653
Código: 37521 Fábrica: MSR Unidade: UN/1
F1 F4

UN: R\$ 112,98 AV: R\$ 112,98 15: R\$ 115,34
30: R\$ 117,64 45: R\$ 120,00 60: R\$ 122,40



ASSADEIRA VIDRO RET KIT 3UN (2,2/1,6/1L)
Código: 47415 Fábrica: DIAMONDS Unidade: CJ/1
F1 F4

UN: R\$ 25,52 AV: R\$ 25,52 15: R\$ 26,05
30: R\$ 26,57 45: R\$ 27,10 60: R\$ 27,64



AVENTAL NYLON PP 1,10X63CM PEIXEIRO 32
Código: 49687 Fábrica: MARIO BRITO Unidade: UN/1
F1 F4

UN: R\$ 6,90 AV: R\$ 6,90 15: R\$ 7,05
30: R\$ 7,19 45: R\$ 7,33 60: R\$ 7,48



AVENTAL NYLON PP 45X65CM REDONDO LISO 01
Código: 49686 Fábrica: MARIO BRITO Unidade: UN/1
F1 F4

UN: R\$ 8,35 AV: R\$ 8,35 15: R\$ 8,53
30: R\$ 8,70 45: R\$ 8,87 60: R\$ 9,05



AVENTAL NYLON 50X70CM C/BOLSO 72901
Código: 49580 Fábrica: ALMEGA Unidade: UN/1
F1 F4

UN: R\$ 15,92 AV: R\$ 15,92 15: R\$ 16,25
30: R\$ 16,58 45: R\$ 16,91 60: R\$ 17,25



AVENTAL PVC GDE 56X85CM
Código: 32344 Fábrica: FERREIRA Unidade: UN/1
F1 F4

UN: R\$ 14,37 AV: R\$ 14,37 15: R\$ 14,67
30: R\$ 14,96 45: R\$ 15,26 60: R\$ 15,57



AVENTAL PVC MED 50X75CM
Código: 28178 Fábrica: FERREIRA Unidade: UN/1
F1 F4

UN: R\$ 20,53 AV: R\$ 20,53 15: R\$ 20,96
30: R\$ 21,38 45: R\$ 21,81 60: R\$ 22,24



AVENTAL PVC 50X70CM C/BOLSO (CANGURU)
Código: 44154 Fábrica: FERREIRA Unidade: UN/1
F1 F4

UN: R\$ 25,67 AV: R\$ 25,67 15: R\$ 26,20
30: R\$ 26,73 45: R\$ 27,26 60: R\$ 27,81



BACIA ALUM LEVE 25 1,300 ML
Código: 5906 Fábrica: AVELAR Unidade: UN/1
F1 F4

UN: R\$ 17,66 AV: R\$ 17,66 15: R\$ 18,03
30: R\$ 18,39 45: R\$ 18,76 60: R\$ 19,13



BACIA N23 23 LTSCANELADA PRETO 10080
Código: Fábrica: Unidade:
41441 PLASMARC UN/1
F1 F4

UN: R\$ 7,78 AV: R\$ 7,78 15: R\$ 7,94
30: R\$ 8,10 45: R\$ 8,26 60: R\$ 8,42



BACIA PLAST 2,3 LTS BRANCO
Código: Fábrica: Unidade:
40775 NUTRIPLAN UN/1
F1 F4

UN: R\$ 6,48 AV: R\$ 6,48 15: R\$ 6,61
30: R\$ 6,75 45: R\$ 6,88 60: R\$ 7,02



BACIA PLAST 3 LTS PRETA 2001
Código: Fábrica: Unidade:
40378 FORMPLAST UN/1
F1 F4

UN: R\$ 7,45 AV: R\$ 7,45 15: R\$ 7,60
30: R\$ 7,75 45: R\$ 7,91 60: R\$ 8,07



BACIA PLAST 3,3 LTS TRANSLUCIDA 0524
Código: Fábrica: Unidade:
7495 JAGUAR UN/1
F1 F4

UN: R\$ 3,99 AV: R\$ 3,99 15: R\$ 3,99
30: R\$ 3,99 45: R\$ 3,99 60: R\$ 3,99



BACIA PLAST 3,5 LTS CANELADA 387
Código: Fábrica: Unidade:
35577 BH PLASTIC UN/1
F1 F4

UN: R\$ 12,40 AV: R\$ 12,40 15: R\$ 12,66
30: R\$ 12,91 45: R\$ 13,17 60: R\$ 13,43



BACIA PLAST 6,7 LTS TRANSLUCIDA 0526
Código: Fábrica: Unidade:
8265 JAGUAR UN/1
F1 F4

UN: R\$ 20,91 AV: R\$ 20,91 15: R\$ 21,35
30: R\$ 21,77 45: R\$ 22,21 60: R\$ 22,65

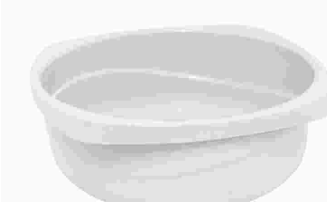

BACIA PLAST 8 LTS BRANCO
Código: Fábrica: Unidade:
40776 NUTRIPLAN UN/1
F1 F4

UN: R\$ 15,63 AV: R\$ 15,63 15: R\$ 15,96
30: R\$ 16,28 45: R\$ 16,60 60: R\$ 16,94



BACIA PLAST N18 13 LTS CANELAD PRETO 119
Código: Fábrica: Unidade:
41442 PLASMARC UN/1
F1 F4

UN: R\$ 12,09 AV: R\$ 12,09 15: R\$ 12,34
30: R\$ 12,59 45: R\$ 12,84 60: R\$ 13,10



BACIA PLAST 12 LTS CANELADA 6614
Código: Fábrica: Unidade:
8705 INPLAST UN/1
F1 F4

UN: R\$ 12,95 AV: R\$ 12,95 15: R\$ 13,22
30: R\$ 13,48 45: R\$ 13,75 60: R\$ 14,03



BACIA PLAST 12,0 LTS CANELADA
Código: Fábrica: Unidade:
30892 BH PLASTIC UN/1
F1 F4

UN: R\$ 21,15 AV: R\$ 21,15 15: R\$ 21,59
30: R\$ 22,02 45: R\$ 22,46 60: R\$ 22,91



BACIA PLAST 13 LTS COLLOR 860
Código: Fábrica: Unidade:
39562 LUMAR UN/1
F1 F4

UN: R\$ 38,29 AV: R\$ 38,29 15: R\$ 39,08
30: R\$ 39,87 45: R\$ 40,66 60: R\$ 41,48

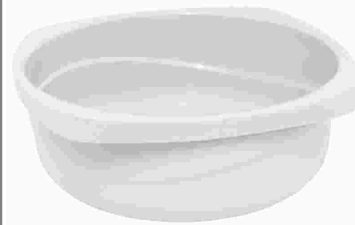

BACIA PLAST 14 LTS BRANCO
Código: Fábrica: Unidade:
40777 NUTRIPLAN UN/1
F1 F4

UN: R\$ 5,95 AV: R\$ 5,95 15: R\$ 6,07
30: R\$ 6,19 45: R\$ 6,32 60: R\$ 6,44



BACIA PLAST 1,5 LTS COLOR
Código: Fábrica: Unidade:
20585 ECOPLASTIC UN/1
F1 F4

UN: R\$ 21,56 AV: R\$ 21,56 15: R\$ 22,01
30: R\$ 22,45 45: R\$ 22,90 60: R\$ 23,36



BACIA PLAST 15 LTS TRANSLUCIDA 0528
Código: Fábrica: Unidade:
7496 JAGUAR UN/1
F1 F4

UN: R\$ 16,74 AV: R\$ 16,74 15: R\$ 17,09
30: R\$ 17,43 45: R\$ 17,78 60: R\$ 18,14



BACIA PLAST 18 LTS PRETA 105
Código: Fábrica: Unidade:
40404 FORMPLAST UN/1
F1 F4

UN: R\$ 2,39 AV: R\$ 2,39 15: R\$ 2,39
30: R\$ 2,39 45: R\$ 2,39 60: R\$ 2,39



BACIA PLAST 2 LTS CANELADA PRETA 6304
Código: Fábrica: Unidade:
41493 KOZI PLAST UN/1
F1 F4

UN: R\$ 8,19 AV: R\$ 8,19 15: R\$ 8,36
30: R\$ 8,53 45: R\$ 8,70 60: R\$ 8,87



BACIA PLAST 2,4 LTS 71493
Código: Fábrika: Unidade:
31295 Y888 UN/1
F1 F4

UN: R\$ 2,99 AV: R\$ 2,99 15: R\$ 2,99
30: R\$ 2,99 45: R\$ 2,99 60: R\$ 2,99



BACIA PLAST 3 LTS CANELADA PRETA 6305
Código: Fábrika: Unidade:
41474 KOZI PLAST UN/1
F1 F4

UN: R\$ 7,68 AV: R\$ 7,68 15: R\$ 7,84
30: R\$ 8,00 45: R\$ 8,16 60: R\$ 8,32



BACIA PLAST 3,0 LTS LISA
Código: Fábrika: Unidade:
17857 ECOPLASTIC UN/1
F1 F4

UN: R\$ 9,23 AV: R\$ 9,23 15: R\$ 9,43
30: R\$ 9,62 45: R\$ 9,81 60: R\$ 10,00

15 cm
32 cm
7 lts



BACIA PLAST 7 LTS COLOR
Código: Fábrika: Unidade:
45279 MOLDE MINAS UN/1
F1 F4

UN: R\$ 2,89 AV: R\$ 2,89 15: R\$ 2,89
30: R\$ 2,89 45: R\$ 2,89 60: R\$ 2,89



BACIA 1,2 LTS CANELADA RECICLADA 6001
Código: Fábrika: Unidade:
17981 SBRISSA UN/1
F1 F4

UN: R\$ 5,97 AV: R\$ 5,97 15: R\$ 6,09
30: R\$ 6,21 45: R\$ 6,34 60: R\$ 6,47



BACIA 2,5 LTS CANELADA RECICLADA 6002
Código: Fábrika: Unidade:
17982 SBRISSA UN/1
F1 F4

UN: R\$ 6,99 AV: R\$ 6,99 15: R\$ 6,99
30: R\$ 6,99 45: R\$ 6,99 60: R\$ 6,99



BACIA 2,5 LTS CANELADA TRANSPARENTE 4007
Código: Fábrika: Unidade:
19763 SBRISSA UN/1
F1 F4

UN: R\$ 11,54 AV: R\$ 11,54 15: R\$ 11,78
30: R\$ 12,01 45: R\$ 12,25 60: R\$ 12,50



BACIA 4,5 LTS CANELADA RECICLADA 6003
Código: Fábrika: Unidade:
17983 SBRISSA UN/1
F1 F4

UN: R\$ 12,43 AV: R\$ 12,43 15: R\$ 12,69
30: R\$ 12,94 45: R\$ 13,20 60: R\$ 13,46



BACIA 4,5 LTS CANELADA TRANSPARENTE 4008
Código: Fábrika: Unidade:
18713 SBRISSA UN/1
F1 F4

UN: R\$ 21,99 AV: R\$ 21,99 15: R\$ 21,99
30: R\$ 21,99 45: R\$ 21,99 60: R\$ 21,99



BACIAO PLAST 35 LTS CANELADA 719/92
Código: Fábrika: Unidade:
36696 LUMAR/PA UN/1
F1 F4

UN: R\$ 98,60 AV: R\$ 98,60 15: R\$ 100,66
30: R\$ 102,67 45: R\$ 104,72 60: R\$ 106,82



BALDE METAL 5 LTS DEC FLAMENGO 1893
Código: Fábrika: Unidade:
41121 BRASFOOT UN/1
F1 F4

UN: R\$ 4,99 AV: R\$ 4,99 15: R\$ 4,99
30: R\$ 4,99 45: R\$ 4,99 60: R\$ 4,99



BALDE PLAST 2,5 LTS P/PIPOCA 7008
Código: Fábrika: Unidade:
31284 SBRISSA UN/1
F1 F4

UN: R\$ 6,99 AV: R\$ 6,99 15: R\$ 6,99
30: R\$ 6,99 45: R\$ 6,99 60: R\$ 6,99

23cm
25cm
7,5lts



BALDE PLAST 7,5 LTS C/ALCA METAL 90
Código: Fábrika: Unidade:
36698 P A SOUZA UN/1
F1 F4

UN: R\$ 25,91 AV: R\$ 25,91 15: R\$ 26,45
30: R\$ 26,97 45: R\$ 27,51 60: R\$ 28,06

9 Lts

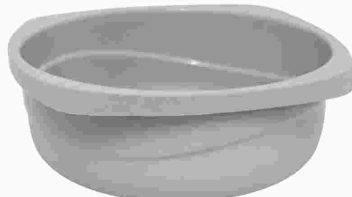

BALDE PLAST 9 LTS CINZA
Código: Fábrika: Unidade:
40778 NUTRIPLAN UN/1
F1 F4

UN: R\$ 25,67 AV: R\$ 25,67 15: R\$ 26,20
30: R\$ 26,73 45: R\$ 27,26 60: R\$ 27,81

9 Lts



BALDE PLAST LATA CONCRETO 16 LTS PRETA
Código: Fábrika: Unidade:
20661 ECOPLASTIC UN/1
F1 F4

UN: R\$ 11,99 AV: R\$ 11,99 15: R\$ 11,99
30: R\$ 11,99 45: R\$ 11,99 60: R\$ 11,99



BALDE PLAST 12 LTS ELEGANCE PRETO 413
Código: Fábrika: Unidade:
50005 PLASMARC UN/1
F1 F4

UN: R\$ 10,99 AV: R\$ 10,99 15: R\$ 10,99
30: R\$ 10,99 45: R\$ 10,99 60: R\$ 10,99



BALDE PLAST 12 LTS PRETO P/CONCRETO 105
Código: Fábrika: Unidade:
40719 ECOPLASTIC UN/1
F1 F4

UN: R\$ 4,10 AV: R\$ 4,10 15: R\$ 4,18
30: R\$ 4,27 45: R\$ 4,35 60: R\$ 4,44



BALDE PLAST 1,2LTS PIPOCA COLOR ADE 3105
Código: Fábrika: Unidade:
50088 LIDER PLUS UN/1
F1 F4

UN: R\$ 3,07 AV: R\$ 3,07 15: R\$ 3,14
30: R\$ 3,20 45: R\$ 3,26 60: R\$ 3,33



BALDE PLAST 1,2LTS PIPOCA COLOR 3104
Código: Fábrika: Unidade:
41785 LIDER PLUS UN/1
F1 F4

UN: R\$ 14,52 AV: R\$ 14,52 15: R\$ 14,83
30: R\$ 15,12 45: R\$ 15,43 60: R\$ 15,73



BALDE PLAST 13 LTS ALCA METAL 6615
Código: Fábrika: Unidade:
14402 INPLAST UN/1
F1 F4

UN: R\$ 16,48 AV: R\$ 16,48 15: R\$ 16,82
30: R\$ 17,16 45: R\$ 17,50 60: R\$ 17,85



BALDE PLAST 13 LTS OVAL ALCA PLAST 102
Código: Fábrika: Unidade:
40717 PLASMARC UN/1
F1 F4

UN: R\$ 11,49 AV: R\$ 11,49 15: R\$ 11,49
30: R\$ 11,49 45: R\$ 11,49 60: R\$ 11,49



BALDE PLAST 15 LTS PRETO ALCA METAL
Código: Fábrika: Unidade:
17810 SHANGRILA UN/1
F1 F4

1 07 cm
2 32 cm
3 15 lts

UN: R\$ 16,67 AV: R\$ 16,67 15: R\$ 17,02
30: R\$ 17,36 45: R\$ 17,71 60: R\$ 18,06



BALDE PLAST 15 LTS 753
Código: Fábrika: Unidade:
37263 LUMAR UN/1
F1 F4

UN: R\$ 22,39 AV: R\$ 22,39 15: R\$ 22,86
30: R\$ 23,32 45: R\$ 23,78 60: R\$ 24,26



BALDE PLAST 20 LTS 720
Código: Fábrika: Unidade:
37262 LUMAR UN/1
F1 F4

UN: R\$ 2,97 AV: R\$ 2,97 15: R\$ 3,03
30: R\$ 3,09 45: R\$ 3,15 60: R\$ 3,22
1 13 cm



BALDINHO PLAST P/PIPOCA 1065
Código: Fábrika: Unidade:
37802 ENGIPLAST UN/1
F1 F4

UN: R\$ 4,00 AV: R\$ 4,00 15: R\$ 4,08
30: R\$ 4,16 45: R\$ 4,24 60: R\$ 4,33



BANDEJA 15 CELULAS BAIXA 5 F PRETO 2134
Código: Fábrika: Unidade:
33544 NUTRIPLAN UN/1
F1 F4

1 07 cm
2 21 cm
3 34 cm
4 02 lts

UN: R\$ 9,23 AV: R\$ 9,23 15: R\$ 9,43
30: R\$ 9,62 45: R\$ 9,81 60: R\$ 10,00



BANDEJA 30 CELULAS PRETO
Código: Fábrika: Unidade:
33545 NUTRIPLAN UN/1
F1 F4

1 09 cm
2 30 cm
3 36 cm
4 03 lts

UN: R\$ 25,67 AV: R\$ 25,67 15: R\$ 26,20
30: R\$ 26,73 45: R\$ 27,26 60: R\$ 27,81



BANDEJA BAMBU 39X15X1,2CM 114
Código: Fábrika: Unidade:
47904 CASITA UN/1
F1 F4

UN: R\$ 28,75 AV: R\$ 28,75 15: R\$ 29,35
30: R\$ 29,94 45: R\$ 30,54 60: R\$ 31,15
1 4,5 cm
2 30 cm

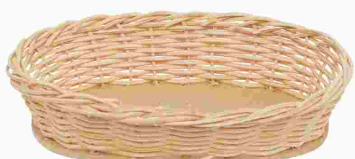

BANDEJA CIPO BRANCO OVAL GDE 8102
Código: Fábrika: Unidade:
40599 PAIOL UN/1
F1 F4

UN: R\$ 61,62 AV: R\$ 61,62 15: R\$ 62,91
30: R\$ 64,16 45: R\$ 65,45 60: R\$ 66,76
1 4,5 cm
2 23,5 cm



BANDEJA CIPO BRANCO OVAL PQ 8106
Código: Fábrika: Unidade:
40595 PAIOL UN/1
F1 F4

UN: R\$ 28,75 AV: R\$ 28,75 15: R\$ 29,35
30: R\$ 29,94 45: R\$ 30,54 60: R\$ 31,15
1 5 cm
2 22 cm



BANDEJA CIPO BRANCO RED GDE 8101
Código: Fábrika: Unidade:
40602 PAIOL UN/1
F1 F4

UN: R\$ 61,62 AV: R\$ 61,62 15: R\$ 62,91
30: R\$ 64,16 45: R\$ 65,45 60: R\$ 66,76
1 2,5 cm
2 21,5 cm





BANDEJA CORCAO CIPO BRANCO N4 8114
Código: Fábrika: Unidade:
40606 PAIOL UN/1
F1 F4

UN: R\$ 55,46 AV: R\$ 55,46 15: R\$ 56,61
 30: R\$ 57,75 45: R\$ 58,90 60: R\$ 60,08
 2,5 cm
 25 cm





BANDEJA CORACAO CIPO BRANCO N5 8115
 Código: Fábrica: Unidade:
40607 PAIOL UN/1
 F1 F4

UN: R\$ 30,81 AV: R\$ 30,81 15: R\$ 31,45
 30: R\$ 32,08 45: R\$ 32,72 60: R\$ 33,37
 5,5 cm
 30,5 cm
 31,5 cm





BANDEJA CORACAO FIO GDE BANANA 6999-2
 Código: Fábrica: Unidade:
39450 PAIOL UN/1
 F1 F4

UN: R\$ 33,89 AV: R\$ 33,89 15: R\$ 34,59
 30: R\$ 35,29 45: R\$ 35,99 60: R\$ 36,71
 6 cm
 29 cm





BANDEJA CORACAO FIO MED ARGILA 7000-1
 Código: Fábrica: Unidade:
37206 PAIOL UN/1
 F1 F4

UN: R\$ 33,89 AV: R\$ 33,89 15: R\$ 34,59
 30: R\$ 35,29 45: R\$ 35,99 60: R\$ 36,71
 5,5 cm
 26 cm
 26 cm





BANDEJA CORACAO FIO MED BANANA 7000-2
 Código: Fábrica: Unidade:
39451 PAIOL UN/1
 F1 F4

UN: R\$ 29,78 AV: R\$ 29,78 15: R\$ 30,40
 30: R\$ 31,01 45: R\$ 31,63 60: R\$ 32,26
 6 cm
 22 cm



BANDEJA CORACAO FIO PEQ ARGILA 7001-1
 Código: Fábrica: Unidade:
37207 PAIOL UN/1
 F1 F4

UN: R\$ 29,78 AV: R\$ 29,78 15: R\$ 30,40
 30: R\$ 31,01 45: R\$ 31,63 60: R\$ 32,26
 5,5 cm
 21 cm
 21 cm



BANDEJA CORACAO FIO PEQ BANANA 7001-2
 Código: Fábrica: Unidade:
39452 PAIOL UN/1
 F1 F4

UN: R\$ 33,89 AV: R\$ 33,89 15: R\$ 34,59
 30: R\$ 35,29 45: R\$ 35,99 60: R\$ 36,71



BANDEJA CORACAO PINUS ENVELHEC GDE 3103
 Código: Fábrica: Unidade:
41749 PAIOL UN/1
 F1 F4

UN: R\$ 27,72 AV: R\$ 27,72 15: R\$ 28,30
 30: R\$ 28,87 45: R\$ 29,45 60: R\$ 30,03





BANDEJA CORACAO PINUS ENVELHEC MED 3104
 Código: Fábrica: Unidade:
40845 PAIOL UN/1
 F1 F4

UN: R\$ 22,21 AV: R\$ 22,21 15: R\$ 22,67
 30: R\$ 23,12 45: R\$ 23,59 60: R\$ 24,06





BANDEJA CORACAO PINUS ENVELHEC PEQ 3105
 Código: Fábrica: Unidade:
41750 PAIOL UN/1
 F1 F4

UN: R\$ 39,98 AV: R\$ 39,98 15: R\$ 40,81
 30: R\$ 41,63 45: R\$ 42,46 60: R\$ 43,31
 6 cm
 35 cm





BANDEJA FIO GDE 8013
 Código: Fábrica: Unidade:
37196 PAIOL UN/1
 F1 F4

UN: R\$ 36,47 AV: R\$ 36,47 15: R\$ 37,23
 30: R\$ 37,97 45: R\$ 38,73 60: R\$ 39,50
 6 cm
 28 cm





BANDEJA FIO MED 8014
 Código: Fábrica: Unidade:
37197 PAIOL UN/1
 F1 F4

UN: R\$ 28,47 AV: R\$ 28,47 15: R\$ 29,07
 30: R\$ 29,65 45: R\$ 30,24 60: R\$ 30,85
 6 cm
 24 cm



BANDEJA FIO PEQ 8015
 Código: Fábrica: Unidade:
37198 PAIOL UN/1
 F1 F4

UN: R\$ 47,24 AV: R\$ 47,24 15: R\$ 48,23
 30: R\$ 49,19 45: R\$ 50,17 60: R\$ 51,18
 7,5 cm
 42 cm

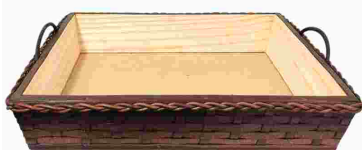

BANDEJA FITA GDE 8010
 Código: Fábrica: Unidade:
37193 PAIOL UN/1
 F1 F4

UN: R\$ 12,33 AV: R\$ 12,33 15: R\$ 12,58
 30: R\$ 12,83 45: R\$ 13,09 60: R\$ 13,35
 22 cm



BANDEJA INOX OVAL 22CM 800-17
 Código: Fábrica: Unidade:
40529 CASA ONZE UN/1
 F1 F4

UN: R\$ 14,38 AV: R\$ 14,38 15: R\$ 14,68
 30: R\$ 14,97 45: R\$ 15,27 60: R\$ 15,58
 25 cm



BANDEJA INOX OVAL 25CM 800-18
 Código: Fábrica: Unidade:
40532 CASA ONZE UN/1
 F1 F4

UN: R\$ 47,87 AV: R\$ 47,87 15: R\$ 48,86
 30: R\$ 49,84 45: R\$ 50,84 60: R\$ 51,86
 35 cm



BANDEJA INOX RED EMBORRACHAD 35CM 180205
 Código: Fábrica: Unidade:
39227 SATYAM UN/1
 F1 F4

UN: R\$ 60,40 AV: R\$ 60,40 15: R\$ 61,66
30: R\$ 62,89 45: R\$ 64,15 60: R\$ 65,43

40 cm



BANDEJA INOX RED EMBORRACHAD 40CM 180206

Código: Fábrica: Unidade:
39228 SATYAM UN/1
F1 F4

UN: R\$ 35,94 AV: R\$ 35,94 15: R\$ 36,69
30: R\$ 37,42 45: R\$ 38,17 60: R\$ 38,94

17 cm
40 cm



BANDEJA PINUS GDE 8016

Código: Fábrica: Unidade:
37199 PAIOL UN/1
F1 F4

UN: R\$ 38,00 AV: R\$ 38,00 15: R\$ 38,79
30: R\$ 39,56 45: R\$ 40,35 60: R\$ 41,16

10 cm
35 cm



BANDEJA PINUS MED 8017

Código: Fábrica: Unidade:
37200 PAIOL UN/1
F1 F4

UN: R\$ 33,89 AV: R\$ 33,89 15: R\$ 34,59
30: R\$ 35,29 45: R\$ 35,99 60: R\$ 36,71

9,5 cm
28 cm



BANDEJA PINUS PEQ 8018

Código: Fábrica: Unidade:
37201 PAIOL UN/1
F1 F4

UN: R\$ 4,18 AV: R\$ 4,18 15: R\$ 4,27
30: R\$ 4,35 45: R\$ 4,44 60: R\$ 4,53

5,5 cm
30 cm
18 cm



BANDEJA PLAST MULTI USO 1,5L 17X31CM 731

Código: Fábrica: Unidade:
44083 QUALYPLAS UN/1
F1 F4

UN: R\$ 54,44 AV: R\$ 54,44 15: R\$ 55,58
30: R\$ 56,69 45: R\$ 57,82 60: R\$ 58,98

65 cm

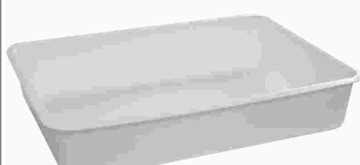

BANDEJA PLAST N5 BCA 26LTS 584

Código: Fábrica: Unidade:
37781 TRITEC UN/1
F1 F4

UN: R\$ 20,53 AV: R\$ 20,53 15: R\$ 20,96
30: R\$ 21,38 45: R\$ 21,81 60: R\$ 22,24

44cm
32cm



BANDEJA PLAST 32,5X43,5CM MULTI USO 1562

Código: Fábrica: Unidade:
47063 JAGUAR UN/1
F1 F4

UN: R\$ 36,98 AV: R\$ 36,98 15: R\$ 37,75
30: R\$ 38,50 45: R\$ 39,27 60: R\$ 40,06

9,5 cm
26 cm

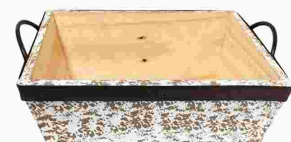

BANDEJA TEXTURA PEQ 8009

Código: Fábrica: Unidade:
37192 PAIOL UN/1
F1 F4

UN: R\$ 5,39 AV: R\$ 5,39 15: R\$ 5,51
30: R\$ 5,62 45: R\$ 5,73 60: R\$ 5,84



BANDEJA 128 CELULAS FINA PRETO

Código: Fábrica: Unidade:
38916 NUTRIPLAN UN/1
F1 F4

UN: R\$ 5,13 AV: R\$ 5,13 15: R\$ 5,23
30: R\$ 5,34 45: R\$ 5,44 60: R\$ 5,55

04 cm
27 cm
53 cm
2,5 lts



BANDEJA 200 CELULAS F08 FINA PRETO

Código: Fábrica: Unidade:
33543 NUTRIPLAN UN/1
F1 F4

UN: R\$ 61,62 AV: R\$ 61,62 15: R\$ 62,91
30: R\$ 64,16 45: R\$ 65,45 60: R\$ 66,76

80cm
23lts



BANHEIRA INF TRANSP 23 LTS ROSA 7741

Código: Fábrica: Unidade:
6191 JAGUAR UN/1
F1 F4

UN: R\$ 26,70 AV: R\$ 26,70 15: R\$ 27,25
30: R\$ 27,80 45: R\$ 28,35 60: R\$ 28,92



BANQUETA ARAXA BRANCA

Código: Fábrica: Unidade:
21134 ANTARES UN/1
F1 F4

UN: R\$ 24,64 AV: R\$ 24,64 15: R\$ 25,16
30: R\$ 25,66 45: R\$ 26,17 60: R\$ 26,70



BANQUETA ARAXA PRETA

Código: Fábrica: Unidade:
25105 ANTARES UN/1
F1 F4

UN: R\$ 21,05 AV: R\$ 21,05 15: R\$ 21,49
30: R\$ 21,92 45: R\$ 22,35 60: R\$ 22,80



BANQUETA PLAST CARIBE PRETA 944

Código: Fábrica: Unidade:
42760 LUMAR UN/1
F1 F4

UN: R\$ 24,74 AV: R\$ 24,74 15: R\$ 25,25
30: R\$ 25,76 45: R\$ 26,28 60: R\$ 26,80



BANQUETA PLAST PRETA 8000

Código: Fábrica: Unidade:
40410 FORMPLAST UN/1
F1 F4

UN: R\$ 64,70 AV: R\$ 64,70 15: R\$ 66,05
30: R\$ 67,37 45: R\$ 68,72 60: R\$ 70,09

24,5 cm
40 cm
31,5 cm



BAU SINTETICO N3 40X30X24CM 8079

Código: Fábrica: Unidade:
40332 PAIOL UN/1
F1 F4

UN: R\$ 32,97 AV: R\$ 32,97 15: R\$ 33,66
30: R\$ 34,33 45: R\$ 35,02 60: R\$ 35,72



BEBEDOURO AMARELO P/BEIJA FLOR 280ML
Código: 27121 Fábrica: NUTRIPLAN Unidade: UN/1 F1 F4

UN: R\$ 32,97 AV: R\$ 32,97 15: R\$ 33,66
30: R\$ 34,33 45: R\$ 35,02 60: R\$ 35,72



BEBEDOURO LARANJA P/BEIJA FLOR 280ML
Código: 18504 Fábrica: NUTRIPLAN Unidade: UN/1 F1 F4

UN: R\$ 9,99 AV: R\$ 9,99 15: R\$ 9,99
30: R\$ 9,99 45: R\$ 9,99 60: R\$ 9,99



BICO ADAPTADOR AJUST P/TORNEIRA CTL 5364
Código: 43272 Fábrica: MEGAGIFT Unidade: CT/1 F1 F4

UN: R\$ 43,13 AV: R\$ 43,13 15: R\$ 44,03
30: R\$ 44,91 45: R\$ 45,81 60: R\$ 46,73



BICO AREJADOR P/TORNEIRA 1021 12X1
Código: 50826 Fábrica: JWC Unidade: DZ/1 F1 F4

UN: R\$ 6,49 AV: R\$ 6,49 15: R\$ 6,49
30: R\$ 6,49 45: R\$ 6,49 60: R\$ 6,49



BICO AREJADOR P/TORNEIRA 23453
Código: 45881 Fábrica: ALMEGA Unidade: UN/1 F1 F4

UN: R\$ 3,81 AV: R\$ 3,81 15: R\$ 3,89
30: R\$ 3,97 45: R\$ 4,05 60: R\$ 4,13



BICO CONEXAO P/TORNEIRA C/ANEL VEDA 390
Código: 49739 Fábrica: NOVA MARCA Unidade: UN/1 F1 F4

UN: R\$ 24,64 AV: R\$ 24,64 15: R\$ 25,16
30: R\$ 25,66 45: R\$ 26,17 60: R\$ 26,70



BICO METAL MANGUEIRA 10CM CTL 37-20
Código: 44774 Fábrica: NICOBEM Unidade: UN/1 F1 F4

UN: R\$ 4,41 AV: R\$ 4,41 15: R\$ 4,50
30: R\$ 4,59 45: R\$ 4,68 60: R\$ 4,77



BICO PLAST REGADOR PRETO 9754
Código: 50963 Fábrica: ARBRA Unidade: UN/1 F1 F4

UN: R\$ 1,13 AV: R\$ 13,61 15: R\$ 13,89
30: R\$ 14,17 45: R\$ 14,46 60: R\$ 14,74



BICO P/TORNEIRA JARDIM B151N 12X1
Código: 33737 Fábrica: REBOUCAS Unidade: PT/12 F1 F4

UN: R\$ 1,31 AV: R\$ 15,72 15: R\$ 16,04
30: R\$ 16,36 45: R\$ 16,69 60: R\$ 17,03



BICO P/TORNEIRA TANQUE PIA B152N 12X1
Código: 33736 Fábrica: REBOUCAS Unidade: PT/12 F1 F4

UN: R\$ 4,00 AV: R\$ 4,00 15: R\$ 4,08
30: R\$ 4,16 45: R\$ 4,24 60: R\$ 4,33



BISNAGA PLAST 200 ML KATCHUP 394
Código: 36229 Fábrica: TRITEC Unidade: UN/1 F1 F4

UN: R\$ 4,00 AV: R\$ 4,00 15: R\$ 4,08
30: R\$ 4,16 45: R\$ 4,24 60: R\$ 4,33



BISNAGA PLAST 200 ML MAIONESE 396
Código: 35945 Fábrica: TRITEC Unidade: UN/1 F1 F4

UN: R\$ 4,00 AV: R\$ 4,00 15: R\$ 4,08
30: R\$ 4,16 45: R\$ 4,24 60: R\$ 4,33



BISNAGA PLAST 200 ML MOSTARDA 395
Código: 36230 Fábrica: TRITEC Unidade: UN/1 F1 F4

UN: R\$ 3,07 AV: R\$ 3,07 15: R\$ 3,14
30: R\$ 3,20 45: R\$ 3,26 60: R\$ 3,33



BISNAGA PLAST 250 ML KATCHUP 106/422
Código: 44080 Fábrica: QUALYPLAS Unidade: UN/1 F1 F4

UN: R\$ 3,07 AV: R\$ 3,07 15: R\$ 3,14
30: R\$ 3,20 45: R\$ 3,26 60: R\$ 3,33



BISNAGA PLAST 250 ML MAIONESE 421/105
Código: 44079 Fábrica: QUALYPLAS Unidade: UN/1 F1 F4

UN: R\$ 3,07 AV: R\$ 3,07 15: R\$ 3,14
30: R\$ 3,20 45: R\$ 3,26 60: R\$ 3,33



BISNAGA PLAST 250 ML MOSTARDA 104/420
Código: 44081 Fábrica: QUALYPLAS Unidade: UN/1 F1 F4

UN: R\$ 13,34 AV: R\$ 13,34 15: R\$ 13,62
30: R\$ 13,89 45: R\$ 14,17 60: R\$ 14,46



BOLEIRA PLAST 26,5X25X10,5CM FACILIT 450
Código: Fábrica: Unidade:
45189 RISCHIOTO UN/1
F1 F4

UN: R\$ 115,41 AV: R\$ 115,41 15: R\$ 117,81
30: R\$ 120,17 45: R\$ 122,57 60: R\$ 125,02



BOLSA TERMICA POLIESTER 24X22X14CM 0066
Código: Fábrica: Unidade:
43685 MORMAII UN/1
F1 F4

UN: R\$ 115,41 AV: R\$ 115,41 15: R\$ 117,81
30: R\$ 120,17 45: R\$ 122,57 60: R\$ 125,02



BOLSA TERMICA POLIESTER 24X22X14CM 0069
Código: Fábrica: Unidade:
43680 MORMAII UN/1
F1 F4

UN: R\$ 71,89 AV: R\$ 71,89 15: R\$ 73,39
30: R\$ 74,86 45: R\$ 76,36 60: R\$ 77,88



BOLSA TERMICA RET 9 LTS
Código: Fábrica: Unidade:
30864 ANTARES UN/1
F1 F4

UN: R\$ 88,33 AV: R\$ 88,33 15: R\$ 90,17
30: R\$ 91,97 45: R\$ 93,81 60: R\$ 95,69



BOLSA TERMICA RET 12 LTS TIRA COLO
Código: Fábrica: Unidade:
30868 ANTARES UN/1
F1 F4

UN: R\$ 102,71 AV: R\$ 102,71 15: R\$ 104,85
30: R\$ 106,95 45: R\$ 109,09 60: R\$ 111,27



BOLSA TERMICA RET 15 LTS
Código: Fábrica: Unidade:
30865 ANTARES UN/1
F1 F4

UN: R\$ 19,29 AV: R\$ 19,29 15: R\$ 19,69
30: R\$ 20,09 45: R\$ 20,49 60: R\$ 20,90



BOMBA MANUAL P/GALAO DE AGUA 16,5CM 861
Código: Fábrica: Unidade:
26874 HAI BRASIL UN/1
F1 F4

UN: R\$ 9,23 AV: R\$ 9,23 15: R\$ 9,43
30: R\$ 9,62 45: R\$ 9,81 60: R\$ 10,00



BOMBONIERE PLAST 10X11CM 15082
Código: Fábrica: Unidade:
46247 CASITA CX/1
F1 F4

UN: R\$ 17,45 AV: R\$ 17,45 15: R\$ 17,82
30: R\$ 18,17 45: R\$ 18,54 60: R\$ 18,91



BOMBONIERE VIDRO GDE 750
Código: Fábrica: Unidade:
47361 ALTHOME UN/1
F1 F4

UN: R\$ 23,62 AV: R\$ 23,62 15: R\$ 24,11
30: R\$ 24,59 45: R\$ 25,08 60: R\$ 25,58



BOMBONIERE VIDRO 290ML RED 13CM EGITO
Código: Fábrica: Unidade:
44781 CITY GLASS CX/1
F1 F4

UN: R\$ 1,04 AV: R\$ 2,09 15: R\$ 2,13
30: R\$ 2,17 45: R\$ 2,21 60: R\$ 2,26



BORDA P/PRATELEIRA 1M X 6CM 2 2X1 1102
Código: Fábrica: Unidade:
11328 PLAST-LEO C//2
F1 F4

UN: R\$ 3,42 AV: R\$ 41,08 15: R\$ 41,93
30: R\$ 42,77 45: R\$ 43,63 60: R\$ 44,50

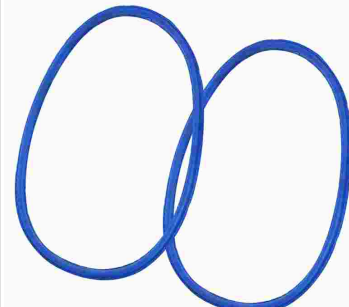

BORRACHA P PRESSAO SILIC 4,5 LTS 12X1
Código: Fábrica: Unidade:
28808 ALPHA DZ/12
F1 F4

UN: R\$ 3,85 AV: R\$ 46,21 15: R\$ 47,18
30: R\$ 48,12 45: R\$ 49,08 60: R\$ 50,06

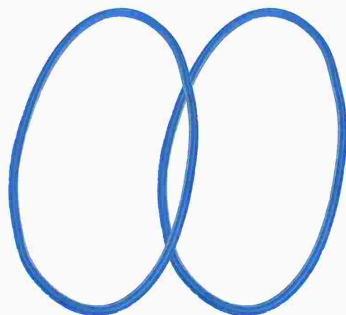

BORRACHA P PRESSAO SILIC 7,0 LTS 12X1
Código: Fábrica: Unidade:
29925 ALPHA DZ/12
F1 F4

UN: R\$ 2,13 AV: R\$ 25,52 15: R\$ 26,05
30: R\$ 26,57 45: R\$ 27,10 60: R\$ 27,64

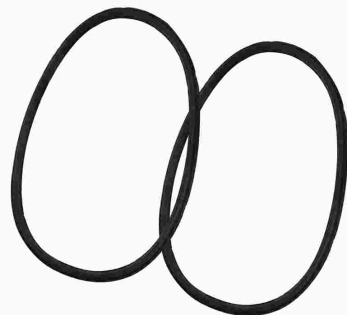

BORRACHA P PRESSAO 4,5 LTS PRETA 12X1
Código: Fábrica: Unidade:
37725 ALPHA DZ/12
F1 F4

UN: R\$ 2,57 AV: R\$ 30,82 15: R\$ 31,46
30: R\$ 32,09 45: R\$ 32,73 60: R\$ 33,38

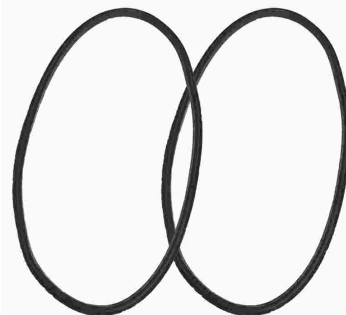

BORRACHA P PRESSAO 7,0 LTS PRETA 12X1
Código: Fábrica: Unidade:
37783 ALPHA DZ/12
F1 F4

UN: R\$ 21,97 AV: R\$ 21,97 15: R\$ 22,43
30: R\$ 22,88 45: R\$ 23,33 60: R\$ 23,80

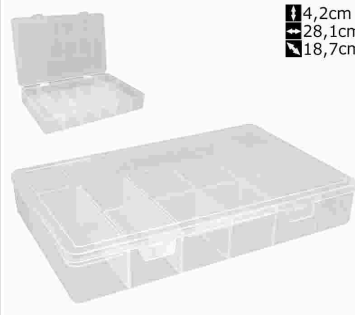

BOX ORGANIZADOR PLAST G C/13 DIV 490
Código: Fábrica: Unidade:
44432 USUAL UN/1
F1 F4

↑ 4,2cm
→ 28,1cm
□ 18,7cm

UN: R\$ 7,41 AV: R\$ 7,41 15: R\$ 7,56
30: R\$ 7,72 45: R\$ 7,87 60: R\$ 8,03

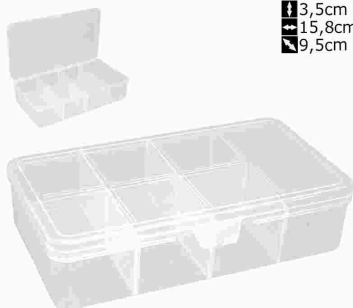

BOX ORGANIZADOR PLAST P C/7 DIV 488

Código: 44431 Fábrica: USUAL Unidade: UN/1
F1 F4

13,5cm
15,8cm
9,5cm

UN: R\$ 32,17 AV: R\$ 32,17 15: R\$ 32,84
30: R\$ 33,50 45: R\$ 34,17 60: R\$ 34,85



BOX PRATIC RATTAN TENDENCIAS GDE 2010

Código: 38375 Fábrica: MONTE LIBANO Unidade: UN/1
F1 F4

14,5 cm
37 cm

UN: R\$ 20,46 AV: R\$ 20,46 15: R\$ 20,89
30: R\$ 21,31 45: R\$ 21,73 60: R\$ 22,17



BOX PRATIC RATTAN TENDENCIAS MED 2005

Código: 38374 Fábrica: MONTE LIBANO Unidade: UN/1
F1 F4

13 cm
29,5 cm

UN: R\$ 15,05 AV: R\$ 15,05 15: R\$ 15,36
30: R\$ 15,67 45: R\$ 15,98 60: R\$ 16,30



BOX PRATIC RATTAN TENDENCIAS PEQ 2000

Código: 38373 Fábrica: MONTE LIBANO Unidade: UN/1
F1 F4

12 cm
24 cm

UN: R\$ 61,62 AV: R\$ 61,62 15: R\$ 62,91
30: R\$ 64,16 45: R\$ 65,45 60: R\$ 66,76



BULE ALUM CB BAQUELITE 02 654

Código: 35270 Fábrica: MSR Unidade: UN/1
F1 F4

UN: R\$ 66,76 AV: R\$ 66,76 15: R\$ 68,15
30: R\$ 69,51 45: R\$ 70,90 60: R\$ 72,32



BULE ALUM CRAQUEADO CB BAQUELITE 655

Código: 35262 Fábrica: MSR Unidade: UN/1
F1 F4

UN: R\$ 2,73 AV: R\$ 8,20 15: R\$ 8,37
30: R\$ 8,54 45: R\$ 8,71 60: R\$ 8,88

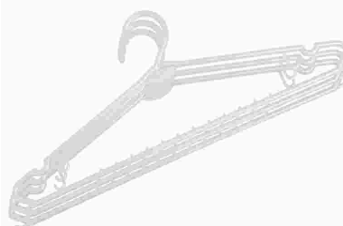

CABIDE ACRIL AD BRANCO 003 3X1

Código: 45751 Fábrica: DCASA Unidade: CJ/3
F1 F4

UN: R\$ 2,05 AV: R\$ 6,15 15: R\$ 6,28
30: R\$ 6,41 45: R\$ 6,53 60: R\$ 6,67

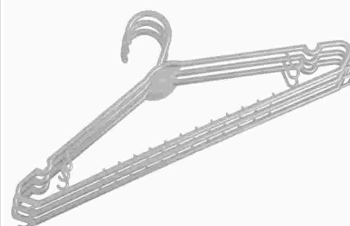

CABIDE ACRIL AD CINZA 002 3X1

Código: 45762 Fábrica: DCASA Unidade: CJ/3
F1 F4

UN: R\$ 2,73 AV: R\$ 8,20 15: R\$ 8,37
30: R\$ 8,54 45: R\$ 8,71 60: R\$ 8,88



CABIDE ACRIL AD COBRE 008 3X1

Código: 45753 Fábrica: DCASA Unidade: CJ/3
F1 F4

UN: R\$ 2,73 AV: R\$ 8,20 15: R\$ 8,37
30: R\$ 8,54 45: R\$ 8,71 60: R\$ 8,88

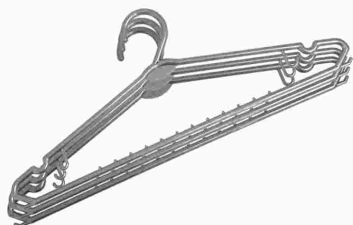

CABIDE ACRIL AD PLATINA 009 3X1

Código: 45752 Fábrica: DCASA Unidade: CJ/3
F1 F4

UN: R\$ 3,08 AV: R\$ 9,23 15: R\$ 9,43
30: R\$ 9,62 45: R\$ 9,81 60: R\$ 10,00



CABIDE ACRIL AD VINTAGE BRANCO 102 3X1

Código: 45754 Fábrica: DCASA Unidade: CJ/3
F1 F4

UN: R\$ 2,91 AV: R\$ 8,72 15: R\$ 8,90
30: R\$ 9,08 45: R\$ 9,26 60: R\$ 9,45



CABIDE ACRIL AD VINTAGE CINZA 110 3X1

Código: 45759 Fábrica: DCASA Unidade: CJ/3
F1 F4

UN: R\$ 3,08 AV: R\$ 9,23 15: R\$ 9,43
30: R\$ 9,62 45: R\$ 9,81 60: R\$ 10,00

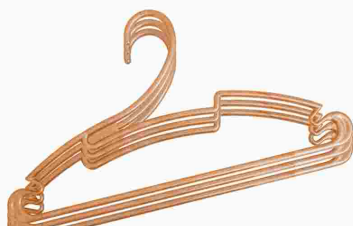

CABIDE ACRIL AD VINTAGE COBRE 103 3X1

Código: 45756 Fábrica: DCASA Unidade: CJ/3
F1 F4

UN: R\$ 3,08 AV: R\$ 9,23 15: R\$ 9,43
30: R\$ 9,62 45: R\$ 9,81 60: R\$ 10,00

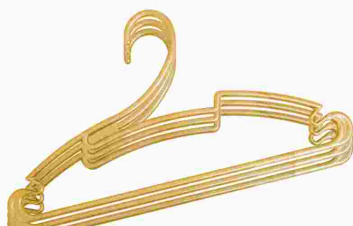

CABIDE ACRIL AD VINTAGE OURO 105 3X1

Código: 45758 Fábrica: DCASA Unidade: CJ/3
F1 F4

UN: R\$ 3,08 AV: R\$ 9,23 15: R\$ 9,43
30: R\$ 9,62 45: R\$ 9,81 60: R\$ 10,00

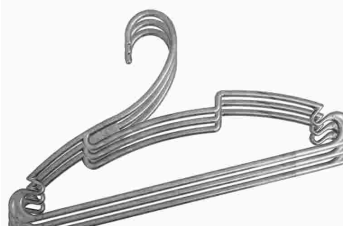

CABIDE ACRIL AD VINTAGE PLATINA 104 3X1

Código: 45757 Fábrica: DCASA Unidade: CJ/3
F1 F4

UN: R\$ 3,08 AV: R\$ 9,23 15: R\$ 9,43
30: R\$ 9,62 45: R\$ 9,81 60: R\$ 10,00

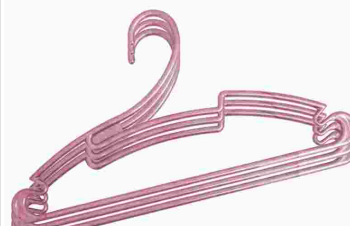

CABIDE ACRIL AD VINTAGE ROSE GOLD112 3X1

Código: 45760 Fábrica: DCASA Unidade: CJ/3
F1 F4

UN: R\$ 2,05 AV: R\$ 6,15 15: R\$ 6,28
30: R\$ 6,41 45: R\$ 6,53 60: R\$ 6,67

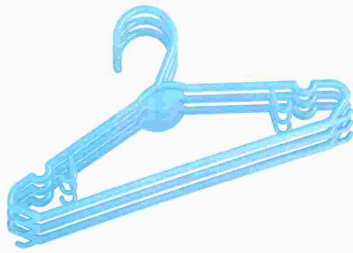

CABIDE ACRIL INF AZUL 200 3X1

Código: Fábrika: Unidade:
45749 DCASA CJ/3
F1 F4

UN: R\$ 2,05 AV: R\$ 6,15 15: R\$ 6,28
30: R\$ 6,41 45: R\$ 6,53 60: R\$ 6,67



CABIDE ACRIL INF BRANCO 400 3X1

Código: Fábrika: Unidade:
45748 DCASA CJ/3
F1 F4

UN: R\$ 2,05 AV: R\$ 6,15 15: R\$ 6,28
30: R\$ 6,41 45: R\$ 6,53 60: R\$ 6,67



CABIDE ACRIL INF ROSA 100 3X1

Código: Fábrika: Unidade:
45750 DCASA CJ/3
F1 F4

UN: R\$ 4,10 AV: R\$ 49,18 15: R\$ 50,21
30: R\$ 51,21 45: R\$ 52,24 60: R\$ 53,28



CABIDE CROM POPULAR 792 12X1

Código: Fábrika: Unidade:
7502 ARAMINAS DZ/12
F1 F4

UN: R\$ 16,02 AV: R\$ 16,02 15: R\$ 16,36
30: R\$ 16,69 45: R\$ 17,02 60: R\$ 17,36



CABIDE GALINHA C/1 GANCHO 5055

Código: Fábrika: Unidade:
39230 PAIOL UN/1
F1 F4

UN: R\$ 1,21 AV: R\$ 3,62 15: R\$ 3,69
30: R\$ 3,76 45: R\$ 3,84 60: R\$ 3,92



CABIDE PLAST AD PRETO 400 3X1

Código: Fábrika: Unidade:
40952 P A SOUZA CJ/3
F1 F4

UN: R\$ 1,21 AV: R\$ 7,24 15: R\$ 7,39
30: R\$ 7,54 45: R\$ 7,69 60: R\$ 7,85



CABIDE PLAST AD PRETO 401 6X1

Código: Fábrika: Unidade:
40953 P A SOUZA CJ/6
F1 F4

UN: R\$ 1,20 AV: R\$ 14,37 15: R\$ 14,67
30: R\$ 14,96 45: R\$ 15,26 60: R\$ 15,57

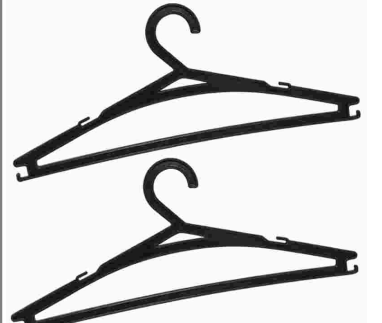

CABIDE PLAST AD PRETO 402 12X1

Código: Fábrika: Unidade:
40954 P A SOUZA CJ/12
F1 F4

UN: R\$ 3,01 AV: R\$ 6,03 15: R\$ 6,16
30: R\$ 6,28 45: R\$ 6,40 60: R\$ 6,53

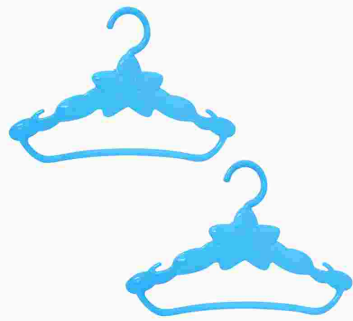

CABIDE PLAST BABY ESTRELA AZUL 3807 2X1

Código: Fábrika: Unidade:
35489 TRITEC CJ/2
F1 F4

UN: R\$ 2,91 AV: R\$ 5,81 15: R\$ 5,94
30: R\$ 6,05 45: R\$ 6,17 60: R\$ 6,30



CABIDE PLAST BABY ESTRELA ROSA 3808 2X1

Código: Fábrika: Unidade:
35488 TRITEC CJ/2
F1 F4

UN: R\$ 1,57 AV: R\$ 4,70 15: R\$ 4,80
30: R\$ 4,89 45: R\$ 4,99 60: R\$ 5,09



CABIDE PLAST PRETO 001 3X1

Código: Fábrika: Unidade:
41490 KOZI PLAST C//3
F1 F4

UN: R\$ 5,13 AV: R\$ 5,13 15: R\$ 5,23
30: R\$ 5,34 45: R\$ 5,44 60: R\$ 5,55



CABO MADEIRA PLAST 1,20 MTS C/ ROSCA

Código: Fábrika: Unidade:
49869 HALLEY UN/1
F1 F4

UN: R\$ 4,62 AV: R\$ 4,62 15: R\$ 4,72
30: R\$ 4,81 45: R\$ 4,91 60: R\$ 5,01



CABO MADEIRA 1,20 MTS C/ ROSCA

Código: Fábrika: Unidade:
49896 HALLEY UN/1
F1 F4

UN: R\$ 133,53 AV: R\$ 133,53 15: R\$ 136,31
30: R\$ 139,03 45: R\$ 141,81 60: R\$ 144,65



CACAROLA ALUM HOTEL 30 10LTS

Código: Fábrika: Unidade:
50778 ASJ UN/1
F1 F4

UN: R\$ 169,48 AV: R\$ 169,48 15: R\$ 173,01
30: R\$ 176,47 45: R\$ 180,00 60: R\$ 183,60



CACAROLA ALUM HOTEL 32 12LTS

Código: Fábrika: Unidade:
50777 ASJ UN/1
F1 F4

UN: R\$ 179,76 AV: R\$ 179,76 15: R\$ 183,51
30: R\$ 187,18 45: R\$ 190,92 60: R\$ 194,74



CACAROLA ALUM HOTEL 36 17LTS

Código: Fábrika: Unidade:
50716 ASJ UN/1
F1 F4

UN: R\$ 25,67 AV: R\$ 25,67 15: R\$ 26,20
30: R\$ 26,73 45: R\$ 27,26 60: R\$ 27,81



CACAROLA ALUM LEVE 14 C/TAMPA 1,0 LT
Código: 14755 Fábrica: AVELAR Unidade: UN/1 F1 F4

UN: R\$ 25,67 AV: R\$ 25,67 15: R\$ 26,20
30: R\$ 26,73 45: R\$ 27,26 60: R\$ 27,81



CACAROLA ALUM LEVE 16 C/TAMPA 1,3 LTS
Código: 14756 Fábrica: AVELAR Unidade: UN/1 F1 F4

UN: R\$ 9,51 AV: R\$ 9,51 15: R\$ 9,71
30: R\$ 9,90 45: R\$ 10,10 60: R\$ 10,30



CACHEPOT ALUM CANELADO SEM ALCA PEQ 206
Código: 39548 Fábrica: BMC ALUMINIO Unidade: UN/1 F1 F4

UN: R\$ 51,35 AV: R\$ 51,35 15: R\$ 52,42
30: R\$ 53,47 45: R\$ 54,54 60: R\$ 55,63



CACHEPOT ATHENAS JARDINEIRA 26 ENVELHECI
Código: 32759 Fábrica: NUTRIPLAN Unidade: UN/1 F1 F4

UN: R\$ 39,55 AV: R\$ 39,55 15: R\$ 40,37
30: R\$ 41,18 45: R\$ 42,00 60: R\$ 42,84



CACHEPOT ELEGANCE CONICO CYBIDIUM BRANCO
Código: 39645 Fábrica: NUTRIPLAN Unidade: UN/1 F1 F4

UN: R\$ 51,32 AV: R\$ 51,32 15: R\$ 52,39
30: R\$ 53,44 45: R\$ 54,50 60: R\$ 55,59



CACHEPOT ELEGANCE CONICO CYBIDIUM CAFE 1
Código: 38910 Fábrica: NUTRIPLAN Unidade: UN/1 F1 F4

UN: R\$ 51,32 AV: R\$ 51,32 15: R\$ 52,39
30: R\$ 53,44 45: R\$ 54,50 60: R\$ 55,59



CACHEPOT ELEGANCE CONICO CYBIDIUM TRAVER
Código: 39646 Fábrica: NUTRIPLAN Unidade: UN/1 F1 F4

UN: R\$ 41,08 AV: R\$ 41,08 15: R\$ 41,93
30: R\$ 42,77 45: R\$ 43,63 60: R\$ 44,50



CACHEPOT ELEGANCE JARDINEIRA 01 BRANC 3L
Código: 32763 Fábrica: NUTRIPLAN Unidade: UN/1 F1 F4

UN: R\$ 48,28 AV: R\$ 48,28 15: R\$ 49,28
30: R\$ 50,27 45: R\$ 51,28 60: R\$ 52,30



CACHEPOT ELEGANCE JARDINEIRA 01 CAFE 3L
Código: 32760 Fábrica: NUTRIPLAN Unidade: UN/1 F1 F4

UN: R\$ 48,18 AV: R\$ 48,18 15: R\$ 49,18
30: R\$ 50,16 45: R\$ 51,17 60: R\$ 52,19



CACHEPOT ELEGANCE JARDINEIRA 01 PRETO 3L
Código: 32764 Fábrica: NUTRIPLAN Unidade: UN/1 F1 F4

UN: R\$ 48,28 AV: R\$ 48,28 15: R\$ 49,28
30: R\$ 50,27 45: R\$ 51,28 60: R\$ 52,30



CACHEPOT ELEGANCE JARDINEIRA 01 TRAVE 3L
Código: 32762 Fábrica: NUTRIPLAN Unidade: UN/1 F1 F4

UN: R\$ 7,70 AV: R\$ 7,70 15: R\$ 7,86
30: R\$ 8,02 45: R\$ 8,18 60: R\$ 8,35



CACHEPOT ELEGANCE PAREDE MINI PRETO 1,5L
Código: 33083 Fábrica: NUTRIPLAN Unidade: UN/1 F1 F4

UN: R\$ 19,51 AV: R\$ 19,51 15: R\$ 19,91
30: R\$ 20,31 45: R\$ 20,72 60: R\$ 21,13

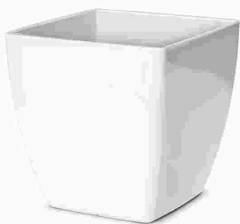

CACHEPOT ELEGANCE QUAD 01 BRANCO 950ML
Código: 48426 Fábrica: NUTRIPLAN Unidade: UN/1 F1 F4

UN: R\$ 25,57 AV: R\$ 25,57 15: R\$ 26,10
30: R\$ 26,62 45: R\$ 27,15 60: R\$ 27,70



CACHEPOT ELEGANCE QUAD 01 CAFE IMP 950ML
Código: 48427 Fábrica: NUTRIPLAN Unidade: UN/1 F1 F4

UN: R\$ 20,03 AV: R\$ 20,03 15: R\$ 20,45
30: R\$ 20,86 45: R\$ 21,27 60: R\$ 21,70



CACHEPOT ELEGANCE QUAD 01 TRAVERTI 950ML
Código: 32768 Fábrica: NUTRIPLAN Unidade: UN/1 F1 F4

UN: R\$ 11,99 AV: R\$ 11,99 15: R\$ 12,24
30: R\$ 12,48 45: R\$ 12,73 60: R\$ 12,99



CACHEPOT ELEGANCE QUAD 02 VERDE LIM 1,7L
Código: 33087 Fábrica: NUTRIPLAN Unidade: UN/1 F1 F4

UN: R\$ 38,52 AV: R\$ 38,52 15: R\$ 39,32
 30: R\$ 40,11 45: R\$ 40,91 60: R\$ 41,73
 13 cm
 13 cm
 2,4 lts



CACHEPOT ELEGANCE QUAD 03 AZUL BB 2,4LTS

Código: Fábrica: Unidade:
36791 NUTRIPLAN UN/1
 F1 F4

UN: R\$ 38,52 AV: R\$ 38,52 15: R\$ 39,32
 30: R\$ 40,11 45: R\$ 40,91 60: R\$ 41,73
 14,9 cm
 15,2 cm
 2,4 lts

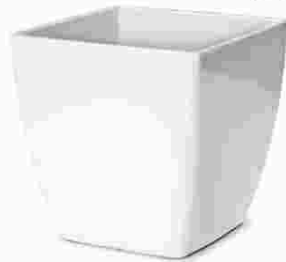

CACHEPOT ELEGANCE QUAD 03 BRANCO 2,4LTS

Código: Fábrica: Unidade:
32766 NUTRIPLAN UN/1
 F1 F4

UN: R\$ 38,52 AV: R\$ 38,52 15: R\$ 39,32
 30: R\$ 40,11 45: R\$ 40,91 60: R\$ 41,73
 14,9 cm
 15,2 cm
 2,4 lts



CACHEPOT ELEGANCE QUAD 03 CAFE IMPE 2,4L

Código: Fábrica: Unidade:
32765 NUTRIPLAN UN/1
 F1 F4

UN: R\$ 38,52 AV: R\$ 38,52 15: R\$ 39,32
 30: R\$ 40,11 45: R\$ 40,91 60: R\$ 41,73
 13 cm
 13 cm
 2,4 lts



CACHEPOT ELEGANCE QUAD 03 ROSE 2,4LTS

Código: Fábrica: Unidade:
36792 NUTRIPLAN UN/1
 F1 F4

UN: R\$ 38,52 AV: R\$ 38,52 15: R\$ 39,32
 30: R\$ 40,11 45: R\$ 40,91 60: R\$ 41,73
 14 cm
 15 cm
 1,7 lts



CACHEPOT ELEGANCE QUAD 03 TRAVERTIN 2,4L

Código: Fábrica: Unidade:
33908 NUTRIPLAN UN/1
 F1 F4

UN: R\$ 45,40 AV: R\$ 45,40 15: R\$ 46,35
 30: R\$ 47,28 45: R\$ 48,22 60: R\$ 49,19
 16 cm
 16 cm
 3 lts

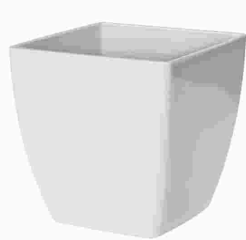

CACHEPOT ELEGANCE QUAD 04 BRANCO 3LTS

Código: Fábrica: Unidade:
38673 NUTRIPLAN UN/1
 F1 F4

UN: R\$ 50,85 AV: R\$ 50,85 15: R\$ 51,91
 30: R\$ 52,94 45: R\$ 54,00 60: R\$ 55,08
 16,6 cm
 16,1 cm
 3,0 lts



CACHEPOT ELEGANCE QUAD 04 CAFE IMPE 3LTS

Código: Fábrica: Unidade:
33550 NUTRIPLAN UN/1
 F1 F4

UN: R\$ 4,82 AV: R\$ 57,83 15: R\$ 59,04
 30: R\$ 60,22 45: R\$ 61,42 60: R\$ 62,65
 5,5 cm



CACHEPOT ELEGANCE RED MINI AZUL BB 12X1

Código: Fábrica: Unidade:
35719 NUTRIPLAN PT/12
 F1 F4

UN: R\$ 5,14 AV: R\$ 61,62 15: R\$ 62,91
 30: R\$ 64,16 45: R\$ 65,45 60: R\$ 66,76
 5,5 cm



CACHEPOT ELEGANCE RED MINI PRETO ON 12X1

Código: Fábrica: Unidade:
35722 NUTRIPLAN PT/12
 F1 F4

UN: R\$ 5,14 AV: R\$ 61,63 15: R\$ 62,92
 30: R\$ 64,17 45: R\$ 65,46 60: R\$ 66,77
 5,5 cm



CACHEPOT ELEGANCE RED MINI ROSE 12X1

Código: Fábrica: Unidade:
35723 NUTRIPLAN PT/12
 F1 F4

UN: R\$ 5,14 AV: R\$ 61,63 15: R\$ 62,92
 30: R\$ 64,17 45: R\$ 65,46 60: R\$ 66,77
 5,5 cm



CACHEPOT ELEGANCE RED MINI VINHO 12X1

Código: Fábrica: Unidade:
35725 NUTRIPLAN PT/12
 F1 F4

UN: R\$ 12,33 AV: R\$ 147,92 15: R\$ 151,00
 30: R\$ 154,02 45: R\$ 157,10 60: R\$ 160,24
 5 cm
 6,5 cm
 350 ml



CACHEPOT ELEGANCE RED 00 BRAN 350ML 12X1

Código: Fábrica: Unidade:
38907 NUTRIPLAN PT/12
 F1 F4

UN: R\$ 147,15 AV: R\$ 147,15 15: R\$ 150,21
 30: R\$ 153,22 45: R\$ 156,28 60: R\$ 159,41
 5 cm
 6,5 cm
 350 ml



CACHEPOT ELEGANCE RED 00 CAFE 350ML 12X1

Código: Fábrica: Unidade:
38908 NUTRIPLAN UN/1
 F1 F4

UN: R\$ 9,85 AV: R\$ 118,23 15: R\$ 120,69
 30: R\$ 123,11 45: R\$ 125,57 60: R\$ 128,08
 5 cm
 6,5 cm
 350 ml



CACHEPOT ELEGANCE RED 00 DOUR 350ML 12X1

Código: Fábrica: Unidade:
38906 NUTRIPLAN PT/12
 F1 F4

UN: R\$ 12,26 AV: R\$ 147,15 15: R\$ 150,21
 30: R\$ 153,22 45: R\$ 156,28 60: R\$ 159,41
 5 cm
 6,5 cm
 350 ml



CACHEPOT ELEGANCE RED 00 PRET 350ML 12X1

Código: Fábrica: Unidade:
38909 NUTRIPLAN PT/12
 F1 F4

UN: R\$ 12,26 AV: R\$ 147,15 15: R\$ 150,21
 30: R\$ 153,22 45: R\$ 156,28 60: R\$ 159,41
 5 cm
 6,5 cm
 350 ml



CACHEPOT ELEGANCE RED 00 TRAV 350ML 12X1

Código: Fábrica: Unidade:
38905 NUTRIPLAN PT/12
 F1 F4

UN: R\$ 8,56 AV: R\$ 102,71 15: R\$ 104,85
 30: R\$ 106,95 45: R\$ 109,09 60: R\$ 111,27
 11 5 cm
 11 6,5 cm
 11 350 ml



CACHEPOT ELEGANCE RED 00 VINH 350ML 12X1

Código: Fábrica: Unidade:
38911 NUTRIPLAN PT/12
 F1 F4

UN: R\$ 12,33 AV: R\$ 12,33 15: R\$ 12,58
 30: R\$ 12,83 45: R\$ 13,09 60: R\$ 13,35
 11 8,7 cm
 11 11,4 cm
 11 0,6 lts



CACHEPOT ELEGANCE RED 01 AMARELO 600ML

Código: Fábrica: Unidade:
32732 NUTRIPLAN UN/1
 F1 F4

UN: R\$ 4,62 AV: R\$ 4,62 15: R\$ 4,72
 30: R\$ 4,81 45: R\$ 4,91 60: R\$ 5,01
 11 8 cm
 11 11 cm
 11 0,6 lts



CACHEPOT ELEGANCE RED 01 PRETO 600ML

Código: Fábrica: Unidade:
33082 NUTRIPLAN UN/1
 F1 F4

UN: R\$ 15,41 AV: R\$ 15,41 15: R\$ 15,73
 30: R\$ 16,04 45: R\$ 16,36 60: R\$ 16,69
 11 10,9 cm
 11 13,6 cm
 11 1,0 lts



CACHEPOT ELEGANCE RED 03 BRANCO 1,5LT

Código: Fábrica: Unidade:
37750 NUTRIPLAN UN/1
 F1 F4

UN: R\$ 20,03 AV: R\$ 20,03 15: R\$ 20,45
 30: R\$ 20,86 45: R\$ 21,27 60: R\$ 21,70
 11 12 cm
 11 15 cm
 11 1,5 lts



CACHEPOT ELEGANCE RED 03 CAFE IMPER 1,5L

Código: Fábrica: Unidade:
33080 NUTRIPLAN UN/1
 F1 F4

UN: R\$ 20,03 AV: R\$ 20,03 15: R\$ 20,45
 30: R\$ 20,86 45: R\$ 21,27 60: R\$ 21,70
 11 12 cm
 11 15,4 cm
 11 1,5 lts



CACHEPOT ELEGANCE RED 03 TRAVERTIN 1,5LT

Código: Fábrica: Unidade:
32726 NUTRIPLAN UN/1
 F1 F4

UN: R\$ 82,17 AV: R\$ 82,17 15: R\$ 83,88
 30: R\$ 85,56 45: R\$ 87,27 60: R\$ 89,01
 11 23,2 cm
 11 25,4 cm
 11 8,5 lts



CACHEPOT ELEGANCE RED 04 CAFE IMPER 8,5L

Código: Fábrica: Unidade:
32728 NUTRIPLAN UN/1
 F1 F4

UN: R\$ 41,95 AV: R\$ 41,95 15: R\$ 42,82
 30: R\$ 43,68 45: R\$ 44,55 60: R\$ 45,45
 11 26,7 cm
 11 27,6 cm
 11 12 lts



CACHEPOT ELEGANCE RED 05 VERDE LIM 12LTS

Código: Fábrica: Unidade:
32729 NUTRIPLAN UN/1
 F1 F4

UN: R\$ 32,35 AV: R\$ 32,35 15: R\$ 33,02
 30: R\$ 33,68 45: R\$ 34,35 60: R\$ 35,04
 11 15,3 cm
 11 15,4 cm
 11 2,0 lts



CACHEPOT ELEGANCE RED 3,5 PRETO ONIX 2LT

Código: Fábrica: Unidade:
32727 NUTRIPLAN UN/1
 F1 F4

UN: R\$ 30,41 AV: R\$ 30,41 15: R\$ 31,04
 30: R\$ 31,66 45: R\$ 32,29 60: R\$ 32,94
 11 26 cm
 11 4 cm
 11 4 lts



CACHEPOT ELEGANCE TRAPEZO 01 AZUL BB 4LT

Código: Fábrica: Unidade:
36793 NUTRIPLAN UN/1
 F1 F4

UN: R\$ 30,41 AV: R\$ 30,41 15: R\$ 31,04
 30: R\$ 31,66 45: R\$ 32,29 60: R\$ 32,94
 11 26 cm
 11 4 cm
 11 4 lts



CACHEPOT ELEGANCE TRAPEZO 01 ROSE 4LT

Código: Fábrica: Unidade:
36794 NUTRIPLAN UN/1
 F1 F4

UN: R\$ 37,35 AV: R\$ 37,35 15: R\$ 38,13
 30: R\$ 38,89 45: R\$ 39,67 60: R\$ 40,46
 11 26 cm
 11 14 cm
 11 4 lts



CACHEPOT ELEGANCE TRAPEZIO 01 BRANCO 4LT

Código: Fábrica: Unidade:
35718 NUTRIPLAN UN/1
 F1 F4

UN: R\$ 48,54 AV: R\$ 48,54 15: R\$ 49,55
 30: R\$ 50,54 45: R\$ 51,55 60: R\$ 52,58
 11 26 cm
 11 14 cm
 11 4 lts

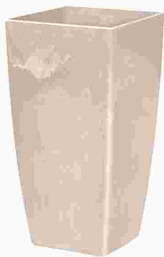

CACHEPOT ELEGANCE TRAPEZIO 01 TRAVER 4LT

Código: Fábrica: Unidade:
35460 NUTRIPLAN UN/1
 F1 F4

UN: R\$ 35,03 AV: R\$ 35,03 15: R\$ 35,76
 30: R\$ 36,47 45: R\$ 37,20 60: R\$ 37,95
 11 26 cm
 11 14 cm
 11 4 lts



CACHEPOT ELEGANCE TRAPEZIO 01 VINHO 4LTS

Código: Fábrica: Unidade:
35717 NUTRIPLAN UN/1
 F1 F4

UN: R\$ 3,79 AV: R\$ 3,79 15: R\$ 3,87
 30: R\$ 3,95 45: R\$ 4,03 60: R\$ 4,11
 11 23 cm
 11 32 cm
 11 2,4 L



CACHEPOT PLAST PAREDE PRETO 2,4LTS

Código: Fábrica: Unidade:
41655 INPLAST UN/1
 F1 F4

UN: R\$ 4,61 AV: R\$ 4,61 15: R\$ 4,71
 30: R\$ 4,80 45: R\$ 4,90 60: R\$ 5,00
 11 23 cm
 11 32 cm
 11 2,4 L



CACHEPOT PLAST PAREDE TERRACOTA 2,4LTS

Código: Fábrica: Unidade:
41656 INPLAST UN/1
 F1 F4

UN: R\$ 4,44 AV: R\$ 4,44 15: R\$ 4,53
30: R\$ 4,62 45: R\$ 4,71 60: R\$ 4,81



11 cm
14 cm

CACHEPOT PLAST 11X14CM 1100

Código: Fábrika: Unidade:
37805 ENGIPLAST UN/1
F1 F4

UN: R\$ 1,80 AV: R\$ 7,18 15: R\$ 7,33
30: R\$ 7,48 45: R\$ 7,63 60: R\$ 7,78



CACHEPOT PLAST 220ML 6404 4X1

Código: Fábrika: Unidade:
41492 KOZI PLAST CJ/4
F1 F4

UN: R\$ 3,76 AV: R\$ 3,76 15: R\$ 3,84
30: R\$ 3,91 45: R\$ 3,99 60: R\$ 4,07



CACHEPOT QUADRADO CONICO 7CM 210

Código: Fábrika: Unidade:
30832 P A SOUZA UN/1
F1 F4

UN: R\$ 4,69 AV: R\$ 4,69 15: R\$ 4,79
30: R\$ 4,89 45: R\$ 4,99 60: R\$ 5,09



CACHEPOT QUADRADO CONICO 9CM 211

Código: Fábrika: Unidade:
30831 P A SOUZA UN/1
F1 F4

UN: R\$ 6,32 AV: R\$ 6,32 15: R\$ 6,45
30: R\$ 6,58 45: R\$ 6,71 60: R\$ 6,84



CACHEPOT QUADRADO CONICO 11CM 212

Código: Fábrika: Unidade:
29220 P A SOUZA UN/1
F1 F4

UN: R\$ 8,01 AV: R\$ 8,01 15: R\$ 8,18
30: R\$ 8,34 45: R\$ 8,51 60: R\$ 8,68



CACHEPOT QUADRADO CONICO 13CM 213

Código: Fábrika: Unidade:
29221 P A SOUZA UN/1
F1 F4

UN: R\$ 9,55 AV: R\$ 9,55 15: R\$ 9,75
30: R\$ 9,95 45: R\$ 10,15 60: R\$ 10,35



CACHEPOT QUADRADO CONICO 15CM 214

Código: Fábrika: Unidade:
29222 P A SOUZA UN/1
F1 F4

UN: R\$ 3,76 AV: R\$ 3,76 15: R\$ 3,84
30: R\$ 3,91 45: R\$ 3,99 60: R\$ 4,07



CACHEPOT QUADRADO RETO 7CM 215

Código: Fábrika: Unidade:
30825 P A SOUZA UN/1
F1 F4

UN: R\$ 4,69 AV: R\$ 4,69 15: R\$ 4,79
30: R\$ 4,89 45: R\$ 4,99 60: R\$ 5,09



CACHEPOT QUADRADO RETO 9CM 216

Código: Fábrika: Unidade:
30824 P A SOUZA UN/1
F1 F4

UN: R\$ 6,32 AV: R\$ 6,32 15: R\$ 6,45
30: R\$ 6,58 45: R\$ 6,71 60: R\$ 6,84



CACHEPOT QUADRADO RETO 11CM 217

Código: Fábrika: Unidade:
30823 P A SOUZA UN/1
F1 F4

UN: R\$ 8,01 AV: R\$ 8,01 15: R\$ 8,18
30: R\$ 8,34 45: R\$ 8,51 60: R\$ 8,68



CACHEPOT QUADRADO RETO 13CM 218

Código: Fábrika: Unidade:
30822 P A SOUZA UN/1
F1 F4

UN: R\$ 9,55 AV: R\$ 9,55 15: R\$ 9,75
30: R\$ 9,95 45: R\$ 10,15 60: R\$ 10,35



CACHEPOT QUADRADO RETO 15CM 219

Código: Fábrika: Unidade:
30821 P A SOUZA UN/1
F1 F4

UN: R\$ 3,76 AV: R\$ 3,76 15: R\$ 3,84
30: R\$ 3,91 45: R\$ 3,99 60: R\$ 4,07



CACHEPOT SEXTAVADO CONICO 7CM 200

Código: Fábrika: Unidade:
30830 P A SOUZA UN/1
F1 F4

UN: R\$ 4,69 AV: R\$ 4,69 15: R\$ 4,79
30: R\$ 4,89 45: R\$ 4,99 60: R\$ 5,09



CACHEPOT SEXTAVADO CONICO 9CM 201

Código: Fábrika: Unidade:
30829 P A SOUZA UN/1
F1 F4

UN: R\$ 6,32 AV: R\$ 6,32 15: R\$ 6,45
30: R\$ 6,58 45: R\$ 6,71 60: R\$ 6,84



CACHEPOT SEXTAVADO CONICO 11CM 202

Código: Fábrika: Unidade:
30828 P A SOUZA UN/1
F1 F4

UN: R\$ 8,01 AV: R\$ 8,01 15: R\$ 8,18
30: R\$ 8,34 45: R\$ 8,51 60: R\$ 8,68



CACHEPOT SEXTAVADO CONICO 13CM 203

Código: Fábrika: Unidade:
30827 P A SOUZA UN/1
F1 F4

UN: R\$ 9,55 AV: R\$ 9,55 15: R\$ 9,75
30: R\$ 9,95 45: R\$ 10,15 60: R\$ 10,35

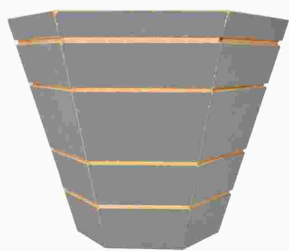

CACHEPOT SEXTAVADO CONICO 15CM 204
Código: Fábrica: Unidade:
30826 P A SOUZA UN/1
F1 F4

UN: R\$ 3,76 AV: R\$ 3,76 15: R\$ 3,84
30: R\$ 3,91 45: R\$ 3,99 60: R\$ 4,07

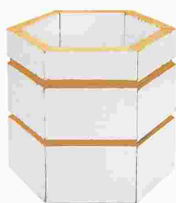

CACHEPOT SEXTAVADO RETO 7CM 205
Código: Fábrica: Unidade:
30837 P A SOUZA UN/1
F1 F4

UN: R\$ 4,61 AV: R\$ 4,61 15: R\$ 4,71
30: R\$ 4,80 45: R\$ 4,90 60: R\$ 5,00



CACHEPOT SEXTAVADO RETO 9CM 206
Código: Fábrica: Unidade:
30836 P A SOUZA UN/1
F1 F4

UN: R\$ 6,32 AV: R\$ 6,32 15: R\$ 6,45
30: R\$ 6,58 45: R\$ 6,71 60: R\$ 6,84

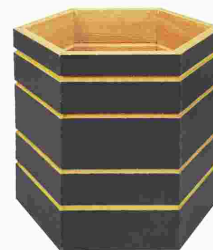

CACHEPOT SEXTAVADO RETO 11CM 207
Código: Fábrica: Unidade:
30835 P A SOUZA UN/1
F1 F4

UN: R\$ 8,01 AV: R\$ 8,01 15: R\$ 8,18
30: R\$ 8,34 45: R\$ 8,51 60: R\$ 8,68

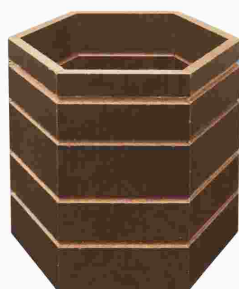

CACHEPOT SEXTAVADO RETO 13CM 208
Código: Fábrica: Unidade:
30834 P A SOUZA UN/1
F1 F4

UN: R\$ 9,40 AV: R\$ 9,40 15: R\$ 9,59
30: R\$ 9,79 45: R\$ 9,98 60: R\$ 10,18



CACHEPOT SEXTAVADO RETO 15CM 209
Código: Fábrica: Unidade:
30833 P A SOUZA UN/1
F1 F4

UN: R\$ 71,89 AV: R\$ 71,89 15: R\$ 73,39
30: R\$ 74,86 45: R\$ 76,36 60: R\$ 77,88



CADEIRA BISTRO PONTE NOVA BRANCA
Código: Fábrica: Unidade:
21168 ANTARES UN/1
F1 F4

UN: R\$ 71,89 AV: R\$ 71,89 15: R\$ 73,39
30: R\$ 74,86 45: R\$ 76,36 60: R\$ 77,88



CADEIRA BISTRO PONTE NOVA PRETA
Código: Fábrica: Unidade:
40038 ANTARES UN/1
F1 F4

UN: R\$ 154,08 AV: R\$ 154,08 15: R\$ 157,29
30: R\$ 160,44 45: R\$ 163,64 60: R\$ 166,92



CADEIRA COLONIAL PLAST DESMONTAVEL
Código: Fábrica: Unidade:
22151 ANTARES UN/1
F1 F4

UN: R\$ 82,17 AV: R\$ 82,17 15: R\$ 83,88
30: R\$ 85,56 45: R\$ 87,27 60: R\$ 89,01



CADEIRA POLTRONA BOA VISTA BRANCA
Código: Fábrica: Unidade:
21165 ANTARES UN/1
F1 F4

UN: R\$ 25,67 AV: R\$ 25,67 15: R\$ 26,20
30: R\$ 26,73 45: R\$ 27,26 60: R\$ 27,81



CAFETEIRA ALUM LEVE 1,2 LTS
Código: Fábrica: Unidade:
5905 AVELAR UN/1
F1 F4

UN: R\$ 66,76 AV: R\$ 66,76 15: R\$ 68,15
30: R\$ 69,51 45: R\$ 70,90 60: R\$ 72,32



CAFETEIRA ALUM PADRAO 657
Código: Fábrica: Unidade:
37512 MSR UN/1
F1 F4

UN: R\$ 51,35 AV: R\$ 51,35 15: R\$ 52,42
30: R\$ 53,47 45: R\$ 54,54 60: R\$ 55,63



CAIXA DE FRUTA GDE ENVELHECIDO 1461-1
Código: Fábrica: Unidade:
41754 PAIOL UN/1
F1 F4

UN: R\$ 38,16 AV: R\$ 38,16 15: R\$ 38,96
30: R\$ 39,73 45: R\$ 40,53 60: R\$ 41,34



CAIXA DE FRUTA GDE PINTADO 1461
Código: Fábrica: Unidade:
37178 PAIOL UN/1
F1 F4

UN: R\$ 31,84 AV: R\$ 31,84 15: R\$ 32,51
30: R\$ 33,16 45: R\$ 33,82 60: R\$ 34,50



CAIXA DE FRUTA MED ASSADO 1562
Código: Fábrica: Unidade:
37175 PAIOL UN/1
F1 F4

UN: R\$ 30,20 AV: R\$ 30,20 15: R\$ 30,83
30: R\$ 31,45 45: R\$ 32,07 60: R\$ 32,72



CAIXA DE FRUTA MED PINT/ENVELH 1462
Código: Fábrica: Unidade:
37179 PAIOL UN/1
F1 F4

UN: R\$ 25,42 AV: R\$ 25,42 15: R\$ 25,95
 30: R\$ 26,47 45: R\$ 27,00 60: R\$ 27,54
 16 cm
 30 cm



CAIXA DE FRUTA PEQ ASSADO 8005

Código: Fábrica: Unidade:
37176 PAIOL UN/1
 F1 F4

UN: R\$ 24,65 AV: R\$ 24,65 15: R\$ 25,17
 30: R\$ 25,67 45: R\$ 26,18 60: R\$ 26,71
 16 cm
 30 cm



CAIXA DE FRUTA PEQ PINT/ENVELH 1463

Código: Fábrica: Unidade:
37180 PAIOL UN/1
 F1 F4

UN: R\$ 21,56 AV: R\$ 21,56 15: R\$ 22,01
 30: R\$ 22,45 45: R\$ 22,90 60: R\$ 23,36
 12 cm
 23 cm



CAIXA DE FRUTA PP ENVELHECIDO 1453-1

Código: Fábrica: Unidade:
37177 PAIOL UN/1
 F1 F4

UN: R\$ 27,72 AV: R\$ 27,72 15: R\$ 28,30
 30: R\$ 28,87 45: R\$ 29,45 60: R\$ 30,03
 12 cm
 23 cm



CAIXA DE FRUTA PP PINTADO 1453-2

Código: Fábrica: Unidade:
37181 PAIOL UN/1
 F1 F4

UN: R\$ 35,94 AV: R\$ 35,94 15: R\$ 36,69
 30: R\$ 37,42 45: R\$ 38,17 60: R\$ 38,94
 17 cm
 35 cm



CAIXA DE FRUTA 2 CRISANTEMOS ENVE 2514-2

Código: Fábrica: Unidade:
37183 PAIOL UN/1
 F1 F4

UN: R\$ 29,78 AV: R\$ 29,78 15: R\$ 30,40
 30: R\$ 31,01 45: R\$ 31,63 60: R\$ 32,26



CAIXA DE FRUTA 2 CRISANTEMOS PINT 2514-1

Código: Fábrica: Unidade:
40842 PAIOL UN/1
 F1 F4

UN: R\$ 18,49 AV: R\$ 18,49 15: R\$ 18,87
 30: R\$ 19,25 45: R\$ 19,64 60: R\$ 20,03
 9 cm
 25 cm

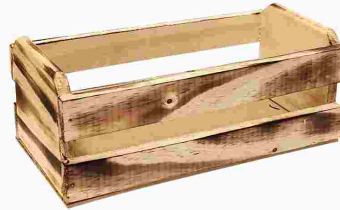

CAIXA DE FRUTA 2 VIOLETAS 2515

Código: Fábrica: Unidade:
37182 PAIOL UN/1
 F1 F4

UN: R\$ 4,10 AV: R\$ 4,10 15: R\$ 4,18
 30: R\$ 4,27 45: R\$ 4,35 60: R\$ 4,44
 8cm
 5cm
 8cm

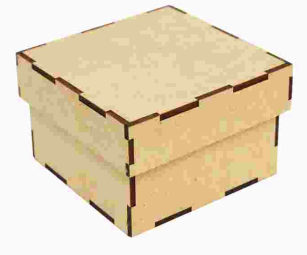

CAIXA MDF 5X5X5CM

Código: Fábrica: Unidade:
51073 FEITOMAO UN/1
 F1 F4

UN: R\$ 4,61 AV: R\$ 4,61 15: R\$ 4,71
 30: R\$ 4,80 45: R\$ 4,90 60: R\$ 5,00
 8cm
 5cm
 8cm



CAIXA MDF 8X8X5CM

Código: Fábrica: Unidade:
47264 FEITOMAO UN/1
 F1 F4

UN: R\$ 5,13 AV: R\$ 5,13 15: R\$ 5,23
 30: R\$ 5,34 45: R\$ 5,44 60: R\$ 5,55
 9cm
 5cm
 9cm



CAIXA MDF 9X9X5CM

Código: Fábrica: Unidade:
47265 FEITOMAO UN/1
 F1 F4

UN: R\$ 5,43 AV: R\$ 5,43 15: R\$ 5,55
 30: R\$ 5,66 45: R\$ 5,77 60: R\$ 5,89
 10cm
 5cm
 10cm

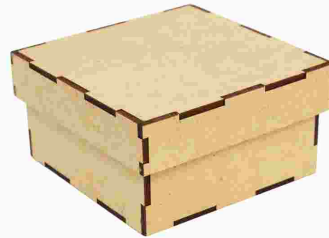

CAIXA MDF 10X10X5CM

Código: Fábrica: Unidade:
47266 FEITOMAO UN/1
 F1 F4

UN: R\$ 9,23 AV: R\$ 9,23 15: R\$ 9,43
 30: R\$ 9,62 45: R\$ 9,81 60: R\$ 10,00
 12cm
 12cm
 5cm

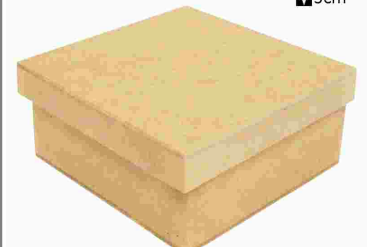

CAIXA MDF 12X12X5CM

Código: Fábrica: Unidade:
47268 FEITOMAO UN/1
 F1 F4

UN: R\$ 25,67 AV: R\$ 25,67 15: R\$ 26,20
 30: R\$ 26,73 45: R\$ 27,26 60: R\$ 27,81
 15cm
 5cm
 15cm

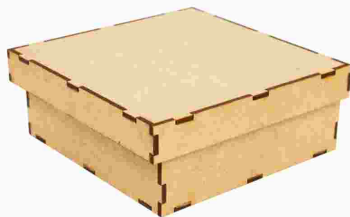

CAIXA MDF 15X15X15CM

Código: Fábrica: Unidade:
47269 FEITOMAO UN/1
 F1 F4

UN: R\$ 17,45 AV: R\$ 17,45 15: R\$ 17,82
 30: R\$ 18,17 45: R\$ 18,54 60: R\$ 18,91
 20cm
 20cm
 5cm



CAIXA MDF 20X20X5CM

Código: Fábrica: Unidade:
50758 FEITOMAO UN/1
 F1 F4

UN: R\$ 25,67 AV: R\$ 25,67 15: R\$ 26,20
 30: R\$ 26,73 45: R\$ 27,26 60: R\$ 27,81



CAIXA MINI KIT 3 PCS ENVELHECIDO 8788-5

Código: Fábrica: Unidade:
41056 PAIOL CJ/1
 F1 F4

UN: R\$ 5,95 AV: R\$ 5,95 15: R\$ 6,07
 30: R\$ 6,19 45: R\$ 6,32 60: R\$ 6,44



CAIXA MINI 1 ENVELHECIDO 8022-2

Código: Fábrica: Unidade:
41751 PAIOL UN/1
 F1 F4

UN: R\$ 9,23 AV: R\$ 9,23 15: R\$ 9,43
30: R\$ 9,62 45: R\$ 9,81 60: R\$ 10,00

17 cm
15 cm



CAIXA MINI 2 ENVELHECIDO 6664-2

Código: Fábrika: Unidade:
37186 PAIOL UN/1
F1 F4

UN: R\$ 9,23 AV: R\$ 9,23 15: R\$ 9,43
30: R\$ 9,62 45: R\$ 9,81 60: R\$ 10,00

17 cm
13 cm



CAIXA MINI 2 PINTADO 6664-1

Código: Fábrika: Unidade:
41752 PAIOL UN/1
F1 F4

UN: R\$ 24,24 AV: R\$ 24,24 15: R\$ 24,75
30: R\$ 25,24 45: R\$ 25,75 60: R\$ 26,26



CAIXA MULTI USO 11 LTS RET C/TPA 6649

Código: Fábrika: Unidade:
24474 INPLAST UN/1
F1 F4

UN: R\$ 82,45 AV: R\$ 82,45 15: R\$ 84,17
30: R\$ 85,85 45: R\$ 87,57 60: R\$ 89,32

16 cm
37 cm
52 cm
21 lbs



CAIXA ORG GDE BAIXA 21LTS C/TRAVA 1121

Código: Fábrika: Unidade:
33035 TRITEC UN/1
F1 F4

UN: R\$ 82,45 AV: R\$ 82,45 15: R\$ 84,17
30: R\$ 85,85 45: R\$ 87,57 60: R\$ 89,32

35cm
38cm
27lbs



CAIXA ORG MED ALTA 27LT C/TRAVA 1120

Código: Fábrika: Unidade:
44256 TRITEC UN/1
F1 F4

UN: R\$ 15,40 AV: R\$ 15,40 15: R\$ 15,72
30: R\$ 16,03 45: R\$ 16,35 60: R\$ 16,68

19 cm
27 cm
3,5 lbs



CAIXA ORG MINI MANDALA 3,5L MARROM 1892

Código: Fábrika: Unidade:
37296 MONTE LIBANO UN/1
F1 F4

UN: R\$ 15,40 AV: R\$ 15,40 15: R\$ 15,72
30: R\$ 16,03 45: R\$ 16,35 60: R\$ 16,68

19 cm
27 cm
3,5 lbs



CAIXA ORG MINI MANDALA 3,5L PRETA 1891

Código: Fábrika: Unidade:
37295 MONTE LIBANO UN/1
F1 F4

UN: R\$ 25,67 AV: R\$ 25,67 15: R\$ 26,20
30: R\$ 26,73 45: R\$ 27,26 60: R\$ 27,81



CAIXA ORG MINI PORTA TUDO C/2GAV 1217

Código: Fábrika: Unidade:
37293 MONTE LIBANO UN/1
F1 F4

UN: R\$ 65,11 AV: R\$ 65,11 15: R\$ 66,47
30: R\$ 67,80 45: R\$ 69,16 60: R\$ 70,54

22 cm



CAIXA ORG PEQ PORTA TUDO C/3GAV 1170

Código: Fábrika: Unidade:
43655 MONTE LIBANO UN/1
F1 F4

UN: R\$ 19,36 AV: R\$ 19,36 15: R\$ 19,77
30: R\$ 20,16 45: R\$ 20,56 60: R\$ 20,98

31 cm
13 cm
22 cm



CAIXA ORG PLAST RET C/TRAVA 5LTS 6845

Código: Fábrika: Unidade:
41659 INPLAST UN/1
F1 F4

UN: R\$ 8,90 AV: R\$ 8,90 15: R\$ 9,08
30: R\$ 9,26 45: R\$ 9,45 60: R\$ 9,64



CAIXA ORG PLAST RET TRANSP 2,5 LTS 6882

Código: Fábrika: Unidade:
41657 INPLAST UN/1
F1 F4

UN: R\$ 9,62 AV: R\$ 9,62 15: R\$ 9,83
30: R\$ 10,02 45: R\$ 10,22 60: R\$ 10,43



CAIXA ORG PLAST RET TRANSP 3,7 LTS 6886

Código: Fábrika: Unidade:
41658 INPLAST UN/1
F1 F4

UN: R\$ 23,55 AV: R\$ 23,55 15: R\$ 24,04
30: R\$ 24,52 45: R\$ 25,01 60: R\$ 25,51



CAIXA ORG RATTAN 10 LTS PRETO 951895

Código: Fábrika: Unidade:
41189 PLASTSU UN/1
F1 F4

UN: R\$ 44,78 AV: R\$ 44,78 15: R\$ 45,71
30: R\$ 46,62 45: R\$ 47,56 60: R\$ 48,51

19 cm
28 cm
38 cm
15 lbs

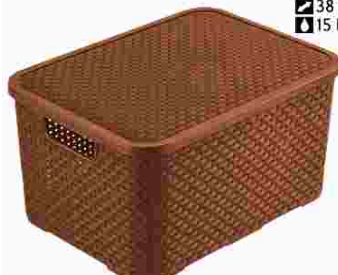

CAIXA ORG RATTAN 15LTS 1820

Código: Fábrika: Unidade:
32667 GIOTTO UN/1
F1 F4

UN: R\$ 48,30 AV: R\$ 48,30 15: R\$ 49,31
30: R\$ 50,29 45: R\$ 51,30 60: R\$ 52,33

18 cm
40 cm
28 cm
15 lbs



CAIXA ORG RATTAN 16 LTS PRETO 214PT

Código: Fábrika: Unidade:
35958 GIOTTO UN/1
F1 F4

UN: R\$ 44,78 AV: R\$ 44,78 15: R\$ 45,71
30: R\$ 46,62 45: R\$ 47,56 60: R\$ 48,51

28 cm
38 cm
15 lbs

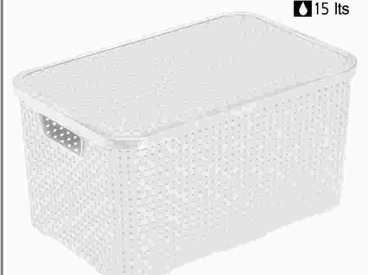

CAIXA ORG RATTAN 18LTS 38X28CM BRAN 1900

Código: Fábrika: Unidade:
37289 MONTE LIBANO UN/1
F1 F4

UN: R\$ 44,78 AV: R\$ 44,78 15: R\$ 45,71
30: R\$ 46,62 45: R\$ 47,56 60: R\$ 48,51
38cm
28cm
18lts

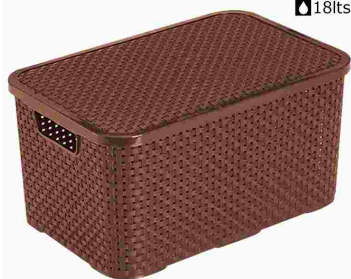

CAIXA ORG RATTAN 18LTS 38X28CM MARR 1902
Código: Fábrica: Unidade:
37290 MONTE LIBANO UN/1
F1 F4

UN: R\$ 44,78 AV: R\$ 44,78 15: R\$ 45,71
30: R\$ 46,62 45: R\$ 47,56 60: R\$ 48,51
38cm
28cm
18lts



CAIXA ORG RATTAN 18LTS 38X28CM PRET 1906
Código: Fábrica: Unidade:
37288 MONTE LIBANO UN/1
F1 F4

UN: R\$ 15,91 AV: R\$ 15,91 15: R\$ 16,24
30: R\$ 16,57 45: R\$ 16,90 60: R\$ 17,24
20cm
23cm



CAIXA ORG 10LTS ALTA PRETO C/TRAVA 138
Código: Fábrica: Unidade:
47726 FORMPLAST UN/1
F1 F4

UN: R\$ 21,56 AV: R\$ 21,56 15: R\$ 22,01
30: R\$ 22,45 45: R\$ 22,90 60: R\$ 23,36
15cm
45cm



CAIXA ORG 12LTS BAIXA PRETO C/TRAVA 8003
Código: Fábrica: Unidade:
40358 FORMPLAST UN/1
F1 F4

UN: R\$ 25,91 AV: R\$ 25,91 15: R\$ 26,45
30: R\$ 26,97 45: R\$ 27,51 60: R\$ 28,06



CAIXA ORG 18LTS BAIXA PRETO C/TRAVA 134
Código: Fábrica: Unidade:
47727 FORMPLAST UN/1
F1 F4

UN: R\$ 30,62 AV: R\$ 30,62 15: R\$ 31,26
30: R\$ 31,88 45: R\$ 32,52 60: R\$ 33,17
32cm
45cm



CAIXA ORG 30LTS ALTA PRETO C/TRAVA 132
Código: Fábrica: Unidade:
40355 FORMPLAST UN/1
F1 F4

UN: R\$ 47,11 AV: R\$ 47,11 15: R\$ 48,09
30: R\$ 49,05 45: R\$ 50,04 60: R\$ 51,04
25cm
60cm



CAIXA ORG 34LTS REFOR PRETO C/TRAVA 128
Código: Fábrica: Unidade:
47729 FORMPLAST UN/1
F1 F4

UN: R\$ 63,91 AV: R\$ 63,91 15: R\$ 65,24
30: R\$ 66,55 45: R\$ 67,88 60: R\$ 69,24
20cm
60cm



CAIXA ORG 50 LTS REFOR PRETO C/TRAVA 126
Código: Fábrica: Unidade:
47730 FORMPLAST UN/1
F1 F4

UN: R\$ 9,41 AV: R\$ 9,41 15: R\$ 9,61
30: R\$ 9,80 45: R\$ 10,00 60: R\$ 10,20
12cm
32cm



CAIXA ORG 5,5LTS BAIXA PRETO C/TRAV 3093
Código: Fábrica: Unidade:
47731 FORMPLAST UN/1
F1 F4

UN: R\$ 33,64 AV: R\$ 33,64 15: R\$ 34,34
30: R\$ 35,03 45: R\$ 35,73 60: R\$ 36,44



CAIXA ORGANI 20LTS PTO ALTA C/TRAVA 6123
Código: Fábrica: Unidade:
50202 RISCHIOTO UN/1
F1 F4

UN: R\$ 69,84 AV: R\$ 69,84 15: R\$ 71,29
30: R\$ 72,72 45: R\$ 74,17 60: R\$ 75,66
27cm
46cm
25lts



CAIXA ORGANIZADORA 25L TRAVA 0668T
Código: Fábrica: Unidade:
19692 JAGUAR UN/1
F1 F4

UN: R\$ 95,38 AV: R\$ 95,38 15: R\$ 97,36
30: R\$ 99,31 45: R\$ 101,30 60: R\$ 103,32
20cm
66cm
38lts



CAIXA ORGANIZADORA 38L TRAVA RODIN 2014T
Código: Fábrica: Unidade:
47093 JAGUAR UN/1
F1 F4

UN: R\$ 115,48 AV: R\$ 115,48 15: R\$ 117,88
30: R\$ 120,24 45: R\$ 122,65 60: R\$ 125,10
30cm
59cm
45lts

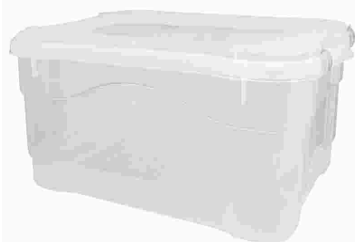

CAIXA ORGANIZADORA 45L TRAVA 0621T
Código: Fábrica: Unidade:
13169 JAGUAR UN/1
F1 F4

UN: R\$ 10,24 AV: R\$ 10,24 15: R\$ 10,45
30: R\$ 10,66 45: R\$ 10,88 60: R\$ 11,09



CAIXA ORGANIZATTA 1,6LTS C/TRAVA 118
Código: Fábrica: Unidade:
45192 RISCHIOTO UN/1
F1 F4

UN: R\$ 12,84 AV: R\$ 12,84 15: R\$ 13,11
30: R\$ 13,37 45: R\$ 13,64 60: R\$ 13,91



CAIXA ORGANIZATTA 3,2LTS C/TRAVA 119
Código: Fábrica: Unidade:
45195 RISCHIOTO UN/1
F1 F4

UN: R\$ 16,88 AV: R\$ 16,88 15: R\$ 17,23
30: R\$ 17,57 45: R\$ 17,92 60: R\$ 18,28



CAIXA ORGANIZATTA 5LTS C/TRAVA 127
Código: Fábrica: Unidade:
45197 RISCHIOTO UN/1
F1 F4

<p>UN: R\$ 21,61 AV: R\$ 21,61 15: R\$ 22,06 30: R\$ 22,50 45: R\$ 22,95 60: R\$ 23,41</p>  <p>CAIXA ORGANIZATTA 6LTS C/TRAVA 122 Código: Fábrica: Unidade: 45199 RISCHIOTO UN/1 F1 F4</p>	<p>UN: R\$ 31,10 AV: R\$ 31,10 15: R\$ 31,75 30: R\$ 32,39 45: R\$ 33,03 60: R\$ 33,70</p>  <p>CAIXA ORGANIZATTA 10LTS C/TRAVA 121 Código: Fábrica: Unidade: 45194 RISCHI/UNIN UN/1 F1 F4</p>	<p>UN: R\$ 25,85 AV: R\$ 25,85 15: R\$ 26,39 30: R\$ 26,92 45: R\$ 27,46 60: R\$ 28,01</p>  <p>CAIXA ORGANIZATTA 12LTS C/TRAVA 124 Código: Fábrica: Unidade: 45193 RISCHIOTO UN/1 F1 F4</p>	<p>UN: R\$ 42,26 AV: R\$ 42,26 15: R\$ 43,14 30: R\$ 44,00 45: R\$ 44,88 60: R\$ 45,78</p>  <p>CAIXA ORGANIZATTA 20LTS ALTA C/TRAVA 123 Código: Fábrica: Unidade: 45200 RISCHIOTO UN/1 F1 F4</p>
<p>UN: R\$ 56,49 AV: R\$ 56,49 15: R\$ 57,66 30: R\$ 58,82 45: R\$ 59,99 60: R\$ 61,19</p>  <p>CAIXA ORGANIZATTA 20LTS C/TRAVA BAIX 115 Código: Fábrica: Unidade: 45202 RISCHIOTO UN/1 F1 F4</p>	<p>UN: R\$ 56,43 AV: R\$ 56,43 15: R\$ 57,61 30: R\$ 58,76 45: R\$ 59,94 60: R\$ 61,14</p>  <p>CAIXA ORGANIZATTA 30LTS C/TRAVA ALTA 129 Código: Fábrica: Unidade: 45201 RISCHI/UNIN UN/1 F1 F4</p>	<p>UN: R\$ 71,89 AV: R\$ 71,89 15: R\$ 73,39 30: R\$ 74,86 45: R\$ 76,36 60: R\$ 77,88</p>  <p>CAIXA ORGANIZATTA 30LTS C/TRAVA 116 Código: Fábrica: Unidade: 45212 RISCHIOTO UN/1 F1 F4</p>	<p>UN: R\$ 101,23 AV: R\$ 101,23 15: R\$ 103,34 30: R\$ 105,41 45: R\$ 107,51 60: R\$ 109,66</p>  <p>CAIXA ORGANIZATTA 50LTS C/TRAVA ALTA 117 Código: Fábrica: Unidade: 36976 RISCHIOTO UN/1 F1 F4</p> <p>138 cm 44 cm</p>
<p>UN: R\$ 102,69 AV: R\$ 102,69 15: R\$ 104,83 30: R\$ 106,93 45: R\$ 109,06 60: R\$ 111,24</p>  <p>CAIXA ORGANIZATTA 56LTS C/TRAVA ALTA 364 Código: Fábrica: Unidade: 50823 UNINJET UN/1 F1 F4</p>	<p>UN: R\$ 148,07 AV: R\$ 148,07 15: R\$ 151,16 30: R\$ 154,18 45: R\$ 157,26 60: R\$ 160,41</p>  <p>CAIXA ORGANIZATTA 80LTS C/TRAVA 128 Código: Fábrica: Unidade: 45198 RISCHIOTO UN/1 F1 F4</p>	<p>UN: R\$ 36,97 AV: R\$ 36,97 15: R\$ 37,74 30: R\$ 38,49 45: R\$ 39,26 60: R\$ 40,05</p>  <p>CAIXA P/CARNE 19 LTS MULTIUSO 25X41X59CM Código: Fábrica: Unidade: 18386 ANTARES UN/1 F1 F4</p>	<p>UN: R\$ 16,72 AV: R\$ 16,72 15: R\$ 17,07 30: R\$ 17,41 45: R\$ 17,76 60: R\$ 18,12</p>  <p>CAIXA PLAST ORG 3LTS C/TRAVA TRANSL 417 Código: Fábrica: Unidade: 44422 USUAL UN/1 F1 F4</p> <p>11cm 26cm 3lts</p>
<p>UN: R\$ 21,15 AV: R\$ 21,15 15: R\$ 21,59 30: R\$ 22,02 45: R\$ 22,46 60: R\$ 22,91</p>  <p>CAIXA PLAST ORG 5LTS C/TRAVA TRANSL 414 Código: Fábrica: Unidade: 44421 USUAL UN/1 F1 F4</p> <p>14cm 30cm 5lts</p>	<p>UN: R\$ 35,61 AV: R\$ 35,61 15: R\$ 36,36 30: R\$ 37,08 45: R\$ 37,82 60: R\$ 38,58</p>  <p>CAIXA PLAST ORG 10LTS C/TRAVA TRANSL 366 Código: Fábrica: Unidade: 44420 USUAL UN/1 F1 F4</p> <p>13cm 42cm 10lts</p>	<p>UN: R\$ 49,67 AV: R\$ 49,67 15: R\$ 50,70 30: R\$ 51,71 45: R\$ 52,75 60: R\$ 53,80</p>  <p>CAIXA PLAST ORG 20LTS C/TRAVA TRANSL 388 Código: Fábrica: Unidade: 44419 USUAL UN/1 F1 F4</p> <p>25cm 42cm 20lts</p>	<p>UN: R\$ 16,42 AV: R\$ 16,42 15: R\$ 16,77 30: R\$ 17,10 45: R\$ 17,44 60: R\$ 17,79</p>  <p>CAIXA PLAST P/MASSA 20 LTS PRETA Código: Fábrica: Unidade: 45251 MOLDE MINAS UN/1 F1 F4</p> <p>14 cm 56 cm 20 lts</p>

UN: R\$ 24,43 AV: R\$ 24,43 15: R\$ 24,94
30: R\$ 25,43 45: R\$ 25,94 60: R\$ 26,46

Produto
* Altura: 16 cm
* Comp: 57cm
* Largura: 36 cm



CAIXA PLAST P/MASSA 22 LTS BRANCA

Código: 12905 Fábrica: ECOPLASTIC Unidade: UN/1 F1 F4

UN: R\$ 16,42 AV: R\$ 16,42 15: R\$ 16,77
30: R\$ 17,10 45: R\$ 17,44 60: R\$ 17,79



CAIXA PLAST P/MASSA 22 LTS PRETA

Código: 20662 Fábrica: ECOPLASTIC Unidade: UN/1 F1 F4

UN: R\$ 61,62 AV: R\$ 61,62 15: R\$ 62,91
30: R\$ 64,16 45: R\$ 65,45 60: R\$ 66,76



CAIXA PLAST PRETA VAZADA AGRICOLA/SUPERM

Código: 18385 Fábrica: ECOPLASTIC Unidade: UN/1 F1 F4

UN: R\$ 21,56 AV: R\$ 21,56 15: R\$ 22,01
30: R\$ 22,45 45: R\$ 22,90 60: R\$ 23,36

13cm
57,5cm
38cm



CAIXA PLAST 19 LTS P/MASSA PRETA

Código: 12117 Fábrica: ANTARES Unidade: UN/1 F1 F4

UN: R\$ 20,03 AV: R\$ 20,03 15: R\$ 20,45
30: R\$ 20,86 45: R\$ 21,27 60: R\$ 21,70



CAIXA PLAST 6,0 LTS VERSATIL TRANSP 786

Código: 39555 Fábrica: LUMAR Unidade: UN/1 F1 F4

UN: R\$ 14,72 AV: R\$ 14,72 15: R\$ 15,03
30: R\$ 15,33 45: R\$ 15,63 60: R\$ 15,95

8cm
45cm



CAIXA PLAST 7 LTS P/FRIOS 1637

Código: 47068 Fábrica: JAGUAR Unidade: UN/1 F1 F4

UN: R\$ 143,78 AV: R\$ 143,78 15: R\$ 146,77
30: R\$ 149,71 45: R\$ 152,70 60: R\$ 155,76

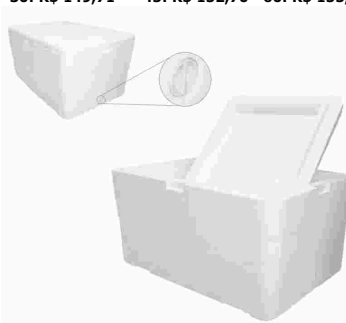

CAIXA TERMICA ISOPOR 80 LTS COM DRENO

Código: 47998 Fábrica: ISOMAX Unidade: UN/1 F1 F4

UN: R\$ 77,03 AV: R\$ 77,03 15: R\$ 78,63
30: R\$ 80,21 45: R\$ 81,81 60: R\$ 83,45



CAIXA TERMICA 16 LTS COLOR

Código: 31769 Fábrica: ANTARES Unidade: UN/1 F1 F4

UN: R\$ 123,25 AV: R\$ 123,25 15: R\$ 125,82
30: R\$ 128,34 45: R\$ 130,90 60: R\$ 133,52



CAIXA TERMICA 34 LTS COLOR

Código: 30863 Fábrica: ANTARES Unidade: UN/1 F1 F4

UN: R\$ 5,18 AV: R\$ 5,18 15: R\$ 5,29
30: R\$ 5,40 45: R\$ 5,51 60: R\$ 5,62



CAIXA VERSATIL QUADR 3,5 LTS 951

Código: 34582 Fábrica: PLASTBON Unidade: UN/1 F1 F4

UN: R\$ 5,18 AV: R\$ 5,18 15: R\$ 5,29
30: R\$ 5,40 45: R\$ 5,51 60: R\$ 5,62



CAIXA VERSATIL RED 3,5 LTS 949

Código: 34583 Fábrica: PLASTBON Unidade: UN/1 F1 F4

UN: R\$ 5,18 AV: R\$ 5,18 15: R\$ 5,29
30: R\$ 5,40 45: R\$ 5,51 60: R\$ 5,62



CAIXA VERSATIL RET 3,5 LTS 950

Código: 34574 Fábrica: PLASTBON Unidade: UN/1 F1 F4

UN: R\$ 8,46 AV: R\$ 8,46 15: R\$ 8,64
30: R\$ 8,81 45: R\$ 8,99 60: R\$ 9,17



CAIXA VERSATIL 2,5LTS RET FACILITA 6340

Código: 20696 Fábrica: RISCHIOTO Unidade: UN/1 F1 F4

UN: R\$ 10,26 AV: R\$ 10,26 15: R\$ 10,48
30: R\$ 10,69 45: R\$ 10,90 60: R\$ 11,12



CAIXA VERSATIL 3,6LTS RET FACILITTA 0120

Código: 20703 Fábrica: RISCHIOTO Unidade: UN/1 F1 F4

UN: R\$ 151,85 AV: R\$ 151,85 15: R\$ 155,01
30: R\$ 158,11 45: R\$ 161,28 60: R\$ 164,50



CALDEIRAO ALUM HOTEL ESP 32 22LTS

Código: 50714 Fábrica: ASJ Unidade: UN/1 F1 F4

UN: R\$ 205,19 AV: R\$ 205,19 15: R\$ 209,47
30: R\$ 213,66 45: R\$ 217,93 60: R\$ 222,29



CALDEIRAO ALUM HOTEL ESP 36 32LTS

Código: 50715 Fábrica: ASJ Unidade: UN/1 F1 F4

UN: R\$ 135,25 AV: R\$ 135,25 15: R\$ 138,07
30: R\$ 140,83 45: R\$ 143,65 60: R\$ 146,52



CALDEIRAO ALUM HOTEL 30 18LTS

Código: Fábrika: Unidade:
50713 ASJ UN/1
F1 F4

UN: R\$ 11,29 AV: R\$ 11,29 15: R\$ 11,52
30: R\$ 11,75 45: R\$ 11,99 60: R\$ 12,23



CANECA ALUM CHOPP

Código: Fábrika: Unidade:
14754 AVELAR UN/1
F1 F4

UN: R\$ 11,29 AV: R\$ 11,29 15: R\$ 11,52
30: R\$ 11,75 45: R\$ 11,99 60: R\$ 12,23



CANECA ALUM ESCOLAR 02 1286

Código: Fábrika: Unidade:
37527 MSR UN/1
F1 F4

UN: R\$ 25,67 AV: R\$ 25,67 15: R\$ 26,20
30: R\$ 26,73 45: R\$ 27,26 60: R\$ 27,81



CANECA ALUM LEVE 12 FRIZADO 1,0 LT

Código: Fábrika: Unidade:
11261 AVELAR UN/1
F1 F4

UN: R\$ 16,23 AV: R\$ 16,23 15: R\$ 16,57
30: R\$ 16,90 45: R\$ 17,24 60: R\$ 17,58
11 cm
350ml



CANECA ALUM 350ML CHOPP BOMDIMAI'S 9012

Código: Fábrika: Unidade:
40400 UN-ART UN/1
F1 F4

UN: R\$ 16,23 AV: R\$ 16,23 15: R\$ 16,57
30: R\$ 16,90 45: R\$ 17,24 60: R\$ 17,58
11 cm
350ml



CANECA ALUM 350ML CHOPP CERVEJA GEL 9009

Código: Fábrika: Unidade:
40399 UN-ART UN/1
F1 F4

UN: R\$ 16,23 AV: R\$ 16,23 15: R\$ 16,57
30: R\$ 16,90 45: R\$ 17,24 60: R\$ 17,58
11 cm
350ml



CANECA ALUM 350ML CHOPP DRAHMA 9007

Código: Fábrika: Unidade:
40398 UN-ART UN/1
F1 F4

UN: R\$ 6,50 AV: R\$ 19,51 15: R\$ 19,91
30: R\$ 20,31 45: R\$ 20,72 60: R\$ 21,13



CANECA ESMALTADA COLOR 80ML 18151 3X1

Código: Fábrika: Unidade:
50212 WELLMIX CX/3
F1 F4

UN: R\$ 4,88 AV: R\$ 19,51 15: R\$ 19,91
30: R\$ 20,31 45: R\$ 20,72 60: R\$ 21,13



CANECA ESMALTADA COLOR 90ML 9111295 4X1

Código: Fábrika: Unidade:
39257 FRATELLI PT/4
F1 F4

UN: R\$ 11,93 AV: R\$ 71,55 15: R\$ 73,05
30: R\$ 74,51 45: R\$ 76,00 60: R\$ 77,52



CANECA ESMALTADA PRETO 350ML 18149 6X1

Código: Fábrika: Unidade:
50210 WELLMIX CX/6
F1 F4

UN: R\$ 11,93 AV: R\$ 71,55 15: R\$ 73,05
30: R\$ 74,51 45: R\$ 76,00 60: R\$ 77,52



CANECA ESMALTADA VERMELH 350ML 18150 6X1

Código: Fábrika: Unidade:
50211 WELLMIX CX/6
F1 F4

UN: R\$ 21,56 AV: R\$ 21,56 15: R\$ 22,01
30: R\$ 22,45 45: R\$ 22,90 60: R\$ 23,36



CANECA ESMALTADA 8CM 7017

Código: Fábrika: Unidade:
43592 KEY UN/1
F1 F4

UN: R\$ 163,94 AV: R\$ 163,94 15: R\$ 167,36
30: R\$ 170,70 45: R\$ 174,12 60: R\$ 177,60



CANECA INOX TERM 710ML AZUL 14043

Código: Fábrika: Unidade:
40667 INGA UN/1
F1 F4

UN: R\$ 163,94 AV: R\$ 163,94 15: R\$ 167,36
30: R\$ 170,70 45: R\$ 174,12 60: R\$ 177,60



CANECA INOX TERM 710ML BRANCO 14044

Código: Fábrika: Unidade:
40666 INGA UN/1
F1 F4

UN: R\$ 163,94 AV: R\$ 163,94 15: R\$ 167,36
30: R\$ 170,70 45: R\$ 174,12 60: R\$ 177,60



CANECA INOX TERM 710ML CINZA 14042

Código: Fábrika: Unidade:
40669 INGA UN/1
F1 F4

UN: R\$ 163,94 AV: R\$ 163,94 15: R\$ 167,36
30: R\$ 170,70 45: R\$ 174,12 60: R\$ 177,60



CANECA INOX TERM 710ML PRETO 14041

Código: Fábrika: Unidade:
40668 INGA UN/1
F1 F4

UN: R\$ 40,06 AV: R\$ 40,06 15: R\$ 40,90
30: R\$ 41,71 45: R\$ 42,55 60: R\$ 43,40



CANECA INOX 350ML LATINHA 14022
Código: Fábrika: Unidade:
40317 WINCY UN/1
F1 F4

UN: R\$ 51,35 AV: R\$ 51,35 15: R\$ 52,42
30: R\$ 53,47 45: R\$ 54,54 60: R\$ 55,63



CANECA METAL INOX 300ML CRUZEIRO 10716
Código: Fábrika: Unidade:
41112 BRASFOOT UN/1
F1 F4

UN: R\$ 2,35 AV: R\$ 2,35 15: R\$ 2,40
30: R\$ 2,45 45: R\$ 2,50 60: R\$ 2,55



CANECA PLAST C/ALCA 300 ML CORES
Código: Fábrika: Unidade:
45926 ANTARES UN/1
F1 F4

UN: R\$ 5,29 AV: R\$ 5,29 15: R\$ 5,40
30: R\$ 5,51 45: R\$ 5,62 60: R\$ 5,73



CANECA PLAST DEC 430ML INFANTIL 1403
Código: Fábrika: Unidade:
40130 KOZI PLAST UN/1
F1 F4

UN: R\$ 1,96 AV: R\$ 5,88 15: R\$ 6,00
30: R\$ 6,12 45: R\$ 6,24 60: R\$ 6,37



CANECA PLAST ESC 250 ML KIT 3 PCS 4013
Código: Fábrika: Unidade:
7204 SBRISSA CJ/3
F1 F4

UN: R\$ 2,85 AV: R\$ 34,15 15: R\$ 34,86
30: R\$ 35,56 45: R\$ 36,27 60: R\$ 37,00



CANECA PLAST ESC 270 ML DEC 8016 12X1
Código: Fábrika: Unidade:
35222 SBRISSA PT/12
F1 F4

UN: R\$ 2,59 AV: R\$ 2,59 15: R\$ 2,59
30: R\$ 2,59 45: R\$ 2,59 60: R\$ 2,59



CANECA PLAST ESCOLAR 300 ML 105
Código: Fábrika: Unidade:
22324 ECOPLASTIC UN/1
F1 F4

UN: R\$ 24,27 AV: R\$ 48,54 15: R\$ 49,55
30: R\$ 50,54 45: R\$ 51,55 60: R\$ 52,58



CANECA PLAST GEL 300ML ADORO 11641 2X1
Código: Fábrika: Unidade:
41125 BRASFOOT CJ/2
F1 F4

UN: R\$ 31,80 AV: R\$ 31,80 15: R\$ 32,46
30: R\$ 33,11 45: R\$ 33,77 60: R\$ 34,45



CANECA PLAST GEL 300ML BOMDIMAIS 3961
Código: Fábrika: Unidade:
39126 BRASFOOT UN/1
F1 F4

UN: R\$ 27,08 AV: R\$ 27,08 15: R\$ 27,65
30: R\$ 28,20 45: R\$ 28,76 60: R\$ 29,34



CANECA PLAST GEL 300ML DRAHMA 3863
Código: Fábrika: Unidade:
39127 BRASFOOT UN/1
F1 F4

UN: R\$ 31,80 AV: R\$ 31,80 15: R\$ 32,46
30: R\$ 33,11 45: R\$ 33,77 60: R\$ 34,45



CANECA PLAST GEL 300ML HARLEY DAVI 2933
Código: Fábrika: Unidade:
39130 BRASFOOT UN/1
F1 F4

UN: R\$ 21,16 AV: R\$ 42,32 15: R\$ 43,20
30: R\$ 44,07 45: R\$ 44,95 60: R\$ 45,85



CANECA PLAST GEL 300ML VC ME F 11619 2X1
Código: Fábrika: Unidade:
41124 BRASFOOT CJ/2
F1 F4

UN: R\$ 53,00 AV: R\$ 53,00 15: R\$ 54,11
30: R\$ 55,19 45: R\$ 56,29 60: R\$ 57,42



CANECA PLAST TERMICA 450ML PAI IDOLO 05
Código: Fábrika: Unidade:
39271 BRASFOOT UN/1
F1 F4

UN: R\$ 5,59 AV: R\$ 5,59 15: R\$ 5,70
30: R\$ 5,82 45: R\$ 5,93 60: R\$ 6,05



CANECA PLAST 270 ML COLOR 617
Código: Fábrika: Unidade:
38661 TRITEC UN/1
F1 F4

UN: R\$ 3,00 AV: R\$ 3,00 15: R\$ 3,06
30: R\$ 3,12 45: R\$ 3,19 60: R\$ 3,25



CANECA PLAST 310ML COLOR 623
Código: Fábrika: Unidade:
44082 QUALYPLAS UN/1
F1 F4

UN: R\$ 3,76 AV: R\$ 22,59 15: R\$ 23,06
30: R\$ 23,52 45: R\$ 23,99 60: R\$ 24,47



CANECA PLAST 400 ML C/ ALCA 7000 6X1
Código: Fábrika: Unidade:
33895 SBRISSA CJ/6
F1 F4

UN: R\$ 6,98 AV: R\$ 41,87 15: R\$ 42,74
30: R\$ 43,60 45: R\$ 44,47 60: R\$ 45,36



CANECA PLAST 400 ML C/ALCA DEC 8022 6X1
Código: Fábrika: Unidade:
35223 SBRISSA PT/6
F1 F4

UN: R\$ 8,21 AV: R\$ 8,21 15: R\$ 8,38
30: R\$ 8,55 45: R\$ 8,72 60: R\$ 8,89



CANECA PLAST 450ML SORT P/FREEZER/MIC 47
Código: Fábrika: Unidade:
40989 PLASTIBRASIL UN/1
F1 F4

UN: R\$ 13,34 AV: R\$ 13,34 15: R\$ 13,62
30: R\$ 13,89 45: R\$ 14,17 60: R\$ 14,46



CANECA PORC 220 ML CACHORRO 13
Código: Fábrika: Unidade:
44345 PORCELANASLU UN/1
F1 F4

UN: R\$ 13,34 AV: R\$ 13,34 15: R\$ 13,62
30: R\$ 13,89 45: R\$ 14,17 60: R\$ 14,46



CANECA PORC 220 ML CAFE/COFFEE 13
Código: Fábrika: Unidade:
37247 PORCELANASLU UN/1
F1 F4

UN: R\$ 13,34 AV: R\$ 13,34 15: R\$ 13,62
30: R\$ 13,89 45: R\$ 14,17 60: R\$ 14,46



CANECA PORC 220 ML CARROS 13
Código: Fábrika: Unidade:
37246 PORCELANASLU UN/1
F1 F4

UN: R\$ 13,34 AV: R\$ 13,34 15: R\$ 13,62
30: R\$ 13,89 45: R\$ 14,17 60: R\$ 14,46



CANECA PORC 220 ML CHOCOLATE 13
Código: Fábrika: Unidade:
44350 PORCELANASLU UN/1
F1 F4

UN: R\$ 13,34 AV: R\$ 13,34 15: R\$ 13,62
30: R\$ 13,89 45: R\$ 14,17 60: R\$ 14,46



CANECA PORC 220 ML GATO 13
Código: Fábrika: Unidade:
44344 PORCELANASLU UN/1
F1 F4

UN: R\$ 13,34 AV: R\$ 13,34 15: R\$ 13,62
30: R\$ 13,89 45: R\$ 14,17 60: R\$ 14,46



CANECA PORC 220 ML MEME BENTO 13
Código: Fábrika: Unidade:
44342 PORCELANASLU UN/1
F1 F4

UN: R\$ 14,74 AV: R\$ 14,74 15: R\$ 15,05
30: R\$ 15,35 45: R\$ 15,66 60: R\$ 15,97



CANECA PORC 220 ML PAI 13
Código: Fábrika: Unidade:
37244 PORCELANASLU UN/1
F1 F4

UN: R\$ 13,34 AV: R\$ 13,34 15: R\$ 13,62
30: R\$ 13,89 45: R\$ 14,17 60: R\$ 14,46



CANECA PORC 220 ML PERIGO 13
Código: Fábrika: Unidade:
44346 PORCELANASLU UN/1
F1 F4

UN: R\$ 13,70 AV: R\$ 164,34 15: R\$ 167,77
30: R\$ 171,12 45: R\$ 174,54 60: R\$ 178,03



CANECA PORC 270ML DEC 778 12X1
Código: Fábrika: Unidade:
41433 OXFORD CJ/12
F1 F4

UN: R\$ 13,70 AV: R\$ 164,34 15: R\$ 167,77
30: R\$ 171,12 45: R\$ 174,54 60: R\$ 178,03



CANECA PORC 270ML LISA PTO/BCO 777 12X1
Código: Fábrika: Unidade:
41434 OXFORD CX/12
F1 F4

UN: R\$ 33,89 AV: R\$ 33,89 15: R\$ 34,59
30: R\$ 35,29 45: R\$ 35,99 60: R\$ 36,71



CANECA PORC 360 ML MEU GAME FORT 2955
Código: Fábrika: Unidade:
38995 BRASFOOT UN/1
F1 F4

UN: R\$ 33,89 AV: R\$ 33,89 15: R\$ 34,59
30: R\$ 35,29 45: R\$ 35,99 60: R\$ 36,71



CANECA PORC 360 ML MEU GAME MINE 2567
Código: Fábrika: Unidade:
39010 BRASFOOT UN/1
F1 F4

UN: R\$ 33,89 AV: R\$ 33,89 15: R\$ 34,59
30: R\$ 35,29 45: R\$ 35,99 60: R\$ 36,71



CANECA PORC 360 ML URBAN DIRIGE SEU 5836
Código: Fábrika: Unidade:
39110 BRASFOOT UN/1
F1 F4

UN: R\$ 33,89 AV: R\$ 33,89 15: R\$ 34,59
30: R\$ 35,29 45: R\$ 35,99 60: R\$ 36,71



CANECA PORC 360 ML URBAN O MUNDO 2790
Código: Fábrika: Unidade:
39104 BRASFOOT UN/1
F1 F4

UN: R\$ 33,89 AV: R\$ 33,89 15: R\$ 34,59
30: R\$ 35,29 45: R\$ 35,99 60: R\$ 36,71



CANECA PORC 360ML URBAN ADORO NOS 11494
Código: Fábrika: Unidade:
41134 BRASFOOT UN/1
F1 F4

UN: R\$ 33,89 AV: R\$ 33,89 15: R\$ 34,59
30: R\$ 35,29 45: R\$ 35,99 60: R\$ 36,71



CANECA PORC 360ML URBAN AMIGAS 10041
Código: Fábrika: Unidade:
39111 BRASFOOT UN/1
F1 F4

UN: R\$ 35,94 AV: R\$ 35,94 15: R\$ 36,69
30: R\$ 37,42 45: R\$ 38,17 60: R\$ 38,94



CANECA PORC 360ML URBAN ATLETICO 1627
Código: Fábrika: Unidade:
39113 BRASFOOT UN/1
F1 F4

UN: R\$ 33,89 AV: R\$ 33,89 15: R\$ 34,59
30: R\$ 35,29 45: R\$ 35,99 60: R\$ 36,71



CANECA PORC 360ML URBAN VC ME FAZ 11325
Código: Fábrika: Unidade:
41135 BRASFOOT UN/1
F1 F4

UN: R\$ 8,56 AV: R\$ 51,35 15: R\$ 52,42
30: R\$ 53,47 45: R\$ 54,54 60: R\$ 55,63



CANECA PORCELANA 50ML DECOR 6X1
Código: Fábrika: Unidade:
42804 INTERPONTE CX/6
F1 F4

UN: R\$ 35,44 AV: R\$ 35,44 15: R\$ 36,18
30: R\$ 36,90 45: R\$ 37,64 60: R\$ 38,39



CANECA TERMICA INOX 340ML TRIANGLE 16015
Código: Fábrika: Unidade:
40319 WINCY UN/1
F1 F4

UN: R\$ 40,06 AV: R\$ 40,06 15: R\$ 40,90
30: R\$ 41,71 45: R\$ 42,55 60: R\$ 43,40



CANECA TERMICA INOX 500ML C/TAMPA 1401
Código: Fábrika: Unidade:
40318 WINCY UN/1
F1 F4

UN: R\$ 6,77 AV: R\$ 40,62 15: R\$ 41,46
30: R\$ 42,29 45: R\$ 43,14 60: R\$ 44,00



CANECA VIDRO 100ML CANADA 016 6X1
Código: Fábrika: Unidade:
49432 RIOHOME CJ/6
F1 F4

UN: R\$ 7,76 AV: R\$ 46,53 15: R\$ 47,50
30: R\$ 48,45 45: R\$ 49,42 60: R\$ 50,41



CANECA VIDRO 255ML TRANSP LISA VD24 6X1
Código: Fábrika: Unidade:
40294 MAXXIMUS CJ/6
F1 F4

UN: R\$ 7,31 AV: R\$ 350,83 15: R\$ 358,14
30: R\$ 365,30 45: R\$ 372,61 60: R\$ 380,06



CANECA VIDRO 268ML NOVO 1070 48X1
Código: Fábrika: Unidade:
39523 MULTIPRESENT CX/48
F1 F4

UN: R\$ 22,59 AV: R\$ 22,59 15: R\$ 23,06
30: R\$ 23,52 45: R\$ 23,99 60: R\$ 24,47



CANECA VIDRO 370 ML CHOPP 057 2X1
Código: Fábrika: Unidade:
49395 RIOHOME CJ/1
F1 F4

UN: R\$ 60,59 AV: R\$ 60,59 15: R\$ 61,86
30: R\$ 63,09 45: R\$ 64,36 60: R\$ 65,64



CANECAO ALUM BAT FUND 16 CB MAD 2L 1519
Código: Fábrika: Unidade:
37449 MSR UN/1
F1 F4

UN: R\$ 9,96 AV: R\$ 9,96 15: R\$ 10,17
30: R\$ 10,37 45: R\$ 10,58 60: R\$ 10,79



CANECAO ALUM CHOPP 10 667
Código: Fábrika: Unidade:
22732 MSR UN/1
F1 F4

UN: R\$ 39,02 AV: R\$ 39,02 15: R\$ 39,84
30: R\$ 40,63 45: R\$ 41,45 60: R\$ 42,27



CANECAO ALUM CRAQUEADO 14 CB MAD 1,9 LT
Código: Fábrika: Unidade:
34761 AVELAR UN/1
F1 F4

UN: R\$ 25,67 AV: R\$ 25,67 15: R\$ 26,20
30: R\$ 26,73 45: R\$ 27,26 60: R\$ 27,81



CANECAO ALUM EXTRA 12 CB MAD 1,0 LT 661
Código: Fábrika: Unidade:
10438 MSR UN/1
F1 F4

UN: R\$ 29,78 AV: R\$ 29,78 15: R\$ 30,40
30: R\$ 31,01 45: R\$ 31,63 60: R\$ 32,26



CANECAO ALUM EXTRA 14 CB MAD 1,5 LTS 662
Código: Fábrika: Unidade:
24370 MSR UN/1
F1 F4

UN: R\$ 32,86 AV: R\$ 32,86 15: R\$ 33,54
30: R\$ 34,22 45: R\$ 34,90 60: R\$ 35,60



CANEAÇO ALUM EXTRA 16 CB MAD 2,0 LTS 658
Código: Fábrika: Unidade:
24369 MSR UN/1
F1 F4

UN: R\$ 39,02 AV: R\$ 39,02 15: R\$ 39,84
30: R\$ 40,63 45: R\$ 41,45 60: R\$ 42,27



CANEAÇO ALUM EXTRA 18 CB MAD 2,5 LTS 659
Código: Fábrika: Unidade:
24368 MSR UN/1
F1 F4

UN: R\$ 36,97 AV: R\$ 36,97 15: R\$ 37,74
30: R\$ 38,49 45: R\$ 39,26 60: R\$ 40,05



CANEAÇO ALUM EXTRA 20 CB MAD 660
Código: Fábrika: Unidade:
24367 MSR UN/1
F1 F4

UN: R\$ 25,67 AV: R\$ 25,67 15: R\$ 26,20
30: R\$ 26,73 45: R\$ 27,26 60: R\$ 27,81



CANEAÇO ALUM LEVE JAPONES 2,0 LTS
Código: Fábrika: Unidade:
27598 AVELAR UN/1
F1 F4

UN: R\$ 19,51 AV: R\$ 19,51 15: R\$ 19,91
30: R\$ 20,31 45: R\$ 20,72 60: R\$ 21,13



CANEAÇO ALUM LEVE 14 CB BAQ 1,5 LTS 672
Código: Fábrika: Unidade:
35255 MSR UN/1
F1 F4

UN: R\$ 25,67 AV: R\$ 25,67 15: R\$ 26,20
30: R\$ 26,73 45: R\$ 27,26 60: R\$ 27,81



CANEAÇO ALUM LEVE 16 1,9 LTS
Código: Fábrika: Unidade:
5891 AVELAR UN/1
F1 F4

UN: R\$ 35,94 AV: R\$ 35,94 15: R\$ 36,69
30: R\$ 37,42 45: R\$ 38,17 60: R\$ 38,94



CANEAÇO ALUM LUXO FORTE 18 CB BAQ 1130
Código: Fábrika: Unidade:
35037 MSR UN/1
F1 F4

UN: R\$ 38,52 AV: R\$ 38,52 15: R\$ 39,32
30: R\$ 40,11 45: R\$ 40,91 60: R\$ 41,73



CANEAÇO ALUM LUXO FORTE 20 CB BAQ 898
Código: Fábrika: Unidade:
35036 MSR UN/1
F1 F4

UN: R\$ 23,62 AV: R\$ 23,62 15: R\$ 24,11
30: R\$ 24,59 45: R\$ 25,08 60: R\$ 25,58



CANEAÇO ALUM LUXO 12 CB BAQ 1,0LT 664
Código: Fábrika: Unidade:
25305 MSR UN/1
F1 F4

UN: R\$ 25,67 AV: R\$ 25,67 15: R\$ 26,20
30: R\$ 26,73 45: R\$ 27,26 60: R\$ 27,81



CANEAÇO ALUM LUXO 14 CB BAQ 1,5LT 663
Código: Fábrika: Unidade:
24371 MSR UN/1
F1 F4

UN: R\$ 26,70 AV: R\$ 26,70 15: R\$ 27,25
30: R\$ 27,80 45: R\$ 28,35 60: R\$ 28,92



CANEAÇO ALUM LUXO 16 CB BAQ 2L 665
Código: Fábrika: Unidade:
24372 MSR UN/1
F1 F4

UN: R\$ 53,22 AV: R\$ 53,22 15: R\$ 54,33
30: R\$ 55,41 45: R\$ 56,52 60: R\$ 57,65



CANEAÇO ALUM TEFLON 14 CB BAQ 1425
Código: Fábrika: Unidade:
45283 MSR UN/1
F1 F4

UN: R\$ 25,67 AV: R\$ 25,67 15: R\$ 26,20
30: R\$ 26,73 45: R\$ 27,26 60: R\$ 27,81



CANEAÇO ALUM LEVE BOJUDO 2,7 LTS
Código: Fábrika: Unidade:
5892 AVELAR UN/1
F1 F4

UN: R\$ 2,65 AV: R\$ 2,65 15: R\$ 2,71
30: R\$ 2,76 45: R\$ 2,82 60: R\$ 2,87



CANEAÇO PLAST 040
Código: Fábrika: Unidade:
10962 HM UTILIDADE UN/1
F1 F4

UN: R\$ 30,81 AV: R\$ 30,81 15: R\$ 31,45
30: R\$ 32,08 45: R\$ 32,72 60: R\$ 33,37



CANIVETE LAMINA ESTREITA 80X14MM 6326
Código: Fábrika: Unidade:
41349 CORNETA UN/1
F1 F4

UN: R\$ 0,22 AV: R\$ 22,02 15: R\$ 22,48
30: R\$ 22,93 45: R\$ 23,39 60: R\$ 23,86



CANUDO PAPEL 19,7X0,6CM BRANCO 100X1
Código: Fábrika: Unidade:
46909 VMP CX/100
F1 F4

UN: R\$ 0,20 AV: R\$ 5,08 15: R\$ 5,19
30: R\$ 5,29 45: R\$ 5,40 60: R\$ 5,51



CANUDO PAPEL 19,7X0,6CM BRANCO 25X1
Código: Fábrika: Unidade:
46907 VMP PT/25
F1 F4

UN: R\$ 0,20 AV: R\$ 5,08 15: R\$ 5,19
30: R\$ 5,29 45: R\$ 5,40 60: R\$ 5,51



CANUDO PAPEL 19,7X0,6CM ROSA 25X1
Código: Fábrika: Unidade:
46908 VMP PT/25
F1 F4

UN: R\$ 0,10 AV: R\$ 2,56 15: R\$ 2,61
30: R\$ 2,66 45: R\$ 2,72 60: R\$ 2,77



CANUDO PAPEL 19,7X0,8CM BRANCO 5067 25X1
Código: Fábrika: Unidade:
47902 CASITA PT/25
F1 F4

UN: R\$ 0,12 AV: R\$ 12,32 15: R\$ 12,57
30: R\$ 12,82 45: R\$ 13,08 60: R\$ 13,34



CANUDO PLAST LISO FLEXIVEL COLOR 100X1
Código: Fábrika: Unidade:
50420 PLAZAPEL PT/100
F1 F4

UN: R\$ 0,15 AV: R\$ 22,46 15: R\$ 22,93
30: R\$ 23,39 45: R\$ 23,86 60: R\$ 24,34



CANUDO PLAST MILK S 8X21CM EMB IND 150X1
Código: Fábrika: Unidade:
47651 JACARE PT/150
F1 F4

UN: R\$ 0,10 AV: R\$ 10,17 15: R\$ 10,38
30: R\$ 10,59 45: R\$ 10,80 60: R\$ 11,02



CANUDO PLAST VITAMI 6X21CM EMB IND 100X1
Código: Fábrika: Unidade:
47652 PLASTSUL PT/100
F1 F4

UN: R\$ 6,67 AV: R\$ 6,67 15: R\$ 6,81
30: R\$ 6,94 45: R\$ 7,08 60: R\$ 7,22



CANUDO PLASTICO 21CM 65074 100X1
Código: Fábrika: Unidade:
33209 PLASTSU/SHOK PT/1
F1 F4

UN: R\$ 13,15 AV: R\$ 13,15 15: R\$ 13,42
30: R\$ 13,69 45: R\$ 13,96 60: R\$ 14,24



CAPA ALMOFADA PANO INF 34X34CM FRENT EST
Código: Fábrika: Unidade:
40450 SUN WELLS UN/1
F1 F4

UN: R\$ 13,34 AV: R\$ 13,34 15: R\$ 13,62
30: R\$ 13,89 45: R\$ 14,17 60: R\$ 14,46



CAPA P/BOTIJA UNIVERSAL 13 KG
Código: Fábrika: Unidade:
7771 FERREIRA UN/1
F1 F4

UN: R\$ 3,08 AV: R\$ 3,08 15: R\$ 3,15
30: R\$ 3,21 45: R\$ 3,27 60: R\$ 3,34



CAPA P/FILTRO 15124
Código: Fábrika: Unidade:
35113 SATYAM UN/1
F1 F4

UN: R\$ 49,20 AV: R\$ 49,20 15: R\$ 50,23
30: R\$ 51,23 45: R\$ 52,26 60: R\$ 53,30



CAPA P/MAQUINA LAVAR NAPA REFOR ATE11 KG
Código: Fábrika: Unidade:
11339 FERREIRA UN/1
F1 F4

UN: R\$ 8,21 AV: R\$ 8,21 15: R\$ 8,38
30: R\$ 8,55 45: R\$ 8,72 60: R\$ 8,89



CAPA P/TAMPA DE FOGAO 4 BOCAS 52X52CM
Código: Fábrika: Unidade:
39277 FERREIRA UN/1
F1 F4

UN: R\$ 11,29 AV: R\$ 11,29 15: R\$ 11,52
30: R\$ 11,75 45: R\$ 11,99 60: R\$ 12,23



CAPA P/TAMPA DE FOGAO 6 BOCAS 52X81CM
Código: Fábrika: Unidade:
11338 FERREIRA UN/1
F1 F4

UN: R\$ 7,26 AV: R\$ 7,26 15: R\$ 7,41
30: R\$ 7,56 45: R\$ 7,71 60: R\$ 7,87



CARRETILHA INOX 20,8CM P/MASSAS 064
Código: Fábrika: Unidade:
47333 NIX UN/1
F1 F4

UN: R\$ 29,78 AV: R\$ 29,78 15: R\$ 30,40
30: R\$ 31,01 45: R\$ 31,63 60: R\$ 32,26



CARRIOLA PL CRISANTEMO CAFE 2390
Código: Fábrika: Unidade:
37143 PAIOL UN/1
F1 F4

UN: R\$ 29,78 AV: R\$ 29,78 15: R\$ 30,40
30: R\$ 31,01 45: R\$ 31,63 60: R\$ 32,26



CARRIOLA PL MADEIRA ENVELHECIDA P 5074-2
Código: Fábrika: Unidade:
41403 PAIOL UN/1
F1 F4

UN: R\$ 35,94 AV: R\$ 35,94 15: R\$ 36,69
30: R\$ 37,42 45: R\$ 38,17 60: R\$ 38,94
↑ 15,5 cm
↔ 44 cm



CARRIOLA PL 2 VIOLETAS CAFE 0126
Código: Fábrica: Unidade:
37141 PAIOL UN/1
F1 F4

UN: R\$ 13,34 AV: R\$ 13,34 15: R\$ 13,62
30: R\$ 13,89 45: R\$ 14,17 60: R\$ 14,46



CASCA DE PINUS PO 1 KG
Código: Fábrica: Unidade:
22288 VITAPLAN PT/1
F1 F4

UN: R\$ 7,18 AV: R\$ 7,18 15: R\$ 7,33
30: R\$ 7,48 45: R\$ 7,63 60: R\$ 7,78



CASCA DE PINUS 300 GRs
Código: Fábrica: Unidade:
27463 NOVATROPICAL PT/1
F1 F4

UN: R\$ 27,72 AV: R\$ 27,72 15: R\$ 28,30
30: R\$ 28,87 45: R\$ 29,45 60: R\$ 30,03
↑ 38 cm
↔ 16 cm



CASINHA PLANTA GDE CAFE 130
Código: Fábrica: Unidade:
37146 PAIOL UN/1
F1 F4

UN: R\$ 51,35 AV: R\$ 51,35 15: R\$ 52,42
30: R\$ 53,47 45: R\$ 54,54 60: R\$ 55,63
↑ 52 cm
↔ 23 cm



CASINHA PLANTA 2 ANDARES CAFE 0392
Código: Fábrica: Unidade:
37145 PAIOL UN/1
F1 F4

UN: R\$ 41,08 AV: R\$ 41,08 15: R\$ 41,93
30: R\$ 42,77 45: R\$ 43,63 60: R\$ 44,50
↑ 40 cm
↔ 27 cm



CASINHA PLANTA 2 VIOLETAS CAFE 2460
Código: Fábrica: Unidade:
37147 PAIOL UN/1
F1 F4

UN: R\$ 71,89 AV: R\$ 71,89 15: R\$ 73,39
30: R\$ 74,86 45: R\$ 76,36 60: R\$ 77,88
↑ 77 cm
↔ 24 cm



CASINHA PLANTA 3 ANDARES CAFE 0404
Código: Fábrica: Unidade:
37144 PAIOL UN/1
F1 F4

UN: R\$ 22,59 AV: R\$ 22,59 15: R\$ 23,06
30: R\$ 23,52 45: R\$ 23,99 60: R\$ 24,47
↑ 33cm
↑ 10,5cm
↔ 23,5cm



CESTA CAFE MANHA KRAFT 23,5X33X10,5CM UN
Código: Fábrica: Unidade:
44233 PFEIFER UN/1
F1 F4

UN: R\$ 9,45 AV: R\$ 9,45 15: R\$ 9,65
30: R\$ 9,84 45: R\$ 10,04 60: R\$ 10,24
↑ 19cm
↔ 11cm



CESTA FRALDEIRA 11CM RED PINUS 8940
Código: Fábrica: Unidade:
50819 PAIOL UN/1
F1 F4

UN: R\$ 10,48 AV: R\$ 10,48 15: R\$ 10,70
30: R\$ 10,91 45: R\$ 11,13 60: R\$ 11,35
↑ 21cm
↔ 13cm



CESTA FRALDEIRA 13CM RED PINUS 8941
Código: Fábrica: Unidade:
50820 PAIOL UN/1
F1 F4

UN: R\$ 11,56 AV: R\$ 11,56 15: R\$ 11,80
30: R\$ 12,03 45: R\$ 12,27 60: R\$ 12,52
↑ 23cm
↔ 15cm



CESTA FRALDEIRA 15CM RED PINUS 8942
Código: Fábrica: Unidade:
50821 PAIOL UN/1
F1 F4

UN: R\$ 12,94 AV: R\$ 12,94 15: R\$ 13,21
30: R\$ 13,48 45: R\$ 13,75 60: R\$ 14,02
↑ 27cm
↔ 18cm



CESTA FRALDEIRA 18CM RED PINUS 8943
Código: Fábrica: Unidade:
41297 PAIOL UN/1
F1 F4

UN: R\$ 21,18 AV: R\$ 21,18 15: R\$ 21,62
30: R\$ 22,05 45: R\$ 22,50 60: R\$ 22,95
↑ 31cm
↔ 25cm



CESTA FRALDEIRA 25CM RED PINUS 8944
Código: Fábrica: Unidade:
41298 PAIOL UN/1
F1 F4

UN: R\$ 25,29 AV: R\$ 25,29 15: R\$ 25,82
30: R\$ 26,33 45: R\$ 26,86 60: R\$ 27,40
↑ 37cm
↔ 30cm



CESTA FRALDEIRA 30CM RED PINUS 8945
Código: Fábrica: Unidade:
41299 PAIOL UN/1
F1 F4

UN: R\$ 29,78 AV: R\$ 29,78 15: R\$ 30,40
30: R\$ 31,01 45: R\$ 31,63 60: R\$ 32,26
↑ 32 cm
↔ 31 cm



CESTA VIME RED PEQ 5081
Código: Fábrica: Unidade:
40611 PAIOL UN/1
F1 F4

UN: R\$ 6,49 AV: R\$ 6,49 15: R\$ 6,49
30: R\$ 6,49 45: R\$ 6,49 60: R\$ 6,49
↑ 25cm
↔ 24cm



CESTO PAPELEIRO TELADO QUAD PTO 24X24CM
Código: Fábrica: Unidade:
32922 SHANGRILA UN/1
F1 F4

UN: R\$ 6,49 AV: R\$ 6,49 15: R\$ 6,49
30: R\$ 6,49 45: R\$ 6,49 60: R\$ 6,49

1 24cm
2 30cm



CESTO PAPELEIRO TELADO RED PTO 23X30CM
Código: 32923 Fábrica: SHANGRILA Unidade: UN/1 F1 F4

UN: R\$ 90,84 AV: R\$ 90,84 15: R\$ 92,73
30: R\$ 94,58 45: R\$ 96,47 60: R\$ 98,40

1 52cm
2 75cm
3 60lts



CESTO PLAST BASIC 60 LTS ECO 3081/79
Código: 49172 Fábrica: JAGUAR Unidade: UN/1 F1 F4

UN: R\$ 72,92 AV: R\$ 72,92 15: R\$ 74,44
30: R\$ 75,93 45: R\$ 77,45 60: R\$ 79,00

1 55cm
2 63cm
3 95lts



CESTO PLAST FECHADO COLOR 95 LTS 6862
Código: 41663 Fábrica: INPLAST Unidade: UN/1 F1 F4

UN: R\$ 17,46 AV: R\$ 17,46 15: R\$ 17,82
30: R\$ 18,18 45: R\$ 18,54 60: R\$ 18,91

1 5,5cm
2 34,4cm
3 11cm

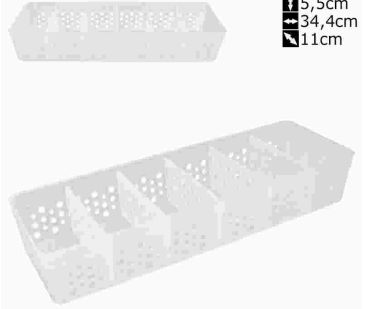

CESTO PLAST GDE C/5 DIV TRANSL 760
Código: 44428 Fábrica: USUAL Unidade: UN/1 F1 F4

UN: R\$ 25,29 AV: R\$ 25,29 15: R\$ 25,82
30: R\$ 26,34 45: R\$ 26,86 60: R\$ 27,40

1 6cm
2 34,4cm
3 17cm

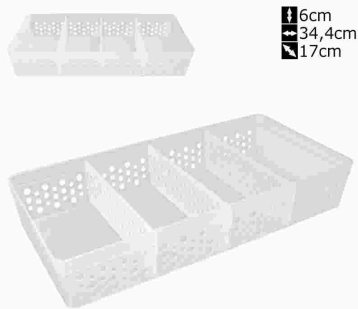

CESTO PLAST MAXI C/3 DIV TRANSL 796
Código: 44429 Fábrica: USUAL Unidade: UN/1 F1 F4

UN: R\$ 12,08 AV: R\$ 12,08 15: R\$ 12,33
30: R\$ 12,57 45: R\$ 12,82 60: R\$ 13,08

1 6cm
2 24,4cm
3 19cm



CESTO PLAST MED 24,2X19,6,5CM PRETO 617
Código: 44430 Fábrica: USUAL Unidade: UN/1 F1 F4

UN: R\$ 4,51 AV: R\$ 4,51 15: R\$ 4,61
30: R\$ 4,70 45: R\$ 4,79 60: R\$ 4,89

1 6cm
2 8,5cm
3 11cm

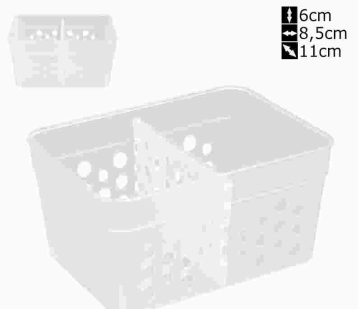

CESTO PLAST MINI C/1 DIV TRANSL 757
Código: 44427 Fábrica: USUAL Unidade: UN/1 F1 F4

UN: R\$ 39,48 AV: R\$ 39,48 15: R\$ 40,30
30: R\$ 41,10 45: R\$ 41,93 60: R\$ 42,76



CESTO PLAST ROUPEIRO 30 LTS COLOR 828
Código: 51064 Fábrica: LUMAR Unidade: UN/1 F1 F4

UN: R\$ 49,30 AV: R\$ 49,30 15: R\$ 50,32
30: R\$ 51,33 45: R\$ 52,36 60: R\$ 53,40



CESTO PLAST ROUPEIRO 60 LTS 849
Código: 46666 Fábrica: LUMAR Unidade: UN/1 F1 F4

UN: R\$ 72,92 AV: R\$ 72,92 15: R\$ 74,44
30: R\$ 75,93 45: R\$ 77,45 60: R\$ 79,00

1 64cm
2 58cm
3 100lts



CESTO PLAST ROUPEIRO 100 LTS PRETO 3100
Código: 46667 Fábrica: LUMAR Unidade: UN/1 F1 F4

UN: R\$ 54,18 AV: R\$ 54,18 15: R\$ 55,31
30: R\$ 56,41 45: R\$ 57,54 60: R\$ 58,69

1 45cm
2 52cm



CESTO PLAST TELADO COLOR 62 LTS 6682
Código: 41665 Fábrica: INPLAST Unidade: UN/1 F1 F4

UN: R\$ 10,54 AV: R\$ 10,54 15: R\$ 10,76
30: R\$ 10,98 45: R\$ 11,20 60: R\$ 11,42

1 24 cm
2 25 cm

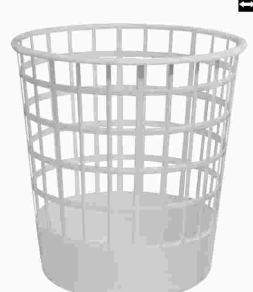

CESTO PLAST TELADO RED BCO 24X25CM 340
Código: 33032 Fábrica: TRITEC Unidade: UN/1 F1 F4

UN: R\$ 31,02 AV: R\$ 31,02 15: R\$ 31,67
30: R\$ 32,30 45: R\$ 32,95 60: R\$ 33,61



CESTO PLAST TELADO RED 30 LTS PRETO 789
Código: 51062 Fábrica: LUMAR Unidade: UN/1 F1 F4

UN: R\$ 55,85 AV: R\$ 55,85 15: R\$ 57,01
30: R\$ 58,15 45: R\$ 59,32 60: R\$ 60,50



CESTO PLAST TELADO RED 60 LTS PRETO 937
Código: 51063 Fábrica: LUMAR Unidade: UN/1 F1 F4

UN: R\$ 34,79 AV: R\$ 34,79 15: R\$ 35,52
30: R\$ 36,23 45: R\$ 36,95 60: R\$ 37,69



CESTO PLAST TELADO RET 35 LTS PRETO 1015
Código: 51047 Fábrica: LUMAR Unidade: UN/1 F1 F4

UN: R\$ 58,33 AV: R\$ 58,33 15: R\$ 59,55
30: R\$ 60,74 45: R\$ 61,96 60: R\$ 63,19



CESTO PLAST TELADO RET 72 LTS PRETO 931
Código: 51046 Fábrica: LUMAR Unidade: UN/1 F1 F4

UN: R\$ 8,82 AV: R\$ 8,82 15: R\$ 9,01
30: R\$ 9,19 45: R\$ 9,37 60: R\$ 9,56



CESTO PLAST TELADO 10 LTS PRETO 163

Código: 38656 Fábrica: MOLDE MINAS Unidade: UN/1 F1 F4

UN: R\$ 10,26 AV: R\$ 10,26 15: R\$ 10,48
30: R\$ 10,69 45: R\$ 10,90 60: R\$ 11,12



CESTO PLAST TELADO 10 LTS 118

Código: 50003 Fábrica: PLASMARC Unidade: UN/1 F1 F4

UN: R\$ 9,67 AV: R\$ 9,67 15: R\$ 9,87
30: R\$ 10,06 45: R\$ 10,27 60: R\$ 10,47



CESTO PLAST TELADO 10 LTS 728

Código: 37264 Fábrica: LUMAR Unidade: UN/1 F1 F4

UN: R\$ 35,42 AV: R\$ 35,42 15: R\$ 36,16
30: R\$ 36,88 45: R\$ 37,62 60: R\$ 38,37



CESTO PLAST TELADO 30 LTS AZUL BABY 831

Código: 50943 Fábrica: LUMAR Unidade: UN/1 F1 F4

UN: R\$ 35,43 AV: R\$ 35,43 15: R\$ 36,17
30: R\$ 36,89 45: R\$ 37,63 60: R\$ 38,38



CESTO PLAST TELADO 30 LTS BRANCO 776

Código: 39552 Fábrica: LUMAR Unidade: UN/1 F1 F4

UN: R\$ 35,43 AV: R\$ 35,43 15: R\$ 36,17
30: R\$ 36,89 45: R\$ 37,63 60: R\$ 38,38



CESTO PLAST TELADO 30 LTS FENDI 873

Código: 39554 Fábrica: LUMAR Unidade: UN/1 F1 F4

UN: R\$ 35,42 AV: R\$ 35,42 15: R\$ 36,16
30: R\$ 36,88 45: R\$ 37,62 60: R\$ 38,37



CESTO PLAST TELADO 30 LTS ROSA BABY 831

Código: 48998 Fábrica: LUMAR Unidade: UN/1 F1 F4

UN: R\$ 17,45 AV: R\$ 17,45 15: R\$ 17,82
30: R\$ 18,17 45: R\$ 18,54 60: R\$ 18,91

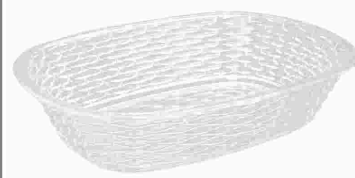

CESTO P/PAO CRISTAL NATURAL 2342

Código: 44255 Fábrica: TRITEC Unidade: UN/1 F1 F4

UN: R\$ 49,99 AV: R\$ 49,99 15: R\$ 49,99
30: R\$ 49,99 45: R\$ 49,99 60: R\$ 49,99



CESTO TELADO RET P/ROUPA 60 LTS CORES

Código: 40878 Fábrica: ANTARES Unidade: UN/1 F1 F4

UN: R\$ 29,44 AV: R\$ 29,44 15: R\$ 30,05
30: R\$ 30,65 45: R\$ 31,27 60: R\$ 31,89



CESTO TELADO ROUPAS 30LTS COLOR 951765

Código: 41199 Fábrica: PLASTSU Unidade: UN/1 F1 F4

UN: R\$ 29,44 AV: R\$ 29,44 15: R\$ 30,05
30: R\$ 30,65 45: R\$ 31,27 60: R\$ 31,89



CESTO TELADO ROUPAS 30LTS PRETO 951000

Código: 41198 Fábrica: PLASTSU Unidade: UN/1 F1 F4

UN: R\$ 7,18 AV: R\$ 7,18 15: R\$ 7,33
30: R\$ 7,48 45: R\$ 7,63 60: R\$ 7,78



CHIPS DE COCO 1 LITRO

Código: 48533 Fábrica: NOVATROPICAL Unidade: PT/1 F1 F4

UN: R\$ 3,08 AV: R\$ 36,97 15: R\$ 37,74
30: R\$ 38,49 45: R\$ 39,26 60: R\$ 40,05



CHUVEIRINHO P/TORNEIRA PIA TANQUE 1 12X1

Código: 33735 Fábrica: REBOUCAS Unidade: PT/12 F1 F4

UN: R\$ 6,85 AV: R\$ 82,17 15: R\$ 83,88
30: R\$ 85,56 45: R\$ 87,27 60: R\$ 89,01



COADOR FLANELA CAFE SEM CABO 12X1

Código: 50969 Fábrica: BEAUTY Unidade: DZ/12 F1 F4

UN: R\$ 4,62 AV: R\$ 55,47 15: R\$ 56,62
30: R\$ 57,76 45: R\$ 58,91 60: R\$ 60,09



COADOR FLANELA CAFE 102 CB MAD 12X1

Código: 27405 Fábrica: MCPAN/BEAUTY Unidade: DZ/12 F1 F4

UN: R\$ 4,74 AV: R\$ 56,88 15: R\$ 56,88
30: R\$ 56,88 45: R\$ 56,88 60: R\$ 56,88



COADOR FLANELA CAFE 103 CB MAD 12X1

Código: 27406 Fábrica: BEAU/AMO/MAR Unidade: DZ/12 F1 F4

UN: R\$ 6,68 AV: R\$ 80,12 15: R\$ 81,79
30: R\$ 83,43 45: R\$ 85,10 60: R\$ 86,80



COADOR FLANELA CAFE 104 CB ALUM 12X1
Código: 27412 Fábrica: FERREIRA Unidade: DZ/12 F1 F4

UN: R\$ 5,13 AV: R\$ 5,13 15: R\$ 5,23
30: R\$ 5,34 45: R\$ 5,44 60: R\$ 5,55



COADOR FLANELA CAFE 104 CB MAD UN
Código: 46137 Fábrica: MC PANOS Unidade: UN/1 F1 F4

UN: R\$ 5,78 AV: R\$ 69,34 15: R\$ 70,78
30: R\$ 72,20 45: R\$ 73,64 60: R\$ 75,11



COADOR FLANELA CAFE 104 CB MAD 12X1
Código: 27408 Fábrica: MC PANOS Unidade: DZ/12 F1 F4

UN: R\$ 5,65 AV: R\$ 67,80 15: R\$ 69,21
30: R\$ 70,59 45: R\$ 72,00 60: R\$ 73,44



COADOR FLANELA CAFE 105 CB MAD 12X1
Código: 23956 Fábrica: MC PANOS Unidade: DZ/12 F1 F4

UN: R\$ 6,16 AV: R\$ 73,96 15: R\$ 75,50
30: R\$ 77,01 45: R\$ 78,55 60: R\$ 80,12



COADOR FLANELA CAFE 107 CB MAD 12X1
Código: 34505 Fábrica: MC PANOS Unidade: DZ/12 F1 F4

UN: R\$ 4,28 AV: R\$ 51,35 15: R\$ 52,42
30: R\$ 53,47 45: R\$ 54,54 60: R\$ 55,63



COADOR MALHA CAFE GDE CB PLAST 12X1
Código: 24949 Fábrica: NZA Unidade: DZ/12 F1 F4

UN: R\$ 1,53 AV: R\$ 1,53 15: R\$ 1,56
30: R\$ 1,59 45: R\$ 1,63 60: R\$ 1,66



COADOR PLASTICO 07 CM 3020 UN
Código: 48015 Fábrica: SBRISSA Unidade: UN/1 F1 F4

UN: R\$ 3,23 AV: R\$ 3,23 15: R\$ 3,29
30: R\$ 3,36 45: R\$ 3,43 60: R\$ 3,49



COADOR PLASTICO 12 CM 3021 UN
Código: 16642 Fábrica: SBRISSA Unidade: UN/1 F1 F4

UN: R\$ 6,15 AV: R\$ 6,15 15: R\$ 6,28
30: R\$ 6,41 45: R\$ 6,53 60: R\$ 6,67



COADOR PLASTICO 18 CM 3023 UN
Código: 48009 Fábrica: SBRISSA Unidade: UN/1 F1 F4

UN: R\$ 4,11 AV: R\$ 49,30 15: R\$ 50,32
30: R\$ 51,33 45: R\$ 52,36 60: R\$ 53,40



COLEIRA PET FIBRA C/SINO 30 CM 12X1
Código: 45878 Fábrica: ALMEGA Unidade: PT/12 F1 F4

UN: R\$ 6,77 AV: R\$ 40,64 15: R\$ 41,49
30: R\$ 42,32 45: R\$ 43,17 60: R\$ 44,03



COLEIRA PET TIPO COURO 38 CM 15593 6X1
Código: 39244 Fábrica: ALIANCA Unidade: PT/6 F1 F4

UN: R\$ 3,72 AV: R\$ 22,30 15: R\$ 22,77
30: R\$ 23,22 45: R\$ 23,68 60: R\$ 24,16



COLHER ACO INOX REFEICAO 21CM 14736 6X1
Código: 46490 Fábrica: NICOBEM Unidade: PT/6 F1 F4

UN: R\$ 3,10 AV: R\$ 18,59 15: R\$ 18,98
30: R\$ 19,36 45: R\$ 19,75 60: R\$ 20,14



COLHER ACO INOX SOBREMESA 17CM 14771 6X1
Código: 46489 Fábrica: NICOBEM Unidade: PT/6 F1 F4

UN: R\$ 11,00 AV: R\$ 11,00 15: R\$ 11,23
30: R\$ 11,46 45: R\$ 11,68 60: R\$ 11,92



COLHER ACO INOX 34CM GDE 14785
Código: 46488 Fábrica: NICOBEM Unidade: UN/1 F1 F4

UN: R\$ 13,34 AV: R\$ 13,34 15: R\$ 13,62
30: R\$ 13,89 45: R\$ 14,17 60: R\$ 14,46



COLHER ALUM BATIDO 30CM ARROZ 2641
Código: 45293 Fábrica: MSR Unidade: UN/1 F1 F4

UN: R\$ 4,47 AV: R\$ 4,47 15: R\$ 4,56
30: R\$ 4,65 45: R\$ 4,75 60: R\$ 4,84



COLHER ALUM 27CM INTEIRICO 2018 UN
Código: 48018 Fábrica: COFAX Unidade: UN/1 F1 F4

UN: R\$ 4,98 AV: R\$ 4,98 15: R\$ 5,09
30: R\$ 5,19 45: R\$ 5,29 60: R\$ 5,40



COLHER ALUM 28CM CB MAD 2003 UN
Código: 48035 Fábrica: COFAX Unidade: UN/1
F1 F4

UN: R\$ 7,18 AV: R\$ 7,18 15: R\$ 7,33
30: R\$ 7,48 45: R\$ 7,63 60: R\$ 7,78



COLHER BAMBU 23 CM 050
Código: 46252 Fábrica: CASITA Unidade: UN/1
F1 F4

UN: R\$ 7,18 AV: R\$ 7,18 15: R\$ 7,33
30: R\$ 7,48 45: R\$ 7,63 60: R\$ 7,78



COLHER BAMBU 30 CM 052
Código: 46253 Fábrica: CASITA Unidade: UN/1
F1 F4

UN: R\$ 0,11 AV: R\$ 5,39 15: R\$ 5,51
30: R\$ 5,62 45: R\$ 5,73 60: R\$ 5,84



COLHER DESCARTAVEL 50X1
Código: 42147 Fábrica: PLAZA/RIOFES Unidade: PT/50
F1 F4

UN: R\$ 1,19 AV: R\$ 3,58 15: R\$ 3,66
30: R\$ 3,73 45: R\$ 3,81 60: R\$ 3,88



COLHER ESPATULA GARFO MADEIRA 30CM 6029
Código: 44738 Fábrica: WINCY Unidade: CJ/3
F1 F4

UN: R\$ 6,99 AV: R\$ 6,99 15: R\$ 7,13
30: R\$ 7,27 45: R\$ 7,42 60: R\$ 7,57



COLHER INOX CACIQUE 33CM 137
Código: 39351 Fábrica: PLANETA Unidade: UN/1
F1 F4

UN: R\$ 2,22 AV: R\$ 26,70 15: R\$ 27,25
30: R\$ 27,80 45: R\$ 28,35 60: R\$ 28,92



COLHER INOX CHA LINHA PRATA 110 12X1
Código: 47628 Fábrica: PLANETA Unidade: PT/12
F1 F4

UN: R\$ 2,05 AV: R\$ 24,64 15: R\$ 25,16
30: R\$ 25,66 45: R\$ 26,17 60: R\$ 26,70



COLHER INOX MESA LINHA AMERICA 2223 12X1
Código: 50620 Fábrica: STEEL Unidade: PT/12
F1 F4

UN: R\$ 2,86 AV: R\$ 17,15 15: R\$ 17,51
30: R\$ 17,86 45: R\$ 18,22 60: R\$ 18,58



COLHER INOX MESA UNIVERSO 2046 6X1
Código: 50136 Fábrica: GP6 Unidade: PT/6
F1 F4

UN: R\$ 2,05 AV: R\$ 24,64 15: R\$ 25,16
30: R\$ 25,66 45: R\$ 26,17 60: R\$ 26,70



COLHER INOX MESA 19CM VERSA PTO 954 12X1
Código: 50163 Fábrica: PLANETA Unidade: DZ/12
F1 F4

UN: R\$ 15,40 AV: R\$ 15,40 15: R\$ 15,72
30: R\$ 16,03 45: R\$ 16,35 60: R\$ 16,68



COLHER INOX P/ARROZ 35CM 173
Código: 19947 Fábrica: PLANETA Unidade: UN/1
F1 F4

UN: R\$ 6,15 AV: R\$ 6,15 15: R\$ 6,28
30: R\$ 6,41 45: R\$ 6,53 60: R\$ 6,67



COLHER INOX P/SUCO 30,5CM 8189
Código: 41541 Fábrica: ELITE Unidade: UN/1
F1 F4

UN: R\$ 1,43 AV: R\$ 17,15 15: R\$ 17,51
30: R\$ 17,86 45: R\$ 18,22 60: R\$ 18,58



COLHER INOX SOBREMESA BRONZE 522 12X1
Código: 39346 Fábrica: PLANETA Unidade: PT/12
F1 F4

UN: R\$ 1,28 AV: R\$ 15,40 15: R\$ 15,72
30: R\$ 16,03 45: R\$ 16,35 60: R\$ 16,68



COLHER INOX SOBREMESA VANGUARD 15CM 12X1
Código: 50906 Fábrica: GP INOX Unidade: CX/12
F1 F4

UN: R\$ 12,99 AV: R\$ 12,99 15: R\$ 13,26
30: R\$ 13,53 45: R\$ 13,80 60: R\$ 14,08



COLHER INOX SORVETE C/EXTRATOR 19CM 3025
Código: 44728 Fábrica: WINCY Unidade: UN/1
F1 F4

UN: R\$ 3,34 AV: R\$ 3,34 15: R\$ 3,41
30: R\$ 3,48 45: R\$ 3,55 60: R\$ 3,62



COLHER INOX SORVETE 19CM CB PLAST 3243
Código: 44727 Fábrica: WINCY Unidade: UN/1
F1 F4

UN: R\$ 4,36 AV: R\$ 4,36 15: R\$ 4,45
30: R\$ 4,54 45: R\$ 4,63 60: R\$ 4,72



COLHER MACARRAO NYLON PRETO 1085
Código: Fábrica: Unidade:
37804 ENGIPLAST UN/1
F1 F4

UN: R\$ 4,10 AV: R\$ 4,10 15: R\$ 4,18
30: R\$ 4,27 45: R\$ 4,35 60: R\$ 4,44



COLHER MADEIRA 23 CM 01
Código: Fábrica: Unidade:
41315 MAD LAR UN/1
F1 F4

UN: R\$ 7,18 AV: R\$ 7,18 15: R\$ 7,33
30: R\$ 7,48 45: R\$ 7,63 60: R\$ 7,78



COLHER MADEIRA 38 CM 105/05
Código: Fábrica: Unidade:
30807 CSD/MAD LAR UN/1
F1 F4

UN: R\$ 1,47 AV: R\$ 5,88 15: R\$ 6,00
30: R\$ 6,12 45: R\$ 6,24 60: R\$ 6,37



COLHER MEDIDORA CHA SOPA 400 4X1
Código: Fábrica: Unidade:
37080 DELTA UTIL PT/4
F1 F4

UN: R\$ 21,19 AV: R\$ 21,19 15: R\$ 21,63
30: R\$ 22,07 45: R\$ 22,51 60: R\$ 22,96



COLHER NYLON ARROZ 33,5CM CB CROMADO 424
Código: Fábrica: Unidade:
41351 HAUSKRAFT UN/1
F1 F4

UN: R\$ 12,32 AV: R\$ 12,32 15: R\$ 12,57
30: R\$ 12,82 45: R\$ 13,08 60: R\$ 13,34



COLHER NYLON BRANCA CB ACO 113-001
Código: Fábrica: Unidade:
41487 HERCULES UN/1
F1 F4

UN: R\$ 4,46 AV: R\$ 4,46 15: R\$ 4,56
30: R\$ 4,65 45: R\$ 4,74 60: R\$ 4,84



COLHER PLAST COLOR 24CM 1014
Código: Fábrica: Unidade:
36953 ENGIPLAST UN/1
F1 F4

UN: R\$ 4,70 AV: R\$ 4,70 15: R\$ 4,80
30: R\$ 4,89 45: R\$ 4,99 60: R\$ 5,09



COLHER PLAST COLOR 30CM 1015
Código: Fábrica: Unidade:
36954 ENGIPLAST UN/1
F1 F4

UN: R\$ 4,70 AV: R\$ 4,70 15: R\$ 4,80
30: R\$ 4,89 45: R\$ 4,99 60: R\$ 5,09



COLHER PLASTICA 36CM 1016
Código: Fábrica: Unidade:
36955 ENGIPLAST UN/1
F1 F4

UN: R\$ 4,27 AV: R\$ 4,27 15: R\$ 4,36
30: R\$ 4,45 45: R\$ 4,54 60: R\$ 4,63



COLHER PLAST COLOR 40CM 1017
Código: Fábrica: Unidade:
36956 ENGIPLAST UN/1
F1 F4

UN: R\$ 3,36 AV: R\$ 3,36 15: R\$ 3,43
30: R\$ 3,50 45: R\$ 3,57 60: R\$ 3,64



COLHER PLAST COLOR 5022
Código: Fábrica: Unidade:
31279 SBRISSA UN/1
F1 F4

UN: R\$ 7,95 AV: R\$ 7,95 15: R\$ 8,12
30: R\$ 8,28 45: R\$ 8,45 60: R\$ 8,61



COLHER PLAST P/SORVETE 19CM 290
Código: Fábrica: Unidade:
39241 DELTA UTIL UN/1
F1 F4

UN: R\$ 0,59 AV: R\$ 7,05 15: R\$ 7,20
30: R\$ 7,35 45: R\$ 7,49 60: R\$ 7,65



COLHER PLASTICA 17CM 12X1
Código: Fábrica: Unidade:
14580 ECOPLASTIC DZ/12
F1 F4

UN: R\$ 17,66 AV: R\$ 17,66 15: R\$ 18,03
30: R\$ 18,39 45: R\$ 18,76 60: R\$ 19,13



COLHER SILICONE ARROZ 27CM 110-11
Código: Fábrica: Unidade:
44772 NICOBEM UN/1
F1 F4

UN: R\$ 15,09 AV: R\$ 15,09 15: R\$ 15,57
30: R\$ 16,04 45: R\$ 16,52 60: R\$ 17,01



COLHER SILICONE VM CB ACO INOX 3098
Código: Fábrica: Unidade:
33822 SATYAM UN/1
F1 F4

UN: R\$ 12,32 AV: R\$ 12,32 15: R\$ 12,57
30: R\$ 12,82 45: R\$ 13,08 60: R\$ 13,34

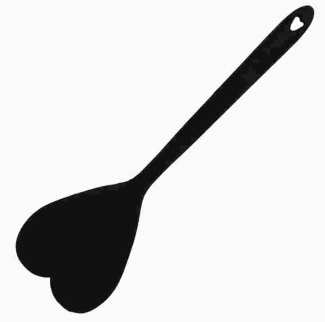

COLHER SILICONE 30X8,5CM CORCAO 9701
Código: Fábrica: Unidade:
50220 CASITA UN/1
F1 F4

UN: R\$ 5,77 AV: R\$ 5,77 15: R\$ 5,89
30: R\$ 6,01 45: R\$ 6,13 60: R\$ 6,25



COLHER+CONCHA NYLON PTO 5003 2X1
Código: Fábrica: Unidade:
18708 SBRISSA KT/1
F1 F4

UN: R\$ 2,89 AV: R\$ 5,77 15: R\$ 5,89
30: R\$ 6,01 45: R\$ 6,13 60: R\$ 6,25



COLHER+PEGADOR MACARRAO NYLON 5004 2X1
Código: Fábrica: Unidade:
18709 SBRISSA KT/2
F1 F4

UN: R\$ 2,67 AV: R\$ 2,67 15: R\$ 2,73
30: R\$ 2,78 45: R\$ 2,84 60: R\$ 2,90



COMEDOIRO PLAST P/CAES MINI AZUL 170ML
Código: Fábrica: Unidade:
24166 NUTRIPLAN UN/1
F1 F4

UN: R\$ 2,67 AV: R\$ 2,67 15: R\$ 2,73
30: R\$ 2,78 45: R\$ 2,84 60: R\$ 2,90



COMEDOIRO PLAST P/CAES MINI ROSA 170ML
Código: Fábrica: Unidade:
24164 NUTRIPLAN UN/1
F1 F4

UN: R\$ 6,07 AV: R\$ 6,07 15: R\$ 6,19
30: R\$ 6,32 45: R\$ 6,44 60: R\$ 6,57

 0,5 lts



COMEDOIRO PLAST PET 500 ML M COLOR
Código: Fábrica: Unidade:
40037 ANTARES UN/1
F1 F4

UN: R\$ 6,15 AV: R\$ 6,15 15: R\$ 6,28
30: R\$ 6,41 45: R\$ 6,53 60: R\$ 6,67

 25cm



CONCHA ACO INOX FEIJAO 25CM 059
Código: Fábrica: Unidade:
47490 PLANETA UN/1
F1 F4

UN: R\$ 9,07 AV: R\$ 9,07 15: R\$ 9,26
30: R\$ 9,44 45: R\$ 9,63 60: R\$ 9,83

 29cm



CONCHA ACO INOX MINI 29CM SAFIRA 160
Código: Fábrica: Unidade:
28768 PLANETA UN/1
F1 F4

UN: R\$ 13,34 AV: R\$ 13,34 15: R\$ 13,62
30: R\$ 13,89 45: R\$ 14,17 60: R\$ 14,46

 30cm



CONCHA ALUM BATIDO 30CM 2643
Código: Fábrica: Unidade:
45294 MSR UN/1
F1 F4

UN: R\$ 4,47 AV: R\$ 4,47 15: R\$ 4,56
30: R\$ 4,65 45: R\$ 4,75 60: R\$ 4,84

 27cm



CONCHA ALUM 27CM INTEIRICO 2020 UN
Código: Fábrica: Unidade:
48022 COFAX UN/1
F1 F4

UN: R\$ 4,92 AV: R\$ 4,92 15: R\$ 5,02
30: R\$ 5,12 45: R\$ 5,23 60: R\$ 5,33

 28cm



CONCHA ALUM 28CM CB MAD 2000 UN
Código: Fábrica: Unidade:
48019 COFAX UN/1
F1 F4

UN: R\$ 6,99 AV: R\$ 6,99 15: R\$ 7,13
30: R\$ 7,27 45: R\$ 7,42 60: R\$ 7,57

 33cm



CONCHA INOX CACIQUE 33CM 136
Código: Fábrica: Unidade:
39350 PLANETA UN/1
F1 F4

UN: R\$ 12,33 AV: R\$ 12,33 15: R\$ 12,58
30: R\$ 12,83 45: R\$ 13,09 60: R\$ 13,35

 32cm



CONCHA INOX COZINHA 32CM 700-42
Código: Fábrica: Unidade:
40534 CASA ONZE UN/1
F1 F4

UN: R\$ 18,08 AV: R\$ 18,08 15: R\$ 18,46
30: R\$ 18,82 45: R\$ 19,20 60: R\$ 19,59

 26 cm



CONCHA INOX FEIJAO 26 CM 147-48
Código: Fábrica: Unidade:
44770 NICOBEM UN/1
F1 F4

UN: R\$ 7,19 AV: R\$ 7,19 15: R\$ 7,34
30: R\$ 7,49 45: R\$ 7,64 60: R\$ 7,79

 23cm



CONCHA INOX SAFIRA 23CM 159
Código: Fábrica: Unidade:
39354 PLANETA UN/1
F1 F4

UN: R\$ 8,62 AV: R\$ 8,62 15: R\$ 8,80
30: R\$ 8,97 45: R\$ 9,15 60: R\$ 9,34

 23cm



CONCHA INOX VAZADA MINI 23CM SAFIRA 158
Código: Fábrica: Unidade:
39353 PLANETA UN/1
F1 F4

UN: R\$ 8,43 AV: R\$ 101,18 15: R\$ 103,29
30: R\$ 105,35 45: R\$ 107,46 60: R\$ 109,61

 30cm



CONCHA INOX 30CM FDO CB MAD 32 12X1
Código: Fábrica: Unidade:
38435 ARTE INOX DZ/12
F1 F4

UN: R\$ 10,27 AV: R\$ 61,62 15: R\$ 62,91
30: R\$ 64,16 45: R\$ 65,45 60: R\$ 66,76



CONCHA INOX 32CM FDO INTEIRICO 50 6X1

Código: 38433 Fábrica: ARTE INOX Unidade: PT/6
F1 F4

UN: R\$ 5,65 AV: R\$ 67,80 15: R\$ 69,21
30: R\$ 70,59 45: R\$ 72,00 60: R\$ 73,44



CONCHA INOX 32CM RASO CB MAD 33 12X1

Código: 38436 Fábrica: ARTE INOX Unidade: DZ/12
F1 F4

UN: R\$ 11,30 AV: R\$ 135,59 15: R\$ 138,42
30: R\$ 141,18 45: R\$ 144,01 60: R\$ 146,89



CONCHA INOX 36CM RS S/SOL CB MAD 63 12X1

Código: 38442 Fábrica: ARTE INOX Unidade: DZ/12
F1 F4

UN: R\$ 12,32 AV: R\$ 12,32 15: R\$ 12,57
30: R\$ 12,82 45: R\$ 13,08 60: R\$ 13,34



CONCHA NYLON BRANCA CB ACO 1103-002

Código: 41300 Fábrica: HERCULES Unidade: UN/1
F1 F4

UN: R\$ 21,19 AV: R\$ 21,19 15: R\$ 21,63
30: R\$ 22,07 45: R\$ 22,51 60: R\$ 22,96



CONCHA NYLON 33,2M CB CROMADO 069

Código: 41352 Fábrica: HAUSKRAFT Unidade: UN/1
F1 F4

UN: R\$ 3,24 AV: R\$ 3,24 15: R\$ 3,30
30: R\$ 3,37 45: R\$ 3,44 60: R\$ 3,51



CONCHA PERFORADA INOX 27CM 72005

Código: 38429 Fábrica: ALMEGA Unidade: UN/1
F1 F4

UN: R\$ 3,36 AV: R\$ 3,36 15: R\$ 3,43
30: R\$ 3,50 45: R\$ 3,57 60: R\$ 3,64



CONCHA PLAST COLOR 5023

Código: 31280 Fábrica: SBRISSA Unidade: UN/1
F1 F4

UN: R\$ 17,66 AV: R\$ 17,66 15: R\$ 18,03
30: R\$ 18,39 45: R\$ 18,76 60: R\$ 19,13



CONCHA SILICONE 28,5CM 110-12

Código: 44773 Fábrica: NICOBEM Unidade: UN/1
F1 F4

UN: R\$ 5,49 AV: R\$ 16,48 15: R\$ 16,82
30: R\$ 17,16 45: R\$ 17,50 60: R\$ 17,85



CONCHA+COLHER+PEGADOR MACARR NYLON 5021

Código: 18711 Fábrica: SBRISSA Unidade: KT/3
F1 F4

UN: R\$ 4,33 AV: R\$ 4,33 15: R\$ 4,43
30: R\$ 4,51 45: R\$ 4,60 60: R\$ 4,70



CONCHINHA PLAST MEDIDORA 150GRS 030

Código: 37881 Fábrica: BENEDETTI Unidade: UN/1
F1 F4

UN: R\$ 12,05 AV: R\$ 12,05 15: R\$ 12,30
30: R\$ 12,55 45: R\$ 12,80 60: R\$ 13,05



CONEXAO PLAST ENGATE RAPIDO MANGUEIR 213

Código: 40240 Fábrica: MONTEREY Unidade: UN/1
F1 F4

UN: R\$ 27,72 AV: R\$ 27,72 15: R\$ 28,30
30: R\$ 28,87 45: R\$ 29,45 60: R\$ 30,03



CONJ INOX P/SERVIR ARROZ 2PCS 152

Código: 41435 Fábrica: MADEFERINOX Unidade: CJ/1
F1 F4

UN: R\$ 27,72 AV: R\$ 27,72 15: R\$ 28,30
30: R\$ 28,87 45: R\$ 29,45 60: R\$ 30,03



CONJ INOX P/SERVIR FEIJAO 2PCS 153

Código: 41436 Fábrica: MADEFERINOX Unidade: CJ/1
F1 F4

UN: R\$ 27,72 AV: R\$ 27,72 15: R\$ 28,30
30: R\$ 28,87 45: R\$ 29,45 60: R\$ 30,03



CONJ INOX P/SERVIR MASSA 2PCS 150

Código: 41438 Fábrica: MADEFERINOX Unidade: CJ/1
F1 F4

UN: R\$ 27,72 AV: R\$ 27,72 15: R\$ 28,30
30: R\$ 28,87 45: R\$ 29,45 60: R\$ 30,03



CONJ INOX P/SERVIR SALADA 2PCS 155

Código: 41437 Fábrica: MADEFERINOX Unidade: CJ/1
F1 F4

UN: R\$ 19,51 AV: R\$ 19,51 15: R\$ 19,91
30: R\$ 20,31 45: R\$ 20,72 60: R\$ 21,13



CONJ INOX P/TORTA E BOLO 7PCS 42

Código: 41440 Fábrica: MADEFERINOX Unidade: CJ/1
F1 F4

UN: R\$ 190,19 AV: R\$ 190,19 15: R\$ 194,15
30: R\$ 198,03 45: R\$ 201,99 60: R\$ 206,03



CONJ PANELA ALUM EXTR 14/16/18/20/22 720

Código: Fábrika: Unidade:
35256 MSR CJ/1
F1 F4

UN: R\$ 16,44 AV: R\$ 16,44 15: R\$ 16,78
30: R\$ 17,11 45: R\$ 17,46 60: R\$ 17,80



CONJ P/COZINHA ABRIDOR+DESCACADOR 7652

Código: Fábrika: Unidade:
34805 IDEA CR/1
F1 F4

UN: R\$ 15,30 AV: R\$ 15,30 15: R\$ 15,62
30: R\$ 15,93 45: R\$ 16,25 60: R\$ 16,58



CONJ SOBREMESA VIDRO BOWLS 150ML 3PC 014

Código: Fábrika: Unidade:
49431 RIOHOME UN/1
F1 F4

UN: R\$ 2,57 AV: R\$ 30,81 15: R\$ 31,45
30: R\$ 32,08 45: R\$ 32,72 60: R\$ 33,37



CONJ TALHERES CB MAD CHURRASCO 6007 12X1

Código: Fábrika: Unidade:
44734 WINCY CJ/12
F1 F4

UN: R\$ 30,81 AV: R\$ 30,81 15: R\$ 31,45
30: R\$ 32,08 45: R\$ 32,72 60: R\$ 33,37



CONJ UTENSILIOS INOX 4PCS 809

Código: Fábrika: Unidade:
41439 MADEFERINOX CJ/1
F1 F4

UN: R\$ 77,45 AV: R\$ 77,45 15: R\$ 79,06
30: R\$ 80,65 45: R\$ 82,26 60: R\$ 83,90



CONJ 6 TACA VIDRO 300ML BERLIM TRANSP

Código: Fábrika: Unidade:
49428 RIOHOME UN/1
F1 F4

UN: R\$ 15,06 AV: R\$ 90,38 15: R\$ 92,27
30: R\$ 94,11 45: R\$ 95,99 60: R\$ 97,91



CONJ 6 TACA VIDRO 320ML DIAMOND TRANSP

Código: Fábrika: Unidade:
49804 FUTURO CASA CJ/6
F1 F4

UN: R\$ 10,27 AV: R\$ 61,62 15: R\$ 62,91
30: R\$ 64,16 45: R\$ 65,45 60: R\$ 66,76



CONJ 6 TACA VIDRO 330ML BICO JACA TRANSP

Código: Fábrika: Unidade:
48204 VIVA FLOR CJ/6
F1 F4

UN: R\$ 103,25 AV: R\$ 103,25 15: R\$ 105,41
30: R\$ 107,51 45: R\$ 109,66 60: R\$ 111,86



CONJ 6 TACA VIDRO 335ML MADRID TRANSP

Código: Fábrika: Unidade:
49429 RIOHOME UN/1
F1 F4

UN: R\$ 10,27 AV: R\$ 61,62 15: R\$ 62,91
30: R\$ 64,16 45: R\$ 65,45 60: R\$ 66,76



CONJ 6 TACA VIDRO 340ML DIAMANTE TRANSP

Código: Fábrika: Unidade:
48203 VIVA FLOR CJ/6
F1 F4

UN: R\$ 47,64 AV: R\$ 47,64 15: R\$ 48,63
30: R\$ 49,61 45: R\$ 50,60 60: R\$ 51,61



CONJ 6 XICARAS CAFE CERAM 90 ML S/PIR 54

Código: Fábrika: Unidade:
49434 RIOHOME CJ/1
F1 F4

UN: R\$ 61,62 AV: R\$ 61,62 15: R\$ 62,91
30: R\$ 64,16 45: R\$ 65,45 60: R\$ 66,76



CONJ 6 XICARAS CHA VID C/PIRES ALEXA 10A

Código: Fábrika: Unidade:
47416 DIAMONDS CJ/1
F1 F4

UN: R\$ 64,99 AV: R\$ 64,99 15: R\$ 64,99
30: R\$ 64,99 45: R\$ 64,99 60: R\$ 64,99



CONJ 6 XICARAS CHA VID C/PIRES BELLA 753

Código: Fábrika: Unidade:
47400 NUNESTAR CJ/1
F1 F4

UN: R\$ 82,17 AV: R\$ 82,17 15: R\$ 83,88
30: R\$ 85,56 45: R\$ 87,27 60: R\$ 89,01



CONJ 6 XICARAS CHA VID C/PIRES STAR8983

Código: Fábrika: Unidade:
47405 NUNESTAR CJ/1
F1 F4

UN: R\$ 82,17 AV: R\$ 82,17 15: R\$ 83,88
30: R\$ 85,56 45: R\$ 87,27 60: R\$ 89,01



CONJ 6 XICARAS CHA VID C/PIRES STAR8984

Código: Fábrika: Unidade:
47404 NUNESTAR CJ/1
F1 F4

UN: R\$ 82,17 AV: R\$ 82,17 15: R\$ 83,88
30: R\$ 85,56 45: R\$ 87,27 60: R\$ 89,01



CONJ 6 XICARAS CHA VID C/PIRES STAR8986

Código: Fábrika: Unidade:
47406 NUNESTAR CJ/1
F1 F4

UN: R\$ 64,99 AV: R\$ 64,99 15: R\$ 64,99
30: R\$ 64,99 45: R\$ 64,99 60: R\$ 64,99



CONJ 6 XICARAS CHA VID C/PIRES TULIP 748

Código: 47399 Fábrica: NUNESTAR Unidade: CJ/1
F1 F4

UN: R\$ 64,99 AV: R\$ 64,99 15: R\$ 64,99
30: R\$ 64,99 45: R\$ 64,99 60: R\$ 64,99



CONJ 6 XICARAS CHA VID C/PIRES VINO 793

Código: 47403 Fábrica: NUNESTAR Unidade: CJ/1
F1 F4

UN: R\$ 69,84 AV: R\$ 69,84 15: R\$ 71,29
30: R\$ 72,72 45: R\$ 74,17 60: R\$ 75,66



CONJ 6 XICARAS PORC C/PIRES CAFE CUPC 29

Código: 41332 Fábrica: HAUSKKRAFT Unidade: CJ/1
F1 F4

UN: R\$ 114,02 AV: R\$ 114,02 15: R\$ 116,39
30: R\$ 118,72 45: R\$ 121,10 60: R\$ 123,52



COOLER 10 LATAS 2674

Código: 45378 Fábrica: MSR Unidade: UN/1
F1 F4

UN: R\$ 266,03 AV: R\$ 266,03 15: R\$ 271,58
30: R\$ 277,01 45: R\$ 282,55 60: R\$ 288,20



COOLER 30 LATAS 2673

Código: 45377 Fábrica: MSR Unidade: UN/1
F1 F4

UN: R\$ 6,90 AV: R\$ 6,90 15: R\$ 7,05
30: R\$ 7,19 45: R\$ 7,33 60: R\$ 7,48



COPO ACRIL MEDIDOR GRADUADO 500ML 989

Código: 41641 Fábrica: QUALYPLAS Unidade: UN/1
F1 F4

UN: R\$ 10,26 AV: R\$ 10,26 15: R\$ 10,48
30: R\$ 10,69 45: R\$ 10,90 60: R\$ 11,12



COPO ALUM LEVE 300 ML LISO

Código: 34326 Fábrica: AVELAR Unidade: UN/1
F1 F4

UN: R\$ 6,15 AV: R\$ 6,15 15: R\$ 6,28
30: R\$ 6,41 45: R\$ 6,53 60: R\$ 6,67



COPO ALUM LISO 1285

Código: 37525 Fábrica: MSR Unidade: UN/1
F1 F4

UN: R\$ 8,71 AV: R\$ 8,71 15: R\$ 8,89
30: R\$ 9,07 45: R\$ 9,25 60: R\$ 9,44



COPO ALUM 200 ML 1423

Código: 37526 Fábrica: MSR Unidade: UN/1
F1 F4

UN: R\$ 16,23 AV: R\$ 16,23 15: R\$ 16,57
30: R\$ 16,90 45: R\$ 17,24 60: R\$ 17,58

14cm
290ml



COPO ALUM 290ML MUNICH MIX 76640

Código: 40401 Fábrica: UN-ART Unidade: UN/1
F1 F4

UN: R\$ 9,23 AV: R\$ 9,23 15: R\$ 9,43
30: R\$ 9,62 45: R\$ 9,81 60: R\$ 10,00



COPO ALUM 300 ML BRASIL

Código: 26860 Fábrica: AVELAR Unidade: UN/1
F1 F4

UN: R\$ 9,65 AV: R\$ 9,65 15: R\$ 9,85
30: R\$ 10,04 45: R\$ 10,24 60: R\$ 10,45



COPO ALUM 300 ML 666

Código: 35269 Fábrica: MSR Unidade: UN/1
F1 F4

UN: R\$ 16,23 AV: R\$ 16,23 15: R\$ 16,57
30: R\$ 16,90 45: R\$ 17,24 60: R\$ 17,58

13,5cm
410ml



COPO ALUM 410ML BERLIM MIX 76642

Código: 40402 Fábrica: UN-ART Unidade: UN/1
F1 F4

UN: R\$ 6,48 AV: R\$ 6,48 15: R\$ 6,61
30: R\$ 6,75 45: R\$ 6,88 60: R\$ 7,02



COPO CRISTAL PEQ TRANSP C/PISCA 70790/21

Código: 26452 Fábrica: Y888/HAI BRA Unidade: UN/1
F1 F4

UN: R\$ 12,32 AV: R\$ 12,32 15: R\$ 12,57
30: R\$ 12,82 45: R\$ 13,08 60: R\$ 13,34



COPO CRISTAL 550 ML GRADUADO TRANSP 1005

Código: 35493 Fábrica: TRITEC Unidade: UN/1
F1 F4

UN: R\$ 0,04 AV: R\$ 4,10 15: R\$ 4,18
30: R\$ 4,27 45: R\$ 4,35 60: R\$ 4,44



COPO DESCARTAVEL 50ML 100X1

Código: 50776 Fábrica: COPOPLAST Unidade: PT/100
F1 F4

UN: R\$ 0,07 AV: R\$ 7,18 15: R\$ 7,33
30: R\$ 7,48 45: R\$ 7,63 60: R\$ 7,78



COPO DESCARTAVEL 100ML (POTE) 100X1

Código: Fábrica: Unidade:
50294 COPOPLAST PT/100
F1 F4

UN: R\$ 0,09 AV: R\$ 9,23 15: R\$ 9,43
30: R\$ 9,62 45: R\$ 9,81 60: R\$ 10,00



COPO DESCARTAVEL 200ML 100X1

Código: Fábrica: Unidade:
47738 COPO MAIS/FL PT/100
F1 F4

UN: R\$ 123,26 AV: R\$ 123,26 15: R\$ 125,83
30: R\$ 128,35 45: R\$ 130,92 60: R\$ 133,53



COPO INOX TERM 500ML AZUL C/TPA ABRIDOR

Código: Fábrica: Unidade:
40662 INGA UN/1
F1 F4

UN: R\$ 123,26 AV: R\$ 123,26 15: R\$ 125,83
30: R\$ 128,35 45: R\$ 130,92 60: R\$ 133,53



COPO INOX TERM 500ML BRANCO C/TPA ABRIDOR

Código: Fábrica: Unidade:
40661 INGA UN/1
F1 F4

UN: R\$ 123,26 AV: R\$ 123,26 15: R\$ 125,83
30: R\$ 128,35 45: R\$ 130,92 60: R\$ 133,53



COPO INOX TERM 500ML CINZA C/TPA ABRIDOR

Código: Fábrica: Unidade:
40664 INGA UN/1
F1 F4

UN: R\$ 123,26 AV: R\$ 123,26 15: R\$ 125,83
30: R\$ 128,35 45: R\$ 130,92 60: R\$ 133,53



COPO INOX TERM 500ML ROSA C/TPA ABRIDOR

Código: Fábrica: Unidade:
40665 INGA UN/1
F1 F4

UN: R\$ 7,37 AV: R\$ 7,37 15: R\$ 7,52
30: R\$ 7,67 45: R\$ 7,82 60: R\$ 7,98



COPO INOX 500ML 14X8,5X8,5CM 110021

Código: Fábrica: Unidade:
39229 SATYAM UN/1
F1 F4

UN: R\$ 3,29 AV: R\$ 3,29 15: R\$ 3,36
30: R\$ 3,42 45: R\$ 3,49 60: R\$ 3,56



COPO LONG DRINK CRISTAL 2654 UN

Código: Fábrica: Unidade:
50677 TRITEC UN/1
F1 F4

UN: R\$ 3,25 AV: R\$ 38,99 15: R\$ 39,81
30: R\$ 40,60 45: R\$ 41,41 60: R\$ 42,24



COPO LONG DRINK CRISTAL 2654 12X1

Código: Fábrica: Unidade:
36234 TRITEC PT/12
F1 F4

UN: R\$ 5,09 AV: R\$ 5,09 15: R\$ 5,20
30: R\$ 5,30 45: R\$ 5,41 60: R\$ 5,51



COPO PLAST DEC 430ML DONUTS 1405

Código: Fábrica: Unidade:
40129 KOZI PLAST UN/1
F1 F4

UN: R\$ 5,09 AV: R\$ 5,09 15: R\$ 5,20
30: R\$ 5,30 45: R\$ 5,41 60: R\$ 5,51



COPO PLAST DEC 430ML FELIZ NATAL 1406

Código: Fábrica: Unidade:
40128 KOZI PLAST UN/1
F1 F4

UN: R\$ 2,03 AV: R\$ 2,03 15: R\$ 2,10
30: R\$ 2,16 45: R\$ 2,22 60: R\$ 2,29



COPO PLAST INF C/TPA BIQUEIRA 985

Código: Fábrica: Unidade:
20058 ERCAPLAST UN/1
F1 F4

UN: R\$ 5,94 AV: R\$ 5,94 15: R\$ 6,06
30: R\$ 6,18 45: R\$ 6,31 60: R\$ 6,43



COPO PLAST INF P/SUCO PLUS 100 ML 130

Código: Fábrica: Unidade:
14574 MAMITA UN/1
F1 F4

UN: R\$ 3,97 AV: R\$ 3,97 15: R\$ 4,05
30: R\$ 4,13 45: R\$ 4,21 60: R\$ 4,30



COPO PLAST INF 245ML C/TPA 1490

Código: Fábrica: Unidade:
47062 JAGUAR UN/1
F1 F4

UN: R\$ 2,29 AV: R\$ 27,45 15: R\$ 28,02
30: R\$ 28,58 45: R\$ 29,15 60: R\$ 29,74



COPO PLAST INF 250 ML DEC 8017 12X1

Código: Fábrica: Unidade:
35221 SBRISSA PT/12
F1 F4

UN: R\$ 1,47 AV: R\$ 17,66 15: R\$ 18,03
30: R\$ 18,39 45: R\$ 18,76 60: R\$ 19,13



COPO PLAST INF 250 ML 7001 12X1

Código: Fábrica: Unidade:
9797 SBRISSA PT/12
F1 F4

UN: R\$ 4,12 AV: R\$ 41,22 15: R\$ 42,08
30: R\$ 42,92 45: R\$ 43,78 60: R\$ 44,66



COPO PLAST INF 250ML C/BIC DEC 8018 10X1
Código: 35216 Fábrica: SBRISSA Unidade: PT/10 F1 F4

UN: R\$ 2,71 AV: R\$ 27,08 15: R\$ 27,65
30: R\$ 28,20 45: R\$ 28,76 60: R\$ 29,34



COPO PLAST INF 250ML C/BICO 7011 10X1
Código: 31286 Fábrica: SBRISSA Unidade: PT/10 F1 F4

UN: R\$ 2,74 AV: R\$ 2,74 15: R\$ 2,80
30: R\$ 2,86 45: R\$ 2,91 60: R\$ 2,97



COPO PLAST INF 300 ML COLOR U020
Código: 45740 Fábrica: APAS Unidade: UN/1 F1 F4

UN: R\$ 5,43 AV: R\$ 5,43 15: R\$ 5,55
30: R\$ 5,66 45: R\$ 5,77 60: R\$ 5,89



COPO PLAST INF 300 ML C/TAMPA COLOR U060
Código: 45742 Fábrica: APAS Unidade: UN/1 F1 F4

UN: R\$ 4,98 AV: R\$ 4,98 15: R\$ 5,09
30: R\$ 5,19 45: R\$ 5,29 60: R\$ 5,40



COPO PLAST INF 300 ML C/TAMPA COLOR U061
Código: 45741 Fábrica: APAS Unidade: UN/1 F1 F4

UN: R\$ 58,89 AV: R\$ 58,89 15: R\$ 60,12
30: R\$ 61,32 45: R\$ 62,55 60: R\$ 63,80



COPO PLAST INOX 450ML FLAMENGO 2885
Código: 39042 Fábrica: BRASFOOT Unidade: UN/1 F1 F4

UN: R\$ 58,89 AV: R\$ 58,89 15: R\$ 60,12
30: R\$ 61,32 45: R\$ 62,55 60: R\$ 63,80



COPO PLAST INOX 450ML MEU GAME FORT 1154
Código: 39038 Fábrica: BRASFOOT Unidade: UN/1 F1 F4

UN: R\$ 1,68 AV: R\$ 1,68 15: R\$ 1,72
30: R\$ 1,75 45: R\$ 1,79 60: R\$ 1,83



COPO PLAST LONG DRINK 200ML AMARELO 2285
Código: 40101 Fábrica: MASSARI Unidade: UN/1 F1 F4

UN: R\$ 1,68 AV: R\$ 1,68 15: R\$ 1,72
30: R\$ 1,75 45: R\$ 1,79 60: R\$ 1,83



COPO PLAST LONG DRINK 200ML AZUL 2283
Código: 40100 Fábrica: MASSARI Unidade: UN/1 F1 F4

UN: R\$ 1,68 AV: R\$ 1,68 15: R\$ 1,72
30: R\$ 1,75 45: R\$ 1,79 60: R\$ 1,83



COPO PLAST LONG DRINK 200ML BRANCO 2281
Código: 40098 Fábrica: MASSARI Unidade: UN/1 F1 F4

UN: R\$ 1,68 AV: R\$ 1,68 15: R\$ 1,72
30: R\$ 1,75 45: R\$ 1,79 60: R\$ 1,83



COPO PLAST LONG DRINK 200ML CRISTAL 2280
Código: 40104 Fábrica: MASSARI Unidade: UN/1 F1 F4

UN: R\$ 1,68 AV: R\$ 1,68 15: R\$ 1,72
30: R\$ 1,75 45: R\$ 1,79 60: R\$ 1,83

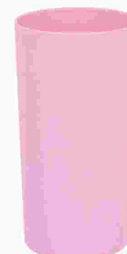

COPO PLAST LONG DRINK 200ML ROSA 2282
Código: 40102 Fábrica: MASSARI Unidade: UN/1 F1 F4

UN: R\$ 1,68 AV: R\$ 1,68 15: R\$ 1,72
30: R\$ 1,75 45: R\$ 1,79 60: R\$ 1,83



COPO PLAST LONG DRINK 200ML VERMELH 2284
Código: 40103 Fábrica: MASSARI Unidade: UN/1 F1 F4

UN: R\$ 2,59 AV: R\$ 2,59 15: R\$ 2,65
30: R\$ 2,70 45: R\$ 2,75 60: R\$ 2,81



COPO PLAST LONG DRINK 350ML CANDY 1317
Código: 38132 Fábrica: KRIA KOISAS Unidade: UN/1 F1 F4

UN: R\$ 4,30 AV: R\$ 4,30 15: R\$ 4,39
30: R\$ 4,48 45: R\$ 4,57 60: R\$ 4,66



COPO PLAST MEDIDA TRANSP 5509
Código: 41667 Fábrica: INPLAST Unidade: UN/1 F1 F4

UN: R\$ 11,81 AV: R\$ 11,81 15: R\$ 12,06
30: R\$ 12,30 45: R\$ 12,55 60: R\$ 12,80



COPO PLAST P/CAIPIRINHA PEQ C/PILAO 403
Código: 33036 Fábrica: TRITEC Unidade: UN/1 F1 F4

UN: R\$ 2,83 AV: R\$ 16,96 15: R\$ 17,32
30: R\$ 17,66 45: R\$ 18,02 60: R\$ 18,38
108 cm



COPO PLAST RETRATIL 8734 6X1

Código: Fábrika: Unidade:
36117 PLASTSANDRI PT/6
F1 F4

UN: R\$ 38,86 AV: R\$ 38,86 15: R\$ 39,67
30: R\$ 40,47 45: R\$ 41,28 60: R\$ 42,10



COPO PLAST TERMICO 200ML ATLETICO 2419

Código: Fábrika: Unidade:
39040 BRASFOOT UN/1
F1 F4

UN: R\$ 1,94 AV: R\$ 7,75 15: R\$ 7,91
30: R\$ 8,06 45: R\$ 8,23 60: R\$ 8,39



COPO PLAST 350ML CONJ 0008 4X1

Código: Fábrika: Unidade:
6187 JAGUAR CJ/4
F1 F4

UN: R\$ 1,84 AV: R\$ 1,84 15: R\$ 1,88
30: R\$ 1,91 45: R\$ 1,95 60: R\$ 1,99



COPO PLAST 350ML 0505

Código: Fábrika: Unidade:
47058 JAGUAR UN/1
F1 F4

UN: R\$ 10,55 AV: R\$ 10,55 15: R\$ 10,77
30: R\$ 10,98 45: R\$ 11,20 60: R\$ 11,43



COPO PLAST 600ML C/TP CANUDO GUERREI 900

Código: Fábrika: Unidade:
42757 LUMAR UN/1
F1 F4

UN: R\$ 10,55 AV: R\$ 10,55 15: R\$ 10,77
30: R\$ 10,98 45: R\$ 11,20 60: R\$ 11,43



COPO PLAST 600ML C/TP CANUDO PRINCES 901

Código: Fábrika: Unidade:
42759 LUMAR UN/1
F1 F4

UN: R\$ 10,55 AV: R\$ 10,55 15: R\$ 10,77
30: R\$ 10,98 45: R\$ 11,20 60: R\$ 11,43



COPO PLAST 600ML C/TP CANUDO SPIDER 899

Código: Fábrika: Unidade:
42756 LUMAR UN/1
F1 F4

UN: R\$ 10,55 AV: R\$ 10,55 15: R\$ 10,77
30: R\$ 10,98 45: R\$ 11,20 60: R\$ 11,43



COPO PLAST 600ML C/TP CANUDO UNICORN 902

Código: Fábrika: Unidade:
42758 LUMAR UN/1
F1 F4

UN: R\$ 71,89 AV: R\$ 71,89 15: R\$ 73,39
30: R\$ 74,86 45: R\$ 76,36 60: R\$ 77,88



COPO TERM INOX 450ML 18X8CM 3696

Código: Fábrika: Unidade:
41459 MABEL UN/1
F1 F4

UN: R\$ 152,02 AV: R\$ 152,02 15: R\$ 155,18
30: R\$ 158,29 45: R\$ 161,45 60: R\$ 164,68



COPO TERM 500ML STONE ATLETICO 10675

Código: Fábrika: Unidade:
41149 BRASFOOT UN/1
F1 F4

UN: R\$ 152,02 AV: R\$ 152,02 15: R\$ 155,18
30: R\$ 158,29 45: R\$ 161,45 60: R\$ 164,68



COPO TERM 500ML STONE CRUZEIRO 10676

Código: Fábrika: Unidade:
41148 BRASFOOT UN/1
F1 F4

UN: R\$ 3,18 AV: R\$ 38,21 15: R\$ 39,01
30: R\$ 39,79 45: R\$ 40,58 60: R\$ 41,40
6 cm
50 ml



COPO VIDRO 50ML TRANSP 732 12X1

Código: Fábrika: Unidade:
40228 HAI BRASIL CJ/12
F1 F4

UN: R\$ 4,06 AV: R\$ 389,55 15: R\$ 397,66
30: R\$ 405,61 45: R\$ 413,73 60: R\$ 422,00
9 cm
4 cm
74 ml



COPO VIDRO 74ML SHOT LEXINGTO 1063 96X1

Código: Fábrika: Unidade:
39521 MULTIPRESENT CX/96
F1 F4

UN: R\$ 15,40 AV: R\$ 15,40 15: R\$ 15,72
30: R\$ 16,03 45: R\$ 16,35 60: R\$ 16,68



COPO VIDRO AMERICANO 190ML ATLETICO10845

Código: Fábrika: Unidade:
41111 BRASFOOT UN/1
F1 F4

UN: R\$ 15,40 AV: R\$ 15,40 15: R\$ 15,72
30: R\$ 16,03 45: R\$ 16,35 60: R\$ 16,68



COPO VIDRO AMERICANO 190ML CRUZEIRO10846

Código: Fábrika: Unidade:
41110 BRASFOOT UN/1
F1 F4

UN: R\$ 1,80 AV: R\$ 43,13 15: R\$ 44,03
30: R\$ 44,91 45: R\$ 45,81 60: R\$ 46,73



COPO VIDRO AMERICANO 190ML 24X1

Código: Fábrika: Unidade:
47410 NADIR CX/24
F1 F4

UN: R\$ 3,85 AV: R\$ 92,44 15: R\$ 94,36
30: R\$ 96,25 45: R\$ 98,18 60: R\$ 100,14



COPO VIDRO AMERICANO 300ML 24X1

Código: Fábrika: Unidade:
50369 NADIR CX/24
F1 F4

UN: R\$ 30,81 AV: R\$ 30,81 15: R\$ 31,45
30: R\$ 32,08 45: R\$ 32,72 60: R\$ 33,37



COPO VIDRO CAIPIRINHA FLAMENGO 9059

Código: Fábrika: Unidade:
39013 BRASFOOT UN/1
F1 F4

UN: R\$ 61,62 AV: R\$ 61,62 15: R\$ 62,91
30: R\$ 64,16 45: R\$ 65,45 60: R\$ 66,76



COPO VIDRO CONJ CAIPIRINHA CRUZEIRO 2426

Código: Fábrika: Unidade:
39123 BRASFOOT UN/1
F1 F4

UN: R\$ 61,62 AV: R\$ 61,62 15: R\$ 62,91
30: R\$ 64,16 45: R\$ 65,45 60: R\$ 66,76



COPO VIDRO CONJ CAIPIRINHA FLAMENGO 2429

Código: Fábrika: Unidade:
39267 BRASFOOT UN/1
F1 F4

UN: R\$ 15,40 AV: R\$ 15,40 15: R\$ 15,72
30: R\$ 16,03 45: R\$ 16,35 60: R\$ 16,68



COPO VIDRO DOSE 60ML ATLETICO 2340

Código: Fábrika: Unidade:
39121 BRASFOOT UN/1
F1 F4

UN: R\$ 10,26 AV: R\$ 10,26 15: R\$ 10,48
30: R\$ 10,69 45: R\$ 10,90 60: R\$ 11,12



COPO VIDRO DOSE 60ML FRASE DE BOTECO3916

Código: Fábrika: Unidade:
39018 BRASFOOT UN/1
F1 F4

UN: R\$ 10,26 AV: R\$ 10,26 15: R\$ 10,48
30: R\$ 10,69 45: R\$ 10,90 60: R\$ 11,12



COPO VIDRO DOSE 60ML HARLEY DAVIDSON 2935

Código: Fábrika: Unidade:
39019 BRASFOOT UN/1
F1 F4

UN: R\$ 10,26 AV: R\$ 10,26 15: R\$ 10,48
30: R\$ 10,69 45: R\$ 10,90 60: R\$ 11,12



COPO VIDRO DOSE 60ML PERAQUEFALTA 1648

Código: Fábrika: Unidade:
39021 BRASFOOT UN/1
F1 F4

UN: R\$ 41,08 AV: R\$ 41,08 15: R\$ 41,93
30: R\$ 42,77 45: R\$ 43,63 60: R\$ 44,50



COPO VIDRO WHISKY ATOL 310ML ATLET 11220

Código: Fábrika: Unidade:
41146 BRASFOOT UN/1
F1 F4

UN: R\$ 41,08 AV: R\$ 41,08 15: R\$ 41,93
30: R\$ 42,77 45: R\$ 43,63 60: R\$ 44,50



COPO VIDRO WHISKY ATOL 310ML CRUZE 11221

Código: Fábrika: Unidade:
41147 BRASFOOT UN/1
F1 F4

UN: R\$ 35,94 AV: R\$ 35,94 15: R\$ 36,69
30: R\$ 37,42 45: R\$ 38,17 60: R\$ 38,94



COPO VIDRO WHISKY ATOL 310ML POKER 4524

Código: Fábrika: Unidade:
39016 BRASFOOT UN/1
F1 F4

UN: R\$ 51,35 AV: R\$ 51,35 15: R\$ 52,42
30: R\$ 53,47 45: R\$ 54,54 60: R\$ 55,63



COPO VIDRO 145ML SCALE 017 6X1

Código: Fábrika: Unidade:
49437 RIOHOME CX/1
F1 F4

UN: R\$ 2,83 AV: R\$ 16,99 15: R\$ 16,99
30: R\$ 16,99 45: R\$ 16,99 60: R\$ 16,99



COPO VIDRO 180 ML TRANSP 18899 6X1

Código: Fábrika: Unidade:
48719 WELLMIX CJ/6
F1 F4

UN: R\$ 2,83 AV: R\$ 16,99 15: R\$ 16,99
30: R\$ 16,99 45: R\$ 16,99 60: R\$ 16,99



COPO VIDRO 180 ML TRANSP 18903 6X1

Código: Fábrika: Unidade:
48717 WELLMIX CJ/6
F1 F4

UN: R\$ 2,83 AV: R\$ 16,99 15: R\$ 16,99
30: R\$ 16,99 45: R\$ 16,99 60: R\$ 16,99



COPO VIDRO 180 ML TRANSP 18905 6X1

Código: Fábrika: Unidade:
48718 WELLMIX CJ/6
F1 F4

UN: R\$ 23,62 AV: R\$ 23,62 15: R\$ 24,11
30: R\$ 24,59 45: R\$ 25,08 60: R\$ 25,58



COPO VIDRO 200ML MUNICH DRAHMA 1255

Código: Fábrika: Unidade:
39035 BRASFOOT UN/1
F1 F4

UN: R\$ 14,99 AV: R\$ 14,99 15: R\$ 14,99
30: R\$ 14,99 45: R\$ 14,99 60: R\$ 14,99



COPO VIDRO 200ML MUNICH MIX 14269
Código: Fábrika: Unidade:
40397 UN-ART UN/1
F1 F4

UN: R\$ 23,62 AV: R\$ 23,62 15: R\$ 24,11
30: R\$ 24,59 45: R\$ 25,08 60: R\$ 25,58



COPO VIDRO 200ML MUNICH SO VOU 1259
Código: Fábrika: Unidade:
39037 BRASFOOT UN/1
F1 F4

UN: R\$ 3,78 AV: R\$ 227,01 15: R\$ 231,74
30: R\$ 236,38 45: R\$ 241,10 60: R\$ 245,93



COPO VIDRO 207 ML TRANSP 60X1
Código: Fábrika: Unidade:
39324 FUTURO CJ/60
F1 F4

UN: R\$ 9,24 AV: R\$ 36,98 15: R\$ 37,75
30: R\$ 38,50 45: R\$ 39,27 60: R\$ 40,06



COPO VIDRO 250ML TRENTO CUBIC 943764 6X1
Código: Fábrika: Unidade:
40891 CEDAR GLASS CJ/4
F1 F4

UN: R\$ 9,24 AV: R\$ 36,98 15: R\$ 37,75
30: R\$ 38,50 45: R\$ 39,27 60: R\$ 40,06



COPO VIDRO 250ML TRENTO ROMAN 943765 6X1
Código: Fábrika: Unidade:
40783 CEDAR GLASS CJ/4
F1 F4

UN: R\$ 9,24 AV: R\$ 36,98 15: R\$ 37,75
30: R\$ 38,50 45: R\$ 39,27 60: R\$ 40,06



COPO VIDRO 290ML TRENTO SMALL 943762 6X1
Código: Fábrika: Unidade:
40890 CEDAR GLASS CJ/4
F1 F4

UN: R\$ 6,78 AV: R\$ 135,59 15: R\$ 138,42
30: R\$ 141,18 45: R\$ 144,01 60: R\$ 146,89



COPO VIDRO 300ML CHOPP ROSTOCK 1035 20X1
Código: Fábrika: Unidade:
51078 MULTIPRESENT CX/20
F1 F4

UN: R\$ 6,76 AV: R\$ 162,30 15: R\$ 165,68
30: R\$ 168,99 45: R\$ 172,37 60: R\$ 175,82



COPO VIDRO 300ML CHOPP ROSTOCK 1035 24X1
Código: Fábrika: Unidade:
39531 MULTIPRESENT CX/24
F1 F4

UN: R\$ 5,01 AV: R\$ 360,86 15: R\$ 368,37
30: R\$ 375,74 45: R\$ 383,26 60: R\$ 390,92



COPO VIDRO 340ML ALTO MONTECAR 1193 72X1
Código: Fábrika: Unidade:
39529 MULTIPRESENT CX/72
F1 F4

UN: R\$ 6,16 AV: R\$ 443,75 15: R\$ 453,00
30: R\$ 462,06 45: R\$ 471,30 60: R\$ 480,72



COPO VIDRO 348ML ALTO ALEGRO 1053 72X1
Código: Fábrika: Unidade:
39525 MULTIPRESENT CX/72
F1 F4

UN: R\$ 6,31 AV: R\$ 151,36 15: R\$ 154,51
30: R\$ 157,60 45: R\$ 160,75 60: R\$ 163,97



COPO VIDRO 350ML CHOPP TRANSP VD52 24X1
Código: Fábrika: Unidade:
40300 MAXXIMUS CX/24
F1 F4

UN: R\$ 43,52 AV: R\$ 43,52 15: R\$ 44,43
30: R\$ 45,32 45: R\$ 46,22 60: R\$ 47,15



COQUETELEIRA INOX 500 ML 924
Código: Fábrika: Unidade:
50068 PLANETA UN/1
F1 F4

UN: R\$ 25,91 AV: R\$ 25,91 15: R\$ 26,45
30: R\$ 26,97 45: R\$ 27,51 60: R\$ 28,06



COQUETELEIRA PLAST 600ML NOW OR NERVER75
Código: Fábrika: Unidade:
39137 BRASFOOT UN/1
F1 F4

UN: R\$ 25,91 AV: R\$ 25,91 15: R\$ 26,45
30: R\$ 26,97 45: R\$ 27,51 60: R\$ 28,06



COQUETELEIRA PLAST 600ML PUSH YOUR LIMIT
Código: Fábrika: Unidade:
39138 BRASFOOT UN/1
F1 F4

UN: R\$ 25,91 AV: R\$ 25,91 15: R\$ 26,45
30: R\$ 26,97 45: R\$ 27,51 60: R\$ 28,06



COQUETELEIRA PLAST 600ML TODA CONQUISTA
Código: Fábrika: Unidade:
39139 BRASFOOT UN/1
F1 F4

UN: R\$ 25,91 AV: R\$ 25,91 15: R\$ 26,45
30: R\$ 26,97 45: R\$ 27,51 60: R\$ 28,06



COQUETELEIRA PLAST 600ML TREINE COMO UMA
Código: Fábrika: Unidade:
39140 BRASFOOT UN/1
F1 F4

UN: R\$ 297,50 AV: R\$ 297,50 15: R\$ 303,70
30: R\$ 309,77 45: R\$ 315,96 60: R\$ 322,28

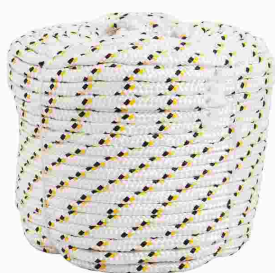

CORDA TRANCADA 14MM 50 MTS 4,5KG
Código: Fábrika: Unidade:
46809 VONDER RL/1
F1 F4

UN: R\$ 3,34 AV: R\$ 40,06 15: R\$ 40,90
30: R\$ 41,71 45: R\$ 42,55 60: R\$ 43,40



CORDA VARAL ACO ENCAPADO 10 MTS 12X1
Código: Fábrika: Unidade:
29842 DEL WAL PT/12
F1 F4

UN: R\$ 5,21 AV: R\$ 62,54 15: R\$ 63,84
30: R\$ 65,12 45: R\$ 66,42 60: R\$ 67,75



CORDA VARAL ACO ENCAPADO 15 MTS 12X1
Código: Fábrika: Unidade:
29843 DEL WAL PT/12
F1 F4

UN: R\$ 6,68 AV: R\$ 80,12 15: R\$ 81,79
30: R\$ 83,43 45: R\$ 85,10 60: R\$ 86,80



CORDA VARAL ACO ENCAPADO 20 MTS 12X1
Código: Fábrika: Unidade:
29844 DEL WAL PT/12
F1 F4

UN: R\$ 5,13 AV: R\$ 5,13 15: R\$ 5,23
30: R\$ 5,34 45: R\$ 5,44 60: R\$ 5,55



CORDA VARAL NYLON 3MM 10 MTS 1540
Código: Fábrika: Unidade:
41539 ELITE UN/1
F1 F4

UN: R\$ 6,15 AV: R\$ 6,15 15: R\$ 6,28
30: R\$ 6,41 45: R\$ 6,53 60: R\$ 6,67



CORDA VARAL NYLON 4MM 10 MTS 2938
Código: Fábrika: Unidade:
41545 ELITE UN/1
F1 F4

UN: R\$ 9,96 AV: R\$ 9,96 15: R\$ 10,17
30: R\$ 10,37 45: R\$ 10,58 60: R\$ 10,79



CORDA VARAL NYLON 5MM 20 MTS 3556
Código: Fábrika: Unidade:
49628 WINMAX UN/1
F1 F4

UN: R\$ 3,34 AV: R\$ 3,34 15: R\$ 3,41
30: R\$ 3,48 45: R\$ 3,55 60: R\$ 3,62



CORDA VARAL PLAST MULTI USO 5 MTS 93003
Código: Fábrika: Unidade:
45877 ALMEGA UN/1
F1 F4

UN: R\$ 5,13 AV: R\$ 5,13 15: R\$ 5,23
30: R\$ 5,34 45: R\$ 5,44 60: R\$ 5,55



CORDA VARAL PLAST MULTI USO 10 MTS 93002
Código: Fábrika: Unidade:
34656 ALMEGA UN/1
F1 F4

UN: R\$ 7,76 AV: R\$ 7,76 15: R\$ 7,92
30: R\$ 8,08 45: R\$ 8,24 60: R\$ 8,40



CORDA VARAL PLAST 5MM 10 MTS 93002
Código: Fábrika: Unidade:
45529 WINMAX UN/1
F1 F4

UN: R\$ 4,61 AV: R\$ 4,61 15: R\$ 4,71
30: R\$ 4,80 45: R\$ 4,90 60: R\$ 5,00



CORDA VARAL POLIESTER 15 MTS UNIVERS 614
Código: Fábrika: Unidade:
46871 PLANETA UN/1
F1 F4

UN: R\$ 17,46 AV: R\$ 17,46 15: R\$ 17,83
30: R\$ 18,18 45: R\$ 18,55 60: R\$ 18,92
70 cm

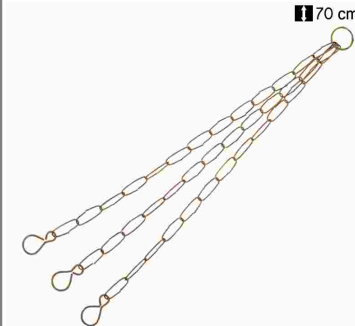

CORRENTAO METAL DOURADA XAXIM 70CM
Código: Fábrika: Unidade:
39471 WS CORRENTES UN/1
F1 F4

UN: R\$ 14,38 AV: R\$ 172,57 15: R\$ 176,16
30: R\$ 179,69 45: R\$ 183,28 60: R\$ 186,95
70 cm



CORRENTAO METAL DOURADA XAXIM 70CM 12X1
Código: Fábrika: Unidade:
39470 WS CORRENTES PT/12
F1 F4

UN: R\$ 10,27 AV: R\$ 123,25 15: R\$ 125,82
30: R\$ 128,34 45: R\$ 130,90 60: R\$ 133,52
84 cm



CORRENTE METAL DOURADA XAXIM 84CM 12X1
Código: Fábrika: Unidade:
39472 WS CORRENTES PT/12
F1 F4

UN: R\$ 9,50 AV: R\$ 9,50 15: R\$ 9,70
30: R\$ 9,89 45: R\$ 10,09 60: R\$ 10,29



CORTADOR INOX MELANCIA 25,5CM 3029
Código: Fábrika: Unidade:
44730 WINCY UN/1
F1 F4

UN: R\$ 8,72 AV: R\$ 8,72 15: R\$ 8,90
30: R\$ 9,08 45: R\$ 9,26 60: R\$ 9,45



CORTADOR INOX PASTEL CACIQUE 19,5CM 145
Código: Fábrika: Unidade:
39356 PLANETA UN/1
F1 F4

UN: R\$ 8,72 AV: R\$ 8,72 15: R\$ 8,90
30: R\$ 9,08 45: R\$ 9,26 60: R\$ 9,45

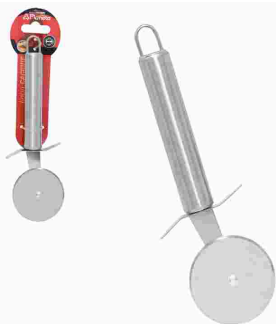

CORTADOR INOX PIZZA CACIQUE 20,5CM 146

Código: Fábrica: Unidade:
39355 PLANETA UN/1
F1 F4

UN: R\$ 7,18 AV: R\$ 7,18 15: R\$ 7,33
30: R\$ 7,48 45: R\$ 7,63 60: R\$ 7,78



CORTADOR INOX QUEIJO 22X7,5CM 147-103

Código: Fábrica: Unidade:
47149 NICOBEM UN/1
F1 F4

UN: R\$ 20,70 AV: R\$ 20,70 15: R\$ 21,13
30: R\$ 21,55 45: R\$ 21,98 60: R\$ 22,42

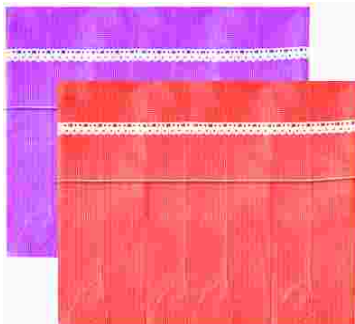

CORTINA P/PIA P 120X90CM

Código: Fábrica: Unidade:
11294 FERREIRA UN/1
F1 F4

UN: R\$ 9,23 AV: R\$ 9,23 15: R\$ 9,43
30: R\$ 9,62 45: R\$ 9,81 60: R\$ 10,00



CUMBUCA BARRO 300 ML RED

Código: Fábrica: Unidade:
30157 AVELAR UN/1
F4

UN: R\$ 10,26 AV: R\$ 10,26 15: R\$ 10,48
30: R\$ 10,69 45: R\$ 10,90 60: R\$ 11,12



CUMBUCA BARRO 400 ML RED

Código: Fábrica: Unidade:
36288 AVELAR UN/1
F1 F4

UN: R\$ 3,28 AV: R\$ 3,28 15: R\$ 3,35
30: R\$ 3,41 45: R\$ 3,48 60: R\$ 3,55



CUMBUCA PLAST 500 ML OVAL 11X15CM 683

Código: Fábrica: Unidade:
50343 QUALYPLAS UN/1
F1 F4

UN: R\$ 5,82 AV: R\$ 5,82 15: R\$ 5,95
30: R\$ 6,06 45: R\$ 6,19 60: R\$ 6,31



CUMBUCA PLAST 650 ML COLOR 907

Código: Fábrica: Unidade:
42762 LUMAR UN/1
F1 F4

UN: R\$ 35,94 AV: R\$ 35,94 15: R\$ 36,69
30: R\$ 37,42 45: R\$ 38,17 60: R\$ 38,94



CUSCUZEIRO ALUM 14 1147

Código: Fábrica: Unidade:
35271 MSR UN/1
F1 F4

UN: R\$ 42,89 AV: R\$ 42,89 15: R\$ 43,78
30: R\$ 44,65 45: R\$ 45,55 60: R\$ 46,46



CUSCUZEIRO ALUM 16 668

Código: Fábrica: Unidade:
35272 MSR UN/1
F1 F4

UN: R\$ 47,24 AV: R\$ 47,24 15: R\$ 48,23
30: R\$ 49,19 45: R\$ 50,17 60: R\$ 51,18



CUSCUZEIRO ALUM 18 669

Código: Fábrica: Unidade:
35273 MSR UN/1
F1 F4

UN: R\$ 4,41 AV: R\$ 4,41 15: R\$ 4,50
30: R\$ 4,59 45: R\$ 4,68 60: R\$ 4,77



DEBULHADOR PLAST MILHO 11,5X7CM 3204

Código: Fábrica: Unidade:
44724 WINCY UN/1
F1 F4

UN: R\$ 11,45 AV: R\$ 11,45 15: R\$ 11,69
30: R\$ 11,92 45: R\$ 12,16 60: R\$ 12,40



DECORADOR PLAST P/BOLO C/8 BICOS 7139

Código: Fábrica: Unidade:
38346 ALIANCA UN/1
F1 F4

UN: R\$ 6,93 AV: R\$ 6,93 15: R\$ 7,08
30: R\$ 7,22 45: R\$ 7,36 60: R\$ 7,51

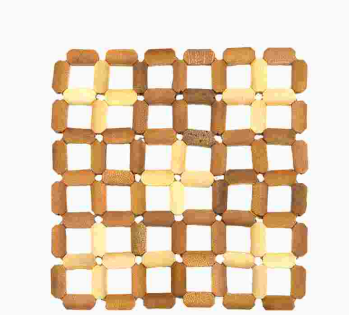

DESCANSO P/PANELAS BAMBU (ESTEIRA) 14752

Código: Fábrica: Unidade:
44524 NICOBEM UN/1
F1 F4

UN: R\$ 7,26 AV: R\$ 7,26 15: R\$ 7,41
30: R\$ 7,56 45: R\$ 7,71 60: R\$ 7,87

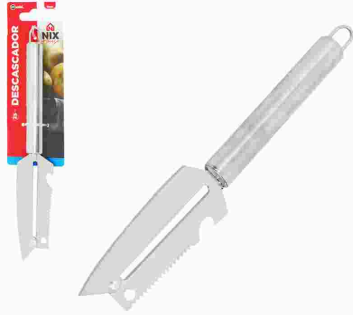

DESCASCADOR FATIAD INOX 25CM LEGUMES 063

Código: Fábrica: Unidade:
47334 NIX UN/1
F1 F4

UN: R\$ 8,21 AV: R\$ 8,21 15: R\$ 8,38
30: R\$ 8,55 45: R\$ 8,72 60: R\$ 8,89



DESCASCADOR MANUAL FRUTAS LEGUMES 147-57

Código: Fábrica: Unidade:
46740 NICOBEM UN/1
F1 F4

UN: R\$ 7,69 AV: R\$ 7,69 15: R\$ 7,85
30: R\$ 8,01 45: R\$ 8,17 60: R\$ 8,33



DESENTUPIDOR DE PIA SANFONADO 5033

Código: Fábrica: Unidade:
47251 SHANGRILA UN/1
F1 F4

UN: R\$ 11,29 AV: R\$ 11,29 15: R\$ 11,52
30: R\$ 11,75 45: R\$ 11,99 60: R\$ 12,23



DESENTUPIDOR SANITARIO WC 332

Código: 5544 Fábrica: N.HORIZONTE Unidade: UN/1 F1 F4

UN: R\$ 5,14 AV: R\$ 5,14 15: R\$ 5,24
30: R\$ 5,35 45: R\$ 5,45 60: R\$ 5,56



DISPENSADOR VIDRO 210ML ACUCAR 18394

Código: 40902 Fábrica: FUTURO Unidade: UN/1 F1 F4

UN: R\$ 66,76 AV: R\$ 66,76 15: R\$ 68,15
30: R\$ 69,51 45: R\$ 70,90 60: R\$ 72,32



DISPENSER INOX CILIND P/COPO AGUA 200ML

Código: 41851 Fábrica: AURIMAR Unidade: UN/1 F1 F4

UN: R\$ 41,08 AV: R\$ 41,08 15: R\$ 41,93
30: R\$ 42,77 45: R\$ 43,63 60: R\$ 44,50



DISPENSER PLAST PAPEL HIG ROLAO 300/500M

Código: 47834 Fábrica: NOBRE Unidade: UN/1 F1 F4

UN: R\$ 35,94 AV: R\$ 35,94 15: R\$ 36,69
30: R\$ 37,42 45: R\$ 38,17 60: R\$ 38,94



DISPENSER PLAST PAPEL TOALHA 1/3D 39999

Código: 47832 Fábrica: NOBRE Unidade: UN/1 F1 F4

UN: R\$ 112,98 AV: R\$ 112,98 15: R\$ 115,34
30: R\$ 117,64 45: R\$ 120,00 60: R\$ 122,40



DISPENSER PLAST POUPADOR COPO AGUA 200ML

Código: 47831 Fábrica: NOBRE Unidade: UN/1 F1 F4

UN: R\$ 41,08 AV: R\$ 41,08 15: R\$ 41,93
30: R\$ 42,77 45: R\$ 43,63 60: R\$ 44,50



DISPENSER PLAST SABONE LIQ/ALCOOL 800ML

Código: 47833 Fábrica: NOBRE Unidade: UN/1 F1 F4

UN: R\$ 1,83 AV: R\$ 3,66 15: R\$ 3,74
30: R\$ 3,81 45: R\$ 3,89 60: R\$ 3,97



DOSADOR PLASTICO GARRAFA 707 2X1

Código: 27647 Fábrica: CLINK Unidade: PT/2 F1 F4

UN: R\$ 36,97 AV: R\$ 36,97 15: R\$ 37,74
30: R\$ 38,49 45: R\$ 39,26 60: R\$ 40,05



EBULIDOR ALUMINIO 127 V 1000W PEQ 101/WA

Código: 22827 Fábrica: IMC/RESIS Unidade: UN/1 F1 F4

UN: R\$ 54,43 AV: R\$ 54,43 15: R\$ 55,57
30: R\$ 56,68 45: R\$ 57,81 60: R\$ 58,97



EBULIDOR ALUMINIO 127 V 2000W GDE 103

Código: 27093 Fábrica: IMC/RESISWAL Unidade: UN/1 F1 F4

UN: R\$ 35,94 AV: R\$ 35,94 15: R\$ 36,69
30: R\$ 37,42 45: R\$ 38,17 60: R\$ 38,94



EBULIDOR ALUMINIO 220 V 1000W PEQ 104

Código: 26118 Fábrica: IMC/RESISWAL Unidade: UN/1 F1 F4

UN: R\$ 54,43 AV: R\$ 54,43 15: R\$ 55,57
30: R\$ 56,68 45: R\$ 57,81 60: R\$ 58,97



EBULIDOR ALUMINIO 220 V 2000W GDE GB

Código: 41653 Fábrica: IMC/RESISWAL Unidade: UN/1 F1 F4

UN: R\$ 14,88 AV: R\$ 14,88 15: R\$ 15,19
30: R\$ 15,50 45: R\$ 15,81 60: R\$ 16,12



EMBALAGEM C/ALCA P/MUDA PL 21 LTS PRETO

Código: 41374 Fábrica: NUTRIPLAN Unidade: UN/1 F1 F4

UN: R\$ 18,99 AV: R\$ 18,99 15: R\$ 19,39
30: R\$ 19,78 45: R\$ 20,17 60: R\$ 20,58



EMBALAGEM C/ALCA P/MUDA PL 33 LTS PRETO

Código: 41373 Fábrica: NUTRIPLAN Unidade: UN/1 F1 F4

UN: R\$ 22,59 AV: R\$ 22,59 15: R\$ 23,06
30: R\$ 23,52 45: R\$ 23,99 60: R\$ 24,47



EMBALAGEM C/ALCA P/MUDA PL 39 LTS PRETO

Código: 41375 Fábrica: NUTRIPLAN Unidade: UN/1 F1 F4

UN: R\$ 26,70 AV: R\$ 26,70 15: R\$ 27,25
30: R\$ 27,80 45: R\$ 28,35 60: R\$ 28,92



EMBALAGEM C/ALCA P/MUDA PL 40 LTS PRETO

Código: 41376 Fábrica: NUTRIPLAN Unidade: UN/1 F1 F4

UN: R\$ 33,89 AV: R\$ 33,89 15: R\$ 34,59
30: R\$ 35,29 45: R\$ 35,99 60: R\$ 36,71



EMBALAGEM C/ALCA P/MUDA PL 50 LTS PRETO
Código: 41377 Fábrica: NUTRIPLAN Unidade: UN/1 F1 F4

UN: R\$ 45,19 AV: R\$ 45,19 15: R\$ 46,13
30: R\$ 47,05 45: R\$ 47,99 60: R\$ 48,95



EMBALAGEM C/ALCA P/MUDA PL 60 LTS PRETO
Código: 41378 Fábrica: NUTRIPLAN Unidade: UN/1 F1 F4

UN: R\$ 58,54 AV: R\$ 58,54 15: R\$ 59,76
30: R\$ 60,95 45: R\$ 62,17 60: R\$ 63,42



EMBALAGEM C/ALCA P/MUDA PL 85 LTS PRETO
Código: 41379 Fábrica: NUTRIPLAN Unidade: UN/1 F1 F4

UN: R\$ 82,17 AV: R\$ 82,17 15: R\$ 83,88
30: R\$ 85,56 45: R\$ 87,27 60: R\$ 89,01



EMBALAGEM C/ALCA P/MUDA PL 110 LTS PTO
Código: 41380 Fábrica: NUTRIPLAN Unidade: UN/1 F1 F4

UN: R\$ 1,79 AV: R\$ 1,79 15: R\$ 1,82
30: R\$ 1,86 45: R\$ 1,90 60: R\$ 1,94
12 cm
12 cm
1 lts



EMBALAGEM P/MUDA PL 1 LT PRETO
Código: 38912 Fábrica: NUTRIPLAN Unidade: UN/1 F1 F4

UN: R\$ 3,77 AV: R\$ 3,77 15: R\$ 3,85
30: R\$ 3,93 45: R\$ 4,00 60: R\$ 4,08
Altura : 15 cm
Larg : 18 cm



EMBALAGEM P/MUDA PL 2,8 LTS PRETO
Código: 30320 Fábrica: NUTRIPLAN Unidade: UN/1 F1 F4

UN: R\$ 5,00 AV: R\$ 5,00 15: R\$ 5,11
30: R\$ 5,21 45: R\$ 5,31 60: R\$ 5,42
Altura : 20 cm
Larg : 20 cm



EMBALAGEM P/MUDA PL 5 LTS PRETO
Código: 30318 Fábrica: NUTRIPLAN Unidade: UN/1 F1 F4

UN: R\$ 6,15 AV: R\$ 6,15 15: R\$ 6,28
30: R\$ 6,41 45: R\$ 6,53 60: R\$ 6,67



EMBALAGEM P/MUDA PL 7 LTS PRETO
Código: 41372 Fábrica: NUTRIPLAN Unidade: UN/1 F1 F4

UN: R\$ 6,46 AV: R\$ 6,46 15: R\$ 6,60
30: R\$ 6,73 45: R\$ 6,86 60: R\$ 7,00
Altura : 22 cm
Larg : 23 cm



EMBALAGEM P/MUDA PL 8 LTS PRETO
Código: 30319 Fábrica: NUTRIPLAN Unidade: UN/1 F1 F4

UN: R\$ 7,93 AV: R\$ 7,93 15: R\$ 8,10
30: R\$ 8,26 45: R\$ 8,42 60: R\$ 8,59
25cm
25 cm
10 lts



EMBALAGEM P/MUDA PL 10 LTS PRETO
Código: 38915 Fábrica: NUTRIPLAN Unidade: UN/1 F1 F4

UN: R\$ 6,88 AV: R\$ 6,88 15: R\$ 7,03
30: R\$ 7,17 45: R\$ 7,31 60: R\$ 7,46
24 cm
27,5 cm



EMBALAGEM P/MUDA PL 11 LTS PRETO
Código: 31389 Fábrica: NUTRIPLAN Unidade: UN/1 F1 F4

UN: R\$ 7,81 AV: R\$ 7,81 15: R\$ 7,97
30: R\$ 8,13 45: R\$ 8,29 60: R\$ 8,46
28cm
28 cm
14.3 lts



EMBALAGEM P/MUDA PL 14,3 LTS PRETO
Código: 38913 Fábrica: NUTRIPLAN Unidade: UN/1 F1 F4

UN: R\$ 9,76 AV: R\$ 9,76 15: R\$ 9,96
30: R\$ 10,16 45: R\$ 10,36 60: R\$ 10,57
30 cm
30 cm
18 lts



EMBALAGEM P/MUDA PL 18 LTS PRETO
Código: 33531 Fábrica: NUTRIPLAN Unidade: UN/1 F1 F4

UN: R\$ 12,22 AV: R\$ 12,22 15: R\$ 12,48
30: R\$ 12,73 45: R\$ 12,98 60: R\$ 13,24
35cm
34 cm
25 lts



EMBALAGEM P/MUDA PL 25 LTS PRETO
Código: 38914 Fábrica: NUTRIPLAN Unidade: UN/1 F1 F4

UN: R\$ 16,42 AV: R\$ 16,42 15: R\$ 16,77
30: R\$ 17,10 45: R\$ 17,44 60: R\$ 17,79



EMBALAGEM P/MUDA PL 35 LTS PRETO
Código: 41401 Fábrica: NUTRIPLAN Unidade: UN/1 F1 F4

UN: R\$ 7,78 AV: R\$ 7,78 15: R\$ 7,94
30: R\$ 8,10 45: R\$ 8,26 60: R\$ 8,42



EMENDA PLAST MANGUEIRA SMART 212
Código: 40239 Fábrica: MONTEREY Unidade: UN/1 F1 F4

UN: R\$ 12,87 AV: R\$ 12,87 15: R\$ 13,14
30: R\$ 13,40 45: R\$ 13,67 60: R\$ 13,94



ENGATE RAPIDO PLAST MANGUEIRA 4X1 4092
Código: Fábrica: Unidade:
50145 GP6 CR/1
F1 F4

UN: R\$ 29,17 AV: R\$ 29,17 15: R\$ 29,78
30: R\$ 30,38 45: R\$ 30,98 60: R\$ 31,60



ESCORREDOR ACO INOX 18X10CM 9375
Código: Fábrica: Unidade:
50219 CASITA UN/1
F1 F4

UN: R\$ 35,94 AV: R\$ 35,94 15: R\$ 36,69
30: R\$ 37,42 45: R\$ 38,17 60: R\$ 38,94



ESCORREDOR ACO INOX 28X35X14CM 9376
Código: Fábrica: Unidade:
50218 CASITA UN/1
F1 F4

UN: R\$ 24,64 AV: R\$ 24,64 15: R\$ 25,16
30: R\$ 25,66 45: R\$ 26,17 60: R\$ 26,70



ESCORREDOR ALUM ARROZ 670
Código: Fábrica: Unidade:
6733 MSR UN/1
F1 F4

UN: R\$ 178,73 AV: R\$ 178,73 15: R\$ 182,46
30: R\$ 186,11 45: R\$ 189,83 60: R\$ 193,62



ESCORREDOR ALUM MACARRAO HOTEL 45
Código: Fábrica: Unidade:
50168 MSR UN/1
F1 F4

UN: R\$ 55,46 AV: R\$ 55,46 15: R\$ 56,61
30: R\$ 57,75 45: R\$ 58,90 60: R\$ 60,08



ESCORREDOR CROM PRAT/COP MEIA LUA 806
Código: Fábrica: Unidade:
33913 ARAMINAS UN/1
F1 F4

UN: R\$ 40,05 AV: R\$ 40,05 15: R\$ 40,88
30: R\$ 41,70 45: R\$ 42,54 60: R\$ 43,39



ESCORREDOR CROM PRAT/COP MINI 947
Código: Fábrica: Unidade:
49960 ARAMINAS UN/1
F1 F4

UN: R\$ 66,76 AV: R\$ 66,76 15: R\$ 68,15
30: R\$ 69,51 45: R\$ 70,90 60: R\$ 72,32



ESCORREDOR CROM PRAT/COP 2AND 39X25CM 31
Código: Fábrica: Unidade:
24607 ARAMINAS UN/1
F1 F4

UN: R\$ 49,30 AV: R\$ 49,30 15: R\$ 50,32
30: R\$ 51,33 45: R\$ 52,36 60: R\$ 53,40

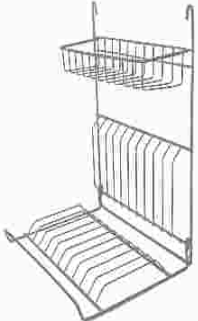

ESCORREDOR CROM PRATO PAREDE 563
Código: Fábrica: Unidade:
28955 ARAMINAS UN/1
F1 F4

UN: R\$ 40,88 AV: R\$ 40,88 15: R\$ 41,73
30: R\$ 42,57 45: R\$ 43,42 60: R\$ 44,29

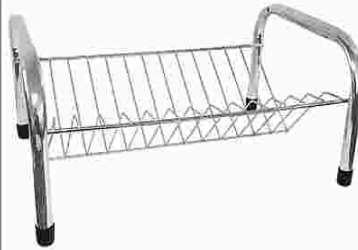

ESCORREDOR CROM PRATO SIMPLES 697
Código: Fábrica: Unidade:
20174 ARAMINAS UN/1
F1 F4

UN: R\$ 68,81 AV: R\$ 68,81 15: R\$ 70,25
30: R\$ 71,65 45: R\$ 73,08 60: R\$ 74,55



ESCORREDOR CROM PRATO/COPO 32 BAIXO41X32
Código: Fábrica: Unidade:
24608 ARAMINAS UN/1
F1 F4

UN: R\$ 59,57 AV: R\$ 59,57 15: R\$ 60,81
30: R\$ 62,02 45: R\$ 63,27 60: R\$ 64,53



ESCORREDOR CROM 2AND TUBULAR 30
Código: Fábrica: Unidade:
40248 ARAMINAS UN/1
F1 F4

UN: R\$ 3,58 AV: R\$ 3,58 15: R\$ 3,66
30: R\$ 3,73 45: R\$ 3,81 60: R\$ 3,88



ESCORREDOR PLAST ARROZ CORES 467
Código: Fábrica: Unidade:
46642 QUALYPLAS UN/1
F1 F4

UN: R\$ 9,92 AV: R\$ 9,92 15: R\$ 10,13
30: R\$ 10,33 45: R\$ 10,54 60: R\$ 10,75



ESCORREDOR PLAST ARROZ 5589
Código: Fábrica: Unidade:
35485 TRITEC UN/1
F1 F4

UN: R\$ 14,37 AV: R\$ 14,37 15: R\$ 14,67
30: R\$ 14,96 45: R\$ 15,26 60: R\$ 15,57



ESCORREDOR PLAST LOUCA PRETO 410
Código: Fábrica: Unidade:
48378 PLASMARC UN/1
F1 F4

UN: R\$ 15,88 AV: R\$ 15,88 15: R\$ 16,21
30: R\$ 16,54 45: R\$ 16,87 60: R\$ 17,20



ESCORREDOR PLAST MASSAS 0013
Código: Fábrica: Unidade:
2675 JAGUAR UN/1
F1 F4

UN: R\$ 11,97 AV: R\$ 11,97 15: R\$ 12,22
30: R\$ 12,46 45: R\$ 12,71 60: R\$ 12,96
11cm
30cm



ESCORREDOR PLAST MULTI USO C/ALCAS 987
Código: Fábrica: Unidade:
46673 LUMAR UN/1
F1 F4

UN: R\$ 27,57 AV: R\$ 27,57 15: R\$ 28,14
30: R\$ 28,70 45: R\$ 29,28 60: R\$ 29,86

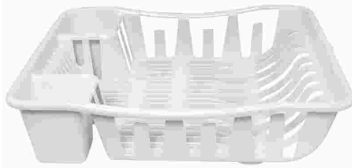

ESCORREDOR PLAST PRATO 503
Código: Fábrica: Unidade:
35487 TRITEC UN/1
F1 F4

UN: R\$ 20,02 AV: R\$ 20,02 15: R\$ 20,44
30: R\$ 20,85 45: R\$ 21,26 60: R\$ 21,69
10cm
48cm



ESCORREDOR PLAST PRATOS 16
Código: Fábrica: Unidade:
2076 JAGUAR UN/1
F1 F4

UN: R\$ 4,58 AV: R\$ 4,58 15: R\$ 4,68
30: R\$ 4,77 45: R\$ 4,87 60: R\$ 4,96
3 cm
39 cm
12,5cm



ESCORREDOR PLAST P/TINTA DE PINTURA
Código: Fábrica: Unidade:
40076 MOLDE MINAS UN/1
F1 F4

UN: R\$ 4,62 AV: R\$ 55,47 15: R\$ 56,62
30: R\$ 57,76 45: R\$ 58,91 60: R\$ 60,09



ESCOVA LAVAR ROUPA MAD OVAL MAX 4 12X1
Código: Fábrica: Unidade:
28872 N.HORIZONTE PT/12
F1 F4

UN: R\$ 4,09 AV: R\$ 49,08 15: R\$ 50,10
30: R\$ 51,10 45: R\$ 52,13 60: R\$ 53,17



ESCOVA LAVAR ROUPA MAD OVAL MED 3 12X1
Código: Fábrica: Unidade:
7122 N.HORIZONTE PT/12
F1 F4

UN: R\$ 3,42 AV: R\$ 41,08 15: R\$ 41,93
30: R\$ 42,77 45: R\$ 43,63 60: R\$ 44,50



ESCOVA LAVAR ROUPA MAD OVAL PEQ 5 12X1
Código: Fábrica: Unidade:
34403 N.HORIZONTE PT/12
F1 F4

UN: R\$ 4,24 AV: R\$ 50,85 15: R\$ 51,91
30: R\$ 52,94 45: R\$ 54,00 60: R\$ 55,08



ESCOVA LAVAR ROUPA MAD RET MED 26 12X1
Código: Fábrica: Unidade:
28135 N.HORIZONTE PT/12
F1 F4

UN: R\$ 3,34 AV: R\$ 40,05 15: R\$ 40,88
30: R\$ 41,70 45: R\$ 42,54 60: R\$ 43,39



ESCOVA LAVAR ROUPA MAD RET PEQ 12X1
Código: Fábrica: Unidade:
36310 N.HORIZONTE PT/12
F1 F4

UN: R\$ 4,45 AV: R\$ 53,40 15: R\$ 54,52
30: R\$ 55,61 45: R\$ 56,72 60: R\$ 57,85



ESCOVA LAVAR ROUPA MAD 16 MED 85175 12X1
Código: Fábrica: Unidade:
6290 CONDOR DZ/12
F1 F4

UN: R\$ 4,28 AV: R\$ 4,28 15: R\$ 4,37
30: R\$ 4,46 45: R\$ 4,55 60: R\$ 4,64



ESCOVA LAVAR ROUPA PLAST ANTIDERRAP UN
Código: Fábrica: Unidade:
20137 N.HORIZONTE UN/1
F1 F4

UN: R\$ 5,99 AV: R\$ 71,89 15: R\$ 73,39
30: R\$ 74,86 45: R\$ 76,36 60: R\$ 77,88



ESCOVA LAVAR ROUPA PLAST OVAL 25 12X1
Código: Fábrica: Unidade:
22595 N.HORIZONTE PT/12
F1 F4

UN: R\$ 4,51 AV: R\$ 4,51 15: R\$ 4,60
30: R\$ 4,70 45: R\$ 4,79 60: R\$ 4,89



ESCOVA LAVAR ROUPA UN
Código: Fábrica: Unidade:
47255 SHANG/NHORIZ UN/1
F1 F4

UN: R\$ 7,18 AV: R\$ 7,18 15: R\$ 7,33
30: R\$ 7,48 45: R\$ 7,63 60: R\$ 7,78



ESCOVA MAD P/SAPATO 6/287
Código: Fábrica: Unidade:
28136 N.HORIZONTE UN/1
F1 F4

UN: R\$ 8,21 AV: R\$ 8,21 15: R\$ 8,38
30: R\$ 8,55 45: R\$ 8,72 60: R\$ 8,89



ESCOVA PLAST LIMPEZA 15,5CM 1467
Código: Fábrica: Unidade:
41542 ELITE UN/1
F1 F4

UN: R\$ 7,18 AV: R\$ 7,18 15: R\$ 7,33
30: R\$ 7,48 45: R\$ 7,63 60: R\$ 7,78



ESCOVA P/ROUPA MAD RET MULTI USO 29/316
Código: Fábrica: Unidade:
28873 N.HORIZONTE UN/1
F1 F4

UN: R\$ 3,42 AV: R\$ 41,08 15: R\$ 41,93
30: R\$ 42,77 45: R\$ 43,63 60: R\$ 44,50



ESCOVA SANIT LAVATINA NYLON 12X1

Código: 29313 Fábrica: N.HORIZONTE Unidade: DZ/12 F1 F4

UN: R\$ 4,71 AV: R\$ 4,71 15: R\$ 4,81
30: R\$ 4,91 45: R\$ 5,01 60: R\$ 5,11



ESCOVA SANITARIA CB PLAST C/SUP AZUL 151

Código: 46865 Fábrica: PLANETA Unidade: UN/1 F1 F4

UN: R\$ 4,71 AV: R\$ 4,71 15: R\$ 4,81
30: R\$ 4,91 45: R\$ 5,01 60: R\$ 5,11



ESCOVA SANITARIA CB PLAST C/SUP BCO 150

Código: 41564 Fábrica: PLANETA Unidade: UN/1 F1 F4

UN: R\$ 4,71 AV: R\$ 4,71 15: R\$ 4,81
30: R\$ 4,91 45: R\$ 5,01 60: R\$ 5,11



ESCOVA SANITARIA CB PLAST C/SUP ROSA 152

Código: 46866 Fábrica: PLANETA Unidade: UN/1 F1 F4

UN: R\$ 9,44 AV: R\$ 9,44 15: R\$ 9,64
30: R\$ 9,83 45: R\$ 10,03 60: R\$ 10,23



ESCOVA SANITARIA CB PLAST C/SUPORTE 2355

Código: 38001 Fábrica: DALCIN Unidade: UN/1 F1 F4

UN: R\$ 5,54 AV: R\$ 5,54 15: R\$ 5,65
30: R\$ 5,76 45: R\$ 5,88 60: R\$ 6,00



ESCUMADEIRA ACO INOX 25,5CM LAR 060

Código: 50101 Fábrica: PLANETA Unidade: UN/1 F1 F4

UN: R\$ 13,34 AV: R\$ 13,34 15: R\$ 13,62
30: R\$ 13,89 45: R\$ 14,17 60: R\$ 14,46



ESCUMADEIRA ALUM BATIDO 30CM 2644

Código: 45295 Fábrica: MSR Unidade: UN/1 F1 F4

UN: R\$ 10,26 AV: R\$ 10,26 15: R\$ 10,48
30: R\$ 10,69 45: R\$ 10,90 60: R\$ 11,12



ESCUMADEIRA ALUM FUNDIDO 30CM

Código: 29648 Fábrica: AVELAR Unidade: UN/1 F1 F4

UN: R\$ 4,47 AV: R\$ 4,47 15: R\$ 4,56
30: R\$ 4,65 45: R\$ 4,75 60: R\$ 4,84



ESCUMADEIRA ALUM 27CM INTEIRIC 2019 UN

Código: 48020 Fábrica: COFAX Unidade: UN/1 F1 F4

UN: R\$ 4,98 AV: R\$ 4,98 15: R\$ 5,09
30: R\$ 5,19 45: R\$ 5,29 60: R\$ 5,40



ESCUMADEIRA ALUM 28CM CB MAD 2001 UN

Código: 48036 Fábrica: COFAX Unidade: UN/1 F1 F4

UN: R\$ 21,56 AV: R\$ 21,56 15: R\$ 22,01
30: R\$ 22,45 45: R\$ 22,90 60: R\$ 23,36



ESCUMADEIRA CROM 01 CB MADEIRA 01 33

Código: 28964 Fábrica: ARAMINAS Unidade: UN/1 F1 F4

UN: R\$ 12,51 AV: R\$ 12,51 15: R\$ 12,77
30: R\$ 13,03 45: R\$ 13,29 60: R\$ 13,55

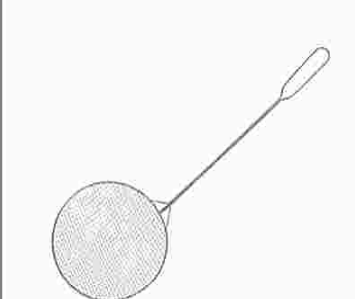

ESCUMADEIRA CROM 02 CB INTEIRICO 277

Código: 20177 Fábrica: ARAMINAS Unidade: UN/1 F1 F4

UN: R\$ 23,11 AV: R\$ 23,11 15: R\$ 23,59
30: R\$ 24,07 45: R\$ 24,55 60: R\$ 25,04

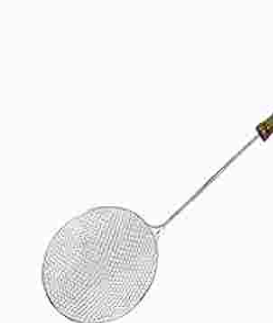

ESCUMADEIRA CROM 02 CB MADEIRA 34

Código: 28965 Fábrica: ARAMINAS Unidade: UN/1 F1 F4

UN: R\$ 17,32 AV: R\$ 17,32 15: R\$ 17,68
30: R\$ 18,03 45: R\$ 18,39 60: R\$ 18,76

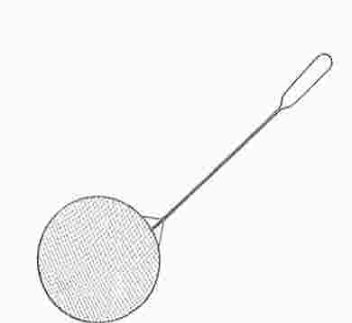

ESCUMADEIRA CROM 03 CB INTEIRICO 278

Código: 20178 Fábrica: ARAMINAS Unidade: UN/1 F1 F4

UN: R\$ 24,53 AV: R\$ 24,53 15: R\$ 25,04
30: R\$ 25,54 45: R\$ 26,05 60: R\$ 26,57



ESCUMADEIRA CROM 03 CB MADEIRA 35

Código: 28966 Fábrica: ARAMINAS Unidade: UN/1 F1 F4

UN: R\$ 22,19 AV: R\$ 22,19 15: R\$ 22,65
30: R\$ 23,10 45: R\$ 23,56 60: R\$ 24,04



ESCUMADEIRA CROM 04 CB INTEIRICO 279

Código: 29831 Fábrica: ARAMINAS Unidade: UN/1 F1 F4

UN: R\$ 36,97 AV: R\$ 36,97 15: R\$ 37,74
30: R\$ 38,49 45: R\$ 39,26 60: R\$ 40,05



ESCUMADEIRA CROM 04 CB MADEIRA 36
Código: Fábrika: Unidade:
28967 ARAMINAS UN/1
F1 F4

UN: R\$ 26,91 AV: R\$ 26,91 15: R\$ 27,47
30: R\$ 28,02 45: R\$ 28,58 60: R\$ 29,15



ESCUMADEIRA CROM 05 CB INTEIR INDST 189
Código: Fábrika: Unidade:
29832 ARAMINAS UN/1
F1 F4

UN: R\$ 35,94 AV: R\$ 35,94 15: R\$ 36,69
30: R\$ 37,42 45: R\$ 38,17 60: R\$ 38,94



ESCUMADEIRA CROM 05 CB MAD INDUST 05
Código: Fábrika: Unidade:
28968 ARAMINAS UN/1
F1 F4

UN: R\$ 36,11 AV: R\$ 36,11 15: R\$ 36,86
30: R\$ 37,60 45: R\$ 38,35 60: R\$ 39,11

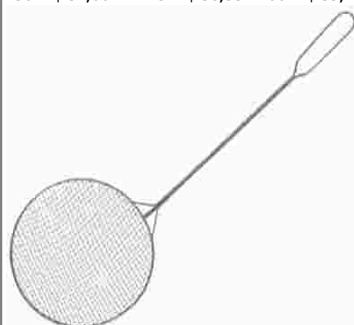

ESCUMADEIRA CROM 06 CB INTEIR INDST 114
Código: Fábrika: Unidade:
12165 ARAMINAS UN/1
F1 F4

UN: R\$ 38,01 AV: R\$ 38,01 15: R\$ 38,80
30: R\$ 39,57 45: R\$ 40,37 60: R\$ 41,17



ESCUMADEIRA CROM 06 CB MAD INDST 38
Código: Fábrika: Unidade:
28969 ARAMINAS UN/1
F1 F4

UN: R\$ 6,99 AV: R\$ 6,99 15: R\$ 7,13
30: R\$ 7,27 45: R\$ 7,42 60: R\$ 7,57



ESCUMADEIRA INOX CACIQUE 33CM 138
Código: Fábrika: Unidade:
39352 PLANETA UN/1
F1 F4

UN: R\$ 12,32 AV: R\$ 12,32 15: R\$ 12,57
30: R\$ 12,82 45: R\$ 13,08 60: R\$ 13,34



ESCUMADEIRA NYLON BRANCA CB ACO 113-005
Código: Fábrika: Unidade:
41599 HERCULES UN/1
F1 F4

UN: R\$ 6,36 AV: R\$ 6,36 15: R\$ 6,49
30: R\$ 6,62 45: R\$ 6,76 60: R\$ 6,99



ESCUMADEIRA NYLON PRETO 28CM 1084
Código: Fábrika: Unidade:
37803 ENGIPLAST UN/1
F1 F4

UN: R\$ 21,19 AV: R\$ 21,19 15: R\$ 21,63
30: R\$ 22,07 45: R\$ 22,51 60: R\$ 22,96



ESCUMADEIRA NYLON 35CM CB CROMADO 66
Código: Fábrika: Unidade:
41350 HAUSKRAFT UN/1
F1 F4

UN: R\$ 2,82 AV: R\$ 2,82 15: R\$ 2,87
30: R\$ 2,93 45: R\$ 2,99 60: R\$ 3,05



ESCUMADEIRA PLAST 33CM COLOR 823
Código: Fábrika: Unidade:
41644 QUALYPLAS UN/1
F1 F4

UN: R\$ 17,26 AV: R\$ 17,26 15: R\$ 17,62
30: R\$ 17,97 45: R\$ 18,33 60: R\$ 18,70



ESCUMADEIRA SILICONE COLOR 29CM 17071
Código: Fábrika: Unidade:
33951 PRATIBELLA UN/1
F1 F4

UN: R\$ 30,81 AV: R\$ 30,81 15: R\$ 31,45
30: R\$ 32,08 45: R\$ 32,72 60: R\$ 33,37



ESGUICHO ADAP/CONEC/PISTOL MANGUEIR 1/2"
Código: Fábrika: Unidade:
50968 FBG CR/1
F1 F4

UN: R\$ 42,06 AV: R\$ 42,06 15: R\$ 42,94
30: R\$ 43,80 45: R\$ 44,68 60: R\$ 45,57



ESGUICHO PIST PLAST ADAPT MANGUEIR 1/2"
Código: Fábrika: Unidade:
49642 WINMAX UN/1
F1 F4

UN: R\$ 12,51 AV: R\$ 12,51 15: R\$ 12,77
30: R\$ 13,03 45: R\$ 13,29 60: R\$ 13,55

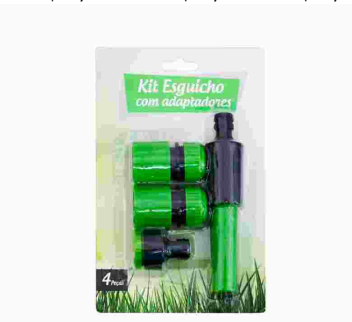

ESGUICHO PLAST ADAP/CONEC MANGUEIR 1/2"
Código: Fábrika: Unidade:
50966 IMPORIENTE CR/1
F1 F4

UN: R\$ 21,01 AV: R\$ 21,01 15: R\$ 21,44
30: R\$ 21,87 45: R\$ 22,31 60: R\$ 22,76



ESGUICHO PLAST ADAP/CONEC MANGUEIR 1/2"
Código: Fábrika: Unidade:
49643 WINMAX UN/1
F1 F4

UN: R\$ 15,87 AV: R\$ 15,87 15: R\$ 16,20
30: R\$ 16,52 45: R\$ 16,86 60: R\$ 17,19



ESPANADOR PENA 20 NOMO COLOR 100
Código: Fábrika: Unidade:
48401 SHANGRILA UN/1
F1 F4

UN: R\$ 25,67 AV: R\$ 25,67 15: R\$ 26,20
30: R\$ 26,73 45: R\$ 27,26 60: R\$ 27,81



ESPANADOR PENA 20 NOMO 86
Código: Fábrika: Unidade:
48399 SHANGRILA UN/1
F1 F4

UN: R\$ 21,05 AV: R\$ 21,05 15: R\$ 21,49
30: R\$ 21,92 45: R\$ 22,35 60: R\$ 22,80



ESPANADOR PENA 25 NOMO CLEAN 5844
Código: Fábrika: Unidade:
50196 SHANGRILA UN/1
F1 F4

UN: R\$ 17,45 AV: R\$ 17,45 15: R\$ 17,82
30: R\$ 18,17 45: R\$ 18,54 60: R\$ 18,91



ESPANADOR PENA 30 NOMO COLOR 101
Código: Fábrika: Unidade:
48402 SHANGRILA UN/1
F1 F4

UN: R\$ 30,81 AV: R\$ 30,81 15: R\$ 31,45
30: R\$ 32,08 45: R\$ 32,72 60: R\$ 33,37



ESPANADOR PENA 35 NOMO CLEAN 5718
Código: Fábrika: Unidade:
50195 SHANGRILA UN/1
F1 F4

UN: R\$ 34,91 AV: R\$ 34,91 15: R\$ 35,64
30: R\$ 36,35 45: R\$ 37,08 60: R\$ 37,82



ESPANADOR PENA 45 NOMO CLEAN 5719
Código: Fábrika: Unidade:
50194 SHANGRILA UN/1
F1 F4

UN: R\$ 19,51 AV: R\$ 19,51 15: R\$ 19,91
30: R\$ 20,31 45: R\$ 20,72 60: R\$ 21,13



ESPATULA ALUM FUNDIDO 30CM
Código: Fábrika: Unidade:
32524 AVELAR UN/1
F1 F4

UN: R\$ 3,51 AV: R\$ 3,51 15: R\$ 3,58
30: R\$ 3,66 45: R\$ 3,73 60: R\$ 3,80



ESPATULA BAMBU VAZADA 30CM CB COLOR 6025
Código: Fábrika: Unidade:
44737 WINCY UN/1
F1 F4

UN: R\$ 8,69 AV: R\$ 8,69 15: R\$ 8,87
30: R\$ 9,05 45: R\$ 9,23 60: R\$ 9,41



ESPATULA INOX P/BOLO 24CM CTL 1736
Código: Fábrika: Unidade:
15922 SIMONAGGIO UN/1
F1 F4

UN: R\$ 5,13 AV: R\$ 5,13 15: R\$ 5,23
30: R\$ 5,34 45: R\$ 5,44 60: R\$ 5,55



ESPATULA INOX P/BOLO 26CM 062
Código: Fábrika: Unidade:
46841 PLANETA UN/1
F1 F4

UN: R\$ 19,16 AV: R\$ 19,16 15: R\$ 19,56
30: R\$ 19,95 45: R\$ 20,35 60: R\$ 20,75



ESPATULA INOX RETA 24X12CM CB PLAST -25
Código: Fábrika: Unidade:
45292 NICOBEM UN/1
F1 F4

UN: R\$ 7,29 AV: R\$ 7,29 15: R\$ 7,45
30: R\$ 7,59 45: R\$ 7,75 60: R\$ 7,90



ESPATULA INOX 26,5CM P/BOLO 061
Código: Fábrika: Unidade:
47326 NIX UN/1
F1 F4

UN: R\$ 10,89 AV: R\$ 10,89 15: R\$ 11,12
30: R\$ 11,34 45: R\$ 11,56 60: R\$ 11,80



ESPATULA SILICONE CURVA VERMELH 24CM 328
Código: Fábrika: Unidade:
46870 PLANETA UN/1
F1 F4

UN: R\$ 10,63 AV: R\$ 10,63 15: R\$ 10,85
30: R\$ 11,07 45: R\$ 11,29 60: R\$ 11,52



ESPATULA SILICONE VAZADA 27CM PRETO 653
Código: Fábrika: Unidade:
50099 PLANETA UN/1
F1 F4

UN: R\$ 12,95 AV: R\$ 12,95 15: R\$ 13,21
30: R\$ 13,48 45: R\$ 13,75 60: R\$ 14,03



ESPATULA SILICONE VAZADA 27CM VERMEL 993
Código: Fábrika: Unidade:
50098 PLANETA UN/1
F1 F4

UN: R\$ 15,41 AV: R\$ 15,41 15: R\$ 15,73
30: R\$ 16,04 45: R\$ 16,36 60: R\$ 16,69



ESPATULA SILICONE VM CB ACO INOX 3094
Código: Fábrika: Unidade:
33820 GEDEX UN/1
F1 F4

UN: R\$ 0,08 AV: R\$ 4,10 15: R\$ 4,18
30: R\$ 4,27 45: R\$ 4,35 60: R\$ 4,44



ESPETO BAMBU CHURRASCO 25CM 24260 50X1
Código: Fábrika: Unidade:
47880 BOMPACK PT/50
F1 F4

UN: R\$ 0,10 AV: R\$ 5,13 15: R\$ 5,23
30: R\$ 5,34 45: R\$ 5,44 60: R\$ 5,55



ESPETO BAMBU CHURRASCO 30CM 24672 50X1
Código: Fábrica: Unidade:
44763 BOMPACK PT/50
F1 F4

UN: R\$ 12,07 AV: R\$ 12,07 15: R\$ 12,32
30: R\$ 12,57 45: R\$ 12,82 60: R\$ 13,08



ESPETO DUPLO 55 CM 02
Código: Fábrica: Unidade:
24059 ARAMINAS UN/1
F1 F4

UN: R\$ 13,87 AV: R\$ 13,87 15: R\$ 14,16
30: R\$ 14,44 45: R\$ 14,73 60: R\$ 15,02



ESPETO DUPLO 65 CM 03
Código: Fábrica: Unidade:
24060 ARAMINAS UN/1
F1 F4

UN: R\$ 19,09 AV: R\$ 19,09 15: R\$ 19,48
30: R\$ 19,87 45: R\$ 20,27 60: R\$ 20,68



ESPETO DUPLO 75 CM 04
Código: Fábrica: Unidade:
24061 ARAMINAS UN/1
F1 F4

UN: R\$ 0,06 AV: R\$ 6,37 15: R\$ 6,50
30: R\$ 6,63 45: R\$ 6,76 60: R\$ 6,90



ESPETO MAD CHURRASCO 18CM 64008 100X1
Código: Fábrica: Unidade:
41178 THEOTO PT/100
F1 F4

UN: R\$ 0,09 AV: R\$ 469,42 15: R\$ 479,20
30: R\$ 488,78 45: R\$ 498,56 60: R\$ 508,53

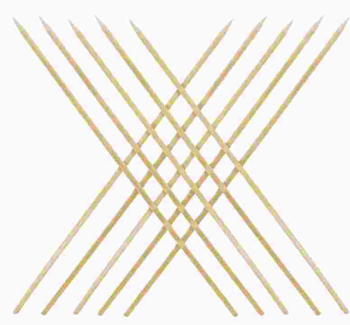

ESPETO MAD CHURRASCO 25CM 5000X1
Código: Fábrica: Unidade:
49693 ESTILO CX/5000
F1 F4

UN: R\$ 0,09 AV: R\$ 8,89 15: R\$ 9,07
30: R\$ 9,25 45: R\$ 9,44 60: R\$ 9,63



ESPETO MAD CHURRASCO 25CM 64021 100X1
Código: Fábrica: Unidade:
1938 THEOTO PT/100
F1 F4

UN: R\$ 0,12 AV: R\$ 9,23 15: R\$ 9,43
30: R\$ 9,62 45: R\$ 9,81 60: R\$ 10,00



ESPETO MAD CHURRASCO 25CM 80X1
Código: Fábrica: Unidade:
49694 ESTILO CX/80
F1 F4

UN: R\$ 12,07 AV: R\$ 12,07 15: R\$ 12,32
30: R\$ 12,57 45: R\$ 12,82 60: R\$ 13,08



ESPETO SIMPLES ACO ESTANHADO 55 CM 05
Código: Fábrica: Unidade:
12947 ARAMINAS UN/1
F1 F4

UN: R\$ 14,07 AV: R\$ 14,07 15: R\$ 14,37
30: R\$ 14,65 45: R\$ 14,95 60: R\$ 15,25



ESPETO SIMPLES ACO ESTANHADO 65 CM 06
Código: Fábrica: Unidade:
12948 ARAMINAS UN/1
F1 F4

UN: R\$ 15,15 AV: R\$ 15,15 15: R\$ 15,47
30: R\$ 15,78 45: R\$ 16,09 60: R\$ 16,41



ESPETO SIMPLES ACO ESTANHADO 75 CM 07
Código: Fábrica: Unidade:
12949 ARAMINAS UN/1
F1 F4

UN: R\$ 16,13 AV: R\$ 16,13 15: R\$ 16,46
30: R\$ 16,79 45: R\$ 17,13 60: R\$ 17,47



ESPETO SIMPLES ACO ESTANHADO 85 CM 0215
Código: Fábrica: Unidade:
40264 ARAMIG UN/1
F1 F4

UN: R\$ 16,13 AV: R\$ 16,13 15: R\$ 16,46
30: R\$ 16,79 45: R\$ 17,13 60: R\$ 17,47



ESPETO SIMPLES ACO ESTANHADO 85 CM 26
Código: Fábrica: Unidade:
44718 ARAMINAS UN/1
F1 F4

UN: R\$ 3,65 AV: R\$ 3,65 15: R\$ 3,72
30: R\$ 3,80 45: R\$ 3,87 60: R\$ 3,95

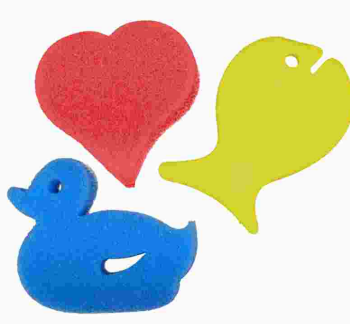

ESPUNJA BANHO INFANTIL UN
Código: Fábrica: Unidade:
44333 MC PANOS UN/1
F1 F4

UN: R\$ 5,13 AV: R\$ 5,13 15: R\$ 5,23
30: R\$ 5,34 45: R\$ 5,44 60: R\$ 5,55



ESPUNJA BANHO MASSAGEADORA
Código: Fábrica: Unidade:
50150 MC PANOS UN/1
F1 F4

UN: R\$ 1,43 AV: R\$ 1,43 15: R\$ 1,46
30: R\$ 1,49 45: R\$ 1,52 60: R\$ 1,55



ESPUNJA LIMPEZA DUPLA FACE UN
Código: Fábrica: Unidade:
46436 NOBRE UN/1
F1 F4

UN: R\$ 0,90 AV: R\$ 2,71 15: R\$ 2,77
30: R\$ 2,82 45: R\$ 2,88 60: R\$ 2,94



ESPONJA LIMPEZA DUPLA FACE 3X1

Código: Fábrika: Unidade:
50125 ESPONFLORA PT/3
F1 F4

UN: R\$ 4,37 AV: R\$ 4,37 15: R\$ 4,46
30: R\$ 4,55 45: R\$ 4,64 60: R\$ 4,73



ESPONJA MODELO LUVA P/LAVAR CARRO

Código: Fábrika: Unidade:
11331 FERREIRA UN/1
F1 F4

UN: R\$ 7,08 AV: R\$ 7,08 15: R\$ 7,22
30: R\$ 7,37 45: R\$ 7,52 60: R\$ 7,67



ESPONJA P/LAVAR CARRO

Código: Fábrika: Unidade:
11333 FERREIRA UN/1
F1 F4

UN: R\$ 333,84 AV: R\$ 333,84 15: R\$ 340,80
30: R\$ 347,61 45: R\$ 354,56 60: R\$ 361,65



ESPREGUICADEIRA PITANGUI BRANCA

Código: Fábrika: Unidade:
7749 ANTARES UN/1
F1 F4

Produto
* Altura: 90 cm
* Comp: 187 cm
* Largura: 70 cm

UN: R\$ 10,63 AV: R\$ 10,63 15: R\$ 10,85
30: R\$ 11,07 45: R\$ 11,29 60: R\$ 11,52

18 cm

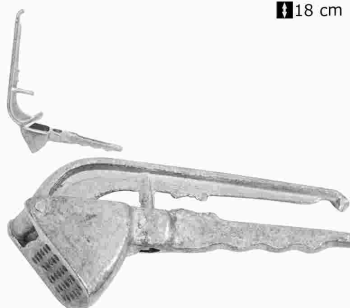

ESPREMEDOR ALUM INTEIR ALHO BIG 2008 UN

Código: Fábrika: Unidade:
48034 COFAX UN/1
F1 F4

UN: R\$ 4,98 AV: R\$ 4,98 15: R\$ 5,09
30: R\$ 5,19 45: R\$ 5,29 60: R\$ 5,40

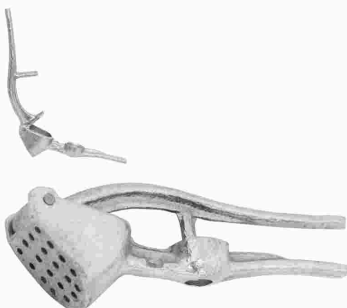

ESPREMEDOR ALUM INTEIR ALHO 2F 2030 UN

Código: Fábrika: Unidade:
48032 COFAX UN/1
F1 F4

UN: R\$ 10,60 AV: R\$ 10,60 15: R\$ 10,82
30: R\$ 11,04 45: R\$ 11,26 60: R\$ 11,49

7 cm
9 cm



ESPREMEDOR PLAST LARANJA 13X09CM 3174

Código: Fábrika: Unidade:
40311 WINCY UN/1
F1 F4

UN: R\$ 25,67 AV: R\$ 25,67 15: R\$ 26,20
30: R\$ 26,73 45: R\$ 27,26 60: R\$ 27,81



ESTACA P/PLANTA FIBRA DE COCO 60X5X5CM

Código: Fábrika: Unidade:
30295 NUTRIPLAN UN/1
F1 F4

UN: R\$ 37,61 AV: R\$ 37,61 15: R\$ 38,39
30: R\$ 39,16 45: R\$ 39,94 60: R\$ 40,74

80cm



ESTACA P/PLANTA FIBRA DE COCO 80X5X5CM

Código: Fábrika: Unidade:
30296 NUTRIPLAN UN/1
F1 F4

UN: R\$ 164,34 AV: R\$ 164,34 15: R\$ 167,77
30: R\$ 171,12 45: R\$ 174,54 60: R\$ 178,03

Produto
* Altura: 128 cm
* Largura: 75 cm



ESTANTE MODULAR 4 PRATELEIRAS PRETA

Código: Fábrika: Unidade:
12899 ANTARES UN/1
F1 F4

UN: R\$ 6,15 AV: R\$ 6,15 15: R\$ 6,28
30: R\$ 6,41 45: R\$ 6,53 60: R\$ 6,67



ESTEIRA MADEIRA FIXA 25 CM IND 162

Código: Fábrika: Unidade:
41323 MAD LAR UN/1
F1 F4

UN: R\$ 6,67 AV: R\$ 6,67 15: R\$ 6,81
30: R\$ 6,94 45: R\$ 7,08 60: R\$ 7,22



ESTEIRA MADEIRA G 25 CM 156

Código: Fábrika: Unidade:
41321 MAD LAR UN/1
F1 F4

UN: R\$ 6,15 AV: R\$ 6,15 15: R\$ 6,28
30: R\$ 6,41 45: R\$ 6,53 60: R\$ 6,67

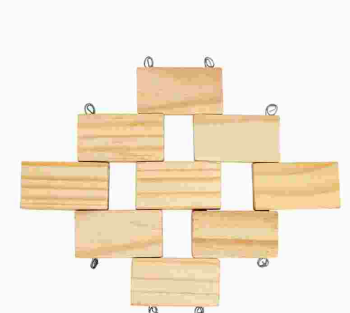

ESTEIRA MADEIRA M 20 CM 157

Código: Fábrika: Unidade:
41322 MAD LAR UN/1
F1 F4

UN: R\$ 8,21 AV: R\$ 8,21 15: R\$ 8,38
30: R\$ 8,55 45: R\$ 8,72 60: R\$ 8,89



ESTERCO DE GALINHA 1 LITRO

Código: Fábrika: Unidade:
48536 NOVATROPICAL PT/1
F1 F4

UN: R\$ 2,04 AV: R\$ 24,53 15: R\$ 25,04
30: R\$ 25,54 45: R\$ 26,05 60: R\$ 26,57



FACA INOX MESA LINHA AMERICA 2224 12X1

Código: Fábrika: Unidade:
50621 STEEL PT/12
F1 F4

UN: R\$ 8,21 AV: R\$ 8,21 15: R\$ 8,38
30: R\$ 8,55 45: R\$ 8,72 60: R\$ 8,89

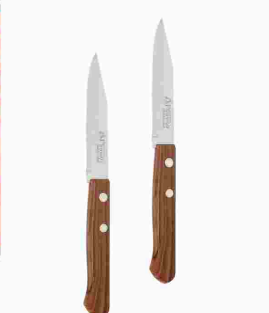

FACA ACO CARBONO 3" CB MAD LEGUMES 222

Código: Fábrika: Unidade:
39348 PLANETA CR/1
F1 F4

UN: R\$ 18,30 AV: R\$ 219,56 15: R\$ 224,14
30: R\$ 228,62 45: R\$ 233,19 60: R\$ 237,86



FACA ACO CARBONO 5" CB MAD 22950/5 12X1
Código: Fábrica: Unidade:
34848 TRAMONTINA DZ/12
F1 F4

UN: R\$ 15,58 AV: R\$ 186,94 15: R\$ 190,83
30: R\$ 194,65 45: R\$ 198,54 60: R\$ 202,52



FACA ACO CARBONO 5" CB MAD 22953/5 12X1
Código: Fábrica: Unidade:
34847 TRAMONTINA DZ/12
F1 F4

UN: R\$ 17,55 AV: R\$ 210,58 15: R\$ 214,96
30: R\$ 219,26 45: R\$ 223,65 60: R\$ 228,12



FACA ACO CARBONO 6" CB MAD 22953/6 12X1
Código: Fábrica: Unidade:
34850 TRAMONTINA DZ/12
F1 F4

UN: R\$ 23,62 AV: R\$ 23,62 15: R\$ 24,11
30: R\$ 24,59 45: R\$ 25,08 60: R\$ 25,58



FACA ACO CARBONO 6" CB MAD 252
Código: Fábrica: Unidade:
39349 PLANETA CR/1
F1 F4

UN: R\$ 19,69 AV: R\$ 236,25 15: R\$ 241,17
30: R\$ 245,99 45: R\$ 250,91 60: R\$ 255,93



FACA ACO CARBONO 7" CB MAD 22953/7 12X1
Código: Fábrica: Unidade:
34849 TRAMONTINA DZ/12
F1 F4

UN: R\$ 2,57 AV: R\$ 30,82 15: R\$ 31,46
30: R\$ 32,09 45: R\$ 32,73 60: R\$ 33,38



FACA ACO INOX 3" CB PLAST COZINHA 12X1
Código: Fábrica: Unidade:
36919 MABEL CX/12
F1 F4

UN: R\$ 15,41 AV: R\$ 15,41 15: R\$ 15,73
30: R\$ 16,04 45: R\$ 16,36 60: R\$ 16,69



FACA ACO INOX 3 1/4" CB PLAST LEGUMES
Código: Fábrica: Unidade:
36573 MUNDIAL UN/1
F1 F4

UN: R\$ 11,13 AV: R\$ 66,76 15: R\$ 68,15
30: R\$ 69,51 45: R\$ 70,90 60: R\$ 72,32



FACA ACO INOX 5" CB MAD CHURRSACO 6X1
Código: Fábrica: Unidade:
46583 MUNDIAL CX/6
F1 F4

UN: R\$ 9,40 AV: R\$ 9,40 15: R\$ 9,59
30: R\$ 9,79 45: R\$ 9,98 60: R\$ 10,18



FACA ACO INOX 5" CB PLAST BCO MAX 53
Código: Fábrica: Unidade:
50100 PLANETA CR/1
F1 F4

UN: R\$ 10,64 AV: R\$ 10,64 15: R\$ 10,86
30: R\$ 11,08 45: R\$ 11,30 60: R\$ 11,53



FACA ACO INOX 5" CB PLAST BCO TOMATE
Código: Fábrica: Unidade:
46578 MUNDIAL UN/1
F1 F4

UN: R\$ 7,78 AV: R\$ 7,78 15: R\$ 7,94
30: R\$ 8,10 45: R\$ 8,26 60: R\$ 8,42



FACA ACO INOX 5" CB PLAST PTO TOMATE
Código: Fábrica: Unidade:
47376 SIMONAGGIO UN/1
F1 F4

UN: R\$ 34,45 AV: R\$ 34,45 15: R\$ 35,17
30: R\$ 35,87 45: R\$ 36,59 60: R\$ 37,32



FACA ACO INOX 6" CB PLAST BCO CARNE 815
Código: Fábrica: Unidade:
36575 MUNDIAL UN/1
F1 F4

UN: R\$ 13,66 AV: R\$ 13,66 15: R\$ 13,95
30: R\$ 14,23 45: R\$ 14,51 60: R\$ 14,80



FACA ACO INOX 6" CB PLAST BCO COZINHA
Código: Fábrica: Unidade:
37807 NICOBEM UN/1
F1 F4

UN: R\$ 32,86 AV: R\$ 32,86 15: R\$ 33,54
30: R\$ 34,22 45: R\$ 34,90 60: R\$ 35,60



FACA ACO INOX 6" CB PLAST BCO COZINHA31
Código: Fábrica: Unidade:
36576 MUNDIAL UN/1
F1 F4

UN: R\$ 16,64 AV: R\$ 16,64 15: R\$ 16,99
30: R\$ 17,33 45: R\$ 17,67 60: R\$ 18,03



FACA ACO INOX 7" CB PLAST BCO COZINHA
Código: Fábrica: Unidade:
50953 HAI BRASIL UN/1
F1 F4

UN: R\$ 10,73 AV: R\$ 10,73 15: R\$ 10,96
30: R\$ 11,18 45: R\$ 11,40 60: R\$ 11,63



FACA ACO INOX 7" CB PLAST BCO MAX 55
Código: Fábrica: Unidade:
47988 PLANETA CR/1
F1 F4

UN: R\$ 22,59 AV: R\$ 22,59 15: R\$ 23,06
30: R\$ 23,52 45: R\$ 23,99 60: R\$ 24,47



FACA ACO INOX 7" CB PLAST PTO CARNE 107
Código: Fábrika: Unidade:
46577 MUNDIAL UN/1
F1 F4

UN: R\$ 10,45 AV: R\$ 10,45 15: R\$ 10,66
30: R\$ 10,88 45: R\$ 11,10 60: R\$ 11,32

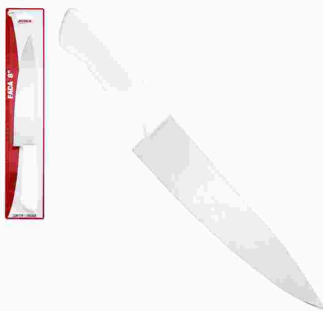

FACA ACO INOX 8" CB PLAST BCO COZINHA
Código: Fábrika: Unidade:
46492 NICOBEM UN/1
F1 F4

UN: R\$ 17,98 AV: R\$ 17,98 15: R\$ 18,35
30: R\$ 18,72 45: R\$ 19,09 60: R\$ 19,47



FACA ACO INOX 8" CB PLAST BCO COZINHA
Código: Fábrika: Unidade:
50945 HAI BRASIL UN/1
F1 F4

UN: R\$ 32,87 AV: R\$ 32,87 15: R\$ 33,56
30: R\$ 34,23 45: R\$ 34,91 60: R\$ 35,61



FACA ACO INOX 8" CB PLAST BCO COZINHA31
Código: Fábrika: Unidade:
36579 MUNDIAL UN/1
F1 F4

UN: R\$ 10,79 AV: R\$ 10,79 15: R\$ 11,01
30: R\$ 11,23 45: R\$ 11,46 60: R\$ 11,68



FACA ACO INOX 8" PAO CB PLAST BCO MAX57
Código: Fábrika: Unidade:
47989 PLANETA CR/1
F1 F4

UN: R\$ 19,51 AV: R\$ 19,51 15: R\$ 19,91
30: R\$ 20,31 45: R\$ 20,72 60: R\$ 21,13



FACA ACO INOX 9" CB PLAST BCO COZINHA
Código: Fábrika: Unidade:
50952 HAI BRASIL UN/1
F1 F4

UN: R\$ 59,06 AV: R\$ 59,06 15: R\$ 60,29
30: R\$ 61,50 45: R\$ 62,73 60: R\$ 63,99



FACA ACO INOX 10" CB PLAST BCO CARNE 781
Código: Fábrika: Unidade:
36581 MUNDIAL UN/1
F1 F4

UN: R\$ 46,94 AV: R\$ 46,94 15: R\$ 47,92
30: R\$ 48,88 45: R\$ 49,86 60: R\$ 50,85



FACA ACO INOX 10" CB PLAST BCO CARNE 820
Código: Fábrika: Unidade:
36582 MUNDIAL UN/1
F1 F4

UN: R\$ 13,61 AV: R\$ 13,61 15: R\$ 13,89
30: R\$ 14,17 45: R\$ 14,46 60: R\$ 14,74



FACA ACO 7" PAO CB PLAST PRETO 6013
Código: Fábrika: Unidade:
44645 MART/SIMONAG UN/1
F1 F4

UN: R\$ 10,79 AV: R\$ 10,79 15: R\$ 11,01
30: R\$ 11,23 45: R\$ 11,46 60: R\$ 11,68



FACA INOX 5" CB PLAST BCO COZINHA 3186
Código: Fábrika: Unidade:
49646 WINMAX UN/1
F1 F4

UN: R\$ 11,29 AV: R\$ 11,29 15: R\$ 11,52
30: R\$ 11,75 45: R\$ 11,99 60: R\$ 12,23



FACA INOX 6" CB PLAST BCO COZINHA 3187
Código: Fábrika: Unidade:
49647 WINMAX UN/1
F1 F4

UN: R\$ 11,60 AV: R\$ 11,60 15: R\$ 11,84
30: R\$ 12,08 45: R\$ 12,32 60: R\$ 12,56



FACA INOX 7" CB PLAST BCO COZINHA 3188
Código: Fábrika: Unidade:
49648 WINMAX UN/1
F1 F4

UN: R\$ 2,05 AV: R\$ 24,64 15: R\$ 25,16
30: R\$ 25,66 45: R\$ 26,17 60: R\$ 26,70



FACA INOX CHURR 20CM VERSA AZ 731 12X1
Código: Fábrika: Unidade:
50162 PLANETA DZ/12
F1 F4

UN: R\$ 18,49 AV: R\$ 18,49 15: R\$ 18,87
30: R\$ 19,25 45: R\$ 19,64 60: R\$ 20,03



FACA INOX KIT C/3 PLENUS CB PLAS BCO 312
Código: Fábrika: Unidade:
40391 TRAMONTINA CR/1
F1 F4

UN: R\$ 18,49 AV: R\$ 18,49 15: R\$ 18,87
30: R\$ 19,25 45: R\$ 19,64 60: R\$ 20,03



FACA INOX KIT C/3 PLENUS CB PLAS PTO 612
Código: Fábrika: Unidade:
40390 TRAMONTINA CR/1
F1 F4

UN: R\$ 2,05 AV: R\$ 6,15 15: R\$ 6,28
30: R\$ 6,41 45: R\$ 6,53 60: R\$ 6,67



FACA INOX MESA LINHA BRONZE 517 3X1
Código: Fábrika: Unidade:
48008 PLANETA PT/3
F1 F4

UN: R\$ 48,27 AV: R\$ 48,27 15: R\$ 49,27
30: R\$ 50,26 45: R\$ 51,26 60: R\$ 52,29



FACA INOX 3PCS CB PLAST GOLDEN DARK 106
Código: Fábrica: Unidade:
41348 HAUSKRAFT CJ/1
F1 F4

UN: R\$ 6,67 AV: R\$ 6,67 15: R\$ 6,81
30: R\$ 6,94 45: R\$ 7,08 60: R\$ 7,22



FACA INOX 3,5" LINH MAX LEGUMES CB BC52
Código: Fábrica: Unidade:
47629 PLANETA CR/1
F1 F4

UN: R\$ 6,28 AV: R\$ 6,28 15: R\$ 6,41
30: R\$ 6,54 45: R\$ 6,67 60: R\$ 6,80



FACA INOX 3,5" LINH MERCOSU LEGUMES 234
Código: Fábrica: Unidade:
46868 PLANETA CR/1
F1 F4

UN: R\$ 20,53 AV: R\$ 20,53 15: R\$ 20,96
30: R\$ 21,38 45: R\$ 21,81 60: R\$ 22,24



FACA INOX 6" CB PLAST P/DESOSSAR 5421
Código: Fábrica: Unidade:
43277 MAGAGIFT CR/1
F1 F4

UN: R\$ 13,10 AV: R\$ 13,10 15: R\$ 13,37
30: R\$ 13,64 45: R\$ 13,91 60: R\$ 14,19



FACA INOX 7" CB MAD JATOBA CTL 225
Código: Fábrica: Unidade:
48692 PLANETA CR/1
F1 F4

UN: R\$ 23,62 AV: R\$ 23,62 15: R\$ 24,11
30: R\$ 24,59 45: R\$ 25,08 60: R\$ 25,58



FACA INOX 7" CB PLAST PROFESSIONAL 5423
Código: Fábrica: Unidade:
43278 MAGAGIFT CR/1
F1 F4

UN: R\$ 13,61 AV: R\$ 13,61 15: R\$ 13,89
30: R\$ 14,17 45: R\$ 14,46 60: R\$ 14,74



FACA INOX 8" CB MAD JATOBA CTL 226
Código: Fábrica: Unidade:
48693 PLANETA CR/1
F1 F4

UN: R\$ 12,32 AV: R\$ 12,32 15: R\$ 12,57
30: R\$ 12,82 45: R\$ 13,08 60: R\$ 13,34



FACA PEIXEIRA ACO CARBONO 5" CB MAD 319
Código: Fábrica: Unidade:
44641 SIMONAGGIO UN/1
F1 F4

UN: R\$ 17,02 AV: R\$ 17,02 15: R\$ 17,38
30: R\$ 17,72 45: R\$ 18,08 60: R\$ 18,44



FACA PEIXEIRA ACO CARBONO 7" CB MAD 321
Código: Fábrica: Unidade:
47375 SIMONAGGIO UN/1
F1 F4

UN: R\$ 17,98 AV: R\$ 17,98 15: R\$ 18,35
30: R\$ 18,72 45: R\$ 19,09 60: R\$ 19,47



FACA PEIXEIRA ACO CARBONO 8" CB MAD 322
Código: Fábrica: Unidade:
44642 SIMONAGGIO UN/1
F1 F4

UN: R\$ 17,45 AV: R\$ 17,45 15: R\$ 17,82
30: R\$ 18,17 45: R\$ 18,54 60: R\$ 18,91



FACA PEIXEIRA ACO 7" CB PLAST VM 321007
Código: Fábrica: Unidade:
44644 SIMONAGGIO UN/1
F1 F4

UN: R\$ 22,59 AV: R\$ 22,59 15: R\$ 23,06
30: R\$ 23,52 45: R\$ 23,99 60: R\$ 24,47



FACA ACO INOX 10" CB MAD 117
Código: Fábrica: Unidade:
45531 WINMAX UN/1
F1 F4

UN: R\$ 1,56 AV: R\$ 18,75 15: R\$ 19,14
30: R\$ 19,52 45: R\$ 19,91 60: R\$ 20,31



FAQUEIRO 12 PCS CB PLAST COLOR 80
Código: Fábrica: Unidade:
41064 TAGLIATORI CJ/12
F1 F4

UN: R\$ 1,44 AV: R\$ 23,11 15: R\$ 23,59
30: R\$ 24,07 45: R\$ 24,55 60: R\$ 25,04



FAQUEIRO 16 PCS CB PLAST COLOR 318
Código: Fábrica: Unidade:
41065 TAGLIATORI CJ/16
F1 F4

UN: R\$ 1,33 AV: R\$ 26,70 15: R\$ 27,25
30: R\$ 27,80 45: R\$ 28,35 60: R\$ 28,92



FAQUEIRO 20 PCS CB PLAST COLOR 313
Código: Fábrica: Unidade:
41063 TAGLIATORI CJ/20
F1 F4

UN: R\$ 1,26 AV: R\$ 30,30 15: R\$ 30,93
30: R\$ 31,55 45: R\$ 32,18 60: R\$ 32,83

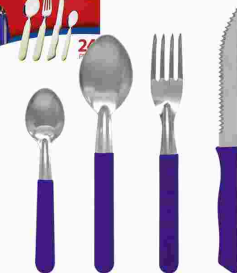

FAQUEIRO 24 PCS CB PLAST COLOR 115
Código: Fábrica: Unidade:
41062 TAGLIATORI CJ/24
F1 F4

UN: R\$ 4,06 AV: R\$ 97,38 15: R\$ 99,41
30: R\$ 101,40 45: R\$ 103,42 60: R\$ 105,49



FAQUEIRO 24 PCS INOX 4829
Código: Fábrica: Unidade:
49759 SQ CJ/24
F1 F4

UN: R\$ 3,85 AV: R\$ 61,62 15: R\$ 62,91
30: R\$ 64,16 45: R\$ 65,45 60: R\$ 66,76



FAQUEIRO 25 PCS CB PLAST BCO PORTA TALHE
Código: Fábrica: Unidade:
41337 HAUSKRAFT CJ/16
F1 F4

UN: R\$ 3,85 AV: R\$ 61,62 15: R\$ 62,91
30: R\$ 64,16 45: R\$ 65,45 60: R\$ 66,76



FAQUEIRO 25 PCS CB PLAST PTO PORTA TALHE
Código: Fábrica: Unidade:
41338 HAUSKRAFT CJ/16
F1 F4

UN: R\$ 3,85 AV: R\$ 61,62 15: R\$ 62,91
30: R\$ 64,16 45: R\$ 65,45 60: R\$ 66,76



FAQUEIRO 25 PCS CB PLAST VM PORTA TALHE
Código: Fábrica: Unidade:
41339 HAUSKRAFT CJ/16
F1 F4

UN: R\$ 6,48 AV: R\$ 6,48 15: R\$ 6,61
30: R\$ 6,75 45: R\$ 6,88 60: R\$ 7,02



FARINHEIRO PLAST 800 ML LEITOSO 21
Código: Fábrica: Unidade:
40374 FORMPLAST UN/1
F1 F4

UN: R\$ 4,06 AV: R\$ 4,06 15: R\$ 4,14
30: R\$ 4,22 45: R\$ 4,31 60: R\$ 4,40



FATIADOR INOX PIZZA 18,9CM 8178
Código: Fábrica: Unidade:
44729 WINCY UN/1
F1 F4

UN: R\$ 7,83 AV: R\$ 7,83 15: R\$ 7,99
30: R\$ 8,15 45: R\$ 8,31 60: R\$ 8,48



FERRAMENTA ACO CB PLAST JARDIM 2X1 74307
Código: Fábrica: Unidade:
49599 ALMEGA CJ/1
F1 F4

UN: R\$ 6,66 AV: R\$ 6,66 15: R\$ 6,79
30: R\$ 6,93 45: R\$ 7,07 60: R\$ 7,21



FERRAMENTA ESPATULA METAL CB PLAST 3080
Código: Fábrica: Unidade:
38453 FENIMA UN/1
F1 F4

UN: R\$ 10,98 AV: R\$ 10,98 15: R\$ 11,21
30: R\$ 11,43 45: R\$ 11,66 60: R\$ 11,90



FERRAMENTA PLAST ARRANCADOR 28,6CM VERDE
Código: Fábrica: Unidade:
47609 NUTRIPLAN UN/1
F1 F4

UN: R\$ 9,69 AV: R\$ 38,78 15: R\$ 39,58
30: R\$ 40,38 45: R\$ 41,18 60: R\$ 42,01



FERRAMENTA PLAST KIT RAST/PA/ARRAN VERDE
Código: Fábrica: Unidade:
47610 NUTRIPLAN CJ/4
F1 F4

UN: R\$ 10,98 AV: R\$ 10,98 15: R\$ 11,21
30: R\$ 11,43 45: R\$ 11,66 60: R\$ 11,90



FERRAMENTA PLAST PAZINHA ESTR 28CM VERDE
Código: Fábrica: Unidade:
47608 NUTRIPLAN UN/1
F1 F4

UN: R\$ 10,98 AV: R\$ 10,98 15: R\$ 11,21
30: R\$ 11,43 45: R\$ 11,66 60: R\$ 11,90



FERRAMENTA PLAST PAZINHA 27,5CM VERDE
Código: Fábrica: Unidade:
47607 NUTRIPLAN UN/1
F1 F4

UN: R\$ 10,98 AV: R\$ 10,98 15: R\$ 11,21
30: R\$ 11,43 45: R\$ 11,66 60: R\$ 11,90



FERRAMENTA PLAST RATELO 24CM VERDE
Código: Fábrica: Unidade:
47606 NUTRIPLAN UN/1
F1 F4

UN: R\$ 26,70 AV: R\$ 26,70 15: R\$ 27,25
30: R\$ 27,80 45: R\$ 28,35 60: R\$ 28,92



FERRAMENTA TESOURA P/PODA 46CM AIH1239
Código: Fábrica: Unidade:
42465 AIH UN/1
F1 F4

UN: R\$ 30,82 AV: R\$ 30,82 15: R\$ 31,46
30: R\$ 32,09 45: R\$ 32,73 60: R\$ 33,38



FERRAMENTA TESOURA P/PODA 8" CTL 9165T
Código: Fábrica: Unidade:
40077 IDEIA UN/1
F1 F4

UN: R\$ 12,20 AV: R\$ 12,20 15: R\$ 12,46
30: R\$ 12,71 45: R\$ 12,96 60: R\$ 13,22



FERTILIZANTE CACTOS SUCULENTAS 150GRS CX
Código: Fábrica: Unidade:
33547 VITAPLAN CX/1
F1 F4

UN: R\$ 25,52 AV: R\$ 25,52 15: R\$ 26,05
30: R\$ 26,57 45: R\$ 27,10 60: R\$ 27,64



FERTILIZANTE COMP ORGANICO JAPONES 800G
Código: Fábrica: Unidade:
39213 VITAPLAN CX/1
F1 F4

UN: R\$ 23,62 AV: R\$ 23,62 15: R\$ 24,11
30: R\$ 24,59 45: R\$ 25,08 60: R\$ 25,58



FERTILIZANTE FARINHA DE OSSO 1KG C/CX
Código: Fábrica: Unidade:
30303 VITAPLAN CX/1
F1 F4

UN: R\$ 13,15 AV: R\$ 13,15 15: R\$ 13,42
30: R\$ 13,69 45: R\$ 13,96 60: R\$ 14,24



FERTILIZANTE NUTRIFLORES 250 GRS POTE
Código: Fábrica: Unidade:
39653 VITAPLAN CX/1
F1 F4

UN: R\$ 32,14 AV: R\$ 32,14 15: R\$ 32,81
30: R\$ 33,47 45: R\$ 34,14 60: R\$ 34,82



FERTILIZANTE NUTRIFLORES 500 GRS POTE
Código: Fábrica: Unidade:
39212 VITAPLAN CX/1
F1 F4

UN: R\$ 35,28 AV: R\$ 35,28 15: R\$ 36,02
30: R\$ 36,74 45: R\$ 37,47 60: R\$ 38,22



FERTILIZANTE NUTRIFRUTAS 600 GRS POTE
Código: Fábrica: Unidade:
49345 VITAPLAN CX/1
F1 F4

UN: R\$ 17,98 AV: R\$ 17,98 15: R\$ 18,35
30: R\$ 18,72 45: R\$ 19,09 60: R\$ 19,47



FERTILIZANTE NUTRIPLANTAS 250 GRS POTE
Código: Fábrica: Unidade:
44136 VITAPLAN CX/1
F1 F4

UN: R\$ 27,99 AV: R\$ 27,99 15: R\$ 28,57
30: R\$ 29,15 45: R\$ 29,73 60: R\$ 30,32



FERTILIZANTE NUTRIPLANTAS 500 GRS POTE
Código: Fábrica: Unidade:
44132 VITAPLAN UN/1
F1 F4

UN: R\$ 16,27 AV: R\$ 16,27 15: R\$ 16,61
30: R\$ 16,94 45: R\$ 17,28 60: R\$ 17,63



FERTILIZANTE NUTRIVERDE 250 GRS POTE
Código: Fábrica: Unidade:
39654 VITAPLAN CX/1
F1 F4

UN: R\$ 24,24 AV: R\$ 24,24 15: R\$ 24,75
30: R\$ 25,24 45: R\$ 25,75 60: R\$ 26,26



FERTILIZANTE NUTRIVERDE 500 GRS POTE
Código: Fábrica: Unidade:
23212 VITAPLAN CX/1
F1 F4

UN: R\$ 41,08 AV: R\$ 41,08 15: R\$ 41,93
30: R\$ 42,77 45: R\$ 43,63 60: R\$ 44,50



FERTILIZANTE NUTRIVERDE 600 GRS POTE
Código: Fábrica: Unidade:
49344 VITAPLAN CX/1
F1 F4

UN: R\$ 9,75 AV: R\$ 9,75 15: R\$ 9,95
30: R\$ 10,15 45: R\$ 10,35 60: R\$ 10,56



FERTILIZANTE ORQUIDEAS 150 GRS C/CX
Código: Fábrica: Unidade:
22292 VITAPLAN UN/1
F1 F4

UN: R\$ 9,75 AV: R\$ 9,75 15: R\$ 9,95
30: R\$ 10,15 45: R\$ 10,35 60: R\$ 10,56



FERTILIZANTE SAMAMBAIAS 150 GRS
Código: Fábrica: Unidade:
22291 VITAPLAN CX/1
F1 F4

UN: R\$ 23,62 AV: R\$ 23,62 15: R\$ 24,11
30: R\$ 24,59 45: R\$ 25,08 60: R\$ 25,58



FERTILIZANTE TORTA MAMONA +FARIN OSSO 1K
Código: Fábrica: Unidade:
30301 VITAPLAN CX/1
F1 F4

UN: R\$ 9,79 AV: R\$ 9,79 15: R\$ 9,99
30: R\$ 10,19 45: R\$ 10,40 60: R\$ 10,60



FERTILIZANTE VIOLETA 150 GR
Código: Fábrica: Unidade:
22290 VITAPLAN CX/1
F1 F4

11,5 cm
8,5 cm

UN: R\$ 30,81 AV: R\$ 30,81 15: R\$ 31,45
30: R\$ 32,08 45: R\$ 32,72 60: R\$ 33,37



FERTILIZANTE 04-14-08 1 KG C/CX
Código: Fábrica: Unidade:
22294 VITAPLAN UN/1
F1 F4

UN: R\$ 7,18 AV: R\$ 7,18 15: R\$ 7,33
30: R\$ 7,48 45: R\$ 7,63 60: R\$ 7,78



FERTILIZANTE 04-14-08 1 KG SACO
Código: Fábrica: Unidade:
30800 FAZENDEIRO KG/1
F1 F4

UN: R\$ 28,75 AV: R\$ 28,75 15: R\$ 29,35
30: R\$ 29,94 45: R\$ 30,54 60: R\$ 31,15



FERTILIZANTE 04-14-08 1 KG SACO

Código: Fábrica: Unidade:
30297 VITAPLAN UN/1
F1 F4

UN: R\$ 31,83 AV: R\$ 31,83 15: R\$ 32,50
30: R\$ 33,15 45: R\$ 33,81 60: R\$ 34,49

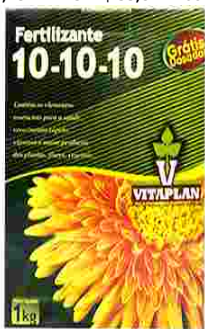

FERTILIZANTE 10-10-10 1 KG C/CX

Código: Fábrica: Unidade:
22293 VITAPLAN UN/1
F1 F4

UN: R\$ 25,67 AV: R\$ 25,67 15: R\$ 26,20
30: R\$ 26,73 45: R\$ 27,26 60: R\$ 27,81



FERTILIZANTE 10-10-10 1 KG SACO

Código: Fábrica: Unidade:
30298 VITAPLAN UN/1
F1 F4

UN: R\$ 25,67 AV: R\$ 25,67 15: R\$ 26,20
30: R\$ 26,73 45: R\$ 27,26 60: R\$ 27,81



FERVEDOR ALUM LEVE 14 C/ TAMP 1,7 LTS

Código: Fábrica: Unidade:
5895 AVELAR UN/1
F1 F4

UN: R\$ 5,25 AV: R\$ 5,25 15: R\$ 5,36
30: R\$ 5,47 45: R\$ 5,57 60: R\$ 5,69



FILME PVC TRANSP 25CMX15M 21752

Código: Fábrica: Unidade:
50077 BOMPACK RL/1
F1 F4

UN: R\$ 23,86 AV: R\$ 23,86 15: R\$ 24,36
30: R\$ 24,85 45: R\$ 25,34 60: R\$ 25,85



FILME PVC TRANSP 28CMX100M 23263

Código: Fábrica: Unidade:
50078 BOMPACK RL/1
F1 F4

UN: R\$ 25,67 AV: R\$ 25,67 15: R\$ 26,20
30: R\$ 26,73 45: R\$ 27,26 60: R\$ 27,81



FILTRA OLEO ALUM LEVE 1 1,0 LT

Código: Fábrica: Unidade:
36286 AVELAR UN/1
F1 F4

UN: R\$ 20,53 AV: R\$ 20,53 15: R\$ 20,96
30: R\$ 21,38 45: R\$ 21,81 60: R\$ 22,24



FILTRA OLEO ALUMINIO 12 673

Código: Fábrica: Unidade:
24782 MSR UN/1
F1 F4

UN: R\$ 69,64 AV: R\$ 69,64 15: R\$ 71,10
30: R\$ 72,52 45: R\$ 73,97 60: R\$ 75,45



FILTRO COADOR INOX P/CAFE 103 4380

Código: Fábrica: Unidade:
49758 SQ UN/1
F1 F4

UN: R\$ 5,99 AV: R\$ 71,89 15: R\$ 73,39
30: R\$ 74,86 45: R\$ 76,36 60: R\$ 77,88



FILTRO PERMANENTE P/ COAR CAFE 102 12X1

Código: Fábrica: Unidade:
27442 FERREIRA DZ/12
F1 F4

UN: R\$ 6,42 AV: R\$ 77,03 15: R\$ 78,63
30: R\$ 80,21 45: R\$ 81,81 60: R\$ 83,45



FILTRO PERMANENTE P/ COAR CAFE 103 12X1

Código: Fábrica: Unidade:
27443 FERREIRA DZ/12
F1 F4

UN: R\$ 2,10 AV: R\$ 25,17 15: R\$ 25,69
30: R\$ 26,20 45: R\$ 26,73 60: R\$ 27,26



FLANELA BRANCA 28X38 CM 12X1

Código: Fábrica: Unidade:
34897 MC PANOS PT/12
F1 F4

UN: R\$ 3,00 AV: R\$ 35,94 15: R\$ 36,69
30: R\$ 37,42 45: R\$ 38,17 60: R\$ 38,94



FLANELA BRANCA 36X56CM 12X1

Código: Fábrica: Unidade:
34501 P & F PT/12
F1 F4

UN: R\$ 4,36 AV: R\$ 52,38 15: R\$ 53,47
30: R\$ 54,54 45: R\$ 55,63 60: R\$ 56,74



FLANELA COLOR 38X58 CM 12X1

Código: Fábrica: Unidade:
42841 MC PANOS PT/12
F1 F4

UN: R\$ 11,29 AV: R\$ 11,29 15: R\$ 11,52
30: R\$ 11,75 45: R\$ 11,99 60: R\$ 12,23

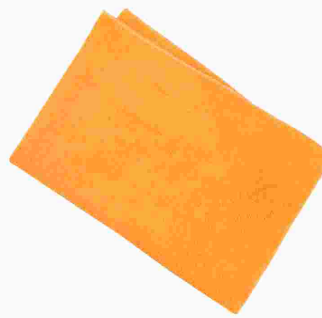

FLANELA MICROFIBRA 50X70 CM COLOR

Código: Fábrica: Unidade:
44155 MC PANOS UN/1
F1 F4

UN: R\$ 16,42 AV: R\$ 16,42 15: R\$ 16,77
30: R\$ 17,10 45: R\$ 17,44 60: R\$ 17,79



FORMA ALUM BOLO ALTA 01 1966

Código: Fábrica: Unidade:
37514 MSR UN/1
F1 F4

UN: R\$ 22,59 AV: R\$ 22,59 15: R\$ 23,06
30: R\$ 23,52 45: R\$ 23,99 60: R\$ 24,47



FORMA ALUM BOLO ALTA 02 1967

Código: Fábrika: Unidade:
37515 MSR UN/1
F1 F4

UN: R\$ 23,62 AV: R\$ 23,62 15: R\$ 24,11
30: R\$ 24,59 45: R\$ 25,08 60: R\$ 25,58



FORMA ALUM BOLO ALTA 03 1968

Código: Fábrika: Unidade:
37516 MSR UN/1
F1 F4

UN: R\$ 17,82 AV: R\$ 17,82 15: R\$ 18,19
30: R\$ 18,56 45: R\$ 18,93 60: R\$ 19,31



FORMA ALUM CB MAD BAURUTEX OVAL 2014 UN

Código: Fábrika: Unidade:
48073 COFAX UN/1
F1 F4

UN: R\$ 0,64 AV: R\$ 7,69 15: R\$ 7,85
30: R\$ 8,01 45: R\$ 8,17 60: R\$ 8,33



FORMA ALUM EMPADA CRESPA 2 009 CTL 12X1

Código: Fábrika: Unidade:
41356 WESTERN CR/12
F1 F4

UN: R\$ 0,39 AV: R\$ 4,62 15: R\$ 4,72
30: R\$ 4,81 45: R\$ 4,91 60: R\$ 5,01



FORMA ALUM EMPADA LISA 0 12X1

Código: Fábrika: Unidade:
36896 MABEL DZ/12
F1 F4

UN: R\$ 1,18 AV: R\$ 14,12 15: R\$ 14,42
30: R\$ 14,71 45: R\$ 15,00 60: R\$ 15,30



FORMA ALUM EMPADA LISA 00 12X1

Código: Fábrika: Unidade:
44386 DAMIAO DZ/12
F1 F4

UN: R\$ 0,64 AV: R\$ 7,69 15: R\$ 7,85
30: R\$ 8,01 45: R\$ 8,17 60: R\$ 8,33



FORMA ALUM EMPADA LISA 1 CTL 011 12X1

Código: Fábrika: Unidade:
41357 WESTERN CR/12
F1 F4

UN: R\$ 1,37 AV: R\$ 16,42 15: R\$ 16,77
30: R\$ 17,10 45: R\$ 17,44 60: R\$ 17,79



FORMA ALUM EMPADA LISA 1 12X1

Código: Fábrika: Unidade:
44388 DAMIAO DZ/12
F1 F4

UN: R\$ 0,68 AV: R\$ 8,21 15: R\$ 8,38
30: R\$ 8,55 45: R\$ 8,72 60: R\$ 8,89



FORMA ALUM EMPADA LISA 2 CTL 012 12X1

Código: Fábrika: Unidade:
41355 WESTERN CR/12
F1 F4

UN: R\$ 1,45 AV: R\$ 17,45 15: R\$ 17,82
30: R\$ 18,17 45: R\$ 18,54 60: R\$ 18,91



FORMA ALUM EMPADA LISA 2 12X1

Código: Fábrika: Unidade:
44389 DAMIAO DZ/12
F1 F4

UN: R\$ 1,67 AV: R\$ 20,03 15: R\$ 20,45
30: R\$ 20,86 45: R\$ 21,27 60: R\$ 21,70



FORMA ALUM EMPADA LISA 3 12X1

Código: Fábrika: Unidade:
44390 DAMIAO DZ/12
F1 F4

UN: R\$ 0,51 AV: R\$ 3,07 15: R\$ 3,14
30: R\$ 3,20 45: R\$ 3,26 60: R\$ 3,33



FORMA ALUM EMPADA LISA 3 6X1

Código: Fábrika: Unidade:
41448 MABEL PT/6
F1 F4

UN: R\$ 2,05 AV: R\$ 24,64 15: R\$ 25,16
30: R\$ 25,66 45: R\$ 26,17 60: R\$ 26,70



FORMA ALUM EMPADA LISA 4 12X1

Código: Fábrika: Unidade:
44391 DAMIAO DZ/12
F1 F4

UN: R\$ 3,25 AV: R\$ 39,02 15: R\$ 39,84
30: R\$ 40,63 45: R\$ 41,45 60: R\$ 42,27



FORMA ALUM EMPADA LISA 5 12X1

Código: Fábrika: Unidade:
44392 DAMIAO DZ/12
F1 F4

UN: R\$ 3,65 AV: R\$ 43,76 15: R\$ 44,67
30: R\$ 45,56 45: R\$ 46,48 60: R\$ 47,40



FORMA ALUM EMPADA LISA 6 12X1

Código: Fábrika: Unidade:
25554 DAMIAO DZ/12
F1 F4

UN: R\$ 5,56 AV: R\$ 66,76 15: R\$ 68,15
30: R\$ 69,51 45: R\$ 70,90 60: R\$ 72,32



FORMA ALUM EMPADA LISA 7 12X1

Código: Fábrika: Unidade:
38505 DAMIAO DZ/12
F1 F4

UN: R\$ 29,10 AV: R\$ 87,30 15: R\$ 89,12
30: R\$ 90,90 45: R\$ 92,72 60: R\$ 94,58



FORMA ALUM FDO REMOV 23/26/28CM 710 3X1

Código: Fábrika: Unidade:
41250 123UTIL CX/3
F1 F4

UN: R\$ 25,67 AV: R\$ 25,67 15: R\$ 26,20
30: R\$ 26,73 45: R\$ 27,26 60: R\$ 27,81



FORMA ALUM LEVE PIZZA 30

Código: Fábrika: Unidade:
5900 AVELAR UN/1
F1 F4

UN: R\$ 25,67 AV: R\$ 25,67 15: R\$ 26,20
30: R\$ 26,73 45: R\$ 27,26 60: R\$ 27,81



FORMA ALUM LEVE PUDIM 18

Código: Fábrika: Unidade:
27867 AVELAR UN/1
F1 F4

UN: R\$ 25,67 AV: R\$ 25,67 15: R\$ 26,20
30: R\$ 26,73 45: R\$ 27,26 60: R\$ 27,81



FORMA ALUM LEVE TORTA 24

Código: Fábrika: Unidade:
5901 AVELAR UN/1
F1 F4

UN: R\$ 14,37 AV: R\$ 14,37 15: R\$ 14,67
30: R\$ 14,96 45: R\$ 15,26 60: R\$ 15,57



FORMA ALUM PAO 01 1253

Código: Fábrika: Unidade:
37256 MSR UN/1
F1 F4

UN: R\$ 22,59 AV: R\$ 22,59 15: R\$ 23,06
30: R\$ 23,52 45: R\$ 23,99 60: R\$ 24,47



FORMA ALUM PAO 02 1254

Código: Fábrika: Unidade:
37255 MSR UN/1
F1 F4

UN: R\$ 29,78 AV: R\$ 29,78 15: R\$ 30,40
30: R\$ 31,01 45: R\$ 31,63 60: R\$ 32,26



FORMA ALUM PAO 03 1255

Código: Fábrika: Unidade:
37448 MSR UN/1
F1 F4

UN: R\$ 4,10 AV: R\$ 4,10 15: R\$ 4,18
30: R\$ 4,27 45: R\$ 4,35 60: R\$ 4,44



FORMA ALUM PIZZA MINI 12 CM 696

Código: Fábrika: Unidade:
37528 MSR UN/1
F1 F4

UN: R\$ 16,42 AV: R\$ 16,42 15: R\$ 16,77
30: R\$ 17,10 45: R\$ 17,44 60: R\$ 17,79



FORMA ALUM PIZZA 25 1229

Código: Fábrika: Unidade:
35274 MSR UN/1
F1 F4

UN: R\$ 23,62 AV: R\$ 23,62 15: R\$ 24,11
30: R\$ 24,59 45: R\$ 25,08 60: R\$ 25,58



FORMA ALUM PIZZA 30 675

Código: Fábrika: Unidade:
25308 MSR UN/1
F1 F4

UN: R\$ 34,91 AV: R\$ 34,91 15: R\$ 35,64
30: R\$ 36,35 45: R\$ 37,08 60: R\$ 37,82



FORMA ALUM PIZZA 35 674

Código: Fábrika: Unidade:
20736 MSR UN/1
F1 F4

UN: R\$ 40,06 AV: R\$ 40,06 15: R\$ 40,90
30: R\$ 41,71 45: R\$ 42,55 60: R\$ 43,40



FORMA ALUM POLIDO 22 BOLO VITORIA

Código: Fábrika: Unidade:
48127 ALEGRETE UN/1
F1 F4

UN: R\$ 7,18 AV: R\$ 7,18 15: R\$ 7,33
30: R\$ 7,48 45: R\$ 7,63 60: R\$ 7,78



FORMA ALUM PUDIM 12 MINI 1955

Código: Fábrika: Unidade:
37524 MSR UN/1
F1 F4

UN: R\$ 13,86 AV: R\$ 13,86 15: R\$ 14,15
30: R\$ 14,43 45: R\$ 14,72 60: R\$ 15,01



FORMA ALUM PUDIM 16 679

Código: Fábrika: Unidade:
24364 MSR UN/1
F1 F4

UN: R\$ 15,40 AV: R\$ 15,40 15: R\$ 15,72
30: R\$ 16,03 45: R\$ 16,35 60: R\$ 16,68



FORMA ALUM PUDIM 18 680

Código: Fábrika: Unidade:
24363 MSR UN/1
F1 F4

UN: R\$ 17,45 AV: R\$ 17,45 15: R\$ 17,82
30: R\$ 18,17 45: R\$ 18,54 60: R\$ 18,91



FORMA ALUM PUDIM 20 681

Código: Fábrika: Unidade:
24362 MSR UN/1
F1 F4

UN: R\$ 19,51 AV: R\$ 19,51 15: R\$ 19,91
30: R\$ 20,31 45: R\$ 20,72 60: R\$ 21,13



FORMA ALUM PUDIM 22 682

Código: Fábrica: Unidade:
24361 MSR UN/1
F1 F4

UN: R\$ 28,75 AV: R\$ 28,75 15: R\$ 29,35
30: R\$ 29,94 45: R\$ 30,54 60: R\$ 31,15



FORMA ALUM PUDIM 26 1969

Código: Fábrica: Unidade:
37522 MSR UN/1
F1 F4

UN: R\$ 22,59 AV: R\$ 22,59 15: R\$ 23,06
30: R\$ 23,52 45: R\$ 23,99 60: R\$ 24,47



FORMA ALUM TORTA 25 676

Código: Fábrica: Unidade:
8236 MSR UN/1
F1 F4

UN: R\$ 30,81 AV: R\$ 30,81 15: R\$ 31,45
30: R\$ 32,08 45: R\$ 32,72 60: R\$ 33,37



FORMA ALUM TORTA 30 677

Código: Fábrica: Unidade:
22730 MSR UN/1
F1 F4

UN: R\$ 36,97 AV: R\$ 36,97 15: R\$ 37,74
30: R\$ 38,49 45: R\$ 39,26 60: R\$ 40,05



FORMA ALUM TORTA 35 678

Código: Fábrica: Unidade:
8238 MSR UN/1
F1 F4

UN: R\$ 3,07 AV: R\$ 3,07 15: R\$ 3,14
30: R\$ 3,20 45: R\$ 3,26 60: R\$ 3,33



FORMA PLAST GELO COLOR 151

Código: Fábrica: Unidade:
12666 FORMPLAST UN/1
F1 F4

UN: R\$ 4,05 AV: R\$ 4,05 15: R\$ 4,13
30: R\$ 4,21 45: R\$ 4,30 60: R\$ 4,38

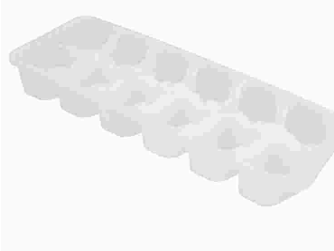

FORMA PLAST GELO TRANSP FAFILLITA 6211

Código: Fábrica: Unidade:
20713 RISCHIOTO UN/1
F1 F4

UN: R\$ 5,37 AV: R\$ 10,74 15: R\$ 10,97
30: R\$ 11,19 45: R\$ 11,41 60: R\$ 11,64

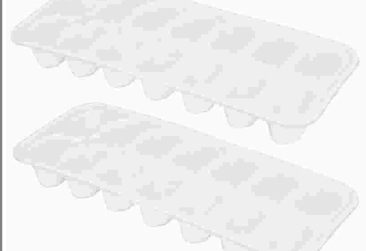

FORMA PLAST GELO 3105 2X1

Código: Fábrica: Unidade:
47056 JAGUAR CJ/2
F1 F4

UN: R\$ 5,36 AV: R\$ 5,36 15: R\$ 5,47
30: R\$ 5,58 45: R\$ 5,69 60: R\$ 5,81

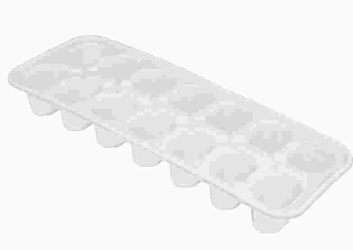

FORMA PLAST GELO 615

Código: Fábrica: Unidade:
9986 JAGUAR UN/1
F1 F4

UN: R\$ 3,37 AV: R\$ 6,73 15: R\$ 6,87
30: R\$ 7,01 45: R\$ 7,15 60: R\$ 7,29

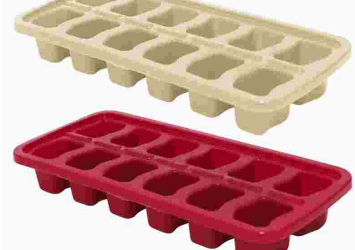

FORMA PLAST GELO 6626 2X1

Código: Fábrica: Unidade:
22501 INPLAST CJ/2
F1 F4

UN: R\$ 8,60 AV: R\$ 8,60 15: R\$ 8,78
30: R\$ 8,95 45: R\$ 9,13 60: R\$ 9,32

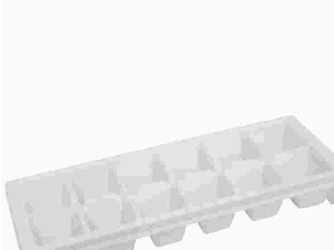

FORMA PLAST P/GELO 502

Código: Fábrica: Unidade:
35497 TRITEC UN/1
F1 F4

UN: R\$ 0,73 AV: R\$ 8,73 15: R\$ 8,91
30: R\$ 9,09 45: R\$ 9,27 60: R\$ 9,46



FORMINHA INOX CORTADOR COOKIE 12X1

Código: Fábrica: Unidade:
40525 MINGJIAN DZ/12
F1 F4

UN: R\$ 369,78 AV: R\$ 369,78 15: R\$ 377,49
30: R\$ 385,04 45: R\$ 392,74 60: R\$ 400,59



FORRO MESA LAMINADO 50M 614 0,10MM CRIST

Código: Fábrica: Unidade:
39358 PERFETTO RL/1
F1 F4

UN: R\$ 346,17 AV: R\$ 346,17 15: R\$ 353,38
30: R\$ 360,45 45: R\$ 367,65 60: R\$ 375,01



FORRO MESA LAMINADO 50M 617 CRISTAL OUTO

Código: Fábrica: Unidade:
39359 PERFETTO RL/1
F1 F4

UN: R\$ 346,17 AV: R\$ 346,17 15: R\$ 353,38
30: R\$ 360,45 45: R\$ 367,65 60: R\$ 375,01

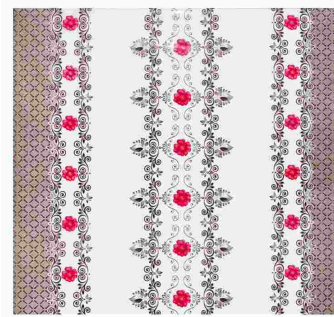

FORRO MESA LAMINADO 50M 619 CRISTAL HIBI

Código: Fábrica: Unidade:
39360 PERFETTO RL/1
F1 F4

UN: R\$ 346,17 AV: R\$ 346,17 15: R\$ 353,38
30: R\$ 360,45 45: R\$ 367,65 60: R\$ 375,01

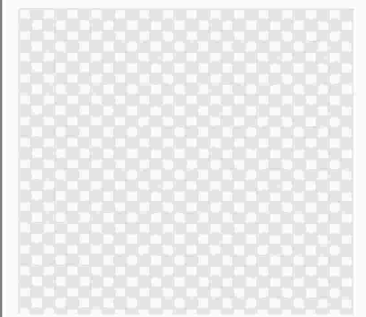

FORRO MESA LAMINADO 50M 623 CRISTAL XADR

Código: Fábrica: Unidade:
39964 PERFETTO RL/1
F1 F4

UN: R\$ 346,17 AV: R\$ 346,17 15: R\$ 353,38
30: R\$ 360,45 45: R\$ 367,65 60: R\$ 375,01

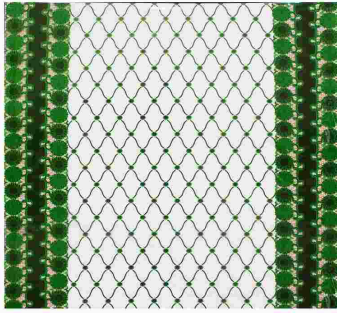

FORRO MESA LAMINADO 50M 626 CRISTAL FLOX
Código: Fábrika: Unidade:
39963 PERFETTO RL/1
F1 F4

UN: R\$ 346,17 AV: R\$ 346,17 15: R\$ 353,38
30: R\$ 360,45 45: R\$ 367,65 60: R\$ 375,01

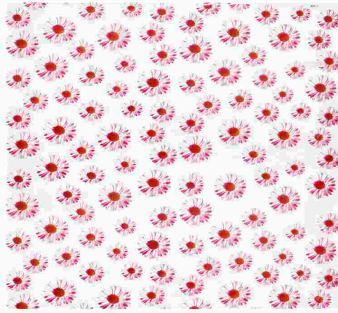

FORRO MESA LAMINADO 50M 659 CRISTAL MARG
Código: Fábrika: Unidade:
39361 PERFETTO RL/1
F1 F4

UN: R\$ 346,17 AV: R\$ 346,17 15: R\$ 353,38
30: R\$ 360,45 45: R\$ 367,65 60: R\$ 375,01

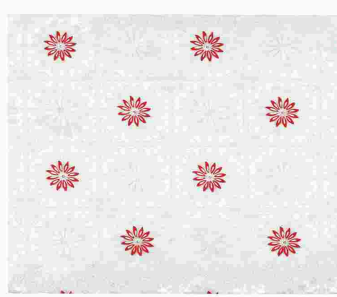

FORRO MESA LAMINADO 50M 663 CRISTAL FLOR
Código: Fábrika: Unidade:
39362 PERFETTO RL/1
F1 F4

UN: R\$ 346,17 AV: R\$ 346,17 15: R\$ 353,38
30: R\$ 360,45 45: R\$ 367,65 60: R\$ 375,01

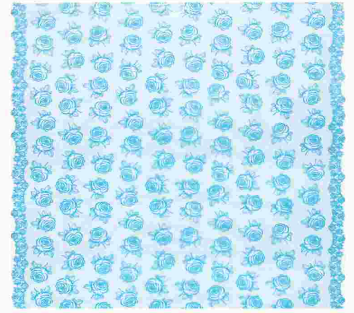

FORRO MESA LAMINADO 50M 665 CRISTAL ROSA
Código: Fábrika: Unidade:
44661 PERFETTO RL/1
F1 F4

UN: R\$ 346,17 AV: R\$ 346,17 15: R\$ 353,38
30: R\$ 360,45 45: R\$ 367,65 60: R\$ 375,01

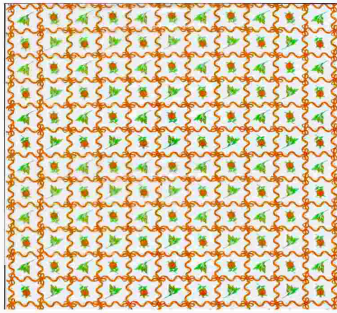

FORRO MESA LAMINADO 50M 669 CRISTAL FLOR
Código: Fábrika: Unidade:
44659 PERFETTO RL/1
F1 F4

UN: R\$ 346,17 AV: R\$ 346,17 15: R\$ 353,38
30: R\$ 360,45 45: R\$ 367,65 60: R\$ 375,01



FORRO MESA LAMINADO 50M 670 CRISTAL LACO
Código: Fábrika: Unidade:
39363 PERFETTO RL/1
F1 F4

UN: R\$ 346,17 AV: R\$ 346,17 15: R\$ 353,38
30: R\$ 360,45 45: R\$ 367,65 60: R\$ 375,01

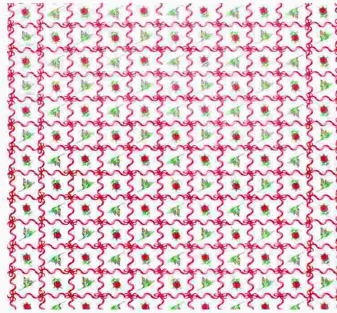

FORRO MESA LAMINADO 50M 670/1 XAD VERMEL
Código: Fábrika: Unidade:
48662 PERFETTO RL/1
F1 F4

UN: R\$ 441,69 AV: R\$ 441,69 15: R\$ 450,99
30: R\$ 459,91 45: R\$ 469,10 60: R\$ 478,49



FORRO MESA LAMINADO 50M 694 0,15MM CRIST
Código: Fábrika: Unidade:
42507 PERFETTO RL/1
F1 F4

UN: R\$ 32,86 AV: R\$ 32,86 15: R\$ 33,54
30: R\$ 34,22 45: R\$ 34,90 60: R\$ 35,60



FORRO MESA PEQ TERMICO 1,40X1,40CM T
Código: Fábrika: Unidade:
14558 FERREIRA UN/1
F1 F4

UN: R\$ 10,22 AV: R\$ 306,67 15: R\$ 313,06
30: R\$ 319,32 45: R\$ 325,71 60: R\$ 332,22



FORRO MESA TERMICO 30M 902 FLORAL ROSAS
Código: Fábrika: Unidade:
39365 PERFETTO RL/30
F1 F4

UN: R\$ 10,22 AV: R\$ 306,67 15: R\$ 313,06
30: R\$ 319,32 45: R\$ 325,71 60: R\$ 332,22



FORRO MESA TERMICO 30M 912 FLORAL MARIA
Código: Fábrika: Unidade:
39366 PERFETTO RL/30
F1 F4

UN: R\$ 10,22 AV: R\$ 306,67 15: R\$ 313,06
30: R\$ 319,32 45: R\$ 325,71 60: R\$ 332,22



FORRO MESA TERMICO 30M 1024 PONTO CRUZ M
Código: Fábrika: Unidade:
40814 PERFETTO RL/30
F1 F4

UN: R\$ 10,22 AV: R\$ 306,67 15: R\$ 313,06
30: R\$ 319,32 45: R\$ 325,71 60: R\$ 332,22



FORRO MESA TERMICO 30M 1107 VASO CORACAO
Código: Fábrika: Unidade:
40815 PERFETTO RL/30
F1 F4

UN: R\$ 10,22 AV: R\$ 306,67 15: R\$ 313,06
30: R\$ 319,32 45: R\$ 325,71 60: R\$ 332,22



FORRO MESA TERMICO 30M 1113 CAFE JADE
Código: Fábrika: Unidade:
40816 PERFETTO RL/30
F1 F4

UN: R\$ 10,22 AV: R\$ 306,67 15: R\$ 313,06
30: R\$ 319,32 45: R\$ 325,71 60: R\$ 332,22



FORRO MESA TERMICO 30M 1114 CAFE HOTENSI
Código: Fábrika: Unidade:
42504 PERFETTO RL/30
F1 F4

UN: R\$ 10,22 AV: R\$ 306,67 15: R\$ 313,06
30: R\$ 319,32 45: R\$ 325,71 60: R\$ 332,22



FORRO MESA TERMICO 30M 1115 GIRASSOL MAR
Código: Fábrika: Unidade:
40817 PERFETTO RL/30
F1 F4

UN: R\$ 10,22 AV: R\$ 306,67 15: R\$ 313,06
30: R\$ 319,32 45: R\$ 325,71 60: R\$ 332,22



FORRO MESA TERMICO 30M 1121 BANANEIRA PI
Código: Fábrica: Unidade:
42498 PERFETTO RL/30
F1 F4

UN: R\$ 10,22 AV: R\$ 306,67 15: R\$ 313,06
30: R\$ 319,32 45: R\$ 325,71 60: R\$ 332,22



FORRO MESA TERMICO 30M 1125 3 ESTACOES
Código: Fábrica: Unidade:
42494 PERFETTO RL/30
F1 F4

UN: R\$ 10,22 AV: R\$ 306,67 15: R\$ 313,06
30: R\$ 319,32 45: R\$ 325,71 60: R\$ 332,22



FORRO MESA TERMICO 30M 1128 LISTR HORTEN
Código: Fábrica: Unidade:
44658 PERFETTO RL/30
F1 F4

UN: R\$ 10,22 AV: R\$ 306,67 15: R\$ 313,06
30: R\$ 319,32 45: R\$ 325,71 60: R\$ 332,22

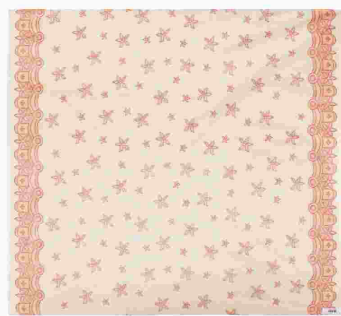

FORRO MESA TERMICO 30M 1133 BARRAD RENDA
Código: Fábrica: Unidade:
47098 PERFETTO RL/30
F1 F4

UN: R\$ 10,22 AV: R\$ 306,67 15: R\$ 313,06
30: R\$ 319,32 45: R\$ 325,71 60: R\$ 332,22



FORRO MESA TERMICO 30M 1137 RENDA AZULEJ
Código: Fábrica: Unidade:
47096 PERFETTO RL/30
F1 F4

UN: R\$ 10,22 AV: R\$ 306,67 15: R\$ 313,06
30: R\$ 319,32 45: R\$ 325,71 60: R\$ 332,22

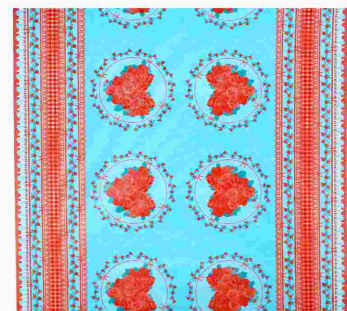

FORRO MESA TERMICO 30M 1172 BUQUE FLORAL
Código: Fábrica: Unidade:
47100 PERFETTO RL/30
F1 F4

UN: R\$ 10,22 AV: R\$ 306,67 15: R\$ 313,06
30: R\$ 319,32 45: R\$ 325,71 60: R\$ 332,22



FORRO MESA TERMICO 30M 1176 JARRO TERRAC
Código: Fábrica: Unidade:
39966 PERFETTO RL/30
F1 F4

UN: R\$ 0,32 AV: R\$ 16,10 15: R\$ 16,43
30: R\$ 16,76 45: R\$ 17,10 60: R\$ 17,44



FORRO PAPEL P/AIR FRYER QUAD 130G 50X1
Código: Fábrica: Unidade:
45908 WINMAX PT/50
F1 F4

UN: R\$ 0,32 AV: R\$ 16,02 15: R\$ 16,36
30: R\$ 16,69 45: R\$ 17,02 60: R\$ 17,36



FORRO PAPEL P/AIR FRYER RED 111G 50X1
Código: Fábrica: Unidade:
45907 WINMAX PT/50
F1 F4

UN: R\$ 1,33 AV: R\$ 1,33 15: R\$ 1,35
30: R\$ 1,38 45: R\$ 1,41 60: R\$ 1,44



FRASCO PLAST 200 ML C/TAMPA (GARRAFA)
Código: Fábrica: Unidade:
51074 DECOPLAST UN/1
F1 F4

UN: R\$ 1,33 AV: R\$ 1,33 15: R\$ 1,35
30: R\$ 1,38 45: R\$ 1,41 60: R\$ 1,44



FRASCO PLAST 300 ML C/TAMPA (GARRAFA)
Código: Fábrica: Unidade:
40505 ARBRA UN/1
F1 F4

UN: R\$ 22,59 AV: R\$ 22,59 15: R\$ 23,06
30: R\$ 23,52 45: R\$ 23,99 60: R\$ 24,47



FRIGIDEIRA ALUM EXTRA FORTE 20 683
Código: Fábrica: Unidade:
8490 MSR UN/1
F1 F4

UN: R\$ 28,75 AV: R\$ 28,75 15: R\$ 29,35
30: R\$ 29,94 45: R\$ 30,54 60: R\$ 31,15



FRIGIDEIRA ALUM EXTRA FORTE 22 684
Código: Fábrica: Unidade:
8241 MSR UN/1
F1 F4

UN: R\$ 31,95 AV: R\$ 31,95 15: R\$ 32,61
30: R\$ 33,26 45: R\$ 33,93 60: R\$ 34,61



FRIGIDEIRA ALUM FRANCESA 18 PRIME 1557
Código: Fábrica: Unidade:
45291 MSR UN/1
F1 F4

UN: R\$ 35,07 AV: R\$ 35,07 15: R\$ 35,80
30: R\$ 36,52 45: R\$ 37,25 60: R\$ 37,99



FRIGIDEIRA ALUM FRANCESA 20 PRIME 1560
Código: Fábrica: Unidade:
45287 MSR UN/1
F1 F4

UN: R\$ 40,05 AV: R\$ 40,05 15: R\$ 40,88
30: R\$ 41,70 45: R\$ 42,54 60: R\$ 43,39



FRIGIDEIRA ALUM FRANCESA 22 ANTI IN 2547
Código: Fábrica: Unidade:
45286 MSR UN/1
F1 F4

UN: R\$ 38,31 AV: R\$ 38,31 15: R\$ 39,11
30: R\$ 39,90 45: R\$ 40,69 60: R\$ 41,51



FRIGIDEIRA ALUM FRANCESA 22 PRIME 1563
Código: Fábrica: Unidade:
45290 MSR UN/1
F1 F4

UN: R\$ 38,52 AV: R\$ 38,52 15: R\$ 39,32
30: R\$ 40,11 45: R\$ 40,91 60: R\$ 41,73



FRIGIDEIRA ALUM FRANCESA 24 ANTI IN 2548
Código: Fábrica: Unidade:
45285 MSR UN/1
F1 F4

UN: R\$ 43,66 AV: R\$ 43,66 15: R\$ 44,57
30: R\$ 45,46 45: R\$ 46,37 60: R\$ 47,29



FRIGIDEIRA ALUM FRANCESA 24 PRIME 1566
Código: Fábrica: Unidade:
45289 MSR UN/1
F1 F4

UN: R\$ 14,35 AV: R\$ 14,35 15: R\$ 14,65
30: R\$ 14,94 45: R\$ 15,24 60: R\$ 15,55



FRIGIDEIRA ALUM LEVE 16 685
Código: Fábrica: Unidade:
35268 MSR UN/1
F1 F4

UN: R\$ 25,67 AV: R\$ 25,67 15: R\$ 26,20
30: R\$ 26,73 45: R\$ 27,26 60: R\$ 27,81



FRIGIDEIRA ALUM LEVE 20 S/TAMPA 1,3LTS
Código: Fábrica: Unidade:
5898 AVELAR UN/1
F1 F4

UN: R\$ 117,51 AV: R\$ 117,51 15: R\$ 119,96
30: R\$ 122,36 45: R\$ 124,81 60: R\$ 127,30



FRIGIDEIRA ALUM 34 TOP QUALI FRANC CINZA
Código: Fábrica: Unidade:
48121 ALEGRETE UN/1
F1 F4

UN: R\$ 24,79 AV: R\$ 24,79 15: R\$ 25,30
30: R\$ 25,81 45: R\$ 26,32 60: R\$ 26,85



FRITURAMA CROM P/FRIGIDEIRA 116
Código: Fábrica: Unidade:
28963 ARAMINAS UN/1
F1 F4

UN: R\$ 35,95 AV: R\$ 35,95 15: R\$ 36,70
30: R\$ 37,44 45: R\$ 38,18 60: R\$ 38,95



FRITURAMA CROM REDONDA 15 42
Código: Fábrica: Unidade:
28970 ARAMINAS UN/1
F1 F4

UN: R\$ 40,06 AV: R\$ 40,06 15: R\$ 40,90
30: R\$ 41,71 45: R\$ 42,55 60: R\$ 43,40



FRITURAMA CROM REDONDA 20 43
Código: Fábrica: Unidade:
28971 ARAMINAS UN/1
F1 F4

UN: R\$ 46,22 AV: R\$ 46,22 15: R\$ 47,19
30: R\$ 48,13 45: R\$ 49,09 60: R\$ 50,08



FRITURAMA CROM REDONDA 25 44
Código: Fábrica: Unidade:
28972 ARAMINAS UN/1
F1 F4

UN: R\$ 50,33 AV: R\$ 50,33 15: R\$ 51,38
30: R\$ 52,41 45: R\$ 53,46 60: R\$ 54,53



FRITURAMA CROM REDONDA 30 45
Código: Fábrica: Unidade:
28973 ARAMINAS UN/1
F1 F4

UN: R\$ 34,91 AV: R\$ 34,91 15: R\$ 35,64
30: R\$ 36,35 45: R\$ 37,08 60: R\$ 37,82



FRUTEIRA CROM DE MESA 367
Código: Fábrica: Unidade:
28956 ARAMINAS UN/1
F1 F4

UN: R\$ 34,10 AV: R\$ 34,10 15: R\$ 34,81
30: R\$ 35,51 45: R\$ 36,22 60: R\$ 36,94

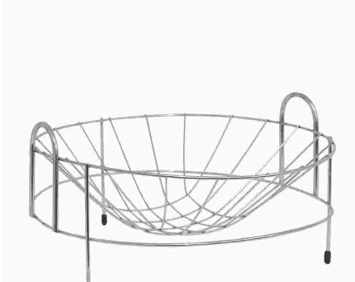

FRUTEIRA CROM RED 1 ANDAR 2378
Código: Fábrica: Unidade:
40250 ARAMIG UN/1
F1 F4

UN: R\$ 45,56 AV: R\$ 45,56 15: R\$ 46,51
30: R\$ 47,44 45: R\$ 48,38 60: R\$ 49,35



FRUTEIRA CROM RED 2 ANDARES 2377
Código: Fábrica: Unidade:
40245 ARAMIG UN/1
F1 F4

UN: R\$ 3,31 AV: R\$ 3,31 15: R\$ 3,38
30: R\$ 3,44 45: R\$ 3,51 60: R\$ 3,58



FRUTEIRA REF 119 32 CM
Código: Fábrica: Unidade:
12128 PARAMOUNT UN/1
F1 F4

UN: R\$ 27,07 AV: R\$ 27,07 15: R\$ 27,63
30: R\$ 28,18 45: R\$ 28,75 60: R\$ 29,32



FUMO P/PLANTA LIQUIDO 500 ML
Código: Fábrica: Unidade:
30300 VITAPLAN UN/1
F1 F4

UN: R\$ 24,58 AV: R\$ 24,58 15: R\$ 25,09
30: R\$ 25,59 45: R\$ 26,11 60: R\$ 26,63



FUMO P/PLANTA PO 400 GRS
Código: Fábrica: Unidade:
30299 VITAPLAN CX/1
F1 F4

UN: R\$ 1,80 AV: R\$ 21,64 15: R\$ 22,09
30: R\$ 22,53 45: R\$ 22,98 60: R\$ 23,44



FUNIL PLAST 10 CM DIAM 5016 12X1
Código: Fábrica: Unidade:
15315 SBRISSA DZ/12
F1 F4

UN: R\$ 6,15 AV: R\$ 6,15 15: R\$ 6,28
30: R\$ 6,41 45: R\$ 6,53 60: R\$ 6,67



FUNIL PLAST 12,5X25CM C/PENEIRA 0621
Código: Fábrica: Unidade:
44505 PLANETA UN/1
F1 F4

UN: R\$ 9,07 AV: R\$ 9,07 15: R\$ 9,26
30: R\$ 9,45 45: R\$ 9,63 60: R\$ 9,83



FUNIL PLAST 15 CM DIAM C/PENEIRA 0622
Código: Fábrica: Unidade:
44504 PLANETA UN/1
F1 F4

UN: R\$ 11,71 AV: R\$ 11,71 15: R\$ 11,95
30: R\$ 12,19 45: R\$ 12,44 60: R\$ 12,69



FUNIL PLAST 4" C/PENEIRA BICO FLEX 1473
Código: Fábrica: Unidade:
51039 BESTFER UN/1
F1 F4

UN: R\$ 4,11 AV: R\$ 4,11 15: R\$ 4,20
30: R\$ 4,28 45: R\$ 4,37 60: R\$ 4,45
10cm



FUNIL PLASTICO 10 CM DIAM 32020
Código: Fábrica: Unidade:
38425 ALMEGA UN/1
F1 F4

UN: R\$ 4,10 AV: R\$ 4,10 15: R\$ 4,18
30: R\$ 4,27 45: R\$ 4,35 60: R\$ 4,44



FUNIL PLASTICO 3PCS 9,5X8X6,5CM 13784
Código: Fábrica: Unidade:
34443 ALIANCA CJ/1
F1 F4

UN: R\$ 4,55 AV: R\$ 54,60 15: R\$ 55,73
30: R\$ 56,85 45: R\$ 57,98 60: R\$ 59,14



FURA COCO INOX 10CM 1009 12X1
Código: Fábrica: Unidade:
33291 JWC DZ/12
F1 F4

UN: R\$ 2,76 AV: R\$ 2,76 15: R\$ 2,82
30: R\$ 2,88 45: R\$ 2,93 60: R\$ 2,99



GANCHEIRA P/VASSOURAS 1521
Código: Fábrica: Unidade:
12908 CONDOR UN/1
F1 F4

UN: R\$ 3,89 AV: R\$ 3,89 15: R\$ 3,97
30: R\$ 4,05 45: R\$ 4,13 60: R\$ 4,22



GANCHO CROM ACOUGUE 01 141
Código: Fábrica: Unidade:
49013 ARAMINAS UN/1
F1 F4

UN: R\$ 4,41 AV: R\$ 4,41 15: R\$ 4,50
30: R\$ 4,59 45: R\$ 4,68 60: R\$ 4,77



GANCHO CROM ACOUGUE 02 140
Código: Fábrica: Unidade:
49014 ARAMINAS UN/1
F1 F4

UN: R\$ 5,13 AV: R\$ 5,13 15: R\$ 5,23
30: R\$ 5,34 45: R\$ 5,44 60: R\$ 5,55



GANCHO CROM ACOUGUE 03 181
Código: Fábrica: Unidade:
49015 ARAMINAS UN/1
F1 F4

UN: R\$ 7,18 AV: R\$ 7,18 15: R\$ 7,33
30: R\$ 7,48 45: R\$ 7,63 60: R\$ 7,78



GANCHO CROM ACOUGUE 04 182
Código: Fábrica: Unidade:
48403 ARAMINAS UN/1
F1 F4

UN: R\$ 11,59 AV: R\$ 11,59 15: R\$ 11,83
30: R\$ 12,06 45: R\$ 12,31 60: R\$ 12,55



GANCHO DECORATIVO MDF 13X9,5CM 804
Código: Fábrica: Unidade:
40906 FUTURO UN/1
F1 F4

UN: R\$ 7,30 AV: R\$ 7,30 15: R\$ 7,46
30: R\$ 7,61 45: R\$ 7,76 60: R\$ 7,91



GANCHO PLAST C/VENTOSA 8 PCS 56045
Código: Fábrica: Unidade:
40809 BLESSED CJ/1
F1 F4

UN: R\$ 13,34 AV: R\$ 13,34 15: R\$ 13,62
30: R\$ 13,89 45: R\$ 14,17 60: R\$ 14,46
30cm



GARFO ALUM BATIDO 30CM 2642
Código: Fábrica: Unidade:
45296 MSR UN/1
F1 F4

UN: R\$ 10,26 AV: R\$ 10,26 15: R\$ 10,48
30: R\$ 10,69 45: R\$ 10,90 60: R\$ 11,12



GARFO ALUM FUNDIDO 30CM
Código: 32525 Fábrica: AVELAR Unidade: UN/1 F1 F4

UN: R\$ 9,24 AV: R\$ 55,47 15: R\$ 56,62
30: R\$ 57,76 45: R\$ 58,91 60: R\$ 60,09



GARFO ALUM INTERICO 28CM 12X1
Código: 41834 Fábrica: COFAX Unidade: PT/6 F1 F4

UN: R\$ 4,98 AV: R\$ 4,98 15: R\$ 5,09
30: R\$ 5,19 45: R\$ 5,29 60: R\$ 5,40



GARFO ALUM 28CM CB MAD 2004 UN
Código: 48074 Fábrica: COFAX Unidade: UN/1 F1 F4

UN: R\$ 11,29 AV: R\$ 11,29 15: R\$ 11,52
30: R\$ 11,75 45: R\$ 11,99 60: R\$ 12,23



GARFO CROM CABO MADEIRA 35 0050
Código: 40256 Fábrica: ARAMINAS Unidade: UN/1 F1 F4

UN: R\$ 19,51 AV: R\$ 19,51 15: R\$ 19,91
30: R\$ 20,31 45: R\$ 20,72 60: R\$ 21,13



GARFO CROM CABO MADEIRA 45 0051
Código: 40257 Fábrica: ARAMINAS Unidade: UN/1 F1 F4

UN: R\$ 23,62 AV: R\$ 23,62 15: R\$ 24,11
30: R\$ 24,59 45: R\$ 25,08 60: R\$ 25,58



GARFO CROM CABO MADEIRA 55 0052
Código: 40258 Fábrica: ARAMINAS Unidade: UN/1 F1 F4

UN: R\$ 2,04 AV: R\$ 24,53 15: R\$ 25,04
30: R\$ 25,54 45: R\$ 26,05 60: R\$ 26,57



GARFO INOX MESA LINHA AMERICA 2221 12X1
Código: 50622 Fábrica: STEEL Unidade: PT/12 F1 F4

UN: R\$ 2,86 AV: R\$ 17,15 15: R\$ 17,51
30: R\$ 17,86 45: R\$ 18,22 60: R\$ 18,58



GARFO INOX MESA UNIVERSO 2047 6X1
Código: 50137 Fábrica: GP6 Unidade: PT/6 F1 F4

UN: R\$ 2,05 AV: R\$ 24,64 15: R\$ 25,16
30: R\$ 25,66 45: R\$ 26,17 60: R\$ 26,70



GARFO INOX MESA 19CM VERS PTO 952 12X1
Código: 50161 Fábrica: PLANETA Unidade: DZ/12 F1 F4

UN: R\$ 0,46 AV: R\$ 5,48 15: R\$ 5,59
30: R\$ 5,70 45: R\$ 5,82 60: R\$ 5,93



GARFO PLASTICO 402 12X1
Código: 10957 Fábrica: ECOPLASTIC Unidade: DZ/12 F1 F4

UN: R\$ 77,03 AV: R\$ 77,03 15: R\$ 78,63
30: R\$ 80,21 45: R\$ 81,81 60: R\$ 83,45



GARRAFA INOX TERM 500ML DIGITAL LED 2117
Código: 41450 Fábrica: EXCALIBUR Unidade: UN/1 F1 F4

UN: R\$ 52,44 AV: R\$ 52,44 15: R\$ 53,53
30: R\$ 54,60 45: R\$ 55,69 60: R\$ 56,81



GARRAFA INOX TERM 650ML 803-16
Código: 40670 Fábrica: CASA ONZE Unidade: UN/1 F1 F4

UN: R\$ 6,67 AV: R\$ 6,67 15: R\$ 6,81
30: R\$ 6,94 45: R\$ 7,08 60: R\$ 7,22



GARRAFA PLAST 1,0 LT COLOR RED 840
Código: 35838 Fábrica: LUMAR Unidade: UN/1 F1 F4

UN: R\$ 6,41 AV: R\$ 6,41 15: R\$ 6,54
30: R\$ 6,67 45: R\$ 6,81 60: R\$ 6,94



GARRAFA PLAST 1,0 LT COLOR RET 841
Código: 35839 Fábrica: LUMAR Unidade: UN/1 F1 F4

UN: R\$ 10,74 AV: R\$ 10,74 15: R\$ 10,97
30: R\$ 11,19 45: R\$ 11,41 60: R\$ 11,64



GARRAFA PLAST 1,1 LTS AGUA 1092
Código: 33025 Fábrica: TRITEC Unidade: UN/1 F1 F4

UN: R\$ 8,75 AV: R\$ 8,75 15: R\$ 8,93
30: R\$ 9,11 45: R\$ 9,30 60: R\$ 9,48



GARRAFA PLAST 1,5 LTS AGUA 1470
Código: 47061 Fábrica: JAGUAR Unidade: UN/1 F1 F4

UN: R\$ 8,21 AV: R\$ 8,21 15: R\$ 8,38
30: R\$ 8,55 45: R\$ 8,72 60: R\$ 8,89



GARRAFA PLAST 1,5 LTS COLOR 812

Código: Fábrika: Unidade:
35833 LUMAR UN/1
F1 F4

UN: R\$ 8,21 AV: R\$ 8,21 15: R\$ 8,38
30: R\$ 8,55 45: R\$ 8,72 60: R\$ 8,89



GARRAFA PLAST 1,5 LTS TRANSP 810

Código: Fábrika: Unidade:
35834 LUMAR UN/1
F1 F4

UN: R\$ 15,77 AV: R\$ 15,77 15: R\$ 16,10
30: R\$ 16,43 45: R\$ 16,75 60: R\$ 17,09

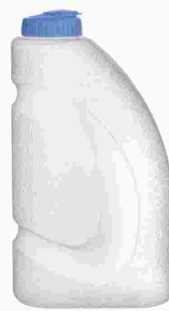

GARRAFA PLAST 2,0 LTS AGUA 697

Código: Fábrika: Unidade:
33030 TRITEC UN/1
F1 F4

UN: R\$ 10,08 AV: R\$ 10,08 15: R\$ 10,29
30: R\$ 10,49 45: R\$ 10,70 60: R\$ 10,92



GARRAFA PLAST 2,0 LTS COLOR 813

Código: Fábrika: Unidade:
35837 LUMAR UN/1
F1 F4

UN: R\$ 9,52 AV: R\$ 9,52 15: R\$ 9,72
30: R\$ 9,91 45: R\$ 10,11 60: R\$ 10,32



GARRAFA PLAST 2,0 LTS TRANSP 809

Código: Fábrika: Unidade:
35836 LUMAR UN/1
F1 F4

UN: R\$ 22,82 AV: R\$ 22,82 15: R\$ 23,30
30: R\$ 23,77 45: R\$ 24,24 60: R\$ 24,73



GARRAFA PLAST 3,2 LTS RET C/TPA 3003

Código: Fábrika: Unidade:
47064 JAGUAR UN/1
F1 F4

UN: R\$ 6,76 AV: R\$ 6,76 15: R\$ 6,90
30: R\$ 7,04 45: R\$ 7,18 60: R\$ 7,32



GARRAFA PLAST 750ML AGUA 1469

Código: Fábrika: Unidade:
47060 JAGUAR UN/1
F1 F4

UN: R\$ 51,35 AV: R\$ 51,35 15: R\$ 52,42
30: R\$ 53,47 45: R\$ 54,54 60: R\$ 55,63



GARRAFA TERM 1LT BCA C/TAMPA COLOR 41458

Código: Fábrika: Unidade:
41458 MABEL UN/1
F1 F4

UN: R\$ 127,36 AV: R\$ 127,36 15: R\$ 130,02
30: R\$ 132,62 45: R\$ 135,27 60: R\$ 137,97



GARRAFA TERM 500ML EMB CRUZEIRO 2913

Código: Fábrika: Unidade:
39043 BRASFOOT UN/1
F1 F4

UN: R\$ 73,28 AV: R\$ 73,28 15: R\$ 74,81
30: R\$ 76,30 45: R\$ 77,83 60: R\$ 79,39



GARRAFA TERMICA 1 LT COLOR C/4 CANECAS

Código: Fábrika: Unidade:
49733 FUTURO CASA UN/1
F1 F4

UN: R\$ 34,82 AV: R\$ 34,82 15: R\$ 35,55
30: R\$ 36,26 45: R\$ 36,98 60: R\$ 37,72



GARRAFA TERMICA 1 LT LOTUS COLOR

Código: Fábrika: Unidade:
44784 SOPRANO UN/1
F1 F4

UN: R\$ 34,45 AV: R\$ 206,67 15: R\$ 210,98
30: R\$ 215,20 45: R\$ 219,50 60: R\$ 223,89



GARRAFA TERMICA 1 LT PRETO 6X1

Código: Fábrika: Unidade:
36732 INVICTA CX/6
F1 F4

UN: R\$ 52,22 AV: R\$ 313,30 15: R\$ 319,82
30: R\$ 326,22 45: R\$ 332,74 60: R\$ 339,40



GARRAFA TERMICA 1 LT SONETO FEN SORT 6X1

Código: Fábrika: Unidade:
45638 SOPRANO CX/6
F1 F4

UN: R\$ 78,06 AV: R\$ 78,06 15: R\$ 79,68
30: R\$ 81,28 45: R\$ 82,90 60: R\$ 84,56



GARRAFA TERMICA 1L INOX 965

Código: Fábrika: Unidade:
50229 FUTURO UN/1
F1 F4

UN: R\$ 65,28 AV: R\$ 65,28 15: R\$ 66,64
30: R\$ 67,97 45: R\$ 69,33 60: R\$ 70,72



GARRAFA TERMICA 1L SAMOA AZUL 9397

Código: Fábrika: Unidade:
51139 GP6 UN/1
F1 F4

UN: R\$ 133,53 AV: R\$ 133,53 15: R\$ 136,31
30: R\$ 139,03 45: R\$ 141,81 60: R\$ 144,65



GARRAFA TERMICA 1,9L ACO 12418

Código: Fábrika: Unidade:
46248 CASITA UN/1
F1 F4

UN: R\$ 129,42 AV: R\$ 129,42 15: R\$ 132,11
30: R\$ 134,76 45: R\$ 137,45 60: R\$ 140,20



GARRAFA TERMICA 1,9L INOX 12482
Código: 47313 Fábrica: CASITA Unidade: UN/1 F1 F4

UN: R\$ 126,86 AV: R\$ 126,86 15: R\$ 129,50
30: R\$ 132,09 45: R\$ 134,73 60: R\$ 137,43



GARRAFA TERMICA 1,9L INOX 14X25CM 12489
Código: 50214 Fábrica: CASITA Unidade: UN/1 F1 F4

UN: R\$ 112,98 AV: R\$ 112,98 15: R\$ 115,34
30: R\$ 117,64 45: R\$ 120,00 60: R\$ 122,40



GARRAFA TERMICA 500ML NEO EMB ATLETICO
Código: 39044 Fábrica: BRASFOOT Unidade: UN/1 F1 F4

UN: R\$ 10,26 AV: R\$ 10,26 15: R\$ 10,48
30: R\$ 10,69 45: R\$ 10,90 60: R\$ 11,12



GARRAFA VIDRO 460ML C/CANUDO PLAST 16015
Código: 47899 Fábrica: CASITA Unidade: UN/1 F1 F4

UN: R\$ 8,23 AV: R\$ 8,23 15: R\$ 8,41
30: R\$ 8,57 45: R\$ 8,75 60: R\$ 8,92



GARRAFA 1L SPORT PLAST COLOR 4101
Código: 42767 Fábrica: DITTOY Unidade: UN/1 F1 F4

UN: R\$ 8,23 AV: R\$ 8,23 15: R\$ 8,41
30: R\$ 8,57 45: R\$ 8,75 60: R\$ 8,92



GARRAFA 500 ML GALAO PLAST COLOR 4014
Código: 42770 Fábrica: DITTOY Unidade: UN/1 F1 F4

UN: R\$ 8,23 AV: R\$ 8,23 15: R\$ 8,41
30: R\$ 8,57 45: R\$ 8,75 60: R\$ 8,92



GARRAFA 500 ML SPORT PLAST COLOR 4103
Código: 42776 Fábrica: DITTOY Unidade: UN/1 F1 F4

UN: R\$ 51,35 AV: R\$ 51,35 15: R\$ 52,42
30: R\$ 53,47 45: R\$ 54,54 60: R\$ 55,63



GARRAFAO TERMICO 3 LTS AZUL
Código: 40035 Fábrica: ANTARES Unidade: UN/1 F1 F4

UN: R\$ 51,35 AV: R\$ 51,35 15: R\$ 52,42
30: R\$ 53,47 45: R\$ 54,54 60: R\$ 55,63



GARRAFAO TERMICO 3 LTS VERMELHO
Código: 49919 Fábrica: ANTARES Unidade: UN/1 F1 F4

UN: R\$ 57,51 AV: R\$ 57,51 15: R\$ 58,71
30: R\$ 59,89 45: R\$ 61,08 60: R\$ 62,30



GARRAFAO TERMICO 5 LTS VERMELHO
Código: 40170 Fábrica: ANTARES Unidade: UN/1 F1 F4

UN: R\$ 38,00 AV: R\$ 38,00 15: R\$ 38,79
30: R\$ 39,56 45: R\$ 40,35 60: R\$ 41,16

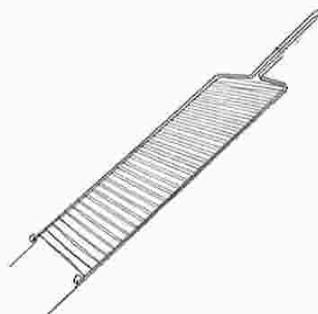

GRELHA DOBRAVEL ABAULADA 01 PQ 58X17CM
Código: 24062 Fábrica: ARAMINAS Unidade: UN/1 F1 F4

UN: R\$ 51,35 AV: R\$ 51,35 15: R\$ 52,42
30: R\$ 53,47 45: R\$ 54,54 60: R\$ 55,63



GRELHA DOBRAVEL ABAULADA 02 MED 65X21CM
Código: 24063 Fábrica: ARAMINAS Unidade: UN/1 F1 F4

UN: R\$ 67,21 AV: R\$ 67,21 15: R\$ 68,61
30: R\$ 69,98 45: R\$ 71,38 60: R\$ 72,81



GRELHA DOBRAVEL ABAULADA 03 GDE 74X26CM
Código: 24064 Fábrica: ARAMINAS Unidade: UN/1 F1 F4

UN: R\$ 40,05 AV: R\$ 40,05 15: R\$ 40,88
30: R\$ 41,70 45: R\$ 42,54 60: R\$ 43,39



GRELHA DOBRAVEL RETA 01 PQ 58X17CM
Código: 24065 Fábrica: ARAMINAS Unidade: UN/1 F1 F4

UN: R\$ 51,35 AV: R\$ 51,35 15: R\$ 52,42
30: R\$ 53,47 45: R\$ 54,54 60: R\$ 55,63



GRELHA DOBRAVEL RETA 02 MED 65X21CM
Código: 24066 Fábrica: ARAMINAS Unidade: UN/1 F1 F4

UN: R\$ 70,87 AV: R\$ 70,87 15: R\$ 72,34
30: R\$ 73,79 45: R\$ 75,27 60: R\$ 76,77



GRELHA DOBRAVEL RETA 03 GDE 74X26CM
Código: 24067 Fábrica: ARAMINAS Unidade: UN/1 F1 F4

UN: R\$ 92,44 AV: R\$ 92,44 15: R\$ 94,36
30: R\$ 96,25 45: R\$ 98,18 60: R\$ 100,14



GUARDA SOL 1,80X2,0 MTS

Código: 32361 Fábrica: ANTARES Unidade: UN/1 F1 F4

UN: R\$ 1,91 AV: R\$ 17,15 15: R\$ 17,51
30: R\$ 17,86 45: R\$ 18,22 60: R\$ 18,58

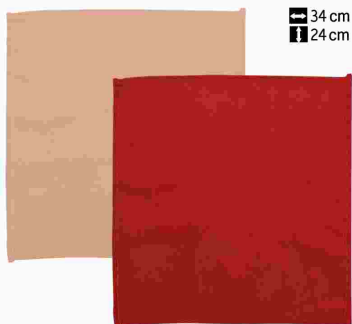

GUARDANAPO PANO LISO 34X24CM 1150 9X1

Código: 40449 Fábrica: SUN WELLS Unidade: PT/9 F1 F4

UN: R\$ 0,01 AV: R\$ 20,53 15: R\$ 20,96
30: R\$ 21,38 45: R\$ 21,81 60: R\$ 22,24



GUARDANAPO PAPEL 14X13CM C/500 4X1

Código: 40581 Fábrica: PANTANAL Unidade: PT/2000 F1 F4

UN: R\$ 0,04 AV: R\$ 1,80 15: R\$ 1,84
30: R\$ 1,87 45: R\$ 1,91 60: R\$ 1,95



GUARDANAPO PAPEL 22,5X20CM 50X1

Código: 47275 Fábrica: DOURADAO Unidade: PT/50 F1 F4

UN: R\$ 0,08 AV: R\$ 3,79 15: R\$ 3,87
30: R\$ 3,95 45: R\$ 4,03 60: R\$ 4,11



GUARDANAPO PAPEL 32,5X30CM 50X1

Código: 47263 Fábrica: DOURADAO Unidade: PT/50 F1 F4

UN: R\$ 10,79 AV: R\$ 10,79 15: R\$ 11,01
30: R\$ 11,23 45: R\$ 11,46 60: R\$ 11,68



GUIA PET 3 MTS 13345

Código: 39245 Fábrica: ALIANCA Unidade: UN/1 F1 F4

UN: R\$ 1,90 AV: R\$ 1,90 15: R\$ 1,94
30: R\$ 1,98 45: R\$ 2,02 60: R\$ 2,06



HASTE PLAST P/VASO 40 CM MARRON

Código: 39215 Fábrica: NUTRIPLAN Unidade: UN/1 F1 F4

UN: R\$ 2,21 AV: R\$ 2,21 15: R\$ 2,25
30: R\$ 2,30 45: R\$ 2,35 60: R\$ 2,39



HASTE PLAST P/VASO 40 CM PRETA

Código: 39214 Fábrica: NUTRIPLAN Unidade: UN/1 F1 F4

UN: R\$ 43,28 AV: R\$ 43,28 15: R\$ 44,18
30: R\$ 45,06 45: R\$ 45,96 60: R\$ 46,88



HUMUS DE MINHOCA 10 KG

Código: 30088 Fábrica: NOVATROPICAL Unidade: PT/1 F1 F4

UN: R\$ 38,00 AV: R\$ 38,00 15: R\$ 38,79
30: R\$ 39,56 45: R\$ 40,35 60: R\$ 41,16

11 cm
34 cm
3,1 Lts



JARDINEIRA ELEGANCE AUTOIR 01 VERDE NEON

Código: 42167 Fábrica: NUTRIPLAN Unidade: UN/1 F1 F4

UN: R\$ 41,08 AV: R\$ 41,08 15: R\$ 41,93
30: R\$ 42,77 45: R\$ 43,63 60: R\$ 44,50

11 cm
33 cm
3,1 Lts



JARDINEIRA ELEGANCE AUTOIRR 01 CAFE IMP

Código: 36202 Fábrica: NUTRIPLAN Unidade: UN/1 F1 F4

UN: R\$ 35,94 AV: R\$ 35,94 15: R\$ 36,69
30: R\$ 37,42 45: R\$ 38,17 60: R\$ 38,94

11 cm
34 cm
3,1 Lts

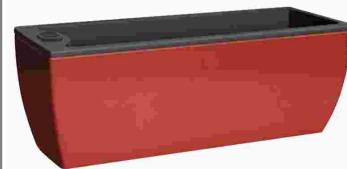

JARDINEIRA ELEGANCE AUTOIRR 01 VINHO IMP

Código: 42166 Fábrica: NUTRIPLAN Unidade: UN/1 F1 F4

UN: R\$ 5,13 AV: R\$ 5,13 15: R\$ 5,23
30: R\$ 5,34 45: R\$ 5,44 60: R\$ 5,55



JARRA PLAST 1,0 LT C/ ESPREM COLOR 4032

Código: 17401 Fábrica: SBRISSA Unidade: UN/1 F1 F4

UN: R\$ 7,06 AV: R\$ 7,06 15: R\$ 7,20
30: R\$ 7,35 45: R\$ 7,49 60: R\$ 7,64



JARRA PLAST 1,0 LT GRAD C/ESP TRANSP4031

Código: 44234 Fábrica: SBRISSA Unidade: UN/1 F1 F4

UN: R\$ 2,53 AV: R\$ 2,53 15: R\$ 2,59
30: R\$ 2,64 45: R\$ 2,69 60: R\$ 2,74



JARRA PLAST 1,0 LT GRADUADA CORES 4010

Código: 17980 Fábrica: SBRISSA Unidade: UN/1 F1 F4

UN: R\$ 4,95 AV: R\$ 4,95 15: R\$ 5,05
30: R\$ 5,15 45: R\$ 5,25 60: R\$ 5,36



JARRA PLAST 1,0 LT GRADUADA TRANSP 4004

Código: 18714 Fábrica: SBRISSA Unidade: UN/1 F1 F4

UN: R\$ 4,21 AV: R\$ 4,21 15: R\$ 4,30
30: R\$ 4,39 45: R\$ 4,47 60: R\$ 4,56



JARRA PLAST 1,0 LT GRADUADA 866 UN
Código: Fábrica: Unidade:
49483 TRITEC UN/1
F1 F4

UN: R\$ 9,65 AV: R\$ 9,65 15: R\$ 9,85
30: R\$ 10,04 45: R\$ 10,24 60: R\$ 10,45



JARRA PLAST 1,5 LT RED C/TPA 6606
Código: Fábrica: Unidade:
11211 INPLAST UN/1
F1 F4

UN: R\$ 11,48 AV: R\$ 11,48 15: R\$ 11,72
30: R\$ 11,96 45: R\$ 12,20 60: R\$ 12,44



JARRA PLAST 1,5 LTS TRANSP 814
Código: Fábrica: Unidade:
35841 LUMAR UN/1
F1 F4

UN: R\$ 8,99 AV: R\$ 8,99 15: R\$ 8,99
30: R\$ 8,99 45: R\$ 8,99 60: R\$ 8,99



JARRA PLAST 2,1 LT QUAD C/TPA 6652
Código: Fábrica: Unidade:
20146 INPLAST UN/1
F1 F4

UN: R\$ 11,87 AV: R\$ 11,87 15: R\$ 12,12
30: R\$ 12,36 45: R\$ 12,61 60: R\$ 12,86

2lts



JARRA PLAST 2,0 LT QD C/TPA 0078
Código: Fábrica: Unidade:
4462 JAGUAR UN/1
F1 F4

UN: R\$ 17,45 AV: R\$ 17,45 15: R\$ 17,82
30: R\$ 18,17 45: R\$ 18,54 60: R\$ 18,91

23cm
2,5lts



JARRA PLAST 2,5 LTS TRANSP TPA COLOR 863
Código: Fábrica: Unidade:
46674 LUMAR UN/1
F1 F4

UN: R\$ 17,45 AV: R\$ 17,45 15: R\$ 17,82
30: R\$ 18,17 45: R\$ 18,54 60: R\$ 18,91



JARRA PLAST 2,5LTS RED NOVELLE 6071
Código: Fábrica: Unidade:
46798 RISCHIOTO UN/1
F1 F4

UN: R\$ 20,34 AV: R\$ 20,34 15: R\$ 20,76
30: R\$ 21,18 45: R\$ 21,60 60: R\$ 22,03

3,3lts

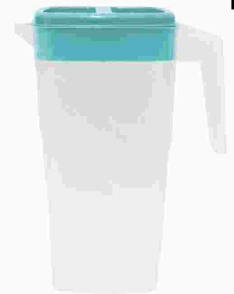

JARRA PLAST 3,3 LTS QUAD C/TPA 0002
Código: Fábrica: Unidade:
18920 JAGUAR UN/1
F1 F4

UN: R\$ 22,00 AV: R\$ 22,00 15: R\$ 22,46
30: R\$ 22,91 45: R\$ 23,37 60: R\$ 23,84

3,7lts



JARRA PLAST 3,7 LTS RED C/TPA 1565
Código: Fábrica: Unidade:
4723 JAGUAR UN/1
F1 F4

UN: R\$ 18,88 AV: R\$ 18,88 15: R\$ 19,27
30: R\$ 19,66 45: R\$ 20,05 60: R\$ 20,45



JARRA PLAST 3,8 LTS AQUARELA C/TPA 6814
Código: Fábrica: Unidade:
41670 INPLAST UN/1
F1 F4

UN: R\$ 18,88 AV: R\$ 18,88 15: R\$ 19,27
30: R\$ 19,66 45: R\$ 20,05 60: R\$ 20,45



JARRA PLAST 3,8 LTS TRANSP C/TPA 6813
Código: Fábrica: Unidade:
41666 INPLAST UN/1
F1 F4

UN: R\$ 26,55 AV: R\$ 26,55 15: R\$ 27,11
30: R\$ 27,65 45: R\$ 28,20 60: R\$ 28,77



JARRA PLAST 4,0 LT TRANSP C/TAMPA 398
Código: Fábrica: Unidade:
33026 TRITEC UN/1
F1 F4

UN: R\$ 15,94 AV: R\$ 15,94 15: R\$ 16,27
30: R\$ 16,60 45: R\$ 16,93 60: R\$ 17,27



JARRA VIDRO 1L P/CANTO GELADEIRA 234
Código: Fábrica: Unidade:
47325 NIX UN/1
F1 F4

UN: R\$ 23,11 AV: R\$ 23,11 15: R\$ 23,59
30: R\$ 24,07 45: R\$ 24,55 60: R\$ 25,04



JARRA VIDRO 1,1 LTS TPA PLAST C/CX 7694
Código: Fábrica: Unidade:
47354 ALTIHOME UN/1
F1 F4

UN: R\$ 23,11 AV: R\$ 23,11 15: R\$ 23,59
30: R\$ 24,07 45: R\$ 24,55 60: R\$ 25,04



JARRA VIDRO 1,1 LTS TPA PLAST C/CX 7695
Código: Fábrica: Unidade:
47356 ALTIHOME UN/1
F1 F4

UN: R\$ 19,99 AV: R\$ 19,99 15: R\$ 19,99
30: R\$ 19,99 45: R\$ 19,99 60: R\$ 19,99



JARRA VIDRO 1,1 LTS TPA PLAST FC019
Código: Fábrica: Unidade:
49439 SATYAM UN/1
F1 F4

UN: R\$ 23,11 AV: R\$ 23,11 15: R\$ 23,59
30: R\$ 24,07 45: R\$ 24,55 60: R\$ 25,04



JARRA VIDRO 1,1 LTS TPA PLAST FC020
Código: Fábriça: Unidade:
49440 SATYAM UN/1
F1 F4

UN: R\$ 23,62 AV: R\$ 23,62 15: R\$ 24,11
30: R\$ 24,59 45: R\$ 25,08 60: R\$ 25,58



JARRA VIDRO 1,1 LTS TRANSP TPA PLAST 016
Código: Fábriça: Unidade:
50805 SATYAM UN/1
F1 F4

UN: R\$ 23,62 AV: R\$ 23,62 15: R\$ 24,11
30: R\$ 24,59 45: R\$ 25,08 60: R\$ 25,58



JARRA VIDRO 1,1 LTS TRANSP TPA PLAST 017
Código: Fábriça: Unidade:
50804 SATYAM UN/1
F1 F4

UN: R\$ 39,02 AV: R\$ 39,02 15: R\$ 39,84
30: R\$ 40,63 45: R\$ 41,45 60: R\$ 42,27



JARRA VIDRO 1,6 LTS C/TPA PLAST 1090
Código: Fábriça: Unidade:
49481 LEHAVI UN/1
F1 F4

UN: R\$ 41,08 AV: R\$ 41,08 15: R\$ 41,93
30: R\$ 42,77 45: R\$ 43,63 60: R\$ 44,50



JARRA VIDRO 1,8 LTS C/TPA PLAST 1091
Código: Fábriça: Unidade:
49482 LEHAVI UN/1
F1 F4

UN: R\$ 29,78 AV: R\$ 29,78 15: R\$ 30,40
30: R\$ 31,01 45: R\$ 31,63 60: R\$ 32,26



JARRA VIDRO 1,8 LTS TRANSP C/TPA ACR 026
Código: Fábriça: Unidade:
50803 PRATIBELLA UN/1
F1 F4

UN: R\$ 48,96 AV: R\$ 48,96 15: R\$ 49,98
30: R\$ 50,98 45: R\$ 52,00 60: R\$ 53,04



JARRA VIDRO 1,8 LTS TRANSP C/TPA ACR 156
Código: Fábriça: Unidade:
49801 FUTURO UN/1
F1 F4

UN: R\$ 48,96 AV: R\$ 48,96 15: R\$ 49,98
30: R\$ 50,98 45: R\$ 52,00 60: R\$ 53,04



JARRA VIDRO 1,8 LTS TRANSP C/TPA ACR 157
Código: Fábriça: Unidade:
49799 FUTURO UN/1
F1 F4

UN: R\$ 7,99 AV: R\$ 7,99 15: R\$ 7,99
30: R\$ 7,99 45: R\$ 7,99 60: R\$ 7,99



JARRA 1,8 LT TRANSP C/TPA 4000
Código: Fábriça: Unidade:
17979 SBRISSA UN/1
F1 F4

UN: R\$ 13,12 AV: R\$ 13,12 15: R\$ 13,40
30: R\$ 13,67 45: R\$ 13,94 60: R\$ 14,22



JARRA 1,8 LT TRANSP DEC C/TPA 8013
Código: Fábriça: Unidade:
35219 SBRISSA UN/1
F1 F4

UN: R\$ 16,76 AV: R\$ 16,76 15: R\$ 17,11
30: R\$ 17,46 45: R\$ 17,80 60: R\$ 18,16



JARRA 1,8 LT TRANSP KIT C/4 COPOS 4041
Código: Fábriça: Unidade:
31277 SBRISSA UN/1
F1 F4

UN: R\$ 1,40 AV: R\$ 69,84 15: R\$ 71,29
30: R\$ 72,72 45: R\$ 74,17 60: R\$ 75,66



JOELHO 1/2 PRETO JO51N 50X1
Código: Fábriça: Unidade:
40153 REBOUCAS PT/50
F1 F4

UN: R\$ 1,41 AV: R\$ 70,47 15: R\$ 71,93
30: R\$ 73,37 45: R\$ 74,84 60: R\$ 76,34



JOELHO 3/4 PRETO JO52N 50X1
Código: Fábriça: Unidade:
40154 REBOUCAS PT/50
F1 F4

UN: R\$ 16,42 AV: R\$ 16,42 15: R\$ 16,77
30: R\$ 17,10 45: R\$ 17,44 60: R\$ 17,79



JOGO CHURRASCO FACA GARFO CB MAD 0091
Código: Fábriça: Unidade:
41748 Q.P.BEST FER CJ/1
F1 F4

UN: R\$ 33,89 AV: R\$ 33,89 15: R\$ 34,59
30: R\$ 35,29 45: R\$ 35,99 60: R\$ 36,71



JOGO CHURRASCO FACA GARFO CB MAD 204
Código: Fábriça: Unidade:
41346 HAUSKRAFT CJ/1
F1 F4

UN: R\$ 20,53 AV: R\$ 20,53 15: R\$ 20,96
30: R\$ 21,38 45: R\$ 21,81 60: R\$ 22,24



JOGO CHURRASCO FACA/CHAIRA CB MAD 0071
Código: Fábriça: Unidade:
41221 TALBERG CJ/1
F1 F4

UN: R\$ 91,42 AV: R\$ 91,42 15: R\$ 93,33
30: R\$ 95,19 45: R\$ 97,10 60: R\$ 99,04



JOGO CHURRASCO FACA/GARF/PEGAD CB MAD 75

Código: Fábrika: Unidade:
40458 TRAMONTINA CJ/1
F1 F4

UN: R\$ 40,57 AV: R\$ 40,57 15: R\$ 41,42
30: R\$ 42,25 45: R\$ 43,09 60: R\$ 43,95



KIT CAIPIRINHA 3CS(COPO/TABUA/AMASSA 681

Código: Fábrika: Unidade:
40392 TRAMONTINA CJ/1
F1 F4

UN: R\$ 18,82 AV: R\$ 18,82 15: R\$ 19,21
30: R\$ 19,59 45: R\$ 19,99 60: R\$ 20,39



KIT COZINHA 3PCS(CAP BOT/CAP LIQ/FOR FOG

Código: Fábrika: Unidade:
38506 FERREIRA UN/1
F1 F4

UN: R\$ 18,80 AV: R\$ 18,80 15: R\$ 19,19
30: R\$ 19,57 45: R\$ 19,96 60: R\$ 20,36



KIT COZINHA 3PCS(CAP BOT/FOGAO/PUX SACO)

Código: Fábrika: Unidade:
11332 FERREIRA UN/1
F1 F4

UN: R\$ 123,25 AV: R\$ 123,25 15: R\$ 125,82
30: R\$ 128,34 45: R\$ 130,90 60: R\$ 133,52



KIT CUIA GDE NUTRICOCO (CORRENT/SUPORTE)

Código: Fábrika: Unidade:
31903 NUTRIPLAN UN/1
F1 F4

UN: R\$ 162,29 AV: R\$ 162,29 15: R\$ 165,67
30: R\$ 168,98 45: R\$ 172,36 60: R\$ 175,81



KIT CUIA GIG NUTRICOCO (CORRENT/SUPORTE)

Código: Fábrika: Unidade:
31904 NUTRIPLAN UN/1
F1 F4

UN: R\$ 19,51 AV: R\$ 19,51 15: R\$ 19,91
30: R\$ 20,31 45: R\$ 20,72 60: R\$ 21,13



KIT CUIA 1 MARROM (PRATO/CORREN/VASO)

Código: Fábrika: Unidade:
18496 NUTRIPLAN UN/1
F1 F4

UN: R\$ 18,48 AV: R\$ 18,48 15: R\$ 18,86
30: R\$ 19,24 45: R\$ 19,63 60: R\$ 20,02



KIT CUIA 1 PRETO (PRATO /CORREN/VASO)

Código: Fábrika: Unidade:
18494 NUTRIPLAN UN/1
F1 F4

UN: R\$ 19,52 AV: R\$ 19,52 15: R\$ 19,92
30: R\$ 20,32 45: R\$ 20,73 60: R\$ 21,14



KIT CUIA 1,5 MARROM (PRATO/CORREN/VASO)

Código: Fábrika: Unidade:
27334 NUTRIPLAN UN/1
F1 F4

UN: R\$ 30,51 AV: R\$ 30,51 15: R\$ 31,14
30: R\$ 31,77 45: R\$ 32,40 60: R\$ 33,05



KIT CUIA 2 MARROM (PRATO/CORREN/VASO)

Código: Fábrika: Unidade:
22283 NUTRIPLAN UN/1
F1 F4

UN: R\$ 26,88 AV: R\$ 26,88 15: R\$ 27,44
30: R\$ 27,99 45: R\$ 28,55 60: R\$ 29,12



KIT CUIA 2 PRETO (PRATO /CORREN/VASO)

Código: Fábrika: Unidade:
22285 NUTRIPLAN UN/1
F1 F4

UN: R\$ 29,28 AV: R\$ 29,28 15: R\$ 29,89
30: R\$ 30,48 45: R\$ 31,09 60: R\$ 31,71



KIT CUIA 3 MARROM (PRATO/CORREN/VASO)

Código: Fábrika: Unidade:
31390 NUTRIPLAN UN/1
F1 F4

UN: R\$ 32,55 AV: R\$ 32,55 15: R\$ 33,23
30: R\$ 33,89 45: R\$ 34,57 60: R\$ 35,26



KIT CUIA 3 PRETO (PRATO/CORREN/VASO)

Código: Fábrika: Unidade:
30307 NUTRIPLAN UN/1
F1 F4

UN: R\$ 8,12 AV: R\$ 8,12 15: R\$ 8,29
30: R\$ 8,45 45: R\$ 8,62 60: R\$ 8,79



KIT INF ESCOLAR PRATO+COLHER+CANECA 5013

Código: Fábrika: Unidade:
41896 SBRISSA CJ/1
F1 F4

UN: R\$ 2,05 AV: R\$ 6,15 15: R\$ 6,28
30: R\$ 6,41 45: R\$ 6,53 60: R\$ 6,67



KIT INOX 3 FACAS HERCULES MUNDIAL

Código: Fábrika: Unidade:
41170 HERCULES CJ/3
F1 F4

UN: R\$ 9,41 AV: R\$ 9,41 15: R\$ 9,61
30: R\$ 9,80 45: R\$ 10,00 60: R\$ 10,20



KIT MERENDA PLAST(PRATO/CUMB/CANECA/COLH

Código: Fábrika: Unidade:
44235 SBRISSA CJ/1
F1 F4

UN: R\$ 10,91 AV: R\$ 10,91 15: R\$ 11,14
30: R\$ 11,36 45: R\$ 11,59 60: R\$ 11,82



KIT MERENDA PLAST(PRATO/CUMB/CANECA/COLH
Código: Fábrika: Unidade:
44236 SBRISSA CJ/1
F1 F4

UN: R\$ 49,82 AV: R\$ 49,82 15: R\$ 50,86
30: R\$ 51,87 45: R\$ 52,91 60: R\$ 53,97



KIT P/BANHEIRO 4 PCS PLAST CORUJA 4054
Código: Fábrika: Unidade:
47314 CASITA CJ/1
F1 F4

UN: R\$ 25,27 AV: R\$ 25,27 15: R\$ 25,80
30: R\$ 26,31 45: R\$ 26,84 60: R\$ 27,37



KIT PIA (LIXEIRA/PA/PORTA DETE) DEC 8020
Código: Fábrika: Unidade:
35224 SBRISSA UN/1
F1 F4

UN: R\$ 21,62 AV: R\$ 21,62 15: R\$ 22,07
30: R\$ 22,51 45: R\$ 22,96 60: R\$ 23,42



KIT PIA (LIXEIRA/PA/PORTA DETE) 8002
Código: Fábrika: Unidade:
34563 SBRISSA UN/1
F1 F4

UN: R\$ 31,83 AV: R\$ 31,83 15: R\$ 32,50
30: R\$ 33,15 45: R\$ 33,81 60: R\$ 34,49



KIT STANDART/TABU MAD C/GARF 20X33CM 57H
Código: Fábrika: Unidade:
41739 DEBIASI UN/1
F1 F4

UN: R\$ 13,30 AV: R\$ 13,30 15: R\$ 13,58
30: R\$ 13,85 45: R\$ 14,13 60: R\$ 14,41



KIT 10 POTES RET 3500/1500/750/350/200ML
Código: Fábrika: Unidade:
34573 PLASTBON CJ/1
F1 F4

UN: R\$ 18,56 AV: R\$ 18,56 15: R\$ 18,95
30: R\$ 19,33 45: R\$ 19,71 60: R\$ 20,11



KIT 2 POTES ORGANIZA QUAD 3L 6332
Código: Fábrika: Unidade:
47050 JAGUAR CJ/1
F1 F4

UN: R\$ 18,34 AV: R\$ 18,34 15: R\$ 18,72
30: R\$ 19,09 45: R\$ 19,47 60: R\$ 19,86



KIT 2 POTES ORGANIZA RED 3L 6331
Código: Fábrika: Unidade:
47049 JAGUAR CJ/1
F1 F4

UN: R\$ 21,21 AV: R\$ 21,21 15: R\$ 21,65
30: R\$ 22,09 45: R\$ 22,53 60: R\$ 22,98



KIT 2 POTES ORGANIZA RET 3,6L 6333
Código: Fábrika: Unidade:
47051 JAGUAR CJ/1
F1 F4

UN: R\$ 15,07 AV: R\$ 15,07 15: R\$ 15,38
30: R\$ 15,69 45: R\$ 16,00 60: R\$ 16,32



KIT 2 POTES RED 4003/02
Código: Fábrika: Unidade:
22916 SBRISSA CJ/1
F1 F4

UN: R\$ 17,93 AV: R\$ 17,93 15: R\$ 18,31
30: R\$ 18,67 45: R\$ 19,05 60: R\$ 19,43



KIT 3 POTES ORGANIZA QUAD 1,2L 6328
Código: Fábrika: Unidade:
47046 JAGUAR CJ/1
F1 F4

UN: R\$ 16,47 AV: R\$ 16,47 15: R\$ 16,81
30: R\$ 17,15 45: R\$ 17,49 60: R\$ 17,84



KIT 3 POTES ORGANIZA RED 1,22L 6330
Código: Fábrika: Unidade:
47048 JAGUAR CJ/1
F1 F4

UN: R\$ 17,92 AV: R\$ 17,92 15: R\$ 18,30
30: R\$ 18,66 45: R\$ 19,04 60: R\$ 19,42



KIT 3 POTES ORGANIZA RET 1,270ML 6329
Código: Fábrika: Unidade:
47047 JAGUAR CJ/1
F1 F4

UN: R\$ 14,49 AV: R\$ 14,49 15: R\$ 14,79
30: R\$ 15,09 45: R\$ 15,39 60: R\$ 15,70



KIT 3 POTES QUAD MED 1200ML 5513
Código: Fábrika: Unidade:
41478 KOZI PLAST UN/1
F1 F4

UN: R\$ 20,53 AV: R\$ 20,53 15: R\$ 20,96
30: R\$ 21,38 45: R\$ 21,81 60: R\$ 22,24



KIT 3 POTES QUAD PMG 380/770/1400ML 7415
Código: Fábrika: Unidade:
22917 RISCHIOTO CJ/1
F1 F4

UN: R\$ 11,85 AV: R\$ 11,85 15: R\$ 12,10
30: R\$ 12,34 45: R\$ 12,59 60: R\$ 12,84



KIT 3 POTES QUAD 230/390/390ML 4128
Código: Fábrika: Unidade:
8270 JAGUAR CJ/1
F1 F4

UN: R\$ 11,85 AV: R\$ 11,85 15: R\$ 12,10
30: R\$ 12,34 45: R\$ 12,59 60: R\$ 12,84



KIT 3 POTES QUAD 230/390/690ML 4129
Código: 9836 Fábrica: JAGUAR Unidade: CJ/1 F1 F4

UN: R\$ 11,85 AV: R\$ 11,85 15: R\$ 12,10
30: R\$ 12,34 45: R\$ 12,59 60: R\$ 12,84



KIT 3 POTES RED 210/370/740ML 4054
Código: 8267 Fábrica: JAGUAR Unidade: CJ/1 F1 F4

UN: R\$ 21,19 AV: R\$ 21,19 15: R\$ 21,63
30: R\$ 22,07 45: R\$ 22,51 60: R\$ 22,96



KIT 3 POTES RED 4003
Código: 30698 Fábrica: SBRISSA Unidade: CJ/1 F1 F4

UN: R\$ 20,44 AV: R\$ 20,44 15: R\$ 20,87
30: R\$ 21,28 45: R\$ 21,71 60: R\$ 22,14



KIT 3 POTES RET PMG 380/740/1200ML 215
Código: 22918 Fábrica: RISCHIOTO Unidade: CJ/1 F1 F4

UN: R\$ 11,30 AV: R\$ 11,30 15: R\$ 11,53
30: R\$ 11,77 45: R\$ 12,00 60: R\$ 12,24



KIT 3 POTES RET 220/420/750ML 4021
Código: 9838 Fábrica: JAGUAR Unidade: CJ/1 F1 F4

UN: R\$ 19,87 AV: R\$ 19,87 15: R\$ 20,28
30: R\$ 20,69 45: R\$ 21,10 60: R\$ 21,52



KIT 4 POTES QUAD 230/390/690/1200ML 4126
Código: 9076 Fábrica: JAGUAR Unidade: CJ/1 F1 F4

UN: R\$ 19,87 AV: R\$ 19,87 15: R\$ 20,28
30: R\$ 20,69 45: R\$ 21,10 60: R\$ 21,52



KIT 4 POTES QUAD 230/390/690/1200ML 4127
Código: 9077 Fábrica: JAGUAR Unidade: CJ/1 F1 F4

UN: R\$ 18,39 AV: R\$ 18,39 15: R\$ 18,77
30: R\$ 19,15 45: R\$ 19,53 60: R\$ 19,92



KIT 4 POTES RED 210/370/740/1220ML 4063
Código: 9835 Fábrica: JAGUAR Unidade: CJ/1 F1 F4

UN: R\$ 18,39 AV: R\$ 18,39 15: R\$ 18,77
30: R\$ 19,15 45: R\$ 19,53 60: R\$ 19,92



KIT 4 POTES RED 210/370/740/1220ML 4064
Código: 9078 Fábrica: JAGUAR Unidade: CJ/1 F1 F4

UN: R\$ 8,91 AV: R\$ 8,91 15: R\$ 9,09
30: R\$ 9,27 45: R\$ 9,46 60: R\$ 9,65

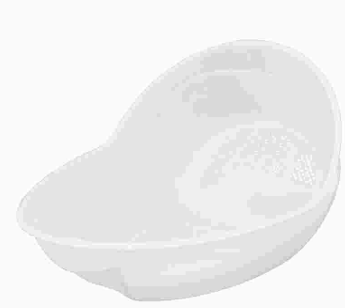

LAVA ARROZ PLAST 0795
Código: 47059 Fábrica: JAGUAR Unidade: UN/1 F1 F4

UN: R\$ 5,01 AV: R\$ 5,01 15: R\$ 5,11
30: R\$ 5,21 45: R\$ 5,32 60: R\$ 5,42



LAVA ARROZ PLAST 5015
Código: 14573 Fábrica: SBRISSA Unidade: UN/1 F1 F4

UN: R\$ 7,36 AV: R\$ 7,36 15: R\$ 7,52
30: R\$ 7,67 45: R\$ 7,82 60: R\$ 7,98



LAVA TUDO PLAST COLOR 5027
Código: 30262 Fábrica: SBRISSA Unidade: UN/1 F1 F4

UN: R\$ 5,13 AV: R\$ 5,13 15: R\$ 5,23
30: R\$ 5,34 45: R\$ 5,44 60: R\$ 5,55



LAVA TUDO PLAST COLOR 674
Código: 18306 Fábrica: ECOPLASTIC Unidade: UN/1 F1 F4

UN: R\$ 30,81 AV: R\$ 30,81 15: R\$ 31,45
30: R\$ 32,08 45: R\$ 32,72 60: R\$ 33,37



LEITEIRA ALUM EXTRA 14 C/TAMPA 1,7LTS
Código: 40290 Fábrica: AVELAR Unidade: UN/1 F1 F4

UN: R\$ 13,92 AV: R\$ 13,92 15: R\$ 14,21
30: R\$ 14,49 45: R\$ 14,78 60: R\$ 15,08



LICOREIRA VIDRO 250ML 19,3CM 22169
Código: 36770 Fábrica: MABEL Unidade: CX/1 F1 F4

UN: R\$ 4,61 AV: R\$ 4,61 15: R\$ 4,71
30: R\$ 4,80 45: R\$ 4,90 60: R\$ 5,00



LIMPA ALUMINIO DULAR 500 ML
Código: 48941 Fábrica: DULAR Unidade: UN/1 F1 F4

UN: R\$ 23,42 AV: R\$ 23,42 15: R\$ 23,91
30: R\$ 24,39 45: R\$ 24,87 60: R\$ 25,37



LIMPA TETO NYLON UN

Código: Fábrica: Unidade:
50868 HALLEY UN/1
F1 F4

UN: R\$ 102,67 AV: R\$ 102,67 15: R\$ 104,81
30: R\$ 106,90 45: R\$ 109,04 60: R\$ 111,22



LIMPADOR MULT 500ML 8X3 AZULIM

Código: Fábrica: Unidade:
48834 AZULIM PT/1
F1 F4

UN: R\$ 88,33 AV: R\$ 88,33 15: R\$ 90,17
30: R\$ 91,97 45: R\$ 93,81 60: R\$ 95,69



LIMPADOR MULTIUSO 5 LTS CONCENTRADO OX2

Código: Fábrica: Unidade:
49516 UP PRO PT/1
F1 F4

UN: R\$ 34,99 AV: R\$ 34,99 15: R\$ 34,99
30: R\$ 34,99 45: R\$ 34,99 60: R\$ 34,99



LIXEIRA C/ PEDAL 15 L ECO 3065

Código: Fábrica: Unidade:
19089 JAGUAR UN/1
F1 F4

1 37cm
2 28cm
3 15Lts

UN: R\$ 66,95 AV: R\$ 66,95 15: R\$ 68,34
30: R\$ 69,71 45: R\$ 71,11 60: R\$ 72,53



LIXEIRA CANELADA N 60 56 LTS FECH C/TPA

Código: Fábrica: Unidade:
18340 ANTARES UN/1
F1 F4

UN: R\$ 106,01 AV: R\$ 106,01 15: R\$ 108,22
30: R\$ 110,39 45: R\$ 112,60 60: R\$ 114,85



LIXEIRA CANELADA N100 86 LTS FECH C/TP

Código: Fábrica: Unidade:
22734 ANTARES UN/1
F1 F4

UN: R\$ 203,18 AV: R\$ 203,18 15: R\$ 207,41
30: R\$ 211,56 45: R\$ 215,79 60: R\$ 220,11



LIXEIRA INOX C/PEDAL 20 LTS 7022

Código: Fábrica: Unidade:
47312 CASITA UN/1
F1 F4

1 43cm

UN: R\$ 151,15 AV: R\$ 151,15 15: R\$ 154,30
30: R\$ 157,39 45: R\$ 160,54 60: R\$ 163,75



LIXEIRA INOX 12 LTS 99-004

Código: Fábrica: Unidade:
46893 SATYAM UN/1
F1 F4

1 39cm
2 12Lts

UN: R\$ 4,71 AV: R\$ 4,71 15: R\$ 4,81
30: R\$ 4,91 45: R\$ 5,00 60: R\$ 5,10



LIXEIRA PLAST BASC 3 LTS 938

Código: Fábrica: Unidade:
34576 PLASTBON UN/1
F1 F4

UN: R\$ 24,64 AV: R\$ 24,64 15: R\$ 25,16
30: R\$ 25,66 45: R\$ 26,17 60: R\$ 26,70



LIXEIRA PLAST BASC 3LTS DEC BIRDS 1741

Código: Fábrica: Unidade:
37315 MONTE LIBANO UN/1
F1 F4

UN: R\$ 20,53 AV: R\$ 20,53 15: R\$ 20,96
30: R\$ 21,38 45: R\$ 21,81 60: R\$ 22,24



LIXEIRA PLAST BASC 3LTS DEC BLACK B 1743

Código: Fábrica: Unidade:
37317 MONTE LIBANO UN/1
F1 F4

UN: R\$ 24,64 AV: R\$ 24,64 15: R\$ 25,16
30: R\$ 25,66 45: R\$ 26,17 60: R\$ 26,70



LIXEIRA PLAST BASC 3LTS DEC FENDI 1742

Código: Fábrica: Unidade:
37316 MONTE LIBANO UN/1
F1 F4

UN: R\$ 15,30 AV: R\$ 15,30 15: R\$ 15,62
30: R\$ 15,93 45: R\$ 16,25 60: R\$ 16,58



LIXEIRA PLAST BASC 4,8 LTS PRETA

Código: Fábrica: Unidade:
45447 PLASMARC UN/1
F1 F4

UN: R\$ 16,94 AV: R\$ 16,94 15: R\$ 17,29
30: R\$ 17,64 45: R\$ 17,99 60: R\$ 18,35



LIXEIRA PLAST BASC 6,2 LTS 6672

Código: Fábrica: Unidade:
26199 INPLAST UN/1
F1 F4

UN: R\$ 22,08 AV: R\$ 22,08 15: R\$ 22,54
30: R\$ 23,00 45: R\$ 23,46 60: R\$ 23,92



LIXEIRA PLAST BASC 7,5 LTS ECO 3065

Código: Fábrica: Unidade:
3077 JAGUAR UN/1
F1 F4

1 40cm
2 7,5Lts

UN: R\$ 34,16 AV: R\$ 34,16 15: R\$ 34,88
30: R\$ 35,57 45: R\$ 36,29 60: R\$ 37,01



LIXEIRA PLAST C/ PEDAL 12 LTS PRETA

Código: Fábrica: Unidade:
34092 SHANGRILA UN/1
F1 F4

1 33cm
2 29cm
3 12Lts

UN: R\$ 45,66 AV: R\$ 45,66 15: R\$ 46,61
30: R\$ 47,54 45: R\$ 48,49 60: R\$ 49,46

1 42cm
2 32cm
3 20lts



LIXEIRA PLAST C/ PEDAL 20 LTS ECO 3073

Código: Fábrica: Unidade:
49170 JAGUAR UN/1
F1 F4

UN: R\$ 89,36 AV: R\$ 89,36 15: R\$ 91,22
30: R\$ 93,04 45: R\$ 94,90 60: R\$ 96,80

1 53cm
2 40cm
3 40lts



LIXEIRA PLAST C/ PEDAL 40 LTS ECO 3074

Código: Fábrica: Unidade:
49171 JAGUAR UN/1
F1 F4

UN: R\$ 400,53 AV: R\$ 400,53 15: R\$ 408,88
30: R\$ 417,05 45: R\$ 425,39 60: R\$ 433,90

1 90cm
2 50cm



LIXEIRA PLAST C/PEDAL E RODINHA 120 LTS

Código: Fábrica: Unidade:
45930 ANTARES UN/1
F1 F4

UN: R\$ 58,89 AV: R\$ 58,89 15: R\$ 60,12
30: R\$ 61,32 45: R\$ 62,55 60: R\$ 63,80



LIXEIRA PLAST C/PEDAL LTS DEC COLOR 1557

Código: Fábrica: Unidade:
41465 MABEL UN/1
F1 F4

UN: R\$ 83,64 AV: R\$ 83,64 15: R\$ 85,39
30: R\$ 87,09 45: R\$ 88,84 60: R\$ 90,61



LIXEIRA PLAST C/PEDAL 12 LTS BRANCA 300

Código: Fábrica: Unidade:
39343 GUARANY UN/1
F1 F4

UN: R\$ 38,86 AV: R\$ 38,86 15: R\$ 39,67
30: R\$ 40,47 45: R\$ 41,28 60: R\$ 42,10



LIXEIRA PLAST C/PEDAL 13 LTS 6313

Código: Fábrica: Unidade:
40984 PLASTIBRASIL UN/1
F1 F4

UN: R\$ 39,31 AV: R\$ 39,31 15: R\$ 40,13
30: R\$ 40,93 45: R\$ 41,75 60: R\$ 42,59

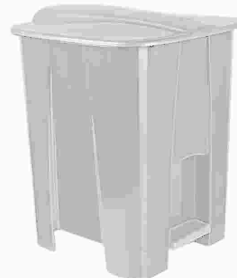

LIXEIRA PLAST C/PEDAL 15 LTS BRANCA 805

Código: Fábrica: Unidade:
51048 LUMAR UN/1
F1 F4

UN: R\$ 56,90 AV: R\$ 56,90 15: R\$ 58,09
30: R\$ 59,25 45: R\$ 60,43 60: R\$ 61,64

1 38cm
2 15lts



LIXEIRA PLAST C/PEDAL 15 LTS PRETO 383

Código: Fábrica: Unidade:
44424 USUAL UN/1
F1 F4

UN: R\$ 393,69 AV: R\$ 393,69 15: R\$ 401,90
30: R\$ 409,93 45: R\$ 418,13 60: R\$ 426,50



LIXEIRA PLAST C/PEDAL 15 LTS PRETO 808

Código: Fábrica: Unidade:
51049 LUMAR UN/1
F1 F4

UN: R\$ 117,80 AV: R\$ 117,80 15: R\$ 120,25
30: R\$ 122,65 45: R\$ 125,11 60: R\$ 127,61

1 67cm
2 39cm



LIXEIRA PLAST C/PEDAL 60 LTS BRANCA

Código: Fábrica: Unidade:
45929 ANTARES UN/1
F1 F4

UN: R\$ 110,89 AV: R\$ 110,89 15: R\$ 113,20
30: R\$ 115,47 45: R\$ 117,78 60: R\$ 120,13

1 67cm
2 39cm



LIXEIRA PLAST C/PEDAL 60 LTS PRETA

Código: Fábrica: Unidade:
48663 ANTARES UN/1
F1 F4

UN: R\$ 36,51 AV: R\$ 36,51 15: R\$ 37,27
30: R\$ 38,01 45: R\$ 38,77 60: R\$ 39,55

1 28cm
2 7lts



LIXEIRA PLAST C/PEDAL 7,0 LTS 281

Código: Fábrica: Unidade:
45443 TRITEC UN/1
F1 F4

UN: R\$ 16,48 AV: R\$ 16,48 15: R\$ 16,82
30: R\$ 17,16 45: R\$ 17,50 60: R\$ 17,86

1 25 cm
2 25 cm



LIXEIRA PLAST C/PEDAL 7,5 LTS RED PRETA

Código: Fábrica: Unidade:
45446 PLASMARC UN/1
F1 F4

UN: R\$ 3,95 AV: R\$ 3,95 15: R\$ 4,03
30: R\$ 4,11 45: R\$ 4,19 60: R\$ 4,28



LIXEIRA PLAST C/TAMPA LTS 921

Código: Fábrica: Unidade:
34577 PLASTBON UN/1
F1 F4

UN: R\$ 15,30 AV: R\$ 15,30 15: R\$ 15,62
30: R\$ 15,93 45: R\$ 16,25 60: R\$ 16,58



LIXEIRA PLAST C/TAMPA 6 LTS PRETO 112

Código: Fábrica: Unidade:
50004 PLASMARC UN/1
F1 F4

UN: R\$ 13,53 AV: R\$ 13,53 15: R\$ 13,81
30: R\$ 14,09 45: R\$ 14,37 60: R\$ 14,66

1 36cm
2 5,5lts



LIXEIRA PLAST C/TPA 5,5 LTS 3067

Código: Fábrica: Unidade:
492 JAGUAR UN/1
F1 F4

UN: R\$ 5,29 AV: R\$ 5,29 15: R\$ 5,40
30: R\$ 5,51 45: R\$ 5,62 60: R\$ 5,73
13,5 cm



LIXEIRA PLAST DE MESA 13.5CM 57010

Código: Fábrika: Unidade:
38423 ALMEGA UN/1
F1 F4

UN: R\$ 55,46 AV: R\$ 55,46 15: R\$ 56,61
30: R\$ 57,75 45: R\$ 58,90 60: R\$ 60,08



LIXEIRA PLAST PEDAL 7LT RATTAN PRET 1987

Código: Fábrika: Unidade:
38377 MONTE LIBANO UN/1
F1 F4

UN: R\$ 15,10 AV: R\$ 15,10 15: R\$ 15,41
30: R\$ 15,72 45: R\$ 16,04 60: R\$ 16,36



LIXEIRA PLAST 13 LTS PRETA

Código: Fábrika: Unidade:
28677 ECOPLASTIC UN/1
F1 F4

UN: R\$ 10,06 AV: R\$ 10,06 15: R\$ 10,27
30: R\$ 10,47 45: R\$ 10,68 60: R\$ 10,89



LIXEIRA PLAST 2 LTS BASC P/PIA 4001

Código: Fábrika: Unidade:
13891 SBRISSA UN/1
F1 F4

UN: R\$ 9,23 AV: R\$ 9,23 15: R\$ 9,43
30: R\$ 9,62 45: R\$ 9,81 60: R\$ 10,00



LIXEIRA PLAST 2,5 LTS P/PIA 7010

Código: Fábrika: Unidade:
31285 SBRISSA UN/1
F1 F4

UN: R\$ 11,56 AV: R\$ 11,56 15: R\$ 11,80
30: R\$ 12,03 45: R\$ 12,27 60: R\$ 12,52
26cm
8cm
3,2lts



LIXEIRA PLAST 3,2 LTS BASC 6650

Código: Fábrika: Unidade:
20157 INPLAST UN/1
F1 F4

UN: R\$ 33,52 AV: R\$ 33,52 15: R\$ 34,22
30: R\$ 34,90 45: R\$ 35,60 60: R\$ 36,31



MACARICO PORTATIL PROF 17X6CM 1853

Código: Fábrika: Unidade:
50956 HAI BRASIL UN/1
F1 F4

UN: R\$ 16,42 AV: R\$ 16,42 15: R\$ 16,77
30: R\$ 17,10 45: R\$ 17,44 60: R\$ 17,79



MANGUEIRA GAS 1,00M MANTAC 100

Código: Fábrika: Unidade:
47883 MANTAC UN/1
F1 F4

UN: R\$ 22,59 AV: R\$ 22,59 15: R\$ 23,06
30: R\$ 23,52 45: R\$ 23,99 60: R\$ 24,47



MANGUEIRA GAS 1,25M C/2 ABRACADEIRAS 500

Código: Fábrika: Unidade:
47884 VINIGAS UN/1
F1 F4

UN: R\$ 70,87 AV: R\$ 70,87 15: R\$ 72,34
30: R\$ 73,79 45: R\$ 75,27 60: R\$ 76,77



MANGUEIRA JD 10M ESG REG CAM DUPLA AZUL

Código: Fábrika: Unidade:
18512 NUTRIPLAN UN/1
F1 F4

UN: R\$ 42,79 AV: R\$ 42,79 15: R\$ 43,68
30: R\$ 44,56 45: R\$ 45,45 60: R\$ 46,36



MANGUEIRA JD 10MTS TRANC CRISTAL 14017

Código: Fábrika: Unidade:
48828 ARQUA UN/1
F1 F4

UN: R\$ 41,87 AV: R\$ 41,87 15: R\$ 42,74
30: R\$ 43,60 45: R\$ 44,47 60: R\$ 45,36



MANGUEIRA JD 10MTS TRANC FLEX VERD 14007

Código: Fábrika: Unidade:
48830 ARQUA UN/1
F1 F4

UN: R\$ 53,20 AV: R\$ 53,20 15: R\$ 54,31
30: R\$ 55,39 45: R\$ 56,50 60: R\$ 57,63



MANGUEIRA JD 15MTS POP VERDE 14002

Código: Fábrika: Unidade:
48826 ARQUA UN/1
F1 F4

UN: R\$ 61,97 AV: R\$ 61,97 15: R\$ 63,26
30: R\$ 64,53 45: R\$ 65,82 60: R\$ 67,13



MANGUEIRA JD 15MTS TRANC CRISTAL 14018

Código: Fábrika: Unidade:
48831 ARQUA UN/1
F1 F4

UN: R\$ 60,75 AV: R\$ 60,75 15: R\$ 62,01
30: R\$ 63,25 45: R\$ 64,52 60: R\$ 65,81



MANGUEIRA JD 15MTS TRANC FLEX VERD 14008

Código: Fábrika: Unidade:
48827 ARQUA UN/1
F1 F4

UN: R\$ 70,28 AV: R\$ 70,28 15: R\$ 71,75
30: R\$ 73,18 45: R\$ 74,64 60: R\$ 76,14



MANGUEIRA JD 20MTS POP VERDE 14003

Código: Fábrika: Unidade:
48825 ARQUA UN/1
F1 F4

UN: R\$ 80,93 AV: R\$ 80,93 15: R\$ 82,62
30: R\$ 84,27 45: R\$ 85,96 60: R\$ 87,68



MANGUEIRA JD 20MTS TRANC CRISTAL 14019
Código: Fábrica: Unidade:
48832 ARQUA UN/1
F1 F4

UN: R\$ 74,63 AV: R\$ 74,63 15: R\$ 76,18
30: R\$ 77,70 45: R\$ 79,26 60: R\$ 80,84



MANGUEIRA JD 20MTS TRANC FLEX COLOR 158
Código: Fábrica: Unidade:
40231 MONTEREY UN/1
F1 F4

UN: R\$ 79,89 AV: R\$ 79,89 15: R\$ 81,55
30: R\$ 83,18 45: R\$ 84,84 60: R\$ 86,54



MANGUEIRA JD 20MTS TRANC FLEX VERD 14009
Código: Fábrica: Unidade:
48833 ARQUA UN/1
F1 F4

UN: R\$ 167,42 AV: R\$ 167,42 15: R\$ 170,91
30: R\$ 174,33 45: R\$ 177,82 60: R\$ 181,37



MANGUEIRA JD 30M ESG REG CAM DUPLA AZUL
Código: Fábrica: Unidade:
27119 NUTRIPLAN UN/1
F1 F4

UN: R\$ 103,14 AV: R\$ 103,14 15: R\$ 105,29
30: R\$ 107,40 45: R\$ 109,54 60: R\$ 111,73



MANGUEIRA JD 30MTS POP VERDE 14030
Código: Fábrica: Unidade:
48824 ARQUA UN/1
F1 F4

UN: R\$ 111,85 AV: R\$ 111,85 15: R\$ 114,18
30: R\$ 116,47 45: R\$ 118,80 60: R\$ 121,17



MANGUEIRA JD 30MTS TRANC FLEX COLOR 160
Código: Fábrica: Unidade:
34405 MONTEREY UN/1
F1 F4

UN: R\$ 118,49 AV: R\$ 118,49 15: R\$ 120,96
30: R\$ 123,38 45: R\$ 125,84 60: R\$ 128,36



MANGUEIRA JD 30MTS TRANC FLEX VERD 14011
Código: Fábrica: Unidade:
48823 ARQUA UN/1
F1 F4

UN: R\$ 8,72 AV: R\$ 8,72 15: R\$ 8,90
30: R\$ 9,08 45: R\$ 9,26 60: R\$ 9,45



MARMITA ALUM REDONDA 10 686
Código: Fábrica: Unidade:
12305 MSR UN/1
F1 F4

UN: R\$ 10,58 AV: R\$ 10,58 15: R\$ 10,80
30: R\$ 11,02 45: R\$ 11,24 60: R\$ 11,46



MARMITA ALUM REDONDA 12 687
Código: Fábrica: Unidade:
10431 MSR UN/1
F1 F4

UN: R\$ 16,42 AV: R\$ 16,42 15: R\$ 16,77
30: R\$ 17,10 45: R\$ 17,44 60: R\$ 17,79



MARMITA ALUM REDONDA 14 688
Código: Fábrica: Unidade:
24365 MSR UN/1
F1 F4

UN: R\$ 17,45 AV: R\$ 17,45 15: R\$ 17,82
30: R\$ 18,17 45: R\$ 18,54 60: R\$ 18,91



MARMITA ALUM REDONDA 16 689
Código: Fábrica: Unidade:
22729 MSR UN/1
F1 F4

UN: R\$ 20,53 AV: R\$ 20,53 15: R\$ 20,96
30: R\$ 21,38 45: R\$ 21,81 60: R\$ 22,24



MARMITA ALUM REDONDA 18 690
Código: Fábrica: Unidade:
14610 MSR UN/1
F1 F4

UN: R\$ 10,72 AV: R\$ 10,72 15: R\$ 10,94
30: R\$ 11,16 45: R\$ 11,39 60: R\$ 11,61



MARMITA PLAST INF 2 DIV C/COLHER 8345
Código: Fábrica: Unidade:
26086 SATYAM UN/1
F1 F4

UN: R\$ 12,95 AV: R\$ 12,95 15: R\$ 13,22
30: R\$ 13,48 45: R\$ 13,75 60: R\$ 14,03

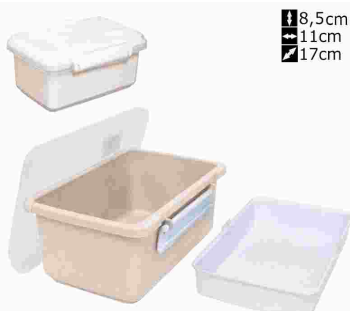

MARMITA PLAST 1 LT C/TRAVA VALVULA 256
Código: Fábrica: Unidade:
44436 USUAL UN/1
F1 F4

UN: R\$ 29,99 AV: R\$ 29,99 15: R\$ 29,99
30: R\$ 29,99 45: R\$ 29,99 60: R\$ 29,99



MARMITA TERMICA ALUM RED 14 692
Código: Fábrica: Unidade:
19605 MSR UN/1
F1 F4

UN: R\$ 35,94 AV: R\$ 35,94 15: R\$ 36,69
30: R\$ 37,42 45: R\$ 38,17 60: R\$ 38,94



MARMITA TERMICA ALUM RED 16 C/BOLSA 694
Código: Fábrica: Unidade:
26822 MSR UN/1
F1 F4

UN: R\$ 29,99 AV: R\$ 29,99 15: R\$ 29,99
30: R\$ 29,99 45: R\$ 29,99 60: R\$ 29,99



MARMITA TERMICA ALUM RED 16 693
Código: Fábrica: Unidade:
2218 MSR UN/1
F1 F4

UN: R\$ 27,99 AV: R\$ 27,99 15: R\$ 27,99
30: R\$ 27,99 45: R\$ 27,99 60: R\$ 27,99



MARMITA TERMICA ALUM RET 16
Código: Fábrica: Unidade:
2219 MSR/DF UN/1
F1 F4

UN: R\$ 0,53 AV: R\$ 53,41 15: R\$ 54,53
30: R\$ 55,62 45: R\$ 56,73 60: R\$ 57,86



MARMITEX ISOPOR C/TAMPA 500 ML 100X1
Código: Fábrica: Unidade:
50421 ULTRA PT/100
F1 F4

UN: R\$ 12,84 AV: R\$ 12,84 15: R\$ 13,11
30: R\$ 13,37 45: R\$ 13,64 60: R\$ 13,91



MARTELO ALUM INTEIRICO 2006 UN
Código: Fábrica: Unidade:
48023 COFAX UN/1
F1 F4

UN: R\$ 6,86 AV: R\$ 6,86 15: R\$ 7,00
30: R\$ 7,14 45: R\$ 7,29 60: R\$ 7,43



MARTELO ALUM 19CM CB MAD 2021 UN
Código: Fábrica: Unidade:
48021 COFAX UN/1
F1 F4

UN: R\$ 33,79 AV: R\$ 33,79 15: R\$ 34,50
30: R\$ 35,19 45: R\$ 35,89 60: R\$ 36,61



MASSAGEADOR ROSTO E LIMPEZA FACIAL RECAR
Código: Fábrica: Unidade:
35624 FOREVER CX/1
F1 F4

UN: R\$ 1,05 AV: R\$ 2,11 15: R\$ 2,15
30: R\$ 2,19 45: R\$ 2,24 60: R\$ 2,28



MATA MOSCA PLAST 48CM CB MADEIRA 264 UN
Código: Fábrica: Unidade:
45440 TRITEC PT/2
F1 F4

UN: R\$ 55,46 AV: R\$ 55,46 15: R\$ 56,61
30: R\$ 57,75 45: R\$ 58,90 60: R\$ 60,08



MESA INFANTIL AZUL
Código: Fábrica: Unidade:
22789 ANTARES UN/1
F1 F4

UN: R\$ 143,80 AV: R\$ 143,80 15: R\$ 146,79
30: R\$ 149,73 45: R\$ 152,72 60: R\$ 155,78



MESA INFANTIL DOBRAVEL AZUL
Código: Fábrica: Unidade:
28513 ANTARES UN/1
F1 F4

UN: R\$ 143,80 AV: R\$ 143,80 15: R\$ 146,79
30: R\$ 149,73 45: R\$ 152,72 60: R\$ 155,78



MESA INFANTIL DOBRAVEL ROSA
Código: Fábrica: Unidade:
28512 ANTARES UN/1
F1 F4

UN: R\$ 55,46 AV: R\$ 55,46 15: R\$ 56,61
30: R\$ 57,75 45: R\$ 58,90 60: R\$ 60,08



MESA INFANTIL ROSA
Código: Fábrica: Unidade:
23042 ANTARES UN/1
F1 F4

UN: R\$ 261,94 AV: R\$ 261,94 15: R\$ 267,39
30: R\$ 272,74 45: R\$ 278,20 60: R\$ 283,76



MESA MADEIRA C/ 2 BANQUETAS STELL
Código: Fábrica: Unidade:
35641 AMOF UN/1
F1 F4

UN: R\$ 118,12 AV: R\$ 118,12 15: R\$ 120,58
30: R\$ 122,99 45: R\$ 125,45 60: R\$ 127,96



MESA MONOBLOCO BEGE
Código: Fábrica: Unidade:
23044 ANTARES UN/1
F1 F4

UN: R\$ 137,63 AV: R\$ 137,63 15: R\$ 140,50
30: R\$ 143,31 45: R\$ 146,18 60: R\$ 149,10



MESA MONOBLOCO BRANCA
Código: Fábrica: Unidade:
22589 ANTARES UN/1
F1 F4

UN: R\$ 123,25 AV: R\$ 123,25 15: R\$ 125,82
30: R\$ 128,34 45: R\$ 130,90 60: R\$ 133,52



MESA MONOBLOCO OURO PRETO PRETA
Código: Fábrica: Unidade:
44669 ANTARES UN/1
F1 F4

UN: R\$ 123,25 AV: R\$ 123,25 15: R\$ 125,82
30: R\$ 128,34 45: R\$ 130,90 60: R\$ 133,52



MESA MONOBLOCO VINHO
Código: Fábrica: Unidade:
22591 ANTARES UN/1
F1 F4

UN: R\$ 195,16 AV: R\$ 195,16 15: R\$ 199,22
30: R\$ 203,21 45: R\$ 207,27 60: R\$ 211,42



MESA PLASTICA RED BEGE DESMONTAVEL

Código: Fábrica: Unidade:
20001 ANTARES UN/1
F1 F4

UN: R\$ 195,16 AV: R\$ 195,16 15: R\$ 199,22
30: R\$ 203,21 45: R\$ 207,27 60: R\$ 211,42



MESA PLASTICA RED BRANCA DESMONTAVEL

Código: Fábrica: Unidade:
20002 ANTARES UN/1
F1 F4

UN: R\$ 6,15 AV: R\$ 6,15 15: R\$ 6,28
30: R\$ 6,41 45: R\$ 6,53 60: R\$ 6,67



MIX PERLITA CARVAO CASCA DE ARROZ 1 LITR

Código: Fábrica: Unidade:
48529 NOVATROPICAL PT/1
F1 F4

UN: R\$ 82,17 AV: R\$ 82,17 15: R\$ 83,88
30: R\$ 85,56 45: R\$ 87,27 60: R\$ 89,01



MOP FLAT C/1 REFIL 474

Código: Fábrica: Unidade:
41263 123UTIL UN/1
F1 F4

UN: R\$ 7,63 AV: R\$ 7,63 15: R\$ 7,79
30: R\$ 7,95 45: R\$ 8,11 60: R\$ 8,27



26cm
1,2lts

MORINGA PLAST 1,2 LTS COLOR 817

Código: Fábrica: Unidade:
35842 LUMAR UN/1
F1 F4

UN: R\$ 7,18 AV: R\$ 7,18 15: R\$ 7,33
30: R\$ 7,48 45: R\$ 7,63 60: R\$ 7,78



MUSGO SPHAGNUM 1 LITRO

Código: Fábrica: Unidade:
48535 NOVATROPICAL PT/1
F1 F4

UN: R\$ 7,45 AV: R\$ 7,45 15: R\$ 7,60
30: R\$ 7,75 45: R\$ 7,91 60: R\$ 8,07



MUSGO VERDE 50 GRS 1 LITRO

Código: Fábrica: Unidade:
34750 NOVATROPICAL PT/1
F1 F4

UN: R\$ 13,21 AV: R\$ 13,21 15: R\$ 13,49
30: R\$ 13,75 45: R\$ 14,03 60: R\$ 14,31

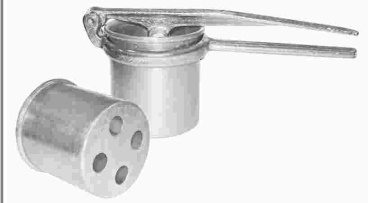

NHOQUEIRA ALUM INTERICO 22CM 2015 UN

Código: Fábrica: Unidade:
48025 COFAX UN/1
F1 F4

UN: R\$ 8,17 AV: R\$ 8,17 15: R\$ 8,34
30: R\$ 8,50 45: R\$ 8,67 60: R\$ 8,85



ORGANIZADOR MOD RATTAN 10X7X11CM BABY942

Código: Fábrica: Unidade:
38393 MONTE LIBANO UN/1
F1 F4

UN: R\$ 8,17 AV: R\$ 8,17 15: R\$ 8,34
30: R\$ 8,50 45: R\$ 8,67 60: R\$ 8,85



ORGANIZADOR MOD RATTAN 10X7X11CM BCO 940

Código: Fábrica: Unidade:
38391 MONTE LIBANO UN/1
F1 F4

UN: R\$ 8,17 AV: R\$ 8,17 15: R\$ 8,34
30: R\$ 8,50 45: R\$ 8,67 60: R\$ 8,85



ORGANIZADOR MOD RATTAN 10X7X11CM TEND943

Código: Fábrica: Unidade:
38394 MONTE LIBANO UN/1
F1 F4

UN: R\$ 13,25 AV: R\$ 13,25 15: R\$ 13,53
30: R\$ 13,80 45: R\$ 14,07 60: R\$ 14,35



ORGANIZADOR MOD RATTAN 15X10X11CM BAB962

Código: Fábrica: Unidade:
38397 MONTE LIBANO UN/1
F1 F4

UN: R\$ 13,25 AV: R\$ 13,25 15: R\$ 13,53
30: R\$ 13,80 45: R\$ 14,07 60: R\$ 14,35



ORGANIZADOR MOD RATTAN 15X10X11CM BCO960

Código: Fábrica: Unidade:
38395 MONTE LIBANO UN/1
F1 F4

UN: R\$ 13,25 AV: R\$ 13,25 15: R\$ 13,53
30: R\$ 13,80 45: R\$ 14,07 60: R\$ 14,35



ORGANIZADOR MOD RATTAN 15X10X11CM PTO961

Código: Fábrica: Unidade:
38396 MONTE LIBANO UN/1
F1 F4

UN: R\$ 13,25 AV: R\$ 13,25 15: R\$ 13,53
30: R\$ 13,80 45: R\$ 14,07 60: R\$ 14,35

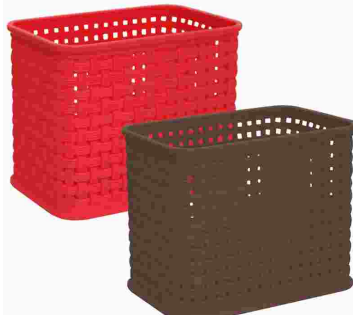

ORGANIZADOR MOD RATTAN 15X10X11CM TEN963

Código: Fábrica: Unidade:
38398 MONTE LIBANO UN/1
F1 F4

UN: R\$ 9,23 AV: R\$ 9,23 15: R\$ 9,43
30: R\$ 9,62 45: R\$ 9,81 60: R\$ 10,00

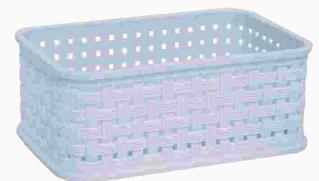

ORGANIZADOR MOD RATTAN 15X10X6CM BABY932

Código: Fábrica: Unidade:
38402 MONTE LIBANO UN/1
F1 F4

UN: R\$ 9,23 AV: R\$ 9,23 15: R\$ 9,43
30: R\$ 9,62 45: R\$ 9,81 60: R\$ 10,00

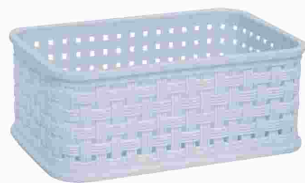

ORGANIZADOR MOD RATTAN 15X10X6CM BCO 930
Código: 38388 Fábrica: MONTE LIBANO Unidade: UN/1
F1 F4

UN: R\$ 9,23 AV: R\$ 9,23 15: R\$ 9,43
30: R\$ 9,62 45: R\$ 9,81 60: R\$ 10,00

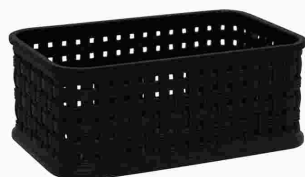

ORGANIZADOR MOD RATTAN 15X10X6CM PTO 931
Código: 38389 Fábrica: MONTE LIBANO Unidade: UN/1
F1 F4

UN: R\$ 9,23 AV: R\$ 9,23 15: R\$ 9,43
30: R\$ 9,62 45: R\$ 9,81 60: R\$ 10,00



ORGANIZADOR MOD RATTAN 15X10X6CM TEND933
Código: 38390 Fábrica: MONTE LIBANO Unidade: UN/1
F1 F4

UN: R\$ 15,87 AV: R\$ 15,87 15: R\$ 16,20
30: R\$ 16,52 45: R\$ 16,86 60: R\$ 17,19



ORGANIZADOR MOD RATTAN 20X15X6CM 970
Código: 38384 Fábrica: MONTE LIBANO Unidade: UN/1
F1 F4

UN: R\$ 15,19 AV: R\$ 15,19 15: R\$ 15,50
30: R\$ 15,81 45: R\$ 16,13 60: R\$ 16,45

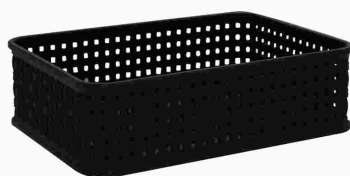

ORGANIZADOR MOD RATTAN 20X15X6CM PTO 971
Código: 38386 Fábrica: MONTE LIBANO Unidade: UN/1
F1 F4

UN: R\$ 17,97 AV: R\$ 17,97 15: R\$ 18,34
30: R\$ 18,71 45: R\$ 19,08 60: R\$ 19,46



ORGANIZADOR MOD RATTAN 30X10X6CM BABY952
Código: 38382 Fábrica: MONTE LIBANO Unidade: UN/1
F1 F4

UN: R\$ 17,97 AV: R\$ 17,97 15: R\$ 18,34
30: R\$ 18,71 45: R\$ 19,08 60: R\$ 19,46

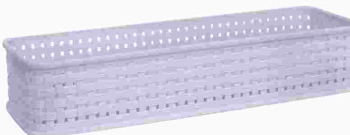

ORGANIZADOR MOD RATTAN 30X10X6CM BCO 950
Código: 38380 Fábrica: MONTE LIBANO Unidade: UN/1
F1 F4

UN: R\$ 17,97 AV: R\$ 17,97 15: R\$ 18,34
30: R\$ 18,71 45: R\$ 19,08 60: R\$ 19,46



ORGANIZADOR MOD RATTAN 30X10X6CM TEND953
Código: 38381 Fábrica: MONTE LIBANO Unidade: UN/1
F1 F4

UN: R\$ 17,60 AV: R\$ 17,60 15: R\$ 17,96
30: R\$ 18,32 45: R\$ 18,69 60: R\$ 19,06



ORGANIZADOR PLAST C/DIV 23X14,8X4CM 2015
Código: 37313 Fábrica: MONTE LIBANO Unidade: UN/1
F1 F4

UN: R\$ 22,55 AV: R\$ 22,55 15: R\$ 23,02
30: R\$ 23,48 45: R\$ 23,95 60: R\$ 24,43



ORGANIZADOR PLAST C/DIV 28X18X4,5CM 2020
Código: 37312 Fábrica: MONTE LIBANO Unidade: UN/1
F1 F4

UN: R\$ 36,98 AV: R\$ 36,98 15: R\$ 37,75
30: R\$ 38,50 45: R\$ 39,27 60: R\$ 40,06
7 cm
37 cm



ORGANIZADOR PLAST C/DIV 37X28,5X7CM 2025
Código: 38376 Fábrica: MONTE LIBANO Unidade: UN/1
F1 F4

UN: R\$ 9,19 AV: R\$ 9,19 15: R\$ 9,38
30: R\$ 9,57 45: R\$ 9,76 60: R\$ 9,95



ORGANIZADORA PLAST RED 5,5 LTS BCA 952
Código: 34581 Fábrica: PLASTBON Unidade: UN/1
F1 F4

UN: R\$ 9,60 AV: R\$ 9,60 15: R\$ 9,80
30: R\$ 10,00 45: R\$ 10,20 60: R\$ 10,40



ORGANIZADORA PLAST RED 5,5 LTS COLOR1088
Código: 34584 Fábrica: PLASTBON Unidade: UN/1
F1 F4

UN: R\$ 12,28 AV: R\$ 12,28 15: R\$ 12,53
30: R\$ 12,78 45: R\$ 13,04 60: R\$ 13,30



PA LIXO METAL CB MADEIRA 60CM
Código: 17510 Fábrica: HALLE Unidade: UN/1
F1 F4

UN: R\$ 15,90 AV: R\$ 15,90 15: R\$ 16,24
30: R\$ 16,56 45: R\$ 16,89 60: R\$ 17,23



PA LIXO PLAST C/CABO MAD LONGO 033
Código: 33514 Fábrica: BENEDETTI Unidade: UN/1
F1 F4

UN: R\$ 9,23 AV: R\$ 9,23 15: R\$ 9,43
30: R\$ 9,62 45: R\$ 9,81 60: R\$ 10,00



PA LIXO PLAST C/CABO PEQ COLOR PLUS 3051
Código: 49812 Fábrica: HALLEY Unidade: UN/1
F1 F4

UN: R\$ 7,18 AV: R\$ 7,18 15: R\$ 7,33
30: R\$ 7,48 45: R\$ 7,63 60: R\$ 7,78



PA LIXO PLAST C/CABO PEQ PRETA 2497
Código: Fábrica: Unidade:
49813 EDS UN/1
F1 F4

UN: R\$ 3,95 AV: R\$ 3,95 15: R\$ 4,03
30: R\$ 4,11 45: R\$ 4,19 60: R\$ 4,28



PA LIXO PLAST COLOR 28CM 09
Código: Fábrica: Unidade:
44084 QUALYPLAS UN/1
F1 F4

UN: R\$ 3,80 AV: R\$ 3,80 15: R\$ 3,88
30: R\$ 3,96 45: R\$ 4,04 60: R\$ 4,12



PA LIXO PLAST CORES
Código: Fábrica: Unidade:
12902 ANTARES UN/1
F1 F4

UN: R\$ 3,98 AV: R\$ 3,98 15: R\$ 4,06
30: R\$ 4,14 45: R\$ 4,22 60: R\$ 4,31



PA LIXO PLAST PRETA
Código: Fábrica: Unidade:
34093 SHANGRILA UN/1
F1 F4

UN: R\$ 9,37 AV: R\$ 9,37 15: R\$ 9,56
30: R\$ 9,75 45: R\$ 9,95 60: R\$ 10,15



PA LIXO PLAST TABACO
Código: Fábrica: Unidade:
40779 NUTRIPLAN UN/1
F1 F4

UN: R\$ 3,24 AV: R\$ 3,24 15: R\$ 3,31
30: R\$ 3,37 45: R\$ 3,44 60: R\$ 3,51



PA LIXO PLAST 032
Código: Fábrica: Unidade:
23995 BENEDETTI UN/1
F1 F4

UN: R\$ 5,91 AV: R\$ 5,91 15: R\$ 6,03
30: R\$ 6,15 45: R\$ 6,27 60: R\$ 6,40



PA LIXO PLAST 0698
Código: Fábrica: Unidade:
47067 JAGUAR UN/1
F1 F4

UN: R\$ 4,00 AV: R\$ 4,00 15: R\$ 4,08
30: R\$ 4,16 45: R\$ 4,24 60: R\$ 4,33



PA LIXO PLAST 2466
Código: Fábrica: Unidade:
49809 EDS UN/1
F1 F4

UN: R\$ 5,48 AV: R\$ 5,48 15: R\$ 5,59
30: R\$ 5,70 45: R\$ 5,81 60: R\$ 5,93



PA LIXO PLAST 7003
Código: Fábrica: Unidade:
14585 SBRISSA UN/1
F1 F4

UN: R\$ 6,15 AV: R\$ 6,15 15: R\$ 6,28
30: R\$ 6,41 45: R\$ 6,53 60: R\$ 6,67



PA MADEIRA 30 CM (ESPATULA) 012
Código: Fábrica: Unidade:
41318 MAD LAR UN/1
F1 F4

UN: R\$ 6,46 AV: R\$ 6,46 15: R\$ 6,60
30: R\$ 6,73 45: R\$ 6,86 60: R\$ 7,00



PA MADEIRA 38 CM (ESPATULA) 014
Código: Fábrica: Unidade:
41317 MAD LAR UN/1
F1 F4

UN: R\$ 4,31 AV: R\$ 4,31 15: R\$ 4,40
30: R\$ 4,49 45: R\$ 4,58 60: R\$ 4,67



PA MADEIRA 38 CM 110
Código: Fábrica: Unidade:
35827 CSD UN/1
F1 F4

UN: R\$ 75,91 AV: R\$ 75,91 15: R\$ 77,49
30: R\$ 79,04 45: R\$ 80,62 60: R\$ 82,23



PANELA ALUM BATIDO 16 CB MADEIRA 1511
Código: Fábrica: Unidade:
45371 MSR UN/1
F1 F4

UN: R\$ 82,17 AV: R\$ 82,17 15: R\$ 83,88
30: R\$ 85,56 45: R\$ 87,27 60: R\$ 89,01



PANELA ALUM BATIDO 18 CB INTEIRICO 1551
Código: Fábrica: Unidade:
45376 MSR UN/1
F1 F4

UN: R\$ 82,17 AV: R\$ 82,17 15: R\$ 83,88
30: R\$ 85,56 45: R\$ 87,27 60: R\$ 89,01



PANELA ALUM BATIDO 18 CB MADEIRA 1512
Código: Fábrica: Unidade:
45370 MSR UN/1
F1 F4

UN: R\$ 98,97 AV: R\$ 98,97 15: R\$ 101,03
30: R\$ 103,05 45: R\$ 105,11 60: R\$ 107,22



PANELA ALUM BATIDO 20 CB INTEIRICO 1554
Código: Fábrica: Unidade:
45375 MSR UN/1
F1 F4

UN: R\$ 98,97 AV: R\$ 98,97 15: R\$ 101,03
30: R\$ 103,05 45: R\$ 105,11 60: R\$ 107,22



PANELA ALUM BATIDO 20 CB MADEIRA 1513
Código: Fábrika: Unidade:
45369 MSR UN/1
F1 F4

UN: R\$ 117,46 AV: R\$ 117,46 15: R\$ 119,91
30: R\$ 122,31 45: R\$ 124,75 60: R\$ 127,25



PANELA ALUM BATIDO 22 CB INTEIRICO 1552
Código: Fábrika: Unidade:
45374 MSR UN/1
F1 F4

UN: R\$ 143,80 AV: R\$ 143,80 15: R\$ 146,79
30: R\$ 149,73 45: R\$ 152,72 60: R\$ 155,78



PANELA ALUM BATIDO 24 CB INTEIRICO 1553
Código: Fábrika: Unidade:
45373 MSR UN/1
F1 F4

UN: R\$ 220,43 AV: R\$ 220,43 15: R\$ 225,02
30: R\$ 229,52 45: R\$ 234,11 60: R\$ 238,79



PANELA ALUM BATIDO 28 CB MADEIRA 1517
Código: Fábrika: Unidade:
45368 MSR UN/1
F1 F4

UN: R\$ 237,85 AV: R\$ 237,85 15: R\$ 242,80
30: R\$ 247,66 45: R\$ 252,61 60: R\$ 257,66



PANELA ALUM BATIDO 30 CB INTEIRICO 1576
Código: Fábrika: Unidade:
45372 MSR UN/1
F1 F4

UN: R\$ 25,67 AV: R\$ 25,67 15: R\$ 26,20
30: R\$ 26,73 45: R\$ 27,26 60: R\$ 27,81



PANELA ALUM EXTRA 14 CB MADEIRA 697
Código: Fábrika: Unidade:
24373 MSR UN/1
F1 F4

UN: R\$ 32,86 AV: R\$ 32,86 15: R\$ 33,54
30: R\$ 34,22 45: R\$ 34,90 60: R\$ 35,60



PANELA ALUM EXTRA 16 CB MADEIRA 698
Código: Fábrika: Unidade:
24374 MSR UN/1
F1 F4

UN: R\$ 36,97 AV: R\$ 36,97 15: R\$ 37,74
30: R\$ 38,49 45: R\$ 39,26 60: R\$ 40,05



PANELA ALUM EXTRA 18 CB MADEIRA 699
Código: Fábrika: Unidade:
24375 MSR UN/1
F1 F4

UN: R\$ 41,08 AV: R\$ 41,08 15: R\$ 41,93
30: R\$ 42,77 45: R\$ 43,63 60: R\$ 44,50



PANELA ALUM EXTRA 20 CB MADEIRA 700/701
Código: Fábrika: Unidade:
24376 MSR UN/1
F1 F4

UN: R\$ 46,21 AV: R\$ 46,21 15: R\$ 47,18
30: R\$ 48,12 45: R\$ 49,08 60: R\$ 50,06



PANELA ALUM EXTRA 22 CB MADEIRA 701
Código: Fábrika: Unidade:
24377 MSR UN/1
F1 F4

UN: R\$ 54,43 AV: R\$ 54,43 15: R\$ 55,57
30: R\$ 56,68 45: R\$ 57,81 60: R\$ 58,97



PANELA ALUM EXTRA 24 CB MADEIRA 702
Código: Fábrika: Unidade:
24378 MSR UN/1
F1 F4

UN: R\$ 25,67 AV: R\$ 25,67 15: R\$ 26,20
30: R\$ 26,73 45: R\$ 27,26 60: R\$ 27,81



PANELA ALUM LEVE 14 C/TAMPA
Código: Fábrika: Unidade:
5884 AVELAR UN/1
F1 F4

UN: R\$ 25,67 AV: R\$ 25,67 15: R\$ 26,20
30: R\$ 26,73 45: R\$ 27,26 60: R\$ 27,81



PANELA ALUM LEVE 16 C/TAMPA
Código: Fábrika: Unidade:
5885 AVELAR UN/1
F1 F4

UN: R\$ 25,67 AV: R\$ 25,67 15: R\$ 26,20
30: R\$ 26,73 45: R\$ 27,26 60: R\$ 27,81



PANELA ALUM LEVE 18 S/TAMPA
Código: Fábrika: Unidade:
5886 AVELAR UN/1
F1 F4

UN: R\$ 25,67 AV: R\$ 25,67 15: R\$ 26,20
30: R\$ 26,73 45: R\$ 27,26 60: R\$ 27,81



PANELA ALUM LEVE 20 S/TAMPA
Código: Fábrika: Unidade:
5887 AVELAR UN/1
F1 F4

UN: R\$ 29,78 AV: R\$ 29,78 15: R\$ 30,40
30: R\$ 31,01 45: R\$ 31,63 60: R\$ 32,26



PANELA ALUM LUXO 14 CB BAQUELITE 703
Código: Fábrika: Unidade:
25302 MSR UN/1
F1 F4

UN: R\$ 34,84 AV: R\$ 34,84 15: R\$ 35,57
30: R\$ 36,28 45: R\$ 37,01 60: R\$ 37,75



PANELA ALUM LUXO 16 CB BAQUELITE 704
Código: Fábrica: Unidade:
25306 MSR UN/1
F1 F4

UN: R\$ 39,02 AV: R\$ 39,02 15: R\$ 39,84
30: R\$ 40,63 45: R\$ 41,45 60: R\$ 42,27



PANELA ALUM LUXO 18 CB BAQUELITE 705
Código: Fábrica: Unidade:
25307 MSR UN/1
F1 F4

UN: R\$ 43,13 AV: R\$ 43,13 15: R\$ 44,03
30: R\$ 44,91 45: R\$ 45,81 60: R\$ 46,73



PANELA ALUM LUXO 20 CB BAQUELITE 706
Código: Fábrica: Unidade:
25303 MSR UN/1
F1 F4

UN: R\$ 47,24 AV: R\$ 47,24 15: R\$ 48,23
30: R\$ 49,19 45: R\$ 50,17 60: R\$ 51,18



PANELA ALUM LUXO 22 CB BAQUELITE 707
Código: Fábrica: Unidade:
25304 MSR UN/1
F1 F4

UN: R\$ 181,78 AV: R\$ 181,78 15: R\$ 185,57
30: R\$ 189,28 45: R\$ 193,07 60: R\$ 196,93



PANELA PRESSAO 7,0 LTS POLIDA ALUMINE
Código: Fábrica: Unidade:
48116 ALEGRETE UN/1
F1 F4

UN: R\$ 223,90 AV: R\$ 223,90 15: R\$ 228,56
30: R\$ 233,13 45: R\$ 237,80 60: R\$ 242,55



PANELA PRESSAO 10,0 LTS POLIDA ALUMINE
Código: Fábrica: Unidade:
48120 ALEGRETE UN/1
F1 F4

UN: R\$ 5,13 AV: R\$ 5,13 15: R\$ 5,23
30: R\$ 5,34 45: R\$ 5,44 60: R\$ 5,55



PANO CHAO SACO ALG ALVEJ COMBATE 38X58CM
Código: Fábrica: Unidade:
49840 TEXTIL UN/1
F1 F4

UN: R\$ 6,15 AV: R\$ 6,15 15: R\$ 6,28
30: R\$ 6,41 45: R\$ 6,53 60: R\$ 6,67



PANO CHAO SACO ALG ALVEJ M 43X63CM
Código: Fábrica: Unidade:
49831 TEXTIL UN/1
F1 F4

UN: R\$ 4,10 AV: R\$ 4,10 15: R\$ 4,18
30: R\$ 4,27 45: R\$ 4,35 60: R\$ 4,44



PANO CHAO SACO ALG ALVEJ PP 30X55CM
Código: Fábrica: Unidade:
50090 TEXTIL UN/1
F1 F4

UN: R\$ 7,18 AV: R\$ 7,18 15: R\$ 7,33
30: R\$ 7,48 45: R\$ 7,63 60: R\$ 7,78



PANO CHAO SACO ALG ALVEJ TRAD 43X68CM
Código: Fábrica: Unidade:
49839 TEXTIL UN/1
F1 F4

UN: R\$ 8,00 AV: R\$ 8,00 15: R\$ 8,17
30: R\$ 8,33 45: R\$ 8,50 60: R\$ 8,67



PANO CHAO SACO ALG XADREZ M 43X68CM
Código: Fábrica: Unidade:
48794 TEXTIL UN/1
F1 F4

UN: R\$ 10,26 AV: R\$ 10,26 15: R\$ 10,48
30: R\$ 10,69 45: R\$ 10,90 60: R\$ 11,12



PANO CHAO SACO ALG XADREZ SG 78X53CM
Código: Fábrica: Unidade:
20249 TEXTIL UN/1
F1 F4

UN: R\$ 8,21 AV: R\$ 8,21 15: R\$ 8,38
30: R\$ 8,55 45: R\$ 8,72 60: R\$ 8,89

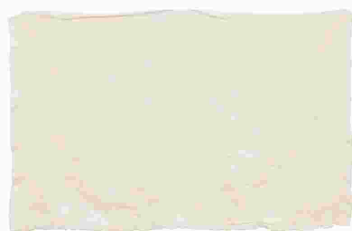

PANO CHAO SACO CRU ECOPLUS 48X85CM
Código: Fábrica: Unidade:
47137 TEXTIL/ENCOP UN/1
F1 F4

UN: R\$ 2,74 AV: R\$ 8,21 15: R\$ 8,38
30: R\$ 8,55 45: R\$ 8,72 60: R\$ 8,89



PANO MULTIUSO MICROFIBRA 30X30CM 010 3X1
Código: Fábrica: Unidade:
49394 RIOHOME PT/3
F1 F4

UN: R\$ 0,74 AV: R\$ 3,69 15: R\$ 3,76
30: R\$ 3,84 45: R\$ 3,92 60: R\$ 3,99



PANO MULTIUSO 30X50CM AZUL 5X1
Código: Fábrica: Unidade:
48716 NOBRE PT/5
F1 F4

UN: R\$ 5,69 AV: R\$ 5,69 15: R\$ 5,81
30: R\$ 5,93 45: R\$ 6,04 60: R\$ 6,16



PANO PRATO ALGODAO LISO RUBI 65X40CM
Código: Fábrica: Unidade:
49795 ENGOMATEXTIL UN/1
F1 F4

UN: R\$ 5,95 AV: R\$ 5,95 15: R\$ 5,95
30: R\$ 5,95 45: R\$ 5,95 60: R\$ 5,95



PANO PRATO LISO EXTRA 100% ALGO 72X45CM
Código: Fábrica: Unidade:
48813 ENGOMATEX UN/1
F1 F4

UN: R\$ 3,08 AV: R\$ 30,81 15: R\$ 31,45
30: R\$ 32,08 45: R\$ 32,72 60: R\$ 33,37



PANO PRATO LISO RUBI 65X40CM 114 10X1
Código: Fábrica: Unidade:
39380 ENGOMATEXIL PT/10
F1 F4

UN: R\$ 12,32 AV: R\$ 12,32 15: R\$ 12,57
30: R\$ 12,82 45: R\$ 13,08 60: R\$ 13,34



PAPEIRO ALUM LEVE 16 708
Código: Fábrica: Unidade:
20734 MSR UN/1
F1 F4

UN: R\$ 7,96 AV: R\$ 7,96 15: R\$ 8,13
30: R\$ 8,29 45: R\$ 8,46 60: R\$ 8,62

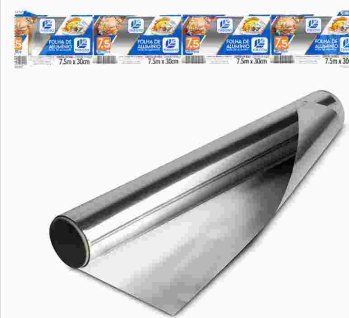

PAPEL ALUMINIO 7,5MTSX30CM 19935
Código: Fábrica: Unidade:
47844 THEOTO/MELLO RL/1
F1 F4

UN: R\$ 5,34 AV: R\$ 5,34 15: R\$ 5,45
30: R\$ 5,56 45: R\$ 5,67 60: R\$ 5,79



PAPEL MANTEIGA 28CMX4M 21754
Código: Fábrica: Unidade:
50076 BOMPACK RL/1
F1 F4

UN: R\$ 7,18 AV: R\$ 7,18 15: R\$ 7,33
30: R\$ 7,48 45: R\$ 7,63 60: R\$ 7,78



PAPEL MANTEIGA 28CMX7,5M
Código: Fábrica: Unidade:
48695 BOMPACK RL/1
F1 F4

UN: R\$ 4,10 AV: R\$ 8,21 15: R\$ 8,38
30: R\$ 8,55 45: R\$ 8,72 60: R\$ 8,89



PAPEL TOALHA 20X22CM BCO FOLHA DUPLA 2X1
Código: Fábrica: Unidade:
47980 NOBRE SENSE PT/2
F1 F4

UN: R\$ 7,18 AV: R\$ 7,18 15: R\$ 7,33
30: R\$ 7,48 45: R\$ 7,63 60: R\$ 7,78

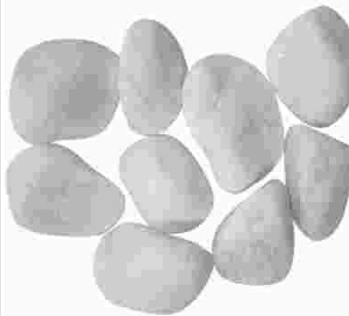

PEDRA DOLOMITA BRANCO 3 1 KG
Código: Fábrica: Unidade:
22888 NOVATROPICAL PT/1
F1 F4

UN: R\$ 61,62 AV: R\$ 61,62 15: R\$ 62,91
30: R\$ 64,16 45: R\$ 65,45 60: R\$ 66,76



PEDRA SEIXO MARMORE 15 KG N0
Código: Fábrica: Unidade:
34647 NOVATROPICAL PT/1
F1 F4

UN: R\$ 61,62 AV: R\$ 61,62 15: R\$ 62,91
30: R\$ 64,16 45: R\$ 65,45 60: R\$ 66,76



PEDRA SEIXO MARMORE 15 KG N1
Código: Fábrica: Unidade:
33905 NOVATROPICAL PT/1
F1 F4

UN: R\$ 61,62 AV: R\$ 61,62 15: R\$ 62,91
30: R\$ 64,16 45: R\$ 65,45 60: R\$ 66,76



PEDRA SEIXO MARMORE 15 KG N2
Código: Fábrica: Unidade:
33430 NOVATROPICAL PT/1
F1 F4

UN: R\$ 61,62 AV: R\$ 61,62 15: R\$ 62,91
30: R\$ 64,16 45: R\$ 65,45 60: R\$ 66,76



PEDRA SEIXO MARMORE 15 KG N3
Código: Fábrica: Unidade:
33235 NOVATROPICAL PT/1
F1 F4

UN: R\$ 41,08 AV: R\$ 41,08 15: R\$ 41,93
30: R\$ 42,77 45: R\$ 43,63 60: R\$ 44,50



PEGADOR INOX CHURRASCO 38CM CAB MAD 2038
Código: Fábrica: Unidade:
41347 HAUSKRAFT UN/1
F1 F4

UN: R\$ 10,26 AV: R\$ 10,26 15: R\$ 10,48
30: R\$ 10,69 45: R\$ 10,90 60: R\$ 11,12



PEGADOR INOX MASSAS 29CM ITALIA CTL 800
Código: Fábrica: Unidade:
47990 PLANETA CR/1
F1 F4

UN: R\$ 22,58 AV: R\$ 22,58 15: R\$ 23,05
30: R\$ 23,51 45: R\$ 23,98 60: R\$ 24,46



PEGADOR INOX MULTUSO 28CM PE60
Código: Fábrica: Unidade:
46582 HERCULES UN/1
F1 F4

UN: R\$ 1,90 AV: R\$ 1,90 15: R\$ 1,94
30: R\$ 1,98 45: R\$ 2,02 60: R\$ 2,06



PEGADOR MACARRAO NYLON REF 503
Código: Fábrica: Unidade:
10988 PLASUTIL UN/1
F1 F4

UN: R\$ 2,29 AV: R\$ 4,57 15: R\$ 4,67
30: R\$ 4,76 45: R\$ 4,85 60: R\$ 4,95

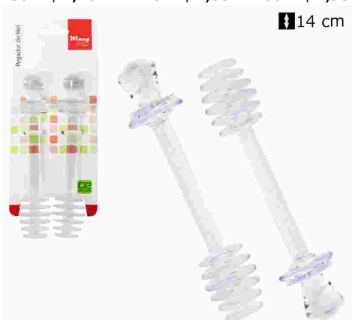

PEGADOR MEL ACRILICO 14CM 2X1 CTL 3170
Código: Fábrica: Unidade:
44725 WINCY CJ/2
F1 F4

UN: R\$ 1,02 AV: R\$ 4,10 15: R\$ 4,18
30: R\$ 4,27 45: R\$ 4,35 60: R\$ 4,44



PEGADOR MEL MADEIRA 15CM 6027 4X1
Código: Fábrica: Unidade:
44726 WINCY CJ/4
F1 F4

UN: R\$ 3,36 AV: R\$ 3,36 15: R\$ 3,43
30: R\$ 3,50 45: R\$ 3,57 60: R\$ 3,64



PEGADOR PLAST MACARRAO COLOR 5024
Código: Fábrica: Unidade:
31281 SBRISSA UN/1
F1 F4

UN: R\$ 14,37 AV: R\$ 14,37 15: R\$ 14,67
30: R\$ 14,96 45: R\$ 15,26 60: R\$ 15,57



PENEIRA ACO INOX 14CM 003
Código: Fábrica: Unidade:
41353 HAUSKRAFT UN/1
F1 F4

UN: R\$ 9,23 AV: R\$ 9,23 15: R\$ 9,43
30: R\$ 9,62 45: R\$ 9,81 60: R\$ 10,00



PENEIRA ACO INOX 16 CM DUPLA CAMADA 345
Código: Fábrica: Unidade:
44507 PLANETA UN/1
F1 F4

UN: R\$ 11,29 AV: R\$ 11,29 15: R\$ 11,52
30: R\$ 11,75 45: R\$ 11,99 60: R\$ 12,23



PENEIRA ACO INOX 18 CM DUPLA CAMADA 346
Código: Fábrica: Unidade:
44506 PLANETA UN/1
F1 F4

UN: R\$ 2,70 AV: R\$ 2,70 15: R\$ 2,75
30: R\$ 2,81 45: R\$ 2,87 60: R\$ 2,92



PENEIRA PLAST C/CABO 07 CM 661
Código: Fábrica: Unidade:
35494 TRITEC UN/1
F1 F4

UN: R\$ 3,07 AV: R\$ 3,07 15: R\$ 3,14
30: R\$ 3,20 45: R\$ 3,26 60: R\$ 3,33



PENEIRA PLAST C/CABO 10 CM 660
Código: Fábrica: Unidade:
35495 TRITEC UN/1
F1 F4

UN: R\$ 9,06 AV: R\$ 54,38 15: R\$ 55,51
30: R\$ 56,62 45: R\$ 57,76 60: R\$ 58,91



PENEIRA PLAST C/CABO 18 CM 3182 6X1
Código: Fábrica: Unidade:
37691 MAMITA PT/6
F1 F4

UN: R\$ 10,73 AV: R\$ 10,73 15: R\$ 10,96
30: R\$ 11,17 45: R\$ 11,40 60: R\$ 11,63



PENEIRA PLAST C/CABO 28 CM 659
Código: Fábrica: Unidade:
35496 TRITEC UN/1
F1 F4

UN: R\$ 66,11 AV: R\$ 66,11 15: R\$ 67,49
30: R\$ 68,84 45: R\$ 70,22 60: R\$ 71,62



PENEIRA PLAST C/FUNIL COLOR 3024 6X1
Código: Fábrica: Unidade:
41894 SBRISSA PT/1
F1 F4

UN: R\$ 4,26 AV: R\$ 4,26 15: R\$ 4,35
30: R\$ 4,44 45: R\$ 4,53 60: R\$ 4,62



PENEIRA PLAST DE NYLON 8 CM 677
Código: Fábrica: Unidade:
48664 PLANETA UN/1
F1 F4

UN: R\$ 3,93 AV: R\$ 47,11 15: R\$ 48,09
30: R\$ 49,05 45: R\$ 50,04 60: R\$ 51,04



PENEIRA PLASTICA 16 CM 3011 12X1
Código: Fábrica: Unidade:
11022 SBRISSA PT/12
F1 F4

UN: R\$ 5,59 AV: R\$ 67,14 15: R\$ 68,54
30: R\$ 69,91 45: R\$ 71,31 60: R\$ 72,73



PENEIRA PLASTICA 20 CM 3012 12X1
Código: Fábrica: Unidade:
2940 SBRISSA PT/12
F1 F4

UN: R\$ 8,21 AV: R\$ 8,21 15: R\$ 8,38
30: R\$ 8,55 45: R\$ 8,72 60: R\$ 8,89



PERLITA EXPANDIDA 1 LITRO
Código: Fábrica: Unidade:
48530 NOVATROPICAL PT/1
F1 F4

UN: R\$ 7,06 AV: R\$ 70,62 15: R\$ 72,09
30: R\$ 73,53 45: R\$ 75,00 60: R\$ 76,50



PESO UNIV PANELA PRESS CROMADO 3002 10X1
Código: Fábrica: Unidade:
19368 PINOLAR PT/10
F1 F4

UN: R\$ 4,73 AV: R\$ 47,25 15: R\$ 48,24
30: R\$ 49,20 45: R\$ 50,18 60: R\$ 51,19



PESO UNIV PANELA PRESS ENCAPAD 4001 10X1
Código: Fábrika: Unidade:
40032 PINOLAR PT/10
F1 F4

UN: R\$ 5,68 AV: R\$ 28,40 15: R\$ 28,99
30: R\$ 29,57 45: R\$ 30,17 60: R\$ 30,77



PESO UNIV PANELA PRESS ENCAPAD 4001 5X1
Código: Fábrika: Unidade:
34633 PINOLAR PT/5
F1 F4

UN: R\$ 14,88 AV: R\$ 14,88 15: R\$ 15,19
30: R\$ 15,50 45: R\$ 15,81 60: R\$ 16,12



PILAO ALUM INTEIRICO ALHO GDE 2032 UN
Código: Fábrika: Unidade:
46852 COFAX UN/1
F1 F4

UN: R\$ 10,73 AV: R\$ 10,73 15: R\$ 10,96
30: R\$ 11,18 45: R\$ 11,40 60: R\$ 11,63



PILAO ALUM INTEIRICO ALHO PEQ 2012 UN
Código: Fábrika: Unidade:
48076 COFAX UN/1
F1 F4

UN: R\$ 10,26 AV: R\$ 10,26 15: R\$ 10,48
30: R\$ 10,69 45: R\$ 10,90 60: R\$ 11,12



PILAO MAD 08 CM C/SOCADOR 101
Código: Fábrika: Unidade:
41324 MAD LAR UN/1
F1 F4

UN: R\$ 8,42 AV: R\$ 8,42 15: R\$ 8,60
30: R\$ 8,77 45: R\$ 8,95 60: R\$ 9,12



PILAO PLASTICO 8,5X17CM 1059/1070
Código: Fábrika: Unidade:
20927 ENGIPLAST UN/1
F1 F4

UN: R\$ 15,08 AV: R\$ 15,08 15: R\$ 15,39
30: R\$ 15,70 45: R\$ 16,02 60: R\$ 16,34



PINCEL COZINHA COLOR SILICONE 24CM 16058
Código: Fábrika: Unidade:
26125 ALIANCA UN/1
F1 F4

UN: R\$ 48,27 AV: R\$ 48,27 15: R\$ 49,27
30: R\$ 50,26 45: R\$ 51,26 60: R\$ 52,29



PIPOQUEIRA ALUM 20 709
Código: Fábrika: Unidade:
22731 MSR UN/1
F1 F4

UN: R\$ 5,25 AV: R\$ 5,25 15: R\$ 5,36
30: R\$ 5,48 45: R\$ 5,59 60: R\$ 5,70



PLAFON PLAST C/SOQUETE PORCELANA BCO E27
Código: Fábrika: Unidade:
48603 REBOUCAS UN/1
F1 F4

UN: R\$ 7,26 AV: R\$ 7,26 15: R\$ 7,41
30: R\$ 7,56 45: R\$ 7,71 60: R\$ 7,87



PLAINA INOX 25CM P/QUEIJOS 065
Código: Fábrika: Unidade:
47332 NIX UN/1
F1 F4

UN: R\$ 8,21 AV: R\$ 8,21 15: R\$ 8,38
30: R\$ 8,55 45: R\$ 8,72 60: R\$ 8,89



PO DE CARVAO VEGETAL 1 LITRO
Código: Fábrika: Unidade:
48528 NOVATROPICAL PT/1
F1 F4

UN: R\$ 8,21 AV: R\$ 8,21 15: R\$ 8,38
30: R\$ 8,55 45: R\$ 8,72 60: R\$ 8,89



PO DE COCO 1 LITRO
Código: Fábrika: Unidade:
48532 NOVATROPICAL PT/1
F1 F4

UN: R\$ 8,21 AV: R\$ 8,21 15: R\$ 8,38
30: R\$ 8,55 45: R\$ 8,72 60: R\$ 8,89



PO DE PINUS 1 LITRO
Código: Fábrika: Unidade:
48531 NOVATROPICAL PT/1
F1 F4

UN: R\$ 53,41 AV: R\$ 53,41 15: R\$ 54,53
30: R\$ 55,62 45: R\$ 56,73 60: R\$ 57,86
154 cm



POLVILHADEIRA MATA FORMIGA CAP 1KG
Código: Fábrika: Unidade:
38650 GUARANY UN/1
F1 F4

UN: R\$ 5,13 AV: R\$ 5,13 15: R\$ 5,23
30: R\$ 5,34 45: R\$ 5,44 60: R\$ 5,55



PORTA CHA MDF 10X10CM 470
Código: Fábrika: Unidade:
45985 R A ARTESANA UN/1
F1 F4

UN: R\$ 30,81 AV: R\$ 30,81 15: R\$ 31,45
30: R\$ 32,08 45: R\$ 32,72 60: R\$ 33,37

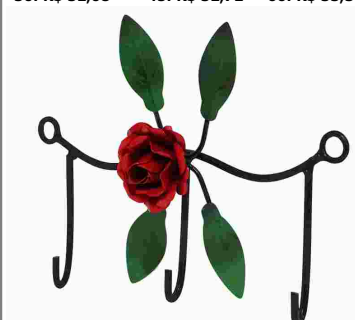

PORTA CHAVE DE FERRO 5062
Código: Fábrika: Unidade:
42171 PAIOL UN/1
F1 F4

UN: R\$ 3,22 AV: R\$ 3,22 15: R\$ 3,28
30: R\$ 3,35 45: R\$ 3,42 60: R\$ 3,48



PORTA COND PLAST COLORAU 499

Código: 46644 Fábrica: QUALYPLAS Unidade: UN/1
F1 F4

UN: R\$ 3,22 AV: R\$ 3,22 15: R\$ 3,28
30: R\$ 3,35 45: R\$ 3,42 60: R\$ 3,48



PORTA COND PLAST OREGANO 416

Código: 46645 Fábrica: QUALYPLAS Unidade: UN/1
F1 F4

UN: R\$ 3,22 AV: R\$ 3,22 15: R\$ 3,28
30: R\$ 3,35 45: R\$ 3,42 60: R\$ 3,48



PORTA COND PLAST PIMENTA DO REINO 418

Código: 46648 Fábrica: QUALYPLAS Unidade: UN/1
F1 F4

UN: R\$ 3,22 AV: R\$ 3,22 15: R\$ 3,28
30: R\$ 3,35 45: R\$ 3,42 60: R\$ 3,48



PORTA COND PLAST PIMENTA 417

Código: 46647 Fábrica: QUALYPLAS Unidade: UN/1
F1 F4

UN: R\$ 3,22 AV: R\$ 3,22 15: R\$ 3,28
30: R\$ 3,35 45: R\$ 3,42 60: R\$ 3,48



PORTA COND PLAST SAL419

Código: 46646 Fábrica: QUALYPLAS Unidade: UN/1
F1 F4

UN: R\$ 12,63 AV: R\$ 12,63 15: R\$ 12,89
30: R\$ 13,15 45: R\$ 13,41 60: R\$ 13,68



PORTA CONDIMENTO VIDRO 100ML 008 2X1

Código: 49375 Fábrica: RIOHOME Unidade: UN/1
F1 F4

UN: R\$ 20,53 AV: R\$ 20,53 15: R\$ 20,96
30: R\$ 21,38 45: R\$ 21,81 60: R\$ 22,24



PORTA COPOS MDF PEQ FLAMENGO 10688 6X1

Código: 41151 Fábrica: BRASFOOT Unidade: UN/1
F1 F4

UN: R\$ 8,21 AV: R\$ 8,21 15: R\$ 8,38
30: R\$ 8,55 45: R\$ 8,72 60: R\$ 8,89



PORTA COTONETE/ALGODAO PLAST 10CM 2638

Código: 41554 Fábrica: PLASUTIL Unidade: UN/1
F1 F4

UN: R\$ 17,80 AV: R\$ 17,80 15: R\$ 18,17
30: R\$ 18,54 45: R\$ 18,91 60: R\$ 19,28



PORTA DETERGENTE BUCHA 550 ML DISPEN 976

Código: 46671 Fábrica: LUMAR Unidade: UN/1
F1 F4

UN: R\$ 23,62 AV: R\$ 23,62 15: R\$ 24,11
30: R\$ 24,59 45: R\$ 25,08 60: R\$ 25,58



PORTA DETERGENTE E BUCHA RATTAN BCO 1970

Código: 37292 Fábrica: MONTE LIBANO Unidade: UN/1
F1 F4

UN: R\$ 22,03 AV: R\$ 22,03 15: R\$ 22,49
30: R\$ 22,94 45: R\$ 23,40 60: R\$ 23,87



PORTA DETERGENTE E BUCHA RATTAN BCO 920

Código: 38399 Fábrica: MONTE LIBANO Unidade: UN/1
F1 F4

UN: R\$ 23,62 AV: R\$ 23,62 15: R\$ 24,11
30: R\$ 24,59 45: R\$ 25,08 60: R\$ 25,58



PORTA DETERGENTE E BUCHA RATTAN PTO 1971

Código: 37291 Fábrica: MONTE LIBANO Unidade: UN/1
F1 F4

UN: R\$ 22,03 AV: R\$ 22,03 15: R\$ 22,49
30: R\$ 22,94 45: R\$ 23,40 60: R\$ 23,87



PORTA DETERGENTE E BUCHA RATTAN PTO 921

Código: 38400 Fábrica: MONTE LIBANO Unidade: UN/1
F1 F4

UN: R\$ 22,03 AV: R\$ 22,03 15: R\$ 22,49
30: R\$ 22,94 45: R\$ 23,40 60: R\$ 23,87



PORTA DETERGENTE E BUCHA RATTAN TEND 923

Código: 38401 Fábrica: MONTE LIBANO Unidade: UN/1
F1 F4

UN: R\$ 3,60 AV: R\$ 3,60 15: R\$ 3,67
30: R\$ 3,74 45: R\$ 3,82 60: R\$ 3,89



PORTA DETERGENTE SABAO ESPONJA 5028

Código: 10403 Fábrica: SBRISSA Unidade: UN/1
F1 F4

UN: R\$ 3,05 AV: R\$ 3,05 15: R\$ 3,11
30: R\$ 3,18 45: R\$ 3,24 60: R\$ 3,31



PORTA DETERGENTE SABAO PLAST 180CM 84

Código: 44087 Fábrica: QUALYPLAS Unidade: UN/1
F1 F4

UN: R\$ 8,91 AV: R\$ 8,91 15: R\$ 9,09
30: R\$ 9,27 45: R\$ 9,46 60: R\$ 9,65



PORTA ESCOVA DENTES PLAST 1616

Código: Fábrica: Unidade:
47065 JAGUAR UN/1
F1 F4

UN: R\$ 3,05 AV: R\$ 3,05 15: R\$ 3,11
30: R\$ 3,18 45: R\$ 3,24 60: R\$ 3,31



PORTA ESCOVA PLAST 20CM COLOR 669

Código: Fábrica: Unidade:
44086 QUALYPLAS UN/1
F1 F4

UN: R\$ 18,95 AV: R\$ 18,95 15: R\$ 19,35
30: R\$ 19,73 45: R\$ 20,13 60: R\$ 20,53



PORTA ESCOVAS DENTE C/TAMPA 980

Código: Fábrica: Unidade:
46672 LUMAR UN/1
F1 F4

UN: R\$ 5,95 AV: R\$ 5,95 15: R\$ 6,07
30: R\$ 6,19 45: R\$ 6,32 60: R\$ 6,44



PORTA FILTRO PLAST UN 5025

Código: Fábrica: Unidade:
31282 SBRISSA UN/1
F1 F4

UN: R\$ 26,35 AV: R\$ 26,35 15: R\$ 26,90
30: R\$ 27,44 45: R\$ 27,99 60: R\$ 28,55

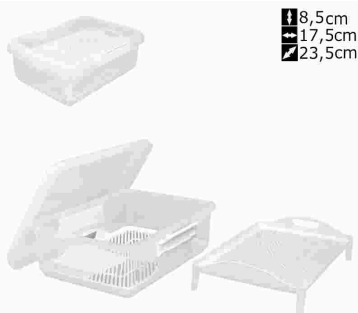

PORTA FRIO PLAST 2 LTS C/TRAV TRANSL 393

Código: Fábrica: Unidade:
44437 USUAL UN/1
F1 F4

UN: R\$ 25,92 AV: R\$ 25,92 15: R\$ 26,46
30: R\$ 26,99 45: R\$ 27,53 60: R\$ 28,08



PORTA GUARDANAPO INOX 13X5,5X9CM 180225

Código: Fábrica: Unidade:
39222 SATYAM UN/1
F1 F4

UN: R\$ 12,53 AV: R\$ 12,53 15: R\$ 12,79
30: R\$ 13,05 45: R\$ 13,31 60: R\$ 13,58



PORTA GUARDANAPO INOX 15X3X6,5CM 110060

Código: Fábrica: Unidade:
39221 SATYAM UN/1
F1 F4

UN: R\$ 5,49 AV: R\$ 5,49 15: R\$ 5,60
30: R\$ 5,72 45: R\$ 5,83 60: R\$ 5,95



PORTA LEITE PLAST SQUIN 16,5X7,5X16,5CM

Código: Fábrica: Unidade:
20013 DELTA UTIL UN/1
F1 F4

UN: R\$ 3,76 AV: R\$ 3,76 15: R\$ 3,84
30: R\$ 3,91 45: R\$ 3,99 60: R\$ 4,07



PORTA SABAO 335

Código: Fábrica: Unidade:
28886 JOREAL UN/1
F1 F4

UN: R\$ 4,82 AV: R\$ 4,82 15: R\$ 4,92
30: R\$ 5,02 45: R\$ 5,12 60: R\$ 5,22



PORTA SABAO/DET/BUCHA PLAST 6611

Código: Fábrica: Unidade:
41671 INPLAST UN/1
F1 F4

UN: R\$ 13,22 AV: R\$ 13,22 15: R\$ 13,50
30: R\$ 13,77 45: R\$ 14,04 60: R\$ 14,32



PORTA SABONETE LIQ PLAST 500 ML 981

Código: Fábrica: Unidade:
46670 LUMAR UN/1
F1 F4

UN: R\$ 11,77 AV: R\$ 11,77 15: R\$ 12,01
30: R\$ 12,25 45: R\$ 12,50 60: R\$ 12,75



PORTA SABONETE LIQUIDO PLAST 250ML 2636

Código: Fábrica: Unidade:
41556 PLASUTIL UN/1
F1 F4

UN: R\$ 11,50 AV: R\$ 11,50 15: R\$ 11,74
30: R\$ 11,98 45: R\$ 12,22 60: R\$ 12,46



PORTA SACHES INOX 10X4,5X6,5CM 180224

Código: Fábrica: Unidade:
39220 SATYAM UN/1
F1 F4

UN: R\$ 38,00 AV: R\$ 38,00 15: R\$ 38,79
30: R\$ 39,56 45: R\$ 40,35 60: R\$ 41,16



PORTA TALHER CROM 561

Código: Fábrica: Unidade:
20176 ARAMINAS UN/1
F1 F4

UN: R\$ 36,16 AV: R\$ 36,16 15: R\$ 36,91
30: R\$ 37,65 45: R\$ 38,40 60: R\$ 39,17

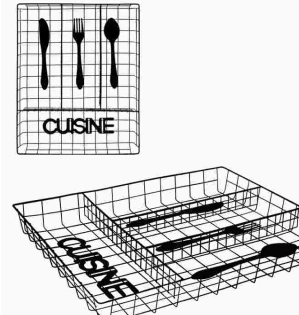

PORTA TALHER INOX ARAMADO 32X26X3,5CM

Código: Fábrica: Unidade:
38529 WINCY UN/1
F1 F4

UN: R\$ 5,43 AV: R\$ 5,43 15: R\$ 5,55
30: R\$ 5,66 45: R\$ 5,77 60: R\$ 5,89



PORTA TALHER PLAST COLOR 6699

Código: Fábrica: Unidade:
41672 INPLAST UN/1
F1 F4

UN: R\$ 38,48 AV: R\$ 38,48 15: R\$ 39,28
30: R\$ 40,06 45: R\$ 40,86 60: R\$ 41,68



PORTA TALHER PLASTICO C/TAMPA 517

Código: Fábrica: Unidade:
35484 TRITEC UN/1
F1 F4

UN: R\$ 50,32 AV: R\$ 50,32 15: R\$ 51,37
30: R\$ 52,40 45: R\$ 53,45 60: R\$ 54,52

11 cm
35 cm



PORTA VINHO DEITADO ENVELHEC 3424-1

Código: Fábrica: Unidade:
37189 PAIOL UN/1
F1 F4

UN: R\$ 50,32 AV: R\$ 50,32 15: R\$ 51,37
30: R\$ 52,40 45: R\$ 53,45 60: R\$ 54,52

22cm
37 cm

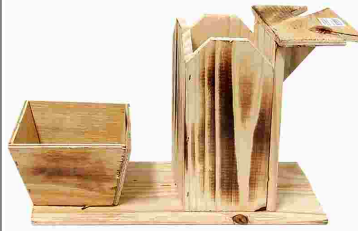

PORTA VINHO E TACAS VIOLETA 4546

Código: Fábrica: Unidade:
37188 PAIOL UN/1
F1 F4

UN: R\$ 28,85 AV: R\$ 28,85 15: R\$ 29,45
30: R\$ 30,04 45: R\$ 30,64 60: R\$ 31,25



POTE CAFE ACUCAR PORTA FILT/ADAPTAD 8001

Código: Fábrica: Unidade:
34564 SBRISSA CJ/1
F1 F4

UN: R\$ 21,78 AV: R\$ 21,78 15: R\$ 22,24
30: R\$ 22,68 45: R\$ 23,13 60: R\$ 23,60



POTE CAFE ACUCAR PREMIUM 8005

Código: Fábrica: Unidade:
34565 SBRISSA CJ/1
F1 F4

UN: R\$ 29,78 AV: R\$ 29,78 15: R\$ 30,40
30: R\$ 31,01 45: R\$ 31,63 60: R\$ 32,26



POTE HERMETICO 4,5LTS RET C/TRAVA 952

Código: Fábrica: Unidade:
48669 LIG BRIN UN/1
F1 F4

UN: R\$ 25,67 AV: R\$ 25,67 15: R\$ 26,20
30: R\$ 26,73 45: R\$ 27,26 60: R\$ 27,81



POTE MANTIMENTO ALUM LEVE 14

Código: Fábrica: Unidade:
11260 AVELAR UN/1
F1 F4

UN: R\$ 10,59 AV: R\$ 10,59 15: R\$ 10,81
30: R\$ 11,03 45: R\$ 11,25 60: R\$ 11,47



POTE PLAST C/TAMPA MULTIUSO G COLOR

Código: Fábrica: Unidade:
41209 PLASTSU UN/1
F1 F4

UN: R\$ 17,66 AV: R\$ 17,66 15: R\$ 18,03
30: R\$ 18,39 45: R\$ 18,76 60: R\$ 19,13



POTE PLAST C/TRAVA GG COLOR 2,5LT 331030

Código: Fábrica: Unidade:
41207 PLASTSU UN/1
F1 F4

UN: R\$ 0,14 AV: R\$ 7,18 15: R\$ 7,33
30: R\$ 7,48 45: R\$ 7,63 60: R\$ 7,78



POTE PLAST DESC 250 ML 50X1

Código: Fábrica: Unidade:
47739 COPOZAN PT/50
F1 F4

UN: R\$ 13,35 AV: R\$ 13,35 15: R\$ 13,63
30: R\$ 13,90 45: R\$ 14,18 60: R\$ 14,46



POTE PLAST HERM 2,2 LTS ALTO TRANSP 183T

Código: Fábrica: Unidade:
34068 GIOTTO UN/1
F1 F4

UN: R\$ 6,48 AV: R\$ 6,48 15: R\$ 6,61
30: R\$ 6,75 45: R\$ 6,88 60: R\$ 7,02



POTE PLAST MANT 2,5LTS QUAD ACUCAR 244

Código: Fábrica: Unidade:
40367 FORMPLAST UN/1
F1 F4

UN: R\$ 6,48 AV: R\$ 6,48 15: R\$ 6,61
30: R\$ 6,75 45: R\$ 6,88 60: R\$ 7,02



POTE PLAST MANT 2,5LTS QUAD ARROZ 241

Código: Fábrica: Unidade:
40370 FORMPLAST UN/1
F1 F4

UN: R\$ 6,48 AV: R\$ 6,48 15: R\$ 6,61
30: R\$ 6,75 45: R\$ 6,88 60: R\$ 7,02



POTE PLAST MANT 2,5LTS QUAD CAFE 245

Código: Fábrica: Unidade:
40368 FORMPLAST UN/1
F1 F4

UN: R\$ 6,48 AV: R\$ 6,48 15: R\$ 6,61
30: R\$ 6,75 45: R\$ 6,88 60: R\$ 7,02



POTE PLAST MANT 2,5LTS QUAD FARINHA 243

Código: Fábrica: Unidade:
40366 FORMPLAST UN/1
F1 F4

UN: R\$ 6,48 AV: R\$ 6,48 15: R\$ 6,61
30: R\$ 6,75 45: R\$ 6,88 60: R\$ 7,02



POTE PLAST MANT 2,5LTS QUAD FEIJAO 242

Código: Fábrica: Unidade:
40365 FORMPLAST UN/1
F1 F4

UN: R\$ 12,08 AV: R\$ 12,08 15: R\$ 12,33
30: R\$ 12,58 45: R\$ 12,83 60: R\$ 13,09



POTE PLAST RED 5LTS PREMIUM FACILITT 155
Código: 45190 Fábrica: RISCHIOTO Unidade: UN/1
F1 F4

UN: R\$ 14,58 AV: R\$ 14,58 15: R\$ 14,89
30: R\$ 15,19 45: R\$ 15,49 60: R\$ 15,80



POTE PLAST RET ALTO 4,2LTS 342
Código: 45196 Fábrica: RISCHIOTO Unidade: UN/1
F1 F4

UN: R\$ 7,90 AV: R\$ 7,90 15: R\$ 8,06
30: R\$ 8,23 45: R\$ 8,39 60: R\$ 8,56

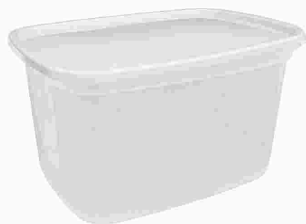

POTE PLAST RET FACILITTA ALTO 2,5LTS 341
Código: 45191 Fábrica: RISCHIOTO Unidade: UN/1
F1 F4

UN: R\$ 19,08 AV: R\$ 19,08 15: R\$ 19,47
30: R\$ 19,86 45: R\$ 20,26 60: R\$ 20,66

28cm
10cm
19cm



POTE PLAST RET 2,75L C/TRAVA 3312
Código: 47055 Fábrica: JAGUAR Unidade: UN/1
F1 F4

UN: R\$ 14,15 AV: R\$ 14,15 15: R\$ 14,45
30: R\$ 14,74 45: R\$ 15,03 60: R\$ 15,33

30cm
10cm
20cm



POTE PLAST RET 3,6LTS 1666
Código: 6195 Fábrica: JAGUAR Unidade: UN/1
F1 F4

UN: R\$ 23,32 AV: R\$ 23,32 15: R\$ 23,80
30: R\$ 24,28 45: R\$ 24,76 60: R\$ 25,26

28cm
17cm
19cm



POTE PLAST RET 5LTS C/TRAVA 3313
Código: 47057 Fábrica: JAGUAR Unidade: UN/1
F1 F4

UN: R\$ 7,12 AV: R\$ 7,12 15: R\$ 7,27
30: R\$ 7,41 45: R\$ 7,56 60: R\$ 7,71

17cm
8cm
19cm



POTE PLAST RET 850 ML C/TRAVA 3306
Código: 47044 Fábrica: JAGUAR Unidade: UN/1
F1 F4

UN: R\$ 8,82 AV: R\$ 8,82 15: R\$ 9,01
30: R\$ 9,19 45: R\$ 9,37 60: R\$ 9,56



POTE PLAST SUPERCLICK 800ML 1545 UN
Código: 45442 Fábrica: TRITEC Unidade: UN/1
F1 F4

UN: R\$ 7,81 AV: R\$ 7,81 15: R\$ 7,97
30: R\$ 8,13 45: R\$ 8,29 60: R\$ 8,46

6,5 cm
22 cm
1250ml



POTE PLAST 1250 ML RET CLICK G 75832
Código: 40396 Fábrica: UN-ART Unidade: UN/1
F1 F4

UN: R\$ 6,48 AV: R\$ 6,48 15: R\$ 6,61
30: R\$ 6,75 45: R\$ 6,88 60: R\$ 7,02

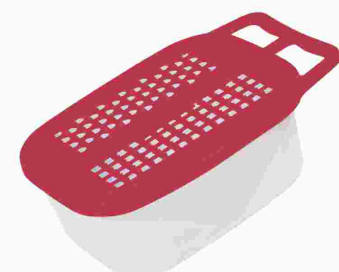

POTE PLAST 1,4 LTS C/RALADOR COLOR 4035
Código: 40376 Fábrica: FORMPLAST Unidade: UN/1
F1 F4

UN: R\$ 8,21 AV: R\$ 8,21 15: R\$ 8,38
30: R\$ 8,55 45: R\$ 8,72 60: R\$ 8,89



POTE PLAST 1,5 LTS COLOR 819
Código: 45843 Fábrica: LUMAR Unidade: UN/1
F1 F4

UN: R\$ 6,48 AV: R\$ 6,48 15: R\$ 6,61
30: R\$ 6,75 45: R\$ 6,88 60: R\$ 7,02



POTE PLAST 1,7 LTS DUPLO COLOR 14
Código: 40372 Fábrica: FORMPLAST Unidade: UN/1
F1 F4

UN: R\$ 10,01 AV: R\$ 10,01 15: R\$ 10,22
30: R\$ 10,43 45: R\$ 10,64 60: R\$ 10,85



POTE PLAST 2 LTS ALTO FRUTAS 002
Código: 36530 Fábrica: MAXIMAPLASTI Unidade: UN/1
F1 F4

UN: R\$ 12,51 AV: R\$ 12,51 15: R\$ 12,77
30: R\$ 13,03 45: R\$ 13,29 60: R\$ 13,55



POTE PLAST 2,5 LT RED P/ ALIMENT 4009
Código: 13912 Fábrica: SBRISSA Unidade: UN/1
F1 F4

UN: R\$ 13,89 AV: R\$ 13,89 15: R\$ 14,18
30: R\$ 14,46 45: R\$ 14,75 60: R\$ 15,05



POTE PLAST 2,5 LT RED P/ALIMENT DEC 8015
Código: 35220 Fábrica: SBRISSA Unidade: UN/1
F1 F4

UN: R\$ 15,31 AV: R\$ 15,31 15: R\$ 15,63
30: R\$ 15,95 45: R\$ 16,27 60: R\$ 16,59



POTE PLAST 3 LTS ALTO FRUTAS 003
Código: 36529 Fábrica: MAXIMAPLASTI Unidade: UN/1
F1 F4

<p>UN: R\$ 5,75 AV: R\$ 5,75 15: R\$ 5,87 30: R\$ 5,99 45: R\$ 6,11 60: R\$ 6,23</p> <p>4,5 cm 15,5 cm 380 ml</p>  <p>POTE PLAST 380 ML RET CLICK P 75820</p> <p>Código: Fábrica: Unidade: 40394 UN-ART UN/1 F1 F4</p>	<p>UN: R\$ 16,02 AV: R\$ 16,02 15: R\$ 16,36 30: R\$ 16,69 45: R\$ 17,02 60: R\$ 17,36</p>  <p>POTE PLAST 4,5LTS C/ROSCA SPINLOCK 7704</p> <p>Código: Fábrica: Unidade: 50230 RISCHIOTO UN/1 F1 F4</p>	<p>UN: R\$ 23,56 AV: R\$ 23,56 15: R\$ 24,05 30: R\$ 24,53 45: R\$ 25,02 60: R\$ 25,52</p>  <p>POTE PLAST 5 LTS ALTO FRUTAS 004</p> <p>Código: Fábrica: Unidade: 36528 MAXIMAPLASTI UN/1 F1 F4</p>	<p>UN: R\$ 6,99 AV: R\$ 6,99 15: R\$ 7,13 30: R\$ 7,27 45: R\$ 7,42 60: R\$ 7,57</p> <p>5,5 cm 18,5 cm 740 ml</p>  <p>POTE PLAST 740 ML RET CLICK M 75826</p> <p>Código: Fábrica: Unidade: 40395 UN-ART UN/1 F1 F4</p>
<p>UN: R\$ 5,09 AV: R\$ 5,09 15: R\$ 5,20 30: R\$ 5,30 45: R\$ 5,41 60: R\$ 5,51</p>  <p>POTE PLAST 800ML QUAD TRANSP TP AZUL PER</p> <p>Código: Fábrica: Unidade: 40134 KOZI PLAST UN/1 F1 F4</p>	<p>UN: R\$ 5,09 AV: R\$ 5,09 15: R\$ 5,20 30: R\$ 5,30 45: R\$ 5,41 60: R\$ 5,51</p>  <p>POTE PLAST 800ML QUAD TRANSP TP BRANCA</p> <p>Código: Fábrica: Unidade: 40133 KOZI PLAST UN/1 F1 F4</p>	<p>UN: R\$ 5,09 AV: R\$ 5,09 15: R\$ 5,20 30: R\$ 5,30 45: R\$ 5,41 60: R\$ 5,51</p>  <p>POTE PLAST 800ML RED TRANSP TP AZUL PER</p> <p>Código: Fábrica: Unidade: 40139 KOZI PLAST UN/1 F1 F4</p>	<p>UN: R\$ 5,09 AV: R\$ 5,09 15: R\$ 5,20 30: R\$ 5,30 45: R\$ 5,41 60: R\$ 5,51</p>  <p>POTE PLAST 800ML RED TRANSP TP AZUL ROY</p> <p>Código: Fábrica: Unidade: 40140 KOZI PLAST UN/1 F1 F4</p>
<p>UN: R\$ 5,09 AV: R\$ 5,09 15: R\$ 5,20 30: R\$ 5,30 45: R\$ 5,41 60: R\$ 5,51</p>  <p>POTE PLAST 800ML RED TRANSP TP BRANCA</p> <p>Código: Fábrica: Unidade: 40138 KOZI PLAST UN/1 F1 F4</p>	<p>UN: R\$ 5,09 AV: R\$ 5,09 15: R\$ 5,20 30: R\$ 5,30 45: R\$ 5,41 60: R\$ 5,51</p>  <p>POTE PLAST 800ML RED TRANSP TP ROSA PER</p> <p>Código: Fábrica: Unidade: 40141 KOZI PLAST UN/1 F1 F4</p>	<p>UN: R\$ 9,19 AV: R\$ 9,19 15: R\$ 9,39 30: R\$ 9,57 45: R\$ 9,76 60: R\$ 9,96</p>  <p>POTE VIDRO 1 LT C/TPA PLAST 22011</p> <p>Código: Fábrica: Unidade: 46889 SATYAM UN/1 F1 F4</p>	<p>UN: R\$ 12,33 AV: R\$ 12,33 15: R\$ 12,58 30: R\$ 12,83 45: R\$ 13,09 60: R\$ 13,35</p>  <p>POTE VIDRO 1,0 L C/TPA PLAST 0017</p> <p>Código: Fábrica: Unidade: 35096 SATYAM UN/1 F1 F4</p>
<p>UN: R\$ 15,41 AV: R\$ 15,41 15: R\$ 15,73 30: R\$ 16,04 45: R\$ 16,36 60: R\$ 16,69</p>  <p>POTE VIDRO 1,0 L C/TPA PLAST 0022</p> <p>Código: Fábrica: Unidade: 35097 SATYAM UN/1 F1 F4</p>	<p>UN: R\$ 11,29 AV: R\$ 11,29 15: R\$ 11,52 30: R\$ 11,75 45: R\$ 11,99 60: R\$ 12,23</p>  <p>POTE VIDRO 1,0 L C/TPA PLAST 9426</p> <p>Código: Fábrica: Unidade: 47316 CASITA UN/1 F1 F4</p>	<p>UN: R\$ 10,79 AV: R\$ 10,79 15: R\$ 11,01 30: R\$ 11,23 45: R\$ 11,46 60: R\$ 11,68</p>  <p>POTE VIDRO 720 ML C/TPA PLAST 0016</p> <p>Código: Fábrica: Unidade: 35098 SATYAM UN/1 F1 F4</p>	<p>UN: R\$ 13,34 AV: R\$ 13,34 15: R\$ 13,62 30: R\$ 13,89 45: R\$ 14,17 60: R\$ 14,46</p>  <p>PRATO ALUM FUNDO 1290</p> <p>Código: Fábrica: Unidade: 37253 MSR/YANG UN/1 F1 F4</p>

UN: R\$ 10,26 AV: R\$ 10,26 15: R\$ 10,48
30: R\$ 10,69 45: R\$ 10,90 60: R\$ 11,12



PRATO ALUM LEVE ESCOLAR

Código: Fábrica: Unidade:
27596 AVELAR UN/1
F1 F4

UN: R\$ 23,97 AV: R\$ 287,61 15: R\$ 293,60
30: R\$ 299,47 45: R\$ 305,46 60: R\$ 311,57



PRATO CERAMICA BCO RASO LISO 10.5 12X1

Código: Fábrica: Unidade:
41460 MABEL CX/12
F1 F4

UN: R\$ 4,10 AV: R\$ 4,10 15: R\$ 4,18
30: R\$ 4,27 45: R\$ 4,35 60: R\$ 4,44



PRATO DESCARTAVEL FUNDO N20 10UN

Código: Fábrica: Unidade:
48319 COPOPLAST PT/1
F1 F4

UN: R\$ 3,45 AV: R\$ 3,45 15: R\$ 3,52
30: R\$ 3,59 45: R\$ 3,67 60: R\$ 3,74



PRATO INF FUNDO DECORADO 1648

Código: Fábrica: Unidade:
7964 PLASUTIL UN/1
F1 F4

UN: R\$ 5,88 AV: R\$ 5,88 15: R\$ 6,00
30: R\$ 6,12 45: R\$ 6,24 60: R\$ 6,37



PRATO MELAMINE FUNDO 20 CM 528P

Código: Fábrica: Unidade:
10059 IDEA UN/1
F1 F4

UN: R\$ 0,92 AV: R\$ 0,92 15: R\$ 0,94
30: R\$ 0,96 45: R\$ 0,98 60: R\$ 1,00

11 2,5 cm
12 09 cm



PRATO PL 09 PRETO 9X25CM 222

Código: Fábrica: Unidade:
37709 BIG PLAST UN/1
F1 F4

UN: R\$ 1,74 AV: R\$ 1,74 15: R\$ 1,77
30: R\$ 1,81 45: R\$ 1,84 60: R\$ 1,88

11 2,5 cm
12 13 cm



PRATO PL 1 RED PRETO

Código: Fábrica: Unidade:
18462 NUTRIPLAN UN/1
F1 F4

UN: R\$ 1,11 AV: R\$ 1,11 15: R\$ 1,13
30: R\$ 1,16 45: R\$ 1,18 60: R\$ 1,20

11 2,5 cm
12 11 cm



PRATO PL 11 PRETO 11X2,5CM 224

Código: Fábrica: Unidade:
37708 BIG PLAST UN/1
F1 F4

UN: R\$ 3,70 AV: R\$ 3,70 15: R\$ 3,78
30: R\$ 3,85 45: R\$ 3,93 60: R\$ 4,01

11 1,5 cm
12 15 cm



PRATO PL 1,2 RED PEQ AMARELO CLARO

Código: Fábrica: Unidade:
34596 NUTRIPLAN UN/1
F1 F4

UN: R\$ 3,70 AV: R\$ 3,70 15: R\$ 3,78
30: R\$ 3,85 45: R\$ 3,93 60: R\$ 4,01

11 1,5 cm
12 15 cm



PRATO PL 1,2 RED PEQ LILAS CLARO

Código: Fábrica: Unidade:
34597 NUTRIPLAN UN/1
F1 F4

UN: R\$ 3,70 AV: R\$ 3,70 15: R\$ 3,78
30: R\$ 3,85 45: R\$ 3,93 60: R\$ 4,01

11 1,5 cm
12 15 cm



PRATO PL 1,2 RED PEQ ROSA BEBE

Código: Fábrica: Unidade:
34599 NUTRIPLAN UN/1
F1 F4

UN: R\$ 4,10 AV: R\$ 4,10 15: R\$ 4,18
30: R\$ 4,27 45: R\$ 4,35 60: R\$ 4,44

11 1,5 cm
12 15 cm



PRATO PL 1,2 RED PEQ VERDE CLARO

Código: Fábrica: Unidade:
34598 NUTRIPLAN UN/1
F1 F4

UN: R\$ 2,52 AV: R\$ 2,52 15: R\$ 2,57
30: R\$ 2,62 45: R\$ 2,67 60: R\$ 2,73

11 2,8 cm
12 17 cm



PRATO PL 1,5 RED PEQ MARROM

Código: Fábrica: Unidade:
22296 NUTRIPLAN UN/1
F1 F4

UN: R\$ 2,56 AV: R\$ 2,56 15: R\$ 2,61
30: R\$ 2,66 45: R\$ 2,72 60: R\$ 2,77

11 2,8 cm
12 17 cm



PRATO PL 1,5 RED PEQ PRETO

Código: Fábrica: Unidade:
18463 NUTRIPLAN UN/1
F1 F4

UN: R\$ 4,41 AV: R\$ 4,41 15: R\$ 4,50
30: R\$ 4,59 45: R\$ 4,68 60: R\$ 4,77

11 3 cm
12 19 cm



PRATO PL 2 RED MARROM

Código: Fábrica: Unidade:
30286 NUTRIPLAN UN/1
F1 F4

UN: R\$ 3,48 AV: R\$ 3,48 15: R\$ 3,55
30: R\$ 3,63 45: R\$ 3,70 60: R\$ 3,77

11 3 cm
12 19 cm



PRATO PL 2 RED PRETO

Código: Fábrica: Unidade:
18464 NUTRIPLAN UN/1
F1 F4

UN: R\$ 5,13 AV: R\$ 5,13 15: R\$ 5,23
 30: R\$ 5,34 45: R\$ 5,44 60: R\$ 5,55



PRATO PL 3 RED MARROM

Código: 30288 Fábrica: NUTRIPLAN Unidade: UN/1 F1 F4

UN: R\$ 4,10 AV: R\$ 4,10 15: R\$ 4,18
 30: R\$ 4,27 45: R\$ 4,35 60: R\$ 4,44



PRATO PL 3 RED PRETO

Código: 18465 Fábrica: NUTRIPLAN Unidade: UN/1 F1 F4

UN: R\$ 6,83 AV: R\$ 6,83 15: R\$ 6,97
 30: R\$ 7,11 45: R\$ 7,25 60: R\$ 7,40



PRATO PL 4 RED MARROM

Código: 18484 Fábrica: NUTRIPLAN Unidade: UN/1 F1 F4

UN: R\$ 5,64 AV: R\$ 5,64 15: R\$ 5,76
 30: R\$ 5,87 45: R\$ 5,99 60: R\$ 6,11



PRATO PL 4 RED PRETO

Código: 18466 Fábrica: NUTRIPLAN Unidade: UN/1 F1 F4

UN: R\$ 6,55 AV: R\$ 6,55 15: R\$ 6,69
 30: R\$ 6,82 45: R\$ 6,96 60: R\$ 7,10



PRATO PL 5 MARROM

Código: 30289 Fábrica: NUTRIPLAN Unidade: UN/1 F1 F4

UN: R\$ 7,18 AV: R\$ 7,18 15: R\$ 7,33
 30: R\$ 7,48 45: R\$ 7,63 60: R\$ 7,78



PRATO PL 5 PRETO

Código: 30290 Fábrica: NUTRIPLAN Unidade: UN/1 F1 F4

UN: R\$ 7,18 AV: R\$ 7,18 15: R\$ 7,33
 30: R\$ 7,48 45: R\$ 7,63 60: R\$ 7,78



PRATO PL 6 RED PRETO

Código: 18467 Fábrica: NUTRIPLAN Unidade: UN/1 F1 F4

UN: R\$ 8,83 AV: R\$ 8,83 15: R\$ 9,02
 30: R\$ 9,20 45: R\$ 9,38 60: R\$ 9,57



PRATO PL 7 MARROM

Código: 18485 Fábrica: NUTRIPLAN Unidade: UN/1 F1 F4

UN: R\$ 9,17 AV: R\$ 9,17 15: R\$ 9,36
 30: R\$ 9,55 45: R\$ 9,74 60: R\$ 9,94



PRATO PL 7 RED PRETO

Código: 18468 Fábrica: NUTRIPLAN Unidade: UN/1 F1 F4

UN: R\$ 12,58 AV: R\$ 12,58 15: R\$ 12,85
 30: R\$ 13,10 45: R\$ 13,36 60: R\$ 13,63



PRATO PL 8 RED PRETO

Código: 18469 Fábrica: NUTRIPLAN Unidade: UN/1 F1 F4

UN: R\$ 15,40 AV: R\$ 15,40 15: R\$ 15,72
 30: R\$ 16,03 45: R\$ 16,35 60: R\$ 16,68



PRATO PL 9 PRETO

Código: 30291 Fábrica: NUTRIPLAN Unidade: UN/1 F1 F4

UN: R\$ 3,60 AV: R\$ 3,60 15: R\$ 3,67
 30: R\$ 3,74 45: R\$ 3,82 60: R\$ 3,89



PRATO PL FLOREIRA 1 MARROM

Código: 18511 Fábrica: NUTRIPLAN Unidade: UN/1 F1 F4

UN: R\$ 2,57 AV: R\$ 2,57 15: R\$ 2,62
 30: R\$ 2,67 45: R\$ 2,73 60: R\$ 2,78



PRATO PL FLOREIRA 1 17CM MARMORE

Código: 22299 Fábrica: NUTRIPLAN Unidade: UN/1 F1 F4

UN: R\$ 4,73 AV: R\$ 4,73 15: R\$ 4,82
 30: R\$ 4,92 45: R\$ 5,02 60: R\$ 5,12

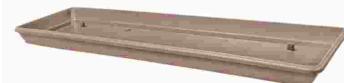

PRATO PL JARDINEIRA 35CM CAPUCCINO

Código: 35206 Fábrica: NUTRIPLAN Unidade: UN/1 F1 F4

UN: R\$ 4,73 AV: R\$ 4,73 15: R\$ 4,82
 30: R\$ 4,92 45: R\$ 5,02 60: R\$ 5,12



PRATO PL JARDINEIRA 35CM CINZA

Código: 35207 Fábrica: NUTRIPLAN Unidade: UN/1 F1 F4

UN: R\$ 6,28 AV: R\$ 6,28 15: R\$ 6,41
 30: R\$ 6,54 45: R\$ 6,67 60: R\$ 6,80

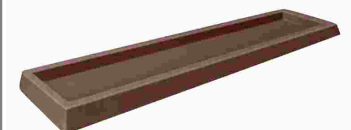

PRATO PL JARDINEIRA 35CM TABACO

Código: 33907 Fábrica: NUTRIPLAN Unidade: UN/1 F1 F4

UN: R\$ 10,27 AV: R\$ 10,27 15: R\$ 10,49
30: R\$ 10,70 45: R\$ 10,91 60: R\$ 11,13
11cm
50cm



PRATO PL JARDINEIRA 50 CM CAPUCCINO

Código: Fábrika: Unidade:
35208 NUTRIPLAN UN/1
F1 F4

UN: R\$ 14,60 AV: R\$ 14,60 15: R\$ 14,90
30: R\$ 15,20 45: R\$ 15,50 60: R\$ 15,81
11cm
50cm

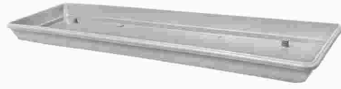

PRATO PL JARDINEIRA 50 CM CINZA

Código: Fábrika: Unidade:
35209 NUTRIPLAN UN/1
F1 F4

UN: R\$ 20,53 AV: R\$ 20,53 15: R\$ 20,96
30: R\$ 21,38 45: R\$ 21,81 60: R\$ 22,24
11cm
35cm



PRATO PL JARDINEIRA 80 CM CAPUCCINO

Código: Fábrika: Unidade:
35461 NUTRIPLAN UN/1
F1 F4

UN: R\$ 29,68 AV: R\$ 29,68 15: R\$ 30,29
30: R\$ 30,90 45: R\$ 31,52 60: R\$ 32,15
11cm
35cm



PRATO PL JARDINEIRA 80 CM CINZA

Código: Fábrika: Unidade:
35462 NUTRIPLAN UN/1
F1 F4

UN: R\$ 1,08 AV: R\$ 1,08 15: R\$ 1,10
30: R\$ 1,12 45: R\$ 1,15 60: R\$ 1,17
1,5 cm
8,5 cm



PRATO PL MINI FLOREIRA QUAD MARMORE

Código: Fábrika: Unidade:
22298 NUTRIPLAN UN/1
F1 F4

UN: R\$ 1,42 AV: R\$ 1,42 15: R\$ 1,45
30: R\$ 1,48 45: R\$ 1,51 60: R\$ 1,54
1,5 cm
8,5 cm



PRATO PL MINI FLOREIRA QUAD MARROM

Código: Fábrika: Unidade:
22297 NUTRIPLAN UN/1
F1 F4

UN: R\$ 0,92 AV: R\$ 0,92 15: R\$ 0,94
30: R\$ 0,96 45: R\$ 0,98 60: R\$ 1,00
1,5 cm
8,5 cm



PRATO PL MINI FLOREIRA QUAD PRETO

Código: Fábrika: Unidade:
30208 NUTRIPLAN UN/1
F1 F4

UN: R\$ 2,79 AV: R\$ 2,79 15: R\$ 2,85
30: R\$ 2,91 45: R\$ 2,97 60: R\$ 3,03



PRATO PL 0,5 RED PEQ AMARELO CLARO

Código: Fábrika: Unidade:
35713 NUTRIPLAN UN/1
F1 F4

UN: R\$ 2,79 AV: R\$ 2,79 15: R\$ 2,85
30: R\$ 2,91 45: R\$ 2,97 60: R\$ 3,03



PRATO PL 0,5 RED PEQ LILAS CLARO

Código: Fábrika: Unidade:
35714 NUTRIPLAN UN/1
F1 F4

UN: R\$ 2,79 AV: R\$ 2,79 15: R\$ 2,85
30: R\$ 2,91 45: R\$ 2,97 60: R\$ 3,03



PRATO PL 0,5 RED PEQ ROSA BEBE

Código: Fábrika: Unidade:
35715 NUTRIPLAN UN/1
F1 F4

UN: R\$ 2,79 AV: R\$ 2,79 15: R\$ 2,85
30: R\$ 2,91 45: R\$ 2,97 60: R\$ 3,03



PRATO PL 0,5 RED PEQ VERDE CLARO

Código: Fábrika: Unidade:
35716 NUTRIPLAN UN/1
F1 F4

UN: R\$ 22,50 AV: R\$ 22,50 15: R\$ 22,96
30: R\$ 23,42 45: R\$ 23,89 60: R\$ 24,37
6 cm
41 cm



PRATO PL 10 MARROM

Código: Fábrika: Unidade:
30292 NUTRIPLAN UN/1
F1 F4

UN: R\$ 1,28 AV: R\$ 1,28 15: R\$ 1,31
30: R\$ 1,34 45: R\$ 1,36 60: R\$ 1,39
3cm
14cm



PRATO PL 14 PRETO 14X3CM 226

Código: Fábrika: Unidade:
47291 BIG PLAST UN/1
F1 F4

UN: R\$ 1,77 AV: R\$ 1,77 15: R\$ 1,80
30: R\$ 1,84 45: R\$ 1,88 60: R\$ 1,91



PRATO PL 14 RED 14CM PRETO 344

Código: Fábrika: Unidade:
40847 JOREAL UN/1
F1 F4

UN: R\$ 2,41 AV: R\$ 2,41 15: R\$ 2,46
30: R\$ 2,51 45: R\$ 2,56 60: R\$ 2,62
3,5 cm
17 cm



PRATO PL 17 PRETO 17X3,5CM 228

Código: Fábrika: Unidade:
37707 BIG PLAST UN/1
F1 F4

UN: R\$ 2,76 AV: R\$ 2,76 15: R\$ 2,82
30: R\$ 2,88 45: R\$ 2,93 60: R\$ 2,99
3,5 cm
20 cm



PRATO PL 20 PRETO 20X3,5CM 230

Código: Fábrika: Unidade:
47290 BIG PLAST UN/1
F1 F4

UN: R\$ 3,94 AV: R\$ 3,94 15: R\$ 4,03
 30: R\$ 4,11 45: R\$ 4,19 60: R\$ 4,27



PRATO PL 22 PRETO 22X3,5CM 232

Código: 37706 Fábrica: BIG PLAST Unidade: UN/1
 F1 F4

UN: R\$ 35,03 AV: R\$ 35,03 15: R\$ 35,76
 30: R\$ 36,47 45: R\$ 37,20 60: R\$ 37,95



PRATO PL 29 QUAD TEXTUR AREIA

Código: 30342 Fábrica: NUTRIPLAN Unidade: UN/1
 F1 F4

UN: R\$ 27,22 AV: R\$ 27,22 15: R\$ 27,79
 30: R\$ 28,34 45: R\$ 28,91 60: R\$ 29,49



PRATO PL 29 QUAD TEXTUR FERRUGEM

Código: 30343 Fábrica: NUTRIPLAN Unidade: UN/1
 F1 F4

UN: R\$ 42,94 AV: R\$ 42,94 15: R\$ 43,83
 30: R\$ 44,71 45: R\$ 45,60 60: R\$ 46,51



PRATO PL 33 QUAD TEXTUR FERRUGEM

Código: 30344 Fábrica: NUTRIPLAN Unidade: UN/1
 F1 F4

UN: R\$ 56,50 AV: R\$ 56,50 15: R\$ 57,67
 30: R\$ 58,83 45: R\$ 60,00 60: R\$ 61,20



PRATO PL 41 RED TEXTUR AREIA

Código: 36795 Fábrica: NUTRIPLAN Unidade: UN/1
 F1 F4

UN: R\$ 45,20 AV: R\$ 45,20 15: R\$ 46,14
 30: R\$ 47,06 45: R\$ 48,00 60: R\$ 48,96

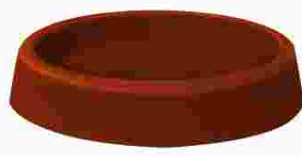

PRATO PL 41 RED TEXTUR FERRUGEM

Código: 30345 Fábrica: NUTRIPLAN Unidade: UN/1
 F1 F4

UN: R\$ 55,47 AV: R\$ 55,47 15: R\$ 56,62
 30: R\$ 57,76 45: R\$ 58,91 60: R\$ 60,09

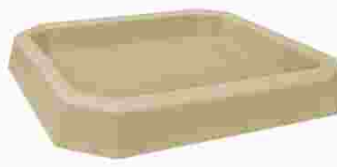

PRATO PL 44 QUAD LISO AREIA

Código: 30346 Fábrica: NUTRIPLAN Unidade: UN/1
 F1 F4

UN: R\$ 52,08 AV: R\$ 52,08 15: R\$ 53,16
 30: R\$ 54,23 45: R\$ 55,31 60: R\$ 56,42

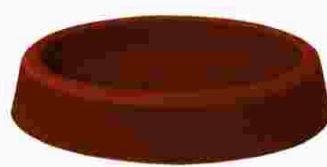

PRATO PL 46 RED LISO FERRUGEM

Código: 30341 Fábrica: NUTRIPLAN Unidade: UN/1
 F1 F4

UN: R\$ 53,93 AV: R\$ 53,93 15: R\$ 55,05
 30: R\$ 56,15 45: R\$ 57,28 60: R\$ 58,42



PRATO PL 47 RED TEXTUR FERRUGEM

Código: 30347 Fábrica: NUTRIPLAN Unidade: UN/1
 F1 F4

UN: R\$ 68,10 AV: R\$ 68,10 15: R\$ 69,52
 30: R\$ 70,91 45: R\$ 72,33 60: R\$ 73,78



PRATO PL 50 RED TEXTUR AREIA

Código: 36283 Fábrica: NUTRIPLAN Unidade: UN/1
 F1 F4

UN: R\$ 3,28 AV: R\$ 3,28 15: R\$ 3,35
 30: R\$ 3,41 45: R\$ 3,48 60: R\$ 3,55



PRATO PLAST FUNDO KIDS CORES 21X30CM 756

Código: 46643 Fábrica: QUALYPLAS Unidade: UN/1
 F1 F4

UN: R\$ 3,29 AV: R\$ 3,29 15: R\$ 3,36
 30: R\$ 3,42 45: R\$ 3,49 60: R\$ 3,56



PRATO PLAST FUNDO 3000

Código: 20712 Fábrica: SBRISSA Unidade: UN/1
 F1 F4

UN: R\$ 4,70 AV: R\$ 4,70 15: R\$ 4,80
 30: R\$ 4,89 45: R\$ 4,99 60: R\$ 5,09

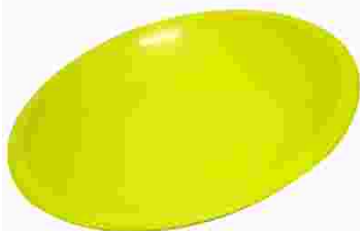

PRATO PLAST INF FUNDO 22 CM C/ABA 1276

Código: 18213 Fábrica: ECOPLASTIC Unidade: UN/1
 F1 F4

UN: R\$ 4,70 AV: R\$ 4,70 15: R\$ 4,80
 30: R\$ 4,89 45: R\$ 4,99 60: R\$ 5,09



PRATO PLAST INF RASO 20 CM S/ABA 1278

Código: 22322 Fábrica: ECOPLASTIC Unidade: UN/1
 F1 F4

UN: R\$ 2,60 AV: R\$ 2,60 15: R\$ 2,66
 30: R\$ 2,71 45: R\$ 2,77 60: R\$ 2,82



PRATO PLAST RASO 3007

Código: 14576 Fábrica: SBRISSA Unidade: UN/1
 F1 F4

UN: R\$ 11,30 AV: R\$ 67,80 15: R\$ 69,21
 30: R\$ 70,59 45: R\$ 72,00 60: R\$ 73,44



PRATO PORC FUNDO FEST BCO 23CM 7507 6X1

Código: 35059 Fábrica: CHEF LINE Unidade: PT/6
 F1 F4

UN: R\$ 17,12 AV: R\$ 102,72 15: R\$ 104,86
30: R\$ 106,96 45: R\$ 109,10 60: R\$ 111,28



PRATO PORC FUNDO QUAD BCO 24CM 7500 6X1

Código: Fábrica: Unidade:
35060 CHEF LINE PT/6
F1 F4

UN: R\$ 11,30 AV: R\$ 67,80 15: R\$ 69,21
30: R\$ 70,59 45: R\$ 72,00 60: R\$ 73,44



PRATO PORC FUNDO RED BCO 24CM 7504 6X1

Código: Fábrica: Unidade:
35058 CHEF LINE PT/6
F1 F4

UN: R\$ 27,19 AV: R\$ 163,12 15: R\$ 166,52
30: R\$ 169,85 45: R\$ 173,24 60: R\$ 176,71

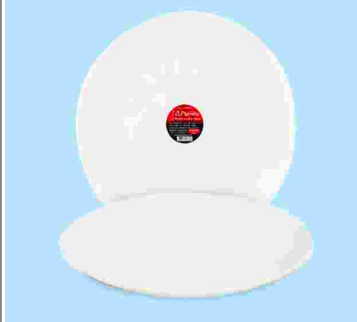

PRATO VIDRO RASO RED BCO 26,67CM 631 6X1

Código: Fábrica: Unidade:
48680 PLANETA CX/6
F1 F4

UN: R\$ 5,99 AV: R\$ 23,96 15: R\$ 23,96
30: R\$ 23,96 45: R\$ 23,96 60: R\$ 23,96



PRATO VIDRO TRANSP FUNDO 22CM MILLY 4X1

Código: Fábrica: Unidade:
50167 WELLMIX CJ/4
F1 F4

UN: R\$ 0,19 AV: R\$ 2,29 15: R\$ 2,29
30: R\$ 2,29 45: R\$ 2,29 60: R\$ 2,29



PRENDEDOR ROUPAS MADEIRA 7CM 12X1

Código: Fábrica: Unidade:
23765 AGUIA BRANCA DZ/12
F1 F4

UN: R\$ 0,18 AV: R\$ 6,36 15: R\$ 6,49
30: R\$ 6,62 45: R\$ 6,75 60: R\$ 6,89



PRENDEDOR ROUPAS MADEIRA 7,2CM 36X1

Código: Fábrica: Unidade:
47001 PRENDE MAIS PT/36
F1 F4

UN: R\$ 0,30 AV: R\$ 3,60 15: R\$ 3,67
30: R\$ 3,74 45: R\$ 3,82 60: R\$ 3,89



PRENDEDOR ROUPAS MADEIRA 9CM 12X1

Código: Fábrica: Unidade:
47000 PRENDE MAIS DZ/12
F1 F4

UN: R\$ 0,31 AV: R\$ 94,23 15: R\$ 96,20
30: R\$ 98,12 45: R\$ 100,08 60: R\$ 102,08



PRENDEDOR ROUPAS PLAST GDE 25X12

Código: Fábrica: Unidade:
41238 POLICORDA PT/300
F1 F4

UN: R\$ 0,94 AV: R\$ 11,29 15: R\$ 11,52
30: R\$ 11,75 45: R\$ 11,99 60: R\$ 12,23



PRENDEDOR ROUPAS PLAST 7CM 12X1 49 A

Código: Fábrica: Unidade:
27432 DEBIASI DZ/12
F1 F4

UN: R\$ 0,31 AV: R\$ 3,74 15: R\$ 3,82
30: R\$ 3,89 45: R\$ 3,97 60: R\$ 4,05



PRENDEDOR ROUPAS PLAST 8,5CM 12X1

Código: Fábrica: Unidade:
24652 PRENDE MAIS DZ/12
F1 F4

UN: R\$ 20,79 AV: R\$ 20,79 15: R\$ 21,22
30: R\$ 21,65 45: R\$ 22,08 60: R\$ 22,52



PREPARO P/ORQUÍDEAS 1KG

Código: Fábrica: Unidade:
32771 VITAPLAN UN/1
F1 F4

UN: R\$ 15,40 AV: R\$ 15,40 15: R\$ 15,72
30: R\$ 16,03 45: R\$ 16,35 60: R\$ 16,68



PROCESSADOR PLAST ALIMENTOS MANUAL 200ML

Código: Fábrica: Unidade:
44518 NICOBEM UN/1
F1 F4

UN: R\$ 25,67 AV: R\$ 25,67 15: R\$ 26,20
30: R\$ 26,73 45: R\$ 27,26 60: R\$ 27,81



PROCESSADOR PLAST ALIMENTOS MANUAL 450ML

Código: Fábrica: Unidade:
39793 HAI BRASIL UN/1
F1 F4

UN: R\$ 17,72 AV: R\$ 17,72 15: R\$ 18,09
30: R\$ 18,45 45: R\$ 18,82 60: R\$ 19,20



PROCESSADOR PLAST ALIMENTOS MANUAL 500ML

Código: Fábrica: Unidade:
40342 PLANETA UN/1
F1 F4

UN: R\$ 15,99 AV: R\$ 15,99 15: R\$ 15,99
30: R\$ 15,99 45: R\$ 15,99 60: R\$ 15,99



PROCESSADOR PLAST ALIMENTOS MANUAL 500ML

Código: Fábrica: Unidade:
50138 GP6 UN/1
F1 F4

UN: R\$ 18,48 AV: R\$ 18,48 15: R\$ 18,86
30: R\$ 19,24 45: R\$ 19,63 60: R\$ 20,02



PROCESSADOR PLAST ALIMENTOS MANUAL 500ML

Código: Fábrica: Unidade:
49651 WINCY UN/1
F1 F4

UN: R\$ 59,57 AV: R\$ 59,57 15: R\$ 60,81
30: R\$ 62,02 45: R\$ 63,27 60: R\$ 64,53



PROCESSADOR PLAST ALIMENTOS USB 220ML779

Código: Fábrika: Unidade:
41598 EMILAR UN/1
F1 F4

UN: R\$ 17,26 AV: R\$ 17,26 15: R\$ 17,62
30: R\$ 17,97 45: R\$ 18,33 60: R\$ 18,69



PULVERIZADOR BOMBA FLITZ 3267

Código: Fábrika: Unidade:
50967 FGB UN/1
F1 F4

UN: R\$ 78,07 AV: R\$ 78,07 15: R\$ 79,69
30: R\$ 81,29 45: R\$ 82,91 60: R\$ 84,57



PULVERIZADOR DE COMPRESSAO PREVIA 1,2 LT

Código: Fábrika: Unidade:
38649 GUARANY UN/1
F1 F4

UN: R\$ 7,81 AV: R\$ 7,81 15: R\$ 7,97
30: R\$ 8,13 45: R\$ 8,29 60: R\$ 8,46



PULVERIZADOR PET PLAST 500ML TRANSP 7631

Código: Fábrika: Unidade:
47358 ALTIHOME UN/1
F1 F4

UN: R\$ 7,34 AV: R\$ 7,34 15: R\$ 7,50
30: R\$ 7,65 45: R\$ 7,80 60: R\$ 7,96



PULVERIZADOR PLAST P/GARRAFA PET 4017

Código: Fábrika: Unidade:
50146 GP6 UN/1
F1 F4

UN: R\$ 7,83 AV: R\$ 7,83 15: R\$ 8,00
30: R\$ 8,16 45: R\$ 8,32 60: R\$ 8,49



PULVERIZADOR PLAST 300 ML DISPENSER 001

Código: Fábrika: Unidade:
49377 RIOHOME UN/1
F1 F4

UN: R\$ 9,18 AV: R\$ 9,18 15: R\$ 9,37
30: R\$ 9,56 45: R\$ 9,75 60: R\$ 9,95



PULVERIZADOR PLAST 350 ML QUALITY 843

Código: Fábrika: Unidade:
35831 LUMAR UN/1
F1 F4

UN: R\$ 11,53 AV: R\$ 11,53 15: R\$ 11,77
30: R\$ 12,01 45: R\$ 12,25 60: R\$ 12,49

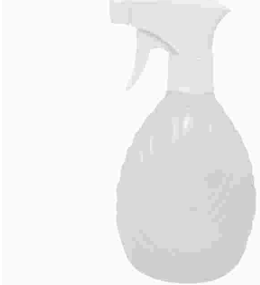

PULVERIZADOR PLAST 450 ML QUALITY 842

Código: Fábrika: Unidade:
35832 LUMAR UN/1
F1 F4

UN: R\$ 6,48 AV: R\$ 6,48 15: R\$ 6,62
30: R\$ 6,75 45: R\$ 6,88 60: R\$ 7,02



PULVERIZADOR PLAST 500 ML TRANSP 5028

Código: Fábrika: Unidade:
39375 ARBRA UN/1
F1 F4

UN: R\$ 13,63 AV: R\$ 13,63 15: R\$ 13,91
30: R\$ 14,19 45: R\$ 14,48 60: R\$ 14,77



PULVERIZADOR PLAST 500 ML VERDE

Código: Fábrika: Unidade:
37222 NUTRIPLAN UN/1
F1 F4

UN: R\$ 7,18 AV: R\$ 7,18 15: R\$ 7,33
30: R\$ 7,48 45: R\$ 7,63 60: R\$ 7,78



PULVERIZADOR PLAST 500ML TRANSP 35654

Código: Fábrika: Unidade:
44098 NOBRE UN/1
F1 F4

UN: R\$ 15,67 AV: R\$ 15,67 15: R\$ 15,99
30: R\$ 16,31 45: R\$ 16,64 60: R\$ 16,97



PULVERIZADOR PLAST 550 ML GIRAFIA 430150

Código: Fábrika: Unidade:
38894 PLASDURAN UN/1
F1 F4

UN: R\$ 14,69 AV: R\$ 14,69 15: R\$ 15,00
30: R\$ 15,29 45: R\$ 15,60 60: R\$ 15,91



PULVERIZADOR PLAST 580 ML AZUL

Código: Fábrika: Unidade:
18503 NUTRIPLAN UN/1
F1 F4

UN: R\$ 12,21 AV: R\$ 12,21 15: R\$ 12,47
30: R\$ 12,72 45: R\$ 12,97 60: R\$ 13,23



PULVERIZADOR PLAST 750 ML QUALITY 847

Código: Fábrika: Unidade:
35835 LUMAR UN/1
F1 F4

UN: R\$ 10,26 AV: R\$ 10,26 15: R\$ 10,48
30: R\$ 10,69 45: R\$ 10,90 60: R\$ 11,12



PUXA SACO

Código: Fábrika: Unidade:
11337 MC PANOS UN/1
F1 F4

UN: R\$ 2,66 AV: R\$ 2,66 15: R\$ 2,72
30: R\$ 2,77 45: R\$ 2,83 60: R\$ 2,88

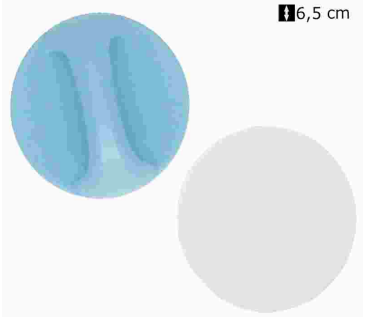

PUXADOR PLAST AUTO COLANTE 6,5CM 106-9

Código: Fábrika: Unidade:
44520 NICOBEM UN/1
F1 F4

UN: R\$ 10,07 AV: R\$ 10,07 15: R\$ 10,28
30: R\$ 10,48 45: R\$ 10,69 60: R\$ 10,91



PUXADOR P/TAMPA DE PAINEL 105753113 2X1

Código: 33444 Fábrica: MAXPING Unidade: UN/1 F1 F4

UN: R\$ 24,64 AV: R\$ 24,64 15: R\$ 25,16
30: R\$ 25,66 45: R\$ 26,17 60: R\$ 26,70

1146 cm
38 cm



QUADRO PL PAINEL 1 PINUS 3004

Código: 37163 Fábrica: PAIOL Unidade: UN/1 F1 F4

UN: R\$ 28,75 AV: R\$ 28,75 15: R\$ 29,35
30: R\$ 29,94 45: R\$ 30,54 60: R\$ 31,15

1157 cm
46 cm



QUADRO PL PAINEL 2 PINUS 3005

Código: 37164 Fábrica: PAIOL Unidade: UN/1 F1 F4

UN: R\$ 30,81 AV: R\$ 30,81 15: R\$ 31,45
30: R\$ 32,08 45: R\$ 32,72 60: R\$ 33,37

1163 cm
57 cm



QUADRO PL PAINEL 3 PINUS 3006

Código: 37165 Fábrica: PAIOL Unidade: UN/1 F1 F4

UN: R\$ 41,08 AV: R\$ 41,08 15: R\$ 41,93
30: R\$ 42,77 45: R\$ 43,63 60: R\$ 44,50

1193 cm
39 cm



QUADRO PL PAINEL 4 PINUS 3007

Código: 37166 Fábrica: PAIOL Unidade: UN/1 F1 F4

UN: R\$ 49,31 AV: R\$ 49,31 15: R\$ 50,33
30: R\$ 51,34 45: R\$ 52,37 60: R\$ 53,41

11115 cm
46 cm



QUADRO PL PAINEL 5 PINUS 3008

Código: 37167 Fábrica: PAIOL Unidade: UN/1 F1 F4

UN: R\$ 35,94 AV: R\$ 35,94 15: R\$ 36,69
30: R\$ 37,42 45: R\$ 38,17 60: R\$ 38,94

1138 cm
40 cm

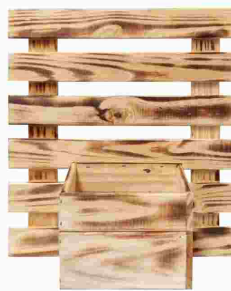

QUADRO PL 1 CRISANTEMO PINUS ENV 3201-2

Código: 37162 Fábrica: PAIOL Unidade: UN/1 F1 F4

UN: R\$ 35,94 AV: R\$ 35,94 15: R\$ 36,69
30: R\$ 37,42 45: R\$ 38,17 60: R\$ 38,94

1140 cm
37,5 cm



QUADRO PL 1 CRISANTEMO PINUS PINT 3201-1

Código: 39469 Fábrica: PAIOL Unidade: UN/1 F1 F4

UN: R\$ 31,83 AV: R\$ 31,83 15: R\$ 32,50
30: R\$ 33,15 45: R\$ 33,81 60: R\$ 34,49

1133 cm
28 cm



QUADRO PL 1 VIOLETA PINOS PINTADO 0024-1

Código: 37156 Fábrica: PAIOL Unidade: UN/1 F1 F4

UN: R\$ 31,83 AV: R\$ 31,83 15: R\$ 32,50
30: R\$ 33,15 45: R\$ 33,81 60: R\$ 34,49

1133 cm
28 cm

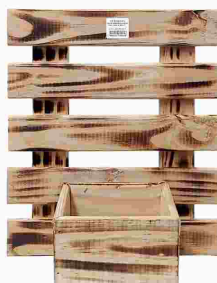

QUADRO PL 1 VIOLETA PINUS ENVELHE 0024-2

Código: 37155 Fábrica: PAIOL Unidade: UN/1 F1 F4

UN: R\$ 40,05 AV: R\$ 40,05 15: R\$ 40,88
30: R\$ 41,70 45: R\$ 42,54 60: R\$ 43,39

1147 cm
43 cm



QUADRO PL 2 CRISANTEMO PINUS ENV 3200-2

Código: 37161 Fábrica: PAIOL Unidade: UN/1 F1 F4

UN: R\$ 40,05 AV: R\$ 40,05 15: R\$ 40,88
30: R\$ 41,70 45: R\$ 42,54 60: R\$ 43,39

1147 cm
43 cm



QUADRO PL 2 CRISANTEMO PINUS PINT 3200-1

Código: 37957 Fábrica: PAIOL Unidade: UN/1 F1 F4

UN: R\$ 33,89 AV: R\$ 33,89 15: R\$ 34,59
30: R\$ 35,29 45: R\$ 35,99 60: R\$ 36,71

1140 cm
38 cm



QUADRO PL 2 VIOLETAS PINUS ENVELHECI 26-1

Código: 37158 Fábrica: PAIOL Unidade: UN/1 F1 F4

UN: R\$ 33,89 AV: R\$ 33,89 15: R\$ 34,59
30: R\$ 35,29 45: R\$ 35,99 60: R\$ 36,71

1140 cm
38 cm



QUADRO PL 2 VIOLETAS PINUS PINTADO 26-2

Código: 37157 Fábrica: PAIOL Unidade: UN/1 F1 F4

UN: R\$ 35,94 AV: R\$ 35,94 15: R\$ 36,69
30: R\$ 37,42 45: R\$ 38,17 60: R\$ 38,94

1140 cm
47 cm



QUADRO PL 3 VIOLETAS PINUS ENVELHEC 23-2

Código: 37159 Fábrica: PAIOL Unidade: UN/1 F1 F4

UN: R\$ 15,40 AV: R\$ 15,40 15: R\$ 15,72
30: R\$ 16,03 45: R\$ 16,35 60: R\$ 16,68

22cm

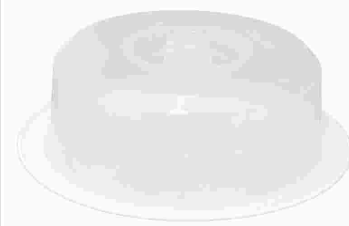

QUEIJEIRA PLAST 0027

Código: 4269 Fábrica: JAGUAR Unidade: UN/1 F1 F4

UN: R\$ 34,91 AV: R\$ 34,91 15: R\$ 35,64
30: R\$ 36,35 45: R\$ 37,08 60: R\$ 37,82



RALADOR INOX 6 FACES CB PLAST BRANCO 59
Código: Fábrika: Unidade:
46584 HERCULES UN/1
F1 F4

UN: R\$ 7,26 AV: R\$ 7,26 15: R\$ 7,41
30: R\$ 7,56 45: R\$ 7,71 60: R\$ 7,87



RALADOR 1 FACE INOX 25CM 062
Código: Fábrika: Unidade:
47327 NIX UN/1
F1 F4

UN: R\$ 12,32 AV: R\$ 12,32 15: R\$ 12,57
30: R\$ 12,82 45: R\$ 13,08 60: R\$ 13,34



RALADOR 4 FACES FLANDRES CB PLAST 3201
Código: Fábrika: Unidade:
38331 VIEL UN/1
F1 F4

UN: R\$ 3,07 AV: R\$ 3,07 15: R\$ 3,14
30: R\$ 3,20 45: R\$ 3,26 60: R\$ 3,33

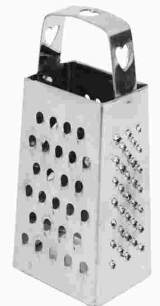

RALADOR 4 FACES INOX MINI 14713
Código: Fábrika: Unidade:
46493 NICOBEM UN/1
F1 F4

UN: R\$ 10,78 AV: R\$ 10,78 15: R\$ 11,00
30: R\$ 11,22 45: R\$ 11,44 60: R\$ 11,67

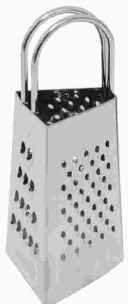

RALADOR 4 FACES INOX MINI 8CM 272
Código: Fábrika: Unidade:
48681 PLANETA UN/1
F1 F4

UN: R\$ 7,69 AV: R\$ 7,69 15: R\$ 7,85
30: R\$ 8,01 45: R\$ 8,17 60: R\$ 8,33



RALADOR 4 FACES PLAST 732
Código: Fábrika: Unidade:
35845 LUMAR UN/1
F1 F4

UN: R\$ 21,56 AV: R\$ 21,56 15: R\$ 22,01
30: R\$ 22,45 45: R\$ 22,90 60: R\$ 23,36



RALADOR 6 FACES INOX 22CM CB METAL 12946
Código: Fábrika: Unidade:
41290 GP6 UN/1
F1 F4

UN: R\$ 1,84 AV: R\$ 1,84 15: R\$ 1,88
30: R\$ 1,91 45: R\$ 1,95 60: R\$ 1,99



RALINHO INOX P/PIA 5,2CM CTL 348
Código: Fábrika: Unidade:
44502 PLANETA CR/1
F1 F4

UN: R\$ 4,10 AV: R\$ 4,10 15: R\$ 4,18
30: R\$ 4,27 45: R\$ 4,35 60: R\$ 4,44



RALINHO INOX P/PIA 5,5CM CTL 4472
Código: Fábrika: Unidade:
49630 WINMAX CR/1
F1 F4

UN: R\$ 1,54 AV: R\$ 18,48 15: R\$ 18,86
30: R\$ 19,24 45: R\$ 19,63 60: R\$ 20,02



RALINHO TELA GALV P/PIA 4,5 CM 1011 12X1
Código: Fábrika: Unidade:
13446 JWC DZ/12
F1 F4

UN: R\$ 2,14 AV: R\$ 25,67 15: R\$ 26,20
30: R\$ 26,73 45: R\$ 27,26 60: R\$ 27,81

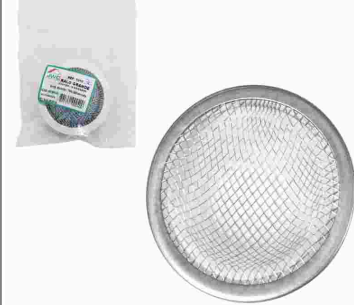

RALINHO TELA GALV P/PIA 7 CM G 1010 12X1
Código: Fábrika: Unidade:
25222 JWC DZ/12
F1 F4

UN: R\$ 4,93 AV: R\$ 4,93 15: R\$ 5,03
30: R\$ 5,13 45: R\$ 5,24 60: R\$ 5,34



RALO INOX P/PIA 7CM CTL MG-2984
Código: Fábrika: Unidade:
40303 MEGAGIFT CR/1
F1 F4

UN: R\$ 41,81 AV: R\$ 41,81 15: R\$ 42,68
30: R\$ 43,53 45: R\$ 44,40 60: R\$ 45,30



RALO OCULTO SIFONADO 150X150MM BEGE
Código: Fábrika: Unidade:
48608 REBOUCAS UN/1
F1 F4

UN: R\$ 41,23 AV: R\$ 41,23 15: R\$ 42,08
30: R\$ 42,92 45: R\$ 43,78 60: R\$ 44,66



RALO OCULTO SIFONADO 150X150MM BRANCO
Código: Fábrika: Unidade:
48604 REBOUCAS UN/1
F1 F4

UN: R\$ 41,81 AV: R\$ 41,81 15: R\$ 42,68
30: R\$ 43,53 45: R\$ 44,40 60: R\$ 45,30

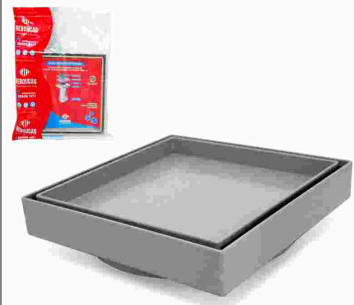

RALO OCULTO SIFONADO 150X150MM CINZA
Código: Fábrika: Unidade:
48606 REBOUCAS UN/1
F1 F4

UN: R\$ 41,81 AV: R\$ 41,81 15: R\$ 42,68
30: R\$ 43,53 45: R\$ 44,40 60: R\$ 45,30



RALO OCULTO SIFONADO 150X150MM MARROM
Código: Fábrika: Unidade:
48607 REBOUCAS UN/1
F1 F4

UN: R\$ 41,23 AV: R\$ 41,23 15: R\$ 42,08
30: R\$ 42,92 45: R\$ 43,78 60: R\$ 44,66



RALO OCULTO SIFONADO 150X150MM PRETO
Código: Fábrica: Unidade:
48605 REBOUCAS UN/1
F1 F4

UN: R\$ 18,48 AV: R\$ 18,48 15: R\$ 18,86
30: R\$ 19,24 45: R\$ 19,63 60: R\$ 20,02



REFRESQUEIRA ALUM LEVE 14 1,2 LTS
Código: Fábrica: Unidade:
5894 AVELAR UN/1
F1 F4

UN: R\$ 46,53 AV: R\$ 46,53 15: R\$ 47,50
30: R\$ 48,45 45: R\$ 49,42 60: R\$ 50,41
17 cm



REGADOR ALUM MEDIO 600 ML 648
Código: Fábrica: Unidade:
39542 BMC ALUMINIO UN/1
F1 F4

UN: R\$ 15,40 AV: R\$ 15,40 15: R\$ 15,72
30: R\$ 16,03 45: R\$ 16,35 60: R\$ 16,68



REGADOR PLAST 5 LTS RECICL VERDE 7006
Código: Fábrica: Unidade:
49519 ARBRA UN/1
F1 F4

UN: R\$ 22,86 AV: R\$ 22,86 15: R\$ 23,33
30: R\$ 23,80 45: R\$ 24,27 60: R\$ 24,76



REGADOR PLAST 8 LTS RECICL PRETO 7004
Código: Fábrica: Unidade:
9513 ARBRA UN/1
F1 F4

UN: R\$ 22,86 AV: R\$ 22,86 15: R\$ 23,33
30: R\$ 23,80 45: R\$ 24,27 60: R\$ 24,76
35 cm
8 lts



REGADOR PLAST 8 LTS RECICL VERDE 7005
Código: Fábrica: Unidade:
39373 ARBRA UN/1
F1 F4

UN: R\$ 16,10 AV: R\$ 16,10 15: R\$ 16,43
30: R\$ 16,76 45: R\$ 17,10 60: R\$ 17,44
20 cm
37 cm



REGADOR PLAST PEQ 1,5LT C/CHUVEIRO LILAS
Código: Fábrica: Unidade:
46044 NUTRIPLAN UN/1
F1 F4

UN: R\$ 16,10 AV: R\$ 16,10 15: R\$ 16,43
30: R\$ 16,76 45: R\$ 17,10 60: R\$ 17,44
20 cm
37 cm



REGADOR PLAST PEQ 1,5LT C/CHUVEIRO ROSA
Código: Fábrica: Unidade:
46043 NUTRIPLAN UN/1
F1 F4

UN: R\$ 23,62 AV: R\$ 23,62 15: R\$ 24,11
30: R\$ 24,59 45: R\$ 25,08 60: R\$ 25,58



REGADOR PLAST 10 LTS RECICL PRETO 7001
Código: Fábrica: Unidade:
49518 ARBRA UN/1
F1 F4

UN: R\$ 23,11 AV: R\$ 23,11 15: R\$ 23,59
30: R\$ 24,07 45: R\$ 24,55 60: R\$ 25,04
35 cm
66 cm
10 L



REGADOR PLAST 10 LTS RECICL VERDE 7002
Código: Fábrica: Unidade:
44981 ARBRA UN/1
F1 F4

UN: R\$ 10,31 AV: R\$ 123,70 15: R\$ 126,27
30: R\$ 128,80 45: R\$ 131,38 60: R\$ 134,00



REGISTRO PRESSAO PVC BCO C/VOL 51N 12X1
Código: Fábrica: Unidade:
40159 REBOUCAS PT/12
F1 F4

UN: R\$ 11,45 AV: R\$ 137,44 15: R\$ 140,31
30: R\$ 143,11 45: R\$ 145,97 60: R\$ 148,89



REGISTRO PRESSAO PVC BCO C/VOL 52N 12X1
Código: Fábrica: Unidade:
40158 REBOUCAS PT/12
F1 F4

UN: R\$ 10,57 AV: R\$ 126,82 15: R\$ 129,47
30: R\$ 132,06 45: R\$ 134,70 60: R\$ 137,39



REGISTRO PRESSAO PVC BCO C/VOL 53N 12X1
Código: Fábrica: Unidade:
40157 REBOUCAS PT/12
F1 F4

UN: R\$ 11,45 AV: R\$ 137,45 15: R\$ 140,32
30: R\$ 143,12 45: R\$ 145,99 60: R\$ 148,91



REGISTRO PRESSAO PVC BCO C/VOL 54N 12X1
Código: Fábrica: Unidade:
40162 REBOUCAS PT/12
F1 F4

UN: R\$ 10,31 AV: R\$ 123,70 15: R\$ 126,27
30: R\$ 128,80 45: R\$ 131,38 60: R\$ 134,00



REGISTRO PRESSAO PVC MARR C/VOL 55N 12X1
Código: Fábrica: Unidade:
40160 REBOUCAS PT/12
F1 F4

UN: R\$ 11,45 AV: R\$ 137,44 15: R\$ 140,31
30: R\$ 143,11 45: R\$ 145,97 60: R\$ 148,89



REGISTRO PRESSAO PVC MARR C/VOL 56N 12X1
Código: Fábrica: Unidade:
40161 REBOUCAS PT/12
F1 F4

UN: R\$ 51,35 AV: R\$ 51,35 15: R\$ 52,42
30: R\$ 53,47 45: R\$ 54,54 60: R\$ 55,63



REGULADOR GAS 1KG COMPLETO 14400 163

Código: Fábrica: Unidade:
47760 VINIGAS UN/1
F1 F4

UN: R\$ 32,86 AV: R\$ 32,86 15: R\$ 33,54
30: R\$ 34,22 45: R\$ 34,90 60: R\$ 35,60



REGULADOR GAS 1KG C/REGISTRO 14300 162

Código: Fábrica: Unidade:
47882 VINIGAS UN/1
F1 F4

UN: R\$ 1,94 AV: R\$ 1,94 15: R\$ 1,98
30: R\$ 2,02 45: R\$ 2,06 60: R\$ 2,10



RODINHO DE PIA CABO MADEIRA 37

Código: Fábrica: Unidade:
6293 N.HORIZONTE UN/1
F1 F4

UN: R\$ 3,63 AV: R\$ 3,63 15: R\$ 3,70
30: R\$ 3,78 45: R\$ 3,85 60: R\$ 3,93



RODINHO DE PIA CABO PLAST 83

Código: Fábrica: Unidade:
48937 N.HORIZONTE UN/1
F1 F4

UN: R\$ 2,87 AV: R\$ 2,87 15: R\$ 2,93
30: R\$ 2,98 45: R\$ 3,04 60: R\$ 3,10



RODINHO PLAST PIA COLOR 744

Código: Fábrica: Unidade:
44085 QUALYPLAS UN/1
F1 F4

UN: R\$ 17,82 AV: R\$ 17,82 15: R\$ 18,19
30: R\$ 18,56 45: R\$ 18,93 60: R\$ 19,31



RODIZIO METAL E PLAST GIRATORIO C/FREIO

Código: Fábrica: Unidade:
50834 GP6 UN/1
F1 F4

UN: R\$ 51,35 AV: R\$ 51,35 15: R\$ 52,42
30: R\$ 53,47 45: R\$ 54,54 60: R\$ 55,63



RODO ALUM 40 CM C/CABO ALUM

Código: Fábrica: Unidade:
50913 SANCHES UN/1
F1 F4

UN: R\$ 61,62 AV: R\$ 61,62 15: R\$ 62,91
30: R\$ 64,16 45: R\$ 65,45 60: R\$ 66,76



RODO ALUM 60 CM C/CABO ALUM

Código: Fábrica: Unidade:
50631 SANCHES UN/1
F1 F4

UN: R\$ 13,80 AV: R\$ 13,80 15: R\$ 14,08
30: R\$ 14,36 45: R\$ 14,65 60: R\$ 14,94



RODO FIORY 30CM CM C/CABO MADEIRA UN

Código: Fábrica: Unidade:
47252 SHANGRILA UN/1
F1 F4

UN: R\$ 15,68 AV: R\$ 15,68 15: R\$ 16,00
30: R\$ 16,32 45: R\$ 16,65 60: R\$ 16,98



RODO FIORY 40CM CM C/CABO MADEIRA UN

Código: Fábrica: Unidade:
47253 SHANGRILA UN/1
F1 F4

UN: R\$ 23,92 AV: R\$ 23,92 15: R\$ 24,42
30: R\$ 24,91 45: R\$ 25,41 60: R\$ 25,92



RODO FIORY 60CM CM C/CABO MADEIRA UN

Código: Fábrica: Unidade:
47254 SHANGRILA UN/1
F1 F4

UN: R\$ 7,53 AV: R\$ 90,39 15: R\$ 92,28
30: R\$ 94,12 45: R\$ 96,00 60: R\$ 97,92



RODO MADEIRA 30CM 2700 12X1

Código: Fábrica: Unidade:
37977 DALCIN PT/12
F1 F4

UN: R\$ 22,08 AV: R\$ 22,08 15: R\$ 22,54
30: R\$ 23,00 45: R\$ 23,46 60: R\$ 23,92



RODO PLAST P/LIMPAR VIDRO 30X26CM 110-19

Código: Fábrica: Unidade:
40659 CASA ONZE UN/1
F1 F4

UN: R\$ 12,17 AV: R\$ 146,04 15: R\$ 149,08
30: R\$ 152,06 45: R\$ 155,10 60: R\$ 158,20



RODO PLAST PUXA SECA 30CM C/CB 5109 12X1

Código: Fábrica: Unidade:
49814 EDS PT/12
F1 F4

UN: R\$ 16,94 AV: R\$ 16,94 15: R\$ 17,29
30: R\$ 17,64 45: R\$ 17,99 60: R\$ 18,35



RODO PLAST PUXA SECA 60 CM C/CABO 5123

Código: Fábrica: Unidade:
49808 EDS UN/1
F1 F4

UN: R\$ 15,81 AV: R\$ 15,81 15: R\$ 16,14
30: R\$ 16,46 45: R\$ 16,79 60: R\$ 17,13



RODO PLAST 60 CM C/CABO MAD 85

Código: Fábrica: Unidade:
50234 HALLEY UN/1
F1 F4

UN: R\$ 35,94 AV: R\$ 35,94 15: R\$ 36,69
30: R\$ 37,42 45: R\$ 38,17 60: R\$ 38,94

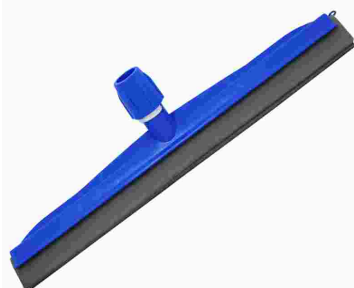

RODO 45CM DRY BRALIMPIA AZUL S/CABO
Código: Fábrica: Unidade:
46721 BRALIMPIA UN/1
F1 F4

UN: R\$ 28,25 AV: R\$ 28,25 15: R\$ 28,84
30: R\$ 29,41 45: R\$ 30,00 60: R\$ 30,60



ROLETE PLAST P/PAPEL HIGIENICO 1053 12X1
Código: Fábrica: Unidade:
33289 JWC PT/1
F1 F4

UN: R\$ 15,40 AV: R\$ 15,40 15: R\$ 15,72
30: R\$ 16,03 45: R\$ 16,35 60: R\$ 16,68



ROLO MADEIRA P/MASSA 107
Código: Fábrica: Unidade:
41319 MAD LAR UN/1
F1 F4

UN: R\$ 10,26 AV: R\$ 10,26 15: R\$ 10,48
30: R\$ 10,69 45: R\$ 10,90 60: R\$ 11,12



ROLO MADEIRA P/MASSA 4,5X40CM 083
Código: Fábrica: Unidade:
47900 CASITA UN/1
F1 F4

UN: R\$ 6,56 AV: R\$ 6,56 15: R\$ 6,70
30: R\$ 6,83 45: R\$ 6,97 60: R\$ 7,11



SABONETEIRA PET PLAST 500ML TRANSP 7632
Código: Fábrica: Unidade:
47359 ALTIHOME UN/1
F1 F4

UN: R\$ 3,63 AV: R\$ 3,63 15: R\$ 3,70
30: R\$ 3,78 45: R\$ 3,85 60: R\$ 3,93



SABONETEIRA PLAST C/TELA 605
Código: Fábrica: Unidade:
12167 JAGUAR UN/1
F1 F4

UN: R\$ 3,60 AV: R\$ 3,60 15: R\$ 3,67
30: R\$ 3,74 45: R\$ 3,82 60: R\$ 3,89



SACO P/LAVAR ROUPA 30X40CM 19006/15885
Código: Fábrica: Unidade:
36951 ALIANCA UN/1
F1 F4

UN: R\$ 21,56 AV: R\$ 21,56 15: R\$ 22,01
30: R\$ 22,45 45: R\$ 22,90 60: R\$ 23,36



SACOLA NYLON 20X38CM MARIA C/BOTAO
Código: Fábrica: Unidade:
27404 FERREIRA UN/1
F1 F4

UN: R\$ 22,59 AV: R\$ 22,59 15: R\$ 23,06
30: R\$ 23,52 45: R\$ 23,99 60: R\$ 24,47



SACOLA NYLON 24X36CM P UTIL C/ZIPER
Código: Fábrica: Unidade:
27401 FERREIRA UN/1
F1 F4

UN: R\$ 20,53 AV: R\$ 20,53 15: R\$ 20,96
30: R\$ 21,38 45: R\$ 21,81 60: R\$ 22,24



SACOLA NYLON 32X29CM TULIPA
Código: Fábrica: Unidade:
29114 FERREIRA UN/1
F1 F4

UN: R\$ 15,40 AV: R\$ 15,40 15: R\$ 15,72
30: R\$ 16,03 45: R\$ 16,35 60: R\$ 16,68



SACOLA NYLON 37X36CM ECONOMICA TRAD
Código: Fábrica: Unidade:
27402 FERREIRA UN/1
F1 F4

UN: R\$ 20,53 AV: R\$ 20,53 15: R\$ 20,96
30: R\$ 21,38 45: R\$ 21,81 60: R\$ 22,24



SACOLA NYLON 39X41CM M TRAD
Código: Fábrica: Unidade:
27400 FERREIRA UN/1
F1 F4

UN: R\$ 30,81 AV: R\$ 30,81 15: R\$ 31,45
30: R\$ 32,08 45: R\$ 32,72 60: R\$ 33,37



SACOLA NYLON 40X39CM FERREIRA
Código: Fábrica: Unidade:
27403 FERREIRA UN/1
F1 F4

UN: R\$ 0,40 AV: R\$ 40,11 15: R\$ 40,95
30: R\$ 41,77 45: R\$ 42,60 60: R\$ 43,45



SACOLA PLAST PRES 20X30CM ESTAMP 100X1
Código: Fábrica: Unidade:
49637 WINMAX PT/100
F1 F4

UN: R\$ 0,46 AV: R\$ 46,12 15: R\$ 47,08
30: R\$ 48,02 45: R\$ 48,98 60: R\$ 49,96



SACOLA PLAST PRES 25X35CM ESTAMP 100X1
Código: Fábrica: Unidade:
49638 WINMAX PT/100
F1 F4

UN: R\$ 0,54 AV: R\$ 54,24 15: R\$ 55,37
30: R\$ 56,47 45: R\$ 57,60 60: R\$ 58,75



SACOLA PLAST PRES 30X40CM ESTAMP 100X1
Código: Fábrica: Unidade:
49639 WINMAX PT/100
F1 F4

UN: R\$ 0,68 AV: R\$ 67,64 15: R\$ 69,05
30: R\$ 70,43 45: R\$ 71,84 60: R\$ 73,28



SACOLA PLAST PRES 35X45CM ESTAMP 100X1

Código: 49640 Fábrica: WINMAX Unidade: PT/100
F1 F4

UN: R\$ 0,92 AV: R\$ 91,73 15: R\$ 93,64
30: R\$ 95,51 45: R\$ 97,42 60: R\$ 99,37

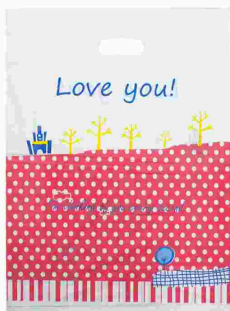

SACOLA PLAST PRES 40X50CM ESTAMP 100X1

Código: 49641 Fábrica: WINMAX Unidade: PT/100
F1 F4

UN: R\$ 14,37 AV: R\$ 14,37 15: R\$ 14,67
30: R\$ 14,96 45: R\$ 15,26 60: R\$ 15,57



SACOLA PLAST 45X50X20CM ESTAMP 150-11

Código: 42402 Fábrica: NICOBEM Unidade: UN/1
F1 F4

UN: R\$ 25,27 AV: R\$ 25,27 15: R\$ 25,80
30: R\$ 26,31 45: R\$ 26,84 60: R\$ 27,37



SACOLA PLAST 60X45X20CM ESTAMP 756

Código: 45911 Fábrica: WINMAX Unidade: UN/1
F1 F4

UN: R\$ 40,29 AV: R\$ 40,29 15: R\$ 41,13
30: R\$ 41,95 45: R\$ 42,79 60: R\$ 43,64



SACOLA PLAST 800X60X25CM ESTAMP 758

Código: 45912 Fábrica: WINMAX Unidade: UN/1
F1 F4

UN: R\$ 35,64 AV: R\$ 35,64 15: R\$ 36,39
30: R\$ 37,11 45: R\$ 37,86 60: R\$ 38,61



SALADEIRA PLAST C/TAMPA GDE 10,0LTS 825

Código: 39560 Fábrica: LUMAR Unidade: UN/1
F1 F4

UN: R\$ 15,66 AV: R\$ 15,66 15: R\$ 15,99
30: R\$ 16,31 45: R\$ 16,64 60: R\$ 16,97



SALADEIRA PLAST C/TAMPA GDE 3,0LTS 854

Código: 39558 Fábrica: LUMAR Unidade: UN/1
F1 F4

UN: R\$ 28,35 AV: R\$ 28,35 15: R\$ 28,94
30: R\$ 29,52 45: R\$ 30,11 60: R\$ 30,71



SALADEIRA PLAST C/TAMPA GDE 6,0LTS 820

Código: 39559 Fábrica: LUMAR Unidade: UN/1
F1 F4

UN: R\$ 10,06 AV: R\$ 10,06 15: R\$ 10,27
30: R\$ 10,47 45: R\$ 10,68 60: R\$ 10,89



SALADEIRA PLAST C/TAMPA MED 1,5LTS 853

Código: 39557 Fábrica: LUMAR Unidade: UN/1
F1 F4

UN: R\$ 6,83 AV: R\$ 6,83 15: R\$ 6,97
30: R\$ 7,11 45: R\$ 7,25 60: R\$ 7,40



SALADEIRA PLAST C/TAMPA PEQ 800ML 852

Código: 39556 Fábrica: LUMAR Unidade: UN/1
F1 F4

UN: R\$ 8,00 AV: R\$ 8,00 15: R\$ 8,17
30: R\$ 8,33 45: R\$ 8,50 60: R\$ 8,67



SALADEIRA PLAST C/TPA ONDUL 2,6 LTS 42

Código: 49705 Fábrica: NOVA ERA Unidade: UN/1
F1 F4

UN: R\$ 8,88 AV: R\$ 8,88 15: R\$ 9,07
30: R\$ 9,25 45: R\$ 9,43 60: R\$ 9,62



SALADEIRA PLAST GDE S/TAMPA 25X10CM 1053

Código: 36962 Fábrica: ENGIPLAST Unidade: UN/1
F1 F4

UN: R\$ 5,64 AV: R\$ 5,64 15: R\$ 5,76
30: R\$ 5,88 45: R\$ 5,99 60: R\$ 6,11



SALADEIRA PLAST MED S/TAMPA 20X8CM 1052

Código: 36961 Fábrica: ENGIPLAST Unidade: UN/1
F1 F4

UN: R\$ 7,93 AV: R\$ 7,93 15: R\$ 8,09
30: R\$ 8,26 45: R\$ 8,42 60: R\$ 8,59



SALADEIRA PLAST PEQ C/TAMPA 15X6CM 1055

Código: 36957 Fábrica: ENGIPLAST Unidade: UN/1
F1 F4

UN: R\$ 3,70 AV: R\$ 3,70 15: R\$ 3,78
30: R\$ 3,85 45: R\$ 3,93 60: R\$ 4,01



SALADEIRA PLAST PEQ S/TAMPA 15X6CM 1051

Código: 36960 Fábrica: ENGIPLAST Unidade: UN/1
F1 F4

UN: R\$ 2,64 AV: R\$ 2,64 15: R\$ 2,69
30: R\$ 2,75 45: R\$ 2,80 60: R\$ 2,86



SALEIRO CRISTAL P/MESA 700

Código: 37260 Fábrica: LUMAR Unidade: UN/1
F1 F4

UN: R\$ 9,88 AV: R\$ 9,88 15: R\$ 10,09
30: R\$ 10,29 45: R\$ 10,50 60: R\$ 10,71



SALEIRO PLAST GRANDE 366

Código: Fábrika: Unidade:
10174 TRITEC UN/1
F1 F4

UN: R\$ 2,53 AV: R\$ 2,53 15: R\$ 2,59
30: R\$ 2,64 45: R\$ 2,69 60: R\$ 2,74



SANDUICHEIRA REF 1315

Código: Fábrika: Unidade:
11029 PLASUTIL UN/1
F1 F4

UN: R\$ 10,26 AV: R\$ 10,26 15: R\$ 10,48
30: R\$ 10,69 45: R\$ 10,90 60: R\$ 11,12

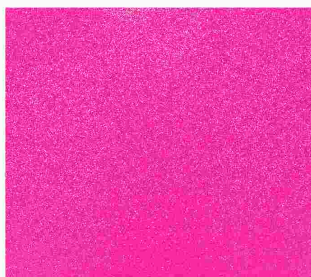

SELADORA PLAST 10X4CM PILHA AA 37-26

Código: Fábrika: Unidade:
46967 NICOBEM UN/1
F1 F4

UN: R\$ 2,46 AV: R\$ 61,62 15: R\$ 62,91
30: R\$ 64,16 45: R\$ 65,45 60: R\$ 66,76



SEMENTE ABOBORA HIROKO 550MG 25X1

Código: Fábrika: Unidade:
33984 FELTRIN PT/25
F1 F4

UN: R\$ 2,46 AV: R\$ 61,62 15: R\$ 62,91
30: R\$ 64,16 45: R\$ 65,45 60: R\$ 66,76

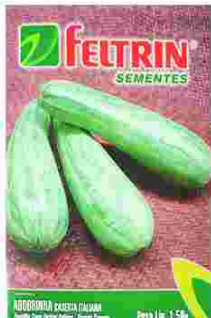

SEMENTE ABOBRINHA CASERT ITAL 1,50G 25X1

Código: Fábrika: Unidade:
31427 FELTRIN PT/25
F1 F4

UN: R\$ 2,46 AV: R\$ 61,62 15: R\$ 62,91
30: R\$ 64,16 45: R\$ 65,45 60: R\$ 66,76



SEMENTE ALFACE AMERICANA 700MG 25X1

Código: Fábrika: Unidade:
31435 FELTRIN PT/25
F1 F4

UN: R\$ 2,46 AV: R\$ 61,62 15: R\$ 62,91
30: R\$ 64,16 45: R\$ 65,45 60: R\$ 66,76



SEMENTE ALFACE MONICA 700MG 25X1

Código: Fábrika: Unidade:
31423 FELTRIN PT/25
F1 F4

UN: R\$ 2,46 AV: R\$ 61,62 15: R\$ 62,91
30: R\$ 64,16 45: R\$ 65,45 60: R\$ 66,76



SEMENTE ALMEIRAO PAO D ACUCAR 700MG 25X1

Código: Fábrika: Unidade:
31410 FELTRIN PT/25
F1 F4

UN: R\$ 2,46 AV: R\$ 61,62 15: R\$ 62,91
30: R\$ 64,16 45: R\$ 65,45 60: R\$ 66,76



SEMENTE BERINGELA EMBU 400MG 25X1

Código: Fábrika: Unidade:
32288 FELTRIN PT/25
F1 F4

UN: R\$ 2,46 AV: R\$ 61,62 15: R\$ 62,91
30: R\$ 64,16 45: R\$ 65,45 60: R\$ 66,76



SEMENTE BETERRABA KATRINA 1,20G 25X1

Código: Fábrika: Unidade:
31419 FELTRIN PT/25
F1 F4

UN: R\$ 2,46 AV: R\$ 61,62 15: R\$ 62,91
30: R\$ 64,16 45: R\$ 65,45 60: R\$ 66,76



SEMENTE CEBOLINHA NEBUKA 400MG 25X1

Código: Fábrika: Unidade:
31440 FELTRIN PT/25
F1 F4

UN: R\$ 2,46 AV: R\$ 61,62 15: R\$ 62,91
30: R\$ 64,16 45: R\$ 65,45 60: R\$ 66,76

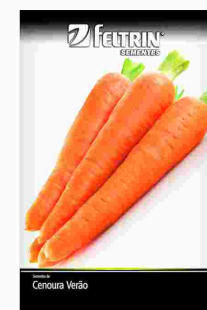

SEMENTE CENOURA BRASILIA IRECE 700G 25X1

Código: Fábrika: Unidade:
31413 FELTRIN PT/25
F1 F4

UN: R\$ 2,46 AV: R\$ 61,62 15: R\$ 62,91
30: R\$ 64,16 45: R\$ 65,45 60: R\$ 66,76



SEMENTE COENTRO PACIFICO 1,60G 25X1

Código: Fábrika: Unidade:
32283 FELTRIN PT/25
F1 F4

UN: R\$ 2,46 AV: R\$ 61,62 15: R\$ 62,91
30: R\$ 64,16 45: R\$ 65,45 60: R\$ 66,76



SEMENTE COENTRO VERDAO 1,6G 25X1

Código: Fábrika: Unidade:
31418 FELTRIN PT/25
F1 F4

UN: R\$ 2,46 AV: R\$ 61,62 15: R\$ 62,91
30: R\$ 64,16 45: R\$ 65,45 60: R\$ 66,76



SEMENTE COUVE MANTEIGA 1,00G 25X1

Código: Fábrika: Unidade:
31431 FELTRIN PT/25
F1 F4

UN: R\$ 2,46 AV: R\$ 61,62 15: R\$ 62,91
30: R\$ 64,16 45: R\$ 65,45 60: R\$ 66,76



SEMENTE JILO COMPRIDO GDE RIO 400MG 25X1

Código: Fábrika: Unidade:
32302 FELTRIN PT/25
F1 F4

UN: R\$ 2,46 AV: R\$ 61,62 15: R\$ 62,91
30: R\$ 64,16 45: R\$ 65,45 60: R\$ 66,76



SEMENTE MAMAO FORMOSA 120MG 25X1

Código: 31422 Fábrica: FELTRIN Unidade: PT/25 F1 F4

UN: R\$ 3,08 AV: R\$ 61,62 15: R\$ 62,91
30: R\$ 64,16 45: R\$ 65,45 60: R\$ 66,76



SEMENTE MELAO GAUCHO 100MG 20X1

Código: 32291 Fábrica: FELTRIN/HORT Unidade: PT/20 F1 F4

UN: R\$ 2,46 AV: R\$ 61,62 15: R\$ 62,91
30: R\$ 64,16 45: R\$ 65,45 60: R\$ 66,76



SEMENTE MORANGA EXPOSITAO 2,00G 25X1

Código: 31439 Fábrica: FELTRIN Unidade: PT/25 F1 F4

UN: R\$ 2,46 AV: R\$ 61,62 15: R\$ 62,91
30: R\$ 64,16 45: R\$ 65,45 60: R\$ 66,76



SEMENTE PIMENTA BICO 400MG 25X1

Código: 31429 Fábrica: FELTRIN Unidade: PT/25 F1 F4

UN: R\$ 2,46 AV: R\$ 61,62 15: R\$ 62,91
30: R\$ 64,16 45: R\$ 65,45 60: R\$ 66,76



SEMENTE PIMENTA CAYENNE LONG 400MG 25X1

Código: 32290 Fábrica: FELTRIN Unidade: PT/25 F1 F4

UN: R\$ 2,05 AV: R\$ 51,35 15: R\$ 52,42
30: R\$ 53,47 45: R\$ 54,54 60: R\$ 55,63



SEMENTE PIMENTA DEDO DE MOCA 400MG 25X1

Código: 49387 Fábrica: FELTRIN Unidade: PT/25 F1 F4

UN: R\$ 2,05 AV: R\$ 51,35 15: R\$ 52,42
30: R\$ 53,47 45: R\$ 54,54 60: R\$ 55,63



SEMENTE PIMENTAO AMARELO 400MG 25X1

Código: 49386 Fábrica: FELTRIN Unidade: PT/25 F1 F4

UN: R\$ 2,46 AV: R\$ 61,62 15: R\$ 62,91
30: R\$ 64,16 45: R\$ 65,45 60: R\$ 66,76



SEMENTE PIMENTAO RUBI GIGANTE 400MG 25X1

Código: 31412 Fábrica: FELTRIN Unidade: PT/25 F1 F4

UN: R\$ 2,46 AV: R\$ 61,62 15: R\$ 62,91
30: R\$ 64,16 45: R\$ 65,45 60: R\$ 66,76



SEMENTE QUIABO SANTA CRUZ 2,00G 25X1

Código: 31411 Fábrica: FELTRIN Unidade: PT/25 F1 F4

UN: R\$ 2,46 AV: R\$ 61,62 15: R\$ 62,91
30: R\$ 64,16 45: R\$ 65,45 60: R\$ 66,76



SEMENTE RABANETE CRIMSON GIG 1,40G 25X1

Código: 31432 Fábrica: FELTRIN Unidade: PT/25 F1 F4

UN: R\$ 2,46 AV: R\$ 61,62 15: R\$ 62,91
30: R\$ 64,16 45: R\$ 65,45 60: R\$ 66,76

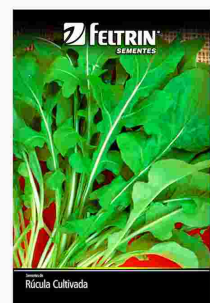

SEMENTE RUCULA CULTIVADA 1G 25X1

Código: 31424 Fábrica: FELTRIN Unidade: PT/25 F1 F4

UN: R\$ 2,46 AV: R\$ 61,62 15: R\$ 62,91
30: R\$ 64,16 45: R\$ 65,45 60: R\$ 66,76

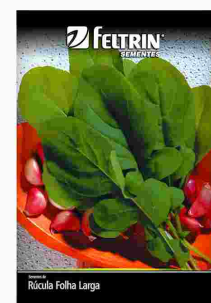

SEMENTE RUCULA FOLHA LARGA 700MG 25X1

Código: 32293 Fábrica: FELTRIN Unidade: PT/25 F1 F4

UN: R\$ 2,46 AV: R\$ 61,62 15: R\$ 62,91
30: R\$ 64,16 45: R\$ 65,45 60: R\$ 66,76



SEMENTE SALSA GRAUDA PORT NOV 900MG 25X1

Código: 31420 Fábrica: FELTRIN Unidade: PT/25 F1 F4

UN: R\$ 2,46 AV: R\$ 61,62 15: R\$ 62,91
30: R\$ 64,16 45: R\$ 65,45 60: R\$ 66,76



SEMENTE SALSA LISA 900MG 25X1

Código: 31434 Fábrica: FELTRIN Unidade: PT/25 F1 F4

UN: R\$ 2,46 AV: R\$ 61,62 15: R\$ 62,91
30: R\$ 64,16 45: R\$ 65,45 60: R\$ 66,76



SEMENTE TOMATE CAROLINA 100MG 25X1

Código: 31416 Fábrica: FELTRIN Unidade: PT/25 F1 F4

UN: R\$ 2,46 AV: R\$ 61,62 15: R\$ 62,91
30: R\$ 64,16 45: R\$ 65,45 60: R\$ 66,76



SEMENTE TOMATE YASHI 100MG 25X1

Código: 35086 Fábrica: FELTRIN Unidade: PT/25 F1 F4

UN: R\$ 6,15 AV: R\$ 6,15 15: R\$ 6,28
30: R\$ 6,41 45: R\$ 6,53 60: R\$ 6,67



SOCADOR FEIJAO 28 CM MADEIRA 115

Código: Fábrica: Unidade:
1485 MAD LAR UN/1
F1 F4

UN: R\$ 7,18 AV: R\$ 7,18 15: R\$ 7,33
30: R\$ 7,48 45: R\$ 7,63 60: R\$ 7,78



SOLO (SUBSTRATO) 2 KG

Código: Fábrica: Unidade:
31469 NOVATROPICAL PT/1
F1 F4

UN: R\$ 12,07 AV: R\$ 12,07 15: R\$ 12,32
30: R\$ 12,57 45: R\$ 12,82 60: R\$ 13,08



SOLO (SUBSTRATO) 5 KG

Código: Fábrica: Unidade:
31470 NOVATROPICAL PT/1
F1 F4

UN: R\$ 34,91 AV: R\$ 34,91 15: R\$ 35,64
30: R\$ 36,35 45: R\$ 37,08 60: R\$ 37,82



SOLO (SUBSTRATO) 20 KG

Código: Fábrica: Unidade:
31472 NOVATROPICAL PT/1
F1 F4

UN: R\$ 5,13 AV: R\$ 5,13 15: R\$ 5,23
30: R\$ 5,34 45: R\$ 5,44 60: R\$ 5,55

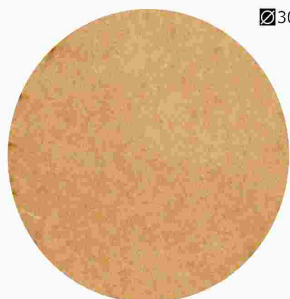

30cm

SOUPLA MDF 30CM 174

Código: Fábrica: Unidade:
45986 R A ARTESANA UN/1
F1 F4

UN: R\$ 5,43 AV: R\$ 5,43 15: R\$ 5,55
30: R\$ 5,66 45: R\$ 5,77 60: R\$ 5,89



SQUEEZE PLAST 300 ML (GALAOZINHO) 982

Código: Fábrica: Unidade:
49707 NOVA ERA UN/1
F1 F4

UN: R\$ 5,43 AV: R\$ 5,43 15: R\$ 5,55
30: R\$ 5,66 45: R\$ 5,77 60: R\$ 5,89



SQUEEZE PLAST 300 ML (GARRAFA) COLOR 972

Código: Fábrica: Unidade:
49719 NOVA ERA UN/1
F1 F4

UN: R\$ 4,22 AV: R\$ 4,22 15: R\$ 4,31
30: R\$ 4,40 45: R\$ 4,48 60: R\$ 4,57



SQUEEZE PLAST 350 ML 846

Código: Fábrica: Unidade:
35843 LUMAR UN/1
F1 F4

UN: R\$ 18,84 AV: R\$ 18,84 15: R\$ 19,23
30: R\$ 19,61 45: R\$ 20,01 60: R\$ 20,41



SQUEEZE PLAST 360ML REFIL FLAMENGO 10625

Código: Fábrica: Unidade:
41106 BRASFOOT UN/1
F1 F4

UN: R\$ 6,46 AV: R\$ 6,46 15: R\$ 6,60
30: R\$ 6,73 45: R\$ 6,86 60: R\$ 7,00



SQUEEZE PLAST 500 ML (GARRAFA) COLOR 962

Código: Fábrica: Unidade:
49712 NOVA ERA UN/1
F1 F4

UN: R\$ 6,56 AV: R\$ 6,56 15: R\$ 6,70
30: R\$ 6,83 45: R\$ 6,97 60: R\$ 7,11



SQUEEZE PLAST 600 ML (GARRAFA) QUAD 1199

Código: Fábrica: Unidade:
49706 NOVA ERA UN/1
F1 F4

UN: R\$ 6,56 AV: R\$ 6,56 15: R\$ 6,70
30: R\$ 6,83 45: R\$ 6,97 60: R\$ 7,11



SQUEEZE PLAST 750 ML (GARRAFA) COLOR 952

Código: Fábrica: Unidade:
49709 NOVA ERA UN/1
F1 F4

UN: R\$ 3,58 AV: R\$ 3,58 15: R\$ 3,66
30: R\$ 3,73 45: R\$ 3,81 60: R\$ 3,88



SQUEEZE 250 ML PLAST ARANHA 479

Código: Fábrica: Unidade:
41636 QUALYPLAS UN/1
F1 F4

UN: R\$ 3,58 AV: R\$ 3,58 15: R\$ 3,66
30: R\$ 3,73 45: R\$ 3,81 60: R\$ 3,88



SQUEEZE 250 ML PLAST COELHO 584

Código: Fábrica: Unidade:
41637 QUALYPLAS UN/1
F1 F4

UN: R\$ 3,58 AV: R\$ 3,58 15: R\$ 3,66
30: R\$ 3,73 45: R\$ 3,81 60: R\$ 3,88



SQUEEZE 250 ML PLAST DINOSSAURO 135/480

Código: Fábrica: Unidade:
41635 QUALYPLAS UN/1
F1 F4

UN: R\$ 3,58 AV: R\$ 3,58 15: R\$ 3,66
30: R\$ 3,73 45: R\$ 3,81 60: R\$ 3,88



SQUEEZE 250 ML PLAST DRAGAO 1202

Código: Fábrica: Unidade:
50341 QUALYPLAS UN/1
F1 F4

UN: R\$ 3,58 AV: R\$ 3,58 15: R\$ 3,66
30: R\$ 3,73 45: R\$ 3,81 60: R\$ 3,88



SQUEEZE 250 ML PLAST FROOZER 130/136
Código: Fábrica: Unidade:
41645 QUALYPLAS UN/1
F1 F4

UN: R\$ 3,58 AV: R\$ 3,58 15: R\$ 3,66
30: R\$ 3,73 45: R\$ 3,81 60: R\$ 3,88



SQUEEZE 250 ML PLAST PRINCESA 1142
Código: Fábrica: Unidade:
50340 QUALYPLAS UN/1
F1 F4

UN: R\$ 3,58 AV: R\$ 3,58 15: R\$ 3,66
30: R\$ 3,73 45: R\$ 3,81 60: R\$ 3,88



SQUEEZE 250 ML PLAST SEREIA 482
Código: Fábrica: Unidade:
41638 QUALYPLAS UN/1
F1 F4

UN: R\$ 3,58 AV: R\$ 3,58 15: R\$ 3,66
30: R\$ 3,73 45: R\$ 3,81 60: R\$ 3,88



SQUEEZE 250 ML PLAST TUBARAO 138/485
Código: Fábrica: Unidade:
41640 QUALYPLAS UN/1
F1 F4

UN: R\$ 3,58 AV: R\$ 3,58 15: R\$ 3,66
30: R\$ 3,73 45: R\$ 3,81 60: R\$ 3,88



SQUEEZE 250 ML PLAST UNICORNIO 483
Código: Fábrica: Unidade:
41639 QUALYPLAS UN/1
F1 F4

UN: R\$ 3,58 AV: R\$ 3,58 15: R\$ 3,66
30: R\$ 3,73 45: R\$ 3,81 60: R\$ 3,88



SQUEEZE 250 ML PLAST VIDEO GAME 1141
Código: Fábrica: Unidade:
50342 QUALYPLAS UN/1
F1 F4

UN: R\$ 7,76 AV: R\$ 7,76 15: R\$ 7,92
30: R\$ 8,08 45: R\$ 8,24 60: R\$ 8,40



SQUEEZE 600 ML PLAST NEON AZUL TPA CLICK
Código: Fábrica: Unidade:
49827 CREATIVE UN/1
F1 F4

UN: R\$ 7,76 AV: R\$ 7,76 15: R\$ 7,92
30: R\$ 8,08 45: R\$ 8,24 60: R\$ 8,40



SQUEEZE 600 ML PLAST NEON ROSA TPA CLICK
Código: Fábrica: Unidade:
49828 CREATIVE UN/1
F1 F4

UN: R\$ 7,45 AV: R\$ 7,45 15: R\$ 7,60
30: R\$ 7,75 45: R\$ 7,91 60: R\$ 8,07



SQUEEZE 700 ML PLAST DIAMANT FUME 22390
Código: Fábrica: Unidade:
49822 CREATIVE UN/1
F1 F4

UN: R\$ 7,45 AV: R\$ 7,45 15: R\$ 7,60
30: R\$ 7,75 45: R\$ 7,91 60: R\$ 8,07



SQUEEZE 700 ML PLAST DIAMANT TIFFAN 2391
Código: Fábrica: Unidade:
49823 CREATIVE UN/1
F1 F4

UN: R\$ 7,45 AV: R\$ 7,45 15: R\$ 7,60
30: R\$ 7,75 45: R\$ 7,91 60: R\$ 8,07



SQUEEZE 700 ML PLAST TOP TRANS FUME 2393
Código: Fábrica: Unidade:
49824 CREATIVE UN/1
F1 F4

UN: R\$ 7,45 AV: R\$ 7,45 15: R\$ 7,60
30: R\$ 7,75 45: R\$ 7,91 60: R\$ 8,07



SQUEEZE 700 ML PLAST TOP TRANS TIFFA 384
Código: Fábrica: Unidade:
49825 CREATIVE UN/1
F1 F4

UN: R\$ 7,45 AV: R\$ 7,45 15: R\$ 7,60
30: R\$ 7,75 45: R\$ 7,91 60: R\$ 8,07



SQUEEZE 700 ML PLAST TOP TRANS TPA COLOR
Código: Fábrica: Unidade:
49826 CREATIVE UN/1
F1 F4

UN: R\$ 22,24 AV: R\$ 22,24 15: R\$ 22,70
30: R\$ 23,16 45: R\$ 23,62 60: R\$ 24,09

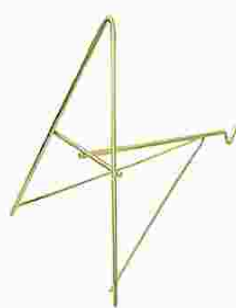

SUPORTE A MED METAL DOURADO P/PLANTAS
Código: Fábrica: Unidade:
18493 NUTRIPLAN UN/1
F1 F4

UN: R\$ 27,72 AV: R\$ 27,72 15: R\$ 28,30
30: R\$ 28,87 45: R\$ 29,45 60: R\$ 30,03

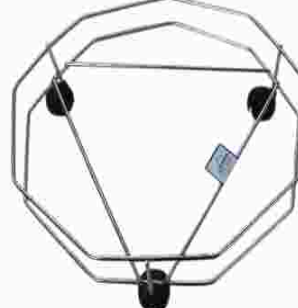

SUPORTE CROM BOTIJAO REFOR C/RODINHAS 21
Código: Fábrica: Unidade:
24069 ARAMINAS UN/1
F1 F4

UN: R\$ 39,02 AV: R\$ 39,02 15: R\$ 39,84
30: R\$ 40,63 45: R\$ 41,45 60: R\$ 42,27



SUPORTE CROM BOTIJAO TUBULAR C/ROD 799
Código: Fábrica: Unidade:
33634 ARAMINAS UN/1
F1 F4

UN: R\$ 24,21 AV: R\$ 24,21 15: R\$ 24,72
30: R\$ 25,21 45: R\$ 25,71 60: R\$ 26,23

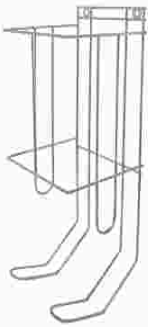

SUPORTE CROM P/PAPEL HIGIENICO 87

Código: Fábrika: Unidade:
28961 ARAMINAS UN/1
F1 F4

UN: R\$ 17,04 AV: R\$ 17,04 15: R\$ 17,40
30: R\$ 17,74 45: R\$ 18,10 60: R\$ 18,46



SUPORTE CROM P/PAPEL TOALHA DE MESA 89

Código: Fábrika: Unidade:
38982 ARAMINAS UN/1
F1 F4

UN: R\$ 29,48 AV: R\$ 29,48 15: R\$ 30,09
30: R\$ 30,70 45: R\$ 31,31 60: R\$ 31,94

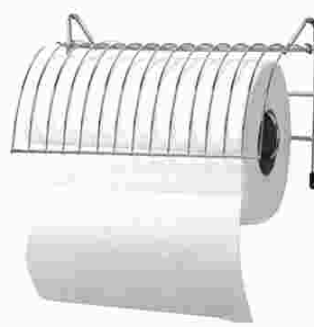

SUPORTE CROM P/PAPEL TOALHA PAREDE 22

Código: Fábrika: Unidade:
18739 ARAMINAS UN/1
F1 F4

UN: R\$ 46,99 AV: R\$ 46,99 15: R\$ 47,97
30: R\$ 48,93 45: R\$ 49,91 60: R\$ 50,91



SUPORTE CROM 20 COPOS PAREDE 52X30CM 28

Código: Fábrika: Unidade:
24068 ARAMINAS UN/1
F1 F4

Produto
* Altura: 52 cm
* Largura: 30 cm

UN: R\$ 41,22 AV: R\$ 41,22 15: R\$ 42,08
30: R\$ 42,92 45: R\$ 43,78 60: R\$ 44,66

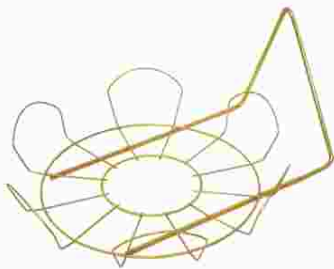

SUPORTE MARGARIDA MED DOURADO P/PLANTAS

Código: Fábrika: Unidade:
33397 NUTRIPLAN UN/1
F1 F4

UN: R\$ 129,58 AV: R\$ 129,58 15: R\$ 132,28
30: R\$ 134,92 45: R\$ 137,62 60: R\$ 140,37
30 cm



SUPORTE METAL RODIZIO PRATO 25CM PRETO

Código: Fábrika: Unidade:
42182 NUTRIPLAN UN/1
F1 F4

UN: R\$ 141,36 AV: R\$ 141,36 15: R\$ 144,30
30: R\$ 147,19 45: R\$ 150,13 60: R\$ 153,13
30 cm



SUPORTE METAL RODIZIO PRATO 28CM PRETO

Código: Fábrika: Unidade:
42179 NUTRIPLAN UN/1
F1 F4

UN: R\$ 149,60 AV: R\$ 149,60 15: R\$ 152,72
30: R\$ 155,77 45: R\$ 158,89 60: R\$ 162,07
30 cm



SUPORTE METAL RODIZIO PRATO 30CM PRETO

Código: Fábrika: Unidade:
42180 NUTRIPLAN UN/1
F1 F4

UN: R\$ 176,70 AV: R\$ 176,70 15: R\$ 180,38
30: R\$ 183,99 45: R\$ 187,67 60: R\$ 191,42
36 cm



SUPORTE METAL RODIZIO PRATO 36CM PRETO

Código: Fábrika: Unidade:
42181 NUTRIPLAN UN/1
F1 F4

UN: R\$ 11,75 AV: R\$ 11,75 15: R\$ 12,00
30: R\$ 12,24 45: R\$ 12,48 60: R\$ 12,73



SUPORTE OLEO PET 773

Código: Fábrika: Unidade:
44719 ARAMINAS UN/1
F1 F4

UN: R\$ 10,02 AV: R\$ 10,02 15: R\$ 10,22
30: R\$ 10,43 45: R\$ 10,64 60: R\$ 10,85



SUPORTE PLAST BOTIJAJO SB054

Código: Fábrika: Unidade:
45109 BUDEPLAST UN/1
F1 F4

UN: R\$ 7,49 AV: R\$ 7,49 15: R\$ 7,64
30: R\$ 7,80 45: R\$ 7,95 60: R\$ 8,11



SUPORTE PLAST BOTIJAJO 760

Código: Fábrika: Unidade:
46631 LUMAR UN/1
F1 F4

UN: R\$ 6,32 AV: R\$ 6,32 15: R\$ 6,45
30: R\$ 6,58 45: R\$ 6,71 60: R\$ 6,84



SUPORTE PLAST FILTRO CAFE 103 6920

Código: Fábrika: Unidade:
47145 INPLAST UN/1
F1 F4

UN: R\$ 10,00 AV: R\$ 10,00 15: R\$ 10,21
30: R\$ 10,41 45: R\$ 10,62 60: R\$ 10,84



SUPORTE PLAST P/BOTIJAJO PRETO 91

Código: Fábrika: Unidade:
22450 MOLDE MINAS UN/1
F1 F4

UN: R\$ 2,98 AV: R\$ 2,98 15: R\$ 3,04
30: R\$ 3,10 45: R\$ 3,16 60: R\$ 3,23



SUPORTE PLAST P/CAIXA SABAO EM PO 4418

Código: Fábrika: Unidade:
10396 NITRON UN/1
F1 F4

UN: R\$ 51,35 AV: R\$ 51,35 15: R\$ 52,42
30: R\$ 53,47 45: R\$ 54,54 60: R\$ 55,63



SUPORTE PLAST P/GARRAFAO AGUA

Código: Fábrika: Unidade:
50368 HERC UN/1
F1 F4

UN: R\$ 4,62 AV: R\$ 4,62 15: R\$ 4,72
30: R\$ 4,81 45: R\$ 4,91 60: R\$ 5,01



SUPORTE PLASTICO P/QUADRO CRISTAL 19 CM
Código: Fábrika: Unidade:
31482 YING FA UN/1
F1 F4

UN: R\$ 5,86 AV: R\$ 5,86 15: R\$ 5,98
30: R\$ 6,10 45: R\$ 6,22 60: R\$ 6,34

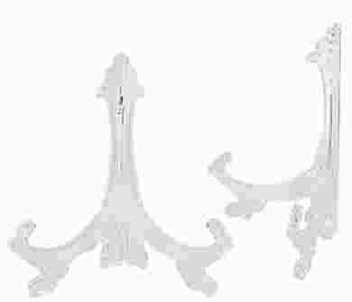

SUPORTE PLASTICO P/QUADRO CRISTAL 21 CM
Código: Fábrika: Unidade:
31483 YING FA UN/1
F1 F4

UN: R\$ 41,09 AV: R\$ 41,09 15: R\$ 41,94
30: R\$ 42,78 45: R\$ 43,64 60: R\$ 44,51



SUQUEIRA VIDRO 3,0 LTS 3182
Código: Fábrika: Unidade:
34816 BATIKI UN/1
F1 F4

UN: R\$ 19,51 AV: R\$ 19,51 15: R\$ 19,91
30: R\$ 20,31 45: R\$ 20,72 60: R\$ 21,13



TABUA MAD HAMBURGUER NATURAL 20X19CM 48B
Código: Fábrika: Unidade:
41740 DEBIASI UN/1
F1 F4

UN: R\$ 20,53 AV: R\$ 20,53 15: R\$ 20,96
30: R\$ 21,38 45: R\$ 21,81 60: R\$ 22,24



TABUA MAD RED PETISCO NATURAL 20CM
Código: Fábrika: Unidade:
41741 DEBIASI UN/1
F1 F4

UN: R\$ 19,51 AV: R\$ 19,51 15: R\$ 19,91
30: R\$ 20,31 45: R\$ 20,72 60: R\$ 21,13



TABUA MAD RED P/FRIOS 25CM 57B
Código: Fábrika: Unidade:
41742 DEBIASI UN/1
F1 F4

UN: R\$ 32,86 AV: R\$ 32,86 15: R\$ 33,54
30: R\$ 34,22 45: R\$ 34,90 60: R\$ 35,60



TABUA MAD RED P/FRIOS C/GARF 25CM 57E
Código: Fábrika: Unidade:
41743 DEBIASI UN/1
F1 F4

UN: R\$ 34,91 AV: R\$ 34,91 15: R\$ 35,64
30: R\$ 36,35 45: R\$ 37,08 60: R\$ 37,82



TABUA PETISQUEIRA ACRÍ PTO 25CM
Código: Fábrika: Unidade:
41744 DEBIASI UN/1
F1 F4

UN: R\$ 4,07 AV: R\$ 4,07 15: R\$ 4,15
30: R\$ 4,24 45: R\$ 4,32 60: R\$ 4,41



TABUA PLAST COLOR 31X18CM 611
Código: Fábrika: Unidade:
41634 QALYPLAS UN/1
F1 F4

UN: R\$ 25,67 AV: R\$ 25,67 15: R\$ 26,20
30: R\$ 26,73 45: R\$ 27,26 60: R\$ 27,81



TABUA PLAST DE CORTE 320X220X4MM P 3050
Código: Fábrika: Unidade:
46243 JAGUAR UN/1
F1 F4

UN: R\$ 35,94 AV: R\$ 35,94 15: R\$ 36,69
30: R\$ 37,42 45: R\$ 38,17 60: R\$ 38,94



TABUA PLAST DE CORTE 35X24X07CM CA08104
Código: Fábrika: Unidade:
50644 CASITA UN/1
F1 F4

UN: R\$ 41,08 AV: R\$ 41,08 15: R\$ 41,93
30: R\$ 42,77 45: R\$ 43,63 60: R\$ 44,50



TABUA PLAST DE CORTE 360X260X6MM G 3051
Código: Fábrika: Unidade:
49219 JAGUAR UN/1
F1 F4

UN: R\$ 23,62 AV: R\$ 23,62 15: R\$ 24,11
30: R\$ 24,59 45: R\$ 25,08 60: R\$ 25,58



TABUA PLAST DE CORTE 37X23CM 001
Código: Fábrika: Unidade:
11000 RIOHOME UN/1
F1 F4

UN: R\$ 33,63 AV: R\$ 33,63 15: R\$ 34,33
30: R\$ 35,02 45: R\$ 35,72 60: R\$ 36,43



TABUA PLAST MEGA 969
Código: Fábrika: Unidade:
46669 LUMAR UN/1
F1 F4

UN: R\$ 21,45 AV: R\$ 21,45 15: R\$ 21,89
30: R\$ 22,33 45: R\$ 22,78 60: R\$ 23,23



TABUA PLAST P/CARNE 36X21X0,5CM 514
Código: Fábrika: Unidade:
33034 TRITEC UN/1
F1 F4

UN: R\$ 9,86 AV: R\$ 9,86 15: R\$ 10,17
30: R\$ 10,48 45: R\$ 10,79 60: R\$ 11,11



TABUA PLASTICA 33X20CM
Código: Fábrika: Unidade:
28706 PLASTBRASIL UN/1
F1 F4

UN: R\$ 24,95 AV: R\$ 24,95 15: R\$ 25,47
30: R\$ 25,98 45: R\$ 26,50 60: R\$ 27,03



TABULEIRO ALUM 1 ALTO 710

Código: 8256 Fábrica: MSR Unidade: UN/1
F1 F4

UN: R\$ 20,49 AV: R\$ 20,49 15: R\$ 20,92
30: R\$ 21,34 45: R\$ 21,76 60: R\$ 22,20



TABULEIRO ALUM 1 PADRAO 30X21X3,0CM 715

Código: 22790 Fábrica: MSR Unidade: UN/1
F1 F4

UN: R\$ 23,62 AV: R\$ 23,62 15: R\$ 24,11
30: R\$ 24,59 45: R\$ 25,08 60: R\$ 25,58



TABULEIRO ALUM 1 RET EXTRA 30X20X4,0CM

Código: 27599 Fábrica: AVELAR Unidade: UN/1
F1 F4

UN: R\$ 29,94 AV: R\$ 29,94 15: R\$ 30,57
30: R\$ 31,18 45: R\$ 31,80 60: R\$ 32,44



TABULEIRO ALUM 2 ALTO 711

Código: 7908 Fábrica: MSR Unidade: UN/1
F1 F4

UN: R\$ 20,53 AV: R\$ 20,53 15: R\$ 20,96
30: R\$ 21,38 45: R\$ 21,81 60: R\$ 22,24



TABULEIRO ALUM 2 PADRAO 33X23X3,0CM 716

Código: 8257 Fábrica: MSR Unidade: UN/1
F1 F4

UN: R\$ 28,75 AV: R\$ 28,75 15: R\$ 29,35
30: R\$ 29,94 45: R\$ 30,54 60: R\$ 31,15



TABULEIRO ALUM 2 RET EXTRA 33X23X4,0CM

Código: 22791 Fábrica: AVELAR Unidade: UN/1
F1 F4

UN: R\$ 35,94 AV: R\$ 35,94 15: R\$ 36,69
30: R\$ 37,42 45: R\$ 38,17 60: R\$ 38,94



TABULEIRO ALUM 3 ALTO 712

Código: 7909 Fábrica: MSR Unidade: UN/1
F1 F4

UN: R\$ 31,83 AV: R\$ 31,83 15: R\$ 32,50
30: R\$ 33,15 45: R\$ 33,81 60: R\$ 34,49



TABULEIRO ALUM 3 PADRAO 40X30X3,5CM 717

Código: 22792 Fábrica: MSR Unidade: UN/1
F1 F4

UN: R\$ 30,81 AV: R\$ 30,81 15: R\$ 31,45
30: R\$ 32,08 45: R\$ 32,72 60: R\$ 33,37



TABULEIRO ALUM 3 RET EXTRA 37X26X4,0CM

Código: 27601 Fábrica: AVELAR Unidade: UN/1
F1 F4

UN: R\$ 50,32 AV: R\$ 50,32 15: R\$ 51,37
30: R\$ 52,40 45: R\$ 53,45 60: R\$ 54,52



TABULEIRO ALUM 4 ALTO 713 ASSAD 42X29X6

Código: 7911 Fábrica: MSR Unidade: UN/1
F1 F4

UN: R\$ 45,19 AV: R\$ 45,19 15: R\$ 46,13
30: R\$ 47,05 45: R\$ 47,99 60: R\$ 48,95



TABULEIRO ALUM 4 PADRAO 45X33X4,0CM 718

Código: 22793 Fábrica: MSR Unidade: UN/1
F1 F4

UN: R\$ 44,16 AV: R\$ 44,16 15: R\$ 45,08
30: R\$ 45,98 45: R\$ 46,90 60: R\$ 47,84



TABULEIRO ALUM 4 RET EXTRA 42X30X4,0CM

Código: 27602 Fábrica: AVELAR Unidade: UN/1
F1 F4

UN: R\$ 61,62 AV: R\$ 61,62 15: R\$ 62,91
30: R\$ 64,16 45: R\$ 65,45 60: R\$ 66,76



TABULEIRO ALUM 5 ALTO 714

Código: 11262 Fábrica: MSR Unidade: UN/1
F1 F4

UN: R\$ 55,46 AV: R\$ 55,46 15: R\$ 56,61
30: R\$ 57,75 45: R\$ 58,90 60: R\$ 60,08



TABULEIRO ALUM 5 PADRAO 48X35X4,5CM 719

Código: 22794 Fábrica: MSR Unidade: UN/1
F1 F4

UN: R\$ 51,35 AV: R\$ 51,35 15: R\$ 52,42
30: R\$ 53,47 45: R\$ 54,54 60: R\$ 55,63



TABULEIRO ALUM 5 RET EXTRA 46X33X4,0CM

Código: 27603 Fábrica: AVELAR Unidade: UN/1
F1 F4

UN: R\$ 3,34 AV: R\$ 3,34 15: R\$ 3,41
30: R\$ 3,48 45: R\$ 3,55 60: R\$ 3,62



TACA ACRILICO 190ML CHAMPANHE CRISTAL 14

Código: 50344 Fábrica: QUALYPLAS Unidade: UN/1
F1 F4

UN: R\$ 17,67 AV: R\$ 35,33 15: R\$ 36,07
30: R\$ 36,79 45: R\$ 37,52 60: R\$ 38,27



TACA PLAST 360ML GIN BICOLOR VC11327 2X1
Código: Fábrika: Unidade:
41130 BRASFOOT CJ/2
F1 F4

UN: R\$ 22,38 AV: R\$ 44,75 15: R\$ 45,69
30: R\$ 46,60 45: R\$ 47,53 60: R\$ 48,48



TACA PLAST 580ML DEGRADE GIN 10565 2X1
Código: Fábrika: Unidade:
39133 BRASFOOT CJ/2
F1 F4

UN: R\$ 22,38 AV: R\$ 44,75 15: R\$ 45,69
30: R\$ 46,60 45: R\$ 47,53 60: R\$ 48,48



TACA PLAST 580ML DEGRADE GIN 10570 2X1
Código: Fábrika: Unidade:
39134 BRASFOOT CJ/2
F1 F4

UN: R\$ 35,33 AV: R\$ 35,33 15: R\$ 36,07
30: R\$ 36,79 45: R\$ 37,52 60: R\$ 38,27



TACA PLAST 580ML GIN ATLETICO 10800 2X1
Código: Fábrika: Unidade:
41128 BRASFOOT UN/1
F1 F4

UN: R\$ 17,67 AV: R\$ 35,33 15: R\$ 36,07
30: R\$ 36,79 45: R\$ 37,52 60: R\$ 38,27



TACA PLAST 580ML GIN FLAMENGO 10801 2X1
Código: Fábrika: Unidade:
41129 BRASFOOT CJ/2
F1 F4

UN: R\$ 2,47 AV: R\$ 2,47 15: R\$ 2,53
30: R\$ 2,58 45: R\$ 2,63 60: R\$ 2,68



TACA PLASTICO COPACABANA GDE 073
Código: Fábrika: Unidade:
27699 HEMITOYS UN/1
F1 F4

UN: R\$ 16,44 AV: R\$ 16,44 15: R\$ 16,78
30: R\$ 17,11 45: R\$ 17,46 60: R\$ 17,80



TACA VIDRO 300ML CERVEJA COLECCION 524093
Código: Fábrika: Unidade:
39258 FRATELLI UN/1
F1 F4

UN: R\$ 25,67 AV: R\$ 25,67 15: R\$ 26,20
30: R\$ 26,73 45: R\$ 27,26 60: R\$ 27,81



TACA VIDRO 300ML WINDSOR AGRADEÇA 2611
Código: Fábrika: Unidade:
39034 BRASFOOT UN/1
F1 F4

UN: R\$ 25,67 AV: R\$ 25,67 15: R\$ 26,20
30: R\$ 26,73 45: R\$ 27,26 60: R\$ 27,81



TACA VIDRO 300ML WINDSOR BEBO PRA E 2612
Código: Fábrika: Unidade:
39031 BRASFOOT UN/1
F1 F4

UN: R\$ 25,67 AV: R\$ 25,67 15: R\$ 26,20
30: R\$ 26,73 45: R\$ 27,26 60: R\$ 27,81



TACA VIDRO 300ML WINDSOR E MELHOR U 2613
Código: Fábrika: Unidade:
39033 BRASFOOT UN/1
F1 F4

UN: R\$ 33,89 AV: R\$ 33,89 15: R\$ 34,59
30: R\$ 35,29 45: R\$ 35,99 60: R\$ 36,71



TACA VIDRO 300ML WINDSOR FLAMENGO 1551
Código: Fábrika: Unidade:
39026 BRASFOOT UN/1
F1 F4

UN: R\$ 33,89 AV: R\$ 33,89 15: R\$ 34,59
30: R\$ 35,29 45: R\$ 35,99 60: R\$ 36,71



TACA VIDRO 300ML WINDSOR FLAMENGO 2661
Código: Fábrika: Unidade:
39030 BRASFOOT UN/1
F1 F4

UN: R\$ 25,67 AV: R\$ 25,67 15: R\$ 26,20
30: R\$ 26,73 45: R\$ 27,26 60: R\$ 27,81



TACA VIDRO 300ML WINDSOR QUEM BEBE 2610
Código: Fábrika: Unidade:
39032 BRASFOOT UN/1
F1 F4

UN: R\$ 28,76 AV: R\$ 57,51 15: R\$ 58,71
30: R\$ 59,89 45: R\$ 61,08 60: R\$ 62,30



TACA VIDRO 330ML WINDSOR ADORO 11597 2X1
Código: Fábrika: Unidade:
41115 BRASFOOT CJ/2
F1 F4

UN: R\$ 30,81 AV: R\$ 30,81 15: R\$ 31,45
30: R\$ 32,08 45: R\$ 32,72 60: R\$ 33,37



TACA VIDRO 330ML WINDSOR ADORO 11600
Código: Fábrika: Unidade:
41117 BRASFOOT UN/1
F1 F4

UN: R\$ 76,00 AV: R\$ 76,00 15: R\$ 77,59
30: R\$ 79,14 45: R\$ 80,72 60: R\$ 82,33



TACA VIDRO 330ML+AVENTAL ATLETICO 10000
Código: Fábrika: Unidade:
41114 BRASFOOT UN/1
F1 F4

UN: R\$ 76,00 AV: R\$ 76,00 15: R\$ 77,59
30: R\$ 79,14 45: R\$ 80,72 60: R\$ 82,33



TACA VIDRO 330ML+AVENTAL CRUZEIRO 10001

Código: Fábrika: Unidade:
41113 BRASFOOT UN/1
F1 F4

UN: R\$ 31,83 AV: R\$ 31,83 15: R\$ 32,50
30: R\$ 33,15 45: R\$ 33,81 60: R\$ 34,49

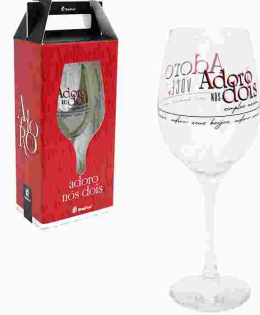

TACA VIDRO 385ML VINHO ADORO 11609

Código: Fábrika: Unidade:
41118 BRASFOOT UN/1
F1 F4

UN: R\$ 4,73 AV: R\$ 28,35 15: R\$ 28,94
30: R\$ 29,52 45: R\$ 30,11 60: R\$ 30,71



TACA VIDRO 40ML TRANSP 23353 6X1

Código: Fábrika: Unidade:
36756 MABEL CX/6
F1 F4

UN: R\$ 4,73 AV: R\$ 28,35 15: R\$ 28,94
30: R\$ 29,52 45: R\$ 30,11 60: R\$ 30,71



TACA VIDRO 40ML TRANSP 23354 6X1

Código: Fábrika: Unidade:
36757 MABEL CX/6
F1 F4

UN: R\$ 41,08 AV: R\$ 41,08 15: R\$ 41,93
30: R\$ 42,77 45: R\$ 43,63 60: R\$ 44,50



TACA VIDRO 400ML DUBLIN ATLETICO 10451

Código: Fábrika: Unidade:
39109 BRASFOOT UN/1
F1 F4

UN: R\$ 41,08 AV: R\$ 41,08 15: R\$ 41,93
30: R\$ 42,77 45: R\$ 43,63 60: R\$ 44,50



TACA VIDRO 400ML DUBLIN FLAMENGO 10453

Código: Fábrika: Unidade:
39023 BRASFOOT UN/1
F1 F4

UN: R\$ 0,45 AV: R\$ 45,19 15: R\$ 46,13
30: R\$ 47,05 45: R\$ 47,99 60: R\$ 48,95



TAMPA PLAST P/LAVATORIO PIA TV51N 100X1

Código: Fábrika: Unidade:
33734 REBOUCAS PT/100
F1 F4

UN: R\$ 0,60 AV: R\$ 59,57 15: R\$ 60,81
30: R\$ 62,02 45: R\$ 63,27 60: R\$ 64,53



TAMPA PLAST P/TANQUE TV52N 100X1

Código: Fábrika: Unidade:
33733 REBOUCAS PT/100
F1 F4

UN: R\$ 13,49 AV: R\$ 13,49 15: R\$ 13,77
30: R\$ 14,05 45: R\$ 14,33 60: R\$ 14,61



TAPETE ANTID BANHEIRO BCO 66X36CM 619

Código: Fábrika: Unidade:
44508 PLANETA UN/1
F1 F4

UN: R\$ 13,49 AV: R\$ 13,49 15: R\$ 13,77
30: R\$ 14,05 45: R\$ 14,33 60: R\$ 14,61



TAPETE ANTID BANHEIRO TRANSP 66X36CM 625

Código: Fábrika: Unidade:
44509 PLANETA UN/1
F1 F4

UN: R\$ 15,30 AV: R\$ 15,30 15: R\$ 15,62
30: R\$ 15,93 45: R\$ 16,25 60: R\$ 16,58



TAPETE ANTID BOX TRANSP 65X35CM 7692

Código: Fábrika: Unidade:
47360 ALTHOME UN/1
F1 F4

UN: R\$ 26,70 AV: R\$ 26,70 15: R\$ 27,25
30: R\$ 27,80 45: R\$ 28,35 60: R\$ 28,92

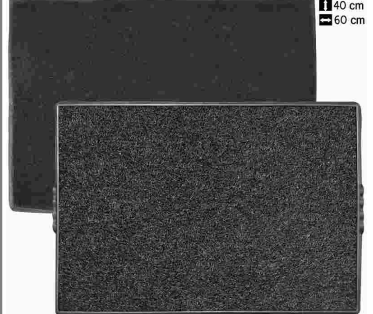

TAPETE BALME 40X60CM CORES 091

Código: Fábrika: Unidade:
36935 RIOHOME UN/1
F1 F4

UN: R\$ 40,05 AV: R\$ 40,05 15: R\$ 40,88
30: R\$ 41,70 45: R\$ 42,54 60: R\$ 43,39



TAPETE FIBRA COCO BORRACHA 40X60CM 088

Código: Fábrika: Unidade:
49365 RIOHOME UN/1
F1 F4

UN: R\$ 24,64 AV: R\$ 24,64 15: R\$ 25,16
30: R\$ 25,66 45: R\$ 26,17 60: R\$ 26,70



TAPETE MICROFIBRA ANTIDER 38X58CM 064

Código: Fábrika: Unidade:
49363 RIOHOME UN/1
F1 F4

UN: R\$ 23,62 AV: R\$ 23,62 15: R\$ 24,11
30: R\$ 24,59 45: R\$ 25,08 60: R\$ 25,58



TAPETE MICROFIBRA 38X58CM SOFT BALL 027

Código: Fábrika: Unidade:
49364 RIOHOME UN/1
F1 F4

UN: R\$ 14,53 AV: R\$ 14,53 15: R\$ 14,83
30: R\$ 15,12 45: R\$ 15,43 60: R\$ 15,74



TAPETE POLIESTER BEM VINDO 37X57CM 11611

Código: Fábrika: Unidade:
44515 NICOBEM UN/1
F1 F4

UN: R\$ 12,32 AV: R\$ 12,32 15: R\$ 12,57
30: R\$ 12,82 45: R\$ 13,08 60: R\$ 13,34



TAPETE POLIESTER BEM VINDO 37X57CM 2167
Código: Fábrica: Unidade:
47094 GP6 UN/1
F1 F4

UN: R\$ 13,04 AV: R\$ 13,04 15: R\$ 13,31
30: R\$ 13,57 45: R\$ 13,84 60: R\$ 14,12



TAPETE POP POLIESTER ANTIDERRAP 59X39CM
Código: Fábrica: Unidade:
39967 PERFETTO RL/1
F1 F4

UN: R\$ 19,51 AV: R\$ 19,51 15: R\$ 19,91
30: R\$ 20,31 45: R\$ 20,72 60: R\$ 21,13



TAPETE PVC ANTID BOX CORUJA 67X35CM 4048
Código: Fábrica: Unidade:
47897 CASITA UN/1
F1 F4

UN: R\$ 19,51 AV: R\$ 19,51 15: R\$ 19,91
30: R\$ 20,31 45: R\$ 20,72 60: R\$ 21,13



TAPETE PVC/FLAN BANH CORUJA 40X60CM 4046
Código: Fábrica: Unidade:
47898 CASITA UN/1
F1 F4

UN: R\$ 16,48 AV: R\$ 16,48 15: R\$ 16,82
30: R\$ 17,16 45: R\$ 17,50 60: R\$ 17,85

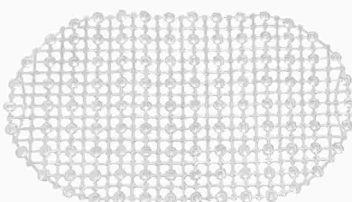

TAPETE SILIC ANTID BANHEIRO 62X35CM 7040
Código: Fábrica: Unidade:
41536 ELITE UN/1
F1 F4

UN: R\$ 1,59 AV: R\$ 79,61 15: R\$ 81,27
30: R\$ 82,89 45: R\$ 84,55 60: R\$ 86,24



TEE 1/2 ACOPLAR MANGUEIRA PTO TE51N 50X1
Código: Fábrica: Unidade:
40149 REBOUCAS PT/50
F1 F4

UN: R\$ 2,67 AV: R\$ 133,53 15: R\$ 136,31
30: R\$ 139,03 45: R\$ 141,81 60: R\$ 144,65



TEE 3/4 ACOPLAR MANGUEIRA PTO TE52N 50X1
Código: Fábrica: Unidade:
40150 REBOUCAS PT/50
F1 F4

UN: R\$ 20,53 AV: R\$ 20,53 15: R\$ 20,96
30: R\$ 21,38 45: R\$ 21,81 60: R\$ 22,24



TERRA ESP P/CACTOS E SUCULENTAS 1,5 KG
Código: Fábrica: Unidade:
35708 NUTRIPLAN PT/1
F1 F4

UN: R\$ 8,00 AV: R\$ 8,00 15: R\$ 8,17
30: R\$ 8,33 45: R\$ 8,50 60: R\$ 8,67



TERRA ORQUIDEA 1 LITRO
Código: Fábrica: Unidade:
48526 NOVATROPICAL PT/1
F1 F4

UN: R\$ 8,21 AV: R\$ 8,21 15: R\$ 8,38
30: R\$ 8,55 45: R\$ 8,72 60: R\$ 8,89



TERRA SAMAMBAIA 1 LITRO
Código: Fábrica: Unidade:
48527 NOVATROPICAL PT/1
F1 F4

UN: R\$ 14,67 AV: R\$ 14,67 15: R\$ 14,97
30: R\$ 15,27 45: R\$ 15,58 60: R\$ 15,89



TERRA SAMAMBAIA 1,5 KG
Código: Fábrica: Unidade:
22287 VITAPLAN PT/1
F1 F4

UN: R\$ 16,62 AV: R\$ 16,62 15: R\$ 16,97
30: R\$ 17,31 45: R\$ 17,65 60: R\$ 18,00



TERRA SAMAMBAIA 2 KG
Código: Fábrica: Unidade:
47464 VITAPLAN KG/1
F1 F4

UN: R\$ 5,02 AV: R\$ 5,02 15: R\$ 5,13
30: R\$ 5,23 45: R\$ 5,33 60: R\$ 5,44

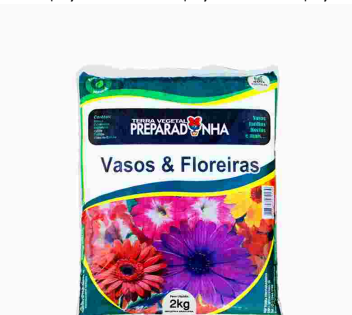

TERRA VEGETAL 2 KG
Código: Fábrica: Unidade:
19888 NOVATROPICAL PT/1
F1 F4

UN: R\$ 10,12 AV: R\$ 10,12 15: R\$ 10,33
30: R\$ 10,54 45: R\$ 10,75 60: R\$ 10,96

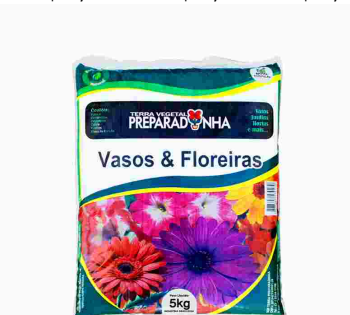

TERRA VEGETAL 5 KG
Código: Fábrica: Unidade:
19889 NOVATROPICAL PT/1
F1 F4

UN: R\$ 17,72 AV: R\$ 17,72 15: R\$ 18,09
30: R\$ 18,45 45: R\$ 18,82 60: R\$ 19,20



TERRA VEGETAL 10 KG
Código: Fábrica: Unidade:
30504 NOVATROPICAL PT/1
F1 F4

UN: R\$ 30,30 AV: R\$ 30,30 15: R\$ 30,93
30: R\$ 31,55 45: R\$ 32,18 60: R\$ 32,83



TERRA VEGETAL 20 KG
Código: Fábrica: Unidade:
30765 NOVATROPICAL PT/1
F1 F4

UN: R\$ 38,00 AV: R\$ 38,00 15: R\$ 38,79
30: R\$ 39,56 45: R\$ 40,35 60: R\$ 41,16



TERRA VEGETAL 25 KG
Código: 47378 Fábrica: NOVATROPICAL Unidade: PT/1 F1 F4

UN: R\$ 23,55 AV: R\$ 23,55 15: R\$ 24,04
30: R\$ 24,52 45: R\$ 25,01 60: R\$ 25,51



TIGELA ACRILIC BOWL C/TAMPA COLOR 33127
Código: 41214 Fábrica: PLASTSU Unidade: UN/1 F1 F4

UN: R\$ 17,98 AV: R\$ 17,98 15: R\$ 18,35
30: R\$ 18,72 45: R\$ 19,09 60: R\$ 19,47



TIGELA ALUM 20 1197
Código: 45284 Fábrica: MSR Unidade: UN/1 F1 F4

UN: R\$ 2,93 AV: R\$ 2,93 15: R\$ 2,99
30: R\$ 3,05 45: R\$ 3,12 60: R\$ 3,18



TIGELA PLASTICA BOWL 350 ML 115
Código: 14583 Fábrica: ECOPLASTIC Unidade: UN/1 F1 F4

UN: R\$ 9,50 AV: R\$ 228,04 15: R\$ 232,79
30: R\$ 237,45 45: R\$ 242,19 60: R\$ 247,04

12,5 cm
10,5 cm
620 ml



TIGELA VIDRO 620ML PREMIERE 1067 24X1
Código: 39522 Fábrica: MULTIPRESENT Unidade: CX/24 F1 F4

UN: R\$ 35,92 AV: R\$ 35,92 15: R\$ 36,67
30: R\$ 37,40 45: R\$ 38,15 60: R\$ 38,91



TOALHA BANHO PROF 1,30X70XM BRANCA
Código: 47342 Fábrica: MARCOTEX Unidade: UN/1 F1 F4

UN: R\$ 4,71 AV: R\$ 56,50 15: R\$ 57,67
30: R\$ 58,83 45: R\$ 60,00 60: R\$ 61,20



TOALHA LAVABO SLIM 45X29CM AMARELO 12X1
Código: 47661 Fábrica: MARCOTEX Unidade: PT/12 F1 F4

UN: R\$ 9,42 AV: R\$ 56,50 15: R\$ 57,67
30: R\$ 58,83 45: R\$ 60,00 60: R\$ 61,20

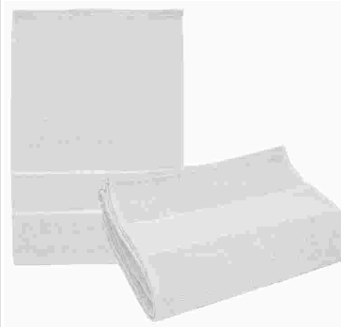

TOALHA LAVABO SLIM 45X29CM BRANCO 6X1
Código: 47654 Fábrica: MARCOTEX Unidade: PT/6 F1 F4

UN: R\$ 4,71 AV: R\$ 56,50 15: R\$ 57,67
30: R\$ 58,83 45: R\$ 60,00 60: R\$ 61,20



TOALHA LAVABO SLIM 45X29CM LARANJA 6X1
Código: 47660 Fábrica: MARCOTEX Unidade: PT/12 F1 F4

UN: R\$ 4,71 AV: R\$ 56,50 15: R\$ 57,67
30: R\$ 58,83 45: R\$ 60,00 60: R\$ 61,20



TOALHA LAVABO SLIM 45X29CM ROSA FLOR12X1
Código: 47657 Fábrica: MARCOTEX Unidade: PT/12 F1 F4

UN: R\$ 22,80 AV: R\$ 22,80 15: R\$ 23,28
30: R\$ 23,74 45: R\$ 24,22 60: R\$ 24,70

1,48m 1,50m



TOALHA MESA PANO 1,48X1,50M LISA 1101
Código: 40444 Fábrica: SUN WELLS Unidade: UN/1 F1 F4

UN: R\$ 33,90 AV: R\$ 33,90 15: R\$ 34,60
30: R\$ 35,30 45: R\$ 36,00 60: R\$ 36,72

1,48m 1,50m



TOALHA MESA PANO 1,48X1,50M NATAL
Código: 40446 Fábrica: SUN WELLS Unidade: UN/1 F1 F4

UN: R\$ 45,41 AV: R\$ 45,41 15: R\$ 46,36
30: R\$ 47,29 45: R\$ 48,23 60: R\$ 49,20

1,50m 2,20m



TOALHA MESA PANO 2,20X1,50M ESTAMP
Código: 40447 Fábrica: SUN WELLS Unidade: UN/1 F1 F4

UN: R\$ 4,62 AV: R\$ 4,62 15: R\$ 4,72
30: R\$ 4,81 45: R\$ 4,91 60: R\$ 5,01



TOALHA MULTIUSO MICROFIBRA 30X30CM 163
Código: 50790 Fábrica: HOME&MORE Unidade: UN/1 F1 F4

UN: R\$ 3,01 AV: R\$ 36,16 15: R\$ 36,91
30: R\$ 37,65 45: R\$ 38,40 60: R\$ 39,17



TOALHA SOCIAL LISA 36X23CM BRANCO 12X1
Código: 47668 Fábrica: MARCOTEX Unidade: PT/12 F1 F4

UN: R\$ 2,78 AV: R\$ 33,38 15: R\$ 34,08
30: R\$ 34,76 45: R\$ 35,46 60: R\$ 36,17



TOALHA SOCIAL LISA 36X23CM PRETO 12X1
Código: 47669 Fábrica: MARCOTEX Unidade: PT/12 F1 F4

UN: R\$ 19,51 AV: R\$ 19,51 15: R\$ 19,91
30: R\$ 20,31 45: R\$ 20,72 60: R\$ 21,13

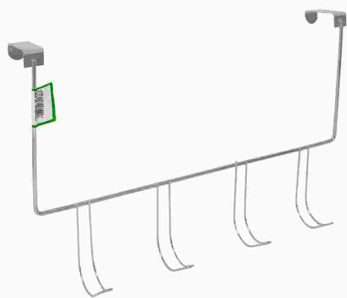

TOALHEIRO CROM DE PORTA 67

Código: Fábrica: Unidade:
28958 ARAMINAS UN/1
F1 F4

UN: R\$ 3,38 AV: R\$ 3,38 15: R\$ 3,45
30: R\$ 3,52 45: R\$ 3,59 60: R\$ 3,66



TOALHEIRO CROM PAREDE N1 1 GANCHO 64

Código: Fábrica: Unidade:
44242 ARAMINAS UN/1
F1 F4

UN: R\$ 11,81 AV: R\$ 11,81 15: R\$ 12,06
30: R\$ 12,30 45: R\$ 12,55 60: R\$ 12,80



TOALHEIRO CROM PAREDE N4 4 GANCHOS 66

Código: Fábrica: Unidade:
40516 ARAMINAS UN/1
F1 F4

UN: R\$ 4,45 AV: R\$ 53,38 15: R\$ 54,49
30: R\$ 55,58 45: R\$ 56,69 60: R\$ 57,83



TORNEIRA JARDIM 1/2 C/BIC COL TVC1N 12X1

Código: Fábrica: Unidade:
33726 REBOUCAS PT/12
F1 F4

UN: R\$ 3,53 AV: R\$ 42,37 15: R\$ 43,25
30: R\$ 44,12 45: R\$ 45,00 60: R\$ 45,90



TORNEIRA JARDIM 1/2 C/BICO PT TTV1N 12X1

Código: Fábrica: Unidade:
30743 REBOUCAS PT/12
F1 F4

UN: R\$ 4,26 AV: R\$ 51,14 15: R\$ 52,21
30: R\$ 53,25 45: R\$ 54,32 60: R\$ 55,41



TORNEIRA JARDIM 3/4 1/2 10CM C/B B1N12X1

Código: Fábrica: Unidade:
51130 REBOUCAS PT/12
F1 F4

UN: R\$ 3,82 AV: R\$ 45,81 15: R\$ 46,76
30: R\$ 47,70 45: R\$ 48,65 60: R\$ 49,62



TORNEIRA JARDIM 3/4 1/2 10CM C/B R1N12X1

Código: Fábrica: Unidade:
35660 REBOUCAS PT/12
F1 F4

UN: R\$ 6,63 AV: R\$ 79,61 15: R\$ 81,27
30: R\$ 82,89 45: R\$ 84,55 60: R\$ 86,24



TORNEIRA P/FILTRO AUTOM MARROM 342 12X1

Código: Fábrica: Unidade:
8042 MINERAL PT/12
F1 F4

UN: R\$ 11,98 AV: R\$ 143,80 15: R\$ 146,79
30: R\$ 149,73 45: R\$ 152,72 60: R\$ 155,78



TORNEIRA P/FILTRO CROMO AUTOMAT 31 12X1

Código: Fábrica: Unidade:
27209 MINERAL PT/12
F1 F4

UN: R\$ 5,97 AV: R\$ 71,70 15: R\$ 73,19
30: R\$ 74,66 45: R\$ 76,15 60: R\$ 77,67



TORNEIRA P/FILTRO MANUAL MARROM 341 12X1

Código: Fábrica: Unidade:
8043 MINERAL PT/12
F1 F4

UN: R\$ 7,19 AV: R\$ 86,27 15: R\$ 88,07
30: R\$ 89,83 45: R\$ 91,63 60: R\$ 93,46



TORNEIRA P/FILTRO TOC BRANCA 86 12X1

Código: Fábrica: Unidade:
28807 MINERAL PT/12
F1 F4

UN: R\$ 6,50 AV: R\$ 78,06 15: R\$ 79,68
30: R\$ 81,28 45: R\$ 82,90 60: R\$ 84,56



TORNEIRA P/FILTRO TOC MARROM 34 12X1

Código: Fábrica: Unidade:
38332 MINERAL PT/12
F1 F4

UN: R\$ 7,25 AV: R\$ 87,04 15: R\$ 88,86
30: R\$ 90,63 45: R\$ 92,45 60: R\$ 94,29



TORNEIRA PIA LG 3/4 1/2 15CM C/B18N 12X1

Código: Fábrica: Unidade:
47223 REBOUCAS PT/12
F1 F4

UN: R\$ 5,73 AV: R\$ 68,72 15: R\$ 70,15
30: R\$ 71,55 45: R\$ 72,98 60: R\$ 74,44



TORNEIRA PIA LONG 3/4 1/2 15CM TR5N 12X1

Código: Fábrica: Unidade:
35659 REBOUCAS PT/12
F1 F4

UN: R\$ 6,87 AV: R\$ 82,46 15: R\$ 84,18
30: R\$ 85,86 45: R\$ 87,58 60: R\$ 89,33



TORNEIRA PIA LONGA 1/2 15CM C/B 18N 12X1

Código: Fábrica: Unidade:
33722 REBOUCAS PT/12
F1 F4

UN: R\$ 4,20 AV: R\$ 50,39 15: R\$ 51,44
30: R\$ 52,47 45: R\$ 53,51 60: R\$ 54,58



TORNEIRA PIA LONGA 1/2 15CM TTV5N 12X1

Código: Fábrica: Unidade:
30742 REBOUCAS PT/12
F1 F4

UN: R\$ 6,06 AV: R\$ 6,06 15: R\$ 6,19
30: R\$ 6,31 45: R\$ 6,44 60: R\$ 6,56



TORNEIRA PIA LONGA 3/4X1/2 15CM TV5N UN
Código: Fábrica: Unidade:
39370 REBOUCAS UN/1
F1 F4

UN: R\$ 5,06 AV: R\$ 60,71 15: R\$ 61,97
30: R\$ 63,21 45: R\$ 64,48 60: R\$ 65,77



TORNEIRA PIA 3/4X1/2 15CM UNIV TV5N 12X1
Código: Fábrica: Unidade:
33729 REBOUCAS PT/12
F1 F4

UN: R\$ 4,20 AV: R\$ 50,39 15: R\$ 51,44
30: R\$ 52,47 45: R\$ 53,51 60: R\$ 54,58

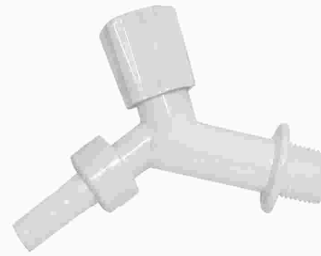

TORNEIRA PIA/TANQUE 1/2 15CM TVC5N 12X1
Código: Fábrica: Unidade:
34844 REBOUCAS PT/12
F1 F4

UN: R\$ 3,40 AV: R\$ 40,78 15: R\$ 41,63
30: R\$ 42,46 45: R\$ 43,31 60: R\$ 44,18

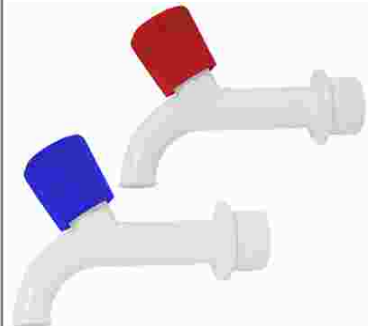

TORNEIRA PIA/TANQUE 3/4 10CM CL C4N 12X1
Código: Fábrica: Unidade:
33727 REBOUCAS PT/12
F1 F4

UN: R\$ 3,91 AV: R\$ 46,95 15: R\$ 47,93
30: R\$ 48,89 45: R\$ 49,87 60: R\$ 50,86

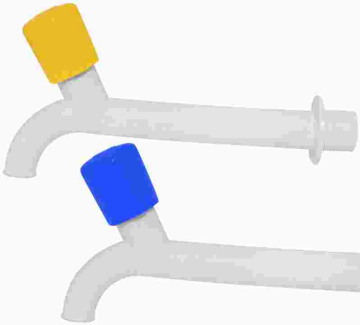

TORNEIRA P/JARDIM 1/2 10CM C/B VB1N 12X1
Código: Fábrica: Unidade:
34846 REBOUCAS PT/12
F1 F4

UN: R\$ 13,74 AV: R\$ 13,74 15: R\$ 14,02
30: R\$ 14,30 45: R\$ 14,59 60: R\$ 14,88



TORNEIRA PLAST ESFERA 1/2 10CM UN
Código: Fábrica: Unidade:
46804 CAERUS UN/1
F1 F4

UN: R\$ 12,98 AV: R\$ 155,77 15: R\$ 159,01
30: R\$ 162,19 45: R\$ 165,44 60: R\$ 168,75



TORNEIRA P/LAVATORIO 1/2 TTV7N 12X1
Código: Fábrica: Unidade:
33217 REBOUCAS PT/12
F1 F4

UN: R\$ 5,10 AV: R\$ 61,17 15: R\$ 62,44
30: R\$ 63,69 45: R\$ 64,96 60: R\$ 66,26



TORNEIRA TANQ/MAQ 1/2 10CM C/A TV20N12X1
Código: Fábrica: Unidade:
34845 REBOUCAS PT/12
F1 F4

UN: R\$ 4,77 AV: R\$ 57,26 15: R\$ 58,45
30: R\$ 59,62 45: R\$ 60,82 60: R\$ 62,03



TORNEIRA TANQUE CURT 1/2 10CM TTV3N 12X1
Código: Fábrica: Unidade:
32565 REBOUCAS PT/12
F1 F4

UN: R\$ 6,01 AV: R\$ 72,15 15: R\$ 73,65
30: R\$ 75,13 45: R\$ 76,63 60: R\$ 78,16



TORNEIRA TANQUE 1/2 10CM C/B16N 12X1
Código: Fábrica: Unidade:
33723 REBOUCAS PT/12
F1 F4

UN: R\$ 4,58 AV: R\$ 54,97 15: R\$ 56,12
30: R\$ 57,24 45: R\$ 58,38 60: R\$ 59,55



TORNEIRA TANQUE 3/4X1/2 10CM U TR3N 12X1
Código: Fábrica: Unidade:
48609 REBOUCAS PT/12
F1 F4

UN: R\$ 5,03 AV: R\$ 5,03 15: R\$ 5,13
30: R\$ 5,24 45: R\$ 5,34 60: R\$ 5,45



TORNEIRA TANQUE 3/4X1/2 10CM U TV3N UN
Código: Fábrica: Unidade:
40675 REBOUCAS PT/1
F1 F4

UN: R\$ 4,53 AV: R\$ 54,41 15: R\$ 55,54
30: R\$ 56,65 45: R\$ 57,79 60: R\$ 58,94



TORNEIRA TANQUE 3/4X1/2 10CM U TV3N 12X1
Código: Fábrica: Unidade:
33730 REBOUCAS PT/12
F1 F4

UN: R\$ 3,74 AV: R\$ 44,90 15: R\$ 45,84
30: R\$ 46,75 45: R\$ 47,69 60: R\$ 48,64



TORNEIRA TANQUE/PIA 3/4 10CM TTV4N 12X1
Código: Fábrica: Unidade:
31572 REBOUCAS PT/12
F1 F4

UN: R\$ 11,29 AV: R\$ 11,29 15: R\$ 11,52
30: R\$ 11,75 45: R\$ 11,99 60: R\$ 12,23



TRAVESSA ALUM PORCAO 1
Código: Fábrica: Unidade:
37341 MSR UN/1
F1 F4

UN: R\$ 27,72 AV: R\$ 27,72 15: R\$ 28,30
30: R\$ 28,87 45: R\$ 29,45 60: R\$ 30,03



TRAVESSA ALUM PORCAO 2 1194
Código: Fábrica: Unidade:
37342 MSR UN/1
F1 F4

UN: R\$ 28,56 AV: R\$ 28,56 15: R\$ 29,15
30: R\$ 29,73 45: R\$ 30,33 60: R\$ 30,94



TRAVESSA ALUM PORCAO 3

Código: 37343 Fábrica: MSR Unidade: UN/1
F1 F4

UN: R\$ 15,82 AV: R\$ 15,82 15: R\$ 16,15
30: R\$ 16,47 45: R\$ 16,80 60: R\$ 17,14



TRAVESSA INOX 31X21CM (TABULEIRO)800-11

Código: 40530 Fábrica: CASA ONZE Unidade: UN/1
F1 F4

UN: R\$ 25,58 AV: R\$ 25,58 15: R\$ 26,11
30: R\$ 26,63 45: R\$ 27,17 60: R\$ 27,71



TRAVESSA INOX 39X29CM (TABULEIRO)800-13

Código: 40658 Fábrica: CASA ONZE Unidade: UN/1
F1 F4

UN: R\$ 5,18 AV: R\$ 5,18 15: R\$ 5,29
30: R\$ 5,40 45: R\$ 5,51 60: R\$ 5,62



TRAVESSA PLAST PEQ RET C/TAMPA 147

Código: 33502 Fábrica: ARIPLAS Unidade: UN/1
F1 F4

UN: R\$ 2,24 AV: R\$ 2,24 15: R\$ 2,28
30: R\$ 2,33 45: R\$ 2,38 60: R\$ 2,42



TRAVESSA PLASTICA FUNDA

Código: 14579 Fábrica: ECOPLASTIC Unidade: UN/1
F1 F4

UN: R\$ 15,85 AV: R\$ 15,85 15: R\$ 16,18
30: R\$ 16,50 45: R\$ 16,83 60: R\$ 17,17



TRAVESSA PORC 320ML PEQ BRANCA G14

Código: 40019 Fábrica: TERRAMADA Unidade: UN/1
F1 F4

UN: R\$ 17,62 AV: R\$ 17,62 15: R\$ 17,98
30: R\$ 18,34 45: R\$ 18,71 60: R\$ 19,08



TRAVESSA PORC 450ML MED BRANCA G15

Código: 40020 Fábrica: TERRAMADA Unidade: UN/1
F1 F4

UN: R\$ 6,15 AV: R\$ 6,15 15: R\$ 6,28
30: R\$ 6,41 45: R\$ 6,53 60: R\$ 6,67



TRITURADOR PLAST GIRATORIO P/ALHO 1032

Código: 50375 Fábrica: ENGIPLAST Unidade: UN/1
F1 F4

UN: R\$ 3,07 AV: R\$ 3,07 15: R\$ 3,14
30: R\$ 3,20 45: R\$ 3,26 60: R\$ 3,33



TRITURADOR PLAST GIRATORIO P/ALHO 780

Código: 36963 Fábrica: QUALYPLAS Unidade: UN/1
F1 F4

UN: R\$ 20,12 AV: R\$ 20,12 15: R\$ 20,54
30: R\$ 20,95 45: R\$ 21,37 60: R\$ 21,80

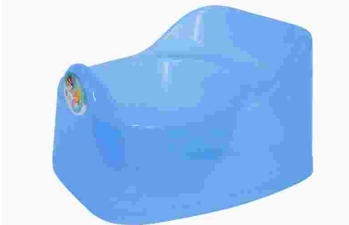

TRONINHO PLAST BABY AZUL 3638

Código: 35480 Fábrica: TRITEC Unidade: UN/1
F1 F4

UN: R\$ 20,12 AV: R\$ 20,12 15: R\$ 20,54
30: R\$ 20,95 45: R\$ 21,37 60: R\$ 21,80



TRONINHO PLAST BABY ROSA 3636

Código: 6456 Fábrica: TRITEC Unidade: UN/1
F1 F4

UN: R\$ 4,75 AV: R\$ 4,75 15: R\$ 4,84
30: R\$ 4,94 45: R\$ 5,04 60: R\$ 5,14



UNIAO PLAST MANGUEIRA STANDARD 215

Código: 40242 Fábrica: MONTEREY Unidade: UN/1
F1 F4

UN: R\$ 2,05 AV: R\$ 51,35 15: R\$ 52,42
30: R\$ 53,47 45: R\$ 54,54 60: R\$ 55,63



UNIAO 1/2 P/IRRIGACAO INTERNA 25X1

Código: 50817 Fábrica: MC LOREN Unidade: PT/25
F1 F4

UN: R\$ 0,53 AV: R\$ 26,70 15: R\$ 27,25
30: R\$ 27,80 45: R\$ 28,35 60: R\$ 28,92



UNIAO 1/2 P/MANGUEIRA PRETO UN51N 50X1

Código: 40151 Fábrica: REBOUCAS Unidade: PT/50
F1 F4

UN: R\$ 0,62 AV: R\$ 30,81 15: R\$ 31,45
30: R\$ 32,08 45: R\$ 32,72 60: R\$ 33,37



UNIAO 3/4 P/MANGUEIRA PRETO UN52N 50X1

Código: 40152 Fábrica: REBOUCAS Unidade: PT/50
F1 F4

UN: R\$ 6,73 AV: R\$ 6,73 15: R\$ 6,87
30: R\$ 7,01 45: R\$ 7,15 60: R\$ 7,29



URINOL GRANDE PLAST 5017

Código: 14026 Fábrica: SBRISSA Unidade: UN/1
F1 F4

UN: R\$ 8,52 AV: R\$ 8,52 15: R\$ 8,69
30: R\$ 8,87 45: R\$ 9,04 60: R\$ 9,23



URINOL PLAST 713

Código: Fábrica: Unidade:
37261 LUMAR UN/1
F1 F4

UN: R\$ 10,59 AV: R\$ 10,59 15: R\$ 10,81
30: R\$ 11,03 45: R\$ 11,25 60: R\$ 11,47



URINOL PLASTICO GDE 113

Código: Fábrica: Unidade:
20915 ECOPLASTIC UN/1
F1 F4

UN: R\$ 3,89 AV: R\$ 3,89 15: R\$ 3,97
30: R\$ 4,05 45: R\$ 4,13 60: R\$ 4,22



VALVULA GATILHO P/PULVERIZADOR 28

Código: Fábrica: Unidade:
49398 ARBRA UN/1
F1 F4

UN: R\$ 10,50 AV: R\$ 126,00 15: R\$ 128,62
30: R\$ 131,20 45: R\$ 133,82 60: R\$ 136,50



VALVULA P/TANQUE 1.1/4" MET VC53N 12X1

Código: Fábrica: Unidade:
40155 REBOUCAS PT/12
F1 F4

UN: R\$ 5,34 AV: R\$ 64,13 15: R\$ 65,47
30: R\$ 66,78 45: R\$ 68,11 60: R\$ 69,48



VALVULA P/TANQUE 1.1/4" PLAS VO53N 12X1

Código: Fábrica: Unidade:
40156 REBOUCAS PT/12
F1 F4

UN: R\$ 2,46 AV: R\$ 24,64 15: R\$ 25,16
30: R\$ 25,66 45: R\$ 26,17 60: R\$ 26,70



VALVULA SEG PAINELA PRESS METAL 2000 10X1

Código: Fábrica: Unidade:
25505 PINOLAR PT/10
F1 F4

UN: R\$ 2,05 AV: R\$ 20,53 15: R\$ 20,96
30: R\$ 21,38 45: R\$ 21,81 60: R\$ 22,24



VALVULA SEG PAINELA PRESS SILIC 6000 10X1

Código: Fábrica: Unidade:
31035 PINOLAR PT/10
F1 F4

UN: R\$ 2,56 AV: R\$ 5,12 15: R\$ 5,22
30: R\$ 5,33 45: R\$ 5,43 60: R\$ 5,54



VALVULA (SELO) PAINELA PRESSAO 62 2X1

Código: Fábrica: Unidade:
49742 NOVA MARCA CR/2
F1 F4

UN: R\$ 12,11 AV: R\$ 12,11 15: R\$ 12,36
30: R\$ 12,61 45: R\$ 12,86 60: R\$ 13,12



VARAL MULTIUSO N1 08 PRENDEDORES 433

Código: Fábrica: Unidade:
38887 LIG BRIN UN/1
F1 F4

UN: R\$ 25,91 AV: R\$ 25,91 15: R\$ 26,45
30: R\$ 26,97 45: R\$ 27,51 60: R\$ 28,06



VARAL MULTIUSO N2 16 PRENDEDORES 440

Código: Fábrica: Unidade:
38888 LIG BRIN UN/1
F1 F4

UN: R\$ 30,81 AV: R\$ 30,81 15: R\$ 31,45
30: R\$ 32,08 45: R\$ 32,72 60: R\$ 33,37



VARAL MULTIUSO N3 26 PRENDEDORES 471

Código: Fábrica: Unidade:
38886 LIG BRIN UN/1
F1 F4

UN: R\$ 47,24 AV: R\$ 47,24 15: R\$ 48,23
30: R\$ 49,19 45: R\$ 50,17 60: R\$ 51,18



VARAL MULTIUSO N4 36 PRENDEDORES 587

Código: Fábrica: Unidade:
38889 LIG BRIN UN/1
F1 F4

UN: R\$ 85,99 AV: R\$ 85,99 15: R\$ 87,78
30: R\$ 89,53 45: R\$ 91,32 60: R\$ 93,15

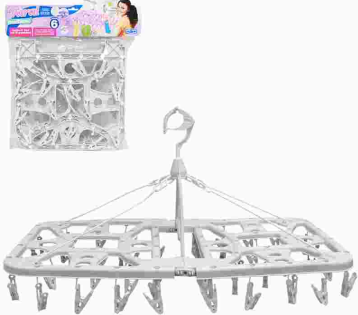

VARAL MULTIUSO N6 48 PRENDEDORES 624

Código: Fábrica: Unidade:
38891 LIG BRIN UN/1
F1 F4

UN: R\$ 13,34 AV: R\$ 13,34 15: R\$ 13,62
30: R\$ 13,89 45: R\$ 14,17 60: R\$ 14,46



VARAL PLAST MULTIUSO 12 PRENDEDORES 0219

Código: Fábrica: Unidade:
31365 TALBERG UN/1
F1 F4

UN: R\$ 41,08 AV: R\$ 41,08 15: R\$ 41,93
30: R\$ 42,77 45: R\$ 43,63 60: R\$ 44,50



VARAO (BASTAO) EXTENSIV METAL 1,40A2,60M

Código: Fábrica: Unidade:
47374 ALTIHOME UN/1
F1 F4

UN: R\$ 0,13 AV: R\$ 12,83 15: R\$ 13,10
30: R\$ 13,36 45: R\$ 13,63 60: R\$ 13,90



VARETA BAMBU ALGODAO DOCE 40CM 100X1

Código: Fábrica: Unidade:
50075 BOMPACK PT/100
F1 F4

UN: R\$ 6,78 AV: R\$ 6,78 15: R\$ 6,92
30: R\$ 7,06 45: R\$ 7,20 60: R\$ 7,34



VASO CERAMICA MINI 5,5X6CM 172116

Código: 34775 Fábrica: FREECOM Unidade: UN/1 F1 F4

UN: R\$ 27,73 AV: R\$ 27,73 15: R\$ 28,31
30: R\$ 28,88 45: R\$ 29,46 60: R\$ 30,05

12 cm
15 cm
1,3 lts



VASO ELEGANCE AUTOIRRIG 03 CAFE IMP 1,3L

Código: 34619 Fábrica: NUTRIPLAN Unidade: UN/1 F1 F4

UN: R\$ 33,49 AV: R\$ 33,49 15: R\$ 34,18
30: R\$ 34,87 45: R\$ 35,57 60: R\$ 36,28

16 cm
15 cm
1,8 lts



VASO ELEGANCE AUTOIRRIG 3,5 TRAVERT 1,8L

Código: 34620 Fábrica: NUTRIPLAN Unidade: UN/1 F1 F4

UN: R\$ 1,48 AV: R\$ 1,48 15: R\$ 1,51
30: R\$ 1,54 45: R\$ 1,57 60: R\$ 1,60

415 ml



VASO PL 1 RED PEQ MARROM 415ML

Código: 39638 Fábrica: NUTRIPLAN Unidade: UN/1 F1 F4

UN: R\$ 1,36 AV: R\$ 1,36 15: R\$ 1,38
30: R\$ 1,41 45: R\$ 1,44 60: R\$ 1,47

7,8cm
10,2cm



VASO PL 1 RED PEQ PRETO 415ML

Código: 18470 Fábrica: NUTRIPLAN Unidade: UN/1 F1 F4

UN: R\$ 3,07 AV: R\$ 3,07 15: R\$ 3,14
30: R\$ 3,20 45: R\$ 3,26 60: R\$ 3,33

12cm
16cm
1lts



VASO PL 1,0 L RED PEQ TERRACOTA 6715

Código: 26766 Fábrica: INPLAST Unidade: UN/1 F1 F4

UN: R\$ 1,83 AV: R\$ 1,83 15: R\$ 1,87
30: R\$ 1,90 45: R\$ 1,94 60: R\$ 1,98

9 cm
12 cm
0,75 L



VASO PL 1,5 RED PEQ PRETO 750ML

Código: 33551 Fábrica: NUTRIPLAN Unidade: UN/1 F1 F4

UN: R\$ 3,01 AV: R\$ 3,01 15: R\$ 3,07
30: R\$ 3,13 45: R\$ 3,20 60: R\$ 3,26

9 cm
13 cm
01 L



VASO PL 2 RED PEQ MARROM 1LT

Código: 33537 Fábrica: NUTRIPLAN Unidade: UN/1 F1 F4

UN: R\$ 2,22 AV: R\$ 2,22 15: R\$ 2,27
30: R\$ 2,31 45: R\$ 2,36 60: R\$ 2,40

9,8cm
13cm



VASO PL 2 RED PEQ PRETO 1LT

Código: 18471 Fábrica: NUTRIPLAN Unidade: UN/1 F1 F4

UN: R\$ 3,45 AV: R\$ 3,45 15: R\$ 3,52
30: R\$ 3,59 45: R\$ 3,67 60: R\$ 3,74

11 cm
14 cm
1,4 L



VASO PL 2,5 RED PEQ MARROM 1,4LTS

Código: 33538 Fábrica: NUTRIPLAN Unidade: UN/1 F1 F4

UN: R\$ 3,13 AV: R\$ 3,13 15: R\$ 3,20
30: R\$ 3,26 45: R\$ 3,33 60: R\$ 3,39

10,5cm
14,5cm



VASO PL 2,5 RED PEQ PRETO 1,4LTS

Código: 18472 Fábrica: NUTRIPLAN Unidade: UN/1 F1 F4

UN: R\$ 5,65 AV: R\$ 5,65 15: R\$ 5,77
30: R\$ 5,88 45: R\$ 6,00 60: R\$ 6,12



VASO PL 3 LTS QUAD PRETO 7002

Código: 40417 Fábrica: FORMPLAST Unidade: UN/1 F1 F4

UN: R\$ 5,32 AV: R\$ 5,32 15: R\$ 5,43
30: R\$ 5,54 45: R\$ 5,65 60: R\$ 5,76

12 cm
17 cm
02 L



VASO PL 3 RED PEQ MARROM 2LTS

Código: 33539 Fábrica: NUTRIPLAN Unidade: UN/1 F1 F4

UN: R\$ 4,61 AV: R\$ 4,61 15: R\$ 4,71
30: R\$ 4,80 45: R\$ 4,90 60: R\$ 5,00

12,5cm
17cm



VASO PL 3 RED PEQ PRETO 2LTS

Código: 18473 Fábrica: NUTRIPLAN Unidade: UN/1 F1 F4

UN: R\$ 7,96 AV: R\$ 7,96 15: R\$ 8,13
30: R\$ 8,29 45: R\$ 8,46 60: R\$ 8,62

15 cm
20 cm
03 L



VASO PL 3,5 RED MED MARROM 3LTS

Código: 33552 Fábrica: NUTRIPLAN Unidade: UN/1 F1 F4

UN: R\$ 11,01 AV: R\$ 11,01 15: R\$ 11,24
30: R\$ 11,47 45: R\$ 11,70 60: R\$ 11,93

17 cm
21 cm
4,9 L



VASO PL 4 RED MED MARROM 4,9LTS

Código: 26911 Fábrica: NUTRIPLAN Unidade: UN/1 F1 F4

UN: R\$ 7,96 AV: R\$ 7,96 15: R\$ 8,13
30: R\$ 8,29 45: R\$ 8,46 60: R\$ 8,62

17cm
21cm



VASO PL 4 RED MED PRETO 4,9LTS

Código: 18475 Fábrica: NUTRIPLAN Unidade: UN/1 F1 F4

UN: R\$ 15,40 AV: R\$ 15,40 15: R\$ 15,72
30: R\$ 16,03 45: R\$ 16,35 60: R\$ 16,68

23 cm
26 cm
8,7 L



VASO PL 5 RED GDE MARROM 8,7LTS

Código: 33553 Fábrica: NUTRIPLAN Unidade: UN/1 F1 F4

UN: R\$ 15,40 AV: R\$ 15,40 15: R\$ 15,72
30: R\$ 16,03 45: R\$ 16,35 60: R\$ 16,68

23cm
26cm



VASO PL 5 RED GDE PRETO 8,7LTS

Código: 18476 Fábrica: NUTRIPLAN Unidade: UN/1 F1 F4

UN: R\$ 8,82 AV: R\$ 8,82 15: R\$ 9,01
30: R\$ 9,19 45: R\$ 9,37 60: R\$ 9,56



VASO PL 5LTS MARFIM 6412

Código: 41480 Fábrica: KOZI PLAST Unidade: UN/1 F1 F4

UN: R\$ 6,18 AV: R\$ 6,18 15: R\$ 6,31
30: R\$ 6,44 45: R\$ 6,57 60: R\$ 6,70



VASO PL 5LTS PRETO 6400

Código: 41494 Fábrica: KOZI PLAST Unidade: UN/1 F1 F4

UN: R\$ 23,99 AV: R\$ 23,99 15: R\$ 24,48
30: R\$ 24,97 45: R\$ 25,47 60: R\$ 25,98

25 cm
20 cm
12 L



VASO PL 6 RED GDE MARROM 12LTS

Código: 33554 Fábrica: NUTRIPLAN Unidade: UN/1 F1 F4

UN: R\$ 19,51 AV: R\$ 19,51 15: R\$ 19,91
30: R\$ 20,31 45: R\$ 20,72 60: R\$ 21,13

25cm
30cm



VASO PL 6 RED GDE PRETO 12LTS

Código: 18477 Fábrica: NUTRIPLAN Unidade: UN/1 F1 F4

UN: R\$ 34,91 AV: R\$ 34,91 15: R\$ 35,64
30: R\$ 36,35 45: R\$ 37,08 60: R\$ 37,82

29 cm
37 cm
21,5 L



VASO PL 7 RED GDE MARROM 21,5LTS

Código: 33555 Fábrica: NUTRIPLAN Unidade: UN/1 F1 F4

UN: R\$ 34,91 AV: R\$ 34,91 15: R\$ 35,64
30: R\$ 36,35 45: R\$ 37,08 60: R\$ 37,82

29cm
37cm



VASO PL 7 RED GDE PRETO 21,2LTS

Código: 18478 Fábrica: NUTRIPLAN Unidade: UN/1 F1 F4

UN: R\$ 78,07 AV: R\$ 78,07 15: R\$ 79,69
30: R\$ 81,29 45: R\$ 82,91 60: R\$ 84,57

38 cm
44 cm
42,5 L



VASO PL 8 RED GIG MARROM 42,5LTS

Código: 33535 Fábrica: NUTRIPLAN Unidade: UN/1 F1 F4

UN: R\$ 68,82 AV: R\$ 68,82 15: R\$ 70,26
30: R\$ 71,66 45: R\$ 73,09 60: R\$ 74,56

38 cm
44 cm
42,5 L



VASO PL 8 RED GIG PRETO 42,5LTS

Código: 33536 Fábrica: NUTRIPLAN Unidade: UN/1 F1 F4

UN: R\$ 102,21 AV: R\$ 102,21 15: R\$ 104,34
30: R\$ 106,42 45: R\$ 108,55 60: R\$ 110,72

45 cm
51 cm
65Lts



VASO PL 9 RED GIG PRETO 65LTS

Código: 39639 Fábrica: NUTRIPLAN Unidade: UN/1 F1 F4

UN: R\$ 20,54 AV: R\$ 20,54 15: R\$ 20,97
30: R\$ 21,39 45: R\$ 21,82 60: R\$ 22,26

21,5cm
29 cm
30 lts



VASO PL ADRI 30 PRETO 8L 788

Código: 37712 Fábrica: BIG PLAST Unidade: UN/1 F1 F4

UN: R\$ 6,66 AV: R\$ 6,66 15: R\$ 6,79
30: R\$ 6,93 45: R\$ 7,07 60: R\$ 7,21



VASO PL AQUARELA 2,5 RED AMARELO CLARO

Código: 35709 Fábrica: NUTRIPLAN Unidade: UN/1 F1 F4

UN: R\$ 6,77 AV: R\$ 6,77 15: R\$ 6,91
30: R\$ 7,05 45: R\$ 7,19 60: R\$ 7,33



VASO PL AQUARELA 2,5 RED LILAS CLARO

Código: 35710 Fábrica: NUTRIPLAN Unidade: UN/1 F1 F4

UN: R\$ 6,77 AV: R\$ 6,77 15: R\$ 6,91
30: R\$ 7,05 45: R\$ 7,19 60: R\$ 7,33



VASO PL AQUARELA 2,5 RED ROSA BEBE

Código: 35711 Fábrica: NUTRIPLAN Unidade: UN/1 F1 F4

UN: R\$ 6,66 AV: R\$ 6,66 15: R\$ 6,79
30: R\$ 6,93 45: R\$ 7,07 60: R\$ 7,21



VASO PL AQUARELA 2,5 RED VERDE CLARO

Código: 35712 Fábrica: NUTRIPLAN Unidade: UN/1 F1 F4

UN: R\$ 8,58 AV: R\$ 8,58 15: R\$ 8,76
30: R\$ 8,93 45: R\$ 9,11 60: R\$ 9,29

14 cm
15 cm
1,6 lts



VASO PL AQUARELA 3,5 RED AMARELO CL 1,7L

Código: 34600 Fábrica: NUTRIPLAN Unidade: UN/1 F1 F4

UN: R\$ 8,58 AV: R\$ 8,58 15: R\$ 8,76
30: R\$ 8,93 45: R\$ 9,11 60: R\$ 9,29

14 cm
15 cm
1,6 lts



VASO PL AQUARELA 3,5 RED VERDE CLAR 1,7L

Código: 34603 Fábrica: NUTRIPLAN Unidade: UN/1 F1 F4

UN: R\$ 22,34 AV: R\$ 22,34 15: R\$ 22,81
30: R\$ 23,26 45: R\$ 23,73 60: R\$ 24,20

13 cm
19 cm



VASO PL AZALEIA QUAD CAFE 1132

Código: 37215 Fábrica: PAIOL Unidade: UN/1 F1 F4

UN: R\$ 51,77 AV: R\$ 51,77 15: R\$ 52,85
30: R\$ 53,91 45: R\$ 54,98 60: R\$ 56,08

35 cm
28,5 cm



VASO PL BACIA GREGA P AZUL 29-9

Código: 40022 Fábrica: PAIOL Unidade: UN/1 F1 F4

UN: R\$ 58,54 AV: R\$ 58,54 15: R\$ 59,76
30: R\$ 60,95 45: R\$ 62,17 60: R\$ 63,42

35 cm
28,5 cm



VASO PL BACIA GREGA P BEGE 29-1

Código: 40021 Fábrica: PAIOL Unidade: UN/1 F1 F4

UN: R\$ 197,67 AV: R\$ 197,67 15: R\$ 201,79
30: R\$ 205,83 45: R\$ 209,95 60: R\$ 214,14

45 cm
28 cm



VASO PL BAMBU OVAL 45 CARVALHO 22LTS

Código: 34609 Fábrica: NUTRIPLAN Unidade: UN/1 F1 F4

UN: R\$ 15,77 AV: R\$ 15,77 15: R\$ 16,10
30: R\$ 16,42 45: R\$ 16,75 60: R\$ 17,08

30 cm
35 cm
13,5 L



VASO PL BELLA FIOR RED 35 PTO 13,5L 9201

Código: 45208 Fábrica: RISCHIOTO Unidade: UN/1 F1 F4

UN: R\$ 22,51 AV: R\$ 22,51 15: R\$ 22,97
30: R\$ 23,43 45: R\$ 23,90 60: R\$ 24,38

36 cm
42 cm
29,6 L



VASO PL BELLA FIORE RED 42 PTO 25L 9202

Código: 45209 Fábrica: RISCHIOTO Unidade: UN/1 F1 F4

UN: R\$ 9,03 AV: R\$ 9,03 15: R\$ 9,22
30: R\$ 9,40 45: R\$ 9,59 60: R\$ 9,78

24 cm
28 cm
9,7 L



VASO PL BELLA QUAD 28 PTO 9,7LTS 9250

Código: 45204 Fábrica: RISCHIOTO Unidade: UN/1 F1 F4

UN: R\$ 5,64 AV: R\$ 5,64 15: R\$ 5,76
30: R\$ 5,87 45: R\$ 5,99 60: R\$ 6,11

19 cm
22 cm
4 L



VASO PL BELLA RED 22 PTO 4LTS 9199

Código: 45206 Fábrica: RISCHIOTO Unidade: UN/1 F1 F4

UN: R\$ 45,63 AV: R\$ 45,63 15: R\$ 46,58
30: R\$ 47,51 45: R\$ 48,46 60: R\$ 49,43

43 cm
50 cm
42,5 L



VASO PL BELLA RED 50 PTO 42,5LTS 9203

Código: 45210 Fábrica: RISCHIOTO Unidade: UN/1 F1 F4

UN: R\$ 42,23 AV: R\$ 42,23 15: R\$ 43,11
30: R\$ 43,97 45: R\$ 44,85 60: R\$ 45,75

25 cm
26 cm



VASO PL CACHEPO GDE SISAL 1725

Código: 37217 Fábrica: PAIOL Unidade: UN/1 F1 F4

UN: R\$ 145,86 AV: R\$ 145,86 15: R\$ 148,90
30: R\$ 151,88 45: R\$ 154,92 60: R\$ 158,02

70 cm
38 cm
27,5 lts



VASO PL CLASS CONE 70 VERDE GUATEMA 27,5L

Código: 39652 Fábrica: NUTRIPLAN Unidade: UN/1 F1 F4

UN: R\$ 231,12 AV: R\$ 231,12 15: R\$ 235,94
30: R\$ 240,65 45: R\$ 245,47 60: R\$ 250,38

65 cm
38 cm
50 lts



VASO PL CLASS CONICO 66 VERDE GUATEMA 50L

Código: 39647 Fábrica: NUTRIPLAN Unidade: UN/1 F1 F4

UN: R\$ 135,96 AV: R\$ 135,96 15: R\$ 138,79
30: R\$ 141,57 45: R\$ 144,40 60: R\$ 147,29

33 cm
35 cm
22 lts



VASO PL CLASS RED 33 VERDE GUATEMALA 22L

Código: 39648 Fábrica: NUTRIPLAN Unidade: UN/1 F1 F4

UN: R\$ 123,25 AV: R\$ 123,25 15: R\$ 125,82
 30: R\$ 128,34 45: R\$ 130,90 60: R\$ 133,52





VASO PL CLASSIC CILINDRICO 32 AREIA 35LT
 Código: Fábrica: Unidade:
30277 NUTRIPLAN UN/1
 F1 F4

UN: R\$ 112,98 AV: R\$ 112,98 15: R\$ 115,34
 30: R\$ 117,64 45: R\$ 120,00 60: R\$ 122,40



VASO PL CLASSIC CILINDRICO 32 AZUL COB
 Código: Fábrica: Unidade:
41390 NUTRIPLAN UN/1
 F1 F4

UN: R\$ 133,53 AV: R\$ 133,53 15: R\$ 136,31
 30: R\$ 139,03 45: R\$ 141,81 60: R\$ 144,65



VASO PL CLASSIC CILINDRICO 32 FERRU 35L
 Código: Fábrica: Unidade:
30278 NUTRIPLAN UN/1
 F1 F4

UN: R\$ 143,80 AV: R\$ 143,80 15: R\$ 146,79
 30: R\$ 149,73 45: R\$ 152,72 60: R\$ 155,78



VASO PL CLASSIC CILINDRICO 75 AREIA
 Código: Fábrica: Unidade:
42173 NUTRIPLAN UN/1
 F1 F4

UN: R\$ 143,80 AV: R\$ 143,80 15: R\$ 146,79
 30: R\$ 149,73 45: R\$ 152,72 60: R\$ 155,78



VASO PL CLASSIC CILINDRICO 75 AZUL COB
 Código: Fábrica: Unidade:
42169 NUTRIPLAN UN/1
 F1 F4

UN: R\$ 143,80 AV: R\$ 143,80 15: R\$ 146,79
 30: R\$ 149,73 45: R\$ 152,72 60: R\$ 155,78



VASO PL CLASSIC CILINDRICO 75 FERRUGEM
 Código: Fábrica: Unidade:
42172 NUTRIPLAN UN/1
 F1 F4

UN: R\$ 58,29 AV: R\$ 58,29 15: R\$ 59,51
 30: R\$ 60,70 45: R\$ 61,91 60: R\$ 63,15

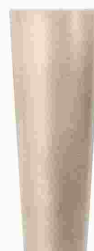



VASO PL CLASSIC CONE 30 AREIA
 Código: Fábrica: Unidade:
36801 NUTRIPLAN UN/1
 F1 F4

UN: R\$ 58,29 AV: R\$ 58,29 15: R\$ 59,51
 30: R\$ 60,70 45: R\$ 61,91 60: R\$ 63,15





VASO PL CLASSIC CONE 30 COBRE
 Código: Fábrica: Unidade:
36803 NUTRIPLAN UN/1
 F1 F4

UN: R\$ 58,29 AV: R\$ 58,29 15: R\$ 59,51
 30: R\$ 60,70 45: R\$ 61,91 60: R\$ 63,15





VASO PL CLASSIC CONE 30 FERRUGEM
 Código: Fábrica: Unidade:
36799 NUTRIPLAN UN/1
 F1 F4

UN: R\$ 58,29 AV: R\$ 58,29 15: R\$ 59,51
 30: R\$ 60,70 45: R\$ 61,91 60: R\$ 63,15





VASO PL CLASSIC CONE 30 RUBI
 Código: Fábrica: Unidade:
36802 NUTRIPLAN UN/1
 F1 F4

UN: R\$ 145,86 AV: R\$ 145,86 15: R\$ 148,90
 30: R\$ 151,88 45: R\$ 154,92 60: R\$ 158,02





VASO PL CLASSIC CONE 70 AREIA
 Código: Fábrica: Unidade:
36798 NUTRIPLAN UN/1
 F1 F4

UN: R\$ 123,25 AV: R\$ 123,25 15: R\$ 125,82
 30: R\$ 128,34 45: R\$ 130,90 60: R\$ 133,52



VASO PL CLASSIC CONE 70 AZUL COB
 Código: Fábrica: Unidade:
41382 NUTRIPLAN UN/1
 F1 F4

UN: R\$ 145,86 AV: R\$ 145,86 15: R\$ 148,90
 30: R\$ 151,88 45: R\$ 154,92 60: R\$ 158,02





VASO PL CLASSIC CONE 70 GRAFITE
 Código: Fábrica: Unidade:
36797 NUTRIPLAN UN/1
 F1 F4

UN: R\$ 92,44 AV: R\$ 92,44 15: R\$ 94,36
 30: R\$ 96,25 45: R\$ 98,18 60: R\$ 100,14



VASO PL CLASSIC CONICO 46 AZUL COB 50L
 Código: Fábrica: Unidade:
41384 NUTRIPLAN UN/1
 F1 F4

UN: R\$ 102,71 AV: R\$ 102,71 15: R\$ 104,85
 30: R\$ 106,95 45: R\$ 109,09 60: R\$ 111,27



VASO PL CLASSIC CONICO 46 GRAFITE 18LTS
 Código: Fábrica: Unidade:
32739 NUTRIPLAN UN/1
 F1 F4

UN: R\$ 164,34 AV: R\$ 164,34 15: R\$ 167,77
 30: R\$ 171,12 45: R\$ 174,54 60: R\$ 178,03



VASO PL CLASSIC CONICO 66 AZUL COB
 Código: Fábrica: Unidade:
41400 NUTRIPLAN UN/1
 F1 F4

UN: R\$ 246,59 AV: R\$ 246,59 15: R\$ 251,73
30: R\$ 256,76 45: R\$ 261,90 60: R\$ 267,13

65 cm
38 cm
50 lts



VASO PL CLASSIC CONICO 66 GRAFITE 50LTS

Código: 32738 Fábrica: NUTRIPLAN Unidade: UN/1
F1 F4

UN: R\$ 223,93 AV: R\$ 223,93 15: R\$ 228,59
30: R\$ 233,17 45: R\$ 237,83 60: R\$ 242,59

65 cm
38 cm
50 lts



VASO PL CLASSIC CONICO 66 RUBI 50LTS

Código: 32737 Fábrica: NUTRIPLAN Unidade: UN/1
F1 F4

UN: R\$ 79,09 AV: R\$ 79,09 15: R\$ 80,74
30: R\$ 82,36 45: R\$ 84,00 60: R\$ 85,68

26 cm
27,5 cm
11 lts



VASO PL CLASSIC REDONDO 26 AREIA 11LTS

Código: 33398 Fábrica: NUTRIPLAN Unidade: UN/1
F1 F4

UN: R\$ 78,49 AV: R\$ 78,49 15: R\$ 80,12
30: R\$ 81,73 45: R\$ 83,36 60: R\$ 85,03

26 cm
27,5 cm
11 lts



VASO PL CLASSIC REDONDO 26 FERRUGEM 11LT

Código: 33392 Fábrica: NUTRIPLAN Unidade: UN/1
F1 F4

UN: R\$ 185,92 AV: R\$ 185,92 15: R\$ 189,80
30: R\$ 193,59 45: R\$ 197,46 60: R\$ 201,41

40 cm
42,6 cm
45 lts



VASO PL CLASSIC REDONDO 40 RUBI 45LTS

Código: 34097 Fábrica: NUTRIPLAN Unidade: UN/1
F1 F4

UN: R\$ 400,60 AV: R\$ 400,60 15: R\$ 408,94
30: R\$ 417,12 45: R\$ 425,46 60: R\$ 433,97

62 cm
67 cm



VASO PL CLASSIC REDONDO 62 FERRUG 170LTS

Código: 30331 Fábrica: NUTRIPLAN Unidade: UN/1
F1 F4

UN: R\$ 20,53 AV: R\$ 20,53 15: R\$ 20,96
30: R\$ 21,38 45: R\$ 21,81 60: R\$ 22,24



VASO PL COLOR M 951994

Código: 41203 Fábrica: PLASTSU Unidade: UN/1
F1 F4

UN: R\$ 21,19 AV: R\$ 21,19 15: R\$ 21,63
30: R\$ 22,07 45: R\$ 22,51 60: R\$ 22,96



VASO PL COLOR P 9LTS 951512

Código: 41201 Fábrica: PLASTSU Unidade: UN/1
F1 F4

UN: R\$ 19,79 AV: R\$ 19,79 15: R\$ 20,20
30: R\$ 20,61 45: R\$ 21,02 60: R\$ 21,44

28 cm
21 cm
8 lts



VASO PL COLUNA MARROM 8 LTS 2302

Código: 36994 Fábrica: ERCAPLAST Unidade: UN/1
F1 F4

UN: R\$ 23,56 AV: R\$ 23,56 15: R\$ 24,05
30: R\$ 24,53 45: R\$ 25,02 60: R\$ 25,52

34 cm
25 cm
13,5 lts



VASO PL COLUNA PRETO 13,5 LTS 2344

Código: 36992 Fábrica: ERCAPLAST Unidade: UN/1
F1 F4

UN: R\$ 16,49 AV: R\$ 16,49 15: R\$ 16,84
30: R\$ 17,17 45: R\$ 17,52 60: R\$ 17,87

28 cm
21 cm
8 lts



VASO PL COLUNA PRETO 8 LTS 2301

Código: 36993 Fábrica: ERCAPLAST Unidade: UN/1
F1 F4

UN: R\$ 86,28 AV: R\$ 86,28 15: R\$ 88,08
30: R\$ 89,84 45: R\$ 91,64 60: R\$ 93,47

35 cm
28,5 cm

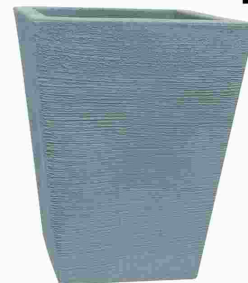

VASO PL COLUNA QUAD PEQ AZUL 79-7

Código: 39961 Fábrica: PAIOL Unidade: UN/1
F1 F4

UN: R\$ 102,31 AV: R\$ 102,31 15: R\$ 104,44
30: R\$ 106,53 45: R\$ 108,66 60: R\$ 110,83

35 cm
28,5 cm



VASO PL COLUNA QUAD PEQ BEGE 79-3

Código: 39959 Fábrica: PAIOL Unidade: UN/1
F1 F4

UN: R\$ 86,28 AV: R\$ 86,28 15: R\$ 88,08
30: R\$ 89,84 45: R\$ 91,64 60: R\$ 93,47

35 cm
28,5 cm



VASO PL COLUNA QUAD PEQ CIMENTO 79-4

Código: 39960 Fábrica: PAIOL Unidade: UN/1
F1 F4

UN: R\$ 86,28 AV: R\$ 86,28 15: R\$ 88,08
30: R\$ 89,84 45: R\$ 91,64 60: R\$ 93,47

35 cm
28,5 cm



VASO PL COLUNA QUAD PEQ MARROM 79-7

Código: 39958 Fábrica: PAIOL Unidade: UN/1
F1 F4

UN: R\$ 51,77 AV: R\$ 51,77 15: R\$ 52,85
30: R\$ 53,91 45: R\$ 54,98 60: R\$ 56,08

35 cm
22 cm



VASO PL COLUNA QUAD PP AZUL 99-7

Código: 39957 Fábrica: PAIOL Unidade: UN/1
F1 F4

UN: R\$ 51,77 AV: R\$ 51,77 15: R\$ 52,85
 30: R\$ 53,91 45: R\$ 54,98 60: R\$ 56,08
 27 cm
 22 cm

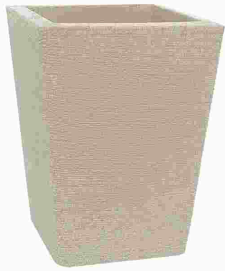

VASO PL COLUNA QUAD PP BEGE 99-1
 Código: Fábrica: Unidade:
39955 PAIOL UN/1
 F1 F4

UN: R\$ 51,77 AV: R\$ 51,77 15: R\$ 52,85
 30: R\$ 53,91 45: R\$ 54,98 60: R\$ 56,08
 27 cm
 22 cm

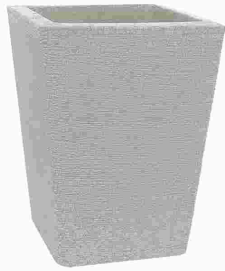

VASO PL COLUNA QUAD PP CIMENTO 99-3
 Código: Fábrica: Unidade:
39956 PAIOL UN/1
 F1 F4

UN: R\$ 51,77 AV: R\$ 51,77 15: R\$ 52,85
 30: R\$ 53,91 45: R\$ 54,98 60: R\$ 56,08
 27 cm
 22 cm



VASO PL COLUNA QUAD PP MARROM 99-2
 Código: Fábrica: Unidade:
39954 PAIOL UN/1
 F1 F4

UN: R\$ 51,77 AV: R\$ 51,77 15: R\$ 52,85
 30: R\$ 53,91 45: R\$ 54,98 60: R\$ 56,08
 26 cm
 21,5 cm



VASO PL COLUNA RED PP BEGE 50-1
 Código: Fábrica: Unidade:
39948 PAIOL UN/1
 F1 F4

UN: R\$ 51,77 AV: R\$ 51,77 15: R\$ 52,85
 30: R\$ 53,91 45: R\$ 54,98 60: R\$ 56,08
 26 cm
 21,5 cm



VASO PL COLUNA RED PP CIMENTO 50-3
 Código: Fábrica: Unidade:
39949 PAIOL UN/1
 F1 F4

UN: R\$ 58,67 AV: R\$ 58,67 15: R\$ 59,90
 30: R\$ 61,09 45: R\$ 62,32 60: R\$ 63,56
 29 cm
 26,5 cm



VASO PL COLUNA RED PP LISO AZUL B50-9
 Código: Fábrica: Unidade:
40027 PAIOL UN/1
 F1 F4

UN: R\$ 58,67 AV: R\$ 58,67 15: R\$ 59,90
 30: R\$ 61,09 45: R\$ 62,32 60: R\$ 63,56
 29 cm
 26,5 cm



VASO PL COLUNA RED PP LISO BEGE B50-1
 Código: Fábrica: Unidade:
40025 PAIOL UN/1
 F1 F4

UN: R\$ 61,62 AV: R\$ 61,62 15: R\$ 62,91
 30: R\$ 64,16 45: R\$ 65,45 60: R\$ 66,76
 29 cm
 26,5 cm



VASO PL COLUNA RED PP LISO CIMENTO B50-5
 Código: Fábrica: Unidade:
40026 PAIOL UN/1
 F1 F4

UN: R\$ 58,67 AV: R\$ 58,67 15: R\$ 59,90
 30: R\$ 61,09 45: R\$ 62,32 60: R\$ 63,56
 26 cm
 26,5 cm

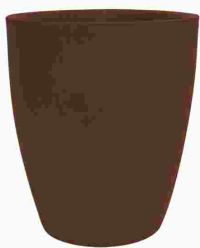

VASO PL COLUNA RED PP LISO MARROM B50-2
 Código: Fábrica: Unidade:
40024 PAIOL UN/1
 F1 F4

UN: R\$ 51,77 AV: R\$ 51,77 15: R\$ 52,85
 30: R\$ 53,91 45: R\$ 54,98 60: R\$ 56,08
 26 cm
 21,5 cm



VASO PL COLUNA RED PP MARRON 50-2
 Código: Fábrica: Unidade:
39947 PAIOL UN/1
 F1 F4

UN: R\$ 51,77 AV: R\$ 51,77 15: R\$ 52,85
 30: R\$ 53,91 45: R\$ 54,98 60: R\$ 56,08
 18,5 cm
 23 cm



VASO PL CONE BERLIAN GOLD PP AZUL A96-9
 Código: Fábrica: Unidade:
39942 PAIOL UN/1
 F1 F4

UN: R\$ 51,77 AV: R\$ 51,77 15: R\$ 52,85
 30: R\$ 53,91 45: R\$ 54,98 60: R\$ 56,08
 18,5 cm
 23 cm



VASO PL CONE BERLIAN GOLD PP BEGE A96-1
 Código: Fábrica: Unidade:
39940 PAIOL UN/1
 F1 F4

UN: R\$ 59,37 AV: R\$ 59,37 15: R\$ 60,61
 30: R\$ 61,82 45: R\$ 63,06 60: R\$ 64,32
 18,5 cm
 23 cm



VASO PL CONE BERLIAN GOLD PP MARRO A96-2
 Código: Fábrica: Unidade:
39939 PAIOL UN/1
 F1 F4

UN: R\$ 43,13 AV: R\$ 43,13 15: R\$ 44,03
 30: R\$ 44,91 45: R\$ 45,81 60: R\$ 46,73



VASO PL CONIC SINT S/BORDA M BANANAS011
 Código: Fábrica: Unidade:
41756 PAIOL UN/1
 F1 F4

UN: R\$ 30,81 AV: R\$ 30,81 15: R\$ 31,45
 30: R\$ 32,08 45: R\$ 32,72 60: R\$ 33,37
 21 cm
 24 cm



VASO PL CONIC SINT S/BORDA P BANANA3536
 Código: Fábrica: Unidade:
37124 PAIOL UN/1
 F1 F4

UN: R\$ 36,98 AV: R\$ 36,98 15: R\$ 37,75
 30: R\$ 38,50 45: R\$ 39,27 60: R\$ 40,06
 24 cm
 17 cm



VASO PL CRETA CONICO 24 BRANCO 3LTS
 Código: Fábrica: Unidade:
34605 NUTRIPLAN UN/1
 F1 F4

UN: R\$ 36,98 AV: R\$ 36,98 15: R\$ 37,75
30: R\$ 38,50 45: R\$ 39,27 60: R\$ 40,06

11 24 cm
17 cm



VASO PL CRETA CONICO 24 TABACO 3LTS

Código: 34604 Fábrica: NUTRIPLAN Unidade: UN/1 F1 F4

UN: R\$ 297,89 AV: R\$ 297,89 15: R\$ 304,09
30: R\$ 310,18 45: R\$ 316,38 60: R\$ 322,71

11 60 cm
42 cm

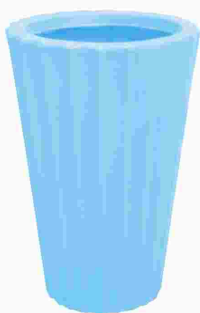

VASO PL CRETA CONICO 60 AZUL CELESTE 50L

Código: 35456 Fábrica: NUTRIPLAN Unidade: UN/1 F1 F4

UN: R\$ 207,49 AV: R\$ 207,49 15: R\$ 211,82
30: R\$ 216,05 45: R\$ 220,37 60: R\$ 224,78

11 60 cm
42 cm



VASO PL CRETA CONICO 60 ENVELHECIDO 50LT

Código: 34607 Fábrica: NUTRIPLAN Unidade: UN/1 F1 F4

UN: R\$ 16,42 AV: R\$ 16,42 15: R\$ 16,77
30: R\$ 17,10 45: R\$ 17,44 60: R\$ 17,79

11 12 cm
17 cm



VASO PL CRISANTEMO CONE CAPIM 2582

Código: 37107 Fábrica: PAIOL Unidade: UN/1 F1 F4

UN: R\$ 21,56 AV: R\$ 21,56 15: R\$ 22,01
30: R\$ 22,45 45: R\$ 22,90 60: R\$ 23,36

11 13 cm
18 cm



VASO PL CRISANTEMO CONE SINT ARGILA 2674

Código: 37105 Fábrica: PAIOL Unidade: UN/1 F1 F4

UN: R\$ 24,64 AV: R\$ 24,64 15: R\$ 25,16
30: R\$ 25,66 45: R\$ 26,17 60: R\$ 26,70

11 14 cm
18 cm



VASO PL CRISANTEMO CONE SINT BANANA 2674

Código: 40118 Fábrica: PAIOL Unidade: UN/1 F1 F4

UN: R\$ 27,72 AV: R\$ 27,72 15: R\$ 28,30
30: R\$ 28,87 45: R\$ 29,45 60: R\$ 30,03

11 14 cm
19 cm



VASO PL CRISANTEMO RED MAD C/LACO 1459

Código: 37109 Fábrica: PAIOL Unidade: UN/1 F1 F4

UN: R\$ 20,53 AV: R\$ 20,53 15: R\$ 20,96
30: R\$ 21,38 45: R\$ 21,81 60: R\$ 22,24

11 14 cm
18 cm



VASO PL CRISANTEMO RED MADEIRA PT/BC5914

Código: 37116 Fábrica: PAIOL Unidade: UN/1 F1 F4

UN: R\$ 16,18 AV: R\$ 16,18 15: R\$ 16,52
30: R\$ 16,85 45: R\$ 17,18 60: R\$ 17,53

11 14 cm
20 cm



VASO PL CRISANTEMO RED SINT ARGILA 40435

Código: 37132 Fábrica: PAIOL Unidade: UN/1 F1 F4

UN: R\$ 27,72 AV: R\$ 27,72 15: R\$ 28,30
30: R\$ 28,87 45: R\$ 29,45 60: R\$ 30,03

11 14 cm
18,5 cm



VASO PL CRISANTEMO RED TEXTURA LACO 3208

Código: 40614 Fábrica: PAIOL Unidade: UN/1 F1 F4

UN: R\$ 3,41 AV: R\$ 3,41 15: R\$ 3,48
30: R\$ 3,55 45: R\$ 3,62 60: R\$ 3,69



VASO PL CUIJA CLASSIC 22 MARROM/PRETO

Código: 30348 Fábrica: NUTRIPLAN Unidade: UN/1 F1 F4

UN: R\$ 2,87 AV: R\$ 2,87 15: R\$ 2,93
30: R\$ 2,98 45: R\$ 3,04 60: R\$ 3,10



VASO PL CUIJA CLASSIC 22 PRETO

Código: 30349 Fábrica: NUTRIPLAN Unidade: UN/1 F1 F4

UN: R\$ 8,73 AV: R\$ 8,73 15: R\$ 8,91
30: R\$ 9,09 45: R\$ 9,27 60: R\$ 9,46

11 12cm
22cm
2,7lts



VASO PL CUIJA NOBRE 1 C/PRATO MARROM

Código: 37857 Fábrica: NUTRIPLAN Unidade: UN/1 F1 F4

UN: R\$ 7,29 AV: R\$ 7,29 15: R\$ 7,45
30: R\$ 7,59 45: R\$ 7,75 60: R\$ 7,90

11 12cm
22cm
2,7lts



VASO PL CUIJA NOBRE 1 C/PRATO PRETO

Código: 38674 Fábrica: NUTRIPLAN Unidade: UN/1 F1 F4

UN: R\$ 8,21 AV: R\$ 8,21 15: R\$ 8,38
30: R\$ 8,55 45: R\$ 8,72 60: R\$ 8,89

11 13cm
27cm



VASO PL CUIJA NOBRE 1,5 PRETO 4,5LTS

Código: 48428 Fábrica: NUTRIPLAN Unidade: UN/1 F1 F4

UN: R\$ 9,23 AV: R\$ 9,23 15: R\$ 9,43
30: R\$ 9,62 45: R\$ 9,81 60: R\$ 10,00

11 6,5 cm
13 cm



VASO PL CUIJA SINT 13 S/BORDA BANAN 27066

Código: 37099 Fábrica: PAIOL Unidade: UN/1 F1 F4

UN: R\$ 7,49 AV: R\$ 7,49 15: R\$ 7,64
30: R\$ 7,80 45: R\$ 7,95 60: R\$ 8,11

 6,5 cm
 13 cm



VASO PL CUIA SINT 13 S/BORDA CAFE 27066
Código: Fábrica: Unidade:
39454 PAIOL UN/1
F1 F4

UN: R\$ 7,49 AV: R\$ 7,49 15: R\$ 7,64
30: R\$ 7,80 45: R\$ 7,95 60: R\$ 8,11



VASO PL CUIA SINT 13 S/BORDA CAPUC 27066
Código: Fábrica: Unidade:
42967 PAIOL UN/1
F1 F4

UN: R\$ 13,34 AV: R\$ 13,34 15: R\$ 13,62
30: R\$ 13,89 45: R\$ 14,17 60: R\$ 14,46

 9 cm
 18 cm



VASO PL CUIA SINT 17 S/BORDA BANAN 26910
Código: Fábrica: Unidade:
39455 PAIOL UN/1
F1 F4

UN: R\$ 13,34 AV: R\$ 13,34 15: R\$ 13,62
30: R\$ 13,89 45: R\$ 14,17 60: R\$ 14,46

 9,5 cm
 19 cm



VASO PL CUIA SINT 17 S/BORDA CAFE 26910
Código: Fábrica: Unidade:
37098 PAIOL UN/1
F1 F4

UN: R\$ 13,34 AV: R\$ 13,34 15: R\$ 13,62
30: R\$ 13,89 45: R\$ 14,17 60: R\$ 14,46

 9,5 cm
 19 cm



VASO PL CUIA SINT 17 S/BORDA CAPUC 26910
Código: Fábrica: Unidade:
39456 PAIOL UN/1
F1 F4

UN: R\$ 19,51 AV: R\$ 19,51 15: R\$ 19,91
30: R\$ 20,31 45: R\$ 20,72 60: R\$ 21,13

 10 cm
 21 cm



VASO PL CUIA SINT 20 S/BORDA ARGIL 26909
Código: Fábrica: Unidade:
39457 PAIOL UN/1
F1 F4

UN: R\$ 19,51 AV: R\$ 19,51 15: R\$ 19,91
30: R\$ 20,31 45: R\$ 20,72 60: R\$ 21,13

 10 cm
 22 cm



VASO PL CUIA SINT 20 S/BORDA BANAN 26909
Código: Fábrica: Unidade:
37097 PAIOL UN/1
F1 F4



UN: R\$ 19,74 AV: R\$ 19,74 15: R\$ 20,15
30: R\$ 20,56 45: R\$ 20,97 60: R\$ 21,39

 10 cm
 22 cm



VASO PL CUIA SINT 20 S/BORDA CAFE 26909
Código: Fábrica: Unidade:
39458 PAIOL UN/1
F1 F4

UN: R\$ 23,62 AV: R\$ 23,62 15: R\$ 24,11
30: R\$ 24,59 45: R\$ 25,08 60: R\$ 25,58

 11 cm
 25 cm



VASO PL CUIA SINT 25 S/BORDA ARGIL 40468
Código: Fábrica: Unidade:
39461 PAIOL UN/1
F1 F4

UN: R\$ 23,62 AV: R\$ 23,62 15: R\$ 24,11
30: R\$ 24,59 45: R\$ 25,08 60: R\$ 25,58

 11 cm
 26 cm



VASO PL CUIA SINT 25 S/BORDA BANAN 40468
Código: Fábrica: Unidade:
37096 PAIOL UN/1
F1 F4

UN: R\$ 24,37 AV: R\$ 24,37 15: R\$ 24,87
30: R\$ 25,37 45: R\$ 25,88 60: R\$ 26,40

 11 cm
 26 cm



VASO PL CUIA SINT 25 S/BORDA CAFE 40468
Código: Fábrica: Unidade:
39460 PAIOL UN/1
F1 F4

UN: R\$ 36,97 AV: R\$ 36,97 15: R\$ 37,74
30: R\$ 38,49 45: R\$ 39,26 60: R\$ 40,05

 12 cm
 31 cm



VASO PL CUIA SINT 28 S/BORDA ARG 26896-1
Código: Fábrica: Unidade:
37095 PAIOL UN/1
F1 F4

UN: R\$ 41,08 AV: R\$ 41,08 15: R\$ 41,93
30: R\$ 42,77 45: R\$ 43,63 60: R\$ 44,50

 13 cm
 34 cm



VASO PL CUIA SINT 32 S/BORDA ARGIL 50523
Código: Fábrica: Unidade:
37094 PAIOL UN/1
F1 F4

UN: R\$ 47,76 AV: R\$ 47,76 15: R\$ 48,76
30: R\$ 49,74 45: R\$ 50,73 60: R\$ 51,74

 32cm
 14cm



VASO PL CUIA SINT 32 S/BORDA BANAN 50523
Código: Fábrica: Unidade:
41055 PAIOL UN/1
F1 F4

UN: R\$ 71,89 AV: R\$ 71,89 15: R\$ 73,39
30: R\$ 74,86 45: R\$ 76,36 60: R\$ 77,88

 17 cm
 42 cm



VASO PL CUIA SINT 40 S/BORDA ARGIL 26944
Código: Fábrica: Unidade:
37093 PAIOL UN/1
F1 F4

UN: R\$ 3,13 AV: R\$ 3,13 15: R\$ 3,20
30: R\$ 3,26 45: R\$ 3,33 60: R\$ 3,39

 7 cm
 13 cm
 350 ml



VASO PL CUIA 13 PRETO C/ALCA 350ML 15
Código: Fábrica: Unidade:
38359 BIG PLAST UN/1
F1 F4

UN: R\$ 4,23 AV: R\$ 4,23 15: R\$ 4,32
30: R\$ 4,41 45: R\$ 4,49 60: R\$ 4,58

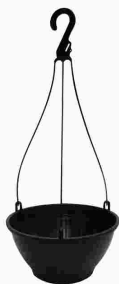

VASO PL CUIA 18 PRETO C/GANCHO 121
Código: 40795 Fábrica: NOVA BRASIL Unidade: UN/1 F1 F4

UN: R\$ 16,74 AV: R\$ 16,74 15: R\$ 17,09
30: R\$ 17,43 45: R\$ 17,78 60: R\$ 18,14



VASO PL CUIA 21 COLOR C/ALCA BA 2,4L 815
Código: 39854 Fábrica: BIG PLAST Unidade: UN/1 F1 F4

UN: R\$ 4,23 AV: R\$ 4,23 15: R\$ 4,32
30: R\$ 4,41 45: R\$ 4,49 60: R\$ 4,58

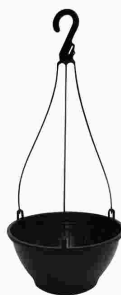

VASO PL CUIA 21 PRETO C/GANCHO 125
Código: 40796 Fábrica: NOVA BRASIL Unidade: UN/1 F1 F4

UN: R\$ 6,43 AV: R\$ 6,43 15: R\$ 6,56
30: R\$ 6,70 45: R\$ 6,83 60: R\$ 6,97



VASO PL CUIA 22 PRETO C/GANCHO 133
Código: 40797 Fábrica: NOVA BRASIL Unidade: UN/1 F1 F4

UN: R\$ 100,15 AV: R\$ 100,15 15: R\$ 102,24
30: R\$ 104,28 45: R\$ 106,37 60: R\$ 108,50

↑ 38 cm
↔ 26 cm



VASO PL DIAMANTE CONICO 38 AREIA 14LT
Código: 32744 Fábrica: NUTRIPLAN Unidade: UN/1 F1 F4

UN: R\$ 100,15 AV: R\$ 100,15 15: R\$ 102,24
30: R\$ 104,28 45: R\$ 106,37 60: R\$ 108,50

↑ 38 cm
↔ 26 cm



VASO PL DIAMANTE CONICO 38 FERRUGEM 14LT
Código: 32743 Fábrica: NUTRIPLAN Unidade: UN/1 F1 F4

UN: R\$ 83,20 AV: R\$ 83,20 15: R\$ 84,94
30: R\$ 86,64 45: R\$ 88,37 60: R\$ 90,14

↑ 22cm
↔ 24,9cm



VASO PL ELO REDONDO 22 CARVALHO 6,5 L
Código: 38923 Fábrica: NUTRIPLAN Unidade: UN/1 F1 F4

UN: R\$ 61,62 AV: R\$ 61,62 15: R\$ 62,91
30: R\$ 64,16 45: R\$ 65,45 60: R\$ 66,76

↑ 22cm
↔ 24,9cm



VASO PL ELO REDONDO 22 CIMENTO 6,5 L
Código: 38922 Fábrica: NUTRIPLAN Unidade: UN/1 F1 F4

UN: R\$ 83,20 AV: R\$ 83,20 15: R\$ 84,94
30: R\$ 86,64 45: R\$ 88,37 60: R\$ 90,14

↑ 22cm
↔ 24,9cm



VASO PL ELO REDONDO 22 ENVELHECIDO 6,5 L
Código: 38921 Fábrica: NUTRIPLAN Unidade: UN/1 F1 F4

UN: R\$ 61,62 AV: R\$ 61,62 15: R\$ 62,91
30: R\$ 64,16 45: R\$ 65,45 60: R\$ 66,76

↑ 22cm
↔ 24,9cm



VASO PL ELO REDONDO 22 PRETO 6,5 L
Código: 38920 Fábrica: NUTRIPLAN Unidade: UN/1 F1 F4

UN: R\$ 201,43 AV: R\$ 201,43 15: R\$ 205,63
30: R\$ 209,74 45: R\$ 213,94 60: R\$ 218,22

↑ 35cm
↔ 38,5cm



VASO PL ELO REDONDO 35 CARVALHO 27 L
Código: 38927 Fábrica: NUTRIPLAN Unidade: UN/1 F1 F4

UN: R\$ 143,80 AV: R\$ 143,80 15: R\$ 146,79
30: R\$ 149,73 45: R\$ 152,72 60: R\$ 155,78

↑ 35cm
↔ 38,5cm



VASO PL ELO REDONDO 35 CIMENTO 27 L
Código: 38926 Fábrica: NUTRIPLAN Unidade: UN/1 F1 F4

UN: R\$ 167,95 AV: R\$ 167,95 15: R\$ 171,45
30: R\$ 174,88 45: R\$ 178,37 60: R\$ 181,94

↑ 35cm
↔ 38,5cm



VASO PL ELO REDONDO 35 PRETO 27 L
Código: 38924 Fábrica: NUTRIPLAN Unidade: UN/1 F1 F4

UN: R\$ 1,34 AV: R\$ 1,34 15: R\$ 1,36
30: R\$ 1,39 45: R\$ 1,42 60: R\$ 1,45

↑ 7 cm
↔ 6 cm
▲ 160 ml



VASO PL ES 07 COLOR 160ML 386
Código: 38362 Fábrica: BIG PLAST Unidade: UN/1 F1 F4

UN: R\$ 2,98 AV: R\$ 2,98 15: R\$ 3,04
30: R\$ 3,10 45: R\$ 3,16 60: R\$ 3,23

↑ 16 cm
↔ 14 cm
▲ 1,9 Lts



VASO PL ES 16 PRETO 1,9L 400
Código: 38360 Fábrica: BIG PLAST Unidade: UN/1 F1 F4

UN: R\$ 41,08 AV: R\$ 41,08 15: R\$ 41,93
30: R\$ 42,77 45: R\$ 43,63 60: R\$ 44,50

↑ 24 cm
↔ 14 cm



VASO PL FACE HOMEM 24 BRANCO 2,75LT
Código: 42162 Fábrica: NUTRIPLAN Unidade: UN/1 F1 F4

UN: R\$ 41,08 AV: R\$ 41,08 15: R\$ 41,93
30: R\$ 42,77 45: R\$ 43,63 60: R\$ 44,50
17 cm
14 cm



VASO PL FACE HOMEM 24 CIMENTO 2,75LT
Código: 42159 Fábrica: NUTRIPLAN Unidade: UN/1 F1 F4

UN: R\$ 41,08 AV: R\$ 41,08 15: R\$ 41,93
30: R\$ 42,77 45: R\$ 43,63 60: R\$ 44,50
17 cm
14 cm



VASO PL FACE HOMEM 24 COBRE 2,75LT
Código: 42161 Fábrica: NUTRIPLAN Unidade: UN/1 F1 F4

UN: R\$ 41,08 AV: R\$ 41,08 15: R\$ 41,93
30: R\$ 42,77 45: R\$ 43,63 60: R\$ 44,50
17 cm
14 cm



VASO PL FACE HOMEM 24 PRETO 2,75LT
Código: 42163 Fábrica: NUTRIPLAN Unidade: UN/1 F1 F4

UN: R\$ 41,08 AV: R\$ 41,08 15: R\$ 41,93
30: R\$ 42,77 45: R\$ 43,63 60: R\$ 44,50
17 cm
16 cm



VASO PL FACE MULHER 17 BRANCO 2,19LT
Código: 42156 Fábrica: NUTRIPLAN Unidade: UN/1 F1 F4

UN: R\$ 41,08 AV: R\$ 41,08 15: R\$ 41,93
30: R\$ 42,77 45: R\$ 43,63 60: R\$ 44,50
17 cm
16 cm



VASO PL FACE MULHER 17 CIMENTO 2,19LT
Código: 42157 Fábrica: NUTRIPLAN Unidade: UN/1 F1 F4

UN: R\$ 41,08 AV: R\$ 41,08 15: R\$ 41,93
30: R\$ 42,77 45: R\$ 43,63 60: R\$ 44,50
17 cm
16 cm



VASO PL FACE MULHER 17 COBRE 2,19LT
Código: 42153 Fábrica: NUTRIPLAN Unidade: UN/1 F1 F4

UN: R\$ 41,08 AV: R\$ 41,08 15: R\$ 41,93
30: R\$ 42,77 45: R\$ 43,63 60: R\$ 44,50
17 cm
16 cm



VASO PL FACE MULHER 17 PRETO 2,19LT
Código: 42155 Fábrica: NUTRIPLAN Unidade: UN/1 F1 F4

UN: R\$ 138,66 AV: R\$ 138,66 15: R\$ 141,55
30: R\$ 144,38 45: R\$ 147,27 60: R\$ 150,21
34 cm
33 cm



VASO PL FACE MULHER 34 BRANCO 14,5LT
Código: 42164 Fábrica: NUTRIPLAN Unidade: UN/1 F1 F4

UN: R\$ 138,66 AV: R\$ 138,66 15: R\$ 141,55
30: R\$ 144,38 45: R\$ 147,27 60: R\$ 150,21
34 cm
33 cm



VASO PL FACE MULHER 34 PRETO 14,5LT
Código: 42165 Fábrica: NUTRIPLAN Unidade: UN/1 F1 F4

UN: R\$ 93,85 AV: R\$ 93,85 15: R\$ 95,80
30: R\$ 97,72 45: R\$ 99,67 60: R\$ 101,66



VASO PL FIBRA COCO PAREDE G 19,6X26X26CM
Código: 30294 Fábrica: NUTRIPLAN Unidade: UN/1 F1 F4

UN: R\$ 55,47 AV: R\$ 55,47 15: R\$ 56,62
30: R\$ 57,76 45: R\$ 58,91 60: R\$ 60,09



VASO PL FIBRA COCO PAREDE M 15,5X20,5CM
Código: 30293 Fábrica: NUTRIPLAN Unidade: UN/1 F1 F4

UN: R\$ 24,82 AV: R\$ 24,82 15: R\$ 25,33
30: R\$ 25,84 45: R\$ 26,36 60: R\$ 26,88
21 cm



VASO PL FIBRA DE COCO CONE 21,5X13X9CM
Código: 34907 Fábrica: NUTRIPLAN Unidade: UN/1 F1 F4

UN: R\$ 28,30 AV: R\$ 28,30 15: R\$ 28,89
30: R\$ 29,47 45: R\$ 30,06 60: R\$ 30,66
9,5 cm
16 cm



VASO PL FIBRA DE COCO 2 9,5X16X16CM
Código: 18499 Fábrica: NUTRIPLAN Unidade: UN/1 F1 F4

UN: R\$ 56,49 AV: R\$ 56,49 15: R\$ 57,66
30: R\$ 58,82 45: R\$ 59,99 60: R\$ 61,19
13 cm
25 cm



VASO PL FIBRA DE COCO 4 13X25,5X25,5CM
Código: 18501 Fábrica: NUTRIPLAN Unidade: UN/1 F1 F4

UN: R\$ 86,27 AV: R\$ 86,27 15: R\$ 88,07
30: R\$ 89,83 45: R\$ 91,63 60: R\$ 93,46
14 cm
31 cm



VASO PL FIBRA DE COCO 5 14X31X31CM
Código: 18502 Fábrica: NUTRIPLAN Unidade: UN/1 F1 F4

UN: R\$ 7,07 AV: R\$ 7,07 15: R\$ 7,22
30: R\$ 7,36 45: R\$ 7,51 60: R\$ 7,66
11 cm
34 cm
3 lts



VASO PL FLOREIRA MARRON 3 LITS 1377
Código: 37009 Fábrica: ERCAPLAST Unidade: UN/1 F1 F4

UN: R\$ 21,21 AV: R\$ 21,21 15: R\$ 21,65
30: R\$ 22,08 45: R\$ 22,52 60: R\$ 22,97

20 cm
24 cm
6,3 lts



VASO PL FLOREIRA 1 QUAD MARMORE

Código: 22303 Fábrica: NUTRIPLAN Unidade: UN/1 F1 F4

UN: R\$ 19,51 AV: R\$ 19,51 15: R\$ 19,91
30: R\$ 20,31 45: R\$ 20,72 60: R\$ 21,13

20 cm
24 cm
6,3 lts



VASO PL FLOREIRA 1 QUAD MARROM

Código: 22304 Fábrica: NUTRIPLAN Unidade: UN/1 F1 F4

UN: R\$ 6,97 AV: R\$ 6,97 15: R\$ 7,12
30: R\$ 7,26 45: R\$ 7,41 60: R\$ 7,56

4 L



VASO PL FLOREIRA 4 LTS MED PRETO 6704

Código: 41668 Fábrica: INPLAST Unidade: UN/1 F1 F4

UN: R\$ 143,81 AV: R\$ 143,81 15: R\$ 146,80
30: R\$ 149,74 45: R\$ 152,73 60: R\$ 155,79

48 cm
34 cm



VASO PL GRAFIATO CONICO 48 AREIA 25 L

Código: 30267 Fábrica: NUTRIPLAN Unidade: UN/1 F1 F4

UN: R\$ 143,81 AV: R\$ 143,81 15: R\$ 146,80
30: R\$ 149,74 45: R\$ 152,73 60: R\$ 155,79

48 cm
34 cm



VASO PL GRAFIATO CONICO 48 FERRUGEM 25 L

Código: 30266 Fábrica: NUTRIPLAN Unidade: UN/1 F1 F4

UN: R\$ 229,68 AV: R\$ 229,68 15: R\$ 234,47
30: R\$ 239,16 45: R\$ 243,94 60: R\$ 248,82

42 cm
37 cm
53 lts



VASO PL GRAFIATO OVAL 42 PRETO 53 LTS

Código: 33085 Fábrica: NUTRIPLAN Unidade: UN/1 F1 F4

UN: R\$ 142,86 AV: R\$ 142,86 15: R\$ 145,84
30: R\$ 148,76 45: R\$ 151,73 60: R\$ 154,77

22 cm
50 cm
45 lts



VASO PL GRAFIATO RED BAIX 22 CIMENTO 28L

Código: 36194 Fábrica: NUTRIPLAN Unidade: UN/1 F1 F4

UN: R\$ 142,86 AV: R\$ 142,86 15: R\$ 145,84
30: R\$ 148,76 45: R\$ 151,73 60: R\$ 154,77

22 cm
45 cm



VASO PL GRAFIATO REDONDO 22 AREIA 28 L

Código: 30276 Fábrica: NUTRIPLAN Unidade: UN/1 F1 F4

UN: R\$ 142,86 AV: R\$ 142,86 15: R\$ 145,84
30: R\$ 148,76 45: R\$ 151,73 60: R\$ 154,77

22 cm
45 cm



VASO PL GRAFIATO REDONDO 22 FERRUGEM 28 L

Código: 30275 Fábrica: NUTRIPLAN Unidade: UN/1 F1 F4

UN: R\$ 142,86 AV: R\$ 142,86 15: R\$ 145,84
30: R\$ 148,76 45: R\$ 151,73 60: R\$ 154,77

22 cm
45 cm
28 lts



VASO PL GRAFIATO REDONDO 22 TABACO 28 L

Código: 33084 Fábrica: NUTRIPLAN Unidade: UN/1 F1 F4

UN: R\$ 80,12 AV: R\$ 80,12 15: R\$ 81,79
30: R\$ 83,43 45: R\$ 85,10 60: R\$ 86,80

28,5 cm
22 cm



VASO PL GRAFIATO TRAPEZIO 28 FERRUGEM 8L

Código: 32751 Fábrica: NUTRIPLAN Unidade: UN/1 F1 F4

UN: R\$ 80,12 AV: R\$ 80,12 15: R\$ 81,79
30: R\$ 83,43 45: R\$ 85,10 60: R\$ 86,80

28 cm
22 cm
08 lts

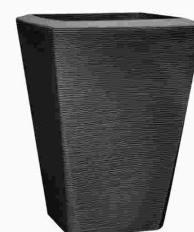

VASO PL GRAFIATO TRAPEZIO 28 PRETO 8L

Código: 36200 Fábrica: NUTRIPLAN Unidade: UN/1 F1 F4

UN: R\$ 120,18 AV: R\$ 120,18 15: R\$ 122,69
30: R\$ 125,14 45: R\$ 127,64 60: R\$ 130,20

35 cm
30 cm



VASO PL GRAFIATO TRAPEZIO 35 FERRUG 17 L

Código: 28675 Fábrica: NUTRIPLAN Unidade: UN/1 F1 F4

UN: R\$ 190,03 AV: R\$ 190,03 15: R\$ 193,99
30: R\$ 197,87 45: R\$ 201,83 60: R\$ 205,86

43 cm
34 cm



VASO PL GRAFIATO TRAPEZIO 43 AREIA 28 L

Código: 27474 Fábrica: NUTRIPLAN Unidade: UN/1 F1 F4

UN: R\$ 167,43 AV: R\$ 167,43 15: R\$ 170,92
30: R\$ 174,34 45: R\$ 177,83 60: R\$ 181,38

50 cm
37 cm
43 lts



VASO PL GRAFIATO TRAPEZIO 50 PRETO 43L

Código: 36201 Fábrica: NUTRIPLAN Unidade: UN/1 F1 F4

UN: R\$ 7,06 AV: R\$ 7,06 15: R\$ 7,20
30: R\$ 7,35 45: R\$ 7,49 60: R\$ 7,64

1,6 L



VASO PL GREGO PAREDE COLOR 1,6LTS 421

Código: 41524 Fábrica: ARIPLAS Unidade: UN/1 F1 F4

UN: R\$ 9,41 AV: R\$ 9,41 15: R\$ 9,61
30: R\$ 9,80 45: R\$ 10,00 60: R\$ 10,20
☒ 2,8 L



VASO PL GREGO PAREDE COLOR 2,8LTS 421
Código: Fábrica: Unidade:
41522 ARIPLAS UN/1
F1 F4

UN: R\$ 6,47 AV: R\$ 6,47 15: R\$ 6,60
30: R\$ 6,73 45: R\$ 6,87 60: R\$ 7,01
☒ 820ml



VASO PL GREGO PAREDE COLOR 820ML 422
Código: Fábrica: Unidade:
41527 ARIPLAS UN/1
F1 F4

UN: R\$ 7,06 AV: R\$ 7,06 15: R\$ 7,20
30: R\$ 7,35 45: R\$ 7,49 60: R\$ 7,64
☒ 1,6 L



VASO PL GREGO PAREDE PRETO 1,6LTS 421
Código: Fábrica: Unidade:
41526 ARIPLAS UN/1
F1 F4

UN: R\$ 9,41 AV: R\$ 9,41 15: R\$ 9,61
30: R\$ 9,80 45: R\$ 10,00 60: R\$ 10,20
☒ 2,8 L



VASO PL GREGO PAREDE PRETO 2,8LTS 424
Código: Fábrica: Unidade:
41523 ARIPLAS UN/1
F1 F4

UN: R\$ 6,47 AV: R\$ 6,47 15: R\$ 6,60
30: R\$ 6,73 45: R\$ 6,87 60: R\$ 7,01
☒ 820 ml



VASO PL GREGO PAREDE PRETO 820ML 422
Código: Fábrica: Unidade:
41528 ARIPLAS UN/1
F1 F4

UN: R\$ 7,06 AV: R\$ 7,06 15: R\$ 7,20
30: R\$ 7,35 45: R\$ 7,49 60: R\$ 7,64
☒ 2,2 L



VASO PL GREGO RED COLOR 2,2LTS 345
Código: Fábrica: Unidade:
41515 ARIPLAS UN/1
F1 F4

UN: R\$ 11,77 AV: R\$ 11,77 15: R\$ 12,01
30: R\$ 12,25 45: R\$ 12,50 60: R\$ 12,75
☒ 9 L



VASO PL GREGO RED COLOR 9 LTS 341
Código: Fábrica: Unidade:
41510 ARIPLAS UN/1
F1 F4

UN: R\$ 7,06 AV: R\$ 7,06 15: R\$ 7,20
30: R\$ 7,35 45: R\$ 7,49 60: R\$ 7,64
☒ 2,2 L



VASO PL GREGO RED PRETO 2,2LTS 346
Código: Fábrica: Unidade:
41514 ARIPLAS UN/1
F1 F4

UN: R\$ 9,41 AV: R\$ 9,41 15: R\$ 9,61
30: R\$ 9,80 45: R\$ 10,00 60: R\$ 10,20
☒ 4,8 L



VASO PL GREGO RED PRETO 4,8 LTS 344
Código: Fábrica: Unidade:
41513 ARIPLAS UN/1
F1 F4

UN: R\$ 11,77 AV: R\$ 11,77 15: R\$ 12,01
30: R\$ 12,25 45: R\$ 12,50 60: R\$ 12,75
☒ 9 L



VASO PL GREGO RED PRETO 9 LTS 342
Código: Fábrica: Unidade:
41511 ARIPLAS UN/1
F1 F4

UN: R\$ 0,43 AV: R\$ 0,43 15: R\$ 0,44
30: R\$ 0,45 45: R\$ 0,46 60: R\$ 0,47
☒ 5cm
☒ 5,8cm



VASO PL HOLAMBRA POTE NP06 PRETO 80ML
Código: Fábrica: Unidade:
39210 NUTRIPLAN UN/1
F1 F4

UN: R\$ 0,49 AV: R\$ 0,49 15: R\$ 0,50
30: R\$ 0,51 45: R\$ 0,52 60: R\$ 0,53
☒ 5cm
☒ 5,8cm



VASO PL HOLAMBRA POTE NP11 PRETO 415ML
Código: Fábrica: Unidade:
38917 NUTRIPLAN UN/1
F1 F4

UN: R\$ 1,08 AV: R\$ 1,08 15: R\$ 1,10
30: R\$ 1,12 45: R\$ 1,15 60: R\$ 1,17
☒ 9 cm
☒ 12 cm
☒ 0,7 lts



VASO PL HOLAMBRA POTE NP13 PRETO 725ML
Código: Fábrica: Unidade:
39211 NUTRIPLAN UN/1
F1 F4

UN: R\$ 1,18 AV: R\$ 1,18 15: R\$ 1,21
30: R\$ 1,23 45: R\$ 1,25 60: R\$ 1,28
☒ 9.8 cm
☒ 13 cm
☒ 1 lts



VASO PL HOLAMBRA POTE NP14 PRETO 1LT
Código: Fábrica: Unidade:
38918 NUTRIPLAN UN/1
F1 F4

UN: R\$ 1,28 AV: R\$ 1,28 15: R\$ 1,31
30: R\$ 1,34 45: R\$ 1,36 60: R\$ 1,39
☒ 10,5 cm
☒ 14,5 cm
☒ 1,16 lts



VASO PL HOLAMBRA POTE NP15 PRETO 1,16LT
Código: Fábrica: Unidade:
38919 NUTRIPLAN UN/1
F1 F4

UN: R\$ 6,48 AV: R\$ 6,48 15: R\$ 6,61
30: R\$ 6,75 45: R\$ 6,88 60: R\$ 7,02



VASO PL JARDINEIRA 2 LTS PRETA 3072
Código: Fábrica: Unidade:
40412 FORMPLAST UN/1
F1 F4

UN: R\$ 7,19 AV: R\$ 7,19 15: R\$ 7,34
30: R\$ 7,49 45: R\$ 7,64 60: R\$ 7,79



VASO PL JARDINEIRA 5 LTS PRETA 3080
Código: 40413 Fábrica: FORMPLAST Unidade: UN/1 F1 F4

UN: R\$ 102,71 AV: R\$ 102,71 15: R\$ 104,85
30: R\$ 106,95 45: R\$ 109,09 60: R\$ 111,27



VASO PL JARDINEIRA CAFE 1MT 145
Código: 37149 Fábrica: PAIOL Unidade: UN/1 F1 F4

UN: R\$ 56,49 AV: R\$ 56,49 15: R\$ 57,66
30: R\$ 58,82 45: R\$ 59,99 60: R\$ 61,19



VASO PL JARDINEIRA CAFE 40CM 148
Código: 37221 Fábrica: PAIOL Unidade: UN/1 F1 F4

UN: R\$ 44,17 AV: R\$ 44,17 15: R\$ 45,09
30: R\$ 45,99 45: R\$ 46,91 60: R\$ 47,85



VASO PL JARDINEIRA CAFE 60CM 0047
Código: 37151 Fábrica: PAIOL Unidade: UN/1 F1 F4

UN: R\$ 55,98 AV: R\$ 55,98 15: R\$ 57,15
30: R\$ 58,29 45: R\$ 59,46 60: R\$ 60,65



VASO PL JARDINEIRA CAFE 80CM 0046
Código: 37150 Fábrica: PAIOL Unidade: UN/1 F1 F4

UN: R\$ 12,96 AV: R\$ 12,96 15: R\$ 13,23
30: R\$ 13,49 45: R\$ 13,76 60: R\$ 14,04



VASO PL JARDINEIRA 10 LTS PRETA 3087
Código: 40414 Fábrica: FORMPLAST Unidade: UN/1 F1 F4

UN: R\$ 12,07 AV: R\$ 12,07 15: R\$ 12,32
30: R\$ 12,57 45: R\$ 12,82 60: R\$ 13,08



VASO PL JARDINEIRA 35 CM BRANCO 3,5L
Código: 13603 Fábrica: NUTRIPLAN Unidade: UN/1 F1 F4

UN: R\$ 13,34 AV: R\$ 13,34 15: R\$ 13,62
30: R\$ 13,89 45: R\$ 14,17 60: R\$ 14,46



VASO PL JARDINEIRA 35 CM CAPUCCINO 3,5L
Código: 35202 Fábrica: NUTRIPLAN Unidade: UN/1 F1 F4

UN: R\$ 12,07 AV: R\$ 12,07 15: R\$ 12,32
30: R\$ 12,57 45: R\$ 12,82 60: R\$ 13,08

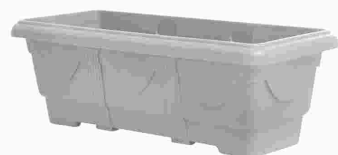

VASO PL JARDINEIRA 35 CM CINZA 3,5L
Código: 35203 Fábrica: NUTRIPLAN Unidade: UN/1 F1 F4

UN: R\$ 13,28 AV: R\$ 13,28 15: R\$ 13,56
30: R\$ 13,83 45: R\$ 14,11 60: R\$ 14,39



VASO PL JARDINEIRA 35 CM MARMORE 3,5L
Código: 30309 Fábrica: NUTRIPLAN Unidade: UN/1 F1 F4

UN: R\$ 13,34 AV: R\$ 13,34 15: R\$ 13,62
30: R\$ 13,89 45: R\$ 14,17 60: R\$ 14,46

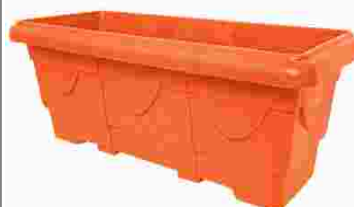

VASO PL JARDINEIRA 35 CM MARROM 3,5L
Código: 18507 Fábrica: NUTRIPLAN Unidade: UN/1 F1 F4

UN: R\$ 13,34 AV: R\$ 13,34 15: R\$ 13,62
30: R\$ 13,89 45: R\$ 14,17 60: R\$ 14,46



VASO PL JARDINEIRA 35 CM TABACO 3,5L
Código: 30308 Fábrica: NUTRIPLAN Unidade: UN/1 F1 F4

UN: R\$ 30,81 AV: R\$ 30,81 15: R\$ 31,45
30: R\$ 32,08 45: R\$ 32,72 60: R\$ 33,37



VASO PL JARDINEIRA 50 CM CAPUCCINO 11,5
Código: 35204 Fábrica: NUTRIPLAN Unidade: UN/1 F1 F4

UN: R\$ 28,75 AV: R\$ 28,75 15: R\$ 29,35
30: R\$ 29,94 45: R\$ 30,54 60: R\$ 31,15



VASO PL JARDINEIRA 50 CM CINZA 11,5L
Código: 35205 Fábrica: NUTRIPLAN Unidade: UN/1 F1 F4

UN: R\$ 63,95 AV: R\$ 63,95 15: R\$ 65,29
30: R\$ 66,59 45: R\$ 67,92 60: R\$ 69,28



VASO PL JARDINEIRA 80 CM CAPUCCINO 24,5L
Código: 35457 Fábrica: NUTRIPLAN Unidade: UN/1 F1 F4

UN: R\$ 63,95 AV: R\$ 63,95 15: R\$ 65,29
30: R\$ 66,59 45: R\$ 67,92 60: R\$ 69,28

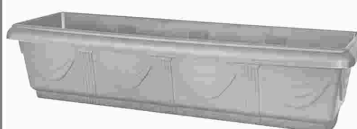

VASO PL JARDINEIRA 80 CM CINZA 34,5L
Código: 35458 Fábrica: NUTRIPLAN Unidade: UN/1 F1 F4

UN: R\$ 63,95 AV: R\$ 63,95 15: R\$ 65,29
 30: R\$ 66,59 45: R\$ 67,92 60: R\$ 69,28

11 cm
 35 cm

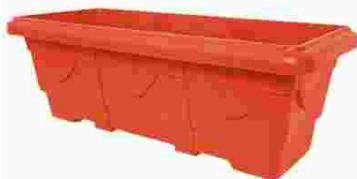

VASO PL JARDINEIRA 80 CM MARROM 24,5L

Código: 30310 Fábrica: NUTRIPLAN Unidade: UN/1 F1 F4

UN: R\$ 7,70 AV: R\$ 7,70 15: R\$ 7,86
 30: R\$ 8,02 45: R\$ 8,18 60: R\$ 8,35

20 cm
 14 cm
 2,1 lts



VASO PL KIREY COLOR 2,1L 391

Código: 37720 Fábrica: BIG PLAST Unidade: UN/1 F1 F4

UN: R\$ 86,70 AV: R\$ 86,70 15: R\$ 88,50
 30: R\$ 90,27 45: R\$ 92,08 60: R\$ 93,92

17 cm
 30 cm
 9 lts



VASO PL LUNA RED 17 TABACO 9LTS

Código: 37752 Fábrica: NUTRIPLAN Unidade: UN/1 F1 F4

UN: R\$ 78,07 AV: R\$ 78,07 15: R\$ 79,69
 30: R\$ 81,29 45: R\$ 82,91 60: R\$ 84,57

17 cm
 30 cm
 9 lts



VASO PL LUNA RED 17 CIMENTO 9LTS

Código: 37754 Fábrica: NUTRIPLAN Unidade: UN/1 F1 F4

UN: R\$ 107,86 AV: R\$ 107,86 15: R\$ 110,10
 30: R\$ 112,31 45: R\$ 114,55 60: R\$ 116,84

17 cm
 30 cm
 9 lts



VASO PL LUNA RED 17 ENVELHECIDO 9LTS

Código: 37753 Fábrica: NUTRIPLAN Unidade: UN/1 F1 F4

UN: R\$ 119,16 AV: R\$ 119,16 15: R\$ 121,64
 30: R\$ 124,07 45: R\$ 126,55 60: R\$ 129,08

47 cm
 31 cm
 18 lts



VASO PL MING CONICO 47 AREIA 18LTS

Código: 33641 Fábrica: NUTRIPLAN Unidade: UN/1 F1 F4

UN: R\$ 75,60 AV: R\$ 75,60 15: R\$ 77,18
 30: R\$ 78,72 45: R\$ 80,29 60: R\$ 81,90

23 cm
 36 cm
 12 lts



VASO PL MING RED BAIXO 23 AREIA 12LTS

Código: 33639 Fábrica: NUTRIPLAN Unidade: UN/1 F1 F4

UN: R\$ 75,60 AV: R\$ 75,60 15: R\$ 77,18
 30: R\$ 78,72 45: R\$ 80,29 60: R\$ 81,90

23 cm
 36 cm
 12 lts



VASO PL MING RED BAIXO 23 CIMENTO 12LTS

Código: 33640 Fábrica: NUTRIPLAN Unidade: UN/1 F1 F4

UN: R\$ 75,60 AV: R\$ 75,60 15: R\$ 77,18
 30: R\$ 78,72 45: R\$ 80,29 60: R\$ 81,90

23 cm
 36 cm
 12 lts



VASO PL MING RED BAIXO 23 FERRUGEM 12LTS

Código: 33644 Fábrica: NUTRIPLAN Unidade: UN/1 F1 F4

UN: R\$ 75,60 AV: R\$ 75,60 15: R\$ 77,18
 30: R\$ 78,72 45: R\$ 80,29 60: R\$ 81,90

23 cm
 36 cm
 12 lts



VASO PL MING RED BAIXO 23 GRANITO 12LTS

Código: 33638 Fábrica: NUTRIPLAN Unidade: UN/1 F1 F4

UN: R\$ 145,86 AV: R\$ 145,86 15: R\$ 148,90
 30: R\$ 151,88 45: R\$ 154,92 60: R\$ 158,02

33 cm
 53 cm
 44 lts



VASO PL MING RED BAIXO 33 AREIA 44LTS

Código: 33642 Fábrica: NUTRIPLAN Unidade: UN/1 F1 F4

UN: R\$ 163,84 AV: R\$ 163,84 15: R\$ 167,25
 30: R\$ 170,60 45: R\$ 174,01 60: R\$ 177,49

33 cm
 53 cm
 44 lts



VASO PL MING RED BAIXO 33 FERRUGEM 44LTS

Código: 33643 Fábrica: NUTRIPLAN Unidade: UN/1 F1 F4

UN: R\$ 62,66 AV: R\$ 62,66 15: R\$ 63,96
 30: R\$ 65,24 45: R\$ 66,55 60: R\$ 67,88

30 cm
 36 cm



VASO PL N99 VIME SINTETICO ARGILA 0106

Código: 37123 Fábrica: PAIOL Unidade: UN/1 F1 F4

UN: R\$ 51,77 AV: R\$ 51,77 15: R\$ 52,85
 30: R\$ 53,91 45: R\$ 54,98 60: R\$ 56,08

21,5 cm
 28 cm



VASO PL ONDULADO PEQ AZUL 84-7

Código: 39953 Fábrica: PAIOL Unidade: UN/1 F1 F4

UN: R\$ 51,77 AV: R\$ 51,77 15: R\$ 52,85
 30: R\$ 53,91 45: R\$ 54,98 60: R\$ 56,08

21,5 cm
 28 cm



VASO PL ONDULADO PEQ BEGE 84-1

Código: 39951 Fábrica: PAIOL Unidade: UN/1 F1 F4

UN: R\$ 51,77 AV: R\$ 51,77 15: R\$ 52,85
 30: R\$ 53,91 45: R\$ 54,98 60: R\$ 56,08

21,5 cm
 28 cm



VASO PL ONDULADO PEQ CIMENTO 84-5

Código: 39952 Fábrica: PAIOL Unidade: UN/1 F1 F4

UN: R\$ 51,77 AV: R\$ 51,77 15: R\$ 52,85
30: R\$ 53,91 45: R\$ 54,98 60: R\$ 56,08
11 21,5 cm
12 28 cm



VASO PL ONDULADO PEQ MARROM 84-2
Código: Fábrika: Unidade:
39950 PAIOL UN/1
F1 F4

UN: R\$ 89,57 AV: R\$ 89,57 15: R\$ 91,44
30: R\$ 93,27 45: R\$ 95,13 60: R\$ 97,03
11 22 cm
12 20 cm



VASO PL ORIGAMI RED 22 BRANCO 5,5LTS
Código: Fábrika: Unidade:
34615 NUTRIPLAN UN/1
F1 F4

UN: R\$ 89,57 AV: R\$ 89,57 15: R\$ 91,44
30: R\$ 93,27 45: R\$ 95,13 60: R\$ 97,03
11 22 cm
12 20 cm



VASO PL ORIGAMI RED 22 CIMENTO 5,5LTS
Código: Fábrika: Unidade:
34616 NUTRIPLAN UN/1
F1 F4

UN: R\$ 89,57 AV: R\$ 89,57 15: R\$ 91,44
30: R\$ 93,27 45: R\$ 95,13 60: R\$ 97,03
11 22 cm
12 20 cm



VASO PL ORIGAMI RED 22 ENVELHECIDO 5,5LTS
Código: Fábrika: Unidade:
34617 NUTRIPLAN UN/1
F1 F4

UN: R\$ 112,99 AV: R\$ 112,99 15: R\$ 115,35
30: R\$ 117,65 45: R\$ 120,01 60: R\$ 122,41
11 22 cm
12 20 cm



VASO PL ORIGAMI RED 22 RUBI 5,5LTS
Código: Fábrika: Unidade:
34618 NUTRIPLAN UN/1
F1 F4

UN: R\$ 30,81 AV: R\$ 30,81 15: R\$ 31,45
30: R\$ 32,08 45: R\$ 32,72 60: R\$ 33,37
11 19 cm
12 20 cm



VASO PL ORQUIDEA CONE SINT ARGILA 2673-1
Código: Fábrika: Unidade:
37104 PAIOL UN/1
F1 F4

UN: R\$ 30,81 AV: R\$ 30,81 15: R\$ 31,45
30: R\$ 32,08 45: R\$ 32,72 60: R\$ 33,37
11 19,5 cm
12 21 cm

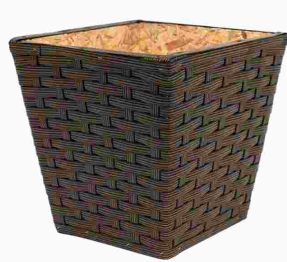

VASO PL ORQUIDEA CONE SINT ARGILA 2673-1
Código: Fábrika: Unidade:
40119 PAIOL UN/1
F1 F4

UN: R\$ 34,91 AV: R\$ 34,91 15: R\$ 35,64
30: R\$ 36,35 45: R\$ 37,08 60: R\$ 37,82
11 19,5 cm
12 21 cm



VASO PL ORQUIDEA CONE SINT BANANA 2673-2
Código: Fábrika: Unidade:
40120 PAIOL UN/1
F1 F4

UN: R\$ 43,13 AV: R\$ 43,13 15: R\$ 44,03
30: R\$ 44,91 45: R\$ 45,81 60: R\$ 46,73
11 23 cm
12 23 cm



VASO PL ORQUIDEA RED CAFE 00138
Código: Fábrika: Unidade:
37119 PAIOL UN/1
F1 F4

UN: R\$ 24,55 AV: R\$ 24,55 15: R\$ 25,06
30: R\$ 25,56 45: R\$ 26,07 60: R\$ 26,60
11 20 cm
12 23 cm



VASO PL ORQUIDEA RED MAD C/FLOR 1458/327
Código: Fábrika: Unidade:
37108 PAIOL UN/1
F1 F4

UN: R\$ 35,94 AV: R\$ 35,94 15: R\$ 36,69
30: R\$ 37,42 45: R\$ 38,17 60: R\$ 38,94
11 20 cm
12 20 cm



VASO PL ORQUIDEA RED MADEIRA PT/BC 5912
Código: Fábrika: Unidade:
37117 PAIOL UN/1
F1 F4

UN: R\$ 4,10 AV: R\$ 4,10 15: R\$ 4,18
30: R\$ 4,27 45: R\$ 4,35 60: R\$ 4,44
11 13 cm
12 26 cm
13 1,7 L



VASO PL PAREDE BELLA 1,7LTS PTO 9500
Código: Fábrika: Unidade:
45182 RISCHIOTO UN/1
F1 F4

UN: R\$ 43,76 AV: R\$ 43,76 15: R\$ 44,67
30: R\$ 45,56 45: R\$ 46,48 60: R\$ 47,40
11 18 cm
12 29 cm



VASO PL PAREDE GDE BANANA 27001-2
Código: Fábrika: Unidade:
37101 PAIOL UN/1
F1 F4

UN: R\$ 56,49 AV: R\$ 56,49 15: R\$ 57,66
30: R\$ 58,82 45: R\$ 59,99 60: R\$ 61,19
11 18 cm
12 29 cm



VASO PL PAREDE GDE C/BORD ARGILA 27001-1
Código: Fábrika: Unidade:
37100 PAIOL UN/1
F1 F4

UN: R\$ 6,17 AV: R\$ 6,17 15: R\$ 6,30
30: R\$ 6,43 45: R\$ 6,56 60: R\$ 6,69
11 18 cm
12 22 cm
13 1,6 lts



VASO PL PAREDE MARROM 1650 ML 2470
Código: Fábrika: Unidade:
37013 ERCAPLAST UN/1
F1 F4

UN: R\$ 9,80 AV: R\$ 9,80 15: R\$ 10,01
30: R\$ 10,21 45: R\$ 10,41 60: R\$ 10,62
11 17,5 cm
12 31 cm
13 3,4 lts



VASO PL PAREDE MARROM 3400 ML 2472
Código: Fábrika: Unidade:
37010 ERCAPLAST UN/1
F1 F4

UN: R\$ 4,71 AV: R\$ 4,71 15: R\$ 4,81
30: R\$ 4,91 45: R\$ 5,00 60: R\$ 5,10
11cm



VASO PL PAREDE MED PRETO 11CM 287
Código: 40715 Fábrica: PLASMARC Unidade: UN/1 F1 F4

UN: R\$ 16,42 AV: R\$ 16,42 15: R\$ 16,77
30: R\$ 17,10 45: R\$ 17,44 60: R\$ 17,79
17cm
32cm



VASO PL PAREDE MED VERDE
Código: 46045 Fábrica: NUTRIPLAN Unidade: UN/1 F1 F4

UN: R\$ 13,44 AV: R\$ 13,44 15: R\$ 13,72
30: R\$ 13,99 45: R\$ 14,27 60: R\$ 14,56



VASO PL PAREDE MEDIO MARROM
Código: 30313 Fábrica: NUTRIPLAN Unidade: UN/1 F1 F4

UN: R\$ 11,81 AV: R\$ 11,81 15: R\$ 12,06
30: R\$ 12,30 45: R\$ 12,55 60: R\$ 12,80



VASO PL PAREDE MEDIO PRETO
Código: 30314 Fábrica: NUTRIPLAN Unidade: UN/1 F1 F4

UN: R\$ 13,44 AV: R\$ 13,44 15: R\$ 13,72
30: R\$ 13,99 45: R\$ 14,27 60: R\$ 14,56



VASO PL PAREDE MEDIO TABACO
Código: 30312 Fábrica: NUTRIPLAN Unidade: UN/1 F1 F4

UN: R\$ 6,41 AV: R\$ 6,41 15: R\$ 6,54
30: R\$ 6,67 45: R\$ 6,81 60: R\$ 6,94
10 cm
20 cm



VASO PL PAREDE MINI MARROM
Código: 30316 Fábrica: NUTRIPLAN Unidade: UN/1 F1 F4

UN: R\$ 5,70 AV: R\$ 5,70 15: R\$ 5,82
30: R\$ 5,94 45: R\$ 6,05 60: R\$ 6,18



VASO PL PAREDE MINI PRETO
Código: 30315 Fábrica: NUTRIPLAN Unidade: UN/1 F1 F4

UN: R\$ 6,41 AV: R\$ 6,41 15: R\$ 6,54
30: R\$ 6,67 45: R\$ 6,81 60: R\$ 6,94



VASO PL PAREDE MINI TABACO
Código: 30317 Fábrica: NUTRIPLAN Unidade: UN/1 F1 F4

UN: R\$ 8,21 AV: R\$ 8,21 15: R\$ 8,38
30: R\$ 8,55 45: R\$ 8,72 60: R\$ 8,89
10cm
20cm



VASO PL PAREDE MINI VERDE
Código: 47605 Fábrica: NUTRIPLAN Unidade: UN/1 F1 F4

UN: R\$ 51,35 AV: R\$ 51,35 15: R\$ 52,42
30: R\$ 53,47 45: R\$ 54,54 60: R\$ 55,63
10,5 cm
16 cm



VASO PL PAREDE PEQ ARGILA 27005-1
Código: 37102 Fábrica: PAIOL Unidade: UN/1 F1 F4

UN: R\$ 4,48 AV: R\$ 4,48 15: R\$ 4,57
30: R\$ 4,66 45: R\$ 4,75 60: R\$ 4,85
8 cm



VASO PL PAREDE PEQ PRETO 8CM 255
Código: 40714 Fábrica: PLASMARC Unidade: UN/1 F1 F4

UN: R\$ 11,97 AV: R\$ 11,97 15: R\$ 12,22
30: R\$ 12,46 45: R\$ 12,71 60: R\$ 12,96
13 cm
26 cm
2 lts



VASO PL PAREDE PEQ VERDE
Código: 34611 Fábrica: NUTRIPLAN Unidade: UN/1 F1 F4

UN: R\$ 5,30 AV: R\$ 5,30 15: R\$ 5,41
30: R\$ 5,52 45: R\$ 5,63 60: R\$ 5,74
18 cm
22 cm
1,6 lts



VASO PL PAREDE PRETO 1650 ML 2469
Código: 37012 Fábrica: ERCAPLAST Unidade: UN/1 F1 F4

UN: R\$ 8,67 AV: R\$ 8,67 15: R\$ 8,85
30: R\$ 9,03 45: R\$ 9,21 60: R\$ 9,39
17,5 cm
31 cm
3,4 lts



VASO PL PAREDE PRETO 3400 ML 2471
Código: 37011 Fábrica: ERCAPLAST Unidade: UN/1 F1 F4

UN: R\$ 10,43 AV: R\$ 10,43 15: R\$ 10,64
30: R\$ 10,86 45: R\$ 11,07 60: R\$ 11,29
17 cm
30 cm
3 lts



VASO PL PAREDE 30 PRETO 3L 268
Código: 37701 Fábrica: BIG PLAST Unidade: UN/1 F1 F4

UN: R\$ 108,06 AV: R\$ 108,06 15: R\$ 110,31
30: R\$ 112,52 45: R\$ 114,77 60: R\$ 117,06
30 cm



VASO PL PETRA CONE 30 C/PRATO AREIA
Código: 36810 Fábrica: NUTRIPLAN Unidade: UN/1 F1 F4

UN: R\$ 108,06 AV: R\$ 108,06 15: R\$ 110,31
30: R\$ 112,52 45: R\$ 114,77 60: R\$ 117,06

30 cm



VASO PL PETRA CONE 30 C/PRATO FERRUGEM

Código: 36809 Fábrica: NUTRIPLAN Unidade: UN/1 F1 F4

UN: R\$ 0,98 AV: R\$ 0,98 15: R\$ 1,00
30: R\$ 1,02 45: R\$ 1,04 60: R\$ 1,06

8 cm
11 cm
300 ml



VASO PL PF 11 PRETO 300ML 130

Código: 38361 Fábrica: BIG PLAST Unidade: UN/1 F1 F4

UN: R\$ 4,61 AV: R\$ 4,61 15: R\$ 4,71
30: R\$ 4,80 45: R\$ 4,90 60: R\$ 5,00

5 cm
8 cm



VASO PL POTE SINT 07 S/BORDA ARGIL 60623

Código: 39437 Fábrica: PAIOL Unidade: UN/1 F1 F4

UN: R\$ 5,13 AV: R\$ 5,13 15: R\$ 5,23
30: R\$ 5,34 45: R\$ 5,44 60: R\$ 5,55

5 cm
8 cm



VASO PL POTE SINT 07 S/BORDA CAFE 60623

Código: 37087 Fábrica: PAIOL Unidade: UN/1 F1 F4

UN: R\$ 4,61 AV: R\$ 4,61 15: R\$ 4,71
30: R\$ 4,80 45: R\$ 4,90 60: R\$ 5,00

5 cm
8 cm



VASO PL POTE SINT 07 S/BORDA CAPUC 60623

Código: 39438 Fábrica: PAIOL Unidade: UN/1 F1 F4

UN: R\$ 6,51 AV: R\$ 6,51 15: R\$ 6,65
30: R\$ 6,78 45: R\$ 6,92 60: R\$ 7,06

7 cm
9 cm



VASO PL POTE SINT 09 S/BORDA CAFE 4046

Código: 39442 Fábrica: PAIOL Unidade: UN/1 F1 F4

UN: R\$ 6,51 AV: R\$ 6,51 15: R\$ 6,65
30: R\$ 6,78 45: R\$ 6,92 60: R\$ 7,06

7 cm
9 cm



VASO PL POTE SINT 09 S/BORDA CAPUCI 4046

Código: 39444 Fábrica: PAIOL Unidade: UN/1 F1 F4

UN: R\$ 7,80 AV: R\$ 7,80 15: R\$ 7,96
30: R\$ 8,12 45: R\$ 8,28 60: R\$ 8,45

7 cm
12 cm



VASO PL POTE SINT 11 S/BORDA ARGIL 40461

Código: 39439 Fábrica: PAIOL Unidade: UN/1 F1 F4

UN: R\$ 7,80 AV: R\$ 7,80 15: R\$ 7,96
30: R\$ 8,12 45: R\$ 8,28 60: R\$ 8,45

7 cm
12 cm



VASO PL POTE SINT 11 S/BORDA BANAN 40461

Código: 39440 Fábrica: PAIOL Unidade: UN/1 F1 F4

UN: R\$ 7,80 AV: R\$ 7,80 15: R\$ 7,96
30: R\$ 8,12 45: R\$ 8,28 60: R\$ 8,45

7 cm
9 cm



VASO PL POTE SINT 11 S/BORDA BRANC 40461

Código: 39441 Fábrica: PAIOL Unidade: UN/1 F1 F4

UN: R\$ 7,80 AV: R\$ 7,80 15: R\$ 7,96
30: R\$ 8,12 45: R\$ 8,28 60: R\$ 8,45

8 cm
10 cm



VASO PL POTE SINT 11 S/BORDA CAFE 40461

Código: 37084 Fábrica: PAIOL Unidade: UN/1 F1 F4

UN: R\$ 7,80 AV: R\$ 7,80 15: R\$ 7,96
30: R\$ 8,12 45: R\$ 8,28 60: R\$ 8,45

VASO PL POTE SINT 11 S/BORDA CAPUC 40461

Código: 39931 Fábrica: PAIOL Unidade: UN/1 F1 F4

UN: R\$ 21,56 AV: R\$ 21,56 15: R\$ 22,01
30: R\$ 22,45 45: R\$ 22,90 60: R\$ 23,36



VASO PL PRETO G 24LTS 650011

Código: 41204 Fábrica: PLASTSU Unidade: UN/1 F1 F4

UN: R\$ 22,37 AV: R\$ 22,37 15: R\$ 22,84
30: R\$ 23,29 45: R\$ 23,76 60: R\$ 24,24



VASO PL PRETO M 951710

Código: 41202 Fábrica: PLASTSU Unidade: UN/1 F1 F4

UN: R\$ 20,02 AV: R\$ 20,02 15: R\$ 20,43
30: R\$ 20,84 45: R\$ 21,26 60: R\$ 21,68



VASO PL PRETO P 9LTS 951314

Código: 41200 Fábrica: PLASTSU Unidade: UN/1 F1 F4

UN: R\$ 5,77 AV: R\$ 5,77 15: R\$ 5,89
30: R\$ 6,01 45: R\$ 6,13 60: R\$ 6,25

13 cm
17 cm
1,9 L



VASO PL PRIMAVERA 2 RED PEQ MARROM 3 L

Código: 33540 Fábrica: NUTRIPLAN Unidade: UN/1 F1 F4

UN: R\$ 4,15 AV: R\$ 4,15 15: R\$ 4,24
 30: R\$ 4,32 45: R\$ 4,41 60: R\$ 4,50





VASO PL PRIMAVERA 2 RED PEQ PRETO 3 L
 Código: 33541 Fábrica: NUTRIPLAN Unidade: UN/1
 F1 F4

UN: R\$ 4,62 AV: R\$ 4,62 15: R\$ 4,72
 30: R\$ 4,81 45: R\$ 4,91 60: R\$ 5,01





VASO PL PRIMAVERA 3 RED PEQ MARROM 3 L
 Código: 22164 Fábrica: NUTRIPLAN Unidade: UN/1
 F1 F4

UN: R\$ 5,26 AV: R\$ 5,26 15: R\$ 5,37
 30: R\$ 5,48 45: R\$ 5,59 60: R\$ 5,70





VASO PL PRIMAVERA 3 RED PEQ PRETO 3L
 Código: 22168 Fábrica: NUTRIPLAN Unidade: UN/1
 F1 F4

UN: R\$ 11,23 AV: R\$ 11,23 15: R\$ 11,46
 30: R\$ 11,69 45: R\$ 11,92 60: R\$ 12,16





VASO PL PRIMAVERA 4 RED MED MARROM
 Código: 22165 Fábrica: NUTRIPLAN Unidade: UN/1
 F1 F4

UN: R\$ 11,23 AV: R\$ 11,23 15: R\$ 11,46
 30: R\$ 11,69 45: R\$ 11,92 60: R\$ 12,16





VASO PL PRIMAVERA 4 RED MED PRETO
 Código: 33542 Fábrica: NUTRIPLAN Unidade: UN/1
 F1 F4

UN: R\$ 11,30 AV: R\$ 11,30 15: R\$ 11,53
 30: R\$ 11,77 45: R\$ 12,00 60: R\$ 12,24



VASO PL PRIMAVERA 5 RED MED CINZA
 Código: 35215 Fábrica: NUTRIPLAN Unidade: UN/1
 F1 F4

UN: R\$ 14,11 AV: R\$ 14,11 15: R\$ 14,41
 30: R\$ 14,70 45: R\$ 14,99 60: R\$ 15,29



VASO PL PRIMAVERA 5 RED MED MARROM
 Código: 22166 Fábrica: NUTRIPLAN Unidade: UN/1
 F1 F4

UN: R\$ 12,33 AV: R\$ 12,33 15: R\$ 12,58
 30: R\$ 12,83 45: R\$ 13,09 60: R\$ 13,35



VASO PL PRIMAVERA 5 RED MED PRETO
 Código: 22170 Fábrica: NUTRIPLAN Unidade: UN/1
 F1 F4

UN: R\$ 18,90 AV: R\$ 18,90 15: R\$ 19,29
 30: R\$ 19,68 45: R\$ 20,07 60: R\$ 20,48



VASO PL PRIMAVERA 6 RED GDE MARROM 6 L
 Código: 22167 Fábrica: NUTRIPLAN Unidade: UN/1
 F1 F4

UN: R\$ 17,10 AV: R\$ 17,10 15: R\$ 17,46
 30: R\$ 17,81 45: R\$ 18,16 60: R\$ 18,53



VASO PL PRIMAVERA 6 RED GDE PRETO
 Código: 22171 Fábrica: NUTRIPLAN Unidade: UN/1
 F1 F4

UN: R\$ 131,48 AV: R\$ 131,48 15: R\$ 134,22
 30: R\$ 136,91 45: R\$ 139,64 60: R\$ 142,44

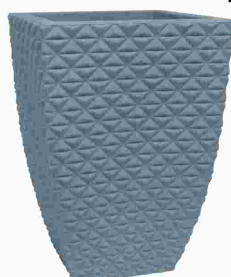



VASO PL QUAD BERLIAN GOLD P AZUL A82-9
 Código: 40031 Fábrica: PAIOL Unidade: UN/1
 F1 F4

UN: R\$ 131,48 AV: R\$ 131,48 15: R\$ 134,22
 30: R\$ 136,91 45: R\$ 139,64 60: R\$ 142,44



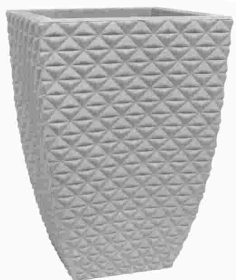

VASO PL QUAD BERLIAN GOLD P BEGE A82-1
 Código: 40029 Fábrica: PAIOL Unidade: UN/1
 F1 F4

UN: R\$ 131,48 AV: R\$ 131,48 15: R\$ 134,22
 30: R\$ 136,91 45: R\$ 139,64 60: R\$ 142,44





VASO PL QUAD BERLIAN GOLD P CIMENT A82-5
 Código: 40030 Fábrica: PAIOL Unidade: UN/1
 F1 F4

UN: R\$ 143,80 AV: R\$ 143,80 15: R\$ 146,79
 30: R\$ 149,73 45: R\$ 152,72 60: R\$ 155,78





VASO PL QUAD BERLIAN GOLD P MAROM A82-2
 Código: 40028 Fábrica: PAIOL Unidade: UN/1
 F1 F4

UN: R\$ 58,54 AV: R\$ 58,54 15: R\$ 59,76
 30: R\$ 60,95 45: R\$ 62,17 60: R\$ 63,42



VASO PL QUAD BOJO 0 AZUL 53-7
 Código: 39946 Fábrica: PAIOL Unidade: UN/1
 F1 F4

UN: R\$ 51,77 AV: R\$ 51,77 15: R\$ 52,85
 30: R\$ 53,91 45: R\$ 54,98 60: R\$ 56,08



VASO PL QUAD BOJO 0 BEGE 53-2
 Código: 39944 Fábrica: PAIOL Unidade: UN/1
 F1 F4

UN: R\$ 51,77 AV: R\$ 51,77 15: R\$ 52,85
 30: R\$ 53,91 45: R\$ 54,98 60: R\$ 56,08
 27 cm
 19,5 cm

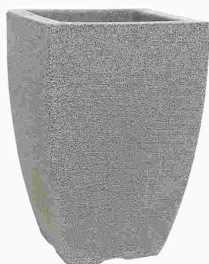

VASO PL QUAD BOJO 0 CIMENTO 53-4
 Código: 39945 Fábrica: PAIOL Unidade: UN/1 F1 F4

UN: R\$ 51,77 AV: R\$ 51,77 15: R\$ 52,85
 30: R\$ 53,91 45: R\$ 54,98 60: R\$ 56,08
 27 cm
 19,5 cm



VASO PL QUAD BOJO 0 MARROM 53-3
 Código: 39943 Fábrica: PAIOL Unidade: UN/1 F1 F4

UN: R\$ 6,82 AV: R\$ 6,82 15: R\$ 6,96
 30: R\$ 7,10 45: R\$ 7,24 60: R\$ 7,39
 1,7 L



VASO PL QUAD COLOR 1,7LTS 403
 Código: 41516 Fábrica: ARIPLAS Unidade: UN/1 F1 F4

UN: R\$ 8,23 AV: R\$ 8,23 15: R\$ 8,41
 30: R\$ 8,57 45: R\$ 8,75 60: R\$ 8,92
 3,5 L



VASO PL QUAD COLOR 3,5LTS 405
 Código: 41518 Fábrica: ARIPLAS Unidade: UN/1 F1 F4

UN: R\$ 10,59 AV: R\$ 10,59 15: R\$ 10,81
 30: R\$ 11,03 45: R\$ 11,25 60: R\$ 11,47
 6 L



VASO PL QUAD COLOR 6,4LTS 407
 Código: 41520 Fábrica: ARIPLAS Unidade: UN/1 F1 F4

UN: R\$ 5,07 AV: R\$ 5,07 15: R\$ 5,17
 30: R\$ 5,27 45: R\$ 5,38 60: R\$ 5,49
 14 cm
 16 cm
 2 lts



VASO PL QUAD MARROM 2,0 LTS 1332
 Código: 36988 Fábrica: ERCAPLAST Unidade: UN/1 F1 F4

UN: R\$ 8,86 AV: R\$ 8,86 15: R\$ 9,04
 30: R\$ 9,22 45: R\$ 9,41 60: R\$ 9,60
 19 cm
 22 cm
 4,6 lts



VASO PL QUAD MARROM 4,6 LTS 1334
 Código: 36987 Fábrica: ERCAPLAST Unidade: UN/1 F1 F4

UN: R\$ 2,43 AV: R\$ 4,85 15: R\$ 4,95
 30: R\$ 5,05 45: R\$ 5,15 60: R\$ 5,26
 11 cm
 18 cm
 0,8 lts



VASO PL QUAD MARROM 800 ML 1384 2X1
 Código: 36990 Fábrica: ERCAPLAST Unidade: CJ/2 F1 F4

UN: R\$ 6,82 AV: R\$ 6,82 15: R\$ 6,96
 30: R\$ 7,10 45: R\$ 7,24 60: R\$ 7,39
 1,7 L



VASO PL QUAD PRETO 1,7LTS 404
 Código: 41517 Fábrica: ARIPLAS Unidade: UN/1 F1 F4

UN: R\$ 4,59 AV: R\$ 4,59 15: R\$ 4,69
 30: R\$ 4,78 45: R\$ 4,88 60: R\$ 4,98
 14 cm
 16 cm
 2 lts



VASO PL QUAD PRETO 2,0 LTS 1331
 Código: 36989 Fábrica: ERCAPLAST Unidade: UN/1 F1 F4

UN: R\$ 7,65 AV: R\$ 7,65 15: R\$ 7,80
 30: R\$ 7,96 45: R\$ 8,12 60: R\$ 8,28
 3,5 L



VASO PL QUAD PRETO 3,5LTS 406
 Código: 41519 Fábrica: ARIPLAS Unidade: UN/1 F1 F4

UN: R\$ 10,00 AV: R\$ 10,00 15: R\$ 10,21
 30: R\$ 10,41 45: R\$ 10,62 60: R\$ 10,84
 6 L



VASO PL QUAD PRETO 6,4LTS 408
 Código: 41521 Fábrica: ARIPLAS Unidade: UN/1 F1 F4

UN: R\$ 2,24 AV: R\$ 4,48 15: R\$ 4,57
 30: R\$ 4,66 45: R\$ 4,75 60: R\$ 4,85
 11 cm
 18 cm
 0,8 lts



VASO PL QUAD PRETO 800 ML 1383 2X1
 Código: 36991 Fábrica: ERCAPLAST Unidade: CJ/2 F1 F4

UN: R\$ 15,57 AV: R\$ 15,57 15: R\$ 15,90
 30: R\$ 16,22 45: R\$ 16,54 60: R\$ 16,87
 24 cm
 28 cm
 9,5 lts



VASO PL QUAD PRETO 9,5 LTS 1349
 Código: 36985 Fábrica: ERCAPLAST Unidade: UN/1 F1 F4

UN: R\$ 20,53 AV: R\$ 20,53 15: R\$ 20,96
 30: R\$ 21,38 45: R\$ 21,81 60: R\$ 22,24
 11 cm
 16 cm
 0,85 lts



VASO PL QUARTZO 11 FERRUGEM 0,85 LTS
 Código: 37845 Fábrica: NUTRIPLAN Unidade: UN/1 F1 F4

UN: R\$ 48,89 AV: R\$ 48,89 15: R\$ 49,91
 30: R\$ 50,91 45: R\$ 51,93 60: R\$ 52,97
 16 cm
 23 cm
 4,75 lts



VASO PL QUARTZO 16 FERRUGEM 4,75 LTS
 Código: 37846 Fábrica: NUTRIPLAN Unidade: UN/1 F1 F4

UN: R\$ 77,04 AV: R\$ 77,04 15: R\$ 78,65
 30: R\$ 80,22 45: R\$ 81,82 60: R\$ 83,46
 12,5 cm
 25 cm
 8 lts



VASO PL QUARTZO 22 FERRUGEM 8LTS
 Código: 37847 Fábrica: NUTRIPLAN Unidade: UN/1
 F1 F4

UN: R\$ 90,39 AV: R\$ 90,39 15: R\$ 92,28
 30: R\$ 94,12 45: R\$ 96,00 60: R\$ 97,92
 30 cm
 43 cm
 25 lts



VASO PL QUARTZO 30 FERRUGEM 25LTS
 Código: 37848 Fábrica: NUTRIPLAN Unidade: UN/1
 F1 F4

UN: R\$ 38,01 AV: R\$ 38,01 15: R\$ 38,80
 30: R\$ 39,57 45: R\$ 40,37 60: R\$ 41,17
 18,5 cm
 23 cm



VASO PL RED BOJO CONE 0 BEGE 96-1
 Código: 39934 Fábrica: PAIOL Unidade: UN/1
 F1 F4

UN: R\$ 38,01 AV: R\$ 38,01 15: R\$ 38,80
 30: R\$ 39,57 45: R\$ 40,37 60: R\$ 41,17
 18,5 cm
 23 cm



VASO PL RED BOJO CONE 0 CIMENTO 96-5
 Código: 39933 Fábrica: PAIOL Unidade: UN/1
 F1 F4

UN: R\$ 76,01 AV: R\$ 76,01 15: R\$ 77,60
 30: R\$ 79,15 45: R\$ 80,73 60: R\$ 82,35
 29 cm
 34 cm



VASO PL RED BOJO CONE 1 AZUL 73-7
 Código: 39938 Fábrica: PAIOL Unidade: UN/1
 F1 F4

UN: R\$ 76,01 AV: R\$ 76,01 15: R\$ 77,60
 30: R\$ 79,15 45: R\$ 80,73 60: R\$ 82,35
 29 cm
 34 cm



VASO PL RED BOJO CONE 1 BEGE 73-2
 Código: 39936 Fábrica: PAIOL Unidade: UN/1
 F1 F4

UN: R\$ 76,01 AV: R\$ 76,01 15: R\$ 77,60
 30: R\$ 79,15 45: R\$ 80,73 60: R\$ 82,35
 29 cm
 34 cm



VASO PL RED BOJO CONE 1 MARRON 73-1
 Código: 39935 Fábrica: PAIOL Unidade: UN/1
 F1 F4

UN: R\$ 11,76 AV: R\$ 11,76 15: R\$ 12,00
 30: R\$ 12,24 45: R\$ 12,49 60: R\$ 12,74
 16 cm
 27 cm
 6 lts



VASO PL RED CANELADO PRETO 6L C/ALCA 2617
 Código: 37002 Fábrica: ERCAPLAST Unidade: UN/1
 F1 F4

UN: R\$ 9,38 AV: R\$ 9,38 15: R\$ 9,57
 30: R\$ 9,76 45: R\$ 9,96 60: R\$ 10,16
 12,5 cm
 25 cm
 3 lts



VASO PL RED CUJA COLOR 3L 2598
 Código: 37006 Fábrica: ERCAPLAST Unidade: UN/1
 F1 F4

UN: R\$ 2,50 AV: R\$ 4,99 15: R\$ 5,10
 30: R\$ 5,20 45: R\$ 5,31 60: R\$ 5,41
 11 cm
 12 cm
 0,7 lts



VASO PL RED MARRON 700 ML 1382 2X1
 Código: 36984 Fábrica: ERCAPLAST Unidade: CJ/2
 F1 F4

UN: R\$ 14,18 AV: R\$ 14,18 15: R\$ 14,48
 30: R\$ 14,77 45: R\$ 15,06 60: R\$ 15,37
 37 cm
 28 cm
 7,5 lts



VASO PL RED MARRON 7,5 LTS 1323
 Código: 36979 Fábrica: ERCAPLAST Unidade: UN/1
 F1 F4

UN: R\$ 7,99 AV: R\$ 7,99 15: R\$ 8,16
 30: R\$ 8,32 45: R\$ 8,49 60: R\$ 8,66



VASO PL RED PRETO N22 3,7LTS 926
 Código: 51043 Fábrica: LUMAR Unidade: UN/1
 F1 F4

UN: R\$ 12,94 AV: R\$ 12,94 15: R\$ 13,21
 30: R\$ 13,48 45: R\$ 13,75 60: R\$ 14,02



VASO PL RED PRETO N28 8,0LTS 915
 Código: 51044 Fábrica: LUMAR Unidade: UN/1
 F1 F4

UN: R\$ 23,13 AV: R\$ 23,13 15: R\$ 23,61
 30: R\$ 24,09 45: R\$ 24,57 60: R\$ 25,06



VASO PL RED PRETO N36 16LTS 916
 Código: 51045 Fábrica: LUMAR Unidade: UN/1
 F1 F4

UN: R\$ 24,44 AV: R\$ 24,44 15: R\$ 24,95
 30: R\$ 25,45 45: R\$ 25,96 60: R\$ 26,48
 31 cm
 35 cm
 15 lts



VASO PL RED PRETO 15 LTS 1328
 Código: 36977 Fábrica: ERCAPLAST Unidade: UN/1
 F1 F4

UN: R\$ 5,07 AV: R\$ 5,07 15: R\$ 5,17
 30: R\$ 5,27 45: R\$ 5,38 60: R\$ 5,49
 14 cm
 17 cm
 1,75 lts



VASO PL RED PRETO 1,75 LTS 1305
 Código: 36982 Fábrica: ERCAPLAST Unidade: UN/1
 F1 F4

UN: R\$ 6,86 AV: R\$ 6,86 15: R\$ 7,00
30: R\$ 7,14 45: R\$ 7,28 60: R\$ 7,43

118 cm
22 cm
3,8 lts



VASO PL RED PRETO 3,8 LTS 1306

Código: 36981 Fábrica: ERCAPLAST Unidade: UN/1 F1 F4

UN: R\$ 2,30 AV: R\$ 4,59 15: R\$ 4,69
30: R\$ 4,78 45: R\$ 4,88 60: R\$ 4,98

111 cm
12 cm
0,7 lts



VASO PL RED PRETO 700 ML 1381 2X1

Código: 36983 Fábrica: ERCAPLAST Unidade: CJ/2 F1 F4

UN: R\$ 12,49 AV: R\$ 12,49 15: R\$ 12,75
30: R\$ 13,00 45: R\$ 13,26 60: R\$ 13,53

137 cm
28 cm
7,5 lts



VASO PL RED PRETO 7,5 LTS 1322

Código: 36978 Fábrica: ERCAPLAST Unidade: UN/1 F1 F4

UN: R\$ 205,43 AV: R\$ 205,43 15: R\$ 209,71
30: R\$ 213,90 45: R\$ 218,18 60: R\$ 222,55

148 cm
40 cm



VASO PL RED RELEVO 40 PRETO

Código: 41387 Fábrica: NUTRIPLAN Unidade: UN/1 F1 F4

UN: R\$ 192,08 AV: R\$ 192,08 15: R\$ 196,08
30: R\$ 200,00 45: R\$ 204,00 60: R\$ 208,08

148 cm
40 cm



VASO PL RED RELEVO 40 TABACO

Código: 41386 Fábrica: NUTRIPLAN Unidade: UN/1 F1 F4

UN: R\$ 225,47 AV: R\$ 225,47 15: R\$ 230,17
30: R\$ 234,77 45: R\$ 239,47 60: R\$ 244,26

124 cm
54 cm



VASO PL RELEVO OVAL 23 CARVALHO

Código: 44137 Fábrica: NUTRIPLAN Unidade: UN/1 F1 F4

UN: R\$ 276,06 AV: R\$ 276,06 15: R\$ 281,81
30: R\$ 287,45 45: R\$ 293,20 60: R\$ 299,06

142 cm
40 cm



VASO PL RELEVO OVAL 42 CARVALHO

Código: 44139 Fábrica: NUTRIPLAN Unidade: UN/1 F1 F4

UN: R\$ 230,08 AV: R\$ 230,08 15: R\$ 234,88
30: R\$ 239,57 45: R\$ 244,36 60: R\$ 249,25

142 cm
40 cm



VASO PL RELEVO OVAL 42 CIMENTO

Código: 44140 Fábrica: NUTRIPLAN Unidade: UN/1 F1 F4

UN: R\$ 246,52 AV: R\$ 246,52 15: R\$ 251,65
30: R\$ 256,69 45: R\$ 261,82 60: R\$ 267,06

167 cm
48 cm



VASO PL RELEVO REDONDO 67 97LT CIMENTO

Código: 42183 Fábrica: NUTRIPLAN Unidade: UN/1 F1 F4

UN: R\$ 308,15 AV: R\$ 308,15 15: R\$ 314,57
30: R\$ 320,86 45: R\$ 327,28 60: R\$ 333,82

167 cm
48 cm



VASO PL RELEVO REDONDO 67 97LT CIMENTO Q

Código: 42184 Fábrica: NUTRIPLAN Unidade: UN/1 F1 F4

UN: R\$ 308,15 AV: R\$ 308,15 15: R\$ 314,57
30: R\$ 320,86 45: R\$ 327,28 60: R\$ 333,82

167 cm
48 cm



VASO PL RELEVO REDONDO 67 97LT OURO ENVE

Código: 42185 Fábrica: NUTRIPLAN Unidade: UN/1 F1 F4

UN: R\$ 142,43 AV: R\$ 142,43 15: R\$ 145,40
30: R\$ 148,31 45: R\$ 151,27 60: R\$ 154,30

142 cm
30 cm



VASO PL RISCATTO CONICO 42 FERRUGEM 20LT

Código: 30280 Fábrica: NUTRIPLAN Unidade: UN/1 F1 F4

UN: R\$ 142,43 AV: R\$ 142,43 15: R\$ 145,40
30: R\$ 148,31 45: R\$ 151,27 60: R\$ 154,30

142 cm
30 cm

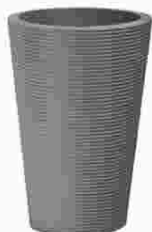

VASO PL RISCATTO CONICO 42 GRANITO 20LTS

Código: 30281 Fábrica: NUTRIPLAN Unidade: UN/1 F1 F4

UN: R\$ 239,85 AV: R\$ 239,85 15: R\$ 244,85
30: R\$ 249,75 45: R\$ 254,74 60: R\$ 259,83

155 cm
39 cm



VASO PL RISCATTO CONICO 55 FERRUGEM 44LT

Código: 30282 Fábrica: NUTRIPLAN Unidade: UN/1 F1 F4

UN: R\$ 166,84 AV: R\$ 166,84 15: R\$ 170,31
30: R\$ 173,72 45: R\$ 177,19 60: R\$ 180,74

155 cm
39 cm



VASO PL RISCATTO CONICO 55 GRANITO 44LTS

Código: 30283 Fábrica: NUTRIPLAN Unidade: UN/1 F1 F4

UN: R\$ 83,51 AV: R\$ 83,51 15: R\$ 85,25
30: R\$ 86,96 45: R\$ 88,70 60: R\$ 90,47

142 cm
31 cm



VASO PL RISCATTO OVAL BAIXO 22 AREIA 12L

Código: 30270 Fábrica: NUTRIPLAN Unidade: UN/1 F1 F4

UN: R\$ 83,51 AV: R\$ 83,51 15: R\$ 85,25
 30: R\$ 86,96 45: R\$ 88,70 60: R\$ 90,47





VASO PL RISCATTO OVAL BAIXO 22 FERRU 12L
 Código: 30271 Fábrica: NUTRIPLAN Unidade: UN/1
 F1 F4

UN: R\$ 83,51 AV: R\$ 83,51 15: R\$ 85,25
 30: R\$ 86,96 45: R\$ 88,70 60: R\$ 90,47





VASO PL RISCATTO OVAL BAIXO 22 GRANI 12L
 Código: 37410 Fábrica: NUTRIPLAN Unidade: UN/1
 F1 F4

UN: R\$ 147,92 AV: R\$ 147,92 15: R\$ 151,00
 30: R\$ 154,02 45: R\$ 157,10 60: R\$ 160,24





VASO PL RISCATTO OVAL BAIXO 30 AREIA 32L
 Código: 30269 Fábrica: NUTRIPLAN Unidade: UN/1
 F1 F4

UN: R\$ 147,92 AV: R\$ 147,92 15: R\$ 151,00
 30: R\$ 154,02 45: R\$ 157,10 60: R\$ 160,24





VASO PL RISCATTO OVAL BAIXO 30 FERRU 32L
 Código: 30268 Fábrica: NUTRIPLAN Unidade: UN/1
 F1 F4

UN: R\$ 109,71 AV: R\$ 109,71 15: R\$ 111,99
 30: R\$ 114,23 45: R\$ 116,51 60: R\$ 118,85





VASO PL RISCATTO RED 34 AREIA 26,5LT
 Código: 30272 Fábrica: NUTRIPLAN Unidade: UN/1
 F1 F4

UN: R\$ 113,61 AV: R\$ 113,61 15: R\$ 115,98
 30: R\$ 118,29 45: R\$ 120,66 60: R\$ 123,07





VASO PL RISCATTO RED 34 FERRUGEM 26,5LTS
 Código: 30273 Fábrica: NUTRIPLAN Unidade: UN/1
 F1 F4

UN: R\$ 109,71 AV: R\$ 109,71 15: R\$ 111,99
 30: R\$ 114,23 45: R\$ 116,51 60: R\$ 118,85





VASO PL RISCATTO RED 34 GRANITO 26,5LTS
 Código: 30274 Fábrica: NUTRIPLAN Unidade: UN/1
 F1 F4

UN: R\$ 2,79 AV: R\$ 2,79 15: R\$ 2,85
 30: R\$ 2,91 45: R\$ 2,97 60: R\$ 3,03





VASO PL ROMANO RED MINI MARROM 0,6L
 Código: 22309 Fábrica: NUTRIPLAN Unidade: UN/1
 F1 F4

UN: R\$ 8,65 AV: R\$ 8,65 15: R\$ 8,83
 30: R\$ 9,01 45: R\$ 9,19 60: R\$ 9,37





VASO PL ROMANO 0 RED PEQ MARROM 2L
 Código: 22308 Fábrica: NUTRIPLAN Unidade: UN/1
 F1 F4

UN: R\$ 7,19 AV: R\$ 7,19 15: R\$ 7,34
 30: R\$ 7,49 45: R\$ 7,64 60: R\$ 7,79





VASO PL ROMANO 0 RED PEQ PRETO 2L
 Código: 39641 Fábrica: NUTRIPLAN Unidade: UN/1
 F1 F4

UN: R\$ 16,66 AV: R\$ 16,66 15: R\$ 17,01
 30: R\$ 17,35 45: R\$ 17,70 60: R\$ 18,05





VASO PL ROMANO 1 RED MED MARROM 5L
 Código: 22307 Fábrica: NUTRIPLAN Unidade: UN/1
 F1 F4

UN: R\$ 14,18 AV: R\$ 14,18 15: R\$ 14,47
 30: R\$ 14,76 45: R\$ 15,06 60: R\$ 15,36





VASO PL ROMANO 1 RED MED PRETO 5L
 Código: 39642 Fábrica: NUTRIPLAN Unidade: UN/1
 F1 F4

UN: R\$ 22,96 AV: R\$ 22,96 15: R\$ 23,44
 30: R\$ 23,90 45: R\$ 24,38 60: R\$ 24,87





VASO PL ROMANO 2 RED GDE MARROM 8,5L
 Código: 22306 Fábrica: NUTRIPLAN Unidade: UN/1
 F1 F4

UN: R\$ 19,52 AV: R\$ 19,52 15: R\$ 19,92
 30: R\$ 20,32 45: R\$ 20,73 60: R\$ 21,14



VASO PL ROMANO 2 RED PRETO 8,5L
 Código: 39643 Fábrica: NUTRIPLAN Unidade: UN/1
 F1 F4

UN: R\$ 23,11 AV: R\$ 23,11 15: R\$ 23,59
 30: R\$ 24,07 45: R\$ 24,55 60: R\$ 25,04





VASO PL ROMANO 2 RED TABACO 8,5L
 Código: 39855 Fábrica: NUTRIPLAN Unidade: UN/1
 F1 F4

UN: R\$ 27,73 AV: R\$ 27,73 15: R\$ 28,31
 30: R\$ 28,88 45: R\$ 29,46 60: R\$ 30,05





VASO PL ROMANO 3 RED CAPUCCINO 19L
 Código: 36195 Fábrica: NUTRIPLAN Unidade: UN/1
 F1 F4

UN: R\$ 35,95 AV: R\$ 35,95 15: R\$ 36,70
 30: R\$ 37,44 45: R\$ 38,18 60: R\$ 38,95
 30 cm
 39 cm





VASO PL ROMANO 3 RED MARROM 19 L
 Código: Fábrica: Unidade:
22305 NUTRIPLAN UN/1
 F1 F4

UN: R\$ 37,18 AV: R\$ 37,18 15: R\$ 37,96
 30: R\$ 38,72 45: R\$ 39,49 60: R\$ 40,28
 19 lts





VASO PL ROMANO 3 RED PRETO 19 L
 Código: Fábrica: Unidade:
39644 NUTRIPLAN UN/1
 F1 F4

UN: R\$ 8,53 AV: R\$ 8,53 15: R\$ 8,70
 30: R\$ 8,88 45: R\$ 9,06 60: R\$ 9,24
 10 cm
 13 cm





VASO PL SINT 13 S/BORDA ARGILA 0908-1
 Código: Fábrica: Unidade:
37083 PAIOL UN/1
 F1 F4

UN: R\$ 8,21 AV: R\$ 8,21 15: R\$ 8,38
 30: R\$ 8,55 45: R\$ 8,72 60: R\$ 8,89
 10 cm
 14,5 cm



VASO PL SINT 13 S/BORDA BANANA 0908-2
 Código: Fábrica: Unidade:
39445 PAIOL UN/1
 F1 F4

UN: R\$ 15,15 AV: R\$ 15,15 15: R\$ 15,47
 30: R\$ 15,78 45: R\$ 16,09 60: R\$ 16,41
 14 cm
 15 cm





VASO PL SINT 16 S/BORDA BANANA 3598-2
 Código: Fábrica: Unidade:
37082 PAIOL UN/1
 F1 F4

UN: R\$ 15,15 AV: R\$ 15,15 15: R\$ 15,47
 30: R\$ 15,78 45: R\$ 16,09 60: R\$ 16,41



VASO PL SINT 16 S/BORDA CAPUCINO 3598
 Código: Fábrica: Unidade:
39465 PAIOL UN/1
 F1 F4

UN: R\$ 20,53 AV: R\$ 20,53 15: R\$ 20,96
 30: R\$ 21,38 45: R\$ 21,81 60: R\$ 22,24
 20 cm
 15 cm





VASO PL SINT 18 S/BORDA ARGILA 909-1
 Código: Fábrica: Unidade:
37081 PAIOL UN/1
 F1 F4

UN: R\$ 20,53 AV: R\$ 20,53 15: R\$ 20,96
 30: R\$ 21,38 45: R\$ 21,81 60: R\$ 22,24



VASO PL SINT 18 S/BORDA BANANA 909-2
 Código: Fábrica: Unidade:
40843 PAIOL UN/1
 F1 F4

UN: R\$ 20,53 AV: R\$ 20,53 15: R\$ 20,96
 30: R\$ 21,38 45: R\$ 21,81 60: R\$ 22,24
 15 cm
 20 cm



VASO PL SINT 18 S/BORDA CAFE 909-4
 Código: Fábrica: Unidade:
39462 PAIOL UN/1
 F1 F4

UN: R\$ 20,53 AV: R\$ 20,53 15: R\$ 20,96
 30: R\$ 21,38 45: R\$ 21,81 60: R\$ 22,24





VASO PL SINT 18 S/BORDA CAPUCINO 909
 Código: Fábrica: Unidade:
39463 PAIOL UN/1
 F1 F4

UN: R\$ 30,81 AV: R\$ 30,81 15: R\$ 31,45
 30: R\$ 32,08 45: R\$ 32,72 60: R\$ 33,37





VASO PL SINT 20 S/BORDA BANANA 8006-4
 Código: Fábrica: Unidade:
40844 PAIOL UN/1
 F1 F4

UN: R\$ 36,97 AV: R\$ 36,97 15: R\$ 37,74
 30: R\$ 38,49 45: R\$ 39,26 60: R\$ 40,05
 2,5 cm
 66 cm



VASO PL SINT 24 S/BORDA BANANA 3538-2
 Código: Fábrica: Unidade:
37089 PAIOL UN/1
 F1 F4

UN: R\$ 36,97 AV: R\$ 36,97 15: R\$ 37,74
 30: R\$ 38,49 45: R\$ 39,26 60: R\$ 40,05
 19 cm
 25 cm



VASO PL SINT 24 S/BORDA CAPUCINO 3538-3
 Código: Fábrica: Unidade:
39929 PAIOL UN/1
 F1 F4

UN: R\$ 41,08 AV: R\$ 41,08 15: R\$ 41,93
 30: R\$ 42,77 45: R\$ 43,63 60: R\$ 44,50





VASO PL SINT 27 S/BORDA ARGILA 3541-1
 Código: Fábrica: Unidade:
41755 PAIOL UN/1
 F1 F4

UN: R\$ 46,91 AV: R\$ 46,91 15: R\$ 47,89
 30: R\$ 48,85 45: R\$ 49,82 60: R\$ 50,82
 30 cm
 24 cm



VASO PL SINT 27 S/BORDA BANANA 3541-2
 Código: Fábrica: Unidade:
37088 PAIOL UN/1
 F1 F4

UN: R\$ 91,71 AV: R\$ 91,71 15: R\$ 93,62
 30: R\$ 95,49 45: R\$ 97,40 60: R\$ 99,35
 34 cm
 42 cm



VASO PL SINT 98 C/BORDA ARGILA 26958-1
 Código: Fábrica: Unidade:
37122 PAIOL UN/1
 F1 F4

UN: R\$ 4,06 AV: R\$ 4,06 15: R\$ 4,14
30: R\$ 4,22 45: R\$ 4,31 60: R\$ 4,40

11 5 cm
12 7 cm



VASO PL SISAL POTE MINI AVELA 8000-4

Código: Fábrica: Unidade:
40594 PAIOL UN/1
F1 F4

UN: R\$ 4,06 AV: R\$ 4,06 15: R\$ 4,14
30: R\$ 4,22 45: R\$ 4,31 60: R\$ 4,40

11 5 cm
12 7 cm



VASO PL SISAL POTE MINI MARROM 8000-1

Código: Fábrica: Unidade:
40592 PAIOL UN/1
F1 F4

UN: R\$ 5,13 AV: R\$ 5,13 15: R\$ 5,23
30: R\$ 5,34 45: R\$ 5,44 60: R\$ 5,55

11 5,5 cm
12 7,5 cm



VASO PL SISAL POTE MINI NATURAL 8000-2

Código: Fábrica: Unidade:
37131 PAIOL UN/1
F1 F4

UN: R\$ 6,52 AV: R\$ 6,52 15: R\$ 6,66
30: R\$ 6,79 45: R\$ 6,93 60: R\$ 7,07



VASO PL SISAL POTE 10 AVELA 8001

Código: Fábrica: Unidade:
39448 PAIOL UN/1
F1 F4

UN: R\$ 6,52 AV: R\$ 6,52 15: R\$ 6,66
30: R\$ 6,79 45: R\$ 6,93 60: R\$ 7,07



VASO PL SISAL POTE 10 CARAMELO 8001

Código: Fábrica: Unidade:
39449 PAIOL UN/1
F1 F4

UN: R\$ 6,52 AV: R\$ 6,52 15: R\$ 6,66
30: R\$ 6,79 45: R\$ 6,93 60: R\$ 7,07



VASO PL SISAL POTE 10 MARROM 8001

Código: Fábrica: Unidade:
39447 PAIOL UN/1
F1 F4

UN: R\$ 6,78 AV: R\$ 6,78 15: R\$ 6,92
30: R\$ 7,06 45: R\$ 7,20 60: R\$ 7,34

11 8 cm
12 11 cm



VASO PL SISAL POTE 10 NATURAL 8001-3

Código: Fábrica: Unidade:
37130 PAIOL UN/1
F1 F4

UN: R\$ 9,14 AV: R\$ 9,14 15: R\$ 9,33
30: R\$ 9,52 45: R\$ 9,71 60: R\$ 9,90

11 9 cm
12 13 cm



VASO PL SISAL POTE 12 CORES 8002

Código: Fábrica: Unidade:
37129 PAIOL UN/1
F1 F4

UN: R\$ 10,48 AV: R\$ 10,48 15: R\$ 10,70
30: R\$ 10,91 45: R\$ 11,13 60: R\$ 11,35

11 10 cm
12 15 cm



VASO PL SISAL POTE 14 CORES 8003

Código: Fábrica: Unidade:
37128 PAIOL UN/1
F1 F4

UN: R\$ 11,92 AV: R\$ 11,92 15: R\$ 12,16
30: R\$ 12,41 45: R\$ 12,66 60: R\$ 12,91

11 12 cm
12 16 cm



VASO PL SISAL POTE 16 CORES 8004

Código: Fábrica: Unidade:
37127 PAIOL UN/1
F1 F4

UN: R\$ 21,26 AV: R\$ 21,26 15: R\$ 21,71
30: R\$ 22,14 45: R\$ 22,58 60: R\$ 23,03

11 25 cm
12 30 cm



VASO PL TERRACOTA 2 MED MARROM

Código: Fábrica: Unidade:
18480 NUTRIPLAN UN/1
F1 F4

UN: R\$ 36,81 AV: R\$ 36,81 15: R\$ 37,58
30: R\$ 38,33 45: R\$ 39,10 60: R\$ 39,88

11 31 cm
12 39 cm



VASO PL TERRACOTA 3 GDE MARROM 22 L

Código: Fábrica: Unidade:
18482 NUTRIPLAN UN/1
F1 F4

UN: R\$ 31,84 AV: R\$ 31,84 15: R\$ 32,51
30: R\$ 33,16 45: R\$ 33,82 60: R\$ 34,50

1 22 lts



VASO PL TERRACOTA 3 GDE PTO 22 L

Código: Fábrica: Unidade:
18483 NUTRIPLAN UN/1
F1 F4

UN: R\$ 59,83 AV: R\$ 59,83 15: R\$ 61,08
30: R\$ 62,30 45: R\$ 63,55 60: R\$ 64,82

1 19cm



VASO PL TEXTURIZADO OVAL 19 AREIA 5,3L

Código: Fábrica: Unidade:
47612 NUTRIPLAN UN/1
F1 F4

UN: R\$ 59,83 AV: R\$ 59,83 15: R\$ 61,08
30: R\$ 62,30 45: R\$ 63,55 60: R\$ 64,82

1 19cm



VASO PL TEXTURIZADO OVAL 19 CIMENTO 5,3L

Código: Fábrica: Unidade:
47614 NUTRIPLAN UN/1
F1 F4

UN: R\$ 59,83 AV: R\$ 59,83 15: R\$ 61,08
30: R\$ 62,30 45: R\$ 63,55 60: R\$ 64,82

1 19cm



VASO PL TEXTURIZADO OVAL 19 FERRUGEM 5,3L

Código: Fábrica: Unidade:
47611 NUTRIPLAN UN/1
F1 F4

UN: R\$ 59,83 AV: R\$ 59,83 15: R\$ 61,08
30: R\$ 62,30 45: R\$ 63,55 60: R\$ 64,82

19cm



VASO PL TEXTURIZADO OVAL 19 GRANITO 5,3L

Código: 47613 Fábrica: NUTRIPLAN Unidade: UN/1 F1 F4

UN: R\$ 59,83 AV: R\$ 59,83 15: R\$ 61,08
30: R\$ 62,30 45: R\$ 63,55 60: R\$ 64,82

19cm



VASO PL TEXTURIZADO OVAL 19 PRETO 5,3L

Código: 47615 Fábrica: NUTRIPLAN Unidade: UN/1 F1 F4

UN: R\$ 156,13 AV: R\$ 156,13 15: R\$ 159,39
30: R\$ 162,57 45: R\$ 165,83 60: R\$ 169,14

34 cm
41 cm



VASO PL TINA RED 34 CARVALHO 30LTS

Código: 30311 Fábrica: NUTRIPLAN Unidade: UN/1 F1 F4

UN: R\$ 247,56 AV: R\$ 247,56 15: R\$ 252,71
30: R\$ 257,77 45: R\$ 262,92 60: R\$ 268,18

45 cm
54 cm



VASO PL TINA RED 45 CARVALHO 80LTS

Código: 30332 Fábrica: NUTRIPLAN Unidade: UN/1 F1 F4

UN: R\$ 59,58 AV: R\$ 59,58 15: R\$ 60,82
30: R\$ 62,04 45: R\$ 63,28 60: R\$ 64,54

30 cm
14 cm
6,5 lts



VASO PL TRECCIA CONICO 30 CARVALHO 6,5LT

Código: 33388 Fábrica: NUTRIPLAN Unidade: UN/1 F1 F4

UN: R\$ 88,33 AV: R\$ 88,33 15: R\$ 90,17
30: R\$ 91,97 45: R\$ 93,81 60: R\$ 95,69

30 cm
14 cm
6,5 lts



VASO PL TRECCIA CONICO 30 ENVELHECI 6,5L

Código: 32745 Fábrica: NUTRIPLAN Unidade: UN/1 F1 F4

UN: R\$ 71,49 AV: R\$ 71,49 15: R\$ 72,98
30: R\$ 74,44 45: R\$ 75,93 60: R\$ 77,45

39 cm
30 cm
33 lts



VASO PL TRECCIA CONICO 39 GRAFITE 33LTS

Código: 36806 Fábrica: NUTRIPLAN Unidade: UN/1 F1 F4

UN: R\$ 267,07 AV: R\$ 267,07 15: R\$ 272,64
30: R\$ 278,09 45: R\$ 283,65 60: R\$ 289,32

53 cm
36 cm



VASO PL TRECCIA CONICO 53 CARVALHO 42LTS

Código: 32747 Fábrica: NUTRIPLAN Unidade: UN/1 F1 F4

UN: R\$ 92,45 AV: R\$ 92,45 15: R\$ 94,37
30: R\$ 96,26 45: R\$ 98,19 60: R\$ 100,15

33 cm
43 cm



VASO PL TRECCIA OVAL 33 CARVALHO 19LTS

Código: 32748 Fábrica: NUTRIPLAN Unidade: UN/1 F1 F4

UN: R\$ 80,12 AV: R\$ 80,12 15: R\$ 81,79
30: R\$ 83,43 45: R\$ 85,10 60: R\$ 86,80

24 cm
26,5 cm
8,5 lts



VASO PL TRECCIA RED 24 CARVALHO 8,5LTS

Código: 33389 Fábrica: NUTRIPLAN Unidade: UN/1 F1 F4

UN: R\$ 80,92 AV: R\$ 80,92 15: R\$ 82,61
30: R\$ 84,26 45: R\$ 85,95 60: R\$ 87,67

24 cm
26,5 cm
8,5 lts



VASO PL TRECCIA RED 24 ENVELHECIDO 8,5LT

Código: 33390 Fábrica: NUTRIPLAN Unidade: UN/1 F1 F4

UN: R\$ 80,12 AV: R\$ 80,12 15: R\$ 81,79
30: R\$ 83,43 45: R\$ 85,10 60: R\$ 86,80

24 cm
26,5 cm
8,5 lts



VASO PL TRECCIA RED 24 RUBI 8,5LTS

Código: 33391 Fábrica: NUTRIPLAN Unidade: UN/1 F1 F4

UN: R\$ 159,21 AV: R\$ 159,21 15: R\$ 162,52
30: R\$ 165,77 45: R\$ 169,09 60: R\$ 172,47

31 cm
34 cm
20 lts



VASO PL TRECCIA RED 31 CARVALHO 20LTS

Código: 33393 Fábrica: NUTRIPLAN Unidade: UN/1 F1 F4

UN: R\$ 123,26 AV: R\$ 123,26 15: R\$ 125,83
30: R\$ 128,35 45: R\$ 130,92 60: R\$ 133,53

31 cm
34 cm
20 lts



VASO PL TRECCIA RED 31 ENVELHECIDO 20LTS

Código: 32749 Fábrica: NUTRIPLAN Unidade: UN/1 F1 F4

UN: R\$ 90,39 AV: R\$ 90,39 15: R\$ 92,28
30: R\$ 94,12 45: R\$ 96,00 60: R\$ 97,92

31 cm
34 cm
20 lts



VASO PL TRECCIA RED 31 GRAFITE 20LTS

Código: 36804 Fábrica: NUTRIPLAN Unidade: UN/1 F1 F4

UN: R\$ 90,39 AV: R\$ 90,39 15: R\$ 92,28
30: R\$ 94,12 45: R\$ 96,00 60: R\$ 97,92

31 cm
34 cm
20 lts



VASO PL TRECCIA RED 31 MARINHO 20LTS

Código: 36805 Fábrica: NUTRIPLAN Unidade: UN/1 F1 F4

UN: R\$ 90,39 AV: R\$ 90,39 15: R\$ 92,28
 30: R\$ 94,12 45: R\$ 96,00 60: R\$ 97,92
 31 cm
 34 cm
 20 lts



VASO PL TRECCIA RED 31 RUBI 20LTS

Código: 33394 Fábrica: NUTRIPLAN Unidade: UN/1 F1 F4

UN: R\$ 4,59 AV: R\$ 4,59 15: R\$ 4,69
 30: R\$ 4,78 45: R\$ 4,88 60: R\$ 4,98
 09 cm



VASO PL TREVO PRETO 09CM 226

Código: 40716 Fábrica: PLASMARC Unidade: UN/1 F1 F4

UN: R\$ 9,91 AV: R\$ 9,91 15: R\$ 10,12
 30: R\$ 10,32 45: R\$ 10,53 60: R\$ 10,74
 22 cm
 25 cm
 5 lts



VASO PL VB 25 PRETO 5L 525

Código: 37716 Fábrica: BIG PLAST Unidade: UN/1 F1 F4

UN: R\$ 44,69 AV: R\$ 44,69 15: R\$ 45,62
 30: R\$ 46,54 45: R\$ 47,47 60: R\$ 48,42
 27 cm
 30 cm



VASO PL VB 30 S/BORDA 7059

Código: 37090 Fábrica: PAIOL Unidade: UN/1 F1 F4

UN: R\$ 21,06 AV: R\$ 21,06 15: R\$ 21,50
 30: R\$ 21,93 45: R\$ 22,36 60: R\$ 22,81
 30 cm
 34 cm
 13 lts



VASO PL VB 34 PRETO 13L 534

Código: 37711 Fábrica: BIG PLAST Unidade: UN/1 F1 F4

UN: R\$ 88,33 AV: R\$ 88,33 15: R\$ 90,17
 30: R\$ 91,97 45: R\$ 93,81 60: R\$ 95,69
 29 cm
 35 cm



VASO PL VB 35 S/BORDA ARGILA 7060-1

Código: 37091 Fábrica: PAIOL Unidade: UN/1 F1 F4

UN: R\$ 128,50 AV: R\$ 128,50 15: R\$ 131,18
 30: R\$ 133,80 45: R\$ 136,48 60: R\$ 139,21
 40 cm
 45 cm



VASO PL VB 45 S/BORDA 7061

Código: 37092 Fábrica: PAIOL Unidade: UN/1 F1 F4

UN: R\$ 16,23 AV: R\$ 16,23 15: R\$ 16,57
 30: R\$ 16,90 45: R\$ 17,24 60: R\$ 17,58
 17 cm
 22 cm



VASO PL VIME SINT N4 CORES 8006

Código: 37216 Fábrica: PAIOL Unidade: UN/1 F1 F4

UN: R\$ 7,91 AV: R\$ 7,91 15: R\$ 8,07
 30: R\$ 8,24 45: R\$ 8,40 60: R\$ 8,57
 10 cm
 15 cm



VASO PL VIOLETA QUAD CAFE 00140

Código: 37148 Fábrica: PAIOL Unidade: UN/1 F1 F4

UN: R\$ 13,71 AV: R\$ 13,71 15: R\$ 14,00
 30: R\$ 14,28 45: R\$ 14,56 60: R\$ 14,86



VASO PL VIOLETA RED FIO ARGILA 4569-1

Código: 41753 Fábrica: PAIOL Unidade: UN/1 F1 F4

UN: R\$ 18,48 AV: R\$ 18,48 15: R\$ 18,86
 30: R\$ 19,24 45: R\$ 19,63 60: R\$ 20,02
 8 cm
 15 cm



VASO PL VIOLETA RED MADEIRA ENVELHE 1460

Código: 37110 Fábrica: PAIOL Unidade: UN/1 F1 F4

UN: R\$ 11,56 AV: R\$ 11,56 15: R\$ 11,80
 30: R\$ 12,03 45: R\$ 12,27 60: R\$ 12,52
 20 cm
 25 cm
 7 lts



VASO PL VQ 25 QUAD PRETO 7L 583

Código: 37703 Fábrica: BIG PLAST Unidade: UN/1 F1 F4

UN: R\$ 28,57 AV: R\$ 28,57 15: R\$ 29,16
 30: R\$ 29,74 45: R\$ 30,34 60: R\$ 30,95
 30 cm
 35 cm
 20 lts



VASO PL VQ 35 QUAD PRETO 20L 586

Código: 37702 Fábrica: BIG PLAST Unidade: UN/1 F1 F4

UN: R\$ 4,71 AV: R\$ 4,71 15: R\$ 4,81
 30: R\$ 4,91 45: R\$ 5,00 60: R\$ 5,10
 10 cm



VASO PL 0 RED PRETO 08CM 300

Código: 40713 Fábrica: PLASMARC Unidade: UN/1 F1 F4

UN: R\$ 5,30 AV: R\$ 5,30 15: R\$ 5,41
 30: R\$ 5,52 45: R\$ 5,63 60: R\$ 5,74
 11 cm



VASO PL 1 QUAD PRETO 11CM 234

Código: 40712 Fábrica: PLASMARC Unidade: UN/1 F1 F4

UN: R\$ 138,67 AV: R\$ 138,67 15: R\$ 141,56
 30: R\$ 144,39 45: R\$ 147,28 60: R\$ 150,23
 50 cm
 58 cm
 90 lts



VASO PL 10 RED GIG PRETO 90LTS

Código: 39640 Fábrica: NUTRIPLAN Unidade: UN/1 F1 F4

UN: R\$ 3,06 AV: R\$ 3,06 15: R\$ 3,13
30: R\$ 3,19 45: R\$ 3,25 60: R\$ 3,32

11 cm



VASO PL 11CM C/PRATO 11CM PRETO 346

Código: Fábriça: Unidade:
40851 JOREAL UN/1
F1 F4

UN: R\$ 10,84 AV: R\$ 10,84 15: R\$ 11,06
30: R\$ 11,29 45: R\$ 11,51 60: R\$ 11,74

VASO PL 12LTS MARFIM 6408

Código: Fábriça: Unidade:
41481 KOZI PLAST UN/1
F1 F4



UN: R\$ 19,43 AV: R\$ 19,43 15: R\$ 19,83
30: R\$ 20,23 45: R\$ 20,63 60: R\$ 21,05

25cm
32cm
12,5Lts

VASO PL 12,5 LTS QUAD GDE PRETO 6701

Código: Fábriça: Unidade:
26767 INPLAST UN/1
F1 F4



UN: R\$ 4,87 AV: R\$ 4,87 15: R\$ 4,97
30: R\$ 5,07 45: R\$ 5,17 60: R\$ 5,27

15 cm
17 cm
1,8 lts

VASO PL 17 PRETO 1,8L 308

Código: Fábriça: Unidade:
37718 BIG PLAST UN/1
F1 F4



UN: R\$ 5,67 AV: R\$ 5,67 15: R\$ 5,79
30: R\$ 5,90 45: R\$ 6,02 60: R\$ 6,14

17 cm
20 cm
3,3 lts



VASO PL 20 PRETO 3,3L 316

Código: Fábriça: Unidade:
37717 BIG PLAST UN/1
F1 F4

UN: R\$ 9,23 AV: R\$ 9,23 15: R\$ 9,43
30: R\$ 9,62 45: R\$ 9,81 60: R\$ 10,00

20 cm
24 cm
6 lts

VASO PL 24 PRETO 6L 324

Código: Fábriça: Unidade:
37715 BIG PLAST UN/1
F1 F4



UN: R\$ 13,34 AV: R\$ 13,34 15: R\$ 13,62
30: R\$ 13,89 45: R\$ 14,17 60: R\$ 14,46

23 cm
27 cm
8,5 L

VASO PL 27 PRETO 8,5L 332

Código: Fábriça: Unidade:
37714 BIG PLAST UN/1
F1 F4



UN: R\$ 5,89 AV: R\$ 5,89 15: R\$ 6,01
30: R\$ 6,13 45: R\$ 6,26 60: R\$ 6,38

14 cm

VASO PL 3 QUAD PRETO 14CM 129

Código: Fábriça: Unidade:
40711 PLASMARC UN/1
F1 F4



UN: R\$ 15,28 AV: R\$ 15,28 15: R\$ 15,60
30: R\$ 15,92 45: R\$ 16,23 60: R\$ 16,56

26 cm
30 cm
11,5 lts



VASO PL 30 PRETO 11,5L 340

Código: Fábriça: Unidade:
37713 BIG PLAST UN/1
F1 F4

UN: R\$ 21,31 AV: R\$ 21,31 15: R\$ 21,76
30: R\$ 22,19 45: R\$ 22,64 60: R\$ 23,09

30 cm
35 cm
22 lts

VASO PL 35 PRETO 22L 348

Código: Fábriça: Unidade:
37710 BIG PLAST UN/1
F1 F4



UN: R\$ 11,09 AV: R\$ 11,09 15: R\$ 11,32
30: R\$ 11,54 45: R\$ 11,78 60: R\$ 12,01

5,5 L

VASO PL 5,5 LTS QUAD MED PTO 6700

Código: Fábriça: Unidade:
26762 INPLAST UN/1
F1 F4



UN: R\$ 9,67 AV: R\$ 9,67 15: R\$ 9,87
30: R\$ 10,06 45: R\$ 10,27 60: R\$ 10,47

5,5 L

VASO PL 5,5 LTS QUAD MED TERRACOTA 6718

Código: Fábriça: Unidade:
26765 INPLAST UN/1
F1 F4



UN: R\$ 9,67 AV: R\$ 9,67 15: R\$ 9,87
30: R\$ 10,06 45: R\$ 10,27 60: R\$ 10,47

5,5 L



VASO PL 5,5 LTS RED MED TERRACOTA 6712

Código: Fábriça: Unidade:
26764 INPLAST UN/1
F1 F4

UN: R\$ 23,97 AV: R\$ 287,61 15: R\$ 293,60
30: R\$ 299,47 45: R\$ 305,46 60: R\$ 311,57

VASSOURA PELO SINTETICO M9 522 12X1

Código: Fábriça: Unidade:
38416 N.HORIZONTE DZ/12
F1 F4



UN: R\$ 17,26 AV: R\$ 17,26 15: R\$ 17,62
30: R\$ 17,97 45: R\$ 18,33 60: R\$ 18,69

VASSOURA PIACAVA NYLON CECI C/CB 1293

Código: Fábriça: Unidade:
49806 CECI JOIA UN/1
F1 F4



UN: R\$ 14,94 AV: R\$ 14,94 15: R\$ 15,25
30: R\$ 15,55 45: R\$ 15,86 60: R\$ 16,18

VASSOURA PIACAVA NYLON JOIA C/CB UN 3241

Código: Fábriça: Unidade:
49805 CECI JOIA UN/1
F1 F4



UN: R\$ 25,67 AV: R\$ 25,67 15: R\$ 26,20
30: R\$ 26,73 45: R\$ 27,26 60: R\$ 27,81



VASSOURA RASTELO PL AZUL P/GRAMA CB MAD
Código: 32770 Fábrica: NUTRIPLAN Unidade: UN/1 F1 F4

UN: R\$ 20,95 AV: R\$ 20,95 15: R\$ 21,39
30: R\$ 21,82 45: R\$ 22,26 60: R\$ 22,70



VASSOURA RASTELO PL P/GRAMA 46CM C/CB 80
Código: 49807 Fábrica: EDS Unidade: UN/1 F1 F4

UN: R\$ 25,67 AV: R\$ 25,67 15: R\$ 26,20
30: R\$ 26,73 45: R\$ 27,26 60: R\$ 27,81



VASSOURA RASTELO PL VERDE P/GRAMA CB MA
Código: 18505 Fábrica: NUTRIPLAN Unidade: UN/1 F1 F4

UN: R\$ 28,75 AV: R\$ 28,75 15: R\$ 29,35
30: R\$ 29,94 45: R\$ 30,54 60: R\$ 31,15



VASSOURA RASTELO PLAST P/GRAMA CB MAD
Código: 48741 Fábrica: N.HORIZONTE Unidade: UN/1 F1 F4

UN: R\$ 20,53 AV: R\$ 20,53 15: R\$ 20,96
30: R\$ 21,38 45: R\$ 21,81 60: R\$ 22,24



VELADOR CROM MED 18CM C/COADOR 426
Código: 30756 Fábrica: ARAMINAS Unidade: UN/1 F1 F4

UN: R\$ 13,34 AV: R\$ 13,34 15: R\$ 13,62
30: R\$ 13,89 45: R\$ 14,17 60: R\$ 14,46



VELADOR CROM MINI C/COADOR 15CM 722
Código: 3490 Fábrica: ARAMINAS Unidade: UN/1 F1 F4

UN: R\$ 14,37 AV: R\$ 14,37 15: R\$ 14,67
30: R\$ 14,96 45: R\$ 15,26 60: R\$ 15,57



VELADOR CROM 1 34CM 68
Código: 24070 Fábrica: ARAMINAS Unidade: UN/1 F1 F4

UN: R\$ 33,89 AV: R\$ 33,89 15: R\$ 34,59
30: R\$ 35,29 45: R\$ 35,99 60: R\$ 36,71

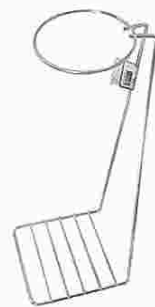

VELADOR CROM 2 GDE 48CM 69
Código: 30922 Fábrica: ARAMINAS Unidade: UN/1 F1 F4

UN: R\$ 8,21 AV: R\$ 8,21 15: R\$ 8,38
30: R\$ 8,55 45: R\$ 8,72 60: R\$ 8,89



VERMICULITA 1 LITRO
Código: 48534 Fábrica: NOVATROPICAL Unidade: PT/1 F1 F4

UN: R\$ 4,45 AV: R\$ 4,45 15: R\$ 4,54
30: R\$ 4,63 45: R\$ 4,72 60: R\$ 4,82



XICARA ACRIL CHA 180ML AZUL TIFFANY 1131
Código: 49320 Fábrica: QUALYPLAS Unidade: UN/1 F1 F4

UN: R\$ 4,49 AV: R\$ 53,93 15: R\$ 55,05
30: R\$ 56,15 45: R\$ 57,28 60: R\$ 58,42



XICARA VIDRO TRANSP 80ML 5CM 23339 12X1
Código: 36748 Fábrica: MABEL Unidade: CX/12 F1 F4

UN: R\$ 41,08 AV: R\$ 41,08 15: R\$ 41,93
30: R\$ 42,77 45: R\$ 43,63 60: R\$ 44,50



XICARAS CHA VID S/PIRES 6X1
Código: 47420 Fábrica: BBC GLASS Unidade: CJ/1 F1 F4