

UN: R\$ 0,88 AV: R\$ 43,96 15: R\$ 44,88  
30: R\$ 45,78 45: R\$ 46,69 60: R\$ 47,63



ABRACADEIRA ACO BORBOLETA ROSCA 1/2 50X1  
Código: Fábrica: Unidade:  
**51099** BESTFER PT/50  
F1 F4

UN: R\$ 0,89 AV: R\$ 44,43 15: R\$ 45,35  
30: R\$ 46,26 45: R\$ 47,18 60: R\$ 48,13



ABRACADEIRA ACO BORBOLETA ROSCA 3/4 50X1  
Código: Fábrica: Unidade:  
**51100** BESTFER PT/50  
F1 F4

UN: R\$ 10,26 AV: R\$ 10,26 15: R\$ 10,48  
30: R\$ 10,69 45: R\$ 10,90 60: R\$ 11,12



ABRACADEIRA METAL BORBOLETA 16/12/25 6X1  
Código: Fábrica: Unidade:  
**49562** ALIANCA CJ/1  
F1 F4

UN: R\$ 10,79 AV: R\$ 10,79 15: R\$ 11,01  
30: R\$ 11,23 45: R\$ 11,46 60: R\$ 11,68



ABRACADEIRA METAL P/M/G 6X1  
Código: Fábrica: Unidade:  
**44714** IMPERIO CJ/1  
F1 F4

UN: R\$ 0,07 AV: R\$ 6,78 15: R\$ 6,92  
30: R\$ 7,06 45: R\$ 7,20 60: R\$ 7,34



ABRACADEIRA NYLON 2,5X150MM PRETO 100X1  
Código: Fábrica: Unidade:  
**45904** WINMAX PT/100  
F1 F4

UN: R\$ 0,08 AV: R\$ 8,21 15: R\$ 8,38  
30: R\$ 8,55 45: R\$ 8,72 60: R\$ 8,89



ABRACADEIRA NYLON 2,5X200MM PRETO 100X1  
Código: Fábrica: Unidade:  
**49627** WINMAX PT/100  
F1 F4

UN: R\$ 0,16 AV: R\$ 16,02 15: R\$ 16,36  
30: R\$ 16,69 45: R\$ 17,02 60: R\$ 17,36



ABRACADEIRA NYLON 4,8X200MM PRETO 100X1  
Código: Fábrica: Unidade:  
**45530** WINMAX PT/100  
F1 F4

UN: R\$ 0,24 AV: R\$ 11,80 15: R\$ 12,05  
30: R\$ 12,29 45: R\$ 12,54 60: R\$ 12,79

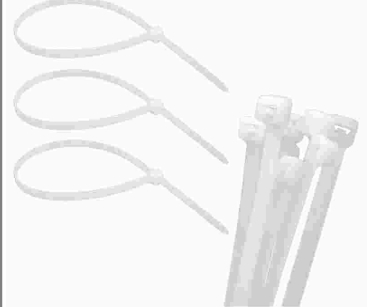

ABRACADEIRA NYLON 5X300MM BRANC 550 50X1  
Código: Fábrica: Unidade:  
**47625** PLANETA PT/50  
F1 F4

UN: R\$ 0,27 AV: R\$ 13,34 15: R\$ 13,62  
30: R\$ 13,89 45: R\$ 14,17 60: R\$ 14,46

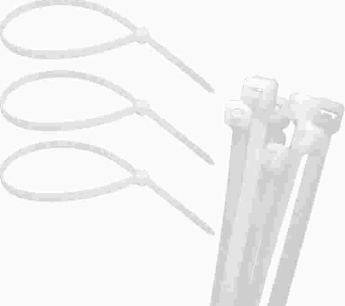

ABRACADEIRA NYLON 5X350MM BRANC 551 50X1  
Código: Fábrica: Unidade:  
**47624** PLANETA PT/50  
F1 F4

UN: R\$ 0,10 AV: R\$ 8,21 15: R\$ 8,38  
30: R\$ 8,55 45: R\$ 8,72 60: R\$ 8,89



ABRACADEIRA PLAST 2,5X100X150X200MM 80X1  
Código: Fábrica: Unidade:  
**45097** NYBC PT/80  
F1 F4

UN: R\$ 0,07 AV: R\$ 7,18 15: R\$ 7,33  
30: R\$ 7,48 45: R\$ 7,63 60: R\$ 7,78



ABRACADEIRA PLAST 3,6X150MM 9698 100X1  
Código: Fábrica: Unidade:  
**41601** EMILAR PT/100  
F1 F4

UN: R\$ 0,12 AV: R\$ 12,32 15: R\$ 12,57  
30: R\$ 12,82 45: R\$ 13,08 60: R\$ 13,34



ABRACADEIRA PLAST 3,6X200MM 100X1  
Código: Fábrica: Unidade:  
**45096** NYBC PT/100  
F1 F4

UN: R\$ 0,10 AV: R\$ 10,26 15: R\$ 10,48  
30: R\$ 10,69 45: R\$ 10,90 60: R\$ 11,12



ABRACADEIRA PLAST 3,6X200MM 465 100X1  
Código: Fábrica: Unidade:  
**41565** PLANETA PT/100  
F1 F4

UN: R\$ 7,99 AV: R\$ 7,99 15: R\$ 7,99  
30: R\$ 7,99 45: R\$ 7,99 60: R\$ 7,99



ACENDEADOR FOGAO CTL 3047  
Código: Fábrica: Unidade:  
**49631** WINMAX UN/1  
F1 F4

UN: R\$ 4,59 AV: R\$ 45,94 15: R\$ 45,94  
30: R\$ 45,94 45: R\$ 45,94 60: R\$ 45,94

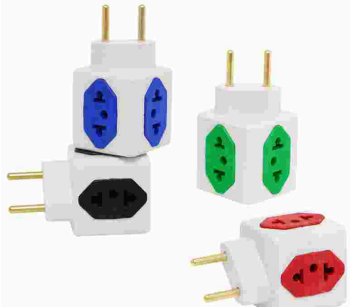

ADAPTADOR CUBO EF02 10X1  
Código: Fábrica: Unidade:  
**39383** GIROFLASH PT/10  
F1 F4

UN: R\$ 35,94 AV: R\$ 35,94 15: R\$ 36,69  
30: R\$ 37,42 45: R\$ 38,17 60: R\$ 38,94



ADAPTADOR DVI-CX VGA KP-AD108  
Código: Fábrica: Unidade:  
**47604** KNUP UN/1  
F1 F4

UN: R\$ 2,04 AV: R\$ 2,04 15: R\$ 2,09  
30: R\$ 2,13 45: R\$ 2,17 60: R\$ 2,21



ADAPTADOR PLAST TOMADA 20A UN

Código: 26675 Fábrica: GIRO FLASH Unidade: UN/1 F1 F4

UN: R\$ 2,67 AV: R\$ 66,76 15: R\$ 68,15  
30: R\$ 69,51 45: R\$ 70,90 60: R\$ 72,32



ADAPTADOR T BENJ 2PIN BOB ESP EF03 25X1

Código: 29067 Fábrica: GIROFLASH Unidade: PT/25 F1 F4

UN: R\$ 4,11 AV: R\$ 102,71 15: R\$ 104,85  
30: R\$ 106,95 45: R\$ 109,09 60: R\$ 111,27



ADAPTADOR T BENJ 2PIN 3ENT EF04 25X1

Código: 28775 Fábrica: GIROFLASH Unidade: PT/25 F1 F4

UN: R\$ 3,06 AV: R\$ 76,40 15: R\$ 77,99  
30: R\$ 79,55 45: R\$ 81,15 60: R\$ 82,77



ADAPTADOR T BENJ 2PIN 3ENT INV EF18 25X1

Código: 44514 Fábrica: GIROFLASH Unidade: PT/25 F1 F4

UN: R\$ 2,88 AV: R\$ 71,89 15: R\$ 73,39  
30: R\$ 74,86 45: R\$ 76,36 60: R\$ 77,88



ADAPTADOR T BENJ 2PIN 3ENT LAT EF01 25X1

Código: 28681 Fábrica: GIROFLASH Unidade: PT/25 F1 F4

UN: R\$ 3,00 AV: R\$ 74,88 15: R\$ 76,44  
30: R\$ 77,97 45: R\$ 79,53 60: R\$ 81,12



ADAPTADOR T BENJ 2PIN 3ENT PARAF 53 25X1

Código: 27974 Fábrica: GIROFLASH Unidade: PT/25 F1 F4

UN: R\$ 42,49 AV: R\$ 42,49 15: R\$ 43,37  
30: R\$ 44,24 45: R\$ 45,13 60: R\$ 46,03



ADAPTADOR TOMADA 2.1A USB CABO TPC 74508

Código: 44512 Fábrica: LETRON Unidade: UN/1 F1 F4

UN: R\$ 8,16 AV: R\$ 8,16 15: R\$ 8,33  
30: R\$ 8,50 45: R\$ 8,67 60: R\$ 8,84



ADAPTADOR 10A+ BOB ESPONJA KIT

Código: 40700 Fábrica: ELETRICAL Unidade: UN/1 F4

UN: R\$ 20,53 AV: R\$ 20,53 15: R\$ 20,96  
30: R\$ 21,38 45: R\$ 21,81 60: R\$ 22,24



ADAPTADOR 2P+T 10A BIV 111151

Código: 48014 Fábrica: IN-TECK Unidade: UN/1 F1 F4

UN: R\$ 4,10 AV: R\$ 4,10 15: R\$ 4,18  
30: R\$ 4,27 45: R\$ 4,35 60: R\$ 4,44



ADESIVO APLIQUE PEROLA PEQ 2060 CTL

Código: 32756 Fábrica: MEI CHEN Unidade: PT/1 F1 F4

UN: R\$ 4,10 AV: R\$ 4,10 15: R\$ 4,18  
30: R\$ 4,27 45: R\$ 4,35 60: R\$ 4,44



ADESIVO APLIQUE STRASS GDE 2059 CTL

Código: 40538 Fábrica: MEI CHEN Unidade: PT/1 F1 F4

UN: R\$ 4,10 AV: R\$ 4,10 15: R\$ 4,18  
30: R\$ 4,27 45: R\$ 4,35 60: R\$ 4,44

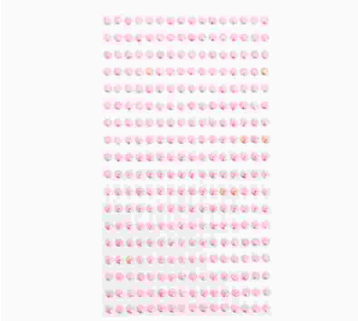

ADESIVO APLIQUE STRASS MED 2061 CTL

Código: 40540 Fábrica: MEI CHEN Unidade: PT/1 F1 F4

UN: R\$ 4,10 AV: R\$ 4,10 15: R\$ 4,18  
30: R\$ 4,27 45: R\$ 4,35 60: R\$ 4,44



ADESIVO APLIQUE STRASS MED 2062 CTL

Código: 40537 Fábrica: MEI CHEN Unidade: PT/1 F1 F4

UN: R\$ 4,10 AV: R\$ 4,10 15: R\$ 4,18  
30: R\$ 4,27 45: R\$ 4,35 60: R\$ 4,44

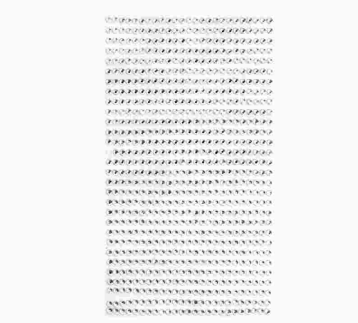

ADESIVO APLIQUE STRASS PEQ 057A CTL

Código: 40539 Fábrica: MEI CHEN Unidade: PT/1 F1 F4

UN: R\$ 4,10 AV: R\$ 4,10 15: R\$ 4,18  
30: R\$ 4,27 45: R\$ 4,35 60: R\$ 4,44



ADESIVO APLIQUE STRASS PEQ 2056 CTL

Código: 32753 Fábrica: MEI CHEN Unidade: PT/1 F1 F4

UN: R\$ 4,10 AV: R\$ 4,10 15: R\$ 4,18  
30: R\$ 4,27 45: R\$ 4,35 60: R\$ 4,44



ADESIVO APLIQUE STRASS 102X265MM CTL

Código: 37669 Fábrica: MEI CHEN Unidade: PT/1 F1 F4

UN: R\$ 27,39 AV: R\$ 164,34 15: R\$ 167,77  
30: R\$ 171,12 45: R\$ 174,54 60: R\$ 178,03



ADESIVO EPOXI ARALDITE HOBBY 16 GRS 6X1  
Código: Fábrica: Unidade:  
**42212** TEK BOND CX/6  
F1 F4

UN: R\$ 4,42 AV: R\$ 4,42 15: R\$ 4,51  
30: R\$ 4,60 45: R\$ 4,69 60: R\$ 4,79



ADESIVO PLAST GRUDA RATO 17X25CM L888  
Código: Fábrica: Unidade:  
**50955** HAI BRASIL UN/1  
F1 F4

UN: R\$ 46,68 AV: R\$ 46,68 15: R\$ 47,65  
30: R\$ 48,61 45: R\$ 49,58 60: R\$ 50,57



ADPADOR UBS 2.0 RJ45 USB LAN UR-01  
Código: Fábrica: Unidade:  
**47408** RR UN/1  
F1 F4

UN: R\$ 46,22 AV: R\$ 46,22 15: R\$ 47,19  
30: R\$ 48,13 45: R\$ 49,09 60: R\$ 50,08



ALICATE CRIMPAR CONECTOR RJ45 PADRAO CAT  
Código: Fábrica: Unidade:  
**44978** MB TOOLS UN/1  
F1 F4

UN: R\$ 25,67 AV: R\$ 25,67 15: R\$ 26,20  
30: R\$ 26,73 45: R\$ 27,26 60: R\$ 27,81



ALMOFADA RET 25X28CM FLAMENGO 11196  
Código: Fábrica: Unidade:  
**41108** BRASFOOT UN/1  
F1 F4

UN: R\$ 30,81 AV: R\$ 30,81 15: R\$ 31,45  
30: R\$ 32,08 45: R\$ 32,72 60: R\$ 33,37



ANTENA INTERNA P/TV DIGITAL HDTV/UHF/VHF  
Código: Fábrica: Unidade:  
**47411** HAI BRASIL UN/1  
F1 F4

UN: R\$ 0,39 AV: R\$ 39,02 15: R\$ 39,84  
30: R\$ 40,63 45: R\$ 41,45 60: R\$ 42,27  
1,5 cm



ANZOL BLACK CHINU N02 100X1  
Código: Fábrica: Unidade:  
**31008** MARINE CE/100  
F1 F4

UN: R\$ 0,40 AV: R\$ 40,05 15: R\$ 40,88  
30: R\$ 41,70 45: R\$ 42,54 60: R\$ 43,39  
1,6 cm



ANZOL BLACK CHINU N03 100X1  
Código: Fábrica: Unidade:  
**31009** MARINE CE/100  
F1 F4

UN: R\$ 0,41 AV: R\$ 41,08 15: R\$ 41,93  
30: R\$ 42,77 45: R\$ 43,63 60: R\$ 44,50  
1,7 cm



ANZOL BLACK CHINU N04 100X1  
Código: Fábrica: Unidade:  
**31010** MARINE CE/100  
F1 F4

UN: R\$ 0,43 AV: R\$ 43,13 15: R\$ 44,03  
30: R\$ 44,91 45: R\$ 45,81 60: R\$ 46,73  
1,8 cm



ANZOL BLACK CHINU N05 100X1  
Código: Fábrica: Unidade:  
**31011** MARINE CE/100  
F1 F4

UN: R\$ 0,45 AV: R\$ 45,19 15: R\$ 46,13  
30: R\$ 47,05 45: R\$ 47,99 60: R\$ 48,95  
2 cm



ANZOL BLACK CHINU N06 100X1  
Código: Fábrica: Unidade:  
**31012** MARINE CE/100  
F1 F4

UN: R\$ 0,51 AV: R\$ 51,35 15: R\$ 52,42  
30: R\$ 53,47 45: R\$ 54,54 60: R\$ 55,63  
2,2 cm



ANZOL BLACK CHINU N07 100X1  
Código: Fábrica: Unidade:  
**31013** MARINE CE/100  
F1 F4

UN: R\$ 0,56 AV: R\$ 56,49 15: R\$ 57,66  
30: R\$ 58,82 45: R\$ 59,99 60: R\$ 61,19  
2,5 cm



ANZOL BLACK CHINU N08 100X1  
Código: Fábrica: Unidade:  
**31014** MARINE CE/100  
F4

UN: R\$ 0,62 AV: R\$ 61,62 15: R\$ 62,91  
30: R\$ 64,16 45: R\$ 65,45 60: R\$ 66,76  
3 cm



ANZOL BLACK CHINU N09 100X1  
Código: Fábrica: Unidade:  
**31015** MARINE CE/100  
F1 F4

UN: R\$ 2,77 AV: R\$ 277,33 15: R\$ 283,11  
30: R\$ 288,77 45: R\$ 294,55 60: R\$ 300,44



ANZOL GARATEIA N02 TREBLE HOOK 100X1  
Código: Fábrica: Unidade:  
**43509** MARINE CE/100  
F1 F4

UN: R\$ 2,57 AV: R\$ 256,79 15: R\$ 262,14  
30: R\$ 267,38 45: R\$ 272,73 60: R\$ 278,18



ANZOL GARATEIA N04 TREBLE HOOK 100X1  
Código: Fábrica: Unidade:  
**43510** MARINE CE/100  
F1 F4

UN: R\$ 2,57 AV: R\$ 256,79 15: R\$ 262,14  
30: R\$ 267,38 45: R\$ 272,73 60: R\$ 278,18



ANZOL GARATEIA N06 TREBLE HOOK 100X1

Código: Fábrica: Unidade:  
**43511** MARINE CE/100  
F1 F4

UN: R\$ 2,64 AV: R\$ 263,74 15: R\$ 269,24  
30: R\$ 274,62 45: R\$ 280,12 60: R\$ 285,72



ANZOL GARATEIA N10 TREBLE HOOK 100X1

Código: Fábrica: Unidade:  
**37697** MARINE CE/100  
F1 F4

UN: R\$ 2,36 AV: R\$ 236,25 15: R\$ 241,17  
30: R\$ 245,99 45: R\$ 250,91 60: R\$ 255,93



ANZOL GARATEIA N12 TREBLE HOOK 100X1

Código: Fábrica: Unidade:  
**37698** MARINE CE/100  
F1 F4

UN: R\$ 2,67 AV: R\$ 267,06 15: R\$ 272,63  
30: R\$ 278,08 45: R\$ 283,64 60: R\$ 289,31



ANZOL GARATEIA N18 TREBLE HOOK 100X1

Código: Fábrica: Unidade:  
**43507** MARINE CE/100  
F1 F4

UN: R\$ 0,34 AV: R\$ 33,89 15: R\$ 34,59  
30: R\$ 35,29 45: R\$ 35,99 60: R\$ 36,71



ANZOL PRATEADO N01 100X1

Código: Fábrica: Unidade:  
**10026** MARINE CE/100  
F4

UN: R\$ 0,32 AV: R\$ 31,83 15: R\$ 32,50  
30: R\$ 33,15 45: R\$ 33,81 60: R\$ 34,49



ANZOL PRATEADO N01/0 100X1

Código: Fábrica: Unidade:  
**30020** MARINE CE/100  
F4

UN: R\$ 0,26 AV: R\$ 25,67 15: R\$ 26,20  
30: R\$ 26,73 45: R\$ 27,26 60: R\$ 27,81



ANZOL PRATEADO N02 100X1

Código: Fábrica: Unidade:  
**10027** MARINE CE/100  
F4

UN: R\$ 0,41 AV: R\$ 41,08 15: R\$ 41,93  
30: R\$ 42,77 45: R\$ 43,63 60: R\$ 44,50



ANZOL PRATEADO N02/0 100X1

Código: Fábrica: Unidade:  
**30021** MARINE CE/100  
F4

UN: R\$ 0,51 AV: R\$ 51,35 15: R\$ 52,42  
30: R\$ 53,47 45: R\$ 54,54 60: R\$ 55,63



ANZOL PRATEADO N03/0 100X1

Código: Fábrica: Unidade:  
**30022** MARINE CE/100  
F4

UN: R\$ 0,27 AV: R\$ 26,70 15: R\$ 27,25  
30: R\$ 27,80 45: R\$ 28,35 60: R\$ 28,92

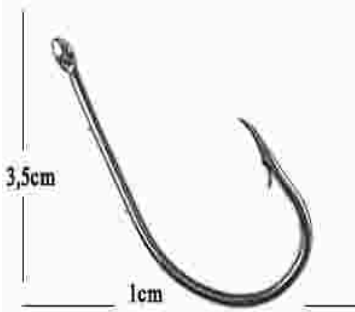

ANZOL PRATEADO N04 100X1

Código: Fábrica: Unidade:  
**10028** MARINE CE/100  
F4

UN: R\$ 0,55 AV: R\$ 54,71 15: R\$ 55,85  
30: R\$ 56,97 45: R\$ 58,10 60: R\$ 59,27



ANZOL PRATEADO N04/0 100X1

Código: Fábrica: Unidade:  
**30023** MARINE CE/100  
F4

UN: R\$ 0,27 AV: R\$ 26,70 15: R\$ 27,25  
30: R\$ 27,80 45: R\$ 28,35 60: R\$ 28,92

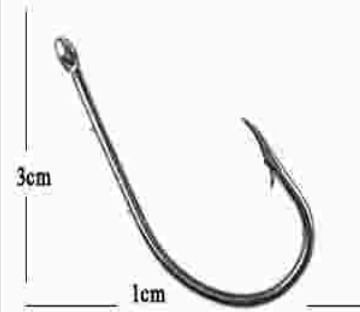

ANZOL PRATEADO N06 100X1

Código: Fábrica: Unidade:  
**10029** MARINE CE/100  
F4

UN: R\$ 0,27 AV: R\$ 26,70 15: R\$ 27,25  
30: R\$ 27,80 45: R\$ 28,35 60: R\$ 28,92

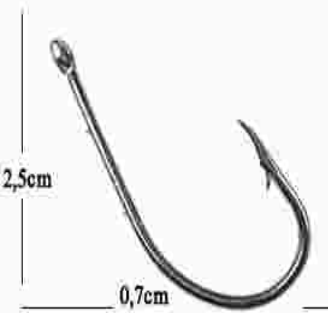

ANZOL PRATEADO N08 100X1

Código: Fábrica: Unidade:  
**10030** MARINE CE/100  
F4

UN: R\$ 0,27 AV: R\$ 26,70 15: R\$ 27,25  
30: R\$ 27,80 45: R\$ 28,35 60: R\$ 28,92

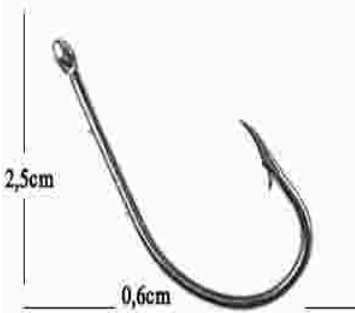

ANZOL PRATEADO N10 100X1

Código: Fábrica: Unidade:  
**8865** MARINE CE/100  
F1 F4

UN: R\$ 0,27 AV: R\$ 26,70 15: R\$ 27,25  
30: R\$ 27,80 45: R\$ 28,35 60: R\$ 28,92



ANZOL PRATEADO N12 100X1

Código: Fábrica: Unidade:  
**9488** MARINE CE/100  
F4

UN: R\$ 0,27 AV: R\$ 26,70 15: R\$ 27,25  
30: R\$ 27,80 45: R\$ 28,35 60: R\$ 28,92



ANZOL PRATEADO N14 100X1

Código: Fábrica: Unidade:  
**8866** MARINE CE/100  
F4

UN: R\$ 0,27 AV: R\$ 26,70 15: R\$ 27,25  
30: R\$ 27,80 45: R\$ 28,35 60: R\$ 28,92



ANZOL PRATEADO N16 100X1  
Código: Fábrika: Unidade:  
**4240** MARINE CE/100  
F1 F4

UN: R\$ 0,26 AV: R\$ 20,53 15: R\$ 20,96  
30: R\$ 21,38 45: R\$ 21,81 60: R\$ 22,24



ANZOL PRATEADO N18 80X1  
Código: Fábrika: Unidade:  
**48136** DJW PT/80  
F4

UN: R\$ 0,27 AV: R\$ 26,70 15: R\$ 27,25  
30: R\$ 27,80 45: R\$ 28,35 60: R\$ 28,92



ANZOL PRATEADO N18 100X1  
Código: Fábrika: Unidade:  
**31007** MARINE CE/100  
F4

UN: R\$ 0,25 AV: R\$ 24,64 15: R\$ 25,16  
30: R\$ 25,66 45: R\$ 26,17 60: R\$ 26,70



ANZOL PRATEADO N20 100X1  
Código: Fábrika: Unidade:  
**13279** STRONG CE/100  
F4

UN: R\$ 0,31 AV: R\$ 24,64 15: R\$ 25,16  
30: R\$ 25,66 45: R\$ 26,17 60: R\$ 26,70



ANZOL PRATEADO N4/0 80X1  
Código: Fábrika: Unidade:  
**48137** DJW PT/80  
F4

UN: R\$ 5,35 AV: R\$ 5,35 15: R\$ 5,46  
30: R\$ 5,57 45: R\$ 5,68 60: R\$ 5,80



APARADOR PLAST P/PORTA 10CM 7678 2X1  
Código: Fábrika: Unidade:  
**47362** ALTIHOME CR/1  
F1 F4

UN: R\$ 5,55 AV: R\$ 5,55 15: R\$ 5,66  
30: R\$ 5,78 45: R\$ 5,89 60: R\$ 6,01

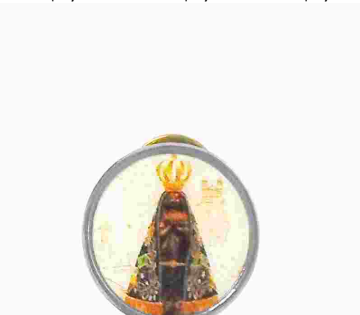

APLIQUE (BOTTON) METAL RELIGIOSO 9402  
Código: Fábrika: Unidade:  
**35915** BAL UN/1  
F1 F4

UN: R\$ 3,58 AV: R\$ 3,58 15: R\$ 3,66  
30: R\$ 3,73 45: R\$ 3,81 60: R\$ 3,88



ARAME AMARRILHO COLOR 5MTS  
Código: Fábrika: Unidade:  
**50865** NYBC RL/1  
F1 F4

UN: R\$ 7,18 AV: R\$ 7,18 15: R\$ 7,33  
30: R\$ 7,48 45: R\$ 7,63 60: R\$ 7,78



AREIA DECORATIVA AMARELO 750 GRS  
Código: Fábrika: Unidade:  
**19941** NOVATROPICAL PT/1  
F1 F4

UN: R\$ 7,18 AV: R\$ 7,18 15: R\$ 7,33  
30: R\$ 7,48 45: R\$ 7,63 60: R\$ 7,78



AREIA DECORATIVA AZUL CLARO 750 GRS  
Código: Fábrika: Unidade:  
**22883** NOVATROPICAL PT/1  
F1 F4

UN: R\$ 7,18 AV: R\$ 7,18 15: R\$ 7,33  
30: R\$ 7,48 45: R\$ 7,63 60: R\$ 7,78



AREIA DECORATIVA AZUL ESCURO 750 GRS  
Código: Fábrika: Unidade:  
**19940** NOVATROPICAL PT/1  
F1 F4

UN: R\$ 7,18 AV: R\$ 7,18 15: R\$ 7,33  
30: R\$ 7,48 45: R\$ 7,63 60: R\$ 7,78



AREIA DECORATIVA BRANCO 750 GRS  
Código: Fábrika: Unidade:  
**19937** NOVATROPICAL PT/1  
F1 F4

UN: R\$ 7,18 AV: R\$ 7,18 15: R\$ 7,33  
30: R\$ 7,48 45: R\$ 7,63 60: R\$ 7,78

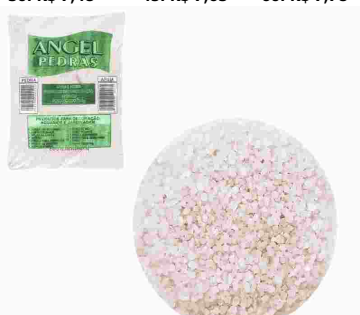

AREIA DECORATIVA CREME 750 GRS  
Código: Fábrika: Unidade:  
**34737** NOVATROPICAL PT/1  
F1 F4

UN: R\$ 7,18 AV: R\$ 7,18 15: R\$ 7,33  
30: R\$ 7,48 45: R\$ 7,63 60: R\$ 7,78



AREIA DECORATIVA LARANJA ESC 750 GRS  
Código: Fábrika: Unidade:  
**34739** NOVATROPICAL PT/1  
F1 F4

UN: R\$ 7,18 AV: R\$ 7,18 15: R\$ 7,33  
30: R\$ 7,48 45: R\$ 7,63 60: R\$ 7,78



AREIA DECORATIVA LARANJA 700 GRS  
Código: Fábrika: Unidade:  
**20112** NOVATROPICAL PT/1  
F1 F4

UN: R\$ 7,18 AV: R\$ 7,18 15: R\$ 7,33  
30: R\$ 7,48 45: R\$ 7,63 60: R\$ 7,78



AREIA DECORATIVA LILAS 750 GRS  
Código: Fábrika: Unidade:  
**22093** NOVATROPICAL PT/1  
F1 F4

UN: R\$ 7,18 AV: R\$ 7,18 15: R\$ 7,33  
30: R\$ 7,48 45: R\$ 7,63 60: R\$ 7,78



AREIA DECORATIVA MISTA 750 GRS

Código: Fábrika: Unidade:  
**22884** NOVATROPICAL PT/1  
F1 F4

UN: R\$ 7,18 AV: R\$ 7,18 15: R\$ 7,33  
30: R\$ 7,48 45: R\$ 7,63 60: R\$ 7,78



AREIA DECORATIVA OCRE 750 GRS

Código: Fábrika: Unidade:  
**34738** NOVATROPICAL PT/1  
F1 F4

UN: R\$ 7,18 AV: R\$ 7,18 15: R\$ 7,33  
30: R\$ 7,48 45: R\$ 7,63 60: R\$ 7,78



AREIA DECORATIVA PRETA 700 GRS

Código: Fábrika: Unidade:  
**22886** NOVATROPICAL PT/1  
F1 F4

UN: R\$ 6,53 AV: R\$ 6,53 15: R\$ 6,67  
30: R\$ 6,80 45: R\$ 6,94 60: R\$ 7,08



AREIA DECORATIVA PRETO 750 GRS

Código: Fábrika: Unidade:  
**34747** NOVATROPICAL PT/1  
F1 F4

UN: R\$ 7,18 AV: R\$ 7,18 15: R\$ 7,33  
30: R\$ 7,48 45: R\$ 7,63 60: R\$ 7,78



AREIA DECORATIVA ROSA 750 GRS

Código: Fábrika: Unidade:  
**19938** NOVATROPICAL PT/1  
F1 F4

UN: R\$ 7,18 AV: R\$ 7,18 15: R\$ 7,33  
30: R\$ 7,48 45: R\$ 7,63 60: R\$ 7,78



AREIA DECORATIVA VERDE CLARO 750 GRS

Código: Fábrika: Unidade:  
**34741** NOVATROPICAL PT/1  
F1 F4

UN: R\$ 7,18 AV: R\$ 7,18 15: R\$ 7,33  
30: R\$ 7,48 45: R\$ 7,63 60: R\$ 7,78



AREIA DECORATIVA VERDE ESCURO 750 GRS

Código: Fábrika: Unidade:  
**19921** NOVATROPICAL PT/1  
F1 F4

UN: R\$ 7,18 AV: R\$ 7,18 15: R\$ 7,33  
30: R\$ 7,48 45: R\$ 7,63 60: R\$ 7,78



AREIA DECORATIVA VERMELHO 750 GRS

Código: Fábrika: Unidade:  
**19939** NOVATROPICAL PT/1  
F1 F4

UN: R\$ 112,98 AV: R\$ 112,98 15: R\$ 115,34  
30: R\$ 117,64 45: R\$ 120,00 60: R\$ 122,40



ARGILA EXPANDIDA N2 50LTS APROX 18KG

Código: Fábrika: Unidade:  
**34594** NOVATROPICAL PT/1  
F1 F4

UN: R\$ 5,80 AV: R\$ 5,80 15: R\$ 5,92  
30: R\$ 6,04 45: R\$ 6,16 60: R\$ 6,29



ARGILA EXPANDIDA 500 GRS

Código: Fábrika: Unidade:  
**45934** NOVATROPICAL PT/1  
F1 F4

UN: R\$ 8,21 AV: R\$ 8,21 15: R\$ 8,38  
30: R\$ 8,55 45: R\$ 8,72 60: R\$ 8,89



ARGILA MACIA 1 L

Código: Fábrika: Unidade:  
**22664** NOVATROPICAL PT/1  
F1 F4

UN: R\$ 1,95 AV: R\$ 1,95 15: R\$ 1,99  
30: R\$ 2,03 45: R\$ 2,07 60: R\$ 2,11



ARGOLA C/CORRENTE P/CHAVEIRO 10UN

Código: Fábrika: Unidade:  
**44721** BBA PT/1  
F1 F4

UN: R\$ 0,12 AV: R\$ 12,32 15: R\$ 12,57  
30: R\$ 12,82 45: R\$ 13,08 60: R\$ 13,34



ARGOLA CHAVEIRO N20 OURO C/CORRENT 100X1

Código: Fábrika: Unidade:  
**50048** NYBC PT/100  
F1 F4

UN: R\$ 0,21 AV: R\$ 20,53 15: R\$ 20,96  
30: R\$ 21,38 45: R\$ 21,81 60: R\$ 22,24



ARGOLA CHAVEIRO N24 PRATA 100X1

Código: Fábrika: Unidade:  
**50047** NYBC PT/100  
F1 F4

UN: R\$ 0,10 AV: R\$ 10,26 15: R\$ 10,48  
30: R\$ 10,69 45: R\$ 10,90 60: R\$ 11,12



ARGOLA CHAVEIRO 1/2 VOLTA 100X1

Código: Fábrika: Unidade:  
**44335** PLASTCIA CE/100  
F1 F4

UN: R\$ 0,13 AV: R\$ 13,34 15: R\$ 13,62  
30: R\$ 13,89 45: R\$ 14,17 60: R\$ 14,46



ARGOLA CHAVEIRO 2 VOLTAS 100X1

Código: Fábrika: Unidade:  
**44340** PLASTCIA CE/100  
F1 F4

UN: R\$ 0,20 AV: R\$ 19,51 15: R\$ 19,91  
30: R\$ 20,31 45: R\$ 20,72 60: R\$ 21,13



ARGOLA CHAVEIRO 20 MM C/CORRENTE 100X1

Código: 51110 Fábrica: PLASTEC Unidade: PT/100  
F1 F4

UN: R\$ 0,31 AV: R\$ 31,33 15: R\$ 31,98  
30: R\$ 32,62 45: R\$ 33,27 60: R\$ 33,94



ARGOLA CHAVEIRO 25 MM C/CORRENTE 100X1

Código: 50184 Fábrica: PLASTEC Unidade: PT/100  
F1 F4

UN: R\$ 3,65 AV: R\$ 3,65 15: R\$ 3,73  
30: R\$ 3,80 45: R\$ 3,88 60: R\$ 3,96



BACIA PLAST MANICURE 439

Código: 40339 Fábrica: ARES PLAST Unidade: UN/1  
F1 F4

UN: R\$ 4,78 AV: R\$ 4,78 15: R\$ 4,93  
30: R\$ 5,08 45: R\$ 5,23 60: R\$ 5,39



BALANCA ANALOGICA DE FEIRA 0 A 5 KG 412

Código: 29204 Fábrica: YING FA Unidade: CX/1  
F1 F4

UN: R\$ 19,99 AV: R\$ 19,99 15: R\$ 19,99  
30: R\$ 19,99 45: R\$ 19,99 60: R\$ 19,99



BALANCA DIG COZINHA PILHA 1 A 10KG 0012

Código: 30466 Fábrica: GP6 Unidade: CX/1  
F1 F4

UN: R\$ 44,16 AV: R\$ 44,16 15: R\$ 45,08  
30: R\$ 45,98 45: R\$ 46,90 60: R\$ 47,84



BALANCA DIGITAL COZINHA 1G A 8KG 023

Código: 49438 Fábrica: PRATIBELLA Unidade: UN/1  
F1 F4

UN: R\$ 69,08 AV: R\$ 69,08 15: R\$ 70,52  
30: R\$ 71,93 45: R\$ 73,37 60: R\$ 74,83



BALANCA DIGITAL QUADR BATERIA 0A180 KG

Código: 33044 Fábrica: RIOHOME Unidade: UN/1  
F1 F4

UN: R\$ 48,09 AV: R\$ 48,09 15: R\$ 49,10  
30: R\$ 50,08 45: R\$ 51,08 60: R\$ 52,10



BALANCA PRECISAO 12CM 0,1GR A 500GR 1052

Código: 8723 Fábrica: WINMAX Unidade: CX/1  
F1 F4

UN: R\$ 0,49 AV: R\$ 12,32 15: R\$ 12,57  
30: R\$ 12,82 45: R\$ 13,08 60: R\$ 13,34



BALAO 5,0 ALUMINIO BRONZE 25X1

Código: 44755 Fábrica: HAPPYDAY Unidade: PT/25  
F1 F4

UN: R\$ 0,49 AV: R\$ 12,32 15: R\$ 12,57  
30: R\$ 12,82 45: R\$ 13,08 60: R\$ 13,34



BALAO 5,0 ALUMINIO DOURADO 25X1

Código: 44756 Fábrica: HAPPYDAY Unidade: PT/25  
F1 F4

UN: R\$ 0,49 AV: R\$ 12,32 15: R\$ 12,57  
30: R\$ 12,82 45: R\$ 13,08 60: R\$ 13,34



BALAO 5,0 ALUMINIO NATURAL 25X1

Código: 44757 Fábrica: HAPPYDAY Unidade: PT/25  
F1 F4

UN: R\$ 0,25 AV: R\$ 12,32 15: R\$ 12,57  
30: R\$ 12,82 45: R\$ 13,08 60: R\$ 13,34



BALAO 5,0 RED LISO SORTIDO 50X1

Código: 41837 Fábrica: HAPPYDAY Unidade: PT/50  
F1 F4

UN: R\$ 0,39 AV: R\$ 11,71 15: R\$ 11,95  
30: R\$ 12,19 45: R\$ 12,44 60: R\$ 12,69



BALAO 6,0 CORACAO LISO ROSA 30X1

Código: 39191 Fábrica: HAPPY DAY Unidade: PT/30  
F1 F4

UN: R\$ 0,39 AV: R\$ 11,71 15: R\$ 11,95  
30: R\$ 12,19 45: R\$ 12,44 60: R\$ 12,69



BALAO 6,0 CORACAO LISO VERMELHO 30X1

Código: 39192 Fábrica: HAPPY DAY Unidade: PT/30  
F1 F4

UN: R\$ 0,16 AV: R\$ 3,24 15: R\$ 3,30  
30: R\$ 3,37 45: R\$ 3,44 60: R\$ 3,51



BALAO 6,5 PERA LISO AMARELO 20X1

Código: 36546 Fábrica: FOLIA Unidade: PT/20  
F1 F4

UN: R\$ 0,14 AV: R\$ 7,18 15: R\$ 7,33  
30: R\$ 7,48 45: R\$ 7,63 60: R\$ 7,78



BALAO 6,5 PERA LISO AMARELO 50X1

Código: 4300 Fábrica: FOLIA Unidade: PT/50  
F1 F4

UN: R\$ 0,16 AV: R\$ 3,24 15: R\$ 3,30  
30: R\$ 3,37 45: R\$ 3,44 60: R\$ 3,51



BALAO 6,5 PERA LISO AZUL CLARO 20X1  
Código: 37375 Fábrica: FOLIA Unidade: PT/20 F1 F4

UN: R\$ 0,14 AV: R\$ 7,18 15: R\$ 7,33  
30: R\$ 7,48 45: R\$ 7,63 60: R\$ 7,78



BALAO 6,5 PERA LISO AZUL CLARO 50X1  
Código: 39551 Fábrica: FOLIA Unidade: PT/50 F1 F4

UN: R\$ 0,16 AV: R\$ 3,24 15: R\$ 3,30  
30: R\$ 3,37 45: R\$ 3,44 60: R\$ 3,51



BALAO 6,5 PERA LISO AZUL 20X1  
Código: 36545 Fábrica: FOLIA Unidade: PT/20 F1 F4

UN: R\$ 0,14 AV: R\$ 7,18 15: R\$ 7,33  
30: R\$ 7,48 45: R\$ 7,63 60: R\$ 7,78



BALAO 6,5 PERA LISO AZUL 50X1  
Código: 8726 Fábrica: FOLIA Unidade: PT/50 F1 F4

UN: R\$ 0,16 AV: R\$ 3,24 15: R\$ 3,30  
30: R\$ 3,37 45: R\$ 3,44 60: R\$ 3,51



BALAO 6,5 PERA LISO BRANCO 20X1  
Código: 36547 Fábrica: FOLIA Unidade: PT/20 F1 F4

UN: R\$ 0,14 AV: R\$ 7,18 15: R\$ 7,33  
30: R\$ 7,48 45: R\$ 7,63 60: R\$ 7,78



BALAO 6,5 PERA LISO BRANCO 50X1  
Código: 36541 Fábrica: FOLIA Unidade: PT/50 F1 F4

UN: R\$ 0,16 AV: R\$ 3,24 15: R\$ 3,30  
30: R\$ 3,37 45: R\$ 3,44 60: R\$ 3,51



BALAO 6,5 PERA LISO LARANJA 20X1  
Código: 36551 Fábrica: FOLIA Unidade: PT/20 F1 F4

UN: R\$ 0,14 AV: R\$ 7,18 15: R\$ 7,33  
30: R\$ 7,48 45: R\$ 7,63 60: R\$ 7,78

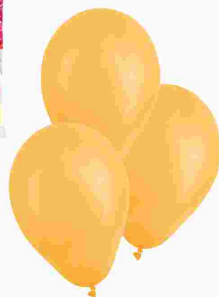

BALAO 6,5 PERA LISO LARANJA 50X1  
Código: 8729 Fábrica: FOLIA Unidade: PT/50 F1 F4

UN: R\$ 0,16 AV: R\$ 3,24 15: R\$ 3,30  
30: R\$ 3,37 45: R\$ 3,44 60: R\$ 3,51



BALAO 6,5 PERA LISO LILAS 20X1  
Código: 36554 Fábrica: FOLIA Unidade: PT/20 F1 F4

UN: R\$ 0,11 AV: R\$ 3,24 15: R\$ 3,30  
30: R\$ 3,37 45: R\$ 3,44 60: R\$ 3,51



BALAO 6,5 PERA LISO PRETO 20X1  
Código: 36550 Fábrica: FOLIA Unidade: PT/30 F1 F4

UN: R\$ 0,14 AV: R\$ 7,18 15: R\$ 7,33  
30: R\$ 7,48 45: R\$ 7,63 60: R\$ 7,78



BALAO 6,5 PERA LISO PRETO 50X1  
Código: 36543 Fábrica: FOLIA Unidade: PT/50 F1 F4

UN: R\$ 0,16 AV: R\$ 3,24 15: R\$ 3,30  
30: R\$ 3,37 45: R\$ 3,44 60: R\$ 3,51



BALAO 6,5 PERA LISO ROSA 20X1  
Código: 36548 Fábrica: FOLIA Unidade: PT/20 F1 F4

UN: R\$ 0,14 AV: R\$ 7,18 15: R\$ 7,33  
30: R\$ 7,48 45: R\$ 7,63 60: R\$ 7,78



BALAO 6,5 PERA LISO ROSA 50X1  
Código: 8731 Fábrica: FOLIA Unidade: PT/50 F1 F4

UN: R\$ 0,16 AV: R\$ 3,24 15: R\$ 3,30  
30: R\$ 3,37 45: R\$ 3,44 60: R\$ 3,51



BALAO 6,5 PERA LISO SORTIDO 20X1  
Código: 36553 Fábrica: FOLIA Unidade: PT/20 F1 F4

UN: R\$ 0,16 AV: R\$ 3,24 15: R\$ 3,30  
30: R\$ 3,37 45: R\$ 3,44 60: R\$ 3,51



BALAO 6,5 PERA LISO VERDE BANDEIRA 20X1  
Código: 36549 Fábrica: FOLIA Unidade: PT/20 F1 F4

UN: R\$ 0,14 AV: R\$ 7,18 15: R\$ 7,33  
30: R\$ 7,48 45: R\$ 7,63 60: R\$ 7,78



BALAO 6,5 PERA LISO VERDE BANDEIRA 50X1  
Código: 36542 Fábrica: FOLIA Unidade: PT/50 F1 F4

UN: R\$ 0,16 AV: R\$ 3,24 15: R\$ 3,30  
30: R\$ 3,37 45: R\$ 3,44 60: R\$ 3,51



BALAO 6,5 PERA LISO VERMELHO 20X1  
Código: 36552 Fábrica: FOLIA Unidade: PT/20 F1 F4

UN: R\$ 0,14 AV: R\$ 7,18 15: R\$ 7,33  
30: R\$ 7,48 45: R\$ 7,63 60: R\$ 7,78



BALAO 6,5 PERA LISO VERMELHO 50X1  
Código: 8735 Fábrica: FOLIA Unidade: PT/50 F1 F4

UN: R\$ 0,37 AV: R\$ 18,48 15: R\$ 18,86  
30: R\$ 19,24 45: R\$ 19,63 60: R\$ 20,02



BALAO 7,0 LISO DOURADO 50X1  
Código: 43720 Fábrica: FOLIA Unidade: PT/50 F1 F4

UN: R\$ 0,15 AV: R\$ 7,49 15: R\$ 7,64  
30: R\$ 7,80 45: R\$ 7,95 60: R\$ 8,11



BALAO 7,0 PERA LISO AMARELO 50X1  
Código: 41006 Fábrica: FOLIA Unidade: PT/50 F1 F4

UN: R\$ 0,15 AV: R\$ 7,49 15: R\$ 7,64  
30: R\$ 7,80 45: R\$ 7,95 60: R\$ 8,11

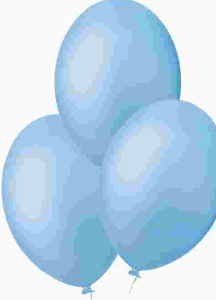

BALAO 7,0 PERA LISO AZUL CLARO 50X1  
Código: 41003 Fábrica: FOLIA Unidade: PT/50 F1 F4

UN: R\$ 0,15 AV: R\$ 7,49 15: R\$ 7,64  
30: R\$ 7,80 45: R\$ 7,95 60: R\$ 8,11



BALAO 7,0 PERA LISO AZUL ESCURO 50X1  
Código: 41005 Fábrica: FOLIA Unidade: PT/50 F1 F4

UN: R\$ 0,15 AV: R\$ 7,49 15: R\$ 7,64  
30: R\$ 7,80 45: R\$ 7,95 60: R\$ 8,11



BALAO 7,0 PERA LISO BRANCO 50X1  
Código: 40734 Fábrica: FOLIA Unidade: PT/50 F1 F4

UN: R\$ 0,23 AV: R\$ 11,29 15: R\$ 11,52  
30: R\$ 11,75 45: R\$ 11,99 60: R\$ 12,23



BALAO 7,0 PERA LISO FELIZ ANI SORT 50X1  
Código: 32776 Fábrica: FOLIA Unidade: PT/50 F1 F4

UN: R\$ 0,15 AV: R\$ 7,49 15: R\$ 7,64  
30: R\$ 7,80 45: R\$ 7,95 60: R\$ 8,11



BALAO 7,0 PERA LISO LARANJA 50X1  
Código: 41008 Fábrica: FOLIA Unidade: PT/50 F1 F4

UN: R\$ 0,15 AV: R\$ 7,49 15: R\$ 7,64  
30: R\$ 7,80 45: R\$ 7,95 60: R\$ 8,11

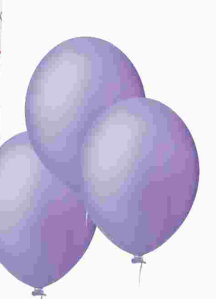

BALAO 7,0 PERA LISO LILAS 50X1  
Código: 40735 Fábrica: FOLIA Unidade: PT/50 F1 F4

UN: R\$ 0,15 AV: R\$ 7,49 15: R\$ 7,64  
30: R\$ 7,80 45: R\$ 7,95 60: R\$ 8,11



BALAO 7,0 PERA LISO PINK 50X1  
Código: 41001 Fábrica: FOLIA Unidade: PT/50 F1 F4

UN: R\$ 0,15 AV: R\$ 7,49 15: R\$ 7,64  
30: R\$ 7,80 45: R\$ 7,95 60: R\$ 8,11



BALAO 7,0 PERA LISO PRETO 50X1  
Código: 41004 Fábrica: FOLIA Unidade: PT/50 F1 F4

UN: R\$ 0,15 AV: R\$ 7,49 15: R\$ 7,64  
30: R\$ 7,80 45: R\$ 7,95 60: R\$ 8,11



BALAO 7,0 PERA LISO ROSA 50X1  
Código: 41002 Fábrica: FOLIA Unidade: PT/50 F1 F4

UN: R\$ 0,14 AV: R\$ 7,18 15: R\$ 7,33  
30: R\$ 7,48 45: R\$ 7,63 60: R\$ 7,78



BALAO 7,0 PERA LISO SORTIDO 50X1  
Código: 45274 Fábrica: FOLIA Unidade: PT/50 F1 F4

UN: R\$ 0,15 AV: R\$ 7,49 15: R\$ 7,64  
30: R\$ 7,80 45: R\$ 7,95 60: R\$ 8,11



BALAO 7,0 PERA LISO VERDE BANDEIRA 50X1  
Código: 40736 Fábrica: FOLIA Unidade: PT/50 F1 F4

UN: R\$ 0,15 AV: R\$ 7,49 15: R\$ 7,64  
30: R\$ 7,80 45: R\$ 7,95 60: R\$ 8,11

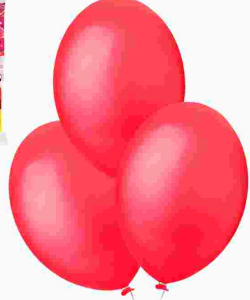

BALAO 7,0 PERA LISO VERMELHO 50X1  
Código: 41007 Fábrica: FOLIA Unidade: PT/50 F1 F4

UN: R\$ 0,31 AV: R\$ 15,40 15: R\$ 15,72  
30: R\$ 16,03 45: R\$ 16,35 60: R\$ 16,68

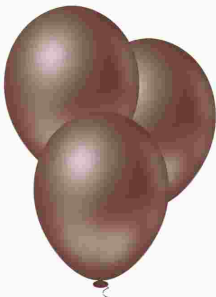

BALAO 8,0 LISO RED MARROM 50X1  
Código: Fábrika: Unidade:  
**29267** PIC PIC PT/50  
F1 F4

UN: R\$ 0,31 AV: R\$ 15,40 15: R\$ 15,72  
30: R\$ 16,03 45: R\$ 16,35 60: R\$ 16,68



BALAO 8,0 PERA LISO AMARELO OCRE 50X1  
Código: Fábrika: Unidade:  
**42367** HAPPY DAY PT/50  
F1 F4

UN: R\$ 0,31 AV: R\$ 15,40 15: R\$ 15,72  
30: R\$ 16,03 45: R\$ 16,35 60: R\$ 16,68



BALAO 8,0 PERA LISO AMARELO 50X1  
Código: Fábrika: Unidade:  
**42362** HAPPY DAY PT/50  
F1 F4

UN: R\$ 0,31 AV: R\$ 15,40 15: R\$ 15,72  
30: R\$ 16,03 45: R\$ 16,35 60: R\$ 16,68



BALAO 8,0 PERA LISO AZUL CELESTE 50X1  
Código: Fábrika: Unidade:  
**42371** HAPPY DAY PT/50  
F1 F4

UN: R\$ 0,31 AV: R\$ 15,40 15: R\$ 15,72  
30: R\$ 16,03 45: R\$ 16,35 60: R\$ 16,68



BALAO 8,0 PERA LISO AZUL CLA CANDY 50X1  
Código: Fábrika: Unidade:  
**42369** HAPPY DAY PT/50  
F1 F4

UN: R\$ 0,31 AV: R\$ 15,40 15: R\$ 15,72  
30: R\$ 16,03 45: R\$ 16,35 60: R\$ 16,68



BALAO 8,0 PERA LISO AZUL TIFANNY 50X1  
Código: Fábrika: Unidade:  
**42368** HAPPY DAY PT/50  
F1 F4

UN: R\$ 0,31 AV: R\$ 15,40 15: R\$ 15,72  
30: R\$ 16,03 45: R\$ 16,35 60: R\$ 16,68



BALAO 8,0 PERA LISO AZUL 50X1  
Código: Fábrika: Unidade:  
**42361** HAPPY DAY PT/50  
F1 F4

UN: R\$ 0,31 AV: R\$ 15,40 15: R\$ 15,72  
30: R\$ 16,03 45: R\$ 16,35 60: R\$ 16,68



BALAO 8,0 PERA LISO BEGE CANDY 50X1  
Código: Fábrika: Unidade:  
**42377** HAPPY DAY PT/50  
F1 F4

UN: R\$ 0,31 AV: R\$ 15,40 15: R\$ 15,72  
30: R\$ 16,03 45: R\$ 16,35 60: R\$ 16,68



BALAO 8,0 PERA LISO BRANCO 50X1  
Código: Fábrika: Unidade:  
**42378** HAPPY DAY PT/50  
F1 F4

UN: R\$ 0,31 AV: R\$ 15,40 15: R\$ 15,72  
30: R\$ 16,03 45: R\$ 16,35 60: R\$ 16,68

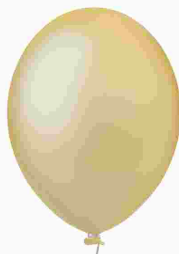

BALAO 8,0 PERA LISO CHAMPAGNE 50X1  
Código: Fábrika: Unidade:  
**42354** HAPPY DAY PT/50  
F1 F4

UN: R\$ 0,31 AV: R\$ 15,40 15: R\$ 15,72  
30: R\$ 16,03 45: R\$ 16,35 60: R\$ 16,68



BALAO 8,0 PERA LISO CORAL 50X1  
Código: Fábrika: Unidade:  
**42357** HAPPY DAY PT/50  
F1 F4

UN: R\$ 0,31 AV: R\$ 15,40 15: R\$ 15,72  
30: R\$ 16,03 45: R\$ 16,35 60: R\$ 16,68



BALAO 8,0 PERA LISO FUCSIA 50X1  
Código: Fábrika: Unidade:  
**42359** HAPPY DAY PT/50  
F1 F4

UN: R\$ 0,31 AV: R\$ 15,40 15: R\$ 15,72  
30: R\$ 16,03 45: R\$ 16,35 60: R\$ 16,68



BALAO 8,0 PERA LISO LARANJA 50X1  
Código: Fábrika: Unidade:  
**42374** HAPPY DAY PT/50  
F1 F4

UN: R\$ 0,30 AV: R\$ 14,89 15: R\$ 15,20  
30: R\$ 15,51 45: R\$ 15,82 60: R\$ 16,14



BALAO 8,0 PERA LISO LILAS CANDY 50X1  
Código: Fábrika: Unidade:  
**42360** HAPPY DAY PT/50  
F1 F4

UN: R\$ 0,31 AV: R\$ 15,40 15: R\$ 15,72  
30: R\$ 16,03 45: R\$ 16,35 60: R\$ 16,68



BALAO 8,0 PERA LISO MARFIM CANDY 50X1  
Código: Fábrika: Unidade:  
**42363** HAPPY DAY PT/50  
F1 F4

UN: R\$ 0,31 AV: R\$ 15,40 15: R\$ 15,72  
30: R\$ 16,03 45: R\$ 16,35 60: R\$ 16,68



BALAO 8,0 PERA LISO MARROM 50X1  
Código: Fábrika: Unidade:  
**42376** HAPPY DAY PT/50  
F1 F4

UN: R\$ 0,31 AV: R\$ 15,40 15: R\$ 15,72  
30: R\$ 16,03 45: R\$ 16,35 60: R\$ 16,68



BALAO 8,0 PERA LISO MARSALA 50X1  
Código: Fábrica: Unidade:  
**42379** HAPPY DAY PT/50  
F1 F4

UN: R\$ 0,31 AV: R\$ 15,40 15: R\$ 15,72  
30: R\$ 16,03 45: R\$ 16,35 60: R\$ 16,68



BALAO 8,0 PERA LISO PRETO 50X1  
Código: Fábrica: Unidade:  
**42366** HAPPY DAY PT/50  
F1 F4

UN: R\$ 0,31 AV: R\$ 15,40 15: R\$ 15,72  
30: R\$ 16,03 45: R\$ 16,35 60: R\$ 16,68



BALAO 8,0 PERA LISO ROSA 50X1  
Código: Fábrica: Unidade:  
**42365** HAPPY DAY PT/50  
F1 F4

UN: R\$ 0,31 AV: R\$ 15,40 15: R\$ 15,72  
30: R\$ 16,03 45: R\$ 16,35 60: R\$ 16,68



BALAO 8,0 PERA LISO ROSA BB CANDY 50X1  
Código: Fábrica: Unidade:  
**42364** HAPPY DAY PT/50  
F1 F4

UN: R\$ 0,31 AV: R\$ 15,40 15: R\$ 15,72  
30: R\$ 16,03 45: R\$ 16,35 60: R\$ 16,68



BALAO 8,0 PERA LISO ROSA PINK 50X1  
Código: Fábrica: Unidade:  
**42373** HAPPY DAY PT/50  
F1 F4

UN: R\$ 0,31 AV: R\$ 15,40 15: R\$ 15,72  
30: R\$ 16,03 45: R\$ 16,35 60: R\$ 16,68



BALAO 8,0 PERA LISO SORTIDO 50X1  
Código: Fábrica: Unidade:  
**42380** HAPPY DAY PT/50  
F1 F4

UN: R\$ 0,31 AV: R\$ 15,40 15: R\$ 15,72  
30: R\$ 16,03 45: R\$ 16,35 60: R\$ 16,68



BALAO 8,0 PERA LISO TERRA COTA 50X1  
Código: Fábrica: Unidade:  
**42356** HAPPY DAY PT/50  
F1 F4

UN: R\$ 0,31 AV: R\$ 15,40 15: R\$ 15,72  
30: R\$ 16,03 45: R\$ 16,35 60: R\$ 16,68



BALAO 8,0 PERA LISO UVA 50X1  
Código: Fábrica: Unidade:  
**42355** HAPPY DAY PT/50  
F1 F4

UN: R\$ 0,31 AV: R\$ 15,40 15: R\$ 15,72  
30: R\$ 16,03 45: R\$ 16,35 60: R\$ 16,68



BALAO 8,0 PERA LISO VERDE AGUA 50X1  
Código: Fábrica: Unidade:  
**42353** HAPPY DAY PT/50  
F1 F4

UN: R\$ 0,31 AV: R\$ 15,40 15: R\$ 15,72  
30: R\$ 16,03 45: R\$ 16,35 60: R\$ 16,68

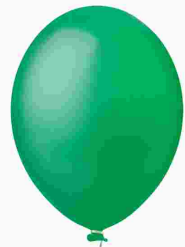

BALAO 8,0 PERA LISO VERDE BANDEIRA 50X1  
Código: Fábrica: Unidade:  
**42350** HAPPY DAY PT/50  
F1 F4

UN: R\$ 0,31 AV: R\$ 15,40 15: R\$ 15,72  
30: R\$ 16,03 45: R\$ 16,35 60: R\$ 16,68



BALAO 8,0 PERA LISO VERDE EUCALIPT 50X1  
Código: Fábrica: Unidade:  
**42349** HAPPY DAY PT/50  
F1 F4

UN: R\$ 0,31 AV: R\$ 15,40 15: R\$ 15,72  
30: R\$ 16,03 45: R\$ 16,35 60: R\$ 16,68



BALAO 8,0 PERA LISO VERDE LIMAO 50X1  
Código: Fábrica: Unidade:  
**42352** HAPPY DAY PT/50  
F1 F4

UN: R\$ 0,31 AV: R\$ 15,40 15: R\$ 15,72  
30: R\$ 16,03 45: R\$ 16,35 60: R\$ 16,68

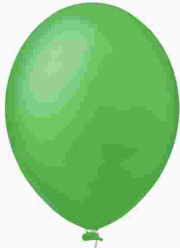

BALAO 8,0 PERA LISO VERDE 50X1  
Código: Fábrica: Unidade:  
**42351** HAPPY DAY PT/50  
F1 F4

UN: R\$ 0,31 AV: R\$ 15,40 15: R\$ 15,72  
30: R\$ 16,03 45: R\$ 16,35 60: R\$ 16,68



BALAO 8,0 PERA LISO VERMELHO 50X1  
Código: Fábrica: Unidade:  
**42372** HAPPY DAY PT/50  
F1 F4

UN: R\$ 0,31 AV: R\$ 15,40 15: R\$ 15,72  
30: R\$ 16,03 45: R\$ 16,35 60: R\$ 16,68



BALAO 8,0 PERA LISO VIOLETA 50X1  
Código: Fábrica: Unidade:  
**42370** HAPPY DAY PT/50  
F1 F4

UN: R\$ 0,41 AV: R\$ 10,26 15: R\$ 10,48  
30: R\$ 10,69 45: R\$ 10,90 60: R\$ 11,12

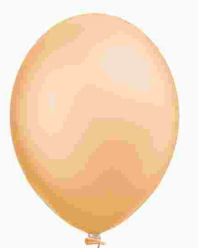

BALAO 8,0 PEROLIZADO OURO 25X1  
Código: Fábrica: Unidade:  
**44753** HAPPY DAY PT/25  
F1 F4

UN: R\$ 0,41 AV: R\$ 10,26 15: R\$ 10,48  
30: R\$ 10,69 45: R\$ 10,90 60: R\$ 11,12



BALAO 8,0 PEROLIZADO PRATA 25X1  
Código: Fábrika: Unidade:  
**44754** HAPPY DAY PT/25  
F1 F4

UN: R\$ 0,31 AV: R\$ 15,40 15: R\$ 15,72  
30: R\$ 16,03 45: R\$ 16,35 60: R\$ 16,68

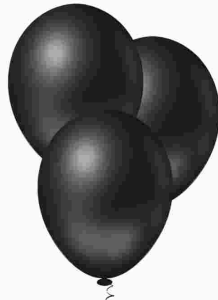

BALAO 8,0 RED LISO PRETO 50X1  
Código: Fábrika: Unidade:  
**50697** PICPIC PT/50  
F1 F4

UN: R\$ 0,35 AV: R\$ 17,45 15: R\$ 17,82  
30: R\$ 18,17 45: R\$ 18,54 60: R\$ 18,91



BALAO 9,0 PERA LISO VERDE 50X1  
Código: Fábrika: Unidade:  
**42835** HAPPY DAY PT/50  
F1 F4

UN: R\$ 0,81 AV: R\$ 20,18 15: R\$ 20,61  
30: R\$ 21,02 45: R\$ 21,44 60: R\$ 21,87

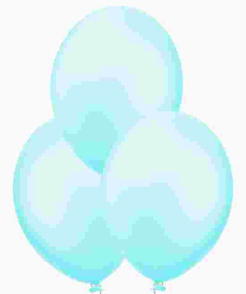

BALAO 9,0 PEROL CANDY AZUL CLARO 25X1  
Código: Fábrika: Unidade:  
**45918** HAPPY DAY PT/25  
F1 F4

UN: R\$ 0,81 AV: R\$ 20,18 15: R\$ 20,61  
30: R\$ 21,02 45: R\$ 21,44 60: R\$ 21,87



BALAO 9,0 PEROL CANDY BRANCO 25X1  
Código: Fábrika: Unidade:  
**45919** HAPPY DAY PT/25  
F1 F4

UN: R\$ 0,81 AV: R\$ 20,18 15: R\$ 20,61  
30: R\$ 21,02 45: R\$ 21,44 60: R\$ 21,87



BALAO 9,0 PEROL CANDY LILAS 25X1  
Código: Fábrika: Unidade:  
**45921** HAPPY DAY PT/25  
F1 F4

UN: R\$ 0,81 AV: R\$ 20,18 15: R\$ 20,61  
30: R\$ 21,02 45: R\$ 21,44 60: R\$ 21,87



BALAO 9,0 PEROL CANDY MARFIM 25X1  
Código: Fábrika: Unidade:  
**45920** HAPPY DAY PT/25  
F1 F4

UN: R\$ 0,81 AV: R\$ 20,18 15: R\$ 20,61  
30: R\$ 21,02 45: R\$ 21,44 60: R\$ 21,87



BALAO 9,0 PEROL CANDY OURO 25X1  
Código: Fábrika: Unidade:  
**45924** HAPPY DAY PT/25  
F1 F4

UN: R\$ 0,81 AV: R\$ 20,18 15: R\$ 20,61  
30: R\$ 21,02 45: R\$ 21,44 60: R\$ 21,87

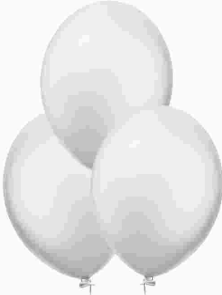

BALAO 9,0 PEROL CANDY PRATA 25X1  
Código: Fábrika: Unidade:  
**45925** HAPPY DAY PT/25  
F1 F4

UN: R\$ 0,81 AV: R\$ 20,18 15: R\$ 20,61  
30: R\$ 21,02 45: R\$ 21,44 60: R\$ 21,87



BALAO 9,0 PEROL CANDY ROSA BB 25X1  
Código: Fábrika: Unidade:  
**45922** HAPPY DAY PT/25  
F1 F4

UN: R\$ 0,81 AV: R\$ 20,18 15: R\$ 20,61  
30: R\$ 21,02 45: R\$ 21,44 60: R\$ 21,87



BALAO 9,0 PEROL CANDY SORT 25X1  
Código: Fábrika: Unidade:  
**45917** HAPPY DAY PT/25  
F1 F4

UN: R\$ 0,81 AV: R\$ 20,18 15: R\$ 20,61  
30: R\$ 21,02 45: R\$ 21,44 60: R\$ 21,87

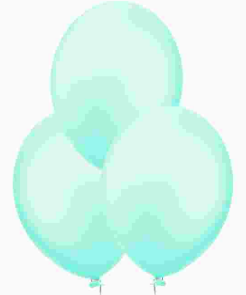

BALAO 9,0 PEROL CANDY VERDE AGUA 25X1  
Código: Fábrika: Unidade:  
**45923** HAPPY DAY PT/25  
F1 F4

UN: R\$ 1,07 AV: R\$ 26,70 15: R\$ 27,25  
30: R\$ 27,80 45: R\$ 28,35 60: R\$ 28,92



BALAO 9,0 RED ALUMINIO AMARELO MOS 25X1  
Código: Fábrika: Unidade:  
**38522** HAPPY DAY PT/25  
F1 F4

UN: R\$ 1,07 AV: R\$ 26,70 15: R\$ 27,25  
30: R\$ 27,80 45: R\$ 28,35 60: R\$ 28,92



BALAO 9,0 RED ALUMINIO AZUL MEIA N 25X1  
Código: Fábrika: Unidade:  
**38517** HAPPY DAY PT/25  
F1 F4

UN: R\$ 1,07 AV: R\$ 26,70 15: R\$ 27,25  
30: R\$ 27,80 45: R\$ 28,35 60: R\$ 28,92

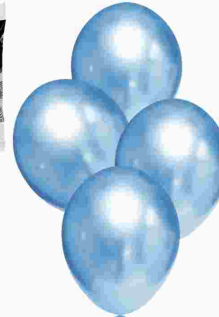

BALAO 9,0 RED ALUMINIO AZUL 25X1  
Código: Fábrika: Unidade:  
**37901** HAPPY DAY PT/25  
F1 F4

UN: R\$ 1,07 AV: R\$ 26,70 15: R\$ 27,25  
30: R\$ 27,80 45: R\$ 28,35 60: R\$ 28,92



BALAO 9,0 RED ALUMINIO BRONZE  
Código: Fábrika: Unidade:  
**37908** HAPPY DAY PT/25  
F1 F4

UN: R\$ 1,07 AV: R\$ 26,70 15: R\$ 27,25  
30: R\$ 27,80 45: R\$ 28,35 60: R\$ 28,92



BALAO 9,0 RED ALUMINIO DOURADO 25X1  
Código: 37909 Fábrica: HAPPY DAY Unidade: PT/25 F1 F4

UN: R\$ 1,07 AV: R\$ 26,70 15: R\$ 27,25  
30: R\$ 27,80 45: R\$ 28,35 60: R\$ 28,92



BALAO 9,0 RED ALUMINIO FUCSIA 25X1  
Código: 37906 Fábrica: HAPPY DAY Unidade: PT/25 F1 F4

UN: R\$ 1,07 AV: R\$ 26,70 15: R\$ 27,25  
30: R\$ 27,80 45: R\$ 28,35 60: R\$ 28,92



BALAO 9,0 RED ALUMINIO LILAS 25X1  
Código: 38518 Fábrica: HAPPY DAY Unidade: PT/25 F1 F4

UN: R\$ 1,07 AV: R\$ 26,70 15: R\$ 27,25  
30: R\$ 27,80 45: R\$ 28,35 60: R\$ 28,92



BALAO 9,0 RED ALUMINIO NATURAL 25X1  
Código: 37907 Fábrica: HAPPY DAY Unidade: PT/25 F1 F4

UN: R\$ 1,07 AV: R\$ 26,70 15: R\$ 27,25  
30: R\$ 27,80 45: R\$ 28,35 60: R\$ 28,92



BALAO 9,0 RED ALUMINIO ONIX  
Código: 37913 Fábrica: HAPPY DAY Unidade: PT/25 F1 F4

UN: R\$ 1,07 AV: R\$ 26,70 15: R\$ 27,25  
30: R\$ 27,80 45: R\$ 28,35 60: R\$ 28,92



BALAO 9,0 RED ALUMINIO PINK 25X1  
Código: 37910 Fábrica: HAPPY DAY Unidade: PT/25 F1 F4

UN: R\$ 1,07 AV: R\$ 26,70 15: R\$ 27,25  
30: R\$ 27,80 45: R\$ 28,35 60: R\$ 28,92



BALAO 9,0 RED ALUMINIO PRATA 25X1  
Código: 50671 Fábrica: HAPPY DAY Unidade: PT/25 F1 F4

UN: R\$ 1,07 AV: R\$ 26,70 15: R\$ 27,25  
30: R\$ 27,80 45: R\$ 28,35 60: R\$ 28,92



BALAO 9,0 RED ALUMINIO PRETO 25X1  
Código: 50670 Fábrica: HAPPY DAY Unidade: PT/25 F1 F4

UN: R\$ 1,07 AV: R\$ 26,70 15: R\$ 27,25  
30: R\$ 27,80 45: R\$ 28,35 60: R\$ 28,92



BALAO 9,0 RED ALUMINIO ROSE GOLD 25X1  
Código: 37914 Fábrica: HAPPY DAY Unidade: PT/25 F1 F4

UN: R\$ 1,07 AV: R\$ 26,70 15: R\$ 27,25  
30: R\$ 27,80 45: R\$ 28,35 60: R\$ 28,92



BALAO 9,0 RED ALUMINIO ROSE 25X1  
Código: 37905 Fábrica: HAPPY DAY Unidade: PT/25 F1 F4

UN: R\$ 1,07 AV: R\$ 26,70 15: R\$ 27,25  
30: R\$ 27,80 45: R\$ 28,35 60: R\$ 28,92



BALAO 9,0 RED ALUMINIO SORTIDO 25X1  
Código: 37902 Fábrica: HAPPY DAY Unidade: PT/25 F1 F4

UN: R\$ 1,07 AV: R\$ 26,70 15: R\$ 27,25  
30: R\$ 27,80 45: R\$ 28,35 60: R\$ 28,92



BALAO 9,0 RED ALUMINIO VERDE OCEAN 25X1  
Código: 38519 Fábrica: HAPPY DAY Unidade: PT/25 F1 F4

UN: R\$ 1,07 AV: R\$ 26,70 15: R\$ 27,25  
30: R\$ 27,80 45: R\$ 28,35 60: R\$ 28,92



BALAO 9,0 RED ALUMINIO VERDE 25X1  
Código: 37904 Fábrica: HAPPY DAY Unidade: PT/25 F1 F4

UN: R\$ 1,07 AV: R\$ 26,70 15: R\$ 27,25  
30: R\$ 27,80 45: R\$ 28,35 60: R\$ 28,92



BALAO 9,0 RED ALUMINIO VERMELHO 25X1  
Código: 37911 Fábrica: HAPPY DAY Unidade: PT/25 F1 F4

UN: R\$ 1,07 AV: R\$ 26,70 15: R\$ 27,25  
30: R\$ 27,80 45: R\$ 28,35 60: R\$ 28,92



BALAO 9,0 RED ALUMINIO VIOLETA 25X1  
Código: 37903 Fábrica: HAPPY DAY Unidade: PT/25 F1 F4

UN: R\$ 0,33 AV: R\$ 16,42 15: R\$ 16,77  
30: R\$ 17,10 45: R\$ 17,44 60: R\$ 17,79



BALAO 9,0 RED LISO LILAS CANDY 50X1  
Código: 50111 Fábrica: HAPPY DAY Unidade: PT/50 F1 F4

UN: R\$ 0,33 AV: R\$ 16,42 15: R\$ 16,77  
30: R\$ 17,10 45: R\$ 17,44 60: R\$ 17,79

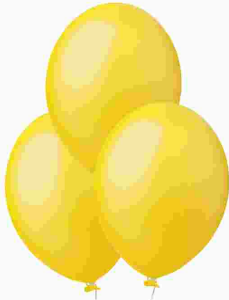

BALAO 9,0 RED LISO AMARELO  
Código: **40621** Fábrica: HAPPY DAY Unidade: PT/50 F1 F4

UN: R\$ 0,33 AV: R\$ 16,42 15: R\$ 16,77  
30: R\$ 17,10 45: R\$ 17,44 60: R\$ 17,79

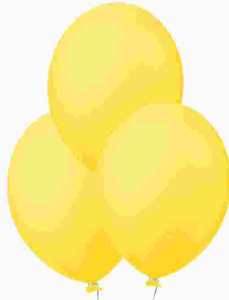

BALAO 9,0 RED LISO AMARELO 50X1  
Código: **29280** Fábrica: FOLIA Unidade: PT/50 F1 F4

UN: R\$ 0,33 AV: R\$ 16,42 15: R\$ 16,77  
30: R\$ 17,10 45: R\$ 17,44 60: R\$ 17,79

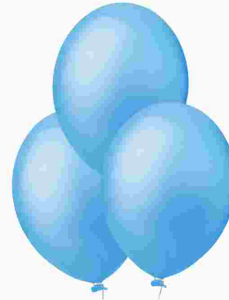

BALAO 9,0 RED LISO AZUL  
Código: **40622** Fábrica: HAPPY DAY Unidade: PT/50 F1 F4

UN: R\$ 0,33 AV: R\$ 16,42 15: R\$ 16,77  
30: R\$ 17,10 45: R\$ 17,44 60: R\$ 17,79



BALAO 9,0 RED LISO AZUL CLARO CAND 50X1  
Código: **41013** Fábrica: HAPPY DAY Unidade: PT/50 F1 F4

UN: R\$ 0,33 AV: R\$ 16,42 15: R\$ 16,77  
30: R\$ 17,10 45: R\$ 17,44 60: R\$ 17,79

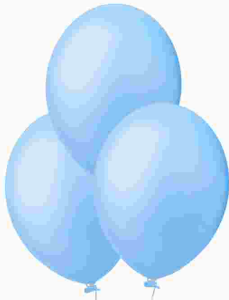

BALAO 9,0 RED LISO AZUL CLARO 50X1  
Código: **31290** Fábrica: FOLIA Unidade: PT/50 F1 F4

UN: R\$ 0,33 AV: R\$ 16,42 15: R\$ 16,77  
30: R\$ 17,10 45: R\$ 17,44 60: R\$ 17,79



BALAO 9,0 RED LISO AZUL ESCURO 50X1  
Código: **31289** Fábrica: FOLIA Unidade: PT/50 F1 F4

UN: R\$ 0,33 AV: R\$ 16,42 15: R\$ 16,77  
30: R\$ 17,10 45: R\$ 17,44 60: R\$ 17,79

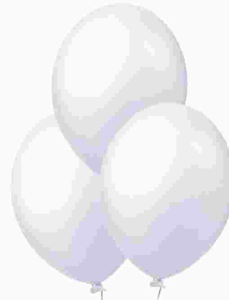

BALAO 9,0 RED LISO BRANCO 50X1  
Código: **41011** Fábrica: HAPPY DAY Unidade: PT/50 F1 F4

UN: R\$ 0,33 AV: R\$ 16,42 15: R\$ 16,77  
30: R\$ 17,10 45: R\$ 17,44 60: R\$ 17,79



BALAO 9,0 RED LISO BRANCO 50X1  
Código: **29285** Fábrica: FOLIA Unidade: PT/50 F1 F4

UN: R\$ 0,33 AV: R\$ 16,42 15: R\$ 16,77  
30: R\$ 17,10 45: R\$ 17,44 60: R\$ 17,79



BALAO 9,0 RED LISO LILAS 50X1  
Código: **31291** Fábrica: FOLIA Unidade: PT/50 F1 F4

UN: R\$ 0,33 AV: R\$ 16,42 15: R\$ 16,77  
30: R\$ 17,10 45: R\$ 17,44 60: R\$ 17,79

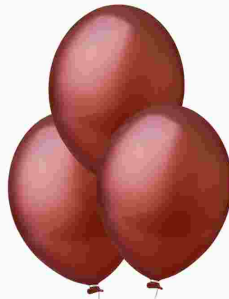

BALAO 9,0 RED LISO MARRON 50X1  
Código: **29288** Fábrica: FOLIA Unidade: PT/50 F1 F4

UN: R\$ 0,33 AV: R\$ 16,42 15: R\$ 16,77  
30: R\$ 17,10 45: R\$ 17,44 60: R\$ 17,79



BALAO 9,0 RED LISO PRETO 50X1  
Código: **40620** Fábrica: HAPPY DAY Unidade: PT/50 F1 F4

UN: R\$ 0,33 AV: R\$ 16,42 15: R\$ 16,77  
30: R\$ 17,10 45: R\$ 17,44 60: R\$ 17,79



BALAO 9,0 RED LISO PRETO 50X1  
Código: **29287** Fábrica: FOLIA Unidade: PT/50 F1 F4

UN: R\$ 0,33 AV: R\$ 16,42 15: R\$ 16,77  
30: R\$ 17,10 45: R\$ 17,44 60: R\$ 17,79



BALAO 9,0 RED LISO ROSA 50X1  
Código: **29281** Fábrica: FOLIA Unidade: PT/50 F1 F4

UN: R\$ 0,33 AV: R\$ 16,42 15: R\$ 16,77  
30: R\$ 17,10 45: R\$ 17,44 60: R\$ 17,79



BALAO 9,0 RED LISO SORTIDO 50X1  
Código: **30033** Fábrica: FOLIA Unidade: PT/50 F1 F4

UN: R\$ 0,33 AV: R\$ 16,42 15: R\$ 16,77  
30: R\$ 17,10 45: R\$ 17,44 60: R\$ 17,79



BALAO 9,0 RED LISO VERDE BANDEIRA 50X1  
Código: **45916** Fábrica: FOLIA Unidade: PT/50 F1 F4

UN: R\$ 0,33 AV: R\$ 16,42 15: R\$ 16,77  
30: R\$ 17,10 45: R\$ 17,44 60: R\$ 17,79



BALAO 9,0 RED LISO VERDE ESCURO 50X1  
Código: **29286** Fábrica: FOLIA Unidade: PT/50 F1 F4

UN: R\$ 0,33 AV: R\$ 16,42 15: R\$ 16,77  
30: R\$ 17,10 45: R\$ 17,44 60: R\$ 17,79



BALAO 9,0 RED LISO VERMELHO

Código: 31293 Fábrica: FOLIA Unidade: PT/50 F1 F4

UN: R\$ 0,51 AV: R\$ 15,40 15: R\$ 15,72  
30: R\$ 16,03 45: R\$ 16,35 60: R\$ 16,68



BALAO 9,0 RED NEON AMARELO 30X1

Código: 38521 Fábrica: HAPPY DAY Unidade: PT/30 F1 F4

UN: R\$ 0,62 AV: R\$ 15,40 15: R\$ 15,72  
30: R\$ 16,03 45: R\$ 16,35 60: R\$ 16,68

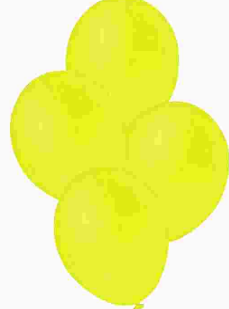

BALAO 9,0 RED NEON CITRUS AMARELO 25X1

Código: 46920 Fábrica: HAPPY DAY Unidade: PT/25 F1 F4

UN: R\$ 0,51 AV: R\$ 15,40 15: R\$ 15,72  
30: R\$ 16,03 45: R\$ 16,35 60: R\$ 16,68

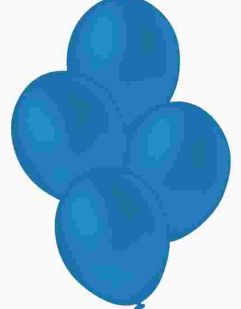

BALAO 9,0 RED NEON CITRUS AZUL 30X1

Código: 38520 Fábrica: HAPPY DAY Unidade: PT/30 F1 F4

UN: R\$ 0,51 AV: R\$ 15,40 15: R\$ 15,72  
30: R\$ 16,03 45: R\$ 16,35 60: R\$ 16,68

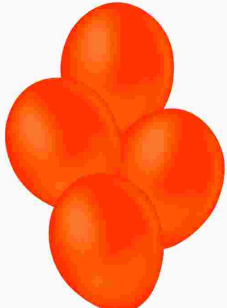

BALAO 9,0 RED NEON CITRUS LARANJA 30X1

Código: 38523 Fábrica: HAPPY DAY Unidade: PT/30 F1 F4

UN: R\$ 0,51 AV: R\$ 15,40 15: R\$ 15,72  
30: R\$ 16,03 45: R\$ 16,35 60: R\$ 16,68



BALAO 9,0 RED NEON CITRUS SORTIDO 30X1

Código: 38528 Fábrica: HAPPY DAY Unidade: PT/30 F1 F4

UN: R\$ 0,51 AV: R\$ 15,40 15: R\$ 15,72  
30: R\$ 16,03 45: R\$ 16,35 60: R\$ 16,68



BALAO 9,0 RED NEON CITRUS VERDE 30X1

Código: 38526 Fábrica: HAPPY DAY Unidade: PT/30 F1 F4

UN: R\$ 0,51 AV: R\$ 15,40 15: R\$ 15,72  
30: R\$ 16,03 45: R\$ 16,35 60: R\$ 16,68

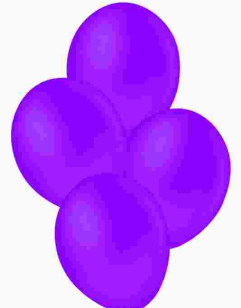

BALAO 9,0 RED NEON LILAS 30X1

Código: 38524 Fábrica: HAPPY DAY Unidade: PT/30 F1 F4

UN: R\$ 0,51 AV: R\$ 15,40 15: R\$ 15,72  
30: R\$ 16,03 45: R\$ 16,35 60: R\$ 16,68

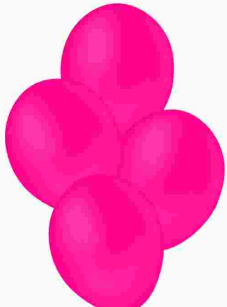

BALAO 9,0 RED NEON ROSA 30X1

Código: 38525 Fábrica: HAPPY DAY Unidade: PT/30 F1 F4

UN: R\$ 0,51 AV: R\$ 15,40 15: R\$ 15,72  
30: R\$ 16,03 45: R\$ 16,35 60: R\$ 16,68

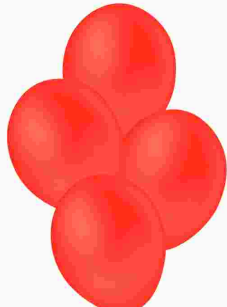

BALAO 9,0 RED NEON VERMELHO 30X1

Código: 38527 Fábrica: HAPPY DAY Unidade: PT/30 F1 F4

UN: R\$ 11,76 AV: R\$ 11,76 15: R\$ 12,01  
30: R\$ 12,25 45: R\$ 12,49 60: R\$ 12,74



BALAO BIG 250 LISO AMARELO

Código: 39197 Fábrica: HAPPY DAY Unidade: PT/1 F1 F4

UN: R\$ 11,76 AV: R\$ 11,76 15: R\$ 12,01  
30: R\$ 12,25 45: R\$ 12,49 60: R\$ 12,74



BALAO BIG 250 LISO AZUL

Código: 39199 Fábrica: HAPPY DAY Unidade: PT/1 F1 F4

UN: R\$ 11,76 AV: R\$ 11,76 15: R\$ 12,01  
30: R\$ 12,25 45: R\$ 12,49 60: R\$ 12,74



BALAO BIG 250 LISO AZULCLARO

Código: 39198 Fábrica: HAPPY DAY Unidade: PT/1 F1 F4

UN: R\$ 11,76 AV: R\$ 11,76 15: R\$ 12,01  
30: R\$ 12,25 45: R\$ 12,49 60: R\$ 12,74



BALAO BIG 250 LISO BEGE

Código: 39200 Fábrica: HAPPY DAY Unidade: PT/1 F1 F4

UN: R\$ 11,76 AV: R\$ 11,76 15: R\$ 12,01  
30: R\$ 12,25 45: R\$ 12,49 60: R\$ 12,74



BALAO BIG 250 LISO BRANCO

Código: 39196 Fábrica: HAPPY DAY Unidade: PT/1 F1 F4

UN: R\$ 11,76 AV: R\$ 11,76 15: R\$ 12,01  
30: R\$ 12,25 45: R\$ 12,49 60: R\$ 12,74



BALAO BIG 250 LISO CRISTAL

Código: 39201 Fábrica: HAPPY DAY Unidade: PT/1 F1 F4

UN: R\$ 11,76 AV: R\$ 11,76 15: R\$ 12,01  
30: R\$ 12,25 45: R\$ 12,49 60: R\$ 12,74



BALAO BIG 250 LISO LARANJA

Código: 39202 Fábrica: HAPPY DAY Unidade: PT/1 F1 F4

UN: R\$ 11,76 AV: R\$ 11,76 15: R\$ 12,01  
30: R\$ 12,25 45: R\$ 12,49 60: R\$ 12,74



BALAO BIG 250 LISO LILAS

Código: 39203 Fábrica: HAPPY DAY Unidade: PT/1 F1 F4

UN: R\$ 11,76 AV: R\$ 11,76 15: R\$ 12,01  
30: R\$ 12,25 45: R\$ 12,49 60: R\$ 12,74

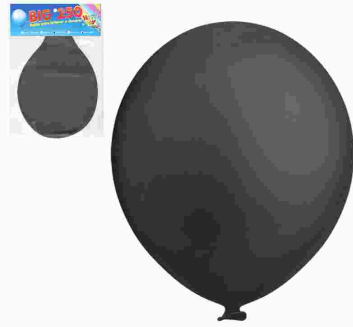

BALAO BIG 250 LISO PRETO

Código: 39204 Fábrica: HAPPY DAY Unidade: PT/1 F1 F4

UN: R\$ 11,76 AV: R\$ 11,76 15: R\$ 12,01  
30: R\$ 12,25 45: R\$ 12,49 60: R\$ 12,74



BALAO BIG 250 LISO ROSA

Código: 39205 Fábrica: HAPPY DAY Unidade: PT/1 F1 F4

UN: R\$ 11,76 AV: R\$ 11,76 15: R\$ 12,01  
30: R\$ 12,25 45: R\$ 12,49 60: R\$ 12,74



BALAO BIG 250 LISO ROSA PINK

Código: 39207 Fábrica: HAPPY DAY Unidade: PT/1 F1 F4

UN: R\$ 11,76 AV: R\$ 11,76 15: R\$ 12,01  
30: R\$ 12,25 45: R\$ 12,49 60: R\$ 12,74



BALAO BIG 250 LISO VERDE

Código: 39206 Fábrica: HAPPY DAY Unidade: PT/1 F1 F4

UN: R\$ 11,76 AV: R\$ 11,76 15: R\$ 12,01  
30: R\$ 12,25 45: R\$ 12,49 60: R\$ 12,74



BALAO BIG 250 LISO VERMELHO

Código: 39208 Fábrica: HAPPY DAY Unidade: PT/1 F1 F4

UN: R\$ 2,03 AV: R\$ 10,17 15: R\$ 10,38  
30: R\$ 10,59 45: R\$ 10,80 60: R\$ 11,02



BALAO BUBLE 24 POLEGADAS 5X1

Código: 50334 Fábrica: BUBBLE Unidade: PT/5 F1 F4

UN: R\$ 2,05 AV: R\$ 20,53 15: R\$ 20,96  
30: R\$ 21,38 45: R\$ 21,81 60: R\$ 22,24



BALAO BUQUE CHA DE REVELACAO 10X1

Código: 37926 Fábrica: HAPPY DAY Unidade: PT/10 F1 F4

UN: R\$ 2,05 AV: R\$ 20,53 15: R\$ 20,96  
30: R\$ 21,38 45: R\$ 21,81 60: R\$ 22,24



BALAO BUQUE CORACAO 10X1

Código: 37936 Fábrica: HAPPY DAY Unidade: PT/10 F1 F4

UN: R\$ 2,05 AV: R\$ 20,53 15: R\$ 20,96  
30: R\$ 21,38 45: R\$ 21,81 60: R\$ 22,24



BALAO BUQUE FAZENDINHA 10X1

Código: 37927 Fábrica: HAPPY DAY Unidade: PT/10 F1 F4

UN: R\$ 19,99 AV: R\$ 19,99 15: R\$ 19,99  
30: R\$ 19,99 45: R\$ 19,99 60: R\$ 19,99



BALAO BUQUE FESTA KIT 14UN

Código: 48285 Fábrica: SOLIDER Unidade: PT/1 F1 F4

UN: R\$ 2,05 AV: R\$ 20,53 15: R\$ 20,96  
30: R\$ 21,38 45: R\$ 21,81 60: R\$ 22,24



BALAO BUQUE FIRE 10X1

Código: 37929 Fábrica: HAPPY DAY Unidade: PT/10 F1 F4

UN: R\$ 2,05 AV: R\$ 20,53 15: R\$ 20,96  
30: R\$ 21,38 45: R\$ 21,81 60: R\$ 22,24



BALAO BUQUE FUNDO DO MAR 10X1

Código: 37930 Fábrica: HAPPY DAY Unidade: PT/10 F1 F4

UN: R\$ 2,05 AV: R\$ 20,53 15: R\$ 20,96  
30: R\$ 21,38 45: R\$ 21,81 60: R\$ 22,24



BALAO BUQUE HALLOWEEN 10X1

Código: 37931 Fábrica: HAPPY DAY Unidade: PT/10 F1 F4

UN: R\$ 2,05 AV: R\$ 20,53 15: R\$ 20,96  
30: R\$ 21,38 45: R\$ 21,81 60: R\$ 22,24



BALAO BUQUE MEU PAPAÍ 10X1

Código: 37916 Fábrica: HAPPY DAY Unidade: PT/10 F1 F4

UN: R\$ 2,05 AV: R\$ 20,53 15: R\$ 20,96  
30: R\$ 21,38 45: R\$ 21,81 60: R\$ 22,24



BALAO BUQUE NATAL ALUMINIO 10X1

Código: Fábrika: Unidade:  
**37932** HAPPY DAY PT/10  
F1 F4

UN: R\$ 2,05 AV: R\$ 20,53 15: R\$ 20,96  
30: R\$ 21,38 45: R\$ 21,81 60: R\$ 22,24



BALAO BUQUE NOVEMBRO AZUL 10X1

Código: Fábrika: Unidade:  
**37934** HAPPY DAY PT/10  
F1 F4

UN: R\$ 2,05 AV: R\$ 20,53 15: R\$ 20,96  
30: R\$ 21,38 45: R\$ 21,81 60: R\$ 22,24



BALAO BUQUE SUPER HEROIS 10X1

Código: Fábrika: Unidade:  
**37922** HAPPY DAY PT/10  
F1 F4

UN: R\$ 2,05 AV: R\$ 20,53 15: R\$ 20,96  
30: R\$ 21,38 45: R\$ 21,81 60: R\$ 22,24



BALAO BUQUE UNICORNIO 10X1

Código: Fábrika: Unidade:  
**37918** HAPPY DAY PT/10  
F1 F4

UN: R\$ 0,29 AV: R\$ 14,37 15: R\$ 14,67  
30: R\$ 14,96 45: R\$ 15,26 60: R\$ 15,57



BALAO CANUDO/PALITO LISO 260 AMARELO 50X1

Código: Fábrika: Unidade:  
**50692** SAOROQUE PT/50  
F1 F4

UN: R\$ 0,29 AV: R\$ 14,37 15: R\$ 14,67  
30: R\$ 14,96 45: R\$ 15,26 60: R\$ 15,57

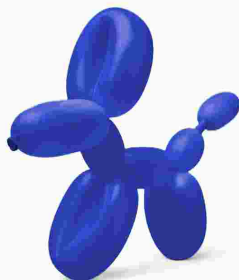

BALAO CANUDO/PALITO LISO 260 AZUL 50X1

Código: Fábrika: Unidade:  
**50695** SAOROQUE PT/50  
F1 F4

UN: R\$ 0,29 AV: R\$ 14,37 15: R\$ 14,67  
30: R\$ 14,96 45: R\$ 15,26 60: R\$ 15,57

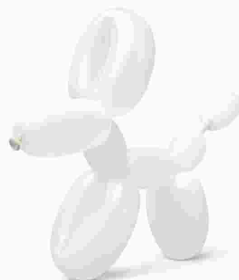

BALAO CANUDO/PALITO LISO 260 BRANCO 50X1

Código: Fábrika: Unidade:  
**50690** SAOROQUE PT/50  
F1 F4

UN: R\$ 0,29 AV: R\$ 14,37 15: R\$ 14,67  
30: R\$ 14,96 45: R\$ 15,26 60: R\$ 15,57

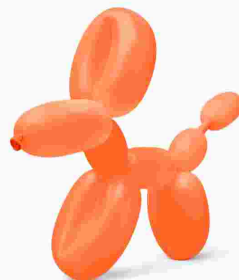

BALAO CANUDO/PALITO LISO 260 LARANJ 50X1

Código: Fábrika: Unidade:  
**50696** SAOROQUE PT/50  
F1 F4

UN: R\$ 0,29 AV: R\$ 14,37 15: R\$ 14,67  
30: R\$ 14,96 45: R\$ 15,26 60: R\$ 15,57



BALAO CANUDO/PALITO LISO 260 LARANJ 50X1

Código: Fábrika: Unidade:  
**50694** SAOROQUE PT/50  
F1 F4

UN: R\$ 0,29 AV: R\$ 14,37 15: R\$ 14,67  
30: R\$ 14,96 45: R\$ 15,26 60: R\$ 15,57



BALAO CANUDO/PALITO LISO 260 SORT 50X1

Código: Fábrika: Unidade:  
**41846** HAPPY/SAOROQ PT/50  
F1 F4

UN: R\$ 0,29 AV: R\$ 14,37 15: R\$ 14,67  
30: R\$ 14,96 45: R\$ 15,26 60: R\$ 15,57



BALAO CANUDO/PALITO LISO 260 VERDE 50X1

Código: Fábrika: Unidade:  
**50691** SAOROQUE PT/50  
F1 F4

UN: R\$ 0,29 AV: R\$ 14,37 15: R\$ 14,67  
30: R\$ 14,96 45: R\$ 15,26 60: R\$ 15,57

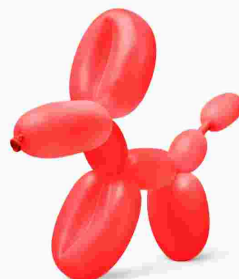

BALAO CANUDO/PALITO LISO 260 VERMEL 50X1

Código: Fábrika: Unidade:  
**50693** SAOROQUE PT/50  
F1 F4

UN: R\$ 4,10 AV: R\$ 4,10 15: R\$ 4,18  
30: R\$ 4,27 45: R\$ 4,35 60: R\$ 4,44



BALAO PLAST METALIA 0 ESTRELA AZUL 40CM

Código: Fábrika: Unidade:  
**40738** FEST WAY UN/1  
F1 F4

UN: R\$ 4,68 AV: R\$ 4,68 15: R\$ 4,78  
30: R\$ 4,88 45: R\$ 4,97 60: R\$ 5,07



BALAO PLAST METALIZ CORACAO ROSA 45CM

Código: Fábrika: Unidade:  
**51035** FEST WAY UN/1  
F1 F4

UN: R\$ 8,21 AV: R\$ 8,21 15: R\$ 8,38  
30: R\$ 8,55 45: R\$ 8,72 60: R\$ 8,89



BALAO PLAST METALIZ OURO LETRA A 75CM

Código: Fábrika: Unidade:  
**47543** FEST WAY UN/1  
F1 F4

UN: R\$ 8,21 AV: R\$ 8,21 15: R\$ 8,38  
30: R\$ 8,55 45: R\$ 8,72 60: R\$ 8,89



BALAO PLAST METALIZ OURO LETRA B 75CM

Código: Fábrika: Unidade:  
**47544** FEST WAY UN/1  
F1 F4

UN: R\$ 8,21 AV: R\$ 8,21 15: R\$ 8,38  
30: R\$ 8,55 45: R\$ 8,72 60: R\$ 8,89



BALAO PLAST METALIZ OURO LETRA C 75CM

Código: 47545 Fábrica: FEST WAY Unidade: UN/1 F1 F4

UN: R\$ 8,21 AV: R\$ 8,21 15: R\$ 8,38  
30: R\$ 8,55 45: R\$ 8,72 60: R\$ 8,89



BALAO PLAST METALIZ OURO LETRA D 75CM

Código: 47546 Fábrica: FEST WAY Unidade: UN/1 F1 F4

UN: R\$ 8,21 AV: R\$ 8,21 15: R\$ 8,38  
30: R\$ 8,55 45: R\$ 8,72 60: R\$ 8,89



BALAO PLAST METALIZ OURO LETRA E 75CM

Código: 47547 Fábrica: FEST WAY Unidade: UN/1 F1 F4

UN: R\$ 8,21 AV: R\$ 8,21 15: R\$ 8,38  
30: R\$ 8,55 45: R\$ 8,72 60: R\$ 8,89



BALAO PLAST METALIZ OURO LETRA F 75CM

Código: 47548 Fábrica: FEST WAY Unidade: UN/1 F1 F4

UN: R\$ 8,21 AV: R\$ 8,21 15: R\$ 8,38  
30: R\$ 8,55 45: R\$ 8,72 60: R\$ 8,89



BALAO PLAST METALIZ OURO LETRA G 75CM

Código: 47549 Fábrica: FEST WAY Unidade: UN/1 F1 F4

UN: R\$ 8,21 AV: R\$ 8,21 15: R\$ 8,38  
30: R\$ 8,55 45: R\$ 8,72 60: R\$ 8,89



BALAO PLAST METALIZ OURO LETRA H 75CM

Código: 47550 Fábrica: FEST WAY Unidade: UN/1 F1 F4

UN: R\$ 8,21 AV: R\$ 8,21 15: R\$ 8,38  
30: R\$ 8,55 45: R\$ 8,72 60: R\$ 8,89



BALAO PLAST METALIZ OURO LETRA I 75CM

Código: 47551 Fábrica: FEST WAY Unidade: UN/1 F1 F4

UN: R\$ 8,21 AV: R\$ 8,21 15: R\$ 8,38  
30: R\$ 8,55 45: R\$ 8,72 60: R\$ 8,89



BALAO PLAST METALIZ OURO LETRA J 75CM

Código: 47552 Fábrica: FEST WAY Unidade: UN/1 F1 F4

UN: R\$ 8,21 AV: R\$ 8,21 15: R\$ 8,38  
30: R\$ 8,55 45: R\$ 8,72 60: R\$ 8,89



BALAO PLAST METALIZ OURO LETRA K 75CM

Código: 47553 Fábrica: FEST WAY Unidade: UN/1 F1 F4

UN: R\$ 8,21 AV: R\$ 8,21 15: R\$ 8,38  
30: R\$ 8,55 45: R\$ 8,72 60: R\$ 8,89



BALAO PLAST METALIZ OURO LETRA L 75CM

Código: 47554 Fábrica: FEST WAY Unidade: UN/1 F1 F4

UN: R\$ 8,21 AV: R\$ 8,21 15: R\$ 8,38  
30: R\$ 8,55 45: R\$ 8,72 60: R\$ 8,89



BALAO PLAST METALIZ OURO LETRA M 75CM

Código: 47555 Fábrica: FEST WAY Unidade: UN/1 F1 F4

UN: R\$ 8,21 AV: R\$ 8,21 15: R\$ 8,38  
30: R\$ 8,55 45: R\$ 8,72 60: R\$ 8,89



BALAO PLAST METALIZ OURO LETRA N 75CM

Código: 47556 Fábrica: FEST WAY Unidade: UN/1 F1 F4

UN: R\$ 8,21 AV: R\$ 8,21 15: R\$ 8,38  
30: R\$ 8,55 45: R\$ 8,72 60: R\$ 8,89



BALAO PLAST METALIZ OURO LETRA O 75CM

Código: 47557 Fábrica: FEST WAY Unidade: UN/1 F1 F4

UN: R\$ 8,21 AV: R\$ 8,21 15: R\$ 8,38  
30: R\$ 8,55 45: R\$ 8,72 60: R\$ 8,89



BALAO PLAST METALIZ OURO LETRA P 75CM

Código: 47558 Fábrica: FEST WAY Unidade: UN/1 F1 F4

UN: R\$ 8,21 AV: R\$ 8,21 15: R\$ 8,38  
30: R\$ 8,55 45: R\$ 8,72 60: R\$ 8,89



BALAO PLAST METALIZ OURO LETRA Q 75CM

Código: 47559 Fábrica: FEST WAY Unidade: UN/1 F1 F4

UN: R\$ 8,21 AV: R\$ 8,21 15: R\$ 8,38  
30: R\$ 8,55 45: R\$ 8,72 60: R\$ 8,89



BALAO PLAST METALIZ OURO LETRA R 75CM

Código: 47560 Fábrica: FEST WAY Unidade: UN/1 F1 F4

UN: R\$ 8,21 AV: R\$ 8,21 15: R\$ 8,38  
30: R\$ 8,55 45: R\$ 8,72 60: R\$ 8,89



BALAO PLAST METALIZ OURO LETRA S 75CM

Código: 47561 Fábrica: FEST WAY Unidade: UN/1 F1 F4

UN: R\$ 8,21 AV: R\$ 8,21 15: R\$ 8,38  
30: R\$ 8,55 45: R\$ 8,72 60: R\$ 8,89



BALAO PLAST METALIZ OURO LETRA T 75CM

Código: 47562 Fábrica: FEST WAY Unidade: UN/1 F1 F4

UN: R\$ 8,21 AV: R\$ 8,21 15: R\$ 8,38  
30: R\$ 8,55 45: R\$ 8,72 60: R\$ 8,89



BALAO PLAST METALIZ OURO LETRA U 75CM

Código: 47563 Fábrica: FEST WAY Unidade: UN/1 F1 F4

UN: R\$ 8,21 AV: R\$ 8,21 15: R\$ 8,38  
30: R\$ 8,55 45: R\$ 8,72 60: R\$ 8,89



BALAO PLAST METALIZ OURO LETRA V 75CM

Código: 47564 Fábrica: FEST WAY Unidade: UN/1 F1 F4

UN: R\$ 8,21 AV: R\$ 8,21 15: R\$ 8,38  
30: R\$ 8,55 45: R\$ 8,72 60: R\$ 8,89



BALAO PLAST METALIZ OURO LETRA W 75CM

Código: 47565 Fábrica: FEST WAY Unidade: UN/1 F1 F4

UN: R\$ 8,21 AV: R\$ 8,21 15: R\$ 8,38  
30: R\$ 8,55 45: R\$ 8,72 60: R\$ 8,89



BALAO PLAST METALIZ OURO LETRA X 75CM

Código: 47566 Fábrica: FEST WAY Unidade: UN/1 F1 F4

UN: R\$ 8,21 AV: R\$ 8,21 15: R\$ 8,38  
30: R\$ 8,55 45: R\$ 8,72 60: R\$ 8,89



BALAO PLAST METALIZ OURO LETRA Y 75CM

Código: 47567 Fábrica: FEST WAY Unidade: UN/1 F1 F4

UN: R\$ 8,21 AV: R\$ 8,21 15: R\$ 8,38  
30: R\$ 8,55 45: R\$ 8,72 60: R\$ 8,89



BALAO PLAST METALIZ OURO LETRA Z 75CM

Código: 47568 Fábrica: FEST WAY Unidade: UN/1 F1 F4

UN: R\$ 8,21 AV: R\$ 8,21 15: R\$ 8,38  
30: R\$ 8,55 45: R\$ 8,72 60: R\$ 8,89

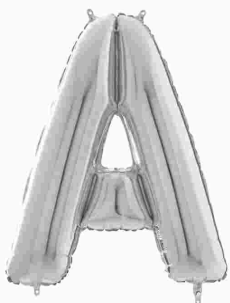

BALAO PLAST METALIZ PRATA LETRA A 75CM

Código: 47517 Fábrica: FEST WAY Unidade: UN/1 F1 F4

UN: R\$ 8,21 AV: R\$ 8,21 15: R\$ 8,38  
30: R\$ 8,55 45: R\$ 8,72 60: R\$ 8,89



BALAO PLAST METALIZ PRATA LETRA B 75CM

Código: 47518 Fábrica: FEST WAY Unidade: UN/1 F1 F4

UN: R\$ 8,21 AV: R\$ 8,21 15: R\$ 8,38  
30: R\$ 8,55 45: R\$ 8,72 60: R\$ 8,89

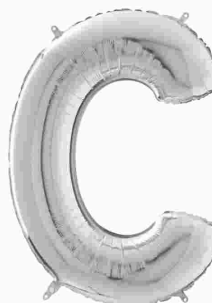

BALAO PLAST METALIZ PRATA LETRA C 75CM

Código: 47519 Fábrica: FEST WAY Unidade: UN/1 F1 F4

UN: R\$ 8,21 AV: R\$ 8,21 15: R\$ 8,38  
30: R\$ 8,55 45: R\$ 8,72 60: R\$ 8,89



BALAO PLAST METALIZ PRATA LETRA D 75CM

Código: 47520 Fábrica: FEST WAY Unidade: UN/1 F1 F4

UN: R\$ 8,21 AV: R\$ 8,21 15: R\$ 8,38  
30: R\$ 8,55 45: R\$ 8,72 60: R\$ 8,89



BALAO PLAST METALIZ PRATA LETRA E 75CM

Código: 47521 Fábrica: FEST WAY Unidade: UN/1 F1 F4

UN: R\$ 8,21 AV: R\$ 8,21 15: R\$ 8,38  
30: R\$ 8,55 45: R\$ 8,72 60: R\$ 8,89

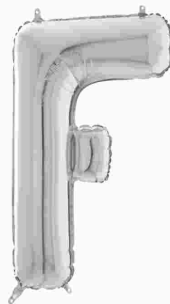

BALAO PLAST METALIZ PRATA LETRA F 75CM

Código: 47522 Fábrica: FEST WAY Unidade: UN/1 F1 F4

UN: R\$ 8,21 AV: R\$ 8,21 15: R\$ 8,38  
30: R\$ 8,55 45: R\$ 8,72 60: R\$ 8,89

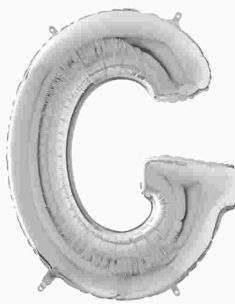

BALAO PLAST METALIZ PRATA LETRA G 75CM

Código: 47523 Fábrica: FEST WAY Unidade: UN/1 F1 F4

UN: R\$ 8,21 AV: R\$ 8,21 15: R\$ 8,38  
30: R\$ 8,55 45: R\$ 8,72 60: R\$ 8,89

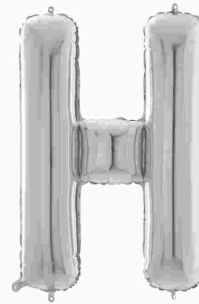

BALAO PLAST METALIZ PRATA LETRA H 75CM

Código: 47524 Fábrica: FEST WAY Unidade: UN/1 F1 F4

UN: R\$ 8,21 AV: R\$ 8,21 15: R\$ 8,38  
30: R\$ 8,55 45: R\$ 8,72 60: R\$ 8,89



BALAO PLAST METALIZ PRATA LETRA I 75CM

Código: Fábrica: Unidade:  
**47525** FEST WAY UN/1  
F1 F4

UN: R\$ 8,21 AV: R\$ 8,21 15: R\$ 8,38  
30: R\$ 8,55 45: R\$ 8,72 60: R\$ 8,89

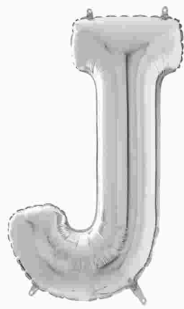

BALAO PLAST METALIZ PRATA LETRA J 75CM

Código: Fábrica: Unidade:  
**47526** FEST WAY UN/1  
F1 F4

UN: R\$ 8,21 AV: R\$ 8,21 15: R\$ 8,38  
30: R\$ 8,55 45: R\$ 8,72 60: R\$ 8,89



BALAO PLAST METALIZ PRATA LETRA K 75CM

Código: Fábrica: Unidade:  
**47527** FEST WAY UN/1  
F1 F4

UN: R\$ 8,21 AV: R\$ 8,21 15: R\$ 8,38  
30: R\$ 8,55 45: R\$ 8,72 60: R\$ 8,89



BALAO PLAST METALIZ PRATA LETRA L 75CM

Código: Fábrica: Unidade:  
**47528** FEST WAY UN/1  
F1 F4

UN: R\$ 8,21 AV: R\$ 8,21 15: R\$ 8,38  
30: R\$ 8,55 45: R\$ 8,72 60: R\$ 8,89

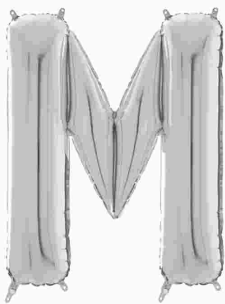

BALAO PLAST METALIZ PRATA LETRA M 75CM

Código: Fábrica: Unidade:  
**47529** FEST WAY UN/1  
F1 F4

UN: R\$ 8,21 AV: R\$ 8,21 15: R\$ 8,38  
30: R\$ 8,55 45: R\$ 8,72 60: R\$ 8,89

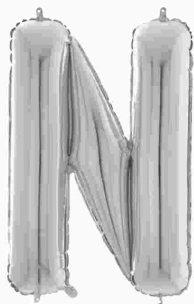

BALAO PLAST METALIZ PRATA LETRA N 75CM

Código: Fábrica: Unidade:  
**47530** FEST WAY UN/1  
F1 F4

UN: R\$ 8,21 AV: R\$ 8,21 15: R\$ 8,38  
30: R\$ 8,55 45: R\$ 8,72 60: R\$ 8,89

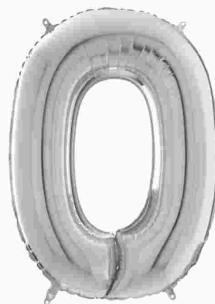

BALAO PLAST METALIZ PRATA LETRA O 75CM

Código: Fábrica: Unidade:  
**47531** FEST WAY UN/1  
F1 F4

UN: R\$ 8,21 AV: R\$ 8,21 15: R\$ 8,38  
30: R\$ 8,55 45: R\$ 8,72 60: R\$ 8,89



BALAO PLAST METALIZ PRATA LETRA P 75CM

Código: Fábrica: Unidade:  
**47532** FEST WAY UN/1  
F1 F4

UN: R\$ 8,21 AV: R\$ 8,21 15: R\$ 8,38  
30: R\$ 8,55 45: R\$ 8,72 60: R\$ 8,89

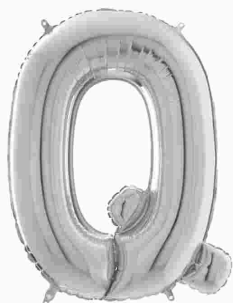

BALAO PLAST METALIZ PRATA LETRA Q 75CM

Código: Fábrica: Unidade:  
**47533** FEST WAY UN/1  
F1 F4

UN: R\$ 8,21 AV: R\$ 8,21 15: R\$ 8,38  
30: R\$ 8,55 45: R\$ 8,72 60: R\$ 8,89

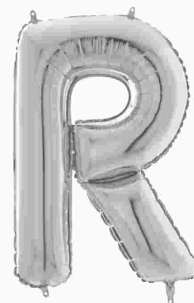

BALAO PLAST METALIZ PRATA LETRA R 75CM

Código: Fábrica: Unidade:  
**47534** FEST WAY UN/1  
F1 F4

UN: R\$ 8,21 AV: R\$ 8,21 15: R\$ 8,38  
30: R\$ 8,55 45: R\$ 8,72 60: R\$ 8,89



BALAO PLAST METALIZ PRATA LETRA S 75CM

Código: Fábrica: Unidade:  
**47535** FEST WAY UN/1  
F1 F4

UN: R\$ 8,21 AV: R\$ 8,21 15: R\$ 8,38  
30: R\$ 8,55 45: R\$ 8,72 60: R\$ 8,89



BALAO PLAST METALIZ PRATA LETRA T 75CM

Código: Fábrica: Unidade:  
**47536** FEST WAY UN/1  
F1 F4

UN: R\$ 8,21 AV: R\$ 8,21 15: R\$ 8,38  
30: R\$ 8,55 45: R\$ 8,72 60: R\$ 8,89

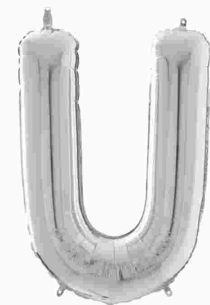

BALAO PLAST METALIZ PRATA LETRA U 75CM

Código: Fábrica: Unidade:  
**47537** FEST WAY UN/1  
F1 F4

UN: R\$ 8,21 AV: R\$ 8,21 15: R\$ 8,38  
30: R\$ 8,55 45: R\$ 8,72 60: R\$ 8,89

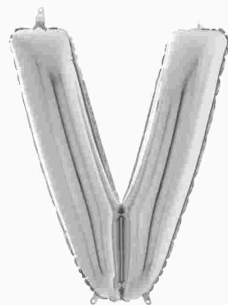

BALAO PLAST METALIZ PRATA LETRA V 75CM

Código: Fábrica: Unidade:  
**47538** FEST WAY UN/1  
F1 F4

UN: R\$ 8,21 AV: R\$ 8,21 15: R\$ 8,38  
30: R\$ 8,55 45: R\$ 8,72 60: R\$ 8,89

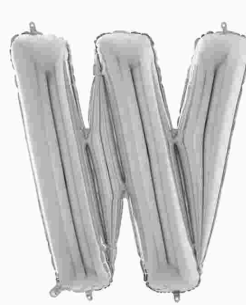

BALAO PLAST METALIZ PRATA LETRA W 75CM

Código: Fábrica: Unidade:  
**47539** FEST WAY UN/1  
F1 F4

UN: R\$ 8,21 AV: R\$ 8,21 15: R\$ 8,38  
30: R\$ 8,55 45: R\$ 8,72 60: R\$ 8,89

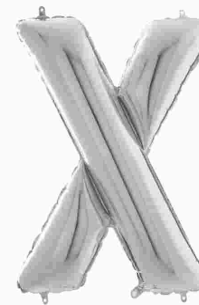

BALAO PLAST METALIZ PRATA LETRA X 75CM

Código: Fábrica: Unidade:  
**47540** FEST WAY UN/1  
F1 F4

UN: R\$ 8,21 AV: R\$ 8,21 15: R\$ 8,38  
30: R\$ 8,55 45: R\$ 8,72 60: R\$ 8,89



BALAO PLAST METALIZ PRATA LETRA Y 75CM  
Código: 47541 Fábrica: FEST WAY Unidade: UN/1 F1 F4

UN: R\$ 8,21 AV: R\$ 8,21 15: R\$ 8,38  
30: R\$ 8,55 45: R\$ 8,72 60: R\$ 8,89

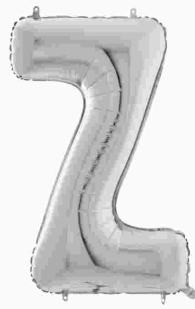

BALAO PLAST METALIZ PRATA LETRA Z 75CM  
Código: 47542 Fábrica: FEST WAY Unidade: UN/1 F1 F4

UN: R\$ 4,10 AV: R\$ 4,10 15: R\$ 4,18  
30: R\$ 4,27 45: R\$ 4,35 60: R\$ 4,44



BALAO PLAST METALIZ 0 LISO PRATA 40CM  
Código: 40763 Fábrica: FEST WAY Unidade: UN/1 F1 F4

UN: R\$ 4,10 AV: R\$ 4,10 15: R\$ 4,18  
30: R\$ 4,27 45: R\$ 4,35 60: R\$ 4,44



BALAO PLAST METALIZ 1 AZUL ESTRELA 40CM  
Código: 40764 Fábrica: FEST WAY Unidade: UN/1 F1 F4

UN: R\$ 4,10 AV: R\$ 4,10 15: R\$ 4,18  
30: R\$ 4,27 45: R\$ 4,35 60: R\$ 4,44



BALAO PLAST METALIZ 1 LISO PRATA 40CM  
Código: 40766 Fábrica: FEST WAY Unidade: UN/1 F1 F4

UN: R\$ 4,10 AV: R\$ 4,10 15: R\$ 4,18  
30: R\$ 4,27 45: R\$ 4,35 60: R\$ 4,44



BALAO PLAST METALIZ 2 CORACAO ROSA 40CM  
Código: 41585 Fábrica: FEST WAY Unidade: UN/1 F1 F4

UN: R\$ 4,10 AV: R\$ 4,10 15: R\$ 4,18  
30: R\$ 4,27 45: R\$ 4,35 60: R\$ 4,44



BALAO PLAST METALIZ 2 ESTRELA AZUL 40CM  
Código: 41586 Fábrica: FEST WAY Unidade: UN/1 F1 F4

UN: R\$ 4,10 AV: R\$ 4,10 15: R\$ 4,18  
30: R\$ 4,27 45: R\$ 4,35 60: R\$ 4,44



BALAO PLAST METALIZ 3 CORACAO ROSA 40CM  
Código: 41570 Fábrica: FEST WAY Unidade: UN/1 F1 F4

UN: R\$ 4,10 AV: R\$ 4,10 15: R\$ 4,18  
30: R\$ 4,27 45: R\$ 4,35 60: R\$ 4,44



BALAO PLAST METALIZ 3 ESTRELA AZUL 44CM  
Código: 40767 Fábrica: FEST WAY Unidade: UN/1 F1 F4

UN: R\$ 4,10 AV: R\$ 4,10 15: R\$ 4,18  
30: R\$ 4,27 45: R\$ 4,35 60: R\$ 4,44



BALAO PLAST METALIZ 3 LISO DOURADO 40CM  
Código: 41596 Fábrica: FEST WAY Unidade: UN/1 F1 F4

UN: R\$ 4,10 AV: R\$ 4,10 15: R\$ 4,18  
30: R\$ 4,27 45: R\$ 4,35 60: R\$ 4,44



BALAO PLAST METALIZ 4 ESTRELA AZUL 44CM  
Código: 41571 Fábrica: FEST WAY Unidade: UN/1 F1 F4

UN: R\$ 4,10 AV: R\$ 4,10 15: R\$ 4,18  
30: R\$ 4,27 45: R\$ 4,35 60: R\$ 4,44



BALAO PLAST METALIZ 4 LISO PRATA 40CM  
Código: 41573 Fábrica: FEST WAY Unidade: UN/1 F1 F4

UN: R\$ 4,10 AV: R\$ 4,10 15: R\$ 4,18  
30: R\$ 4,27 45: R\$ 4,35 60: R\$ 4,44



BALAO PLAST METALIZ 5 CORACAO ROSA 40CM  
Código: 41576 Fábrica: FEST WAY Unidade: UN/1 F1 F4

UN: R\$ 4,10 AV: R\$ 4,10 15: R\$ 4,18  
30: R\$ 4,27 45: R\$ 4,35 60: R\$ 4,44



BALAO PLAST METALIZ 5 ESTRELA AZUL 40CM  
Código: 41577 Fábrica: FEST WAY Unidade: UN/1 F1 F4

UN: R\$ 4,10 AV: R\$ 4,10 15: R\$ 4,18  
30: R\$ 4,27 45: R\$ 4,35 60: R\$ 4,44



BALAO PLAST METALIZ 5 LISO DOURADO 40CM  
Código: 41575 Fábrica: FEST WAY Unidade: UN/1 F1 F4

UN: R\$ 4,10 AV: R\$ 4,10 15: R\$ 4,18  
30: R\$ 4,27 45: R\$ 4,35 60: R\$ 4,44



BALAO PLAST METALIZ 5 LISO PRATA 40CM  
Código: 41574 Fábrica: FEST WAY Unidade: UN/1 F1 F4

UN: R\$ 4,10 AV: R\$ 4,10 15: R\$ 4,18  
30: R\$ 4,27 45: R\$ 4,35 60: R\$ 4,44



BALAO PLAST METALIZ 6 CORACAO ROSA 40CM  
Código: 41579 Fábrica: FEST WAY Unidade: UN/1  
F1 F4

UN: R\$ 4,10 AV: R\$ 4,10 15: R\$ 4,18  
30: R\$ 4,27 45: R\$ 4,35 60: R\$ 4,44



BALAO PLAST METALIZ 6 ESTRELA AZUL 40CM  
Código: 41578 Fábrica: FEST WAY Unidade: UN/1  
F1 F4

UN: R\$ 4,10 AV: R\$ 4,10 15: R\$ 4,18  
30: R\$ 4,27 45: R\$ 4,35 60: R\$ 4,44



BALAO PLAST METALIZ 6 LISO DOURADO 40CM  
Código: 41595 Fábrica: FEST WAY Unidade: UN/1  
F1 F4

UN: R\$ 4,10 AV: R\$ 4,10 15: R\$ 4,18  
30: R\$ 4,27 45: R\$ 4,35 60: R\$ 4,44



BALAO PLAST METALIZ 6 LISO PRATA 40CM  
Código: 41580 Fábrica: FEST WAY Unidade: UN/1  
F1 F4

UN: R\$ 4,10 AV: R\$ 4,10 15: R\$ 4,18  
30: R\$ 4,27 45: R\$ 4,35 60: R\$ 4,44



BALAO PLAST METALIZ 7 CORACAO ROSA 40CM  
Código: 41584 Fábrica: FEST WAY Unidade: UN/1  
F1 F4

UN: R\$ 4,10 AV: R\$ 4,10 15: R\$ 4,18  
30: R\$ 4,27 45: R\$ 4,35 60: R\$ 4,44



BALAO PLAST METALIZ 7 ESTRELA AZUL 40CM  
Código: 41583 Fábrica: FEST WAY Unidade: UN/1  
F1 F4

UN: R\$ 4,10 AV: R\$ 4,10 15: R\$ 4,18  
30: R\$ 4,27 45: R\$ 4,35 60: R\$ 4,44



BALAO PLAST METALIZ 7 LISO DOURADO 40CM  
Código: 41582 Fábrica: FEST WAY Unidade: UN/1  
F1 F4

UN: R\$ 4,10 AV: R\$ 4,10 15: R\$ 4,18  
30: R\$ 4,27 45: R\$ 4,35 60: R\$ 4,44



BALAO PLAST METALIZ 7 LISO PRATA 40CM  
Código: 41581 Fábrica: FEST WAY Unidade: UN/1  
F1 F4

UN: R\$ 4,10 AV: R\$ 4,10 15: R\$ 4,18  
30: R\$ 4,27 45: R\$ 4,35 60: R\$ 4,44



BALAO PLAST METALIZ 8 CORACAO ROSA 40CM  
Código: 41594 Fábrica: FEST WAY Unidade: UN/1  
F1 F4

UN: R\$ 4,10 AV: R\$ 4,10 15: R\$ 4,18  
30: R\$ 4,27 45: R\$ 4,35 60: R\$ 4,44



BALAO PLAST METALIZ 8 ESTRELA AZUL 40CM  
Código: 41592 Fábrica: FEST WAY Unidade: UN/1  
F1 F4

UN: R\$ 4,10 AV: R\$ 4,10 15: R\$ 4,18  
30: R\$ 4,27 45: R\$ 4,35 60: R\$ 4,44



BALAO PLAST METALIZ 8 LISO DOURADO 40CM  
Código: 41593 Fábrica: FEST WAY Unidade: UN/1  
F1 F4

UN: R\$ 4,10 AV: R\$ 4,10 15: R\$ 4,18  
30: R\$ 4,27 45: R\$ 4,35 60: R\$ 4,44



BALAO PLAST METALIZ 9 CORACAO ROSA 40CM  
Código: 41590 Fábrica: FEST WAY Unidade: UN/1  
F1 F4

UN: R\$ 4,10 AV: R\$ 4,10 15: R\$ 4,18  
30: R\$ 4,27 45: R\$ 4,35 60: R\$ 4,44



BALAO PLAST METALIZ 9 ESTRELA AZUL 40CM  
Código: 41591 Fábrica: FEST WAY Unidade: UN/1  
F1 F4

UN: R\$ 4,10 AV: R\$ 4,10 15: R\$ 4,18  
30: R\$ 4,27 45: R\$ 4,35 60: R\$ 4,44



BALAO PLAST METALIZ 9 LISO DOURADO 40CM  
Código: 41589 Fábrica: FEST WAY Unidade: UN/1  
F1 F4

UN: R\$ 4,10 AV: R\$ 4,10 15: R\$ 4,18  
30: R\$ 4,27 45: R\$ 4,35 60: R\$ 4,44



BALAO PLAST METALIZ 9 LISO PRATA 40CM  
Código: 41588 Fábrica: FEST WAY Unidade: UN/1  
F1 F4

UN: R\$ 4,10 AV: R\$ 4,10 15: R\$ 4,18  
30: R\$ 4,27 45: R\$ 4,35 60: R\$ 4,44



BALAO PLAST METALIZA 0 CORACAO ROSA 40CM  
Código: 40762 Fábrica: FEST WAY Unidade: UN/1  
F1 F4

UN: R\$ 4,23 AV: R\$ 4,23 15: R\$ 4,32  
30: R\$ 4,41 45: R\$ 4,49 60: R\$ 4,58



BALAO PLAST P/FESTA BOLA 42X46CM 263  
Código: Fábrica: Unidade:  
**34784** AGUIA BRANCA PT/1  
F1 F4

UN: R\$ 16,61 AV: R\$ 16,61 15: R\$ 16,96  
30: R\$ 17,30 45: R\$ 17,64 60: R\$ 17,99



BALAO PLAST P/FESTA DINOSSAUROS 466 5X1  
Código: Fábrica: Unidade:  
**37325** AGUIA BRANCA UN/1  
F1 F4

UN: R\$ 25,17 AV: R\$ 25,17 15: R\$ 25,69  
30: R\$ 26,20 45: R\$ 26,73 60: R\$ 27,26



BALAO PLAST P/FESTA FELIZ ANIVERSAR 655  
Código: Fábrica: Unidade:  
**37327** AGUIA BRANCA UN/1  
F1 F4

UN: R\$ 4,37 AV: R\$ 261,94 15: R\$ 267,39  
30: R\$ 272,74 45: R\$ 278,20 60: R\$ 283,76



BALAO PLAST P/FESTA LETRAS DOUR/PRA 30X1  
Código: Fábrica: Unidade:  
**37346** AGUIA BRANCA UN/60  
F1 F4

UN: R\$ 7,29 AV: R\$ 7,29 15: R\$ 7,45  
30: R\$ 7,59 45: R\$ 7,75 60: R\$ 7,90



BALAO PLAST P/FESTA UNICORNIO 461  
Código: Fábrica: Unidade:  
**37328** AGUIA BRANCA UN/1  
F1 F4

UN: R\$ 1,45 AV: R\$ 17,45 15: R\$ 17,82  
30: R\$ 18,17 45: R\$ 18,54 60: R\$ 18,91



BALAO 11 CORACAO LISO BRANCO 12X1  
Código: Fábrica: Unidade:  
**39193** HAPPY DAY PT/12  
F1 F4

UN: R\$ 1,45 AV: R\$ 17,45 15: R\$ 17,82  
30: R\$ 18,17 45: R\$ 18,54 60: R\$ 18,91



BALAO 11 CORACAO LISO ROSA 12X1  
Código: Fábrica: Unidade:  
**39194** HAPPY DAY PT/12  
F1 F4

UN: R\$ 1,45 AV: R\$ 17,45 15: R\$ 17,82  
30: R\$ 18,17 45: R\$ 18,54 60: R\$ 18,91



BALAO 11 CORACAO LISO VERMELHO 12X1  
Código: Fábrica: Unidade:  
**39195** HAPPY DAY PT/12  
F1 F4

UN: R\$ 0,47 AV: R\$ 23,52 15: R\$ 24,01  
30: R\$ 24,49 45: R\$ 24,98 60: R\$ 25,48



BALAO 11 PERA LISO CRISTAL 50X1  
Código: Fábrica: Unidade:  
**42326** HAPPY DAY PT/50  
F1 F4

UN: R\$ 0,47 AV: R\$ 23,52 15: R\$ 24,01  
30: R\$ 24,49 45: R\$ 24,98 60: R\$ 25,48



BALAO 11 PERA LISO VERDE AGUA 50X1  
Código: Fábrica: Unidade:  
**42332** HAPPY DAY PT/50  
F1 F4

UN: R\$ 0,47 AV: R\$ 23,52 15: R\$ 24,01  
30: R\$ 24,49 45: R\$ 24,98 60: R\$ 25,48



BALAO 11 PERA LISO AMARELO 50X1  
Código: Fábrica: Unidade:  
**42341** HAPPY DAY PT/50  
F1 F4

UN: R\$ 0,47 AV: R\$ 23,52 15: R\$ 24,01  
30: R\$ 24,49 45: R\$ 24,98 60: R\$ 25,48



BALAO 11 PERA LISO AZUL ARTICO 50X1  
Código: Fábrica: Unidade:  
**42314** HAPPY DAY PT/50  
F1 F4

UN: R\$ 0,47 AV: R\$ 23,52 15: R\$ 24,01  
30: R\$ 24,49 45: R\$ 24,98 60: R\$ 25,48



BALAO 11 PERA LISO AZUL CELESTE 50X1  
Código: Fábrica: Unidade:  
**42313** HAPPY DAY PT/50  
F1 F4

UN: R\$ 0,47 AV: R\$ 23,52 15: R\$ 24,01  
30: R\$ 24,49 45: R\$ 24,98 60: R\$ 25,48



BALAO 11 PERA LISO AZUL CLARO 50X1  
Código: Fábrica: Unidade:  
**42315** HAPPY DAY PT/50  
F1 F4

UN: R\$ 0,47 AV: R\$ 23,52 15: R\$ 24,01  
30: R\$ 24,49 45: R\$ 24,98 60: R\$ 25,48



BALAO 11 PERA LISO AZUL ESCURO 50X1  
Código: Fábrica: Unidade:  
**42311** HAPPY DAY PT/50  
F1 F4

UN: R\$ 0,47 AV: R\$ 23,52 15: R\$ 24,01  
30: R\$ 24,49 45: R\$ 24,98 60: R\$ 25,48



BALAO 11 PERA LISO AZUL TIFFANY 50X1  
Código: Fábrica: Unidade:  
**42316** HAPPY DAY PT/50  
F1 F4

UN: R\$ 0,47 AV: R\$ 23,52 15: R\$ 24,01  
30: R\$ 24,49 45: R\$ 24,98 60: R\$ 25,48



BALAO 11 PERA LISO BRANCO 50X1  
Código: Fábrica: Unidade:  
**42337** HAPPY DAY PT/50  
F1 F4

UN: R\$ 0,47 AV: R\$ 23,52 15: R\$ 24,01  
30: R\$ 24,49 45: R\$ 24,98 60: R\$ 25,48

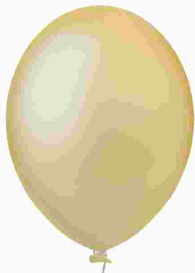

BALAO 11 PERA LISO CHAMPAGNE 50X1  
Código: Fábrica: Unidade:  
**42338** HAPPY DAY PT/50  
F1 F4

UN: R\$ 0,47 AV: R\$ 23,52 15: R\$ 24,01  
30: R\$ 24,49 45: R\$ 24,98 60: R\$ 25,48



BALAO 11 PERA LISO CORAL 50X1  
Código: Fábrica: Unidade:  
**42325** HAPPY DAY PT/50  
F1 F4

UN: R\$ 0,47 AV: R\$ 23,52 15: R\$ 24,01  
30: R\$ 24,49 45: R\$ 24,98 60: R\$ 25,48



BALAO 11 PERA LISO LARANJA 50X1  
Código: Fábrica: Unidade:  
**42324** HAPPY DAY PT/50  
F1 F4

UN: R\$ 0,47 AV: R\$ 23,52 15: R\$ 24,01  
30: R\$ 24,49 45: R\$ 24,98 60: R\$ 25,48



BALAO 11 PERA LISO LILAS 50X1  
Código: Fábrica: Unidade:  
**42339** HAPPY DAY PT/50  
F1 F4

UN: R\$ 0,47 AV: R\$ 23,52 15: R\$ 24,01  
30: R\$ 24,49 45: R\$ 24,98 60: R\$ 25,48



BALAO 11 PERA LISO MARROM 50X1  
Código: Fábrica: Unidade:  
**42333** HAPPY DAY PT/50  
F1 F4

UN: R\$ 0,47 AV: R\$ 23,52 15: R\$ 24,01  
30: R\$ 24,49 45: R\$ 24,98 60: R\$ 25,48



BALAO 11 PERA LISO MARSALA 50X1  
Código: Fábrica: Unidade:  
**42321** HAPPY DAY PT/50  
F1 F4

UN: R\$ 0,47 AV: R\$ 23,52 15: R\$ 24,01  
30: R\$ 24,49 45: R\$ 24,98 60: R\$ 25,48



BALAO 11 PERA LISO PRETO 50X1  
Código: Fábrica: Unidade:  
**42317** HAPPY DAY PT/50  
F1 F4

UN: R\$ 0,47 AV: R\$ 23,52 15: R\$ 24,01  
30: R\$ 24,49 45: R\$ 24,98 60: R\$ 25,48



BALAO 11 PERA LISO ROSA BEBE 50X1  
Código: Fábrica: Unidade:  
**42329** HAPPY DAY PT/50  
F1 F4

UN: R\$ 0,47 AV: R\$ 23,52 15: R\$ 24,01  
30: R\$ 24,49 45: R\$ 24,98 60: R\$ 25,48



BALAO 11 PERA LISO ROSA PINK 50X1  
Código: Fábrica: Unidade:  
**42327** HAPPY DAY PT/50  
F1 F4

UN: R\$ 0,47 AV: R\$ 23,52 15: R\$ 24,01  
30: R\$ 24,49 45: R\$ 24,98 60: R\$ 25,48



BALAO 11 PERA LISO ROSA 50X1  
Código: Fábrica: Unidade:  
**42322** HAPPY DAY PT/50  
F1 F4

UN: R\$ 0,47 AV: R\$ 23,52 15: R\$ 24,01  
30: R\$ 24,49 45: R\$ 24,98 60: R\$ 25,48



BALAO 11 PERA LISO SORTIDO 50X1  
Código: Fábrica: Unidade:  
**42343** HAPPY DAY PT/50  
F1 F4

UN: R\$ 0,47 AV: R\$ 23,52 15: R\$ 24,01  
30: R\$ 24,49 45: R\$ 24,98 60: R\$ 25,48

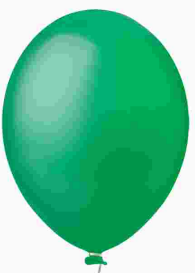

BALAO 11 PERA LISO VERDE BANDEIRA 50X1  
Código: Fábrica: Unidade:  
**42340** HAPPY DAY PT/50  
F1 F4

UN: R\$ 0,47 AV: R\$ 23,52 15: R\$ 24,01  
30: R\$ 24,49 45: R\$ 24,98 60: R\$ 25,48



BALAO 11 PERA LISO VERDE LIMAO 50X1  
Código: Fábrica: Unidade:  
**42331** HAPPY DAY PT/50  
F1 F4

UN: R\$ 0,47 AV: R\$ 23,52 15: R\$ 24,01  
30: R\$ 24,49 45: R\$ 24,98 60: R\$ 25,48



BALAO 11 PERA LISO VERDE 50X1  
Código: Fábrica: Unidade:  
**42330** HAPPY DAY PT/50  
F1 F4

UN: R\$ 0,47 AV: R\$ 23,52 15: R\$ 24,01  
30: R\$ 24,49 45: R\$ 24,98 60: R\$ 25,48



BALAO 11 PERA LISO VERMELHO PAIXAO 50X1  
Código: Fábrica: Unidade:  
**42323** HAPPY DAY PT/50  
F1 F4

UN: R\$ 0,47 AV: R\$ 23,52 15: R\$ 24,01  
30: R\$ 24,49 45: R\$ 24,98 60: R\$ 25,48



BALAO 11 PERA LISO VERMELHO 50X1

Código: 42335 Fábrica: HAPPY DAY Unidade: PT/50 F1 F4

UN: R\$ 0,47 AV: R\$ 23,52 15: R\$ 24,01  
30: R\$ 24,49 45: R\$ 24,98 60: R\$ 25,48

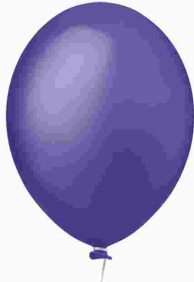

BALAO 11 PERA LISO VIOLETA 50X1

Código: 42342 Fábrica: HAPPY DAY Unidade: PT/50 F1 F4

UN: R\$ 0,74 AV: R\$ 18,48 15: R\$ 18,86  
30: R\$ 19,24 45: R\$ 19,63 60: R\$ 20,02



BALAO 11 SAFARI SORTIDO 25X1

Código: 42834 Fábrica: HAPPY DAY Unidade: PT/25 F1 F4

UN: R\$ 2,05 AV: R\$ 20,53 15: R\$ 20,96  
30: R\$ 21,38 45: R\$ 21,81 60: R\$ 22,24

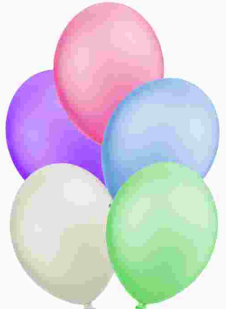

BALAO 16 RED PEROLIZADO CANDY SORT 10X1

Código: 42836 Fábrica: HAPPY DAY Unidade: PT/10 F1 F4

UN: R\$ 2,29 AV: R\$ 22,91 15: R\$ 23,38  
30: R\$ 23,85 45: R\$ 24,33 60: R\$ 24,82



BALAO 16 RED LISO AMARELO 10X1

Código: 41000 Fábrica: HAPPY DAY Unidade: PT/10 F1 F4

UN: R\$ 2,36 AV: R\$ 23,62 15: R\$ 24,11  
30: R\$ 24,59 45: R\$ 25,08 60: R\$ 25,58



BALAO 16 RED LISO AZUL CLARO 10X1

Código: 40724 Fábrica: HAPPY DAY Unidade: PT/10 F1 F4

UN: R\$ 2,36 AV: R\$ 23,62 15: R\$ 24,11  
30: R\$ 24,59 45: R\$ 25,08 60: R\$ 25,58



BALAO 16 RED LISO AZUL 10X1

Código: 40722 Fábrica: HAPPY DAY Unidade: PT/10 F1 F4

UN: R\$ 2,36 AV: R\$ 23,62 15: R\$ 24,11  
30: R\$ 24,59 45: R\$ 25,08 60: R\$ 25,58



BALAO 16 RED LISO BEGE 10X1

Código: 40732 Fábrica: HAPPY DAY Unidade: PT/10 F1 F4

UN: R\$ 2,36 AV: R\$ 23,62 15: R\$ 24,11  
30: R\$ 24,59 45: R\$ 25,08 60: R\$ 25,58

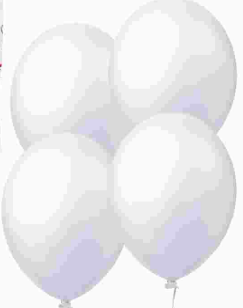

BALAO 16 RED LISO BRANCO 10X1

Código: 40721 Fábrica: HAPPY DAY Unidade: PT/10 F1 F4

UN: R\$ 2,36 AV: R\$ 23,62 15: R\$ 24,11  
30: R\$ 24,59 45: R\$ 25,08 60: R\$ 25,58

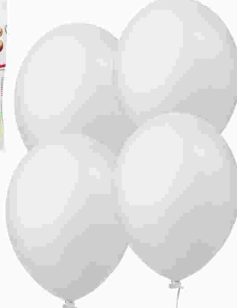

BALAO 16 RED LISO CINZA 10X1

Código: 40729 Fábrica: HAPPY DAY Unidade: PT/10 F1 F4

UN: R\$ 2,36 AV: R\$ 23,62 15: R\$ 24,11  
30: R\$ 24,59 45: R\$ 25,08 60: R\$ 25,58



BALAO 16 RED LISO CRISTAL 10X1

Código: 40731 Fábrica: HAPPY DAY Unidade: PT/10 F1 F4

UN: R\$ 2,36 AV: R\$ 23,62 15: R\$ 24,11  
30: R\$ 24,59 45: R\$ 25,08 60: R\$ 25,58

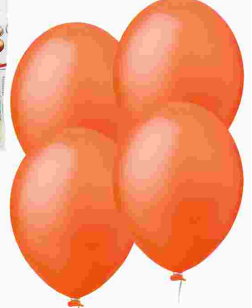

BALAO 16 RED LISO LARANJA 10X1

Código: 40728 Fábrica: HAPPY DAY Unidade: PT/10 F1 F4

UN: R\$ 2,36 AV: R\$ 23,62 15: R\$ 24,11  
30: R\$ 24,59 45: R\$ 25,08 60: R\$ 25,58

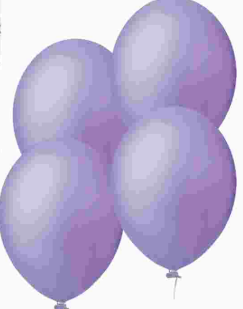

BALAO 16 RED LISO LILAS 10X1

Código: 40730 Fábrica: HAPPY DAY Unidade: PT/10 F1 F4

UN: R\$ 2,36 AV: R\$ 23,62 15: R\$ 24,11  
30: R\$ 24,59 45: R\$ 25,08 60: R\$ 25,58



BALAO 16 RED LISO PINK 10X1

Código: 40725 Fábrica: HAPPY DAY Unidade: PT/10 F1 F4

UN: R\$ 2,36 AV: R\$ 23,62 15: R\$ 24,11  
30: R\$ 24,59 45: R\$ 25,08 60: R\$ 25,58

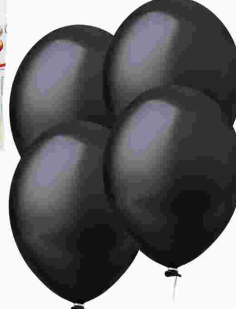

BALAO 16 RED LISO PRETO 10X1

Código: 40723 Fábrica: HAPPY DAY Unidade: PT/10 F1 F4

UN: R\$ 2,36 AV: R\$ 23,62 15: R\$ 24,11  
30: R\$ 24,59 45: R\$ 25,08 60: R\$ 25,58

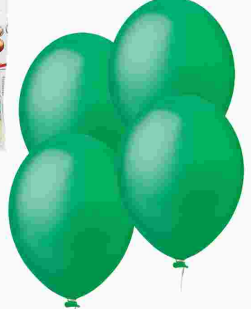

BALAO 16 RED LISO VERDE BANDEIRA 10X1

Código: 40726 Fábrica: HAPPY DAY Unidade: PT/10 F1 F4

UN: R\$ 2,36 AV: R\$ 23,62 15: R\$ 24,11  
30: R\$ 24,59 45: R\$ 25,08 60: R\$ 25,58



BALAO 16 RED LISO VERDE EUCALIPTO 10X1  
Código: Fábrica: Unidade:  
**40727** HAPPY DAY PT/10  
F1 F4

UN: R\$ 2,36 AV: R\$ 23,62 15: R\$ 24,11  
30: R\$ 24,59 45: R\$ 25,08 60: R\$ 25,58



BALAO 16 RED LISO VERMELHO 10X1  
Código: Fábrica: Unidade:  
**40733** HAPPY DAY PT/10  
F1 F4

UN: R\$ 6,15 AV: R\$ 6,15 15: R\$ 6,28  
30: R\$ 6,41 45: R\$ 6,53 60: R\$ 6,67



BANDEIRINHA PAPEL SEDA FESTA JUNINA 10MT  
Código: Fábrica: Unidade:  
**22503** ROMANA PT/1  
F1 F4

UN: R\$ 30,81 AV: R\$ 30,81 15: R\$ 31,45  
30: R\$ 32,08 45: R\$ 32,72 60: R\$ 33,37



BANDEJA RET MELAMINE 44,5X29,5CM 9951  
Código: Fábrica: Unidade:  
**49863** KEY UN/1  
F1 F4

UN: R\$ 49,30 AV: R\$ 49,30 15: R\$ 50,32  
30: R\$ 51,33 45: R\$ 52,36 60: R\$ 53,40



BANHEIRA PRATICA 20 LTS C/ESG ROSA 3738  
Código: Fábrica: Unidade:  
**18650** TRITEC UN/1  
F1 F4

UN: R\$ 10,26 AV: R\$ 10,26 15: R\$ 10,48  
30: R\$ 10,69 45: R\$ 10,90 60: R\$ 11,12



BARALHO PLASTIFICADO 1001 2X1 ESTOJO  
Código: Fábrica: Unidade:  
**21875** COPAG CX/1  
F1 F4

UN: R\$ 11,13 AV: R\$ 133,53 15: R\$ 136,31  
30: R\$ 139,03 45: R\$ 141,81 60: R\$ 144,65



BARALHO 54 CARTAS 12X1 (O MESMO 139)  
Código: Fábrica: Unidade:  
**7438** COPAG CX/12  
F1 F4

UN: R\$ 210,58 AV: R\$ 210,58 15: R\$ 214,96  
30: R\$ 219,26 45: R\$ 223,65 60: R\$ 228,12



BARRACA CAMPING 3 LUGARES SAN VALENTIN  
Código: Fábrica: Unidade:  
**48080** KALA UN/1  
F1 F4

UN: R\$ 199,27 AV: R\$ 199,27 15: R\$ 203,42  
30: R\$ 207,49 45: R\$ 211,64 60: R\$ 215,87



BARRACA DE CAMPING 2 LUGARES  
Código: Fábrica: Unidade:  
**32358** ANTARES UN/1  
F1 F4

UN: R\$ 297,88 AV: R\$ 297,88 15: R\$ 304,08  
30: R\$ 310,17 45: R\$ 316,37 60: R\$ 322,70



BARRACA DE CAMPING 3 LUGARES  
Código: Fábrica: Unidade:  
**32359** ANTARES UN/1  
F1 F4

UN: R\$ 349,24 AV: R\$ 349,24 15: R\$ 356,51  
30: R\$ 363,64 45: R\$ 370,92 60: R\$ 378,34



BARRACA DE CAMPING 4 LUGARES  
Código: Fábrica: Unidade:  
**32360** ANTARES UN/1  
F1 F4

UN: R\$ 1,59 AV: R\$ 7,96 15: R\$ 8,13  
30: R\$ 8,29 45: R\$ 8,46 60: R\$ 8,62



BATERIA 3 V LITHIUM 2032 CR2032C 5X1  
Código: Fábrica: Unidade:  
**44292** ALFACELL CR/5  
F1 F4

UN: R\$ 2,46 AV: R\$ 12,32 15: R\$ 12,57  
30: R\$ 12,82 45: R\$ 13,08 60: R\$ 13,34



BATERIA 3 V LITIO 2016 5X1  
Código: Fábrica: Unidade:  
**22511** ALFACELL CT/5  
F1 F4

UN: R\$ 2,57 AV: R\$ 12,84 15: R\$ 13,11  
30: R\$ 13,37 45: R\$ 13,64 60: R\$ 13,91



BATERIA 3 V LITIO 2025 5X1  
Código: Fábrica: Unidade:  
**15177** ALFACELL CR/5  
F1 F4

UN: R\$ 1,62 AV: R\$ 8,10 15: R\$ 8,27  
30: R\$ 8,44 45: R\$ 8,61 60: R\$ 8,78



BATERIA 3 V 1220 LITHIUM 40MAH 5X1  
Código: Fábrica: Unidade:  
**44281** ALFACELL CR/5  
F1 F4

UN: R\$ 15,40 AV: R\$ 15,40 15: R\$ 15,72  
30: R\$ 16,03 45: R\$ 16,35 60: R\$ 16,68



BATERIA 9 V ALCALINA 6LR61/1B CTL  
Código: Fábrica: Unidade:  
**42403** ALFACELL CR/1  
F1 F4

UN: R\$ 5,95 AV: R\$ 5,95 15: R\$ 6,07  
30: R\$ 6,19 45: R\$ 6,32 60: R\$ 6,44



BATERIA 9 V 6F22/1B CTL  
Código: Fábriça: Unidade:  
**29372** ALFACELL CR/1  
F1 F4

UN: R\$ 4,45 AV: R\$ 53,40 15: R\$ 54,52  
30: R\$ 55,61 45: R\$ 56,72 60: R\$ 57,85



BATERIA 9 V 6F22/1SC 12X1  
Código: Fábriça: Unidade:  
**47903** ALFACELL CX/12  
F1 F4

UN: R\$ 0,62 AV: R\$ 30,81 15: R\$ 31,45  
30: R\$ 32,08 45: R\$ 32,72 60: R\$ 33,37

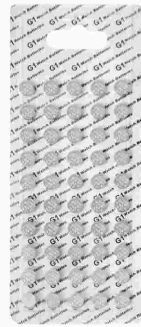

BATERIA G01 SR621/364/164/1,5V 50X1  
Código: Fábriça: Unidade:  
**20624** RDE PT/50  
F1 F4

UN: R\$ 1,33 AV: R\$ 13,34 15: R\$ 13,62  
30: R\$ 13,89 45: R\$ 14,17 60: R\$ 14,46



BATERIA G04 377/177 SR626V 1,55V 10X1  
Código: Fábriça: Unidade:  
**29370** ALFACELL CR/10  
F1 F4

UN: R\$ 0,62 AV: R\$ 30,81 15: R\$ 31,45  
30: R\$ 32,08 45: R\$ 32,72 60: R\$ 33,37



BATERIA G10 LR1130/379 REL AQUA 50X1  
Código: Fábriça: Unidade:  
**6494** AG CT/50  
F1 F4

UN: R\$ 2,56 AV: R\$ 5,13 15: R\$ 5,23  
30: R\$ 5,34 45: R\$ 5,44 60: R\$ 5,55



BATERIA G13 LR44 LASER/TAMAGUCHI 1,5V 5X1  
Código: Fábriça: Unidade:  
**41186** ALFACELL CR/2  
F1 F4

UN: R\$ 0,62 AV: R\$ 30,81 15: R\$ 31,45  
30: R\$ 32,08 45: R\$ 32,72 60: R\$ 33,37



BATERIA G13 LR44 LASER/TAMAGUCHI 1,5V 5X1  
Código: Fábriça: Unidade:  
**25027** NR CT/50  
F1 F4

UN: R\$ 20,53 AV: R\$ 20,53 15: R\$ 20,96  
30: R\$ 21,38 45: R\$ 21,81 60: R\$ 22,24



BATERIA TELEFONE S/FIO 600MAH MO-U120  
Código: Fábriça: Unidade:  
**5689** MOX UN/1  
F1 F4

UN: R\$ 3,08 AV: R\$ 15,40 15: R\$ 15,72  
30: R\$ 16,03 45: R\$ 16,35 60: R\$ 16,68



BATERIA 12 V ALCALINA 23A 5X1  
Código: Fábriça: Unidade:  
**43250** ALFACELL CR/5  
F1 F4

UN: R\$ 1,54 AV: R\$ 15,40 15: R\$ 15,72  
30: R\$ 16,03 45: R\$ 16,35 60: R\$ 16,68



BATERIA 364/164/SR621SW 1,55V 10X1  
Código: Fábriça: Unidade:  
**41187** ALFACELL CR/10  
F1 F4

UN: R\$ 2,05 AV: R\$ 20,53 15: R\$ 20,96  
30: R\$ 21,38 45: R\$ 21,81 60: R\$ 22,24



BATERIA 371 SR920SW 1,55V RELOGIO 10X1  
Código: Fábriça: Unidade:  
**41188** ALFACELL CR/10  
F1 F4

UN: R\$ 9,49 AV: R\$ 9,49 15: R\$ 9,49  
30: R\$ 9,49 45: R\$ 9,49 60: R\$ 9,49



BICO EXTENSOR P/TORNEIRA CTL 525X3  
Código: Fábriça: Unidade:  
**43271** MEGAGIFT CT/1  
F1 F4

UN: R\$ 0,03 AV: R\$ 1,39 15: R\$ 1,42  
30: R\$ 1,44 45: R\$ 1,47 60: R\$ 1,50

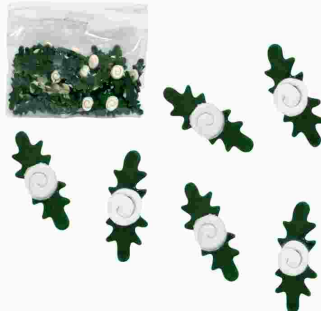

BISCUIT ROCOCO SIMPLES BRANCO 50X1  
Código: Fábriça: Unidade:  
**37757** MINAS BRILHO PT/50  
F1 F4

UN: R\$ 0,03 AV: R\$ 1,39 15: R\$ 1,42  
30: R\$ 1,44 45: R\$ 1,47 60: R\$ 1,50



BISCUIT ROCOCO SIMPLES DOURADO 50X1  
Código: Fábriça: Unidade:  
**37758** MINAS BRILHO PT/50  
F1 F4

UN: R\$ 0,03 AV: R\$ 1,39 15: R\$ 1,42  
30: R\$ 1,44 45: R\$ 1,47 60: R\$ 1,50



BISCUIT ROCOCO SIMPLES LARANJA 50X1  
Código: Fábriça: Unidade:  
**37759** MINAS BRILHO PT/50  
F1 F4

UN: R\$ 0,03 AV: R\$ 1,39 15: R\$ 1,42  
30: R\$ 1,44 45: R\$ 1,47 60: R\$ 1,50



BISCUIT ROCOCO SIMPLES PRATA 50X1  
Código: Fábriça: Unidade:  
**37761** MINAS BRILHO PT/50  
F1 F4

UN: R\$ 0,03 AV: R\$ 1,39 15: R\$ 1,42  
30: R\$ 1,44 45: R\$ 1,47 60: R\$ 1,50

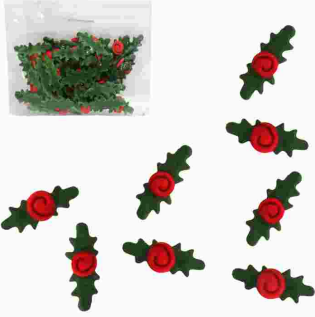

BISCUIT ROCOCO SIMPLES VERMELHO 50X1

Código: 37764 Fábrica: MINAS BRILHO Unidade: PT/50 F1 F4

UN: R\$ 0,35 AV: R\$ 34,77 15: R\$ 35,50  
30: R\$ 36,21 45: R\$ 36,93 60: R\$ 37,67

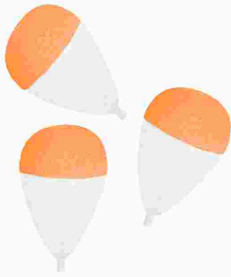

BOIA PESCA A-1 B.D 100X1

Código: 47684 Fábrica: AAL Unidade: CE/100 F1 F4

UN: R\$ 0,35 AV: R\$ 35,44 15: R\$ 36,18  
30: R\$ 36,90 45: R\$ 37,64 60: R\$ 38,39



BOIA PESCA A-2 B.D 100X1

Código: 47685 Fábrica: AAL Unidade: CE/100 F1 F4

UN: R\$ 0,49 AV: R\$ 49,30 15: R\$ 50,32  
30: R\$ 51,33 45: R\$ 52,36 60: R\$ 53,40



BOIA PESCA A-3 B.D 100X1

Código: 33213 Fábrica: AAL Unidade: CE/100 F1 F4

UN: R\$ 0,60 AV: R\$ 60,35 15: R\$ 61,61  
30: R\$ 62,84 45: R\$ 64,09 60: R\$ 65,38



BOIA PESCA A-4 B.D 100X1

Código: 33214 Fábrica: AAL Unidade: CE/100 F1 F4

UN: R\$ 0,72 AV: R\$ 71,89 15: R\$ 73,39  
30: R\$ 74,86 45: R\$ 76,36 60: R\$ 77,88



BOIA PESCA A-5 B.D 100X1

Código: 33215 Fábrica: AAL Unidade: CE/100 F1 F4

UN: R\$ 1,03 AV: R\$ 102,71 15: R\$ 104,85  
30: R\$ 106,95 45: R\$ 109,09 60: R\$ 111,27



BOIA PESCA A-6 B.D 100X1

Código: 33216 Fábrica: AAL Unidade: CE/100 F1 F4

UN: R\$ 0,77 AV: R\$ 18,48 15: R\$ 18,86  
30: R\$ 19,24 45: R\$ 19,63 60: R\$ 20,02



BOLINHA AQUA BIO GEL CRESCE NA AGUA 24X1

Código: 20312 Fábrica: CHENSON Unidade: PT/24 F1 F4

UN: R\$ 174,61 AV: R\$ 174,61 15: R\$ 178,25  
30: R\$ 181,82 45: R\$ 185,45 60: R\$ 189,16



BOLSA FEM COURO SINT AMAYRA CAFE 3123-2

Código: 42471 Fábrica: AMAYRA Unidade: UN/1 F1 F4

UN: R\$ 61,62 AV: R\$ 61,62 15: R\$ 62,91  
30: R\$ 64,16 45: R\$ 65,45 60: R\$ 66,76



BOLSA LONA ESPORTES MED GDES MARCAS

Código: 45875 Fábrica: FMM Unidade: UN/1 F1 F4

UN: R\$ 69,84 AV: R\$ 69,84 15: R\$ 71,29  
30: R\$ 72,72 45: R\$ 74,17 60: R\$ 75,66



BOLSA LONA VIAGEM GDE C/TELA 4003

Código: 5467 Fábrica: LITA Unidade: UN/1 F1 F4

UN: R\$ 70,87 AV: R\$ 70,87 15: R\$ 72,34  
30: R\$ 73,79 45: R\$ 75,27 60: R\$ 76,77



BOLSA LONA VIAGEM GG 4001

Código: 17044 Fábrica: LITA Unidade: UN/1 F1 F4

UN: R\$ 60,59 AV: R\$ 60,59 15: R\$ 61,86  
30: R\$ 63,09 45: R\$ 64,36 60: R\$ 65,64



BOLSA LONA VIAGEM MED 4007

Código: 5468 Fábrica: LITA Unidade: UN/1 F1 F4

UN: R\$ 43,13 AV: R\$ 43,13 15: R\$ 44,03  
30: R\$ 44,91 45: R\$ 45,81 60: R\$ 46,73



BOLSA LONA VIAGEM PEQ 4009

Código: 2055 Fábrica: LITA Unidade: UN/1 F1 F4

UN: R\$ 73,95 AV: R\$ 73,95 15: R\$ 75,49  
30: R\$ 77,00 45: R\$ 78,54 60: R\$ 80,11



BOLSA TIRACOLO BAG 19X14X6,5CM 0073

Código: 42477 Fábrica: MORMAII Unidade: UN/1 F1 F4

UN: R\$ 19,51 AV: R\$ 19,51 15: R\$ 19,91  
30: R\$ 20,31 45: R\$ 20,72 60: R\$ 21,13



BOLSA TRANSVERSAL COURINO GDES MARCAS

Código: 38065 Fábrica: CJL Unidade: UN/1 F1 F4

UN: R\$ 232,55 AV: R\$ 232,55 15: R\$ 237,39  
30: R\$ 242,14 45: R\$ 246,98 60: R\$ 251,92



BOLSA VIAGEM POLIESTER WILSON 021  
Código: Fábrica: Unidade:  
**43679** WILSON UN/1  
F1 F4

UN: R\$ 16,18 AV: R\$ 16,18 15: R\$ 16,52  
30: R\$ 16,85 45: R\$ 17,18 60: R\$ 17,53



BOMBA AR MANUAL BOLA BICICLETA 30CM 719  
Código: Fábrica: Unidade:  
**34058** COSTAVERDE UN/1  
F1 F4

UN: R\$ 27,27 AV: R\$ 27,27 15: R\$ 27,84  
30: R\$ 28,40 45: R\$ 28,97 60: R\$ 29,54



BOMBA AR MANUAL BOLA BICICLETA 56CM 717  
Código: Fábrica: Unidade:  
**36444** COSTAVERDE UN/1  
F1 F4

UN: R\$ 29,78 AV: R\$ 29,78 15: R\$ 30,40  
30: R\$ 31,01 45: R\$ 31,63 60: R\$ 32,26



BOMBA AR MANUAL DUPLA ACAO 20CM 6 BICOS  
Código: Fábrica: Unidade:  
**48342** CONVOY SPORT UN/1  
F1 F4

UN: R\$ 12,89 AV: R\$ 12,89 15: R\$ 13,16  
30: R\$ 13,42 45: R\$ 13,69 60: R\$ 13,97  
14 cm



BOMBA AR MANUAL P/ENCHER BOLA 20CM C/ACE  
Código: Fábrica: Unidade:  
**34815** KYRIOS UN/1  
F1 F4

UN: R\$ 13,34 AV: R\$ 13,34 15: R\$ 13,62  
30: R\$ 13,89 45: R\$ 14,17 60: R\$ 14,46



BOMBA AR MANUAL P/ENCHER BOLA 22 CM MA31  
Código: Fábrica: Unidade:  
**23756** JK UN/1  
F1 F4

UN: R\$ 12,32 AV: R\$ 12,32 15: R\$ 12,57  
30: R\$ 12,82 45: R\$ 13,08 60: R\$ 13,34



BOMBA AR MANUAL P/ENCHER BOLA 28CM 43026  
Código: Fábrica: Unidade:  
**47292** IMPORIENTE UN/1  
F1 F4

UN: R\$ 48,27 AV: R\$ 48,27 15: R\$ 49,27  
30: R\$ 50,26 45: R\$ 51,26 60: R\$ 52,29



BOMBA DE AR MANUAL SAC AZUL T-U  
Código: Fábrica: Unidade:  
**37397** PENALTY UN/1  
F1 F4

UN: R\$ 6,67 AV: R\$ 6,67 15: R\$ 6,81  
30: R\$ 6,94 45: R\$ 7,08 60: R\$ 7,22



BOMBA DE AR MANUAL 16,5CM HM704  
Código: Fábrica: Unidade:  
**27043** HOME&MORE UN/1  
F1 F4

UN: R\$ 177,70 AV: R\$ 177,70 15: R\$ 181,40  
30: R\$ 185,03 45: R\$ 188,73 60: R\$ 192,50



BOMBA ELETRICA P/BALAO 1472  
Código: Fábrica: Unidade:  
**49243** HAI BRASIL UN/1  
F1 F4

UN: R\$ 58,54 AV: R\$ 58,54 15: R\$ 59,76  
30: R\$ 60,95 45: R\$ 62,17 60: R\$ 63,42



BOMBA P/ENCHER BOLA DUPLA ACAO METAL  
Código: Fábrica: Unidade:  
**22582** OFF SIDE UN/1  
F1 F4

UN: R\$ 20,53 AV: R\$ 20,53 15: R\$ 20,96  
30: R\$ 21,38 45: R\$ 21,81 60: R\$ 22,24



BONE ABA CURVA GDES MARCAS  
Código: Fábrica: Unidade:  
**21832** CJL UN/1  
F1 F4

UN: R\$ 28,99 AV: R\$ 28,99 15: R\$ 28,99  
30: R\$ 28,99 45: R\$ 28,99 60: R\$ 28,99



BONE MEIA TELA COUNTRY C/BOTTON MET 1064  
Código: Fábrica: Unidade:  
**36852** GLX UN/1  
F1 F4

UN: R\$ 29,99 AV: R\$ 29,99 15: R\$ 29,99  
30: R\$ 29,99 45: R\$ 29,99 60: R\$ 29,99



BONE MEIA TELA COUNTRY C/BOTTON MET12033  
Código: Fábrica: Unidade:  
**44473** GLX UN/1  
F1 F4

UN: R\$ 30,81 AV: R\$ 30,81 15: R\$ 31,45  
30: R\$ 32,08 45: R\$ 32,72 60: R\$ 33,37



BONE MEIA TELA TRUCKER COUNTRY BORD12041  
Código: Fábrica: Unidade:  
**44474** GLX UN/1  
F1 F4

UN: R\$ 29,99 AV: R\$ 29,99 15: R\$ 29,99  
30: R\$ 29,99 45: R\$ 29,99 60: R\$ 29,99



BONE MEIA TELA TRUCKER COUNTRY CAMUFLADO  
Código: Fábrica: Unidade:  
**44472** GLX UN/1  
F1 F4

UN: R\$ 27,99 AV: R\$ 27,99 15: R\$ 27,99  
30: R\$ 27,99 45: R\$ 27,99 60: R\$ 27,99



BONE MEIA TELA TRUCKER COUNTRY COUR12015

Código: Fábrica: Unidade:  
**44475** GLX UN/1  
F1 F4

UN: R\$ 28,99 AV: R\$ 28,99 15: R\$ 28,99  
30: R\$ 28,99 45: R\$ 28,99 60: R\$ 28,99



BONE MEIA TELA TRUCKER GOSPEL BORDA 1600

Código: Fábrica: Unidade:  
**44471** GLX UN/1  
F1 F4

UN: R\$ 7,99 AV: R\$ 7,99 15: R\$ 7,99  
30: R\$ 7,99 45: R\$ 7,99 60: R\$ 7,99



BONE TEC TEL ATLET

Código: Fábrica: Unidade:  
**17989** CJL UN/1  
F1 F4

UN: R\$ 4,45 AV: R\$ 106,83 15: R\$ 109,05  
30: R\$ 111,24 45: R\$ 113,46 60: R\$ 115,73

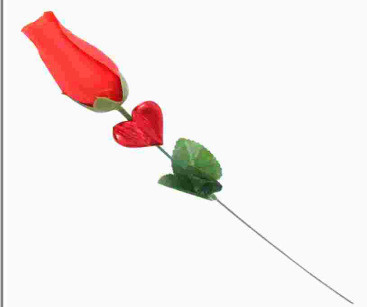

BOTAO ROSA VERMELHO CORACAO 3931 24X1

Código: Fábrica: Unidade:  
**49582** WINMAX PT/24  
F1 F4

UN: R\$ 3,79 AV: R\$ 90,91 15: R\$ 92,80  
30: R\$ 94,66 45: R\$ 96,55 60: R\$ 98,48



BOTAO ROSA VERMELHO CORACAO 3932 24X1

Código: Fábrica: Unidade:  
**36567** WINMAX PT/24  
F1 F4

UN: R\$ 4,87 AV: R\$ 184,89 15: R\$ 188,74  
30: R\$ 192,51 45: R\$ 196,36 60: R\$ 200,29



BOTAO ROSA VERMELHO LOVE 3933 38X1

Código: Fábrica: Unidade:  
**49584** WINMAX CX/38  
F1 F4

UN: R\$ 10,80 AV: R\$ 129,58 15: R\$ 132,28  
30: R\$ 134,93 45: R\$ 137,63 60: R\$ 140,38



BOTAO ROSA VERMELHO URSINHO 3936 12X1

Código: Fábrica: Unidade:  
**49583** WINMAX PT/12  
F1 F4

UN: R\$ 10,27 AV: R\$ 20,53 15: R\$ 20,96  
30: R\$ 21,38 45: R\$ 21,81 60: R\$ 22,24

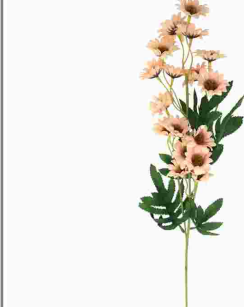

BOUQUET MINI MARGARIDA 3886 2X1

Código: Fábrica: Unidade:  
**41392** H8 RL/2  
F1 F4

UN: R\$ 4,49 AV: R\$ 4,49 15: R\$ 4,49  
30: R\$ 4,49 45: R\$ 4,49 60: R\$ 4,49



BOUQUET 4 FLORES CEREJEIRA 55108 UN

Código: Fábrica: Unidade:  
**49572** ALMEGA UN/1  
F1 F4

UN: R\$ 4,49 AV: R\$ 4,49 15: R\$ 4,49  
30: R\$ 4,49 45: R\$ 4,49 60: R\$ 4,49



BOUQUET 4 FLORES COPO DE LEITE 55101 UN

Código: Fábrica: Unidade:  
**49577** ALMEGA UN/1  
F1 F4

UN: R\$ 4,49 AV: R\$ 4,49 15: R\$ 4,49  
30: R\$ 4,49 45: R\$ 4,49 60: R\$ 4,49



BOUQUET 4 FLORES CRAVO 55112 UN

Código: Fábrica: Unidade:  
**49578** ALMEGA UN/1  
F1 F4

UN: R\$ 4,49 AV: R\$ 4,49 15: R\$ 4,49  
30: R\$ 4,49 45: R\$ 4,49 60: R\$ 4,49

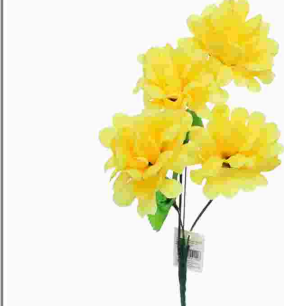

BOUQUET 4 FLORES CRISANTEMO 55111 UN

Código: Fábrica: Unidade:  
**49571** ALMEGA UN/1  
F1 F4

UN: R\$ 4,80 AV: R\$ 4,80 15: R\$ 4,90  
30: R\$ 4,99 45: R\$ 5,09 60: R\$ 5,20



BOUQUET 4 FLORES DALIA 55113 UN

Código: Fábrica: Unidade:  
**49570** ALMEGA UN/1  
F1 F4

UN: R\$ 4,49 AV: R\$ 4,49 15: R\$ 4,49  
30: R\$ 4,49 45: R\$ 4,49 60: R\$ 4,49



BOUQUET 4 FLORES GIRASSOL 55107 UN

Código: Fábrica: Unidade:  
**49576** ALMEGA UN/1  
F1 F4

UN: R\$ 4,49 AV: R\$ 4,49 15: R\$ 4,49  
30: R\$ 4,49 45: R\$ 4,49 60: R\$ 4,49



BOUQUET 4 FLORES MAGNOLIA 55106 UN

Código: Fábrica: Unidade:  
**49575** ALMEGA UN/1  
F1 F4

UN: R\$ 4,49 AV: R\$ 4,49 15: R\$ 4,49  
30: R\$ 4,49 45: R\$ 4,49 60: R\$ 4,49

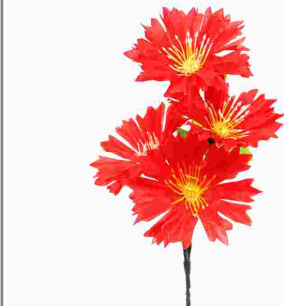

BOUQUET 4 FLORES MARGARIDA 55102 UN

Código: Fábrica: Unidade:  
**49574** ALMEGA UN/1  
F1 F4

UN: R\$ 4,49 AV: R\$ 4,49 15: R\$ 4,49  
30: R\$ 4,49 45: R\$ 4,49 60: R\$ 4,49



BOUQUET 4 FLORES ROSA 55104 UN

Código: Fábrica: Unidade:  
**49573** ALMEGA UN/1  
F1 F4

UN: R\$ 9,33 AV: R\$ 111,95 15: R\$ 114,29  
30: R\$ 116,57 45: R\$ 118,90 60: R\$ 121,28



BOUQUET 5 FLORES DALIA TULE 933044 12X1

Código: Fábrica: Unidade:  
**22005** BELLA FLOR C//12  
F1 F4

UN: R\$ 9,24 AV: R\$ 36,97 15: R\$ 37,74  
30: R\$ 38,49 45: R\$ 39,26 60: R\$ 40,05



BOUQUET 5 FLORES GERBERA 212884 4X1

Código: Fábrica: Unidade:  
**41099** BELLA FLOR C//4  
F1 F4

UN: R\$ 8,21 AV: R\$ 16,42 15: R\$ 16,77  
30: R\$ 17,10 45: R\$ 17,44 60: R\$ 17,79



BOUQUET 5 FLORES GIRASSOL 911384 2X1

Código: Fábrica: Unidade:  
**41101** BELLA FLOR C//2  
F1 F4

UN: R\$ 8,21 AV: R\$ 16,42 15: R\$ 16,77  
30: R\$ 17,10 45: R\$ 17,44 60: R\$ 17,79



BOUQUET 5 FLORES MAGNOLIA 213084 2X1

Código: Fábrica: Unidade:  
**41102** BELLA FLOR PT/2  
F1 F4

UN: R\$ 4,37 AV: R\$ 52,44 15: R\$ 53,53  
30: R\$ 54,60 45: R\$ 55,69 60: R\$ 56,81

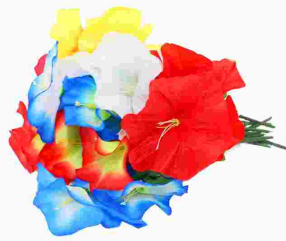

BOUQUET 5 FLORES 20191 12X1

Código: Fábrica: Unidade:  
**49564** ALIANCA PT/12  
F1 F4

UN: R\$ 4,37 AV: R\$ 52,44 15: R\$ 53,53  
30: R\$ 54,60 45: R\$ 55,69 60: R\$ 56,81



BOUQUET 5 FLORES 20193 12X1

Código: Fábrica: Unidade:  
**49565** ALIANCA PT/12  
F1 F4

UN: R\$ 4,37 AV: R\$ 52,44 15: R\$ 53,53  
30: R\$ 54,60 45: R\$ 55,69 60: R\$ 56,81



BOUQUET 5 FLORES 20194 12X1

Código: Fábrica: Unidade:  
**49566** ALIANCA PT/12  
F1 F4

UN: R\$ 0,07 AV: R\$ 6,99 15: R\$ 7,13  
30: R\$ 7,27 45: R\$ 7,42 60: R\$ 7,57



BUCHA PAREDE 6MM 100X1 5889

Código: Fábrica: Unidade:  
**38207** IDEA PT/100  
F1 F4

UN: R\$ 0,08 AV: R\$ 8,01 15: R\$ 8,18  
30: R\$ 8,34 45: R\$ 8,51 60: R\$ 8,68



BUCHA PAREDE 8MM 100X1 5885

Código: Fábrica: Unidade:  
**38206** IDEA PT/100  
F1 F4

UN: R\$ 5,99 AV: R\$ 5,99 15: R\$ 5,99  
30: R\$ 5,99 45: R\$ 5,99 60: R\$ 5,99



CABO AUDIO P2 1,5 MTS 117/962

Código: Fábrica: Unidade:  
**35977** WINMAX UN/1  
F1 F4

UN: R\$ 8,40 AV: R\$ 8,40 15: R\$ 8,58  
30: R\$ 8,75 45: R\$ 8,93 60: R\$ 9,10

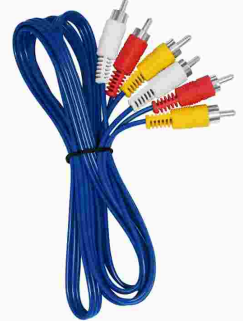

CABO AUDIO RCA2 X RCA2 1,5 MTS 1118

Código: Fábrica: Unidade:  
**40925** WINMAX UN/1  
F1 F4

UN: R\$ 18,49 AV: R\$ 18,49 15: R\$ 18,87  
30: R\$ 19,25 45: R\$ 19,64 60: R\$ 20,03



CABO CARR CELULAR USB V8 2M 1000AH

Código: Fábrica: Unidade:  
**40687** PMCELL UN/1  
F4

UN: R\$ 31,50 AV: R\$ 31,50 15: R\$ 32,16  
30: R\$ 32,80 45: R\$ 33,46 60: R\$ 34,13



CABO CARR TPC IPHONE 1,2M 30W BCO 155CI

Código: Fábrica: Unidade:  
**48448** MAKETECH UN/1  
F1 F4

UN: R\$ 15,41 AV: R\$ 15,41 15: R\$ 15,73  
30: R\$ 16,04 45: R\$ 16,36 60: R\$ 16,69



CABO CARR TRANSM DADOS USB 1M V8 5900

Código: Fábrica: Unidade:  
**41566** INOVA PT/1  
F1 F4

UN: R\$ 24,50 AV: R\$ 24,50 15: R\$ 25,01  
30: R\$ 25,51 45: R\$ 26,02 60: R\$ 26,54



CABO CARR TRANSM DADOS 1M TP C D88 74608

Código: Fábrica: Unidade:  
**43310** LETRON UN/1  
F1 F4

UN: R\$ 15,16 AV: R\$ 15,16 15: R\$ 15,48  
30: R\$ 15,79 45: R\$ 16,10 60: R\$ 16,43



CABO CARR TRANSM DADOS 1M V8 X03-1/02-1

Código: Fábrika: Unidade:  
**41039** HMASTON/GOLD UN/1  
F1 F4

UN: R\$ 14,00 AV: R\$ 14,00 15: R\$ 14,29  
30: R\$ 14,57 45: R\$ 14,86 60: R\$ 15,16



CABO CARR TRANSM DADOS 1M V8 8721

Código: Fábrika: Unidade:  
**36931** INOVA UN/1  
F1 F4

UN: R\$ 14,00 AV: R\$ 14,00 15: R\$ 14,29  
30: R\$ 14,57 45: R\$ 14,86 60: R\$ 15,16



CABO CARREG USB TPC 1,10M 2.4 6007/06

Código: Fábrika: Unidade:  
**48578** INOV/MAKETEC UN/1  
F1 F4

UN: R\$ 0,18 AV: R\$ 18,48 15: R\$ 18,86  
30: R\$ 19,24 45: R\$ 19,63 60: R\$ 20,02



CABO DE ACO 10MTS 05 LIBRAS

Código: Fábrika: Unidade:  
**41867** MARINE CE/100  
F4

UN: R\$ 0,20 AV: R\$ 19,51 15: R\$ 19,91  
30: R\$ 20,31 45: R\$ 20,72 60: R\$ 21,13



CABO DE ACO 10MTS 20 LIBRAS

Código: Fábrika: Unidade:  
**41868** MARINE CE/100  
F4

UN: R\$ 0,21 AV: R\$ 20,53 15: R\$ 20,96  
30: R\$ 21,38 45: R\$ 21,81 60: R\$ 22,24

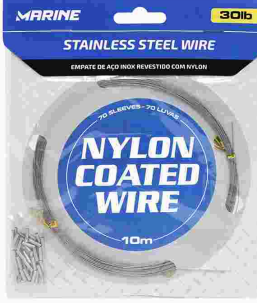

CABO DE ACO 10MTS 30 LIBRAS

Código: Fábrika: Unidade:  
**41870** MARINE CE/100  
F4

UN: R\$ 0,23 AV: R\$ 22,59 15: R\$ 23,06  
30: R\$ 23,52 45: R\$ 23,99 60: R\$ 24,47



CABO DE ACO 10MTS 40 LIBRAS

Código: Fábrika: Unidade:  
**41871** MARINE CE/100  
F4

UN: R\$ 0,26 AV: R\$ 25,67 15: R\$ 26,20  
30: R\$ 26,73 45: R\$ 27,26 60: R\$ 27,81



CABO DE ACO 10MTS 60 LIBRAS

Código: Fábrika: Unidade:  
**41873** MARINE CE/100  
F4

UN: R\$ 0,31 AV: R\$ 30,81 15: R\$ 31,45  
30: R\$ 32,08 45: R\$ 32,72 60: R\$ 33,37



CABO DE ACO 10MTS 90 LIBRAS

Código: Fábrika: Unidade:  
**41875** MARINE CE/100  
F4

UN: R\$ 70,03 AV: R\$ 70,03 15: R\$ 71,48  
30: R\$ 72,91 45: R\$ 74,37 60: R\$ 75,86



CABO ENXERTO CHUPETA BATERIA 1000AMP 135

Código: Fábrika: Unidade:  
**31763** AIH/NAPOLES UN/1  
F1 F4

UN: R\$ 2,39 AV: R\$ 23,91 15: R\$ 24,41  
30: R\$ 24,90 45: R\$ 25,40 60: R\$ 25,91



CABO EXTENSOR CHIBIU 1,0 M PLAST 10X1

Código: Fábrika: Unidade:  
**441** TOKELASTICOS PT/10  
F1 F4

UN: R\$ 3,80 AV: R\$ 38,00 15: R\$ 38,79  
30: R\$ 39,56 45: R\$ 40,35 60: R\$ 41,16



CABO EXTENSOR CHIBIU 1,5 M PLAST 10X1

Código: Fábrika: Unidade:  
**1613** MB PT/10  
F1 F4

UN: R\$ 6,56 AV: R\$ 65,59 15: R\$ 66,95  
30: R\$ 68,29 45: R\$ 69,66 60: R\$ 71,05



CABO EXTENSOR CHIBIU 2,0 M METAL 10X1

Código: Fábrika: Unidade:  
**18644** WINMAX PT/10  
F1 F4

UN: R\$ 4,42 AV: R\$ 44,16 15: R\$ 45,08  
30: R\$ 45,98 45: R\$ 46,90 60: R\$ 47,84



CABO EXTENSOR CHIBIU 2,0 M PLAST 10X1

Código: Fábrika: Unidade:  
**1656** MB PT/10  
F1 F4

UN: R\$ 6,16 AV: R\$ 61,62 15: R\$ 62,91  
30: R\$ 64,16 45: R\$ 65,45 60: R\$ 66,76



CABO EXTENSOR CHIBIU 3,0 M PLAST 10X1

Código: Fábrika: Unidade:  
**24576** MB PT/10  
F1 F4

UN: R\$ 6,68 AV: R\$ 66,76 15: R\$ 68,15  
30: R\$ 69,51 45: R\$ 70,90 60: R\$ 72,32



CABO EXTENSOR CHIBIU 4,0 M PLAST 10X1

Código: Fábrika: Unidade:  
**24577** TOKELASTICOS PT/10  
F1 F4

UN: R\$ 16,33 AV: R\$ 16,33 15: R\$ 16,67  
30: R\$ 17,00 45: R\$ 17,34 60: R\$ 17,69



CABO HDMI 1,8MTS ENTRADA SAIDA HDMI 9367  
Código: Fábrica: Unidade:  
**26792** IDEA UN/1  
F1 F4

UN: R\$ 52,39 AV: R\$ 52,39 15: R\$ 53,48  
30: R\$ 54,55 45: R\$ 55,64 60: R\$ 56,75



CABO P/REBOQUE 4MTSX10MM 6345  
Código: Fábrica: Unidade:  
**40073** IDEA UN/1  
F1 F4

UN: R\$ 6,15 AV: R\$ 6,15 15: R\$ 6,28  
30: R\$ 6,41 45: R\$ 6,53 60: R\$ 6,67



CABO RCA DVD AUDIO VIDEO 1,5 MTS CTL 37  
Código: Fábrica: Unidade:  
**41559** ENCARTE UTIL UN/1  
F1 F4

UN: R\$ 5,95 AV: R\$ 5,95 15: R\$ 6,08  
30: R\$ 6,20 45: R\$ 6,32 60: R\$ 6,45



CABO RCA DVD AUDIO VIDEO 1,5 MTS 12232  
Código: Fábrica: Unidade:  
**22087** YF COMERCIAL UN/1  
F1 F4

UN: R\$ 5,82 AV: R\$ 5,82 15: R\$ 5,95  
30: R\$ 6,07 45: R\$ 6,19 60: R\$ 6,31



CABO RCA DVD AUDIO VIDEO 1,5 MTS 2338  
Código: Fábrica: Unidade:  
**41103** CALIMAX UN/1  
F1 F4

UN: R\$ 5,98 AV: R\$ 5,98 15: R\$ 6,10  
30: R\$ 6,22 45: R\$ 6,35 60: R\$ 6,47



CABO RCA DVD AUDIO VIDEO 1,5 MTS 963  
Código: Fábrica: Unidade:  
**27956** LIVSTAR UN/1  
F1 F4

UN: R\$ 5,14 AV: R\$ 5,14 15: R\$ 5,24  
30: R\$ 5,35 45: R\$ 5,45 60: R\$ 5,56



CADARCO 1,10MTS CORES P/TENIS PAR 56766  
Código: Fábrica: Unidade:  
**40812** BLESSED CR/1  
F1 F4

UN: R\$ 4,37 AV: R\$ 52,49 15: R\$ 53,58  
30: R\$ 54,66 45: R\$ 55,75 60: R\$ 56,86

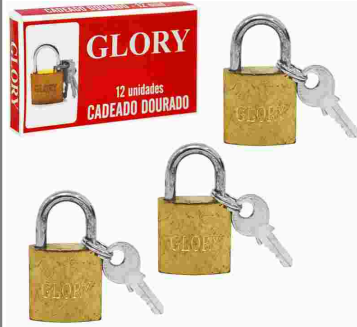

CADEADO 25 MM EMB IND 12X1  
Código: Fábrica: Unidade:  
**10533** HOSSI/GLORY CX/12  
F1 F4

UN: R\$ 6,33 AV: R\$ 6,33 15: R\$ 6,47  
30: R\$ 6,59 45: R\$ 6,73 60: R\$ 6,86



CADEADO 30 MM C/3 CHAVES EMB IND  
Código: Fábrica: Unidade:  
**43082** FELE UN/1  
F1 F4

UN: R\$ 5,95 AV: R\$ 5,95 15: R\$ 6,07  
30: R\$ 6,19 45: R\$ 6,32 60: R\$ 6,44



CADEADO 32 MM C/3 CHAVES EMB IND  
Código: Fábrica: Unidade:  
**45181** FELE UN/1  
F1 F4

UN: R\$ 14,55 AV: R\$ 87,30 15: R\$ 89,12  
30: R\$ 90,90 45: R\$ 92,72 60: R\$ 94,58



CADEADO 32 MM C/3 CHAVES EMB IND 263 6X1  
Código: Fábrica: Unidade:  
**47827** D.C.B CX/6  
F1 F4

UN: R\$ 6,15 AV: R\$ 6,15 15: R\$ 6,28  
30: R\$ 6,41 45: R\$ 6,53 60: R\$ 6,67



CADEADO 35 MM C/3 CHAVES EMB IND  
Código: Fábrica: Unidade:  
**43258** FELE UN/1  
F1 F4

UN: R\$ 6,46 AV: R\$ 6,46 15: R\$ 6,60  
30: R\$ 6,73 45: R\$ 6,86 60: R\$ 7,00



CADEADO 38 MM C/3 CHAVES EMB IND  
Código: Fábrica: Unidade:  
**35265** GLORY UN/1  
F1 F4

UN: R\$ 16,65 AV: R\$ 99,90 15: R\$ 101,98  
30: R\$ 104,02 45: R\$ 106,10 60: R\$ 108,22



CADEADO 38 MM C/3 CHAVES EMB IND 264 6X1  
Código: Fábrica: Unidade:  
**47777** D.C.B CX/6  
F1 F4

UN: R\$ 6,67 AV: R\$ 6,67 15: R\$ 6,81  
30: R\$ 6,94 45: R\$ 7,08 60: R\$ 7,22



CADEADO 40 MM C/3 CHAVES EMB IND  
Código: Fábrica: Unidade:  
**38116** FELE UN/1  
F1 F4

UN: R\$ 29,07 AV: R\$ 174,44 15: R\$ 178,07  
30: R\$ 181,63 45: R\$ 185,27 60: R\$ 188,97

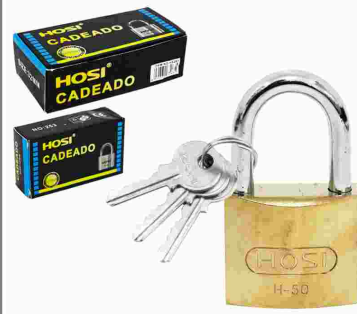

CADEADO 50 MM C/3 CHAVES EMB IND 265 6X1  
Código: Fábrica: Unidade:  
**47784** D.C.B CX/6  
F1 F4

UN: R\$ 9,24 AV: R\$ 9,24 15: R\$ 9,44  
30: R\$ 9,63 45: R\$ 9,82 60: R\$ 10,02



CADEADO 60 MM UN  
Código: Fábrika: Unidade:  
**35267** GLORY UN/1  
F1 F4

UN: R\$ 43,86 AV: R\$ 263,17 15: R\$ 268,65  
30: R\$ 274,02 45: R\$ 279,50 60: R\$ 285,09



CADEADO 63 MM C/3 CHAVES EMB IND 266 6X1  
Código: Fábrika: Unidade:  
**47835** D.C.B CX/6  
F1 F4

UN: R\$ 14,37 AV: R\$ 14,37 15: R\$ 14,67  
30: R\$ 14,96 45: R\$ 15,26 60: R\$ 15,57



CAIXA ACRILICO 19X18CM CORCAO AZUL  
Código: Fábrika: Unidade:  
**50337** QUALYPLAS UN/1  
F1 F4

UN: R\$ 14,37 AV: R\$ 14,37 15: R\$ 14,67  
30: R\$ 14,96 45: R\$ 15,26 60: R\$ 15,57

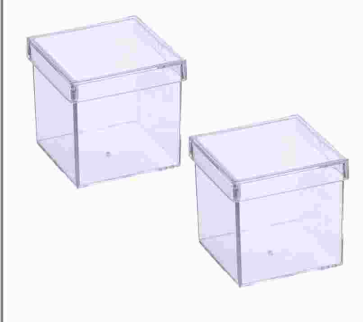

CAIXA ACRILICO 19X18CM CORCAO TRANSP  
Código: Fábrika: Unidade:  
**50336** QUALYPLAS UN/1  
F1 F4

UN: R\$ 1,44 AV: R\$ 14,37 15: R\$ 14,67  
30: R\$ 14,96 45: R\$ 15,26 60: R\$ 15,57

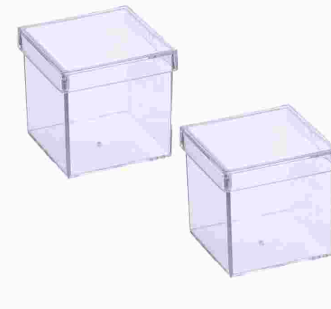

CAIXA ACRILICO 4X4 INCOLOR 1343 10X1  
Código: Fábrika: Unidade:  
**50250** MHP PT/10  
F1 F4

UN: R\$ 5,74 AV: R\$ 68,82 15: R\$ 70,26  
30: R\$ 71,66 45: R\$ 73,09 60: R\$ 74,56



CALCINHA AD MALHA 200 G ESTAMP 12X1  
Código: Fábrika: Unidade:  
**33637** LELE LULU PT/12  
F1 F4

UN: R\$ 5,74 AV: R\$ 68,82 15: R\$ 70,26  
30: R\$ 71,66 45: R\$ 73,09 60: R\$ 74,56



CALCINHA AD MALHA 200 GG ESTAMP 12X1  
Código: Fábrika: Unidade:  
**35705** LELE LULU PT/12  
F1 F4

UN: R\$ 5,74 AV: R\$ 68,82 15: R\$ 70,26  
30: R\$ 71,66 45: R\$ 73,09 60: R\$ 74,56



CALCINHA AD MALHA 200 M ESTAMP 12X1  
Código: Fábrika: Unidade:  
**33636** LELE LULU PT/12  
F1 F4

UN: R\$ 5,74 AV: R\$ 68,82 15: R\$ 70,26  
30: R\$ 71,66 45: R\$ 73,09 60: R\$ 74,56



CALCINHA AD MALHA 200 P ESTAMP 12X1  
Código: Fábrika: Unidade:  
**33635** LELE LULU PT/12  
F1 F4

UN: R\$ 5,74 AV: R\$ 68,82 15: R\$ 70,26  
30: R\$ 71,66 45: R\$ 73,09 60: R\$ 74,56



CALCINHA AD MALHA 200.1 G LISA 12X1  
Código: Fábrika: Unidade:  
**36324** LELE LULU PT/12  
F1 F4

UN: R\$ 5,74 AV: R\$ 68,82 15: R\$ 70,26  
30: R\$ 71,66 45: R\$ 73,09 60: R\$ 74,56



CALCINHA AD MALHA 200.1 GG LISA 12X1  
Código: Fábrika: Unidade:  
**36325** LELE LULU PT/12  
F1 F4

UN: R\$ 5,74 AV: R\$ 68,82 15: R\$ 70,26  
30: R\$ 71,66 45: R\$ 73,09 60: R\$ 74,56



CALCINHA AD MALHA 200.1 M LISA 12X1  
Código: Fábrika: Unidade:  
**36323** LELE LULU PT/12  
F1 F4

UN: R\$ 5,74 AV: R\$ 68,82 15: R\$ 70,26  
30: R\$ 71,66 45: R\$ 73,09 60: R\$ 74,56



CALCINHA AD MALHA 200.1 P LISA 12X1  
Código: Fábrika: Unidade:  
**36322** LELE LULU PT/12  
F1 F4

UN: R\$ 6,76 AV: R\$ 81,15 15: R\$ 82,84  
30: R\$ 84,50 45: R\$ 86,19 60: R\$ 87,91



CALCINHA INF COTTON 205 G ESTAMP 12X1  
Código: Fábrika: Unidade:  
**29544** LELE LULU PT/12  
F1 F4

UN: R\$ 6,76 AV: R\$ 81,15 15: R\$ 82,84  
30: R\$ 84,50 45: R\$ 86,19 60: R\$ 87,91



CALCINHA INF COTTON 205 G LISO 12X1  
Código: Fábrika: Unidade:  
**36328** LELE LULU PT/12  
F1 F4

UN: R\$ 6,76 AV: R\$ 81,15 15: R\$ 82,84  
30: R\$ 84,50 45: R\$ 86,19 60: R\$ 87,91



CALCINHA INF COTTON 205 GG ESTAMP 12X1  
Código: Fábrika: Unidade:  
**35703** LELE LULU PT/12  
F1 F4

UN: R\$ 6,76 AV: R\$ 81,15 15: R\$ 82,84  
30: R\$ 84,50 45: R\$ 86,19 60: R\$ 87,91



CALCINHA INF COTTON 205 GG LISA 12X1  
Código: Fábrika: Unidade:  
**36329** LELE LULU PT/12  
F1 F4

UN: R\$ 6,76 AV: R\$ 81,15 15: R\$ 82,84  
30: R\$ 84,50 45: R\$ 86,19 60: R\$ 87,91



CALCINHA INF COTTON 205 M LISA 12X1  
Código: Fábrika: Unidade:  
**36327** LELE LULU PT/12  
F1 F4

UN: R\$ 6,76 AV: R\$ 81,15 15: R\$ 82,84  
30: R\$ 84,50 45: R\$ 86,19 60: R\$ 87,91



CALCINHA INF COTTON 205 P ESTAMP 12X1  
Código: Fábrika: Unidade:  
**29542** LELE LULU PT/12  
F1 F4

UN: R\$ 6,76 AV: R\$ 81,15 15: R\$ 82,84  
30: R\$ 84,50 45: R\$ 86,19 60: R\$ 87,91



CALCINHA INF COTTON 205 P LISA 12X1  
Código: Fábrika: Unidade:  
**36326** LELE LULU PT/12  
F1 F4

UN: R\$ 5,28 AV: R\$ 63,38 15: R\$ 64,70  
30: R\$ 65,99 45: R\$ 67,31 60: R\$ 68,66



CALCINHA INF MALHA 207 GG ESTAMP 12X1  
Código: Fábrika: Unidade:  
**35704** LELE LULU PT/12  
F1 F4

UN: R\$ 5,28 AV: R\$ 63,38 15: R\$ 64,70  
30: R\$ 65,99 45: R\$ 67,31 60: R\$ 68,66



CALCINHA INF MALHA 207 M ESTAMP 12X1  
Código: Fábrika: Unidade:  
**7836** LELE LULU PT/12  
F1 F4

UN: R\$ 5,28 AV: R\$ 63,38 15: R\$ 64,70  
30: R\$ 65,99 45: R\$ 67,31 60: R\$ 68,66



CALCINHA INF MALHA 207 P ESTAMP 12X1  
Código: Fábrika: Unidade:  
**7835** LELE LULU PT/12  
F1 F4

UN: R\$ 5,28 AV: R\$ 63,38 15: R\$ 64,70  
30: R\$ 65,99 45: R\$ 67,31 60: R\$ 68,66



CALCINHA INF MALHA 207.1 G LISA 12X1  
Código: Fábrika: Unidade:  
**36318** LELE LULU PT/12  
F1 F4

UN: R\$ 5,28 AV: R\$ 63,38 15: R\$ 64,70  
30: R\$ 65,99 45: R\$ 67,31 60: R\$ 68,66



CALCINHA INF MALHA 207.1 GG LISA 12X1  
Código: Fábrika: Unidade:  
**36319** LELE LULU PT/12  
F1 F4

UN: R\$ 5,28 AV: R\$ 63,38 15: R\$ 64,70  
30: R\$ 65,99 45: R\$ 67,31 60: R\$ 68,66



CALCINHA INF MALHA 207.1 M LISA 12X1  
Código: Fábrika: Unidade:  
**36317** LELE LULU PT/12  
F1 F4

UN: R\$ 5,28 AV: R\$ 63,38 15: R\$ 64,70  
30: R\$ 65,99 45: R\$ 67,31 60: R\$ 68,66



CALCINHA INF MALHA 207.1 P LISA 12X1  
Código: Fábrika: Unidade:  
**36316** LELE LULU PT/12  
F1 F4

UN: R\$ 8,78 AV: R\$ 52,70 15: R\$ 53,79  
30: R\$ 54,87 45: R\$ 55,97 60: R\$ 57,09



CALCOLA MALHA 201 G ESTAMP 6X1  
Código: Fábrika: Unidade:  
**22011** LELE LULU PT/6  
F1 F4

UN: R\$ 8,78 AV: R\$ 52,70 15: R\$ 53,79  
30: R\$ 54,87 45: R\$ 55,97 60: R\$ 57,09



CALCOLA MALHA 201 GG ESTAMP 6X1  
Código: Fábrika: Unidade:  
**22012** LELE LULU PT/6  
F1 F4

UN: R\$ 8,78 AV: R\$ 52,70 15: R\$ 53,79  
30: R\$ 54,87 45: R\$ 55,97 60: R\$ 57,09



CALCOLA MALHA 201 M ESTAMP 6X1  
Código: Fábrika: Unidade:  
**22010** LELE LULU PT/6  
F1 F4

UN: R\$ 21,57 AV: R\$ 21,57 15: R\$ 22,02  
30: R\$ 22,46 45: R\$ 22,91 60: R\$ 23,37



CAMISA ATLETICO SIMPLES  
Código: Fábrika: Unidade:  
**26170** CJL UN/1  
F4

UN: R\$ 51,35 AV: R\$ 51,35 15: R\$ 52,42  
30: R\$ 53,47 45: R\$ 54,54 60: R\$ 55,63



CAMPANHIA 32 MUSICAS ALCANCE 100MTS 1142  
Código: Fábrika: Unidade:  
**40920** WINMAX UN/1  
F1 F4

UN: R\$ 16,98 AV: R\$ 16,98 15: R\$ 17,33  
30: R\$ 17,68 45: R\$ 18,03 60: R\$ 18,39



CANELEIRA ADULTO G 37028G

Código: Fábrica: Unidade:  
**48338** CONVOY SPORT UN/1  
F1 F4

UN: R\$ 16,98 AV: R\$ 16,98 15: R\$ 17,33  
30: R\$ 17,68 45: R\$ 18,03 60: R\$ 18,39



CANELEIRA ADULTO G 37030G

Código: Fábrica: Unidade:  
**48339** CONVOY SPORT UN/1  
F1 F4

UN: R\$ 18,88 AV: R\$ 18,88 15: R\$ 19,27  
30: R\$ 19,66 45: R\$ 20,05 60: R\$ 20,45



CANELEIRA ADULTO M 37028M

Código: Fábrica: Unidade:  
**48336** CONVOY SPORT UN/1  
F1 F4

UN: R\$ 16,59 AV: R\$ 16,59 15: R\$ 16,93  
30: R\$ 17,27 45: R\$ 17,62 60: R\$ 17,97



CANELEIRA ADULTO M 37030M

Código: Fábrica: Unidade:  
**48337** CONVOY SPORT UN/1  
F1 F4

UN: R\$ 16,59 AV: R\$ 16,59 15: R\$ 16,93  
30: R\$ 17,27 45: R\$ 17,62 60: R\$ 17,97



CANELEIRA ADULTO P 37028P

Código: Fábrica: Unidade:  
**48334** CONVOY SPORT UN/1  
F1 F4

UN: R\$ 16,59 AV: R\$ 16,59 15: R\$ 16,93  
30: R\$ 17,27 45: R\$ 17,62 60: R\$ 17,97



CANELEIRA ADULTO P 37030P

Código: Fábrica: Unidade:  
**48335** CONVOY SPORT UN/1  
F1 F4

UN: R\$ 32,86 AV: R\$ 32,86 15: R\$ 33,54  
30: R\$ 34,22 45: R\$ 34,90 60: R\$ 35,60



CANELEIRA INFANT C/TORNOZELEIRA CRISTAL

Código: Fábrica: Unidade:  
**22584** OFF SIDE UN/1  
F1 F4

UN: R\$ 4,06 AV: R\$ 4,06 15: R\$ 4,15  
30: R\$ 4,23 45: R\$ 4,32 60: R\$ 4,40



CANETA MARCA CD/DVD 7682 UN

Código: Fábrica: Unidade:  
**21579** YIN'S PAPER UN/1  
F1 F4

UN: R\$ 1,81 AV: R\$ 10,84 15: R\$ 11,06  
30: R\$ 11,28 45: R\$ 11,51 60: R\$ 11,74



CANTONEIRA FERRO REFORCO CANTO 6,5CM 6X1

Código: Fábrica: Unidade:  
**51101** BESTFER PT/6  
F1 F4

UN: R\$ 27,72 AV: R\$ 27,72 15: R\$ 28,30  
30: R\$ 28,87 45: R\$ 29,45 60: R\$ 30,03



CAPA CHUVA INF PVC CAPUZ UNISSEX 10A 31A

Código: Fábrica: Unidade:  
**22978** HIMEB UN/1  
F1 F4

UN: R\$ 25,67 AV: R\$ 25,67 15: R\$ 26,20  
30: R\$ 26,73 45: R\$ 27,26 60: R\$ 27,81



CAPA CHUVA INF PVC CAPUZ UNISSEX 6A 195A

Código: Fábrica: Unidade:  
**36450** HIMEB UN/1  
F1 F4

UN: R\$ 5,44 AV: R\$ 5,44 15: R\$ 5,56  
30: R\$ 5,67 45: R\$ 5,78 60: R\$ 5,90



CAPA CHUVA PLAST ADULTO 3057

Código: Fábrica: Unidade:  
**40772** KEY UN/1  
F1 F4

UN: R\$ 6,16 AV: R\$ 6,16 15: R\$ 6,29  
30: R\$ 6,42 45: R\$ 6,55 60: R\$ 6,68



CAPA CHUVA PLAST ADULTO 4978

Código: Fábrica: Unidade:  
**40771** KEY UN/1  
F1 F4

UN: R\$ 10,17 AV: R\$ 10,17 15: R\$ 10,38  
30: R\$ 10,59 45: R\$ 10,80 60: R\$ 11,02



CAPA CHUVA PLAST ADULTO 9210

Código: Fábrica: Unidade:  
**40769** KEY UN/1  
F1 F4

UN: R\$ 5,65 AV: R\$ 5,65 15: R\$ 5,77  
30: R\$ 5,88 45: R\$ 6,00 60: R\$ 6,12



CAPA CHUVA PLAST ADULTO 9517

Código: Fábrica: Unidade:  
**40770** KEY UN/1  
F1 F4

UN: R\$ 9,35 AV: R\$ 9,35 15: R\$ 9,54  
30: R\$ 9,73 45: R\$ 9,93 60: R\$ 10,13



CAPA PLAST IMPERMEAVEL P/CELULAR 1024

Código: Fábrica: Unidade:  
**38222** AGUIABRANCA UN/1  
F1 F4

UN: R\$ 5,13 AV: R\$ 5,13 15: R\$ 5,23  
30: R\$ 5,34 45: R\$ 5,44 60: R\$ 5,55



CAPA P/MAQUINA DIGITAL HA2005  
Código: Fábrika: Unidade:  
**14555** HAI BRASIL UN/1  
F1 F4

UN: R\$ 25,63 AV: R\$ 25,63 15: R\$ 26,16  
30: R\$ 26,69 45: R\$ 27,22 60: R\$ 27,76



CARREGADOR CELULAR TPC 1.5A XC-CP-C  
Código: Fábrika: Unidade:  
**44300** X-CELL UN/1  
F1 F4

UN: R\$ 12,17 AV: R\$ 12,17 15: R\$ 12,43  
30: R\$ 12,67 45: R\$ 12,93 60: R\$ 13,19



CARREGADOR CELULAR V8 1A BIVOLT  
Código: Fábrika: Unidade:  
**48894** DOTCELL UN/1  
F1 F4

UN: R\$ 23,73 AV: R\$ 23,73 15: R\$ 24,22  
30: R\$ 24,71 45: R\$ 25,20 60: R\$ 25,71



CARREGADOR CELULAR V8 1.5A XC-V8  
Código: Fábrika: Unidade:  
**44303** X-CELL UN/1  
F1 F4

UN: R\$ 51,35 AV: R\$ 51,35 15: R\$ 52,42  
30: R\$ 53,47 45: R\$ 54,54 60: R\$ 55,63



CARREGADOR PILHA AA/AAA/9V BIVOLT  
Código: Fábrika: Unidade:  
**23664** INOVA UN/1  
F1 F4

UN: R\$ 12,83 AV: R\$ 12,83 15: R\$ 13,10  
30: R\$ 13,36 45: R\$ 13,62 60: R\$ 13,90



CARREGADOR USB CELULAR UNIV DIGITAL 7003  
Código: Fábrika: Unidade:  
**25013** INOVA UN/1  
F1 F4

UN: R\$ 32,10 AV: R\$ 32,10 15: R\$ 32,77  
30: R\$ 33,42 45: R\$ 34,09 60: R\$ 34,77



CARREGADOR 1 USB C/FIO IPHO 12W 2,4A 191  
Código: Fábrika: Unidade:  
**48453** MAKETECH UN/1  
F1 F4

UN: R\$ 32,10 AV: R\$ 32,10 15: R\$ 32,77  
30: R\$ 33,42 45: R\$ 34,09 60: R\$ 34,77



CARREGADOR 1 USB C/FIO TPC 12W/2,4A 19C  
Código: Fábrika: Unidade:  
**48451** MAKETECH UN/1  
F1 F4

UN: R\$ 10,49 AV: R\$ 10,49 15: R\$ 10,71  
30: R\$ 10,93 45: R\$ 11,15 60: R\$ 11,37



CARREGADOR 1 USB C/FIO TPC 3.1A 8201  
Código: Fábrika: Unidade:  
**50154** INOVA UN/1  
F1 F4

UN: R\$ 16,33 AV: R\$ 16,33 15: R\$ 16,67  
30: R\$ 17,00 45: R\$ 17,34 60: R\$ 17,69



CARREGADOR 1 USB C/FIO V8 8112/8293  
Código: Fábrika: Unidade:  
**36060** INOVA UN/1  
F1 F4

UN: R\$ 29,17 AV: R\$ 29,17 15: R\$ 29,78  
30: R\$ 30,37 45: R\$ 30,98 60: R\$ 31,60



CARREGADOR 1 USB S/FIO 12W 2,4A BC 19  
Código: Fábrika: Unidade:  
**48449** MAKETECH UN/1  
F1 F4

UN: R\$ 37,64 AV: R\$ 37,64 15: R\$ 38,43  
30: R\$ 39,20 45: R\$ 39,98 60: R\$ 40,78



CARREGADOR 1 USB V8 C/FIO 2.1A 74507  
Código: Fábrika: Unidade:  
**48178** LETRON UN/1  
F1 F4

UN: R\$ 36,17 AV: R\$ 36,17 15: R\$ 36,93  
30: R\$ 37,67 45: R\$ 38,42 60: R\$ 39,19



CARREGADOR 2 USB C/FIO IPHONE 2,4A 1091  
Código: Fábrika: Unidade:  
**48454** MAKET/KNUP UN/1  
F1 F4

UN: R\$ 12,83 AV: R\$ 12,83 15: R\$ 13,10  
30: R\$ 13,36 45: R\$ 13,62 60: R\$ 13,90



CARREGADOR 2 USB C/FIO TPC 3.1A 395/9015  
Código: Fábrika: Unidade:  
**41246** INOVA UN/1  
F1 F4

UN: R\$ 20,43 AV: R\$ 20,43 15: R\$ 20,85  
30: R\$ 21,27 45: R\$ 21,69 60: R\$ 22,13



CARREGADOR 2 USB C/FIO TPC 5.1A 373/9059  
Código: Fábrika: Unidade:  
**48438** KAPB/LELONG UN/1  
F1 F4

UN: R\$ 29,17 AV: R\$ 29,17 15: R\$ 29,78  
30: R\$ 30,37 45: R\$ 30,98 60: R\$ 31,60



CARREGADOR 2 USB C/FIO V8 3.1A CA26/34  
Código: Fábrika: Unidade:  
**45156** INOVA/GOLD UN/1  
F1 F4

UN: R\$ 15,16 AV: R\$ 15,16 15: R\$ 15,48  
30: R\$ 15,79 45: R\$ 16,10 60: R\$ 16,43



CARREGADOR 2 USB C/FIO V8 4.8A 5223  
Código: Fábrika: Unidade:  
**35331** INOVA UN/1  
F1 F4

UN: R\$ 31,50 AV: R\$ 31,50 15: R\$ 32,16  
30: R\$ 32,80 45: R\$ 33,46 60: R\$ 34,13



CARREGADOR 2 USB C/FIO V8 5.1A 233  
Código: Fábrika: Unidade:  
**47939** LELONG UN/1  
F1 F4

UN: R\$ 18,66 AV: R\$ 18,66 15: R\$ 19,05  
30: R\$ 19,43 45: R\$ 19,82 60: R\$ 20,22



CARREGADOR 2 USB C/FIO V8 5.1A 9059/373  
Código: Fábrika: Unidade:  
**48439** KAPBOM UN/1  
F1 F4

UN: R\$ 26,84 AV: R\$ 26,84 15: R\$ 27,39  
30: R\$ 27,94 45: R\$ 28,50 60: R\$ 29,07



CARREGADOR 2 USB S/FIO 12W 2,4A BC 109  
Código: Fábrika: Unidade:  
**48452** MAKETECH UN/1  
F1 F4

UN: R\$ 35,01 AV: R\$ 35,01 15: R\$ 35,74  
30: R\$ 36,45 45: R\$ 37,18 60: R\$ 37,92



CARREGADOR 3 USB C/FIO TPC 5.1A 3250  
Código: Fábrika: Unidade:  
**38756** INOVA UN/1  
F1 F4

UN: R\$ 46,21 AV: R\$ 46,21 15: R\$ 47,18  
30: R\$ 48,12 45: R\$ 49,08 60: R\$ 50,06



CARTÃO MEMÓRIA 16 GB  
Código: Fábrika: Unidade:  
**49120** SANDISK UN/1  
F4

UN: R\$ 7,19 AV: R\$ 7,19 15: R\$ 7,34  
30: R\$ 7,49 45: R\$ 7,64 60: R\$ 7,79



CARTEIRA INF C/ZIPER CRUZ  
Código: Fábrika: Unidade:  
**26710** NEW CELL UN/1  
F1 F4

UN: R\$ 4,10 AV: R\$ 4,10 15: R\$ 4,18  
30: R\$ 4,27 45: R\$ 4,35 60: R\$ 4,44



CARTEIRA SLIM TP COURO PORTA CARTAO/CNH  
Código: Fábrika: Unidade:  
**41525** 3G UN/1  
F1 F4

UN: R\$ 14,37 AV: R\$ 14,37 15: R\$ 14,67  
30: R\$ 14,96 45: R\$ 15,26 60: R\$ 15,57



CARTEIRA TP COURO S/CX  
Código: Fábrika: Unidade:  
**28815** CJL UN/1  
F1 F4

UN: R\$ 18,99 AV: R\$ 18,99 15: R\$ 18,99  
30: R\$ 18,99 45: R\$ 18,99 60: R\$ 18,99



CHAPEU AD BUCKET POLIESTER APL REF 9172  
Código: Fábrika: Unidade:  
**41824** GLX UN/1  
F1 F4

UN: R\$ 30,27 AV: R\$ 30,27 15: R\$ 30,90  
30: R\$ 31,52 45: R\$ 32,15 60: R\$ 32,79



CHAPEU MASC FED 3906  
Código: Fábrika: Unidade:  
**38341** IDEA UN/1  
F1 F4

UN: R\$ 7,19 AV: R\$ 7,19 15: R\$ 7,34  
30: R\$ 7,49 45: R\$ 7,64 60: R\$ 7,79



CHAPEU PAGODEIRO MALANDRINHO XADREZ  
Código: Fábrika: Unidade:  
**38672** CJL UN/1  
F1 F4

UN: R\$ 7,19 AV: R\$ 7,19 15: R\$ 7,34  
30: R\$ 7,49 45: R\$ 7,64 60: R\$ 7,79



CHAPEU PAGODEIRO MALANDRINHO 38467-004  
Código: Fábrika: Unidade:  
**38676** CJL UN/1  
F1 F4

UN: R\$ 24,64 AV: R\$ 24,64 15: R\$ 25,16  
30: R\$ 25,66 45: R\$ 26,17 60: R\$ 26,70



CHAPEU PALHA ANA RAI0 SIMPLES 675  
Código: Fábrika: Unidade:  
**35370** KOPAL UN/1  
F1 F4

UN: R\$ 24,64 AV: R\$ 24,64 15: R\$ 25,16  
30: R\$ 25,66 45: R\$ 26,17 60: R\$ 26,70



CHAPEU PALHA BARUC 756  
Código: Fábrika: Unidade:  
**50887** SAMIA UN/1  
F1 F4

UN: R\$ 5,43 AV: R\$ 5,43 15: R\$ 5,55  
30: R\$ 5,66 45: R\$ 5,77 60: R\$ 5,89



CHAPEU PALHA BONECA 621  
Código: Fábrika: Unidade:  
**44456** KOPAL UN/1  
F1 F4

11 cm

UN: R\$ 19,51 AV: R\$ 19,51 15: R\$ 19,91  
30: R\$ 20,31 45: R\$ 20,72 60: R\$ 21,13



CHAPEU PALHA BRASILIA/PEROLA SIMPLES 731

Código: Fábrica: Unidade:  
**22507** SAMIA UN/1  
F1 F4

UN: R\$ 17,30 AV: R\$ 17,30 15: R\$ 17,66  
30: R\$ 18,01 45: R\$ 18,37 60: R\$ 18,74

29 cm



CHAPEU PALHA C/ RENDA FITA 700

Código: Fábrica: Unidade:  
**35031** SAMIA UN/1  
F1 F4

UN: R\$ 19,99 AV: R\$ 19,99 15: R\$ 19,99  
30: R\$ 19,99 45: R\$ 19,99 60: R\$ 19,99



CHAPEU PALHA COWBOY C/CORDAO NATURA 7508

Código: Fábrica: Unidade:  
**44478** GLX UN/1  
F1 F4

UN: R\$ 27,12 AV: R\$ 27,12 15: R\$ 27,68  
30: R\$ 28,24 45: R\$ 28,80 60: R\$ 29,38



CHAPEU PALHA COWBOY PANTANEIRO 772

Código: Fábrica: Unidade:  
**50888** SAMIA UN/1  
F1 F4

UN: R\$ 17,62 AV: R\$ 17,62 15: R\$ 17,98  
30: R\$ 18,34 45: R\$ 18,71 60: R\$ 19,08



CHAPEU PALHA C/RENDA TRANCA 720

Código: Fábrica: Unidade:  
**17903** SAMIA UN/1  
F1 F4

UN: R\$ 8,99 AV: R\$ 8,99 15: R\$ 8,99  
30: R\$ 8,99 45: R\$ 8,99 60: R\$ 8,99



CHAPEU PALHA DESFIADO CARAVANA 715

Código: Fábrica: Unidade:  
**11435** SAMIA UN/1  
F1 F4

UN: R\$ 13,79 AV: R\$ 13,79 15: R\$ 14,07  
30: R\$ 14,35 45: R\$ 14,64 60: R\$ 14,93



CHAPEU PALHA DESFIADO CRISTAL 719

Código: Fábrica: Unidade:  
**44458** SAMIA UN/1  
F1 F4

UN: R\$ 18,89 AV: R\$ 18,89 15: R\$ 19,28  
30: R\$ 19,67 45: R\$ 20,06 60: R\$ 20,46

31 cm



CHAPEU PALHA ESTAMPADO C/TRANCAS 711

Código: Fábrica: Unidade:  
**35030** SAMIA UN/1  
F1 F4

UN: R\$ 17,62 AV: R\$ 17,62 15: R\$ 17,98  
30: R\$ 18,34 45: R\$ 18,71 60: R\$ 19,08



CHAPEU PALHA ESTAMPADO S/TRANCA 701

Código: Fábrica: Unidade:  
**44459** SAMIA UN/1  
F1 F4

UN: R\$ 19,51 AV: R\$ 19,51 15: R\$ 19,91  
30: R\$ 20,31 45: R\$ 20,72 60: R\$ 21,13



CHAPEU PALHA FEM VAZADO C/CORDINHA 504M

Código: Fábrica: Unidade:  
**44489** GLX UN/1  
F1 F4

UN: R\$ 12,32 AV: R\$ 12,32 15: R\$ 12,57  
30: R\$ 12,82 45: R\$ 13,08 60: R\$ 13,34

22 cm



CHAPEU PALHA FOFAO 622

Código: Fábrica: Unidade:  
**44457** KOPAL UN/1  
F1 F4

UN: R\$ 34,63 AV: R\$ 34,63 15: R\$ 35,35  
30: R\$ 36,06 45: R\$ 36,78 60: R\$ 37,51

63 cm



CHAPEU PALHA GIGANTE MEXICANO 734/0093

Código: Fábrica: Unidade:  
**20043** MAZA UN/1  
F1 F4

UN: R\$ 24,72 AV: R\$ 24,72 15: R\$ 25,24  
30: R\$ 25,74 45: R\$ 26,26 60: R\$ 26,78

40 cm



CHAPEU PALHA GIGANTINHO 733

Código: Fábrica: Unidade:  
**35032** SAMIA UN/1  
F1 F4

UN: R\$ 15,40 AV: R\$ 15,40 15: R\$ 15,72  
30: R\$ 16,03 45: R\$ 16,35 60: R\$ 16,68



CHAPEU PALHA MALANDRINHO 624/724

Código: Fábrica: Unidade:  
**22148** KOPAL UN/1  
F1 F4

UN: R\$ 2,66 AV: R\$ 2,66 15: R\$ 2,72  
30: R\$ 2,77 45: R\$ 2,83 60: R\$ 2,88

7 cm



CHAPEU PALHA MINIATURA 602

Código: Fábrica: Unidade:  
**44455** KOPAL UN/1  
F1 F4

UN: R\$ 27,12 AV: R\$ 27,12 15: R\$ 27,68  
30: R\$ 28,24 45: R\$ 28,80 60: R\$ 29,38



CHAPEU PALHA PANAMA PANTANEIRO 794

Código: Fábrica: Unidade:  
**50889** SAMIA UN/1  
F1 F4

UN: R\$ 19,51 AV: R\$ 19,51 15: R\$ 19,91  
30: R\$ 20,31 45: R\$ 20,72 60: R\$ 21,13



CHAPEU PALHA PANAMA SIMPLES 641

Código: Fábrica: Unidade:  
**22505** KOPAL UN/1  
F1 F4

UN: R\$ 19,51 AV: R\$ 19,51 15: R\$ 19,91  
30: R\$ 20,31 45: R\$ 20,72 60: R\$ 21,13

35 cm



CHAPEU PALHA PANAMA VENTILAD 740/640

Código: Fábrica: Unidade:  
**22508** SAMIA/KOPAL UN/1  
F1 F4

UN: R\$ 27,12 AV: R\$ 27,12 15: R\$ 27,68  
30: R\$ 28,24 45: R\$ 28,80 60: R\$ 29,38



CHAPEU PALHA PANTANEIRO KARANDA GROS 764

Código: Fábrica: Unidade:  
**40144** SAMIA UN/1  
F1 F4

UN: R\$ 32,15 AV: R\$ 32,15 15: R\$ 32,82  
30: R\$ 33,48 45: R\$ 34,15 60: R\$ 34,83

39 cm



CHAPEU PALHA PEROLA DUPLO 745

Código: Fábrica: Unidade:  
**35033** SAMIA UN/1  
F1 F4

UN: R\$ 19,51 AV: R\$ 19,51 15: R\$ 19,91  
30: R\$ 20,31 45: R\$ 20,72 60: R\$ 21,13



CHAPEU PALHA SERTANEJO G S/CORDINHA 504

Código: Fábrica: Unidade:  
**44495** GLX UN/1  
F1 F4

UN: R\$ 19,51 AV: R\$ 19,51 15: R\$ 19,91  
30: R\$ 20,31 45: R\$ 20,72 60: R\$ 21,13



CHAPEU PALHA SERTANEJO M S/CORDINHA 3184

Código: Fábrica: Unidade:  
**44494** GLX UN/1  
F1 F4

UN: R\$ 19,51 AV: R\$ 19,51 15: R\$ 19,91  
30: R\$ 20,31 45: R\$ 20,72 60: R\$ 21,13



CHAPEU PALHA SERTANEJO P C/CORDINHA 504

Código: Fábrica: Unidade:  
**44490** GLX UN/1  
F1 F4

UN: R\$ 24,72 AV: R\$ 24,72 15: R\$ 25,24  
30: R\$ 25,74 45: R\$ 26,26 60: R\$ 26,78

31 cm



CHAPEU PALHA SOCIAL SIMPLES 746

Código: Fábrica: Unidade:  
**21822** SAMIA UN/1  
F1 F4

UN: R\$ 22,26 AV: R\$ 22,26 15: R\$ 22,72  
30: R\$ 23,18 45: R\$ 23,64 60: R\$ 24,11

31 cm



CHAPEU PALHA SOCIAL VENTILADO 748

Código: Fábrica: Unidade:  
**41810** SAMIA UN/1  
F1 F4

UN: R\$ 24,64 AV: R\$ 24,64 15: R\$ 25,16  
30: R\$ 25,66 45: R\$ 26,17 60: R\$ 26,70



CHAPEU PALHA TROPEIRO AZTECA 752

Código: Fábrica: Unidade:  
**50886** SAMIA UN/1  
F1 F4

UN: R\$ 19,51 AV: R\$ 19,51 15: R\$ 19,91  
30: R\$ 20,31 45: R\$ 20,72 60: R\$ 21,13



CHAPEU PALHA TROPEIRO TEXANO SIMPLES 632

Código: Fábrica: Unidade:  
**22509** KOPAL UN/1  
F1 F4

UN: R\$ 16,44 AV: R\$ 16,44 15: R\$ 16,78  
30: R\$ 17,11 45: R\$ 17,46 60: R\$ 17,80



CHAPEU PANAMA 04-10

Código: Fábrica: Unidade:  
**36834** GLX UN/1  
F1 F4

UN: R\$ 22,59 AV: R\$ 22,59 15: R\$ 23,06  
30: R\$ 23,52 45: R\$ 23,99 60: R\$ 24,47



CHAPEU PESCADOR CAMUFLADO 7030-2

Código: Fábrica: Unidade:  
**29434** GLX UN/1  
F1 F4

UN: R\$ 14,37 AV: R\$ 14,37 15: R\$ 14,67  
30: R\$ 14,96 45: R\$ 15,26 60: R\$ 15,57



CHAPEU PESCADOR INFANTIL COLOR 9180

Código: Fábrica: Unidade:  
**41818** GLX UN/1  
F1 F4

UN: R\$ 22,59 AV: R\$ 22,59 15: R\$ 23,06  
30: R\$ 23,52 45: R\$ 23,99 60: R\$ 24,47



CHAPEU PESCADOR LISO COLOR 7032

Código: Fábrica: Unidade:  
**40487** GLX UN/1  
F1 F4

UN: R\$ 24,64 AV: R\$ 24,64 15: R\$ 25,16  
30: R\$ 25,66 45: R\$ 26,17 60: R\$ 26,70



CHAPEU PESCADOR LISO C/TELA 0431

Código: Fábrica: Unidade:  
**49870** IDEA UN/1  
F1 F4

UN: R\$ 41,08 AV: R\$ 41,08 15: R\$ 41,93  
30: R\$ 42,77 45: R\$ 43,63 60: R\$ 44,50



CHAPEU SERTANEJO COUNTRY

Código: Fábrika: Unidade:  
**28039** SERTANEJO UN/1  
F1 F4

UN: R\$ 20,53 AV: R\$ 20,53 15: R\$ 20,96  
30: R\$ 21,38 45: R\$ 21,81 60: R\$ 22,24



CHAPEU TURISTA BRASIL/COPA

Código: Fábrika: Unidade:  
**40657** CJL UN/1  
F1 F4

UN: R\$ 15,99 AV: R\$ 15,99 15: R\$ 15,99  
30: R\$ 15,99 45: R\$ 15,99 60: R\$ 15,99



CHAPEU TURISTA CORES/CAMUFLADO 7030

Código: Fábrika: Unidade:  
**22152** GLX UN/1  
F1 F4

UN: R\$ 1,11 AV: R\$ 13,35 15: R\$ 13,63  
30: R\$ 13,90 45: R\$ 14,18 60: R\$ 14,47



CHAVEIRO ACRILICO SORT DEC 671 12X1

Código: Fábrika: Unidade:  
**23671** NOVA AMIZADE PT/12  
F1 F4

UN: R\$ 6,74 AV: R\$ 107,86 15: R\$ 110,10  
30: R\$ 112,31 45: R\$ 114,55 60: R\$ 116,84



CHAVEIRO BOLAS SINUCA MINI 3862 16X1

Código: Fábrika: Unidade:  
**49645** WINMAX CX/16  
F1 F4

UN: R\$ 9,31 AV: R\$ 148,94 15: R\$ 152,05  
30: R\$ 155,09 45: R\$ 158,19 60: R\$ 161,35



CHAVEIRO BOLAS SINUCA PEQ 3861 16X1

Código: Fábrika: Unidade:  
**15903** WINMAX CX/16  
F1 F4

UN: R\$ 3,70 AV: R\$ 44,38 15: R\$ 45,30  
30: R\$ 46,21 45: R\$ 47,13 60: R\$ 48,07  
109 cm



CHAVEIRO BONECA C/TRANCAS MED 12X1

Código: Fábrika: Unidade:  
**33353** CSL DZ/12  
F1 F4

UN: R\$ 5,13 AV: R\$ 5,13 15: R\$ 5,23  
30: R\$ 5,34 45: R\$ 5,44 60: R\$ 5,55



CHAVEIRO C/CORDAO ATLET 1339

Código: Fábrika: Unidade:  
**39798** MILENO UN/1  
F1 F4

UN: R\$ 4,09 AV: R\$ 24,53 15: R\$ 25,04  
30: R\$ 25,54 45: R\$ 26,05 60: R\$ 26,57



CHAVEIRO C/CORDAO ATLET 673 6X1

Código: Fábrika: Unidade:  
**25969** NOVIDADE PT/6  
F1 F4

UN: R\$ 5,13 AV: R\$ 5,13 15: R\$ 5,23  
30: R\$ 5,34 45: R\$ 5,44 60: R\$ 5,55



CHAVEIRO C/CORDAO COLOR 1339

Código: Fábrika: Unidade:  
**39801** MILENO UN/1  
F1 F4

UN: R\$ 5,13 AV: R\$ 5,13 15: R\$ 5,23  
30: R\$ 5,34 45: R\$ 5,44 60: R\$ 5,55



CHAVEIRO C/CORDAO CRUZE 1339

Código: Fábrika: Unidade:  
**39799** MILENO UN/1  
F1 F4

UN: R\$ 4,09 AV: R\$ 24,53 15: R\$ 25,04  
30: R\$ 25,54 45: R\$ 26,05 60: R\$ 26,57



CHAVEIRO C/CORDAO CRUZE 673 6X1

Código: Fábrika: Unidade:  
**25968** NOVIDADE PT/6  
F1 F4

UN: R\$ 12,76 AV: R\$ 12,76 15: R\$ 13,02  
30: R\$ 13,28 45: R\$ 13,55 60: R\$ 13,82



CHAVEIRO METAL ABRIDOR GARRAFA 5295

Código: Fábrika: Unidade:  
**49119** BAL UN/1  
F1 F4

UN: R\$ 11,29 AV: R\$ 11,29 15: R\$ 11,52  
30: R\$ 11,75 45: R\$ 11,99 60: R\$ 12,23



CHAVEIRO METAL ALGEMAS 4679

Código: Fábrika: Unidade:  
**30593** BAL UN/1  
F1 F4

UN: R\$ 25,67 AV: R\$ 25,67 15: R\$ 26,20  
30: R\$ 26,73 45: R\$ 27,26 60: R\$ 27,81



CHAVEIRO METAL AMORTECEDOR 8909

Código: Fábrika: Unidade:  
**35008** BAL UN/1  
F1 F4

UN: R\$ 4,93 AV: R\$ 49,30 15: R\$ 50,32  
30: R\$ 51,33 45: R\$ 52,36 60: R\$ 53,40  
108 cm



CHAVEIRO METAL ANZOL A907 10X1

Código: Fábrika: Unidade:  
**32574** YING FA PT/10  
F1 F4

UN: R\$ 4,11 AV: R\$ 49,30 15: R\$ 50,32  
30: R\$ 51,33 45: R\$ 52,36 60: R\$ 53,40



CHAVEIRO METAL ARGOLA ANZOL 12X1

Código: Fábrica: Unidade:  
**25853** SQ PT/12  
F1 F4

UN: R\$ 24,64 AV: R\$ 24,64 15: R\$ 25,16  
30: R\$ 25,66 45: R\$ 26,17 60: R\$ 26,70



CHAVEIRO METAL BALA FUZIL 8223

Código: Fábrica: Unidade:  
**30601** BAL UN/1  
F1 F4

UN: R\$ 10,26 AV: R\$ 10,26 15: R\$ 10,48  
30: R\$ 10,69 45: R\$ 10,90 60: R\$ 11,12



CHAVEIRO METAL BIBLIA 764/763

Código: Fábrica: Unidade:  
**30608** BAL UN/1  
F1 F4

UN: R\$ 17,45 AV: R\$ 17,45 15: R\$ 17,82  
30: R\$ 18,17 45: R\$ 18,54 60: R\$ 18,91



CHAVEIRO METAL BOLA ATLET 8152

Código: Fábrica: Unidade:  
**30607** BAL UN/1  
F1 F4

UN: R\$ 15,40 AV: R\$ 15,40 15: R\$ 15,72  
30: R\$ 16,03 45: R\$ 16,35 60: R\$ 16,68



CHAVEIRO METAL CAO ARTICULADO 8610

Código: Fábrica: Unidade:  
**30579** BAL UN/1  
F1 F4

UN: R\$ 8,21 AV: R\$ 8,21 15: R\$ 8,38  
30: R\$ 8,55 45: R\$ 8,72 60: R\$ 8,89



CHAVEIRO METAL CAO BEAGLE 8676

Código: Fábrica: Unidade:  
**30582** BAL UN/1  
F1 F4

UN: R\$ 8,21 AV: R\$ 8,21 15: R\$ 8,38  
30: R\$ 8,55 45: R\$ 8,72 60: R\$ 8,89



CHAVEIRO METAL CAO DASCHUND 8672

Código: Fábrica: Unidade:  
**30580** BAL UN/1  
F1 F4

UN: R\$ 8,21 AV: R\$ 8,21 15: R\$ 8,38  
30: R\$ 8,55 45: R\$ 8,72 60: R\$ 8,89



CHAVEIRO METAL CAO LABRADOR 8658

Código: Fábrica: Unidade:  
**30588** BAL UN/1  
F1 F4

UN: R\$ 8,21 AV: R\$ 8,21 15: R\$ 8,38  
30: R\$ 8,55 45: R\$ 8,72 60: R\$ 8,89



CHAVEIRO METAL CAO LHASA APSO 8655

Código: Fábrica: Unidade:  
**30583** BAL UN/1  
F1 F4

UN: R\$ 8,21 AV: R\$ 8,21 15: R\$ 8,38  
30: R\$ 8,55 45: R\$ 8,72 60: R\$ 8,89



CHAVEIRO METAL CAO MALTES 8656

Código: Fábrica: Unidade:  
**30655** BAL UN/1  
F1 F4

UN: R\$ 8,21 AV: R\$ 8,21 15: R\$ 8,38  
30: R\$ 8,55 45: R\$ 8,72 60: R\$ 8,89



CHAVEIRO METAL CAO PINSCHER 8660

Código: Fábrica: Unidade:  
**30584** BAL UN/1  
F1 F4

UN: R\$ 8,21 AV: R\$ 8,21 15: R\$ 8,38  
30: R\$ 8,55 45: R\$ 8,72 60: R\$ 8,89



CHAVEIRO METAL CAO POODLE 8677/8177

Código: Fábrica: Unidade:  
**30581** BAL UN/1  
F1 F4

UN: R\$ 8,21 AV: R\$ 8,21 15: R\$ 8,38  
30: R\$ 8,55 45: R\$ 8,72 60: R\$ 8,89



CHAVEIRO METAL CAO YORKSHIRE 8673

Código: Fábrica: Unidade:  
**30586** BAL UN/1  
F1 F4

UN: R\$ 9,60 AV: R\$ 9,60 15: R\$ 9,80  
30: R\$ 10,00 45: R\$ 10,20 60: R\$ 10,40



CHAVEIRO METAL CHAPEU N S APARECID 10031

Código: Fábrica: Unidade:  
**40813** BAL UN/1  
F1 F4

UN: R\$ 8,34 AV: R\$ 8,34 15: R\$ 8,51  
30: R\$ 8,68 45: R\$ 8,86 60: R\$ 9,04



CHAVEIRO METAL CHUTEIRA BRASIL 8450

Código: Fábrica: Unidade:  
**30889** BAL UN/1  
F1 F4

UN: R\$ 11,66 AV: R\$ 11,66 15: R\$ 11,90  
30: R\$ 12,14 45: R\$ 12,38 60: R\$ 12,63



CHAVEIRO METAL COUNTRY BERRANTE 10033

Código: Fábrica: Unidade:  
**30618** BAL UN/1  
F1 F4

UN: R\$ 7,63 AV: R\$ 7,63 15: R\$ 7,79  
30: R\$ 7,95 45: R\$ 8,11 60: R\$ 8,27



CHAVEIRO METAL COUNTRY BOTA VAQUEJA 6157  
Código: Fábrica: Unidade:  
**30620** BAL UN/1  
F1 F4

UN: R\$ 12,32 AV: R\$ 12,32 15: R\$ 12,57  
30: R\$ 12,82 45: R\$ 13,08 60: R\$ 13,34



CHAVEIRO METAL COUNTRY BOTA 3776  
Código: Fábrica: Unidade:  
**30619** BAL UN/1  
F1 F4

UN: R\$ 19,51 AV: R\$ 19,51 15: R\$ 19,91  
30: R\$ 20,31 45: R\$ 20,72 60: R\$ 21,13



CHAVEIRO METAL COUNTRY CAVALO MOSQU 3667  
Código: Fábrica: Unidade:  
**30703** BAL UN/1  
F1 F4

UN: R\$ 14,37 AV: R\$ 14,37 15: R\$ 14,67  
30: R\$ 14,96 45: R\$ 15,26 60: R\$ 15,57



CHAVEIRO METAL COUNTRY CAVALO 6178  
Código: Fábrica: Unidade:  
**30457** BAL UN/1  
F1 F4

UN: R\$ 14,06 AV: R\$ 14,06 15: R\$ 14,36  
30: R\$ 14,64 45: R\$ 14,94 60: R\$ 15,23



CHAVEIRO METAL COUNTRY CELA CAVALO 9015  
Código: Fábrica: Unidade:  
**31673** BAL UN/1  
F1 F4

UN: R\$ 23,62 AV: R\$ 23,62 15: R\$ 24,11  
30: R\$ 24,59 45: R\$ 25,08 60: R\$ 25,58



CHAVEIRO METAL COUNTRY CHAPEU GDE 2830  
Código: Fábrica: Unidade:  
**35007** BAL UN/1  
F1 F4

UN: R\$ 9,23 AV: R\$ 9,23 15: R\$ 9,43  
30: R\$ 9,62 45: R\$ 9,81 60: R\$ 10,00



CHAVEIRO METAL COUNTRY ESPORA 12529  
Código: Fábrica: Unidade:  
**30415** BAL UN/1  
F1 F4

UN: R\$ 18,48 AV: R\$ 18,48 15: R\$ 18,96  
30: R\$ 19,24 45: R\$ 19,63 60: R\$ 20,02



CHAVEIRO METAL COUNTRY FERRAD CAVAL 4867  
Código: Fábrica: Unidade:  
**30416** BAL UN/1  
F1 F4

UN: R\$ 11,29 AV: R\$ 11,29 15: R\$ 11,52  
30: R\$ 11,75 45: R\$ 11,99 60: R\$ 12,23



CHAVEIRO METAL COUNTRY FERRADURA 3623  
Código: Fábrica: Unidade:  
**30417** BAL UN/1  
F1 F4

UN: R\$ 35,94 AV: R\$ 35,94 15: R\$ 36,69  
30: R\$ 37,42 45: R\$ 38,17 60: R\$ 38,94



CHAVEIRO METAL CRUCIFIXO 12769  
Código: Fábrica: Unidade:  
**35921** BAL UN/1  
F1 F4

UN: R\$ 16,42 AV: R\$ 16,42 15: R\$ 16,77  
30: R\$ 17,10 45: R\$ 17,44 60: R\$ 17,79



CHAVEIRO METAL CRUCIFIXO 139555  
Código: Fábrica: Unidade:  
**40043** BAL UN/1  
F1 F4

UN: R\$ 20,53 AV: R\$ 20,53 15: R\$ 20,96  
30: R\$ 21,38 45: R\$ 21,81 60: R\$ 22,24



CHAVEIRO METAL DIVINO ESPIRITO STO 39261  
Código: Fábrica: Unidade:  
**35920** BAL UN/1  
F1 F4

UN: R\$ 11,29 AV: R\$ 11,29 15: R\$ 11,52  
30: R\$ 11,75 45: R\$ 11,99 60: R\$ 12,23



CHAVEIRO METAL EMOJI 8611  
Código: Fábrica: Unidade:  
**30610** BAL UN/1  
F1 F4

UN: R\$ 11,29 AV: R\$ 11,29 15: R\$ 11,52  
30: R\$ 11,75 45: R\$ 11,99 60: R\$ 12,23



CHAVEIRO METAL ESCUDO FE 30107  
Código: Fábrica: Unidade:  
**30589** BAL UN/1  
F1 F4

UN: R\$ 10,72 AV: R\$ 10,72 15: R\$ 10,95  
30: R\$ 11,17 45: R\$ 11,39 60: R\$ 11,62



CHAVEIRO METAL GATO ARTICULADO 9455  
Código: Fábrica: Unidade:  
**41393** BAL UN/1  
F1 F4

UN: R\$ 8,21 AV: R\$ 8,21 15: R\$ 8,38  
30: R\$ 8,55 45: R\$ 8,72 60: R\$ 8,89



CHAVEIRO METAL GATO MEU BICHANO 8675  
Código: Fábrica: Unidade:  
**30590** BAL UN/1  
F1 F4

UN: R\$ 8,21 AV: R\$ 8,21 15: R\$ 8,38  
30: R\$ 8,55 45: R\$ 8,72 60: R\$ 8,89



CHAVEIRO METAL GATO SIAMES 8674

Código: Fábrika: Unidade:  
**30587** BAL UN/1  
F1 F4

UN: R\$ 8,21 AV: R\$ 8,21 15: R\$ 8,38  
30: R\$ 8,55 45: R\$ 8,72 60: R\$ 8,89



CHAVEIRO METAL GATO 6148

Código: Fábrika: Unidade:  
**30604** BAL UN/1  
F1 F4

UN: R\$ 19,51 AV: R\$ 19,51 15: R\$ 19,91  
30: R\$ 20,31 45: R\$ 20,72 60: R\$ 21,13



CHAVEIRO METAL GROSSO 4670

Código: Fábrika: Unidade:  
**30615** BAL UN/1  
F1 F4

UN: R\$ 17,45 AV: R\$ 17,45 15: R\$ 17,82  
30: R\$ 18,17 45: R\$ 18,54 60: R\$ 18,91



CHAVEIRO METAL GUITARRA 4860

Código: Fábrika: Unidade:  
**30598** BAL UN/1  
F1 F4

UN: R\$ 6,16 AV: R\$ 6,16 15: R\$ 6,29  
30: R\$ 6,42 45: R\$ 6,55 60: R\$ 6,68



CHAVEIRO METAL IMAGEM JESUS QUAD 4250

Código: Fábrika: Unidade:  
**30609** BAL UN/1  
F1 F4

UN: R\$ 11,29 AV: R\$ 11,29 15: R\$ 11,52  
30: R\$ 11,75 45: R\$ 11,99 60: R\$ 12,23



CHAVEIRO METAL IMAGEM JESUS RED 6231

Código: Fábrika: Unidade:  
**30627** BAL UN/1  
F1 F4

UN: R\$ 17,04 AV: R\$ 17,04 15: R\$ 17,40  
30: R\$ 17,74 45: R\$ 18,10 60: R\$ 18,46



CHAVEIRO METAL IMAGEM N S APAREC 13188

Código: Fábrika: Unidade:  
**30702** BAL UN/1  
F1 F4

UN: R\$ 9,57 AV: R\$ 9,57 15: R\$ 9,77  
30: R\$ 9,97 45: R\$ 10,17 60: R\$ 10,37



CHAVEIRO METAL IMAGEM N S APARECID 10054

Código: Fábrika: Unidade:  
**39923** BAL UN/1  
F1 F4

UN: R\$ 13,10 AV: R\$ 13,10 15: R\$ 13,37  
30: R\$ 13,64 45: R\$ 13,91 60: R\$ 14,19



CHAVEIRO METAL IMAGEM N S APARECID 10061

Código: Fábrika: Unidade:  
**42566** BAL UN/1  
F1 F4

UN: R\$ 16,42 AV: R\$ 16,42 15: R\$ 16,77  
30: R\$ 17,10 45: R\$ 17,44 60: R\$ 17,79



CHAVEIRO METAL IMAGEM N S APARECID 10096

Código: Fábrika: Unidade:  
**40046** BAL UN/1  
F1 F4

UN: R\$ 16,95 AV: R\$ 16,95 15: R\$ 17,30  
30: R\$ 17,65 45: R\$ 18,00 60: R\$ 18,36



CHAVEIRO METAL IMAGEM N S APARECID 5287

Código: Fábrika: Unidade:  
**40041** BAL UN/1  
F1 F4

UN: R\$ 13,10 AV: R\$ 13,10 15: R\$ 13,37  
30: R\$ 13,64 45: R\$ 13,91 60: R\$ 14,19



CHAVEIRO METAL IMAGEM N S APARECID 9909

Código: Fábrika: Unidade:  
**48433** BAL UN/1  
F1 F4

UN: R\$ 12,32 AV: R\$ 12,32 15: R\$ 12,57  
30: R\$ 12,82 45: R\$ 13,08 60: R\$ 13,34



CHAVEIRO METAL IMAGEM N S APARECIDA 9188

Código: Fábrika: Unidade:  
**33097** BAL UN/1  
F1 F4

UN: R\$ 9,24 AV: R\$ 9,24 15: R\$ 9,44  
30: R\$ 9,63 45: R\$ 9,82 60: R\$ 10,02



CHAVEIRO METAL IMAGEM N S APARECIDA 9247

Código: Fábrika: Unidade:  
**40042** BAL UN/1  
F1 F4

UN: R\$ 5,14 AV: R\$ 5,14 15: R\$ 5,24  
30: R\$ 5,35 45: R\$ 5,45 60: R\$ 5,56



CHAVEIRO METAL LEME 12748

Código: Fábrika: Unidade:  
**31405** BAL UN/1  
F1 F4

UN: R\$ 10,26 AV: R\$ 10,26 15: R\$ 10,48  
30: R\$ 10,69 45: R\$ 10,90 60: R\$ 11,12



CHAVEIRO METAL MACONARIA 8832/130013

Código: Fábrika: Unidade:  
**30628** BAL UN/1  
F1 F4

UN: R\$ 16,42 AV: R\$ 16,42 15: R\$ 16,77  
30: R\$ 17,10 45: R\$ 17,44 60: R\$ 17,79



CHAVEIRO METAL MANGALARGA MARCHADOR 8183

Código: Fábrica: Unidade:  
**30414** BAL UN/1  
F1 F4

UN: R\$ 14,37 AV: R\$ 14,37 15: R\$ 14,67  
30: R\$ 14,96 45: R\$ 15,26 60: R\$ 15,57



CHAVEIRO METAL MARCAS CARROS VW 9284

Código: Fábrica: Unidade:  
**35767** BAL UN/1  
F1 F4

UN: R\$ 16,42 AV: R\$ 16,42 15: R\$ 16,77  
30: R\$ 17,10 45: R\$ 17,44 60: R\$ 17,79



CHAVEIRO METAL PISTAO E BIELA 13422

Código: Fábrica: Unidade:  
**30626** BAL UN/1  
F1 F4

UN: R\$ 6,66 AV: R\$ 6,66 15: R\$ 6,79  
30: R\$ 6,93 45: R\$ 7,07 60: R\$ 7,21



CHAVEIRO METAL PLACA FRASES 13

Código: Fábrica: Unidade:  
**35916** BAL UN/1  
F1 F4

UN: R\$ 7,80 AV: R\$ 7,80 15: R\$ 7,96  
30: R\$ 8,12 45: R\$ 8,28 60: R\$ 8,45



CHAVEIRO METAL PLACA RES I LOVE BH 9941

Código: Fábrica: Unidade:  
**43080** BAL UN/1  
F1 F4

UN: R\$ 7,18 AV: R\$ 7,18 15: R\$ 7,33  
30: R\$ 7,48 45: R\$ 7,63 60: R\$ 7,78



CHAVEIRO METAL PROFISSAO ADMINISTRACAO

Código: Fábrica: Unidade:  
**36064** BAL UN/1  
F1 F4

UN: R\$ 6,63 AV: R\$ 6,63 15: R\$ 6,76  
30: R\$ 6,90 45: R\$ 7,04 60: R\$ 7,18



CHAVEIRO METAL PROFISSAO ARQUIT URBANISMO

Código: Fábrica: Unidade:  
**36080** BAL UN/1  
F1 F4

UN: R\$ 6,63 AV: R\$ 6,63 15: R\$ 6,76  
30: R\$ 6,90 45: R\$ 7,04 60: R\$ 7,18



CHAVEIRO METAL PROFISSAO CHEFF 13

Código: Fábrica: Unidade:  
**36067** BAL UN/1  
F1 F4

UN: R\$ 6,63 AV: R\$ 6,63 15: R\$ 6,76  
30: R\$ 6,90 45: R\$ 7,04 60: R\$ 7,18



CHAVEIRO METAL PROFISSAO CIENCIAS CONTAB

Código: Fábrica: Unidade:  
**36078** BAL UN/1  
F1 F4

UN: R\$ 7,18 AV: R\$ 7,18 15: R\$ 7,33  
30: R\$ 7,48 45: R\$ 7,63 60: R\$ 7,78



CHAVEIRO METAL PROFISSAO DIREITO 13

Código: Fábrica: Unidade:  
**36071** BAL UN/1  
F1 F4

UN: R\$ 6,63 AV: R\$ 6,63 15: R\$ 6,76  
30: R\$ 6,90 45: R\$ 7,04 60: R\$ 7,18



CHAVEIRO METAL PROFISSAO EDUCACAO FISICA

Código: Fábrica: Unidade:  
**36072** BAL UN/1  
F1 F4

UN: R\$ 7,18 AV: R\$ 7,18 15: R\$ 7,33  
30: R\$ 7,48 45: R\$ 7,63 60: R\$ 7,78



CHAVEIRO METAL PROFISSAO ENFERMAGEM 13

Código: Fábrica: Unidade:  
**36070** BAL UN/1  
F1 F4

UN: R\$ 6,63 AV: R\$ 6,63 15: R\$ 6,76  
30: R\$ 6,90 45: R\$ 7,04 60: R\$ 7,18



CHAVEIRO METAL PROFISSAO ENGENH MECANICA

Código: Fábrica: Unidade:  
**36079** BAL UN/1  
F1 F4

UN: R\$ 6,63 AV: R\$ 6,63 15: R\$ 6,76  
30: R\$ 6,90 45: R\$ 7,04 60: R\$ 7,18



CHAVEIRO METAL PROFISSAO ENGENHAR CIVIL

Código: Fábrica: Unidade:  
**36065** BAL UN/1  
F1 F4

UN: R\$ 7,18 AV: R\$ 7,18 15: R\$ 7,33  
30: R\$ 7,48 45: R\$ 7,63 60: R\$ 7,78



CHAVEIRO METAL PROFISSAO FARMACIA 13

Código: Fábrica: Unidade:  
**36074** BAL UN/1  
F1 F4

UN: R\$ 7,18 AV: R\$ 7,18 15: R\$ 7,33  
30: R\$ 7,48 45: R\$ 7,63 60: R\$ 7,78



CHAVEIRO METAL PROFISSAO FISIOTERAPIA 13

Código: Fábrica: Unidade:  
**36077** BAL UN/1  
F1 F4

UN: R\$ 6,63 AV: R\$ 6,63 15: R\$ 6,76  
30: R\$ 6,90 45: R\$ 7,04 60: R\$ 7,18



CHAVEIRO METAL PROFISSAO MED VETERINARIA

Código: Fábrika: Unidade:  
**36069** BAL UN/1  
F1 F4

UN: R\$ 7,18 AV: R\$ 7,18 15: R\$ 7,33  
30: R\$ 7,48 45: R\$ 7,63 60: R\$ 7,78



CHAVEIRO METAL PROFISSAO MEDICINA 13

Código: Fábrika: Unidade:  
**36075** BAL UN/1  
F1 F4

UN: R\$ 6,63 AV: R\$ 6,63 15: R\$ 6,76  
30: R\$ 6,90 45: R\$ 7,04 60: R\$ 7,18



CHAVEIRO METAL PROFISSAO NUTRICA0 13

Código: Fábrika: Unidade:  
**36063** BAL UN/1  
F1 F4

UN: R\$ 7,18 AV: R\$ 7,18 15: R\$ 7,33  
30: R\$ 7,48 45: R\$ 7,63 60: R\$ 7,78



CHAVEIRO METAL PROFISSAO ODONTOLOGIA 13

Código: Fábrika: Unidade:  
**36076** BAL UN/1  
F1 F4

UN: R\$ 7,18 AV: R\$ 7,18 15: R\$ 7,33  
30: R\$ 7,48 45: R\$ 7,63 60: R\$ 7,78



CHAVEIRO METAL PROFISSAO PEDAGOGIA 13

Código: Fábrika: Unidade:  
**36073** BAL UN/1  
F1 F4

UN: R\$ 6,63 AV: R\$ 6,63 15: R\$ 6,76  
30: R\$ 6,90 45: R\$ 7,04 60: R\$ 7,18



CHAVEIRO METAL PROFISSAO POLICE 13

Código: Fábrika: Unidade:  
**36066** BAL UN/1  
F1 F4

UN: R\$ 7,18 AV: R\$ 7,18 15: R\$ 7,33  
30: R\$ 7,48 45: R\$ 7,63 60: R\$ 7,78



CHAVEIRO METAL PROFISSAO PSICOLOGIA 13

Código: Fábrika: Unidade:  
**36068** BAL UN/1  
F1 F4

UN: R\$ 17,45 AV: R\$ 17,45 15: R\$ 17,82  
30: R\$ 18,17 45: R\$ 18,54 60: R\$ 18,91



CHAVEIRO METAL REVOLVER MAGNUM 6235

Código: Fábrika: Unidade:  
**30592** BAL UN/1  
F1 F4

UN: R\$ 18,48 AV: R\$ 18,48 15: R\$ 18,86  
30: R\$ 19,24 45: R\$ 19,63 60: R\$ 20,02



CHAVEIRO METAL REVOLVER 38 8942

Código: Fábrika: Unidade:  
**30591** BAL UN/1  
F1 F4

UN: R\$ 8,21 AV: R\$ 8,21 15: R\$ 8,38  
30: R\$ 8,55 45: R\$ 8,72 60: R\$ 8,89



CHAVEIRO METAL RODA CHUMBO 941

Código: Fábrika: Unidade:  
**39323** BAL UN/1  
F1 F4

UN: R\$ 9,24 AV: R\$ 9,24 15: R\$ 9,44  
30: R\$ 9,63 45: R\$ 9,82 60: R\$ 10,02



CHAVEIRO METAL SANTO ANJO AZUL 9288

Código: Fábrika: Unidade:  
**40044** BAL UN/1  
F1 F4

UN: R\$ 9,24 AV: R\$ 9,24 15: R\$ 9,44  
30: R\$ 9,63 45: R\$ 9,82 60: R\$ 10,02



CHAVEIRO METAL SANTO ANJO ROSA 9288

Código: Fábrika: Unidade:  
**40045** BAL UN/1  
F1 F4

UN: R\$ 18,48 AV: R\$ 18,48 15: R\$ 18,86  
30: R\$ 19,24 45: R\$ 19,63 60: R\$ 20,02



CHAVEIRO METAL SAO JORGE 92110

Código: Fábrika: Unidade:  
**33152** BAL UN/1  
F1 F4

UN: R\$ 6,63 AV: R\$ 6,63 15: R\$ 6,76  
30: R\$ 6,90 45: R\$ 7,04 60: R\$ 7,18



CHAVEIRO METAL SIGNOS AQUARIO 17

Código: Fábrika: Unidade:  
**35912** BAL UN/1  
F1 F4

UN: R\$ 6,63 AV: R\$ 6,63 15: R\$ 6,76  
30: R\$ 6,90 45: R\$ 7,04 60: R\$ 7,18



CHAVEIRO METAL SIGNOS CANCER 17

Código: Fábrika: Unidade:  
**35905** BAL UN/1  
F1 F4

UN: R\$ 6,63 AV: R\$ 6,63 15: R\$ 6,76  
30: R\$ 6,90 45: R\$ 7,04 60: R\$ 7,18



CHAVEIRO METAL SIGNOS ESCORPIAO 17

Código: Fábrika: Unidade:  
**35909** BAL UN/1  
F1 F4

UN: R\$ 6,63 AV: R\$ 6,63 15: R\$ 6,76  
30: R\$ 6,90 45: R\$ 7,04 60: R\$ 7,18



CHAVEIRO METAL SIGNOS GEMEOS 17  
Código: Fábrica: Unidade:  
**35904** BAL UN/1  
F1 F4

UN: R\$ 6,63 AV: R\$ 6,63 15: R\$ 6,76  
30: R\$ 6,90 45: R\$ 7,04 60: R\$ 7,18



CHAVEIRO METAL SIGNOS LEO 17  
Código: Fábrica: Unidade:  
**35906** BAL UN/1  
F1 F4

UN: R\$ 6,63 AV: R\$ 6,63 15: R\$ 6,76  
30: R\$ 6,90 45: R\$ 7,04 60: R\$ 7,18



CHAVEIRO METAL SIGNOS LIBRA 17  
Código: Fábrica: Unidade:  
**35908** BAL UN/1  
F1 F4

UN: R\$ 6,63 AV: R\$ 6,63 15: R\$ 6,76  
30: R\$ 6,90 45: R\$ 7,04 60: R\$ 7,18



CHAVEIRO METAL SIGNOS PEIXES 17  
Código: Fábrica: Unidade:  
**35913** BAL UN/1  
F1 F4

UN: R\$ 6,63 AV: R\$ 6,63 15: R\$ 6,76  
30: R\$ 6,90 45: R\$ 7,04 60: R\$ 7,18



CHAVEIRO METAL SIGNOS TOURO 17  
Código: Fábrica: Unidade:  
**35903** BAL UN/1  
F1 F4

UN: R\$ 30,81 AV: R\$ 30,81 15: R\$ 31,45  
30: R\$ 32,08 45: R\$ 32,72 60: R\$ 33,37



CHAVEIRO METAL TURBINA CARRO 8834  
Código: Fábrica: Unidade:  
**30621** BAL UN/1  
F1 F4

UN: R\$ 10,26 AV: R\$ 10,26 15: R\$ 10,48  
30: R\$ 10,69 45: R\$ 10,90 60: R\$ 11,12



CHAVEIRO METAL VAZADO 4966  
Código: Fábrica: Unidade:  
**30616** BAL UN/1  
F1 F4

UN: R\$ 6,63 AV: R\$ 6,63 15: R\$ 6,76  
30: R\$ 6,90 45: R\$ 7,04 60: R\$ 7,18



CHAVEIRO METAL VERS BIBLICOS RED 1095  
Código: Fábrica: Unidade:  
**30623** BAL UN/1  
F1 F4

UN: R\$ 5,14 AV: R\$ 5,14 15: R\$ 5,24  
30: R\$ 5,35 45: R\$ 5,45 60: R\$ 5,56



CHAVEIRO METAL VERS BIBLICOS 1096  
Código: Fábrica: Unidade:  
**30617** BAL UN/1  
F1 F4

UN: R\$ 2,04 AV: R\$ 24,53 15: R\$ 25,04  
30: R\$ 25,54 45: R\$ 26,05 60: R\$ 26,57



CHAVEIRO MINI LANTERNA 1 LED 3858 12X1  
Código: Fábrica: Unidade:  
**49614** WINMAX DZ/12  
F1 F4

UN: R\$ 2,74 AV: R\$ 32,86 15: R\$ 33,54  
30: R\$ 34,22 45: R\$ 34,90 60: R\$ 35,60



CHAVEIRO MOSQUETAO METAL MALER 908 12X1  
Código: Fábrica: Unidade:  
**20911** YING FA DZ/12  
F1 F4

UN: R\$ 1,23 AV: R\$ 12,33 15: R\$ 12,58  
30: R\$ 12,83 45: R\$ 13,09 60: R\$ 13,35



CHAVEIRO PLAST BRASIL 10X1  
Código: Fábrica: Unidade:  
**37642** KEY CHAIN PT/10  
F1 F4

UN: R\$ 3,60 AV: R\$ 3,60 15: R\$ 3,67  
30: R\$ 3,74 45: R\$ 3,82 60: R\$ 3,89



CHAVEIRO PLAST NARUTO GDE  
Código: Fábrica: Unidade:  
**37643** KEY CHAIN UN/1  
F4

UN: R\$ 1,23 AV: R\$ 12,33 15: R\$ 12,58  
30: R\$ 12,83 45: R\$ 13,09 60: R\$ 13,35



CHAVEIRO PLAST PANDA KEY GHAIN 10X1  
Código: Fábrica: Unidade:  
**37649** KEY CHAIN PT/10  
F1 F4

UN: R\$ 1,23 AV: R\$ 12,33 15: R\$ 12,58  
30: R\$ 12,83 45: R\$ 13,09 60: R\$ 13,35



CHAVEIRO PLAST SAPO 10X1  
Código: Fábrica: Unidade:  
**37641** KEY CHAIN PT/10  
F1 F4

UN: R\$ 1,02 AV: R\$ 1,02 15: R\$ 1,04  
30: R\$ 1,06 45: R\$ 1,08 60: R\$ 1,10



CHAVEIRO UN  
Código: Fábrica: Unidade:  
**42344** BAL UN/1  
F1 F4

UN: R\$ 8,56 AV: R\$ 102,71 15: R\$ 104,85  
30: R\$ 106,95 45: R\$ 109,09 60: R\$ 111,27



CHINELO AD MASC BCO QUIK 34A44 841 12X1

Código: Fábrika: Unidade:  
**29132** PIATA PT/12  
F1 F4

UN: R\$ 13,66 AV: R\$ 13,66 15: R\$ 13,95  
30: R\$ 14,23 45: R\$ 14,51 60: R\$ 14,80



CHINELO ANATOMIC SURF 37/38 PRETO 25122

Código: Fábrika: Unidade:  
**37798** IPANEMA UN/1  
F1 F4

UN: R\$ 13,66 AV: R\$ 13,66 15: R\$ 13,95  
30: R\$ 14,23 45: R\$ 14,51 60: R\$ 14,80



CHINELO ANATOMIC SURF 39/40 AZUL 25122

Código: Fábrika: Unidade:  
**37795** IPANEMA UN/1  
F1 F4

UN: R\$ 13,66 AV: R\$ 13,66 15: R\$ 13,95  
30: R\$ 14,23 45: R\$ 14,51 60: R\$ 14,80



CHINELO ANATOMIC SURF 39/40 PRETO 25122

Código: Fábrika: Unidade:  
**37799** IPANEMA UN/1  
F1 F4

UN: R\$ 13,66 AV: R\$ 13,66 15: R\$ 13,95  
30: R\$ 14,23 45: R\$ 14,51 60: R\$ 14,80



CHINELO ANATOMIC SURF 41/42 AZUL 25122

Código: Fábrika: Unidade:  
**37796** IPANEMA UN/1  
F1 F4

UN: R\$ 13,66 AV: R\$ 13,66 15: R\$ 13,95  
30: R\$ 14,23 45: R\$ 14,51 60: R\$ 14,80



CHINELO ANATOMIC SURF 41/42 PRETO 25122

Código: Fábrika: Unidade:  
**37800** IPANEMA UN/1  
F1 F4

UN: R\$ 13,66 AV: R\$ 13,66 15: R\$ 13,95  
30: R\$ 14,23 45: R\$ 14,51 60: R\$ 14,80



CHINELO ANATOMIC SURF 43/44 AZUL 25122

Código: Fábrika: Unidade:  
**37797** IPANEMA UN/1  
F1 F4

UN: R\$ 13,66 AV: R\$ 13,66 15: R\$ 13,95  
30: R\$ 14,23 45: R\$ 14,51 60: R\$ 14,80



CHINELO ANATOMIC SURF 43/44 PRETO 25122

Código: Fábrika: Unidade:  
**37801** IPANEMA UN/1  
F1 F4

UN: R\$ 205,43 AV: R\$ 205,43 15: R\$ 209,71  
30: R\$ 213,90 45: R\$ 218,18 60: R\$ 222,55



CHUMBADA ARROZINHO 1 KG

Código: Fábrika: Unidade:  
**50001** FALCAO KG/1  
F1 F4

UN: R\$ 61,62 AV: R\$ 61,62 15: R\$ 62,91  
30: R\$ 64,16 45: R\$ 65,45 60: R\$ 66,76



CHUMBADA OLIVA N 00 1 KG

Código: Fábrika: Unidade:  
**13621** FALCAO KG/1  
F1 F4

UN: R\$ 51,35 AV: R\$ 51,35 15: R\$ 52,42  
30: R\$ 53,47 45: R\$ 54,54 60: R\$ 55,63



CHUMBADA OLIVA N 01 1 KG

Código: Fábrika: Unidade:  
**13612** FALCAO KG/1  
F1 F4

UN: R\$ 51,35 AV: R\$ 51,35 15: R\$ 52,42  
30: R\$ 53,47 45: R\$ 54,54 60: R\$ 55,63



CHUMBADA OLIVA N 02 1 KG

Código: Fábrika: Unidade:  
**13613** FALCAO KG/1  
F1 F4

UN: R\$ 51,35 AV: R\$ 51,35 15: R\$ 52,42  
30: R\$ 53,47 45: R\$ 54,54 60: R\$ 55,63



CHUMBADA OLIVA N 03 1 KG

Código: Fábrika: Unidade:  
**13614** FALCAO KG/1  
F1 F4

UN: R\$ 51,35 AV: R\$ 51,35 15: R\$ 52,42  
30: R\$ 53,47 45: R\$ 54,54 60: R\$ 55,63



CHUMBADA OLIVA N 04 1 KG

Código: Fábrika: Unidade:  
**13615** FALCAO KG/1  
F1 F4

UN: R\$ 51,35 AV: R\$ 51,35 15: R\$ 52,42  
30: R\$ 53,47 45: R\$ 54,54 60: R\$ 55,63



CHUMBADA OLIVA N 05 1 KG

Código: Fábrika: Unidade:  
**13617** FALCAO KG/1  
F1 F4

UN: R\$ 51,35 AV: R\$ 51,35 15: R\$ 52,42  
30: R\$ 53,47 45: R\$ 54,54 60: R\$ 55,63



CHUMBADA OLIVA N 06 1 KG

Código: Fábrika: Unidade:  
**13618** FALCAO KG/1  
F1 F4

UN: R\$ 51,35 AV: R\$ 51,35 15: R\$ 52,42  
30: R\$ 53,47 45: R\$ 54,54 60: R\$ 55,63



CHUMBADA OLIVA N 07 1 KG

Código: Fábrica: Unidade:  
**13619** FALCAO KG/1  
F1 F4

UN: R\$ 51,35 AV: R\$ 51,35 15: R\$ 52,42  
30: R\$ 53,47 45: R\$ 54,54 60: R\$ 55,63



CHUMBADA OLIVA N 08 1 KG

Código: Fábrica: Unidade:  
**13620** FALCAO KG/1  
F1 F4

UN: R\$ 0,11 AV: R\$ 13,34 15: R\$ 13,62  
30: R\$ 13,89 45: R\$ 14,17 60: R\$ 14,46



CHUMBINHO 5.5 DIABOLO 125X1

Código: Fábrica: Unidade:  
**28954** FALCAO CX/125  
F1 F4

UN: R\$ 2,48 AV: R\$ 29,78 15: R\$ 30,40  
30: R\$ 31,01 45: R\$ 31,63 60: R\$ 32,26



CHUVEIRINHO P/TORNEIRA 1022 12X1

Código: Fábrica: Unidade:  
**28868** JWC/MARINI DZ/12  
F1 F4

UN: R\$ 21,56 AV: R\$ 21,56 15: R\$ 22,01  
30: R\$ 22,45 45: R\$ 22,90 60: R\$ 23,36



CINTO COURO SINT CATRACA METALIC 8613/17

Código: Fábrica: Unidade:  
**44484** GLX UN/1  
F1 F4

UN: R\$ 21,56 AV: R\$ 21,56 15: R\$ 22,01  
30: R\$ 22,45 45: R\$ 22,90 60: R\$ 23,36



CINTO COURO SINT FIVELA METALICA 8006

Código: Fábrica: Unidade:  
**44486** GLX UN/1  
F1 F4

UN: R\$ 21,56 AV: R\$ 21,56 15: R\$ 22,01  
30: R\$ 22,45 45: R\$ 22,90 60: R\$ 23,36



CINTO POLIESTER CATRACA METALICA 8605

Código: Fábrica: Unidade:  
**44481** GLX UN/1  
F1 F4

UN: R\$ 21,56 AV: R\$ 21,56 15: R\$ 22,01  
30: R\$ 22,45 45: R\$ 22,90 60: R\$ 23,36



CINTO POLIESTER CATRACA METALICA 8611

Código: Fábrica: Unidade:  
**44483** GLX UN/1  
F1 F4

UN: R\$ 19,51 AV: R\$ 19,51 15: R\$ 19,91  
30: R\$ 20,31 45: R\$ 20,72 60: R\$ 21,13

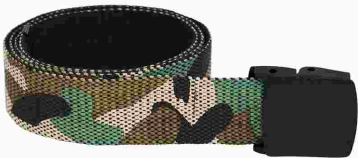

CINTO POLIESTER FIV PLAST CAMUFL 1223 UN

Código: Fábrica: Unidade:  
**50000** GLX UN/1  
F1 F4

UN: R\$ 16,42 AV: R\$ 16,42 15: R\$ 16,77  
30: R\$ 17,10 45: R\$ 17,44 60: R\$ 17,79



CINTO POLIESTER FIVELA METALICA 8609

Código: Fábrica: Unidade:  
**44482** GLX UN/1  
F1 F4

UN: R\$ 14,55 AV: R\$ 174,61 15: R\$ 178,25  
30: R\$ 181,82 45: R\$ 185,45 60: R\$ 189,16



CINTO RASPA COURO SEM COSTURA 12X1

Código: Fábrica: Unidade:  
**17712** CJL PT/12  
F1 F4

UN: R\$ 18,48 AV: R\$ 18,48 15: R\$ 18,86  
30: R\$ 19,24 45: R\$ 19,63 60: R\$ 20,02



CINTO SOCIAL C/CX

Código: Fábrica: Unidade:  
**17131** STREETMAN UN/1  
F1 F4

UN: R\$ 11,17 AV: R\$ 11,17 15: R\$ 11,40  
30: R\$ 11,63 45: R\$ 11,86 60: R\$ 12,10



COFRE GESSO DEC PORCO GDE

Código: Fábrica: Unidade:  
**50166** ASJ UN/1  
F1 F4

UN: R\$ 7,18 AV: R\$ 7,18 15: R\$ 7,33  
30: R\$ 7,48 45: R\$ 7,63 60: R\$ 7,78



COFRE MADEIRA 15CM BOTAFO

Código: Fábrica: Unidade:  
**42263** FEG UN/1  
F1 F4

UN: R\$ 7,18 AV: R\$ 7,18 15: R\$ 7,33  
30: R\$ 7,48 45: R\$ 7,63 60: R\$ 7,78



COFRE MADEIRA 15CM INF FEM

Código: Fábrica: Unidade:  
**36720** FEG UN/1  
F1 F4

UN: R\$ 7,18 AV: R\$ 7,18 15: R\$ 7,33  
30: R\$ 7,48 45: R\$ 7,63 60: R\$ 7,78



COFRE MADEIRA 15CM TIME SANTOS

Código: Fábrica: Unidade:  
**44104** FEG UN/1  
F1 F4

UN: R\$ 7,18 AV: R\$ 7,18 15: R\$ 7,33  
30: R\$ 7,48 45: R\$ 7,63 60: R\$ 7,78



COFRE MADEIRA 15CM VASC

Código: Fábrika: Unidade:  
**42265** FEG UN/1  
F1 F4

UN: R\$ 6,87 AV: R\$ 6,87 15: R\$ 7,02  
30: R\$ 7,16 45: R\$ 7,30 60: R\$ 7,44



COFRE PLAST BOTAJO MED 9298

Código: Fábrika: Unidade:  
**37371** PLASTSANDRI UN/1  
F1 F4

UN: R\$ 16,95 AV: R\$ 16,95 15: R\$ 17,30  
30: R\$ 17,65 45: R\$ 18,00 60: R\$ 18,36



COIFA DE CAMBIO ACESS VEICULOS YT-5

Código: Fábrika: Unidade:  
**33022** HAI BRASIL CR/1  
F1 F4

UN: R\$ 11,29 AV: R\$ 11,29 15: R\$ 11,52  
30: R\$ 11,75 45: R\$ 11,99 60: R\$ 12,23



COLA ADESIVA DE CONTATO 30 GRS 41 CTL

Código: Fábrika: Unidade:  
**49522** FORTCONTACTO UN/1  
F1 F4

UN: R\$ 6,15 AV: R\$ 6,15 15: R\$ 6,28  
30: R\$ 6,41 45: R\$ 6,53 60: R\$ 6,67



COLA ADESIVO INSTANT 5 GRS CTL UN

Código: Fábrika: Unidade:  
**45282** 7 BOND UN/1  
F1 F4

UN: R\$ 9,04 AV: R\$ 90,38 15: R\$ 92,27  
30: R\$ 94,11 45: R\$ 95,99 60: R\$ 97,91



COLA ADESIVO INSTANT 20 GRS 200 10X1

Código: Fábrika: Unidade:  
**38183** 7 BOND CX/10  
F1 F4

UN: R\$ 7,44 AV: R\$ 74,39 15: R\$ 75,94  
30: R\$ 77,46 45: R\$ 79,01 60: R\$ 80,59



COLA ADESIVO INSTANT 20 GRS 40329 10X1

Código: Fábrika: Unidade:  
**48583** REND BOND CX/10  
F1 F4

UN: R\$ 29,79 AV: R\$ 297,88 15: R\$ 304,08  
30: R\$ 310,17 45: R\$ 316,37 60: R\$ 322,70



COLA ADESIVO INSTANT 100 GRS 793 10X1

Código: Fábrika: Unidade:  
**44356** 7 BOND CX/10  
F1 F4

UN: R\$ 13,35 AV: R\$ 133,53 15: R\$ 136,31  
30: R\$ 139,03 45: R\$ 141,81 60: R\$ 144,65



COLA EPOXI BICOMP EXT FORT 16GR CTL 10X1

Código: Fábrika: Unidade:  
**44357** 7 BOND CX/10  
F1 F4

UN: R\$ 6,15 AV: R\$ 6,15 15: R\$ 6,28  
30: R\$ 6,41 45: R\$ 6,53 60: R\$ 6,67

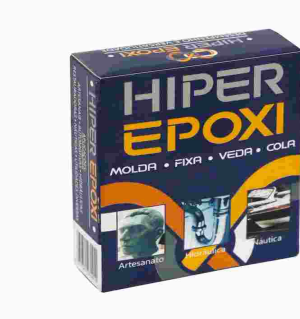

COLA HIPER EPOXI 50 GRS (TIPO DUREPOXI)

Código: Fábrika: Unidade:  
**34754** HIPER EPOXI UN/1  
F1 F4

UN: R\$ 10,26 AV: R\$ 10,26 15: R\$ 10,48  
30: R\$ 10,69 45: R\$ 10,90 60: R\$ 11,12



COLA HIPER EPOXI 100 GRS (TIPO DUREPOXI)

Código: Fábrika: Unidade:  
**7807** HIPER EPOXI UN/1  
F1 F4

UN: R\$ 61,62 AV: R\$ 61,62 15: R\$ 62,91  
30: R\$ 64,16 45: R\$ 65,45 60: R\$ 66,76



CONJ 6 XICARAS CAFE C/PIRES ACR CRISTAL

Código: Fábrika: Unidade:  
**50338** QUALYPLAS CX/1  
F1 F4

UN: R\$ 20,53 AV: R\$ 20,53 15: R\$ 20,96  
30: R\$ 21,38 45: R\$ 21,81 60: R\$ 22,24



CONJUNTO TESOURA INOX CB PLAST 8208 4X1

Código: Fábrika: Unidade:  
**43583** IDEA UN/1  
F1 F4

UN: R\$ 8,21 AV: R\$ 8,21 15: R\$ 8,38  
30: R\$ 8,55 45: R\$ 8,72 60: R\$ 8,89



CONTROLE REMOTO TV GRADIENTE 8114/29A

Código: Fábrika: Unidade:  
**24222** HAI BRASIL UN/1  
F1 F4

UN: R\$ 8,21 AV: R\$ 8,21 15: R\$ 8,38  
30: R\$ 8,55 45: R\$ 8,72 60: R\$ 8,89



CONTROLE REMOTO TV MITSUBISHI 8122

Código: Fábrika: Unidade:  
**17544** HAI BRASIL UN/1  
F1 F4

UN: R\$ 8,21 AV: R\$ 8,21 15: R\$ 8,38  
30: R\$ 8,55 45: R\$ 8,72 60: R\$ 8,89



CONTROLE REMOTO TV MITSUBISHI HA-053A

Código: Fábrika: Unidade:  
**21600** IMPORTADO UN/1  
F1 F4

UN: R\$ 8,21 AV: R\$ 8,21 15: R\$ 8,38  
30: R\$ 8,55 45: R\$ 8,72 60: R\$ 8,89



CONTROLE REMOTO TV SHARP 8126/7122/3112

Código: Fábrica: Unidade:  
**24226** IDEA UN/1  
F1 F4

UN: R\$ 6,02 AV: R\$ 6,02 15: R\$ 6,14  
30: R\$ 6,27 45: R\$ 6,39 60: R\$ 6,52



CORANTE LIQ 50 ML AMARELO

Código: Fábrica: Unidade:  
**50741** TEK BOND UN/1  
F1 F4

UN: R\$ 6,02 AV: R\$ 6,02 15: R\$ 6,14  
30: R\$ 6,27 45: R\$ 6,39 60: R\$ 6,52



CORANTE LIQ 50 ML AZUL

Código: Fábrica: Unidade:  
**50740** TEK BOND UN/1  
F1 F4

UN: R\$ 6,02 AV: R\$ 6,02 15: R\$ 6,14  
30: R\$ 6,27 45: R\$ 6,39 60: R\$ 6,52



CORANTE LIQ 50 ML BRANCO

Código: Fábrica: Unidade:  
**50738** TEK BOND UN/1  
F1 F4

UN: R\$ 6,02 AV: R\$ 6,02 15: R\$ 6,14  
30: R\$ 6,27 45: R\$ 6,39 60: R\$ 6,52



CORANTE LIQ 50 ML LARANJA

Código: Fábrica: Unidade:  
**50745** TEK BOND UN/1  
F1 F4

UN: R\$ 6,02 AV: R\$ 6,02 15: R\$ 6,14  
30: R\$ 6,27 45: R\$ 6,39 60: R\$ 6,52



CORANTE LIQ 50 ML MARROM

Código: Fábrica: Unidade:  
**50747** TEK BOND UN/1  
F1 F4

UN: R\$ 6,02 AV: R\$ 6,02 15: R\$ 6,14  
30: R\$ 6,27 45: R\$ 6,39 60: R\$ 6,52



CORANTE LIQ 50 ML OCRES

Código: Fábrica: Unidade:  
**50746** TEK BOND UN/1  
F1 F4

UN: R\$ 6,02 AV: R\$ 6,02 15: R\$ 6,14  
30: R\$ 6,27 45: R\$ 6,39 60: R\$ 6,52



CORANTE LIQ 50 ML PRETO

Código: Fábrica: Unidade:  
**50739** TEK BOND UN/1  
F1 F4

UN: R\$ 6,02 AV: R\$ 6,02 15: R\$ 6,14  
30: R\$ 6,27 45: R\$ 6,39 60: R\$ 6,52



CORANTE LIQ 50 ML VERDE

Código: Fábrica: Unidade:  
**50743** TEK BOND UN/1  
F1 F4

UN: R\$ 6,02 AV: R\$ 6,02 15: R\$ 6,14  
30: R\$ 6,27 45: R\$ 6,39 60: R\$ 6,52



CORANTE LIQ 50 ML VERMELHO

Código: Fábrica: Unidade:  
**50742** TEK BOND UN/1  
F1 F4

UN: R\$ 6,02 AV: R\$ 6,02 15: R\$ 6,14  
30: R\$ 6,27 45: R\$ 6,39 60: R\$ 6,52



CORANTE LIQ 50 ML VIOLETA

Código: Fábrica: Unidade:  
**50744** TEK BOND UN/1  
F1 F4

UN: R\$ 3,00 AV: R\$ 71,89 15: R\$ 73,39  
30: R\$ 74,86 45: R\$ 76,36 60: R\$ 77,88

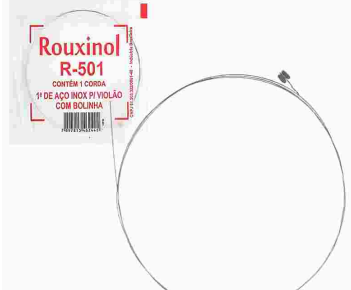

CORDA ACO VIOLAO 1 MI R-501-201 24X1

Código: Fábrica: Unidade:  
**37353** ROUXINOL PT/24  
F1 F4

UN: R\$ 3,21 AV: R\$ 77,03 15: R\$ 78,63  
30: R\$ 80,21 45: R\$ 81,81 60: R\$ 83,45



CORDA ACO VIOLAO 2 SI R-502 24X1

Código: Fábrica: Unidade:  
**37354** ROUXINOL PT/24  
F1 F4

UN: R\$ 4,49 AV: R\$ 53,93 15: R\$ 55,05  
30: R\$ 56,15 45: R\$ 57,28 60: R\$ 58,42



CORDA ACO VIOLAO 3 SOL R-503 12X1

Código: Fábrica: Unidade:  
**36271** ROUXINOL PT/12  
F1 F4

UN: R\$ 131,47 AV: R\$ 131,47 15: R\$ 134,21  
30: R\$ 136,89 45: R\$ 139,63 60: R\$ 142,43



CORTADOR ELETRICO DE ISOPOR USB 110V

Código: Fábrica: Unidade:  
**50203** VONDER UN/1  
F1 F4

UN: R\$ 2,65 AV: R\$ 31,83 15: R\$ 32,50  
30: R\$ 33,15 45: R\$ 33,81 60: R\$ 34,49



CORTADOR UNHA DISCO C/CORRENTE 398 12X1

Código: Fábrica: Unidade:  
**39983** PLANETA CR/12  
F1 F4

UN: R\$ 1,54 AV: R\$ 18,48 15: R\$ 18,86  
30: R\$ 19,24 45: R\$ 19,63 60: R\$ 20,02



CORTADOR UNHA PEQ C/CORRENT CTL 07 12X1

Código: Fábrika: Unidade:  
**50789** HOME&MORE CR/12  
F1 F4

UN: R\$ 11,64 AV: R\$ 34,91 15: R\$ 35,64  
30: R\$ 36,35 45: R\$ 37,08 60: R\$ 37,82



CUECA AD ALGODAO C/ELAST N01 G 3X1

Código: Fábrika: Unidade:  
**22472** NAWES PT/3  
F1 F4

UN: R\$ 11,64 AV: R\$ 34,91 15: R\$ 35,64  
30: R\$ 36,35 45: R\$ 37,08 60: R\$ 37,82



CUECA AD ALGODAO C/ELAST N01 GG 3X1

Código: Fábrika: Unidade:  
**28164** NAWES PT/3  
F1 F4

UN: R\$ 11,64 AV: R\$ 34,91 15: R\$ 35,64  
30: R\$ 36,35 45: R\$ 37,08 60: R\$ 37,82



CUECA AD ALGODAO C/ELAST N01 M 3X1

Código: Fábrika: Unidade:  
**18843** NAWES PT/3  
F1 F4

UN: R\$ 11,64 AV: R\$ 34,91 15: R\$ 35,64  
30: R\$ 36,35 45: R\$ 37,08 60: R\$ 37,82



CUECA AD ALGODAO C/ELAST N01/2/59 P 3X1

Código: Fábrika: Unidade:  
**18844** NAWES PT/3  
F1 F4

UN: R\$ 11,18 AV: R\$ 33,54 15: R\$ 34,24  
30: R\$ 34,92 45: R\$ 35,62 60: R\$ 36,33



CUECA AD ALGODAO N02 G 3X1

Código: Fábrika: Unidade:  
**20352** NAWES PT/3  
F1 F4

UN: R\$ 11,18 AV: R\$ 33,54 15: R\$ 34,24  
30: R\$ 34,92 45: R\$ 35,62 60: R\$ 36,33



CUECA AD ALGODAO N02 GG 3X1

Código: Fábrika: Unidade:  
**25051** NAWES PT/3  
F1 F4

UN: R\$ 11,18 AV: R\$ 33,54 15: R\$ 34,24  
30: R\$ 34,92 45: R\$ 35,62 60: R\$ 36,33



CUECA AD ALGODAO N02 M 3X1

Código: Fábrika: Unidade:  
**20353** NAWES PT/3  
F1 F4

UN: R\$ 11,18 AV: R\$ 33,54 15: R\$ 34,24  
30: R\$ 34,92 45: R\$ 35,62 60: R\$ 36,33



CUECA AD ALGODAO N02 P 3X1

Código: Fábrika: Unidade:  
**6918** NAWES PT/3  
F1 F4

UN: R\$ 14,98 AV: R\$ 179,76 15: R\$ 183,51  
30: R\$ 187,18 45: R\$ 190,92 60: R\$ 194,74



CUECA AD BOXER ALGODAO LISO N15 G 12X1

Código: Fábrika: Unidade:  
**39720** NAWES PT/12  
F1 F4

UN: R\$ 14,98 AV: R\$ 179,76 15: R\$ 183,51  
30: R\$ 187,18 45: R\$ 190,92 60: R\$ 194,74



CUECA AD BOXER ALGODAO LISO N15 GG 12X1

Código: Fábrika: Unidade:  
**39721** NAWES PT/12  
F1 F4

UN: R\$ 14,98 AV: R\$ 179,76 15: R\$ 183,51  
30: R\$ 187,18 45: R\$ 190,92 60: R\$ 194,74



CUECA AD BOXER ALGODAO LISO N15 M 12X1

Código: Fábrika: Unidade:  
**39719** NAWES PT/12  
F1 F4

UN: R\$ 14,98 AV: R\$ 179,76 15: R\$ 183,51  
30: R\$ 187,18 45: R\$ 190,92 60: R\$ 194,74



CUECA AD BOXER ALGODAO LISO N15 P 12X1

Código: Fábrika: Unidade:  
**39718** NAWES PT/12  
F1 F4

UN: R\$ 21,49 AV: R\$ 42,99 15: R\$ 43,88  
30: R\$ 44,76 45: R\$ 45,66 60: R\$ 46,57



CUECA AD BOXER ALGODAO LISO N27 GG 2X1

Código: Fábrika: Unidade:  
**39717** NAWES PT/2  
F1 F4

UN: R\$ 14,98 AV: R\$ 179,76 15: R\$ 183,51  
30: R\$ 187,18 45: R\$ 190,92 60: R\$ 194,74



CUECA AD BOXER ALGODAO LISTR N15 G 12X1

Código: Fábrika: Unidade:  
**39724** NAWES PT/12  
F1 F4

UN: R\$ 14,98 AV: R\$ 179,76 15: R\$ 183,51  
30: R\$ 187,18 45: R\$ 190,92 60: R\$ 194,74



CUECA AD BOXER ALGODAO LISTR N15 GG 12X1

Código: Fábrika: Unidade:  
**39725** NAWES PT/12  
F1 F4

UN: R\$ 14,98 AV: R\$ 179,76 15: R\$ 183,51  
30: R\$ 187,18 45: R\$ 190,92 60: R\$ 194,74



CUECA AD BOXER ALGODAO LISTR N15 M 12X1

Código: 39723 Fábrica: NAWES Unidade: PT/12 F1 F4

UN: R\$ 14,98 AV: R\$ 179,76 15: R\$ 183,51  
30: R\$ 187,18 45: R\$ 190,92 60: R\$ 194,74



CUECA AD BOXER ALGODAO LISTR N15 P 12X1

Código: 39722 Fábrica: NAWES Unidade: PT/12 F1 F4

UN: R\$ 20,54 AV: R\$ 41,08 15: R\$ 41,93  
30: R\$ 42,77 45: R\$ 43,63 60: R\$ 44,50



CUECA AD BOXER ALGODAO N27 G 2X1

Código: 39716 Fábrica: NAWES Unidade: PT/2 F1 F4

UN: R\$ 20,54 AV: R\$ 41,08 15: R\$ 41,93  
30: R\$ 42,77 45: R\$ 43,63 60: R\$ 44,50



CUECA AD BOXER ALGODAO N27 M 2X1

Código: 39715 Fábrica: NAWES Unidade: PT/2 F1 F4

UN: R\$ 20,54 AV: R\$ 41,08 15: R\$ 41,93  
30: R\$ 42,77 45: R\$ 43,63 60: R\$ 44,50



CUECA AD BOXER ALGODAO N27 P 2X1

Código: 39714 Fábrica: NAWES Unidade: PT/2 F1 F4

UN: R\$ 11,09 AV: R\$ 11,09 15: R\$ 11,32  
30: R\$ 11,55 45: R\$ 11,78 60: R\$ 12,02



CUECA AD BOXER ALGODAO P 030/007

Código: 20350 Fábrica: KELLPS/MACHY Unidade: UN/1 F1 F4

UN: R\$ 11,56 AV: R\$ 11,56 15: R\$ 11,80  
30: R\$ 12,03 45: R\$ 12,27 60: R\$ 12,52



CUECA AD BOXER MICROFIBRA G 019

Código: 29103 Fábrica: SOMOS Unidade: PT/1 F1 F4

UN: R\$ 11,56 AV: R\$ 11,56 15: R\$ 11,80  
30: R\$ 12,03 45: R\$ 12,27 60: R\$ 12,52



CUECA AD BOXER MICROFIBRA M ESPEC MARCA

Código: 29100 Fábrica: CJL Unidade: PT/1 F1 F4

UN: R\$ 6,33 AV: R\$ 76,01 15: R\$ 77,60  
30: R\$ 79,15 45: R\$ 80,73 60: R\$ 82,35



CUECA AD BOXER UNICO 90%POL/10%ELAS 12X1

Código: 32646 Fábrica: VI-MAIS Unidade: PT/12 F1 F4

UN: R\$ 15,72 AV: R\$ 15,72 15: R\$ 16,04  
30: R\$ 16,36 45: R\$ 16,69 60: R\$ 17,03



CUECA AD SAMBA CANCAO P 053

Código: 12585 Fábrica: MACHY Unidade: UN/1 F1 F4

UN: R\$ 8,41 AV: R\$ 8,41 15: R\$ 8,59  
30: R\$ 8,76 45: R\$ 8,94 60: R\$ 9,11



CUECA AD SLIP P ALGODAO/MFIBRA

Código: 15690 Fábrica: GUERRIER Unidade: UN/1 F1 F4

UN: R\$ 8,14 AV: R\$ 24,43 15: R\$ 24,94  
30: R\$ 25,43 45: R\$ 25,94 60: R\$ 26,46



CUECA INF ALGODAO C/ELAST M 58/08 3X1

Código: 12586 Fábrica: KELLPS/SOMOS Unidade: PT/3 F1 F4

UN: R\$ 8,14 AV: R\$ 24,43 15: R\$ 24,94  
30: R\$ 25,43 45: R\$ 25,94 60: R\$ 26,46



CUECA INF ALGODAO C/ELAST N03 G 3X1

Código: 18209 Fábrica: NAWES Unidade: PT/3 F1 F4

UN: R\$ 8,14 AV: R\$ 24,43 15: R\$ 24,94  
30: R\$ 25,43 45: R\$ 25,94 60: R\$ 26,46



CUECA INF ALGODAO C/ELAST N03 M 3X1

Código: 51079 Fábrica: NAWES Unidade: PT/3 F1 F4

UN: R\$ 8,14 AV: R\$ 24,43 15: R\$ 24,94  
30: R\$ 25,43 45: R\$ 25,94 60: R\$ 26,46



CUECA INF ALGODAO C/ELAST N03 P 3X1

Código: 5917 Fábrica: NAWES Unidade: PT/3 F1 F4

UN: R\$ 7,95 AV: R\$ 23,86 15: R\$ 24,36  
30: R\$ 24,85 45: R\$ 25,34 60: R\$ 25,85



CUECA INF ALGODAO N04 G 3X1

Código: 18839 Fábrica: NAWES Unidade: PT/3 F1 F4

UN: R\$ 7,95 AV: R\$ 23,86 15: R\$ 24,36  
30: R\$ 24,85 45: R\$ 25,34 60: R\$ 25,85



CUECA INF ALGODAO N04 M 3X1

Código: Fábriça: Unidade:  
**18841** NAWES PT/3  
F1 F4

UN: R\$ 7,95 AV: R\$ 23,86 15: R\$ 24,36  
30: R\$ 24,85 45: R\$ 25,34 60: R\$ 25,85



CUECA INF ALGODAO N04 P 3X1

Código: Fábriça: Unidade:  
**18207** NAWES PT/3  
F1 F4

UN: R\$ 11,98 AV: R\$ 143,80 15: R\$ 146,79  
30: R\$ 149,73 45: R\$ 152,72 60: R\$ 155,78



CUECA INF BOXER ALGODAO LISO N16 G 12X1

Código: Fábriça: Unidade:  
**39730** NAWES PT/12  
F1 F4

UN: R\$ 11,98 AV: R\$ 143,80 15: R\$ 146,79  
30: R\$ 149,73 45: R\$ 152,72 60: R\$ 155,78



CUECA INF BOXER ALGODAO LISO N16 GG 12X1

Código: Fábriça: Unidade:  
**39731** NAWES PT/12  
F1 F4

UN: R\$ 11,98 AV: R\$ 143,80 15: R\$ 146,79  
30: R\$ 149,73 45: R\$ 152,72 60: R\$ 155,78



CUECA INF BOXER ALGODAO LISO N16 M 12X1

Código: Fábriça: Unidade:  
**39729** NAWES PT/12  
F1 F4

UN: R\$ 11,98 AV: R\$ 143,80 15: R\$ 146,79  
30: R\$ 149,73 45: R\$ 152,72 60: R\$ 155,78



CUECA INF BOXER ALGODAO LISO N16 P 12X1

Código: Fábriça: Unidade:  
**39728** NAWES PT/12  
F1 F4

UN: R\$ 11,98 AV: R\$ 143,80 15: R\$ 146,79  
30: R\$ 149,73 45: R\$ 152,72 60: R\$ 155,78



CUECA INF BOXER ALGODAO LISTR N16 G 12X1

Código: Fábriça: Unidade:  
**39734** NAWES PT/12  
F1 F4

UN: R\$ 11,98 AV: R\$ 143,80 15: R\$ 146,79  
30: R\$ 149,73 45: R\$ 152,72 60: R\$ 155,78



CUECA INF BOXER ALGODAO LISTR N16 P 12X1

Código: Fábriça: Unidade:  
**39732** NAWES PT/12  
F1 F4

UN: R\$ 4,49 AV: R\$ 13,46 15: R\$ 13,74  
30: R\$ 14,01 45: R\$ 14,29 60: R\$ 14,58



CUECA JUVENIL ALGODAO C/ELAST G 021 3X1

Código: Fábriça: Unidade:  
**20386** SOMOS PT/3  
F1 F4

UN: R\$ 4,49 AV: R\$ 13,46 15: R\$ 13,74  
30: R\$ 14,01 45: R\$ 14,29 60: R\$ 14,58



CUECA JUVENIL ALGODAO C/ELAST M 021 3X1

Código: Fábriça: Unidade:  
**20385** SOMOS PT/3  
F1 F4

UN: R\$ 6,33 AV: R\$ 19,00 15: R\$ 19,40  
30: R\$ 19,79 45: R\$ 20,18 60: R\$ 20,59



CUECA JUVENIL ALGODAO C/ELAST N14 G 3X1

Código: Fábriça: Unidade:  
**39726** NAWES PT/3  
F1 F4

UN: R\$ 4,49 AV: R\$ 13,46 15: R\$ 13,74  
30: R\$ 14,01 45: R\$ 14,29 60: R\$ 14,58



CUECA JUVENIL ALGODAO C/ELAST P 021 3X1

Código: Fábriça: Unidade:  
**20384** SOMOS PT/3  
F1 F4

UN: R\$ 7,40 AV: R\$ 7,40 15: R\$ 7,55  
30: R\$ 7,70 45: R\$ 7,85 60: R\$ 8,01



CUECA JUVENIL BOXER ALG/MF N13 G

Código: Fábriça: Unidade:  
**26142** NAWES UN/1  
F1 F4

UN: R\$ 7,40 AV: R\$ 7,40 15: R\$ 7,55  
30: R\$ 7,70 45: R\$ 7,85 60: R\$ 8,01



CUECA JUVENIL BOXER N13 M ALG/MF

Código: Fábriça: Unidade:  
**32882** NAWES UN/1  
F1 F4

UN: R\$ 7,40 AV: R\$ 7,40 15: R\$ 7,55  
30: R\$ 7,70 45: R\$ 7,85 60: R\$ 8,01



CUECA JUVENIL BOXER N13 P/PP ALG/MF

Código: Fábriça: Unidade:  
**32883** NAWES UN/1  
F1 F4

UN: R\$ 109,40 AV: R\$ 109,40 15: R\$ 111,68  
30: R\$ 113,91 45: R\$ 116,19 60: R\$ 118,51



CX SOM PORT MULT USB BLUE RAD AM/FM 1105

Código: Fábriça: Unidade:  
**39707** WINMAX CX/1  
F1 F4

UN: R\$ 109,40 AV: R\$ 109,40 15: R\$ 111,68  
30: R\$ 113,91 45: R\$ 116,19 60: R\$ 118,51



CX SOM PORT MULT USB BLUE RAD AM/FM 1106

Código: Fábrika: Unidade:  
**39708** WINMAX CX/1  
F1 F4

UN: R\$ 282,23 AV: R\$ 282,23 15: R\$ 2881,03  
30: R\$ 2938,65 45: R\$ 2997,42 60: R\$ 3057,37



CX SOM PORTATIL LED CONTROL REMOT 2000W

Código: Fábrika: Unidade:  
**43400** LETRON UN/1  
F1 F4

UN: R\$ 4,28 AV: R\$ 51,35 15: R\$ 52,42  
30: R\$ 53,47 45: R\$ 54,54 60: R\$ 55,63



DEDEIRA VIOLAO COLOR D98 12X1

Código: Fábrika: Unidade:  
**24410** ROUXINOL PT/12  
F1 F4

UN: R\$ 11,29 AV: R\$ 11,29 15: R\$ 11,52  
30: R\$ 11,75 45: R\$ 11,99 60: R\$ 12,23



DESENGRIPANTE SPRAY 300 ML 150 GRS

Código: Fábrika: Unidade:  
**15753** LUB FAST UN/1  
F1 F4

UN: R\$ 9,75 AV: R\$ 9,75 15: R\$ 9,95  
30: R\$ 10,15 45: R\$ 10,35 60: R\$ 10,56



DESENTUPIDOR DE TUBULACAO 1,5 MT 5693

Código: Fábrika: Unidade:  
**32403** IDEA UN/1  
F1 F4

UN: R\$ 9,23 AV: R\$ 9,23 15: R\$ 9,43  
30: R\$ 9,62 45: R\$ 9,81 60: R\$ 10,00



DESENTUPIDOR INOX TUBULACAO 1,23MTS 1001

Código: Fábrika: Unidade:  
**44735** WINCY UN/1  
F1 F4

UN: R\$ 2,21 AV: R\$ 110,42 15: R\$ 112,72  
30: R\$ 114,98 45: R\$ 117,28 60: R\$ 119,62



ENCASTOR C/CHUMBADA 20X19 50X1

Código: Fábrika: Unidade:  
**27235** ENTRE RIOS PT/50  
F1 F4

UN: R\$ 1,67 AV: R\$ 83,38 15: R\$ 85,11  
30: R\$ 86,82 45: R\$ 88,55 60: R\$ 90,32



ENCASTOR C/CHUMBADA 22X17 50X1

Código: Fábrika: Unidade:  
**39382** ENTRE RIOS PT/50  
F1 F4

UN: R\$ 1,03 AV: R\$ 51,35 15: R\$ 52,42  
30: R\$ 53,47 45: R\$ 54,54 60: R\$ 55,63



ENCASTOR C/CHUMBADA 24 50X1

Código: Fábrika: Unidade:  
**27236** CF PT/50  
F4

UN: R\$ 1,23 AV: R\$ 122,87 15: R\$ 125,43  
30: R\$ 127,94 45: R\$ 130,50 60: R\$ 133,11



ENCASTOR C/CHUMBADA 24X15 100X1

Código: Fábrika: Unidade:  
**10895** ENTRE RIOS CE/100  
F1 F4

UN: R\$ 1,03 AV: R\$ 102,71 15: R\$ 104,85  
30: R\$ 106,95 45: R\$ 109,09 60: R\$ 111,27

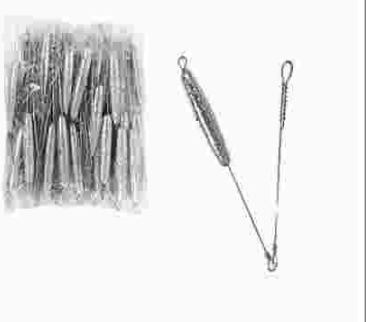

ENCASTOR C/CHUMBADA 26X13 100X1

Código: Fábrika: Unidade:  
**27237** ENTRE RIOS CE/100  
F1 F4

UN: R\$ 0,86 AV: R\$ 86,13 15: R\$ 87,93  
30: R\$ 89,68 45: R\$ 91,48 60: R\$ 93,31



ENCASTOR C/CHUMBADA 28X11 100X1

Código: Fábrika: Unidade:  
**27238** ENTRE RIOS CE/100  
F1 F4

UN: R\$ 0,77 AV: R\$ 77,31 15: R\$ 78,92  
30: R\$ 80,50 45: R\$ 82,11 60: R\$ 83,75



ENCASTOR C/CHUMBADA 30X06 100X1

Código: Fábrika: Unidade:  
**27239** ENTRE RIOS CE/100  
F1 F4

UN: R\$ 0,71 AV: R\$ 71,49 15: R\$ 72,98  
30: R\$ 74,44 45: R\$ 75,93 60: R\$ 77,45



ENCASTOR C/CHUMBADA 32X06 100X1

Código: Fábrika: Unidade:  
**27240** ENTRE RIOS CE/100  
F1 F4

UN: R\$ 0,56 AV: R\$ 56,49 15: R\$ 57,66  
30: R\$ 58,82 45: R\$ 59,99 60: R\$ 61,19

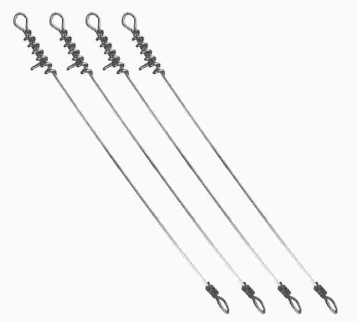

ENCASTOR C/MOLA 18X25 100X1

Código: Fábrika: Unidade:  
**45161** CF CE/100  
F1 F4

UN: R\$ 0,51 AV: R\$ 51,35 15: R\$ 52,42  
30: R\$ 53,47 45: R\$ 54,54 60: R\$ 55,63



ENCASTOR C/MOLA 20X07 100X1

Código: Fábrika: Unidade:  
**45160** CF CE/100  
F1 F4

UN: R\$ 0,33 AV: R\$ 32,87 15: R\$ 33,56  
30: R\$ 34,23 45: R\$ 34,91 60: R\$ 35,61



ENCASTOR C/MOLA 20X10 100X1

Código: 13624 Fábrica: CF Unidade: CE/100 F4

UN: R\$ 0,39 AV: R\$ 39,03 15: R\$ 39,85  
30: R\$ 40,64 45: R\$ 41,46 60: R\$ 42,29



ENCASTOR C/MOLA 20X15 100X1

Código: 13623 Fábrica: CF Unidade: CE/100 F4

UN: R\$ 0,46 AV: R\$ 46,21 15: R\$ 47,18  
30: R\$ 48,12 45: R\$ 49,08 60: R\$ 50,06



ENCASTOR C/MOLA 22X07 100X1

Código: 10888 Fábrica: CF Unidade: CE/100 F4

UN: R\$ 0,46 AV: R\$ 46,21 15: R\$ 47,18  
30: R\$ 48,12 45: R\$ 49,08 60: R\$ 50,06



ENCASTOR C/MOLA 22X10 100X1

Código: 10889 Fábrica: ENTRE RIOS Unidade: CE/100 F4

UN: R\$ 0,46 AV: R\$ 46,21 15: R\$ 47,18  
30: R\$ 48,12 45: R\$ 49,08 60: R\$ 50,06



ENCASTOR C/MOLA 22X15 100X1

Código: 34567 Fábrica: CF Unidade: CE/100 F4

UN: R\$ 0,41 AV: R\$ 41,08 15: R\$ 41,93  
30: R\$ 42,77 45: R\$ 43,63 60: R\$ 44,50



ENCASTOR C/MOLA 22X20 100X1

Código: 43953 Fábrica: CF Unidade: CE/100 F4

UN: R\$ 0,21 AV: R\$ 20,54 15: R\$ 20,97  
30: R\$ 21,39 45: R\$ 21,82 60: R\$ 22,26



ENCASTOR C/MOLA 24X05 100X1

Código: 10890 Fábrica: CF Unidade: CE/100 F4

UN: R\$ 0,26 AV: R\$ 25,67 15: R\$ 26,20  
30: R\$ 26,73 45: R\$ 27,26 60: R\$ 27,81



ENCASTOR C/MOLA 24X07 100X1

Código: 10885 Fábrica: ENTRE RIOS Unidade: CE/100 F4

UN: R\$ 0,45 AV: R\$ 45,19 15: R\$ 46,13  
30: R\$ 47,05 45: R\$ 47,99 60: R\$ 48,95



ENCASTOR C/MOLA 24X10 100X1

Código: 10886 Fábrica: ENTRE RIOS Unidade: CE/100 F1 F4

UN: R\$ 0,27 AV: R\$ 27,48 15: R\$ 28,05  
30: R\$ 28,61 45: R\$ 29,18 60: R\$ 29,77



ENCASTOR C/MOLA 26X05 100X1

Código: 30710 Fábrica: ENTRE RIOS Unidade: CE/100 F1 F4

UN: R\$ 0,31 AV: R\$ 30,81 15: R\$ 31,45  
30: R\$ 32,08 45: R\$ 32,72 60: R\$ 33,37



ENCASTOR C/MOLA 26X07 100X1

Código: 13622 Fábrica: ENTRE RIOS Unidade: CE/100 F1 F4

UN: R\$ 0,26 AV: R\$ 25,67 15: R\$ 26,20  
30: R\$ 26,73 45: R\$ 27,26 60: R\$ 27,81



ENCASTOR C/MOLA 28X03 100X1

Código: 10893 Fábrica: CF Unidade: CE/100 F1 F4

UN: R\$ 0,23 AV: R\$ 22,60 15: R\$ 23,07  
30: R\$ 23,53 45: R\$ 24,00 60: R\$ 24,48



ENCASTOR C/MOLA 28X05 100X1

Código: 10892 Fábrica: CF Unidade: CE/100 F4

UN: R\$ 0,26 AV: R\$ 25,55 15: R\$ 26,08  
30: R\$ 26,60 45: R\$ 27,13 60: R\$ 27,67



ENCASTOR C/MOLA 28X07 100X1

Código: 10894 Fábrica: ENTRE RIOS Unidade: CE/100 F1 F4

UN: R\$ 10,79 AV: R\$ 10,79 15: R\$ 11,01  
30: R\$ 11,23 45: R\$ 11,46 60: R\$ 11,68



ENCORDOAMENTO ACO CAVAQUINHO R-51

Código: 37351 Fábrica: ROUXINOL Unidade: PT/1 F1 F4

UN: R\$ 27,72 AV: R\$ 27,72 15: R\$ 28,30  
30: R\$ 28,87 45: R\$ 29,45 60: R\$ 30,03



ENCORDOAMENTO ACO GUITARRA ELETRICA R-80

Código: 36455 Fábrica: ROUXINOL Unidade: UN/1 F1 F4

UN: R\$ 35,94 AV: R\$ 35,94 15: R\$ 36,69  
30: R\$ 37,42 45: R\$ 38,17 60: R\$ 38,94



ENCORDOAMENTO ACO VIOLA R-52

Código: 20610 Fábrica: ROUXINOL Unidade: PT/1 F1 F4

UN: R\$ 33,90 AV: R\$ 33,90 15: R\$ 34,60  
30: R\$ 35,30 45: R\$ 36,00 60: R\$ 36,72



ENCORDOAMENTO ACO VIOLA R-20

Código: 37350 Fábrica: ROUXINOL Unidade: PT/1 F1 F4

UN: R\$ 38,00 AV: R\$ 38,00 15: R\$ 38,79  
30: R\$ 39,56 45: R\$ 40,35 60: R\$ 41,16



ENCORDOAMENTO ACO VIOLA R-50

Código: 20609 Fábrica: ROUXINOL Unidade: PT/1 F1 F4

UN: R\$ 30,81 AV: R\$ 30,81 15: R\$ 31,45  
30: R\$ 32,08 45: R\$ 32,72 60: R\$ 33,37



ENCORDOAMENTO ACO VIOLA R-70

Código: 37352 Fábrica: ROUXINOL Unidade: PT/1 F1 F4

UN: R\$ 2,37 AV: R\$ 14,20 15: R\$ 14,49  
30: R\$ 14,78 45: R\$ 15,08 60: R\$ 15,38



ENFEITE DECORATIVO SAPO 4CM 15477 6X1

Código: 38296 Fábrica: SATYAM Unidade: CX/6 F1 F4

UN: R\$ 2,49 AV: R\$ 2,49 15: R\$ 2,54  
30: R\$ 2,59 45: R\$ 2,64 60: R\$ 2,69



ENFEITE RESINA C/CX 83708 BATISMO

Código: 15481 Fábrica: AIH Unidade: CX/1 F1 F4

UN: R\$ 2,26 AV: R\$ 2,26 15: R\$ 2,31  
30: R\$ 2,35 45: R\$ 2,40 60: R\$ 2,45



ENFEITE RESINA C/CX 84016 C/PORTA JOIA

Código: 15451 Fábrica: AIH Unidade: CX/1 F1 F4

UN: R\$ 2,72 AV: R\$ 2,72 15: R\$ 2,78  
30: R\$ 2,83 45: R\$ 2,89 60: R\$ 2,95

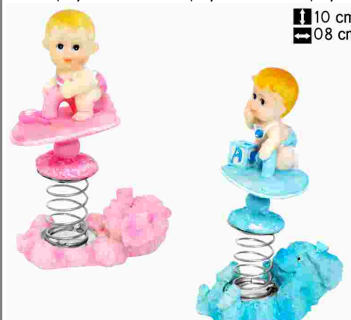

ENFEITE RESINA C/CX 84083 BEBE LEVADO

Código: 15018 Fábrica: AIH Unidade: CX/1 F1 F4

UN: R\$ 2,11 AV: R\$ 2,11 15: R\$ 2,15  
30: R\$ 2,19 45: R\$ 2,24 60: R\$ 2,28



ENFEITE RESINA C/CX 84129 BEBE SENT BOLA

Código: 15495 Fábrica: AIH Unidade: CX/1 F1 F4

UN: R\$ 0,49 AV: R\$ 49,31 15: R\$ 50,33  
30: R\$ 51,34 45: R\$ 52,37 60: R\$ 53,41

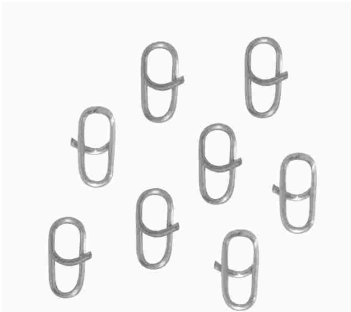

ENGATE RAPIDO SNAP P/ISCA ARTIFICIAL100X1

Código: 40269 Fábrica: CF Unidade: CE/100 F4

UN: R\$ 48,84 AV: R\$ 48,84 15: R\$ 49,86  
30: R\$ 50,86 45: R\$ 51,88 60: R\$ 52,91



ESPELHO AUMENTO MESA DUPLO 16,7X19CM 041

Código: 49389 Fábrica: RIOHOME Unidade: UN/1 F1 F4

UN: R\$ 2,23 AV: R\$ 80,16 15: R\$ 81,83  
30: R\$ 83,46 45: R\$ 85,13 60: R\$ 86,84

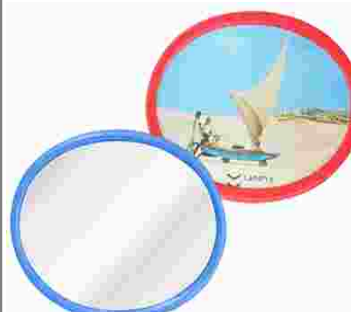

ESPELHO BOLSO OVAL PLAST 3702 36X1

Código: 30168 Fábrica: LANDHS Unidade: CX/36 F1 F4

UN: R\$ 2,00 AV: R\$ 72,15 15: R\$ 73,65  
30: R\$ 75,13 45: R\$ 76,63 60: R\$ 78,16



ESPELHO BOLSO REDONDO PLAST 3602 36X1

Código: 9391 Fábrica: LANDHS Unidade: CX/36 F1 F4

UN: R\$ 2,73 AV: R\$ 2,73 15: R\$ 2,78  
30: R\$ 2,84 45: R\$ 2,90 60: R\$ 2,95



ESPELHO EMOLDURADO INF C/QUEBRA CABECA

Código: 24798 Fábrica: HAI BRASIL Unidade: UN/1 F1 F4

UN: R\$ 3,67 AV: R\$ 3,67 15: R\$ 3,74  
30: R\$ 3,82 45: R\$ 3,89 60: R\$ 3,97



ESPELHO EMOLDURADO 0062

Código: 24796 Fábrica: HAI BRASIL Unidade: UN/1 F1 F4

UN: R\$ 4,45 AV: R\$ 26,71 15: R\$ 27,26  
30: R\$ 27,81 45: R\$ 28,37 60: R\$ 28,93



ESPELHO MOLDURA COLOR 10 6X1

Código: 19370 Fábrica: LANDHS/BUDEP Unidade: PT/6 F1 F4

UN: R\$ 3,77 AV: R\$ 45,19 15: R\$ 46,13  
30: R\$ 47,05 45: R\$ 47,99 60: R\$ 48,95

18 cm  
13,5 cm



ESPELHO MOLDURA N 12 12X1

Código: 17995 Fábrica: BUDEPLAST Unidade: DZ/12 F1 F4

UN: R\$ 6,50 AV: R\$ 39,02 15: R\$ 39,84  
30: R\$ 40,63 45: R\$ 41,45 60: R\$ 42,27



ESPELHO MOLDURA N 14 6X1

Código: 19093 Fábrica: BUDEPLAST Unidade: PT/6 F1 F4

UN: R\$ 6,42 AV: R\$ 77,03 15: R\$ 78,63  
30: R\$ 80,21 45: R\$ 81,81 60: R\$ 83,45



ESPELHO MOLDURA N 14 12X1

Código: 14334 Fábrica: BUDEPLAST Unidade: DZ/12 F1 F4

UN: R\$ 9,76 AV: R\$ 58,54 15: R\$ 59,76  
30: R\$ 60,95 45: R\$ 62,17 60: R\$ 63,42



ESPELHO MOLDURA N 16 6X1

Código: 19085 Fábrica: BUDEPLAST Unidade: PT/6 F1 F4

UN: R\$ 7,70 AV: R\$ 92,44 15: R\$ 94,36  
30: R\$ 96,25 45: R\$ 98,18 60: R\$ 100,14

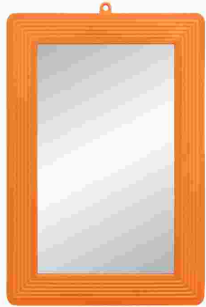

ESPELHO MOLDURA N 16 12X1

Código: 14335 Fábrica: BUDEPLAST Unidade: DZ/12 F1 F4

UN: R\$ 11,98 AV: R\$ 71,89 15: R\$ 73,39  
30: R\$ 74,86 45: R\$ 76,36 60: R\$ 77,88



ESPELHO MOLDURA N 18 6X1

Código: 3054 Fábrica: BUDEPLAST Unidade: PT/6 F1 F4

UN: R\$ 10,27 AV: R\$ 123,25 15: R\$ 125,82  
30: R\$ 128,34 45: R\$ 130,90 60: R\$ 133,52

25 cm  
18 cm



ESPELHO MOLDURA N 18 12X1

Código: 14336 Fábrica: BUDEPLAST Unidade: DZ/12 F1 F4

UN: R\$ 13,69 AV: R\$ 82,17 15: R\$ 83,88  
30: R\$ 85,56 45: R\$ 87,27 60: R\$ 89,01



ESPELHO MOLDURA N 20 6X1

Código: 3051 Fábrica: BUDEPLAST Unidade: PT/6 F1 F4

UN: R\$ 12,84 AV: R\$ 154,07 15: R\$ 157,28  
30: R\$ 160,43 45: R\$ 163,63 60: R\$ 166,91

31 cm  
21 cm



ESPELHO MOLDURA N 20 12X1

Código: 14337 Fábrica: BUDEPLAST Unidade: DZ/12 F1 F4

UN: R\$ 6,15 AV: R\$ 6,15 15: R\$ 6,28  
30: R\$ 6,41 45: R\$ 6,53 60: R\$ 6,67



ESTOPA COR EXTRA 200 GRS 1512

Código: 48284 Fábrica: POLIUM Unidade: PT/1 F1 F4

UN: R\$ 29,78 AV: R\$ 29,78 15: R\$ 30,40  
30: R\$ 31,01 45: R\$ 31,63 60: R\$ 32,26



EXTENSAO 3 MTS 3 ENTRADAS RED 32508A

Código: 26594 Fábrica: LIDER PLUS Unidade: UN/1 F1 F4

UN: R\$ 29,78 AV: R\$ 29,78 15: R\$ 30,40  
30: R\$ 31,01 45: R\$ 31,63 60: R\$ 32,26



EXTENSAO 3 MTS 3 ENTRADAS 3 PINOS 32640

Código: 46003 Fábrica: LIDER PLUS Unidade: UN/1 F1 F4

UN: R\$ 18,48 AV: R\$ 18,48 15: R\$ 18,86  
30: R\$ 19,24 45: R\$ 19,63 60: R\$ 20,02



EXTENSAO 3 MTS 3 ENTRADAS 32652

Código: 25895 Fábrica: LIDER PLUS Unidade: UN/1 F1 F4

UN: R\$ 30,81 AV: R\$ 30,81 15: R\$ 31,45  
30: R\$ 32,08 45: R\$ 32,72 60: R\$ 33,37



EXTENSAO 5 MTS 3 ENTRADAS RED 32509A

Código: 17785 Fábrica: LIDER PLUS Unidade: UN/1 F1 F4

UN: R\$ 23,62 AV: R\$ 23,62 15: R\$ 24,11  
30: R\$ 24,59 45: R\$ 25,08 60: R\$ 25,58



EXTENSAO 5 MTS 3 ENTRADAS 32654

Código: 25896 Fábrica: LIDER PLUS Unidade: UN/1 F1 F4

UN: R\$ 29,78 AV: R\$ 29,78 15: R\$ 30,40  
30: R\$ 31,01 45: R\$ 31,63 60: R\$ 32,26



EXTENSAO 10 MTS 3 ENTRADAS 32656

Código: 25897 Fábrica: LIDER PLUS Unidade: UN/1 F1 F4

UN: R\$ 6,15 AV: R\$ 6,15 15: R\$ 6,28  
30: R\$ 6,41 45: R\$ 6,53 60: R\$ 6,67



FERRAMEN PONTEIRO CONCRETO 30CM 9307 2X1

Código: Fábrica: Unidade:  
**42394** IDEA UN/1  
F1 F4

UN: R\$ 29,78 AV: R\$ 29,78 15: R\$ 30,40  
30: R\$ 31,01 45: R\$ 31,63 60: R\$ 32,26



FERRAMENTA ALICATE BICO FINO 1020

Código: Fábrica: Unidade:  
**48065** FERTAK UN/1  
F1 F4

UN: R\$ 25,67 AV: R\$ 25,67 15: R\$ 26,20  
30: R\$ 26,73 45: R\$ 27,26 60: R\$ 27,81



FERRAMENTA ALICATE BIJOUTERIA 5" BR

Código: Fábrica: Unidade:  
**45083** NYBC UN/1  
F1 F4

UN: R\$ 29,78 AV: R\$ 29,78 15: R\$ 30,40  
30: R\$ 31,01 45: R\$ 31,63 60: R\$ 32,26



FERRAMENTA ALICATE BIJOUTERIAS 5" BJ

Código: Fábrica: Unidade:  
**45084** NYBC UN/1  
F1 F4

UN: R\$ 21,56 AV: R\$ 21,56 15: R\$ 22,01  
30: R\$ 22,45 45: R\$ 22,90 60: R\$ 23,36



FERRAMENTA ALICATE CORTE BIJOU 4,5" 421

Código: Fábrica: Unidade:  
**46873** PLANETA UN/1  
F1 F4

UN: R\$ 21,56 AV: R\$ 21,56 15: R\$ 22,01  
30: R\$ 22,45 45: R\$ 22,90 60: R\$ 23,36



FERRAMENTA ALICATE CORTE BIJOU 4,5" 422

Código: Fábrica: Unidade:  
**46874** PLANETA UN/1  
F1 F4

UN: R\$ 32,86 AV: R\$ 32,86 15: R\$ 33,54  
30: R\$ 34,22 45: R\$ 34,90 60: R\$ 35,60



FERRAMENTA ALICATE ILHOS 6" 150MM

Código: Fábrica: Unidade:  
**45081** NYBC UN/1  
F1 F4

UN: R\$ 30,82 AV: R\$ 30,82 15: R\$ 31,46  
30: R\$ 32,09 45: R\$ 32,73 60: R\$ 33,38



FERRAMENTA ALICATE PRESSAO 10" 4566

Código: Fábrica: Unidade:  
**2866** IDEA UN/1  
F1 F4

UN: R\$ 17,98 AV: R\$ 17,98 15: R\$ 18,35  
30: R\$ 18,72 45: R\$ 19,09 60: R\$ 19,47



FERRAMENTA ALICATE UNIVERSAL 5" 9733

Código: Fábrica: Unidade:  
**38210** IDEA UN/1  
F1 F4

UN: R\$ 11,57 AV: R\$ 11,57 15: R\$ 11,81  
30: R\$ 12,04 45: R\$ 12,28 60: R\$ 12,53



FERRAMENTA ALICATE UNIVERSAL 8" 4030

Código: Fábrica: Unidade:  
**50144** GP6 CR/1  
F1 F4

UN: R\$ 51,35 AV: R\$ 51,35 15: R\$ 52,42  
30: R\$ 53,47 45: R\$ 54,54 60: R\$ 55,63



FERRAMENTA ALICATE VAZADOR 9" 210MM

Código: Fábrica: Unidade:  
**45082** NYBC UN/1  
F1 F4

UN: R\$ 24,14 AV: R\$ 24,14 15: R\$ 24,64  
30: R\$ 25,13 45: R\$ 25,64 60: R\$ 26,15



FERRAMENTA ALICATE 4,5" BICO/CORT/UN 3X1

Código: Fábrica: Unidade:  
**50143** GP6 CJ/1  
F1 F4

UN: R\$ 14,55 AV: R\$ 14,55 15: R\$ 14,85  
30: R\$ 15,15 45: R\$ 15,45 60: R\$ 15,76



FERRAMENTA ALICATE 6" BICO FINO ACO 511

Código: Fábrica: Unidade:  
**29205** PLANETA UN/1  
F1 F4

UN: R\$ 20,03 AV: R\$ 20,03 15: R\$ 20,45  
30: R\$ 20,86 45: R\$ 21,27 60: R\$ 21,70



FERRAMENTA ALICATE 6" CORTE DIAGONAL3017

Código: Fábrica: Unidade:  
**34789** FBG UN/1  
F1 F4

UN: R\$ 9,34 AV: R\$ 9,34 15: R\$ 9,53  
30: R\$ 9,72 45: R\$ 9,92 60: R\$ 10,12



FERRAMENTA ARAME GALVANIZADO 4X1

Código: Fábrica: Unidade:  
**33440** MAXPING CT/1  
F1 F4

UN: R\$ 5,84 AV: R\$ 5,84 15: R\$ 5,97  
30: R\$ 6,09 45: R\$ 6,21 60: R\$ 6,33

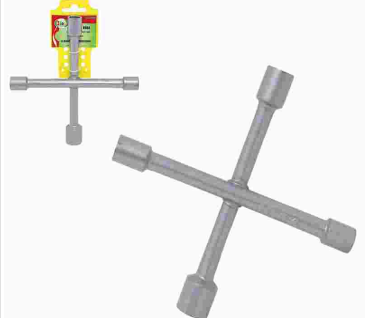

FERRAMENTA CHAVE COMBINADA 10 BOCAS 446

Código: Fábrica: Unidade:  
**46872** PLANETA CT/1  
F1 F4

UN: R\$ 20,03 AV: R\$ 20,03 15: R\$ 20,45  
30: R\$ 20,86 45: R\$ 21,27 60: R\$ 21,70

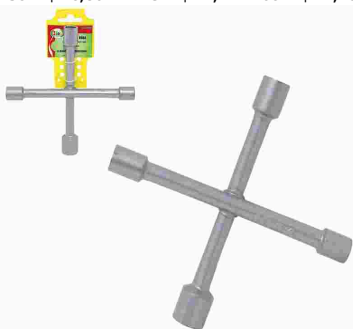

FERRAMENTA CHAVE RODA MINI 12X13X14MM

Código: Fábrica: Unidade:  
**40069** IDEA UN/1  
F1 F4

UN: R\$ 8,21 AV: R\$ 8,21 15: R\$ 8,38  
30: R\$ 8,55 45: R\$ 8,72 60: R\$ 8,89



FERRAMENTA CHAVE TESTE C/PLUG 10 FUSIVEL

Código: Fábrica: Unidade:  
**2853** IDEA CR/1  
F1 F4

UN: R\$ 31,84 AV: R\$ 31,84 15: R\$ 32,51  
30: R\$ 33,16 45: R\$ 33,82 60: R\$ 34,50

Altura: 32 cm



FERRAMENTA MARTELO G CB MADEIRA MT50

Código: Fábrica: Unidade:  
**27416** YING FA UN/1  
F1 F4

UN: R\$ 23,08 AV: R\$ 23,08 15: R\$ 23,56  
30: R\$ 24,03 45: R\$ 24,51 60: R\$ 25,00



FERRAMENTA MULTIMETRO ANALOGICO 270

Código: Fábrica: Unidade:  
**8349** AGUIA BRANCA UN/1  
F1 F4

UN: R\$ 34,92 AV: R\$ 34,92 15: R\$ 35,65  
30: R\$ 36,37 45: R\$ 37,09 60: R\$ 37,83



FERRAMENTA MULTIMETRO DIGITAL CTL 6200

Código: Fábrica: Unidade:  
**38214** IDEA UN/1  
F1 F4

UN: R\$ 9,93 AV: R\$ 9,93 15: R\$ 10,14  
30: R\$ 10,34 45: R\$ 10,55 60: R\$ 10,76



FERRAMENTA TRENA 5 MTS 24MM EMB 60017

Código: Fábrica: Unidade:  
**25016** GP6 UN/1  
F1 F4

UN: R\$ 14,37 AV: R\$ 14,37 15: R\$ 14,67  
30: R\$ 14,96 45: R\$ 15,26 60: R\$ 15,57



FERRAMENTA TRENA 7,5 MTS KD129

Código: Fábrica: Unidade:  
**22432** YING FA UN/1  
F1 F4

UN: R\$ 7,04 AV: R\$ 7,04 15: R\$ 7,18  
30: R\$ 7,33 45: R\$ 7,47 60: R\$ 7,62



FERRAMENTA 6 CHAVES PRECISAO 71601

Código: Fábrica: Unidade:  
**2871** ALMEGA UN/1  
F1 F4

UN: R\$ 36,90 AV: R\$ 36,90 15: R\$ 37,67  
30: R\$ 38,43 45: R\$ 39,19 60: R\$ 39,98



FERRO SOLDA 30W 127V G12

Código: Fábrica: Unidade:  
**41133** WESTERN UN/1  
F1 F4

UN: R\$ 40,05 AV: R\$ 40,05 15: R\$ 40,88  
30: R\$ 41,70 45: R\$ 42,54 60: R\$ 43,39



FILTRO LINHA 1 MT 4 TOMADAS 3 PINO 33044

Código: Fábrica: Unidade:  
**50085** LIDER PLUS UN/1  
F1 F4

UN: R\$ 41,08 AV: R\$ 41,08 15: R\$ 41,93  
30: R\$ 42,77 45: R\$ 43,63 60: R\$ 44,50



FILTRO LINHA 1 MT 5 TOMADAS 3 PIN 33045

Código: Fábrica: Unidade:  
**50086** LIDER PLUS UN/1  
F1 F4

UN: R\$ 44,16 AV: R\$ 44,16 15: R\$ 45,08  
30: R\$ 45,98 45: R\$ 46,90 60: R\$ 47,84



FILTRO LINHA 1 MT 6 TOMADAS 3 PIN 33046

Código: Fábrica: Unidade:  
**50087** LIDER PLUS UN/1  
F1 F4

UN: R\$ 4,35 AV: R\$ 4,35 15: R\$ 4,44  
30: R\$ 4,52 45: R\$ 4,61 60: R\$ 4,71



FIO DE SILICONE 0.5MM 10MTS 528801

Código: Fábrica: Unidade:  
**48550** KIT RL/1  
F1 F4

UN: R\$ 4,49 AV: R\$ 4,49 15: R\$ 4,58  
30: R\$ 4,67 45: R\$ 4,77 60: R\$ 4,86



FIO DE SILICONE 0.7MM 10MTS 309327

Código: Fábrica: Unidade:  
**48551** KIT RL/1  
F1 F4

UN: R\$ 4,98 AV: R\$ 4,98 15: R\$ 5,09  
30: R\$ 5,19 45: R\$ 5,29 60: R\$ 5,40



FIO DE SILICONE 1.0MM 10MTS 528803

Código: Fábrica: Unidade:  
**48552** KIT RL/1  
F1 F4

UN: R\$ 0,46 AV: R\$ 27,73 15: R\$ 28,31  
30: R\$ 28,88 45: R\$ 29,46 60: R\$ 30,05



FIO P/DECORAR UNHA 5117A 60X1

Código: Fábrica: Unidade:  
**27677** Y888 CX/60  
F1 F4

UN: R\$ 2,51 AV: R\$ 25,13 15: R\$ 25,65  
30: R\$ 26,16 45: R\$ 26,69 60: R\$ 27,22



FITA ISOLANTE 17MMX5MTS ANTI CHAMA10X1  
Código: 36465 Fábrica: BESTFER Unidade: PT/10  
F1 F4

UN: R\$ 4,10 AV: R\$ 4,10 15: R\$ 4,18  
30: R\$ 4,27 45: R\$ 4,35 60: R\$ 4,44



FITA ISOLANTE 18MMX10MTS ANTICHAMA 0012  
Código: 44311 Fábrica: ALLTAPE Unidade: PT/10  
F1 F4

UN: R\$ 7,69 AV: R\$ 7,69 15: R\$ 7,85  
30: R\$ 8,01 45: R\$ 8,17 60: R\$ 8,33



FITA ISOLANTE 18MMX20MTS ANTICHAMA 0013  
Código: 44312 Fábrica: ALLTAPE Unidade: UN/1  
F1 F4

UN: R\$ 2,88 AV: R\$ 28,83 15: R\$ 29,42  
30: R\$ 30,02 45: R\$ 30,61 60: R\$ 31,23



FITA ISOLANTE 18MMX5MTS ANTI CHAMA 10X1  
Código: 48682 Fábrica: PLANETA Unidade: PT/10  
F1 F4

UN: R\$ 1,89 AV: R\$ 1,89 15: R\$ 1,89  
30: R\$ 1,89 45: R\$ 1,89 60: R\$ 1,89



FITA ISOLANTE 18MMX5MTS ANTICHAMA 0011  
Código: 49892 Fábrica: ALLTAPE Unidade: UN/1  
F1 F4

UN: R\$ 5,65 AV: R\$ 56,49 15: R\$ 57,66  
30: R\$ 58,82 45: R\$ 59,99 60: R\$ 61,19



FITA ISOLANTE 19MMX10MTS 10X1  
Código: 48643 Fábrica: TEK BOND Unidade: PT/10  
F1 F4

UN: R\$ 9,66 AV: R\$ 96,55 15: R\$ 98,56  
30: R\$ 100,53 45: R\$ 102,54 60: R\$ 104,59



FITA ISOLANTE 19MMX20MTS 10X1  
Código: 48644 Fábrica: TEK BOND Unidade: PT/10  
F1 F4

UN: R\$ 3,03 AV: R\$ 30,30 15: R\$ 30,93  
30: R\$ 31,55 45: R\$ 32,18 60: R\$ 32,83



FITA ISOLANTE 19MMX5MTS 10X1  
Código: 48642 Fábrica: TEK BOND Unidade: PT/10  
F1 F4

UN: R\$ 1,63 AV: R\$ 1,63 15: R\$ 1,67  
30: R\$ 1,70 45: R\$ 1,73 60: R\$ 1,77



FITA VEDA ROSCA 12MMX10MTS NA CX  
Código: 50748 Fábrica: TEK BOND Unidade: UN/1  
F1 F4

UN: R\$ 1,99 AV: R\$ 1,99 15: R\$ 2,03  
30: R\$ 2,08 45: R\$ 2,12 60: R\$ 2,16



FITA VEDA ROSCA 18MMX10MTS NA CX  
Código: 50749 Fábrica: TEK BOND Unidade: UN/1  
F1 F4

UN: R\$ 3,07 AV: R\$ 3,07 15: R\$ 3,14  
30: R\$ 3,20 45: R\$ 3,26 60: R\$ 3,33



FITA VEDA ROSCA 18MMX50MTS NA CX  
Código: 50784 Fábrica: VEDALAR Unidade: UN/1  
F1 F4

UN: R\$ 12,32 AV: R\$ 12,32 15: R\$ 12,57  
30: R\$ 12,82 45: R\$ 13,08 60: R\$ 13,34



FLOR ARTIF BOUQUET ANTURIO 7 BOTOES18974  
Código: 36921 Fábrica: MABEL Unidade: UN/1  
F1 F4

UN: R\$ 28,71 AV: R\$ 28,71 15: R\$ 29,31  
30: R\$ 29,89 45: R\$ 30,49 60: R\$ 31,10



FLOR BOUGAINVILLEA RASP 98CM 11045  
Código: 48200 Fábrica: VIVA FLOR Unidade: UN/1  
F1 F4

UN: R\$ 24,44 AV: R\$ 24,44 15: R\$ 24,95  
30: R\$ 25,45 45: R\$ 25,95 60: R\$ 26,47



FLOR LIRIO 2 FLORES 50CM 11324/11304  
Código: 48202 Fábrica: VIVA FLOR Unidade: UN/1  
F1 F4

UN: R\$ 20,53 AV: R\$ 20,53 15: R\$ 20,96  
30: R\$ 21,38 45: R\$ 21,81 60: R\$ 22,24



FLOR ORQUIDEA 7 BOTOES 95CM 13083  
Código: 48198 Fábrica: VIVA FLOR Unidade: UN/1  
F1 F4

UN: R\$ 20,53 AV: R\$ 20,53 15: R\$ 20,96  
30: R\$ 21,38 45: R\$ 21,81 60: R\$ 22,24



FLOR RANUNCULO 5 BOTOES 11378  
Código: 48196 Fábrica: VIVA FLOR Unidade: UN/1  
F1 F4

UN: R\$ 2,35 AV: R\$ 2,35 15: R\$ 2,35  
30: R\$ 2,35 45: R\$ 2,35 60: R\$ 2,35



FLOR ROSA 1 BOTAO 55114 UN

Código: Fábrika: Unidade:  
**23144** ALMEGA UN/1  
F1 F4

UN: R\$ 16,42 AV: R\$ 16,42 15: R\$ 16,77  
30: R\$ 17,10 45: R\$ 17,44 60: R\$ 17,79

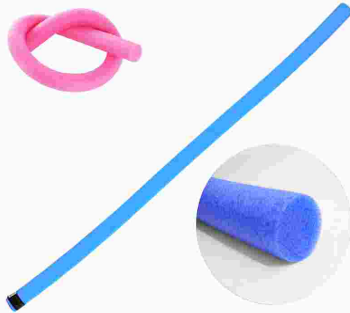

FLUTUADOR P/PISCINA ESPAGUETE 160X6CM

Código: Fábrika: Unidade:  
**48070** BEL UN/1  
F1 F4

UN: R\$ 50,18 AV: R\$ 50,18 15: R\$ 51,23  
30: R\$ 52,25 45: R\$ 53,30 60: R\$ 54,36



FONE HEADSET ARCO C/MICROFONE 2059

Código: Fábrika: Unidade:  
**35342** INOVA UN/1  
F1 F4

UN: R\$ 205,43 AV: R\$ 205,43 15: R\$ 209,71  
30: R\$ 213,90 45: R\$ 218,18 60: R\$ 222,55



FONE OUVIDO BLUETOOTH DC-BL1200

Código: Fábrika: Unidade:  
**50295** DOTCELL UN/1  
F1 F4

UN: R\$ 46,68 AV: R\$ 46,68 15: R\$ 47,65  
30: R\$ 48,61 45: R\$ 49,58 60: R\$ 50,57



FONE OUVIDO BLUETOOTH ESPORTIVO KA-S6

Código: Fábrika: Unidade:  
**40213** KAPBOM UN/1  
F1 F4

UN: R\$ 15,50 AV: R\$ 15,50 15: R\$ 15,82  
30: R\$ 16,14 45: R\$ 16,46 60: R\$ 16,79



FONE OUVIDO C/MICROFONE PRETO F50

Código: Fábrika: Unidade:  
**48893** DOTCELL UN/1  
F1 F4

UN: R\$ 8,75 AV: R\$ 8,75 15: R\$ 8,94  
30: R\$ 9,12 45: R\$ 9,30 60: R\$ 9,48



FONE OUVIDO C/MICROFONE SAQUINH 1031/241

Código: Fábrika: Unidade:  
**29791** INOVA UN/1  
F1 F4

UN: R\$ 19,09 AV: R\$ 19,09 15: R\$ 19,48  
30: R\$ 19,87 45: R\$ 20,27 60: R\$ 20,68



FONE OUVIDO C/MICROFONE VERMELHO F35

Código: Fábrika: Unidade:  
**48596** DOTCELL UN/1  
F1 F4

UN: R\$ 14,00 AV: R\$ 14,00 15: R\$ 14,29  
30: R\$ 14,57 45: R\$ 14,86 60: R\$ 15,16



FONE OUVIDO C/MICROFONE 2172/73/78/2069

Código: Fábrika: Unidade:  
**21269** INOVA UN/1  
F1 F4

UN: R\$ 11,66 AV: R\$ 11,66 15: R\$ 11,90  
30: R\$ 12,14 45: R\$ 12,38 60: R\$ 12,63



FONE OUVIDO C/MICROFONE 2318/9828/58

Código: Fábrika: Unidade:  
**47938** INOVA UN/1  
F1 F4

UN: R\$ 11,66 AV: R\$ 11,66 15: R\$ 11,90  
30: R\$ 12,14 45: R\$ 12,38 60: R\$ 12,63



FONE OUVIDO C/MICROFONE 6758/9851

Código: Fábrika: Unidade:  
**48440** INOVA UN/1  
F1 F4

UN: R\$ 14,00 AV: R\$ 14,00 15: R\$ 14,29  
30: R\$ 14,57 45: R\$ 14,86 60: R\$ 15,16



FONE OUVIDO C/MICROFONE 8659

Código: Fábrika: Unidade:  
**47393** INOVA UN/1  
F1 F4

UN: R\$ 14,00 AV: R\$ 14,00 15: R\$ 14,29  
30: R\$ 14,57 45: R\$ 14,86 60: R\$ 15,16



FONE OUVIDO C/MICROFONE 9919/17/20/254

Código: Fábrika: Unidade:  
**35610** INOVA UN/1  
F1 F4

UN: R\$ 46,21 AV: R\$ 46,21 15: R\$ 47,18  
30: R\$ 48,12 45: R\$ 49,08 60: R\$ 50,06



FONE OUVIDO HEADPHONE USB MICROF HP20

Código: Fábrika: Unidade:  
**48891** MOX UN/1  
F1 F4

UN: R\$ 122,23 AV: R\$ 122,23 15: R\$ 124,77  
30: R\$ 127,27 45: R\$ 129,81 60: R\$ 132,41



FONE OUVIDO HEADSET USB MICROF EMBUTIDO

Código: Fábrika: Unidade:  
**47174** LETRON UN/1  
F1 F4

UN: R\$ 21,42 AV: R\$ 21,42 15: R\$ 21,86  
30: R\$ 22,31 45: R\$ 22,75 60: R\$ 23,20



FONE OUVIDO P2 C/MICROFONE BRANCO 047B

Código: Fábrika: Unidade:  
**48575** MAKETECH UN/1  
F1 F4

UN: R\$ 21,42 AV: R\$ 21,42 15: R\$ 21,86  
30: R\$ 22,31 45: R\$ 22,75 60: R\$ 23,20



FONE OUVIDO P2 C/MICROFONE PRETO 047P

Código: 48576 Fábrica: MAKETECH Unidade: UN/1 F1 F4

UN: R\$ 0,06 AV: R\$ 61,62 15: R\$ 62,91  
30: R\$ 64,16 45: R\$ 65,45 60: R\$ 66,76



FORMINHA PAPEL N 0 BCA 10X100

Código: 30090 Fábrica: PEL PLAST Unidade: MI/1000 F1 F4

UN: R\$ 0,03 AV: R\$ 33,89 15: R\$ 34,59  
30: R\$ 35,29 45: R\$ 35,99 60: R\$ 36,71



FORMINHA PAPEL N 3 AZUL CLARO 10X100

Código: 8709 Fábrica: PEL PLAST Unidade: MI/1000 F1 F4

UN: R\$ 0,03 AV: R\$ 33,89 15: R\$ 34,59  
30: R\$ 35,29 45: R\$ 35,99 60: R\$ 36,71



FORMINHA PAPEL N 3 BCA 10X100

Código: 16086 Fábrica: PEL PLAST Unidade: MI/1000 F1 F4

UN: R\$ 0,03 AV: R\$ 33,89 15: R\$ 34,59  
30: R\$ 35,29 45: R\$ 35,99 60: R\$ 36,71



FORMINHA PAPEL N 3 ROSA 10X100

Código: 9719 Fábrica: PEL PLAST Unidade: MI/1000 F1 F4

UN: R\$ 0,02 AV: R\$ 19,51 15: R\$ 19,91  
30: R\$ 20,31 45: R\$ 20,72 60: R\$ 21,13



FORMINHA PAPEL N 5 AZUL CLARO 10X100

Código: 10049 Fábrica: PEL PLAST Unidade: MI/1000 F1 F4

UN: R\$ 0,02 AV: R\$ 19,51 15: R\$ 19,91  
30: R\$ 20,31 45: R\$ 20,72 60: R\$ 21,13



FORMINHA PAPEL N 5 BCA 10X100

Código: 10047 Fábrica: PEL PLAST Unidade: MI/1000 F1 F4

UN: R\$ 0,02 AV: R\$ 19,51 15: R\$ 19,91  
30: R\$ 20,31 45: R\$ 20,72 60: R\$ 21,13



FORMINHA PAPEL N 5 LILAS 10X100

Código: 25061 Fábrica: PEL PLAST Unidade: MI/1000 F1 F4

UN: R\$ 0,02 AV: R\$ 19,51 15: R\$ 19,91  
30: R\$ 20,31 45: R\$ 20,72 60: R\$ 21,13



FORMINHA PAPEL N 5 ROSA 10X100

Código: 10048 Fábrica: PEL PLAST Unidade: MI/1000 F1 F4

UN: R\$ 0,01 AV: R\$ 14,37 15: R\$ 14,67  
30: R\$ 14,96 45: R\$ 15,26 60: R\$ 15,57



FORMINHA PAPEL N 6 AZUL CLARO 10X100

Código: 10050 Fábrica: PEL PLAST Unidade: MI/1000 F1 F4

UN: R\$ 0,01 AV: R\$ 14,37 15: R\$ 14,67  
30: R\$ 14,96 45: R\$ 15,26 60: R\$ 15,57



FORMINHA PAPEL N 6 BCA 10X100

Código: 10052 Fábrica: PEL PLAST Unidade: MI/1000 F1 F4

UN: R\$ 0,01 AV: R\$ 14,37 15: R\$ 14,67  
30: R\$ 14,96 45: R\$ 15,26 60: R\$ 15,57



FORMINHA PAPEL N 6 LILAS 10X100

Código: 25062 Fábrica: PEL PLAST Unidade: MI/1000 F1 F4

UN: R\$ 14,37 AV: R\$ 14,37 15: R\$ 14,67  
30: R\$ 14,96 45: R\$ 15,26 60: R\$ 15,57



FORMINHA PAPEL N 6 ROSA 10X100

Código: 10051 Fábrica: PEL PLAST Unidade: MI/1 F1 F4

UN: R\$ 0,01 AV: R\$ 14,37 15: R\$ 14,67  
30: R\$ 14,96 45: R\$ 15,26 60: R\$ 15,57



FORMINHA PAPEL N 6 SORTIDO 10X100

Código: 50794 Fábrica: PEL PLAST Unidade: MI/1000 F1 F4

UN: R\$ 0,01 AV: R\$ 14,37 15: R\$ 14,67  
30: R\$ 14,96 45: R\$ 15,26 60: R\$ 15,57



FORMINHA PAPEL N 6 VERMELHO 10X100

Código: 50768 Fábrica: PELPLAST Unidade: MI/1000 F1 F4

UN: R\$ 36,90 AV: R\$ 36,90 15: R\$ 37,67  
30: R\$ 38,42 45: R\$ 39,19 60: R\$ 39,97



FORTELECEDOR DE MAOS FERRO PLAST 37057

Código: 48341 Fábrica: CONVOY SPORT Unidade: UN/1 F1 F4

UN: R\$ 10,85 AV: R\$ 10,85 15: R\$ 11,07  
30: R\$ 11,29 45: R\$ 11,52 60: R\$ 11,75



FORTALECEDOR DE MAOS 37060

Código: Fábrica: Unidade:  
**48340** CONVOY SPORT UN/1  
F1 F4

UN: R\$ 7,18 AV: R\$ 7,18 15: R\$ 7,33  
30: R\$ 7,48 45: R\$ 7,63 60: R\$ 7,78



FUSIVEL AUTOMOTIVO 6-24 VOLT 15 PCS 1333

Código: Fábrica: Unidade:  
**49561** ALIANCA CR/1  
F1 F4

UN: R\$ 2,85 AV: R\$ 5,70 15: R\$ 5,82  
30: R\$ 5,94 45: R\$ 6,05 60: R\$ 6,18



GANCHO PLAST 4CM EMOJI 7036-C CTL 3X1

Código: Fábrica: Unidade:  
**38457** FENIMA CR/2  
F1 F4

UN: R\$ 1,90 AV: R\$ 5,70 15: R\$ 5,82  
30: R\$ 5,94 45: R\$ 6,05 60: R\$ 6,18



GANCHO PLAST 4CM 7036-D CTL 3X1

Código: Fábrica: Unidade:  
**38454** FENIMA CR/3  
F1 F4

UN: R\$ 1,90 AV: R\$ 5,70 15: R\$ 5,82  
30: R\$ 5,94 45: R\$ 6,05 60: R\$ 6,18



GANCHO PLAST 5CM 7200 CTL 3X1

Código: Fábrica: Unidade:  
**38455** FENIMA CR/3  
F1 F4

UN: R\$ 8,21 AV: R\$ 8,21 15: R\$ 8,38  
30: R\$ 8,55 45: R\$ 8,72 60: R\$ 8,89



GRAFITE EM PO 25 GRS FORT FITE

Código: Fábrica: Unidade:  
**38883** FORT FITE UN/1  
F1 F4

UN: R\$ 0,51 AV: R\$ 12,33 15: R\$ 12,58  
30: R\$ 12,83 45: R\$ 13,09 60: R\$ 13,35

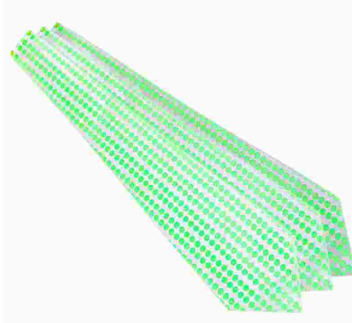

GRAVATA COLOR P/FESTAS 13681 24X1

Código: Fábrica: Unidade:  
**40307** IMP PT/24  
F4

UN: R\$ 20,53 AV: R\$ 20,53 15: R\$ 20,96  
30: R\$ 21,38 45: R\$ 21,81 60: R\$ 22,24



GUARDA CHUVA 8 V MINI CB CURV MAN 1300

Código: Fábrica: Unidade:  
**14086** ELITE UN/1  
F1 F4

UN: R\$ 17,99 AV: R\$ 17,99 15: R\$ 17,99  
30: R\$ 17,99 45: R\$ 17,99 60: R\$ 17,99



GUARDA CHUVA 8 V MINI CB RETO MAN 1295

Código: Fábrica: Unidade:  
**12056** ELITE UN/1  
F1 F4

UN: R\$ 25,99 AV: R\$ 25,99 15: R\$ 25,99  
30: R\$ 25,99 45: R\$ 25,99 60: R\$ 25,99



GUARDA CHUVA 8V GIG CB RETO AUT 1220A-3

Código: Fábrica: Unidade:  
**17676** RISOVIT UN/1  
F1 F4

UN: R\$ 27,72 AV: R\$ 27,72 15: R\$ 28,30  
30: R\$ 28,87 45: R\$ 29,45 60: R\$ 30,03



GUARDA CHUVA 8V LONG CB CURVO AUT 12203

Código: Fábrica: Unidade:  
**17651** HIMEB UN/1  
F1 F4

UN: R\$ 24,99 AV: R\$ 24,99 15: R\$ 24,99  
30: R\$ 24,99 45: R\$ 24,99 60: R\$ 24,99



GUARDA CHUVA 8V MED CB CURVO AUT 1241

Código: Fábrica: Unidade:  
**14095** ELITE UN/1  
F1 F4

UN: R\$ 27,72 AV: R\$ 27,72 15: R\$ 28,30  
30: R\$ 28,87 45: R\$ 29,45 60: R\$ 30,03



GUARDA CHUVA 8V MED CB CURVO AUT 2250

Código: Fábrica: Unidade:  
**17666** HIMEB UN/1  
F1 F4

UN: R\$ 23,62 AV: R\$ 23,62 15: R\$ 24,11  
30: R\$ 24,59 45: R\$ 25,08 60: R\$ 25,58



GUARDA CHUVA 8V MINI CB CURVO MAN 3930

Código: Fábrica: Unidade:  
**23002** HIMEB UN/1  
F1 F4

UN: R\$ 19,99 AV: R\$ 19,99 15: R\$ 19,99  
30: R\$ 19,99 45: R\$ 19,99 60: R\$ 19,99



GUARDA CHUVA 8V MINI CB RETO MAN 3950

Código: Fábrica: Unidade:  
**13271** HIMEB UN/1  
F1 F4

UN: R\$ 16,95 AV: R\$ 16,95 15: R\$ 17,30  
30: R\$ 17,65 45: R\$ 18,00 60: R\$ 18,36



GUARDA CHUVA 8V MINI CB RETO MAN 903.3

Código: Fábrica: Unidade:  
**14092** MIZPA UN/1  
F1 F4

UN: R\$ 44,16 AV: R\$ 44,16 15: R\$ 45,08  
30: R\$ 45,98 45: R\$ 46,90 60: R\$ 47,84



GUARDA CHUVA GIG BASTAO AUT G07/17/587

Código: Fábrika: Unidade:  
**12058** CHL UN/1  
F1 F4

UN: R\$ 13,99 AV: R\$ 13,99 15: R\$ 13,99  
30: R\$ 13,99 45: R\$ 13,99 60: R\$ 13,99



GUARDA CHUVA INF 1070AB

Código: Fábrika: Unidade:  
**23004** JL UN/1  
F1 F4

UN: R\$ 19,51 AV: R\$ 19,51 15: R\$ 19,91  
30: R\$ 20,31 45: R\$ 20,72 60: R\$ 21,13



GUARDA CHUVA INF 8V CB CURVO AUT 50001

Código: Fábrika: Unidade:  
**21990** CASITA UN/1  
F1 F4

UN: R\$ 41,08 AV: R\$ 41,08 15: R\$ 41,93  
30: R\$ 42,77 45: R\$ 43,63 60: R\$ 44,50



GUARDA CHUVA 10V GIG 3 DOBRA MAN 3750FIT

Código: Fábrika: Unidade:  
**31681** HIMEB UN/1  
F1 F4

UN: R\$ 0,95 AV: R\$ 47,72 15: R\$ 48,72  
30: R\$ 49,69 45: R\$ 50,69 60: R\$ 51,70



IMA 6X2MM RED PRATA CTL 14878-09 50X1

Código: Fábrika: Unidade:  
**48544** KIT CR/50  
F1 F4

UN: R\$ 2,47 AV: R\$ 2,47 15: R\$ 2,52  
30: R\$ 2,57 45: R\$ 2,62 60: R\$ 2,67



IMA DE GELADEIRA 3428 ANIMAIS VAR. PQ

Código: Fábrika: Unidade:  
**18110** BRASLU UN/1  
F1 F4

UN: R\$ 1,77 AV: R\$ 1,77 15: R\$ 1,80  
30: R\$ 1,84 45: R\$ 1,88 60: R\$ 1,91



IMA DE GELADEIRA 7216 BIC. AQUATICOS PQ

Código: Fábrika: Unidade:  
**18109** BRASLU UN/1  
F1 F4

UN: R\$ 0,25 AV: R\$ 24,75 15: R\$ 25,26  
30: R\$ 25,77 45: R\$ 26,28 60: R\$ 26,81



IMA 10X3MM RED PRETO CTL 14878-03 100X1

Código: Fábrika: Unidade:  
**48545** KIT CR/100  
F1 F4

UN: R\$ 0,27 AV: R\$ 27,25 15: R\$ 27,82  
30: R\$ 28,38 45: R\$ 28,94 60: R\$ 29,52



IMA 12X3MM RED PRETO CTL 14878-04 100X1

Código: Fábrika: Unidade:  
**48546** KIT CR/100  
F1 F4

UN: R\$ 2,36 AV: R\$ 23,62 15: R\$ 24,11  
30: R\$ 24,59 45: R\$ 25,08 60: R\$ 25,58



IMA 15MM BLISTER 10X1

Código: Fábrika: Unidade:  
**48274** STALO PT/10  
F1 F4

UN: R\$ 0,43 AV: R\$ 21,69 15: R\$ 22,15  
30: R\$ 22,59 45: R\$ 23,04 60: R\$ 23,50



IMA 15X3MM RED PRETO CTL 14878-05 50X1

Código: Fábrika: Unidade:  
**48547** KIT CR/50  
F1 F4

UN: R\$ 0,46 AV: R\$ 22,96 15: R\$ 23,44  
30: R\$ 23,90 45: R\$ 24,38 60: R\$ 24,87



IMA 18X3MM RED PRETO CTL 14878-06 50X1

Código: Fábrika: Unidade:  
**48548** KIT CR/50  
F1 F4

UN: R\$ 6,68 AV: R\$ 80,12 15: R\$ 81,79  
30: R\$ 83,43 45: R\$ 85,10 60: R\$ 86,80



IMA 2X8MMX1MT 20X1

Código: Fábrika: Unidade:  
**43399** DJW CT/12  
F1 F4

UN: R\$ 0,51 AV: R\$ 25,52 15: R\$ 26,05  
30: R\$ 26,57 45: R\$ 27,10 60: R\$ 27,64



IMA 20X3MM RED PRETO CTL 14878-07 50X1

Código: Fábrika: Unidade:  
**48549** KIT CR/50  
F1 F4

UN: R\$ 3,62 AV: R\$ 3,62 15: R\$ 3,69  
30: R\$ 3,76 45: R\$ 3,84 60: R\$ 3,92



INTERRUPTOR 2 TECLAS C/ PLACA REF 1347

Código: Fábrika: Unidade:  
**7820** BLACK BULL UN/1  
F1 F4

UN: R\$ 3,39 AV: R\$ 33,89 15: R\$ 34,59  
30: R\$ 35,29 45: R\$ 35,99 60: R\$ 36,71



ISQUEIRO COLOR DUCK 10X1

Código: Fábrika: Unidade:  
**37667** DUCK CT/10  
F1 F4

UN: R\$ 7,18 AV: R\$ 7,18 15: R\$ 7,33  
30: R\$ 7,48 45: R\$ 7,63 60: R\$ 7,78



KIT AGULHA BICO ENCHER BOLA 5PCS 3813

Código: Fábrica: Unidade:  
**40935** WINMAX CR/1  
F1 F4

UN: R\$ 5,02 AV: R\$ 5,02 15: R\$ 5,13  
30: R\$ 5,23 45: R\$ 5,33 60: R\$ 5,44



KIT DE REPAROS P/PNEU DE BICICLETA 3266

Código: Fábrica: Unidade:  
**34057** SQ CR/1  
F1 F4

UN: R\$ 154,07 AV: R\$ 154,07 15: R\$ 157,28  
30: R\$ 160,43 45: R\$ 163,63 60: R\$ 166,91

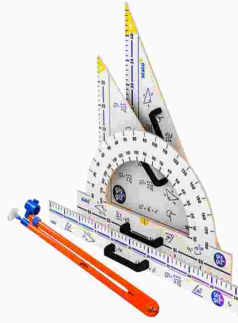

KIT INSTRUMENTO GEOMETRICO MDF PROF 4765

Código: Fábrica: Unidade:  
**49489** STALO UN/1  
F1 F4

UN: R\$ 5,24 AV: R\$ 5,24 15: R\$ 5,35  
30: R\$ 5,45 45: R\$ 5,56 60: R\$ 5,68



KIT REPARO PNEU DE BICICLETA 7X1 CTL 759

Código: Fábrica: Unidade:  
**37324** AGUIA BRANCA UN/1  
F1 F4

UN: R\$ 11,83 AV: R\$ 11,83 15: R\$ 12,08  
30: R\$ 12,32 45: R\$ 12,57 60: R\$ 12,82



KIT REPARO PNEU S/CAMERA 6X1 CTL HM60

Código: Fábrica: Unidade:  
**49478** HOME&MORE CR/1  
F1 F4

UN: R\$ 7,18 AV: R\$ 7,18 15: R\$ 7,33  
30: R\$ 7,48 45: R\$ 7,63 60: R\$ 7,78



LAMPADA BULBO LED 9W BIV 6500K BCA FRIA

Código: Fábrica: Unidade:  
**47386** TASCHIBRA UN/1  
F1 F4

UN: R\$ 10,26 AV: R\$ 10,26 15: R\$ 10,48  
30: R\$ 10,69 45: R\$ 10,90 60: R\$ 11,12



LAMPADA BULBO LED 20W BIV 6500K BCA FRIA

Código: Fábrica: Unidade:  
**47385** TECHLUZ UN/1  
F1 F4

UN: R\$ 16,42 AV: R\$ 16,42 15: R\$ 16,77  
30: R\$ 17,10 45: R\$ 17,44 60: R\$ 17,79



LAMPADA BULBO LED 30W BIV 6500K BCA FRIA

Código: Fábrica: Unidade:  
**47384** TECHLUZ/KIAN UN/1  
F1 F4

UN: R\$ 30,81 AV: R\$ 30,81 15: R\$ 31,45  
30: R\$ 32,08 45: R\$ 32,72 60: R\$ 33,37



LAMPADA BULBO LED 50W BIV 6500K BCA FRIA

Código: Fábrica: Unidade:  
**47383** TECHLUZ/AVAN UN/1  
F1 F4

UN: R\$ 38,01 AV: R\$ 38,01 15: R\$ 38,80  
30: R\$ 39,57 45: R\$ 40,37 60: R\$ 41,17



LANTERNA 1 LED FLASHLIGHT USB REC 1237

Código: Fábrica: Unidade:  
**40937** AGUIA BRANCA UN/1  
F1 F4

UN: R\$ 38,01 AV: R\$ 38,01 15: R\$ 38,80  
30: R\$ 39,57 45: R\$ 40,37 60: R\$ 41,17



LANTERNA 1 LED FLASHLIGHT USB REC 1268

Código: Fábrica: Unidade:  
**40938** AGUIA BRANCA UN/1  
F1 F4

UN: R\$ 23,08 AV: R\$ 23,08 15: R\$ 23,56  
30: R\$ 24,03 45: R\$ 24,51 60: R\$ 25,00



LANTERNA 1 LED 0.5W SS-850-1 314 RECARR

Código: Fábrica: Unidade:  
**33165** WINMAX UN/1  
F1 F4

UN: R\$ 19,51 AV: R\$ 19,51 15: R\$ 19,91  
30: R\$ 20,31 45: R\$ 20,72 60: R\$ 21,13



LANTERNA 1 LED 1W RECARREGAVEL BIV 4014

Código: Fábrica: Unidade:  
**50141** GP6 UN/1  
F1 F4

UN: R\$ 20,81 AV: R\$ 20,81 15: R\$ 21,24  
30: R\$ 21,67 45: R\$ 22,10 60: R\$ 22,55



LANTERNA 1 LED 1W RECARREGAVEL BIV 4015

Código: Fábrica: Unidade:  
**50142** GP6 UN/1  
F1 F4

UN: R\$ 60,60 AV: R\$ 60,60 15: R\$ 61,87  
30: R\$ 63,10 45: R\$ 64,37 60: R\$ 65,65



LANTERNA 1 LED 5W 24CM EXC PILHA ZW-443

Código: Fábrica: Unidade:  
**36443** AGUIA BRANCA UN/1  
F1 F4

UN: R\$ 78,07 AV: R\$ 78,07 15: R\$ 79,69  
30: R\$ 81,29 45: R\$ 82,91 60: R\$ 84,57



LANTERNA 1 LED 8000W VEIC POLICIAL RECA

Código: Fábrica: Unidade:  
**40863** WINMAX UN/1  
F1 F4

UN: R\$ 11,29 AV: R\$ 11,29 15: R\$ 11,52  
30: R\$ 11,75 45: R\$ 11,99 60: R\$ 12,23



LANTERNA 2 LED BC/VM BICICLETA 158 2X1  
Código: Fábrika: Unidade:  
**37287** AGUIA BRANCA UN/1  
F1 F4

UN: R\$ 30,81 AV: R\$ 30,81 15: R\$ 31,45  
30: R\$ 32,08 45: R\$ 32,72 60: R\$ 33,37



LANTERNA 2 LED MAN PORTATIL 1536/900  
Código: Fábrika: Unidade:  
**33649** AGUIA BRANCA UN/1  
F1 F4

UN: R\$ 2,04 AV: R\$ 2,04 15: R\$ 2,09  
30: R\$ 2,13 45: R\$ 2,17 60: R\$ 2,21



LANTERNA CHAVEIRO PLAST 1 LED 658  
Código: Fábrika: Unidade:  
**49981** VIPIMPORT UN/1  
F1 F4

UN: R\$ 9,43 AV: R\$ 113,17 15: R\$ 115,52  
30: R\$ 117,83 45: R\$ 120,19 60: R\$ 122,60



LANTERNA FORM INTERRUPTOR PILHA 166 12X1  
Código: Fábrika: Unidade:  
**34787** AGUIA BRANCA CX/12  
F1 F4

UN: R\$ 51,36 AV: R\$ 51,36 15: R\$ 52,43  
30: R\$ 53,48 45: R\$ 54,55 60: R\$ 55,64



LANTERNA USB BICICLETA C/BUZINA RECAR 11  
Código: Fábrika: Unidade:  
**40862** WINMAX UN/1  
F1 F4

UN: R\$ 22,29 AV: R\$ 22,29 15: R\$ 22,75  
30: R\$ 23,21 45: R\$ 23,67 60: R\$ 24,15



LANTERNA 1 LED 0,5W 14CM RECARR 3383  
Código: Fábrika: Unidade:  
**37076** SQ UN/1  
F1 F4

UN: R\$ 37,77 AV: R\$ 37,77 15: R\$ 38,56  
30: R\$ 39,33 45: R\$ 40,11 60: R\$ 40,92



LANTERNA 1 LED 2W CABECA RECAR 4196  
Código: Fábrika: Unidade:  
**49756** SQ UN/1  
F1 F4

UN: R\$ 9,24 AV: R\$ 27,72 15: R\$ 28,30  
30: R\$ 28,87 45: R\$ 29,45 60: R\$ 30,03



LENCO MASCULINO PREMIER P/BOLSO 2405 3X1  
Código: Fábrika: Unidade:  
**2097** PREMIER CX/3  
F1 F4

UN: R\$ 13,35 AV: R\$ 133,53 15: R\$ 136,31  
30: R\$ 139,03 45: R\$ 141,81 60: R\$ 144,65



LINHA NYLON PESCA 4,0 100M 0,33MM 10X1  
Código: Fábrika: Unidade:  
**30578** MAX FORCE CX/10  
F4

UN: R\$ 14,38 AV: R\$ 143,80 15: R\$ 146,79  
30: R\$ 149,73 45: R\$ 152,72 60: R\$ 155,78



LINHA NYLON PESCA 5,0 100M 0,37MM 10X1  
Código: Fábrika: Unidade:  
**19153** MAX FORCE CX/10  
F4

UN: R\$ 17,46 AV: R\$ 174,61 15: R\$ 178,25  
30: R\$ 181,82 45: R\$ 185,45 60: R\$ 189,16



LINHA NYLON PESCA 8 100M 0,47MM 10X1  
Código: Fábrika: Unidade:  
**44375** MAX FORCE CX/10  
F4

UN: R\$ 4,44 AV: R\$ 4,44 15: R\$ 4,53  
30: R\$ 4,62 45: R\$ 4,71 60: R\$ 4,81



LINHA NYLON PESCA 0,20MM 100M  
Código: Fábrika: Unidade:  
**43327** DOURADO RL/1  
F1 F4

UN: R\$ 4,88 AV: R\$ 4,88 15: R\$ 4,98  
30: R\$ 5,08 45: R\$ 5,18 60: R\$ 5,29



LINHA NYLON PESCA 0,25MM DOURADO 100M  
Código: Fábrika: Unidade:  
**47840** DOURADO RL/1  
F1 F4

UN: R\$ 7,81 AV: R\$ 7,81 15: R\$ 7,97  
30: R\$ 8,13 45: R\$ 8,29 60: R\$ 8,46



LINHA NYLON PESCA 0,3MM 200M  
Código: Fábrika: Unidade:  
**50045** NYBC RL/1  
F1 F4

UN: R\$ 5,55 AV: R\$ 5,55 15: R\$ 5,66  
30: R\$ 5,78 45: R\$ 5,89 60: R\$ 6,01



LINHA NYLON PESCA 0,30MM DOURADO 100M  
Código: Fábrika: Unidade:  
**47841** DOURADO RL/1  
F1 F4

UN: R\$ 6,42 AV: R\$ 6,42 15: R\$ 6,55  
30: R\$ 6,68 45: R\$ 6,82 60: R\$ 6,95



LINHA NYLON PESCA 0,35 DOURADO 100M  
Código: Fábrika: Unidade:  
**47842** DOURADO RL/1  
F1 F4

UN: R\$ 5,13 AV: R\$ 5,13 15: R\$ 5,23  
30: R\$ 5,34 45: R\$ 5,44 60: R\$ 5,55



LINHA NYLON PESCA 0.35MM 100M R-101  
Código: Fábrica: Unidade:  
**50042** NYBC RL/1  
F1 F4

UN: R\$ 32,86 AV: R\$ 32,86 15: R\$ 33,54  
30: R\$ 34,22 45: R\$ 34,90 60: R\$ 35,60



LINHA NYLON PESCA 0,35MM 800M 35-R-101  
Código: Fábrica: Unidade:  
**45091** NYBC RL/1  
F1 F4

UN: R\$ 5,39 AV: R\$ 5,39 15: R\$ 5,51  
30: R\$ 5,62 45: R\$ 5,73 60: R\$ 5,84



LINHA NYLON PESCA 0.4MM 100M  
Código: Fábrica: Unidade:  
**50041** NYBC RL/1  
F1 F4

UN: R\$ 5,64 AV: R\$ 5,64 15: R\$ 5,76  
30: R\$ 5,87 45: R\$ 5,99 60: R\$ 6,11



LINHA NYLON PESCA 0.45MM 100M  
Código: Fábrica: Unidade:  
**50043** NYBC RL/1  
F1 F4

UN: R\$ 6,15 AV: R\$ 6,15 15: R\$ 6,28  
30: R\$ 6,41 45: R\$ 6,53 60: R\$ 6,67



LINHA NYLON PESCA 0.5MM 100M  
Código: Fábrica: Unidade:  
**50044** NYBC RL/1  
F1 F4

UN: R\$ 21,57 AV: R\$ 215,70 15: R\$ 220,20  
30: R\$ 224,60 45: R\$ 229,09 60: R\$ 233,67



LINHA NYLON PESCA 10 100M 0,52MM 10X1  
Código: Fábrica: Unidade:  
**34077** MAX FORCE CX/10  
F4

UN: R\$ 24,65 AV: R\$ 246,52 15: R\$ 251,65  
30: R\$ 256,69 45: R\$ 261,82 60: R\$ 267,06



LINHA NYLON PESCA 14 100M 0,62MM 10X1  
Código: Fábrica: Unidade:  
**34078** MAX FORCE CX/10  
F4

UN: R\$ 42,11 AV: R\$ 421,14 15: R\$ 429,92  
30: R\$ 438,51 45: R\$ 447,28 60: R\$ 456,23



LINHA NYLON PESCA 30 100M 0,92MM 10X1  
Código: Fábrica: Unidade:  
**44105** MAX FORCE CX/10  
F4

UN: R\$ 8,82 AV: R\$ 8,82 15: R\$ 9,01  
30: R\$ 9,19 45: R\$ 9,37 60: R\$ 9,56



LINHA NYLON PESCA 30MMX100M 1547  
Código: Fábrica: Unidade:  
**41535** ELITE UN/1  
F1 F4

UN: R\$ 8,21 AV: R\$ 8,21 15: R\$ 8,38  
30: R\$ 8,55 45: R\$ 8,72 60: R\$ 8,89



LINHA NYLON PESCA 40 100M  
Código: Fábrica: Unidade:  
**47843** FBG RL/1  
F1 F4

UN: R\$ 17,46 AV: R\$ 174,61 15: R\$ 178,25  
30: R\$ 181,82 45: R\$ 185,45 60: R\$ 189,16



LINHA NYLON PESCA 5,5 100M 0,40MM 10X1  
Código: Fábrica: Unidade:  
**19148** MAX FORCE CX/10  
F4

UN: R\$ 16,43 AV: R\$ 164,34 15: R\$ 167,77  
30: R\$ 171,12 45: R\$ 174,54 60: R\$ 178,03



LINHA NYLON PESCA 6 MAX 100M 0,43MM 10X1  
Código: Fábrica: Unidade:  
**38944** MAX FORCE CX/10  
F4

UN: R\$ 3,58 AV: R\$ 3,58 15: R\$ 3,66  
30: R\$ 3,73 45: R\$ 3,81 60: R\$ 3,88

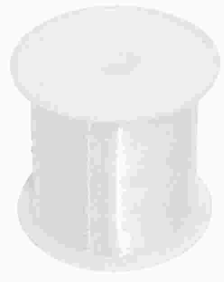

LINHA NYLON 0.20MM 100M 608020  
Código: Fábrica: Unidade:  
**48538** KIT RL/1  
F1 F4

UN: R\$ 4,47 AV: R\$ 4,47 15: R\$ 4,56  
30: R\$ 4,65 45: R\$ 4,75 60: R\$ 4,84

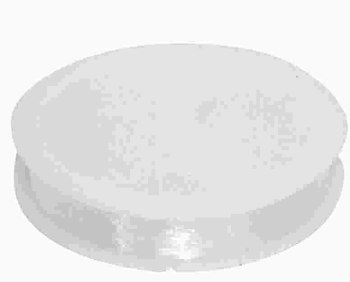

LINHA NYLON 0.25MM 100M 608025  
Código: Fábrica: Unidade:  
**48539** KIT RL/1  
F1 F4

UN: R\$ 5,07 AV: R\$ 5,07 15: R\$ 5,18  
30: R\$ 5,28 45: R\$ 5,39 60: R\$ 5,50

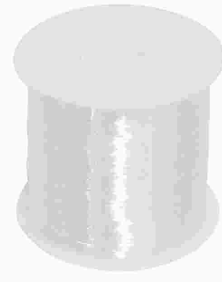

LINHA NYLON 0.30MM 100M 608030  
Código: Fábrica: Unidade:  
**48540** KIT RL/1  
F1 F4

UN: R\$ 7,00 AV: R\$ 7,00 15: R\$ 7,14  
30: R\$ 7,28 45: R\$ 7,43 60: R\$ 7,58



LINHA NYLON 0.35MM 100M 608035  
Código: Fábrica: Unidade:  
**48541** KIT RL/1  
F1 F4

UN: R\$ 8,47 AV: R\$ 8,47 15: R\$ 8,65  
30: R\$ 8,82 45: R\$ 9,00 60: R\$ 9,18



LINHA NYLON 0.40MM 100M 608040

Código: Fábrica: Unidade:  
**48542** KIT RL/1  
F1 F4

UN: R\$ 77,03 AV: R\$ 77,03 15: R\$ 78,63  
30: R\$ 80,21 45: R\$ 81,81 60: R\$ 83,45



LUMINARIA SOLAR C/SENSOR DE PRESENCIA

Código: Fábrica: Unidade:  
**44280** ALFACELL UN/1  
F1 F4

UN: R\$ 5,13 AV: R\$ 5,13 15: R\$ 5,23  
30: R\$ 5,34 45: R\$ 5,44 60: R\$ 5,55



LUPA 50MM LENTE OPTICA RX 5

Código: Fábrica: Unidade:  
**49396** CLASSE UN/1  
F1 F4

UN: R\$ 7,66 AV: R\$ 7,66 15: R\$ 7,82  
30: R\$ 7,98 45: R\$ 8,14 60: R\$ 8,30



LUPA 60MM 10003

Código: Fábrica: Unidade:  
**46733** WIN PAPER UN/1  
F1 F4

UN: R\$ 8,83 AV: R\$ 8,83 15: R\$ 9,02  
30: R\$ 9,20 45: R\$ 9,38 60: R\$ 9,57



LUPA 75MM 10002

Código: Fábrica: Unidade:  
**24140** WIN PAPER UN/1  
F1 F4

UN: R\$ 13,34 AV: R\$ 13,34 15: R\$ 13,62  
30: R\$ 13,89 45: R\$ 14,17 60: R\$ 14,46



LUPA 100MM 10001

Código: Fábrica: Unidade:  
**24141** WIN PAPER UN/1  
F1 F4

UN: R\$ 6,67 AV: R\$ 6,67 15: R\$ 6,81  
30: R\$ 6,94 45: R\$ 7,08 60: R\$ 7,22



LUPA 60MM FUY-31

Código: Fábrica: Unidade:  
**31766** FUTURO UN/1  
F1 F4

UN: R\$ 2,75 AV: R\$ 32,99 15: R\$ 32,99  
30: R\$ 32,99 45: R\$ 32,99 60: R\$ 32,99



LUVA ADULTO LISA 13 12 PARES

Código: Fábrica: Unidade:  
**14152** HSD PT/12  
F1 F4

UN: R\$ 2,50 AV: R\$ 29,99 15: R\$ 29,99  
30: R\$ 29,99 45: R\$ 29,99 60: R\$ 29,99



LUVA ADULTO MESCLADA 12 12 PARES

Código: Fábrica: Unidade:  
**22147** HSD PT/12  
F1 F4

UN: R\$ 12,99 AV: R\$ 12,99 15: R\$ 12,99  
30: R\$ 12,99 45: R\$ 12,99 60: R\$ 12,99



LUVA LA AD LISTRADA YX1301T

Código: Fábrica: Unidade:  
**44479** DOTAD UN/1  
F1 F4

UN: R\$ 18,99 AV: R\$ 18,99 15: R\$ 18,99  
30: R\$ 18,99 45: R\$ 18,99 60: R\$ 18,99



LUVA LA AD TOUCH VINTAGE PIGMEN YX1307EM

Código: Fábrica: Unidade:  
**44480** DOTAD UN/1  
F1 F4

UN: R\$ 12,11 AV: R\$ 12,11 15: R\$ 12,36  
30: R\$ 12,61 45: R\$ 12,86 60: R\$ 13,12



LUVA LA AD UNISSEX YX1349TRI

Código: Fábrica: Unidade:  
**44462** DOTAD UN/1  
F1 F4

UN: R\$ 10,99 AV: R\$ 10,99 15: R\$ 10,99  
30: R\$ 10,99 45: R\$ 10,99 60: R\$ 10,99



LUVA LA ADULTO TRAD ESTAMPADA 3005

Código: Fábrica: Unidade:  
**44476** GLX UN/1  
F1 F4

UN: R\$ 6,99 AV: R\$ 6,99 15: R\$ 6,99  
30: R\$ 6,99 45: R\$ 6,99 60: R\$ 6,99



LUVA LA INF DEDO VAZADO YX0201-1

Código: Fábrica: Unidade:  
**44465** DOTAD UN/1  
F1 F4

UN: R\$ 10,27 AV: R\$ 102,71 15: R\$ 104,85  
30: R\$ 106,95 45: R\$ 109,09 60: R\$ 111,27



LUVA LA INFANTIL BICHINHO G 3059 10X1

Código: Fábrica: Unidade:  
**41827** GLX PT/10  
F1 F4

UN: R\$ 10,27 AV: R\$ 102,71 15: R\$ 104,85  
30: R\$ 106,95 45: R\$ 109,09 60: R\$ 111,27



LUVA LA INFANTIL BICHINHO M 3059 10X1

Código: Fábrica: Unidade:  
**41825** GLX PT/10  
F1 F4

UN: R\$ 9,00 AV: R\$ 89,99 15: R\$ 89,99  
30: R\$ 89,99 45: R\$ 89,99 60: R\$ 89,99



LUVA LA INFANTIL BICHINHO P 3059 10X1  
Código: Fábrica: Unidade:  
**41826** GLX PT/10 UN/1  
F1 F4

UN: R\$ 10,26 AV: R\$ 10,26 15: R\$ 10,48  
30: R\$ 10,69 45: R\$ 10,90 60: R\$ 11,12



LUVA LA INFANTIL LUXO P/FRIO 828  
Código: Fábrica: Unidade:  
**6689** RIO MASTER UN/1  
F1 F4

UN: R\$ 3,89 AV: R\$ 3,89 15: R\$ 3,97  
30: R\$ 4,05 45: R\$ 4,13 60: R\$ 4,22



LUVA LATEX MULTI USO AZUL G/9 UN  
Código: Fábrica: Unidade:  
**50824** VOLK BRASIL UN/1  
F1 F4

UN: R\$ 3,89 AV: R\$ 3,89 15: R\$ 3,97  
30: R\$ 4,05 45: R\$ 4,13 60: R\$ 4,22



LUVA LATEX MULTI USO AZUL P/7 UN  
Código: Fábrica: Unidade:  
**50825** VOLK BRASIL UN/1  
F1 F4

UN: R\$ 8,53 AV: R\$ 8,53 15: R\$ 8,70  
30: R\$ 8,88 45: R\$ 9,05 60: R\$ 9,24



LUVA LATEX P M G  
Código: Fábrica: Unidade:  
**41678** IMBAT UN/1  
F1 F4

UN: R\$ 3,89 AV: R\$ 3,89 15: R\$ 3,97  
30: R\$ 4,05 45: R\$ 4,13 60: R\$ 4,22



LUVA LATEX SLIM AMARELA M/8 38828 UN  
Código: Fábrica: Unidade:  
**30328** NOBRE UN/1  
F1 F4

UN: R\$ 3,89 AV: R\$ 3,89 15: R\$ 3,97  
30: R\$ 4,05 45: R\$ 4,13 60: R\$ 4,22



LUVA LATEX SLIM AMARELA P 38827 UN  
Código: Fábrica: Unidade:  
**44096** NOBRE UN/1  
F1 F4

UN: R\$ 3,89 AV: R\$ 3,89 15: R\$ 3,97  
30: R\$ 4,05 45: R\$ 4,13 60: R\$ 4,22



LUVA LATEX SLIM VERDE P/7 37972 UN  
Código: Fábrica: Unidade:  
**47824** NOBRE UN/1  
F1 F4

UN: R\$ 34,99 AV: R\$ 34,99 15: R\$ 34,99  
30: R\$ 34,99 45: R\$ 34,99 60: R\$ 34,99



LUVA MOTOQUEIRO EMBORRACHADA 0127  
Código: Fábrica: Unidade:  
**44498** LURS UN/1  
F1 F4

UN: R\$ 25,99 AV: R\$ 25,99 15: R\$ 25,99  
30: R\$ 25,99 45: R\$ 25,99 60: R\$ 25,99



LUVA MOTOQUEIRO POLIESTER PS0140EM  
Código: Fábrica: Unidade:  
**44464** DOTAD UN/1  
F1 F4

UN: R\$ 24,64 AV: R\$ 24,64 15: R\$ 25,16  
30: R\$ 25,66 45: R\$ 26,17 60: R\$ 26,70



LUVA MOTOQUEIRO POLIESTER PS2310-SP  
Código: Fábrica: Unidade:  
**44463** DOTAD UN/1  
F1 F4

UN: R\$ 16,44 AV: R\$ 16,44 15: R\$ 16,78  
30: R\$ 17,11 45: R\$ 17,46 60: R\$ 17,80



LUVA P/NOTEBOOK C/ZIPER 11 DINA NINA  
Código: Fábrica: Unidade:  
**17754** MAXIMA UN/1  
F1 F4

UN: R\$ 16,95 AV: R\$ 16,95 15: R\$ 17,30  
30: R\$ 17,65 45: R\$ 18,00 60: R\$ 18,36



LUVA P/NOTEBOOK C/ZIPER 14 DINA NINA  
Código: Fábrica: Unidade:  
**25669** MAXIMA UN/1  
F1 F4

UN: R\$ 16,95 AV: R\$ 16,95 15: R\$ 17,30  
30: R\$ 17,65 45: R\$ 18,00 60: R\$ 18,36



LUVA P/NOTEBOOK C/ZIPER 15,6 DINA NINA  
Código: Fábrica: Unidade:  
**7056** MAXIMA UN/1  
F1 F4

UN: R\$ 4,28 AV: R\$ 51,35 15: R\$ 52,42  
30: R\$ 53,47 45: R\$ 54,54 60: R\$ 55,63



LUVA TRICOTADA LEVE BRANCA 12 PARES  
Código: Fábrica: Unidade:  
**38667** IMBAT PT/12 UN/1  
F1 F4

UN: R\$ 2,99 AV: R\$ 35,88 15: R\$ 35,88  
30: R\$ 35,88 45: R\$ 35,88 60: R\$ 35,88

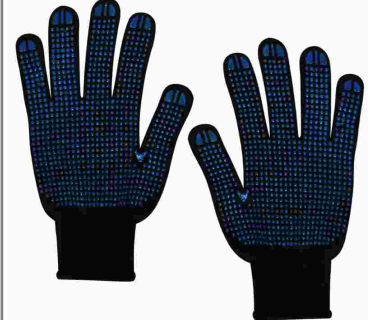

LUVA TRICOTADA LEVE PRETA PIG 763 12PARE  
Código: Fábrica: Unidade:  
**41937** IMBAT PT/12 UN/1  
F1 F4

UN: R\$ 6,15 AV: R\$ 6,15 15: R\$ 6,28  
30: R\$ 6,41 45: R\$ 6,53 60: R\$ 6,67

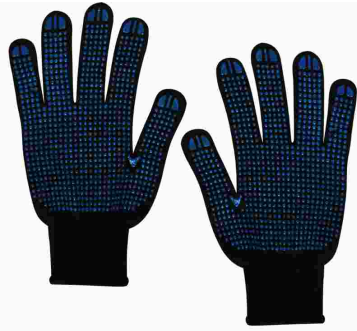

LUVA TRICOTADA PRETA C/PIGMENTADA 1 PAR

Código: Fábrica: Unidade:  
**41760** IMBAT UN/1  
F1 F4

UN: R\$ 5,14 AV: R\$ 61,62 15: R\$ 62,91  
30: R\$ 64,16 45: R\$ 65,45 60: R\$ 66,76

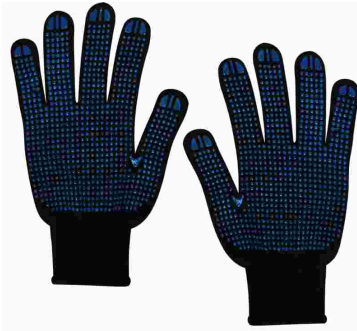

LUVA TRICOTADA PRETA PIG 762 12 PARES

Código: Fábrica: Unidade:  
**38669** IMBAT PT/12  
F1 F4

UN: R\$ 307,13 AV: R\$ 307,13 15: R\$ 313,53  
30: R\$ 319,80 45: R\$ 326,20 60: R\$ 332,72



MALA VIAGEM AEROP AZUL GDE 27"

Código: Fábrica: Unidade:  
**33667** VIAGGIO UN/1  
F1 F4

UN: R\$ 215,71 AV: R\$ 215,71 15: R\$ 220,21  
30: R\$ 224,61 45: R\$ 229,10 60: R\$ 233,68



MALA VIAGEM AEROP AZUL PEQ 19"

Código: Fábrica: Unidade:  
**33661** VIAGGIO UN/1  
F1 F4

UN: R\$ 699,99 AV: R\$ 699,99 15: R\$ 699,99  
30: R\$ 699,99 45: R\$ 699,99 60: R\$ 699,99



MALA VIAGEM AEROP AZUL 19/23/27" 3X1

Código: Fábrica: Unidade:  
**48520** VIAGGIO CJ/1  
F1 F4

UN: R\$ 347,52 AV: R\$ 347,52 15: R\$ 354,76  
30: R\$ 361,85 45: R\$ 369,09 60: R\$ 376,47



MALA VIAGEM AEROP LARANJ 19" ABS360° 10H

Código: Fábrica: Unidade:  
**37693** WILSON UN/1  
F1 F4

UN: R\$ 307,13 AV: R\$ 307,13 15: R\$ 313,53  
30: R\$ 319,80 45: R\$ 326,20 60: R\$ 332,72



MALA VIAGEM AEROP MARRON GDE 27"

Código: Fábrica: Unidade:  
**48601** VIAGGIO UN/1  
F1 F4

UN: R\$ 261,04 AV: R\$ 261,04 15: R\$ 266,48  
30: R\$ 271,81 45: R\$ 277,25 60: R\$ 282,79



MALA VIAGEM AEROP MARRON MED 23"

Código: Fábrica: Unidade:  
**48600** VIAGGIO UN/1  
F1 F4

UN: R\$ 215,71 AV: R\$ 215,71 15: R\$ 220,21  
30: R\$ 224,61 45: R\$ 229,10 60: R\$ 233,68



MALA VIAGEM AEROP MARRON PEQ 19"

Código: Fábrica: Unidade:  
**48602** VIAGGIO UN/1  
F1 F4

UN: R\$ 699,99 AV: R\$ 699,99 15: R\$ 699,99  
30: R\$ 699,99 45: R\$ 699,99 60: R\$ 699,99



MALA VIAGEM AEROP MARRON 19/23/27" 3X1

Código: Fábrica: Unidade:  
**42573** VIAGGIO CJ/1  
F1 F4

UN: R\$ 699,99 AV: R\$ 699,99 15: R\$ 699,99  
30: R\$ 699,99 45: R\$ 699,99 60: R\$ 699,99



MALA VIAGEM AEROP PRETA 19/23/27" 3X1

Código: Fábrica: Unidade:  
**40340** VIAGGIO CJ/1  
F1 F4

UN: R\$ 1042,57 AV: R\$ 1042,57 15: R\$ 1064,29  
30: R\$ 1085,58 45: R\$ 1107,29 60: R\$ 1129,43



MALA VIAGEM AEROP PRETA 19/23/27" 3X1

Código: Fábrica: Unidade:  
**43665** MALAS MUNDI CJ/1  
F1 F4

UN: R\$ 297,89 AV: R\$ 297,89 15: R\$ 304,09  
30: R\$ 310,18 45: R\$ 316,38 60: R\$ 322,71



MALA VIAGEM AEROP PRETO GDE 27"

Código: Fábrica: Unidade:  
**33665** VIAGGIO UN/1  
F1 F4

UN: R\$ 261,04 AV: R\$ 261,04 15: R\$ 266,48  
30: R\$ 271,81 45: R\$ 277,25 60: R\$ 282,79



MALA VIAGEM AEROP PRETO MED 23"

Código: Fábrica: Unidade:  
**33662** VAGGIO UN/1  
F1 F4

UN: R\$ 215,71 AV: R\$ 215,71 15: R\$ 220,21  
30: R\$ 224,61 45: R\$ 229,10 60: R\$ 233,68



MALA VIAGEM AEROP PRETO PEQ 19"

Código: Fábrica: Unidade:  
**33659** VAGGIO UN/1  
F1 F4

UN: R\$ 579,20 AV: R\$ 579,20 15: R\$ 591,27  
30: R\$ 603,09 45: R\$ 615,15 60: R\$ 627,46



MALA VIAGEM AEROP PRETO 19/23" 2X1

Código: Fábrica: Unidade:  
**38257** SPEXPRESS CJ/1  
F1 F4

UN: R\$ 58,35 AV: R\$ 58,35 15: R\$ 59,57  
30: R\$ 60,76 45: R\$ 61,97 60: R\$ 63,21



MANETE JOGOS USB 203Z

Código: Fábriça: Unidade:  
**42195** INOVA UN/1  
F1 F4

UN: R\$ 5,13 AV: R\$ 5,13 15: R\$ 5,23  
30: R\$ 5,34 45: R\$ 5,44 60: R\$ 5,55



MANGUEIRA DE BOMBA ENCHER PNEU 50CM 1359

Código: Fábriça: Unidade:  
**30685** BESTFER UN/1  
F1 F4

UN: R\$ 12,32 AV: R\$ 12,32 15: R\$ 12,57  
30: R\$ 12,82 45: R\$ 13,08 60: R\$ 13,34



MANGUITO (MANGA PROTECAO SOLAR P/BRACOS)

Código: Fábriça: Unidade:  
**31765** CJL UN/1  
F1 F4

UN: R\$ 4,52 AV: R\$ 27,10 15: R\$ 27,66  
30: R\$ 28,21 45: R\$ 28,78 60: R\$ 29,35



MAOZINHA COCA COCA PLAST COLOR 12X1

Código: Fábriça: Unidade:  
**39696** ITALY'S PT/6  
F1 F4

UN: R\$ 45,09 AV: R\$ 45,09 15: R\$ 46,03  
30: R\$ 46,95 45: R\$ 47,89 60: R\$ 48,85



MASSA P/BISCUIT 1 KG NATURAL

Código: Fábriça: Unidade:  
**50385** POLYCOL PT/1  
F1 F4

UN: R\$ 4,10 AV: R\$ 4,10 15: R\$ 4,18  
30: R\$ 4,27 45: R\$ 4,35 60: R\$ 4,44



MEIA AEROBICA DEFENDER ALGODAO 5246

Código: Fábriça: Unidade:  
**35470** APOLLO UN/1  
F1 F4

UN: R\$ 4,04 AV: R\$ 12,13 15: R\$ 12,38  
30: R\$ 12,63 45: R\$ 12,88 60: R\$ 13,14



MEIA AEROBICA DEFENDER ALGODAO 5246 3X1

Código: Fábriça: Unidade:  
**35467** APOLLO PT/3  
F1 F4

UN: R\$ 5,88 AV: R\$ 5,88 15: R\$ 6,00  
30: R\$ 6,12 45: R\$ 6,24 60: R\$ 6,37



MEIA AEROBICA FEM 33A38 850

Código: Fábriça: Unidade:  
**32723** APOLLO UN/1  
F1 F4

UN: R\$ 10,27 AV: R\$ 10,27 15: R\$ 10,49  
30: R\$ 10,70 45: R\$ 10,91 60: R\$ 11,13



MEIA CALÇA GEOMETRICA 17468

Código: Fábriça: Unidade:  
**40683** ACTIONWEAR UN/1  
F1 F4

UN: R\$ 20,53 AV: R\$ 20,53 15: R\$ 20,96  
30: R\$ 21,38 45: R\$ 21,81 60: R\$ 22,24



MEIA CANO CURTO PRO BIKE NO LIMITS 5161

Código: Fábriça: Unidade:  
**32719** FLINDERS UN/1  
F1 F4

UN: R\$ 3,60 AV: R\$ 3,60 15: R\$ 3,67  
30: R\$ 3,74 45: R\$ 3,82 60: R\$ 3,89



MEIA ESPORTIVA JUVENIL 546

Código: Fábriça: Unidade:  
**15908** APOLLO UN/1  
F1 F4

UN: R\$ 6,16 AV: R\$ 6,16 15: R\$ 6,29  
30: R\$ 6,42 45: R\$ 6,55 60: R\$ 6,68



MEIA FEMININA FINA 3/4 POA

Código: Fábriça: Unidade:  
**15801** ACTIONWEAR UN/1  
F1 F4

UN: R\$ 0,83 AV: R\$ 9,99 15: R\$ 9,99  
30: R\$ 9,99 45: R\$ 9,99 60: R\$ 9,99



MEIA INF SOCIAL STILLO KIDS 403 12X1

Código: Fábriça: Unidade:  
**10691** STILLO DZ/12  
F1 F4

UN: R\$ 4,28 AV: R\$ 51,35 15: R\$ 52,42  
30: R\$ 53,47 45: R\$ 54,54 60: R\$ 55,63



MEIA INFANTIL DEC FEM P/M/G 881 12X1

Código: Fábriça: Unidade:  
**32720** APOLLO PT/12  
F1 F4

UN: R\$ 4,28 AV: R\$ 51,35 15: R\$ 52,42  
30: R\$ 53,47 45: R\$ 54,54 60: R\$ 55,63



MEIA INFANTIL DEC MASC P/M/G 874 12X1

Código: Fábriça: Unidade:  
**32721** APOLLO PT/12  
F1 F4

UN: R\$ 3,96 AV: R\$ 11,88 15: R\$ 12,13  
30: R\$ 12,37 45: R\$ 12,62 60: R\$ 12,87



MEIA MASC DEFENDER ALGODAO 5215 3X1

Código: Fábriça: Unidade:  
**35466** APOLLO PT/3  
F1 F4

UN: R\$ 3,89 AV: R\$ 3,89 15: R\$ 3,97  
30: R\$ 4,05 45: R\$ 4,13 60: R\$ 4,22



MEIA MASC DEFENDER ALGODAO 5215/5314  
Código: Fábrica: Unidade:  
**35471** APOLLO UN/1  
F1 F4

UN: R\$ 5,01 AV: R\$ 5,01 15: R\$ 5,12  
30: R\$ 5,22 45: R\$ 5,32 60: R\$ 5,43



MEIA MASC INV ALGODAO 584  
Código: Fábrica: Unidade:  
**33904** APOLLO UN/1  
F1 F4

UN: R\$ 3,54 AV: R\$ 3,54 15: R\$ 3,62  
30: R\$ 3,69 45: R\$ 3,76 60: R\$ 3,84



MEIA MASC INV DEFENDER ALGODAO 5222  
Código: Fábrica: Unidade:  
**35469** APOLLO UN/1  
F1 F4

UN: R\$ 3,54 AV: R\$ 10,63 15: R\$ 10,85  
30: R\$ 11,07 45: R\$ 11,29 60: R\$ 11,52



MEIA MASC INV DEFENDER ALGODAO 5222 3X1  
Código: Fábrica: Unidade:  
**35468** APOLLO PT/3  
F1 F4

UN: R\$ 4,61 AV: R\$ 4,61 15: R\$ 4,71  
30: R\$ 4,80 45: R\$ 4,90 60: R\$ 5,00



MEIA SAPATILHA FEM ALGODAO 607  
Código: Fábrica: Unidade:  
**27819** APOLLO UN/1  
F1 F4

UN: R\$ 5,47 AV: R\$ 16,42 15: R\$ 16,77  
30: R\$ 17,10 45: R\$ 17,44 60: R\$ 17,79



MEIA SAPATILHA FEM C/ELASTANO 5024 3X1  
Código: Fábrica: Unidade:  
**15802** APOLLO PT/3  
F1 F4

UN: R\$ 4,28 AV: R\$ 51,35 15: R\$ 52,42  
30: R\$ 53,47 45: R\$ 54,54 60: R\$ 55,63



MEIA SAPATILHA FEM INF 27A34 5055 12X1  
Código: Fábrica: Unidade:  
**32725** APOLLO PT/12  
F1 F4

UN: R\$ 3,24 AV: R\$ 3,24 15: R\$ 3,30  
30: R\$ 3,37 45: R\$ 3,44 60: R\$ 3,51



MEIA SAPATILHA FEM JUVENIL 0089  
Código: Fábrica: Unidade:  
**22160** APOLLO UN/1  
F1 F4

UN: R\$ 1,12 AV: R\$ 1,12 15: R\$ 1,14  
30: R\$ 1,17 45: R\$ 1,19 60: R\$ 1,21



MEIA SAPATILHA FEM MEIA FINA PEZINHO  
Código: Fábrica: Unidade:  
**1798** CRUZEIRO UN/1  
F1 F4

UN: R\$ 7,49 AV: R\$ 7,49 15: R\$ 7,64  
30: R\$ 7,80 45: R\$ 7,95 60: R\$ 8,11



MEIA SAPATILHA MASC FITN 38A43 5086  
Código: Fábrica: Unidade:  
**45276** APOLLO UN/1  
F1 F4

UN: R\$ 4,28 AV: R\$ 51,35 15: R\$ 52,42  
30: R\$ 53,47 45: R\$ 54,54 60: R\$ 55,63



MEIA SAPATILHA MASC INF 31A34 5062 12X1  
Código: Fábrica: Unidade:  
**32724** APOLLO PT/12  
F1 F4

UN: R\$ 5,13 AV: R\$ 5,13 15: R\$ 5,23  
30: R\$ 5,34 45: R\$ 5,44 60: R\$ 5,55



MEIA SAPATILHA MASC INV ALGODAO 553  
Código: Fábrica: Unidade:  
**24551** APOLLO UN/1  
F1 F4

UN: R\$ 4,79 AV: R\$ 28,75 15: R\$ 29,35  
30: R\$ 29,94 45: R\$ 30,54 60: R\$ 31,15



MEIA SAPATILHA MASC INVISIVEL 5284 6X1  
Código: Fábrica: Unidade:  
**45277** APOLLO PT/6  
F1 F4

UN: R\$ 5,00 AV: R\$ 14,99 15: R\$ 15,30  
30: R\$ 15,61 45: R\$ 15,92 60: R\$ 16,24



MEIA SAPATILHA MASC INVISIVEL 997 3X1  
Código: Fábrica: Unidade:  
**15803** APOLLO PT/3  
F1 F4

UN: R\$ 9,23 AV: R\$ 9,23 15: R\$ 9,43  
30: R\$ 9,62 45: R\$ 9,81 60: R\$ 10,00



MEIA SAPATILHA MASC NO LIMITS 38A43 5192  
Código: Fábrica: Unidade:  
**32722** FLINDERS UN/1  
F1 F4

UN: R\$ 7,70 AV: R\$ 92,44 15: R\$ 94,36  
30: R\$ 96,25 45: R\$ 98,18 60: R\$ 100,14



MEIA SOCIAL MASC 5109 12X1  
Código: Fábrica: Unidade:  
**128** APOLLO PT/12  
F1 F4

UN: R\$ 4,61 AV: R\$ 4,61 15: R\$ 4,71  
30: R\$ 4,80 45: R\$ 4,90 60: R\$ 5,00



MEIA SOQUETE FEM ALGODAO 34A39 539  
Código: Fábrica: Unidade:  
**33488** APOLLO UN/1  
F1 F4

UN: R\$ 26,70 AV: R\$ 26,70 15: R\$ 27,25  
30: R\$ 27,80 45: R\$ 28,35 60: R\$ 28,92



MICROFONE C/FIO DINAMICO NA CX 969M  
Código: Fábrica: Unidade:  
**13527** IDEA UN/1  
F1 F4

UN: R\$ 7,95 AV: R\$ 7,95 15: R\$ 7,95  
30: R\$ 7,95 45: R\$ 7,95 60: R\$ 7,95



MOCHILA SACO PISCINA (PORTA CHUTEIRA)  
Código: Fábrica: Unidade:  
**44334** WEAREEYES UN/1  
F1 F4

UN: R\$ 18,52 AV: R\$ 18,52 15: R\$ 18,91  
30: R\$ 19,29 45: R\$ 19,67 60: R\$ 20,07



MOCHILA SACO PISCINA (PORTA CHUTEIRA)  
Código: Fábrica: Unidade:  
**22145** CJL UN/1  
F1 F4

UN: R\$ 55,46 AV: R\$ 55,46 15: R\$ 56,61  
30: R\$ 57,75 45: R\$ 58,90 60: R\$ 60,08



MOLINETE BH200 1 ROL  
Código: Fábrica: Unidade:  
**5759** TAUE CX/1  
F4

UN: R\$ 5,13 AV: R\$ 5,13 15: R\$ 5,23  
30: R\$ 5,34 45: R\$ 5,44 60: R\$ 5,55



MUNHEQUEIRA 12 CM 10614  
Código: Fábrica: Unidade:  
**44522** NICOBEM UN/1  
F1 F4

UN: R\$ 84,23 AV: R\$ 84,23 15: R\$ 85,99  
30: R\$ 87,70 45: R\$ 89,46 60: R\$ 91,25



MURAL C/8 PORTA RET 10X15+1 20X25 MAD 09  
Código: Fábrica: Unidade:  
**35182** MM QUADROS UN/1  
F1 F4

UN: R\$ 4,79 AV: R\$ 4,79 15: R\$ 4,79  
30: R\$ 4,79 45: R\$ 4,79 60: R\$ 4,79



NAFTALINA 50 GRS APROX 30 BOLAS  
Código: Fábrica: Unidade:  
**49341** SANILAR PT/1  
F1 F4

UN: R\$ 31,84 AV: R\$ 31,84 15: R\$ 32,51  
30: R\$ 33,16 45: R\$ 33,82 60: R\$ 34,50

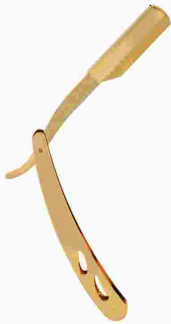

NAVALHETE PROF DOURADA  
Código: Fábrica: Unidade:  
**40751** OSTRICH UN/1  
F1 F4

UN: R\$ 18,28 AV: R\$ 18,28 15: R\$ 18,67  
30: R\$ 19,04 45: R\$ 19,42 60: R\$ 19,81



NECESSAIRE C/DIVISORIAS 19000  
Código: Fábrica: Unidade:  
**36839** GLX UN/1  
F1 F4

UN: R\$ 15,75 AV: R\$ 15,75 15: R\$ 16,08  
30: R\$ 16,40 45: R\$ 16,72 60: R\$ 17,06



NECESSAIRE ESTAMPADA OVAL 19002  
Código: Fábrica: Unidade:  
**37770** FELE UN/1  
F1 F4

UN: R\$ 13,99 AV: R\$ 13,99 15: R\$ 13,99  
30: R\$ 13,99 45: R\$ 13,99 60: R\$ 13,99



NECESSAIRE ESTAMPADA QUAD 19002  
Código: Fábrica: Unidade:  
**37755** FELE UN/1  
F1 F4

UN: R\$ 12,33 AV: R\$ 12,33 15: R\$ 12,58  
30: R\$ 12,83 45: R\$ 13,09 60: R\$ 13,35



OCULOS ESPORTIVO  
Código: Fábrica: Unidade:  
**25525** CJL UN/1  
F1 F4

UN: R\$ 12,84 AV: R\$ 12,84 15: R\$ 13,11  
30: R\$ 13,37 45: R\$ 13,64 60: R\$ 13,91



OCULOS GRAU 0,25  
Código: Fábrica: Unidade:  
**26391** CJL UN/1  
F4

UN: R\$ 12,84 AV: R\$ 12,84 15: R\$ 13,11  
30: R\$ 13,37 45: R\$ 13,64 60: R\$ 13,91



OCULOS GRAU 0,50  
Código: Fábrica: Unidade:  
**26734** CJL UN/1  
F4

UN: R\$ 12,84 AV: R\$ 12,84 15: R\$ 13,11  
30: R\$ 13,37 45: R\$ 13,64 60: R\$ 13,91



OCULOS GRAU 0,75  
Código: Fábrica: Unidade:  
**26192** CJL UN/1  
F4

UN: R\$ 12,84 AV: R\$ 12,84 15: R\$ 13,11  
30: R\$ 13,37 45: R\$ 13,64 60: R\$ 13,91



OCULOS GRAU 1,00

Código: Fábrika: Unidade:  
**25528** CJL UN/1  
F4

UN: R\$ 12,84 AV: R\$ 12,84 15: R\$ 13,11  
30: R\$ 13,37 45: R\$ 13,64 60: R\$ 13,91



OCULOS GRAU 1,25

Código: Fábrika: Unidade:  
**26003** CJL UN/1  
F4

UN: R\$ 12,84 AV: R\$ 12,84 15: R\$ 13,11  
30: R\$ 13,37 45: R\$ 13,64 60: R\$ 13,91



OCULOS GRAU 1,50

Código: Fábrika: Unidade:  
**25995** CJL UN/1  
F4

UN: R\$ 12,84 AV: R\$ 12,84 15: R\$ 13,11  
30: R\$ 13,37 45: R\$ 13,64 60: R\$ 13,91



OCULOS GRAU 1,75

Código: Fábrika: Unidade:  
**26004** CJL UN/1  
F4

UN: R\$ 12,84 AV: R\$ 12,84 15: R\$ 13,11  
30: R\$ 13,37 45: R\$ 13,64 60: R\$ 13,91



OCULOS GRAU 2,00

Código: Fábrika: Unidade:  
**25996** CJL UN/1  
F4

UN: R\$ 12,84 AV: R\$ 12,84 15: R\$ 13,11  
30: R\$ 13,37 45: R\$ 13,64 60: R\$ 13,91



OCULOS GRAU 2,25

Código: Fábrika: Unidade:  
**25997** CJL UN/1  
F4

UN: R\$ 12,84 AV: R\$ 12,84 15: R\$ 13,11  
30: R\$ 13,37 45: R\$ 13,64 60: R\$ 13,91



OCULOS GRAU 2,50

Código: Fábrika: Unidade:  
**25998** CJL UN/1  
F4

UN: R\$ 12,84 AV: R\$ 12,84 15: R\$ 13,11  
30: R\$ 13,37 45: R\$ 13,64 60: R\$ 13,91



OCULOS GRAU 2,75

Código: Fábrika: Unidade:  
**25999** CJL UN/1  
F4

UN: R\$ 12,84 AV: R\$ 12,84 15: R\$ 13,11  
30: R\$ 13,37 45: R\$ 13,64 60: R\$ 13,91



OCULOS GRAU 3,00

Código: Fábrika: Unidade:  
**26000** CJL UN/1  
F4

UN: R\$ 12,84 AV: R\$ 12,84 15: R\$ 13,11  
30: R\$ 13,37 45: R\$ 13,64 60: R\$ 13,91



OCULOS GRAU 3,25

Código: Fábrika: Unidade:  
**29659** CJL UN/1  
F4

UN: R\$ 12,84 AV: R\$ 12,84 15: R\$ 13,11  
30: R\$ 13,37 45: R\$ 13,64 60: R\$ 13,91



OCULOS GRAU 3,50

Código: Fábrika: Unidade:  
**26392** CJL UN/1  
F4

UN: R\$ 12,84 AV: R\$ 12,84 15: R\$ 13,11  
30: R\$ 13,37 45: R\$ 13,64 60: R\$ 13,91



OCULOS GRAU 3,75

Código: Fábrika: Unidade:  
**29646** CJL UN/1  
F4

UN: R\$ 12,84 AV: R\$ 12,84 15: R\$ 13,11  
30: R\$ 13,37 45: R\$ 13,64 60: R\$ 13,91



OCULOS GRAU 4,00

Código: Fábrika: Unidade:  
**26393** CJL UN/1  
F4

UN: R\$ 12,84 AV: R\$ 12,84 15: R\$ 13,11  
30: R\$ 13,37 45: R\$ 13,64 60: R\$ 13,91



OCULOS GRAU 4,50

Código: Fábrika: Unidade:  
**50884** CJL UN/1  
F4

UN: R\$ 12,84 AV: R\$ 12,84 15: R\$ 13,11  
30: R\$ 13,37 45: R\$ 13,64 60: R\$ 13,91



OCULOS GRAU 5,00

Código: Fábrika: Unidade:  
**50885** CJL UN/1  
F4

UN: R\$ 16,42 AV: R\$ 16,42 15: R\$ 16,77  
30: R\$ 17,10 45: R\$ 17,44 60: R\$ 17,79



OCULOS INF P/MERGULHO C/ACESSORIOS 3665

Código: Fábrika: Unidade:  
**42876** FIRST UN/1  
F1 F4

UN: R\$ 7,18 AV: R\$ 7,18 15: R\$ 7,33  
30: R\$ 7,48 45: R\$ 7,63 60: R\$ 7,78



OCULOS INFANTIL P/ NATACAO 16X5,2CM 0679

Código: Fábrica: Unidade:  
**10024** SUPER99 UN/1  
F1 F4

UN: R\$ 12,33 AV: R\$ 12,33 15: R\$ 12,58  
30: R\$ 12,83 45: R\$ 13,09 60: R\$ 13,35



OCULOS OAKL

Código: Fábrica: Unidade:  
**28018** CJL UN/1  
F1 F4

UN: R\$ 8,21 AV: R\$ 8,21 15: R\$ 8,38  
30: R\$ 8,55 45: R\$ 8,72 60: R\$ 8,89



OCULOS SOL AD PURPLE DEGRADE FUME 8218

Código: Fábrica: Unidade:  
**41507** SPECTRE UN/1  
F1 F4

UN: R\$ 8,21 AV: R\$ 8,21 15: R\$ 8,38  
30: R\$ 8,55 45: R\$ 8,72 60: R\$ 8,89



OCULOS SOL INF LILAS BCO ROSA MY1621

Código: Fábrica: Unidade:  
**41498** SPECTRE UN/1  
F1 F4

UN: R\$ 8,21 AV: R\$ 8,21 15: R\$ 8,38  
30: R\$ 8,55 45: R\$ 8,72 60: R\$ 8,89



OCULOS SOL INF PTO VERMELHO MY1611

Código: Fábrica: Unidade:  
**41499** SPECTRE UN/1  
F1 F4

UN: R\$ 8,21 AV: R\$ 8,21 15: R\$ 8,38  
30: R\$ 8,55 45: R\$ 8,72 60: R\$ 8,89



OCULOS SOL INF ROSA FUME MSL108

Código: Fábrica: Unidade:  
**41497** SPECTRE UN/1  
F1 F4

UN: R\$ 8,21 AV: R\$ 8,21 15: R\$ 8,38  
30: R\$ 8,55 45: R\$ 8,72 60: R\$ 8,89



OCULOS SOL INF ROSA FUME SRK039

Código: Fábrica: Unidade:  
**41496** SPECTRE UN/1  
F1 F4

UN: R\$ 12,33 AV: R\$ 12,33 15: R\$ 12,58  
30: R\$ 12,83 45: R\$ 13,09 60: R\$ 13,35



OCULOS TIPO DIOR 02

Código: Fábrica: Unidade:  
**33142** CRUZESOUZA UN/1  
F4

UN: R\$ 12,33 AV: R\$ 12,33 15: R\$ 12,58  
30: R\$ 12,83 45: R\$ 13,09 60: R\$ 13,35



OCULOS TIPO RAY BAN

Código: Fábrica: Unidade:  
**32371** CRUZESOUZA UN/1  
F4

UN: R\$ 12,33 AV: R\$ 12,33 15: R\$ 12,58  
30: R\$ 12,83 45: R\$ 13,09 60: R\$ 13,35



OCULOS TIPO RAY BAN AVIADOR COLOR 19

Código: Fábrica: Unidade:  
**33140** CRUZESOUZA UN/1  
F4

UN: R\$ 12,33 AV: R\$ 12,33 15: R\$ 12,58  
30: R\$ 12,83 45: R\$ 13,09 60: R\$ 13,35



OCULOS TIPO RAY BAN AVIADOR PEQ

Código: Fábrica: Unidade:  
**32502** CRUZESOUZA UN/1  
F1 F4

UN: R\$ 12,33 AV: R\$ 12,33 15: R\$ 12,58  
30: R\$ 12,83 45: R\$ 13,09 60: R\$ 13,35



OCULOS TIPO RAY BAN ESPELHADO

Código: Fábrica: Unidade:  
**32366** CRUZESOUZA UN/1  
F4

UN: R\$ 12,33 AV: R\$ 12,33 15: R\$ 12,58  
30: R\$ 12,83 45: R\$ 13,09 60: R\$ 13,35



OCULOS TIPO RAY BAN ESPELHADO PRATA CAMU

Código: Fábrica: Unidade:  
**32522** CRUZESOUZA UN/1  
F4

UN: R\$ 4,55 AV: R\$ 4,55 15: R\$ 4,65  
30: R\$ 4,74 45: R\$ 4,83 60: R\$ 4,93



OLEO DE MAQUINA MULTI USO 90 ML

Código: Fábrica: Unidade:  
**19551** NOVOIL UN/1  
F1 F4

UN: R\$ 0,04 AV: R\$ 3,58 15: R\$ 3,66  
30: R\$ 3,73 45: R\$ 3,81 60: R\$ 3,88

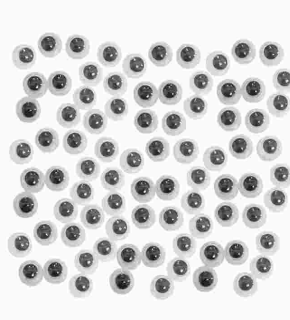

OLHINHOS C/PUPILA MOVEIS 03MM 100X1

Código: Fábrica: Unidade:  
**47631** ABE PT/100  
F1 F4

UN: R\$ 0,04 AV: R\$ 4,10 15: R\$ 4,18  
30: R\$ 4,27 45: R\$ 4,35 60: R\$ 4,44

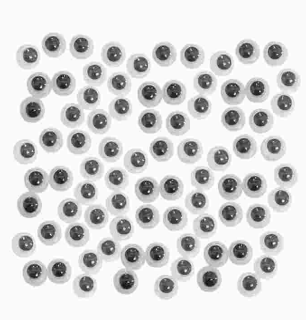

OLHINHOS C/PUPILA MOVEIS 04MM 100X1

Código: Fábrica: Unidade:  
**50053** NYBC PT/100  
F1 F4

UN: R\$ 0,05 AV: R\$ 5,06 15: R\$ 5,17  
30: R\$ 5,27 45: R\$ 5,38 60: R\$ 5,49



OLHINHOS C/PUPILA MOVEIS 05MM 100X1  
Código: 42879 Fábrica: ABE Unidade: PT/100 F1 F4

UN: R\$ 0,05 AV: R\$ 5,13 15: R\$ 5,23  
30: R\$ 5,34 45: R\$ 5,44 60: R\$ 5,55

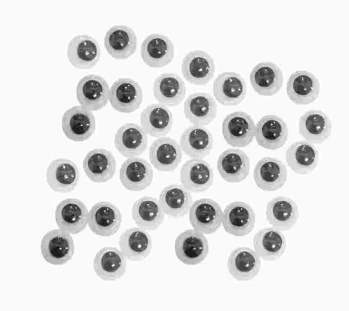

OLHINHOS C/PUPILA MOVEIS 06MM 100X1  
Código: 45134 Fábrica: NYBC Unidade: PT/100 F1 F4

UN: R\$ 0,06 AV: R\$ 5,64 15: R\$ 5,76  
30: R\$ 5,87 45: R\$ 5,99 60: R\$ 6,11



OLHINHOS C/PUPILA MOVEIS 07MM 100X1  
Código: 45135 Fábrica: ABE Unidade: PT/100 F1 F4

UN: R\$ 0,07 AV: R\$ 6,67 15: R\$ 6,81  
30: R\$ 6,94 45: R\$ 7,08 60: R\$ 7,22



OLHINHOS C/PUPILA MOVEIS 08MM 100X1  
Código: 46792 Fábrica: NYBC Unidade: PT/100 F1 F4

UN: R\$ 0,09 AV: R\$ 9,23 15: R\$ 9,43  
30: R\$ 9,62 45: R\$ 9,81 60: R\$ 10,00



OLHINHOS C/PUPILA MOVEIS 10MM 100X1  
Código: 45136 Fábrica: ABE Unidade: PT/100 F1 F4

UN: R\$ 0,13 AV: R\$ 12,62 15: R\$ 12,89  
30: R\$ 13,15 45: R\$ 13,41 60: R\$ 13,68



OLHINHOS C/PUPILA MOVEIS 12MM 100X1  
Código: 45137 Fábrica: ABE Unidade: PT/100 F1 F4

UN: R\$ 0,22 AV: R\$ 22,50 15: R\$ 22,96  
30: R\$ 23,42 45: R\$ 23,89 60: R\$ 24,37

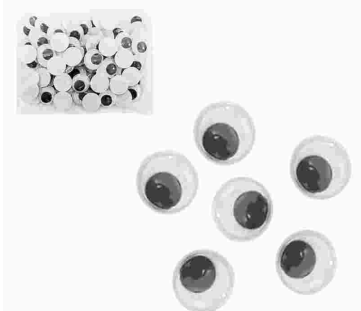

OLHINHOS C/PUPILA MOVEIS 20MM 100X1  
Código: 50386 Fábrica: ABE Unidade: PT/100 F1 F4

UN: R\$ 5,13 AV: R\$ 5,13 15: R\$ 5,23  
30: R\$ 5,34 45: R\$ 5,44 60: R\$ 5,55



ORATORIO MDF 8X18CM 469  
Código: 45984 Fábrica: R A ARTESANA Unidade: UN/1 F1 F4

UN: R\$ 49,31 AV: R\$ 49,31 15: R\$ 50,33  
30: R\$ 51,34 45: R\$ 52,37 60: R\$ 53,41

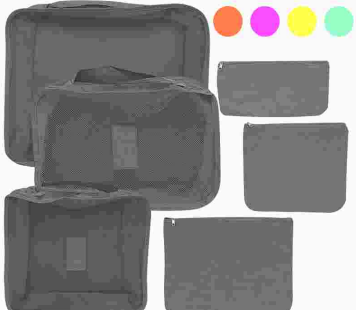

ORGANIZADOR DE MALA KIT 6 PCS 74002  
Código: 37085 Fábrica: ROCIE Unidade: KT/1 F1 F4

UN: R\$ 10,01 AV: R\$ 10,01 15: R\$ 10,22  
30: R\$ 10,43 45: R\$ 10,64 60: R\$ 10,85



ORGANIZADOR PLAST (PORTA CONTROLE) 389  
Código: 36335 Fábrica: FUTURO Unidade: UN/1 F1 F4

UN: R\$ 1,71 AV: R\$ 20,53 15: R\$ 20,96  
30: R\$ 21,38 45: R\$ 21,81 60: R\$ 22,24



PALHETA COLOR P-96 12X1  
Código: 37355 Fábrica: ROUXINOL Unidade: PT/12 F1 F4

UN: R\$ 256,79 AV: R\$ 256,79 15: R\$ 262,14  
30: R\$ 267,38 45: R\$ 272,73 60: R\$ 278,18



PARAFUSADEIRA ARTICULADA 4V EMB ACRILIC  
Código: 42479 Fábrica: MICHELIN Unidade: UN/1 F1 F4

UN: R\$ 297,88 AV: R\$ 297,88 15: R\$ 304,08  
30: R\$ 310,17 45: R\$ 316,37 60: R\$ 322,70



PARAFUSADEIRA IMPAC 12V LITI 2VEL MALETA  
Código: 42478 Fábrica: MULTILASER Unidade: UN/1 F1 F4

UN: R\$ 4,10 AV: R\$ 4,10 15: R\$ 4,18  
30: R\$ 4,27 45: R\$ 4,35 60: R\$ 4,44



PEDRA DECORATIVA VERDE CLARO 750 GRS  
Código: 34745 Fábrica: NOVATROPICAL Unidade: PT/1 F1 F4

UN: R\$ 3,39 AV: R\$ 3,39 15: R\$ 3,46  
30: R\$ 3,53 45: R\$ 3,60 60: R\$ 3,67



PEDRA SEIXO BRANCO 4 APROX 1 KG  
Código: 34749 Fábrica: ANGEL PEDRAS Unidade: PT/1 F1 F4

UN: R\$ 12,32 AV: R\$ 24,64 15: R\$ 25,16  
30: R\$ 25,66 45: R\$ 26,17 60: R\$ 26,70



PILHA ALCALINA GDE D BLISTER LR202B 2X1  
Código: 47475 Fábrica: ALFACELL Unidade: CR/2 F1 F4

UN: R\$ 10,27 AV: R\$ 10,27 15: R\$ 10,49  
30: R\$ 10,70 45: R\$ 10,91 60: R\$ 11,13



PILHA ALCALINA GDE D UN

Código: Fábrika: Unidade:  
**28693** ALFACELL U/1  
F1 F4

UN: R\$ 9,60 AV: R\$ 19,21 15: R\$ 19,61  
30: R\$ 20,00 45: R\$ 20,40 60: R\$ 20,81



PILHA ALCALINA MED TPO C BLISTE LR14 2X1

Código: Fábrika: Unidade:  
**28692** ALFACELL CR/2  
F1 F4

UN: R\$ 0,13 AV: R\$ 0,13 15: R\$ 0,13  
30: R\$ 0,14 45: R\$ 0,14 60: R\$ 0,15



PILHA ALCALINA PALITO AAA UN

Código: Fábrika: Unidade:  
**19019** ALFACELL UN/1  
F1 F4

UN: R\$ 2,82 AV: R\$ 5,64 15: R\$ 5,76  
30: R\$ 5,87 45: R\$ 5,99 60: R\$ 6,11



PILHA ALCALINA PALITO BLISTE AAA 1.5V 2X1

Código: Fábrika: Unidade:  
**21666** ALFACELL/ELG CR/2  
F1 F4

UN: R\$ 2,57 AV: R\$ 77,03 15: R\$ 78,63  
30: R\$ 80,21 45: R\$ 81,81 60: R\$ 83,45



PILHA ALCALINA PALITO 1.5V AAA LR03 15X2

Código: Fábrika: Unidade:  
**46651** ALFACELL CX/30  
F1 F4

UN: R\$ 2,82 AV: R\$ 11,29 15: R\$ 11,52  
30: R\$ 11,75 45: R\$ 11,99 60: R\$ 12,23



PILHA ALCALINA PEQ AA 1.5V LR6/4 CTL 4X1

Código: Fábrika: Unidade:  
**19645** ALFACELL CR/4  
F1 F4

UN: R\$ 5,82 AV: R\$ 87,30 15: R\$ 89,12  
30: R\$ 90,90 45: R\$ 92,72 60: R\$ 94,58



PILHA ALCALINA PEQ 1.5V AA LR6 15X2

Código: Fábrika: Unidade:  
**47295** ALFACELL CX/15  
F1 F4

UN: R\$ 4,10 AV: R\$ 4,10 15: R\$ 4,18  
30: R\$ 4,27 45: R\$ 4,35 60: R\$ 4,44



PILHA ALCALINA 23AC (BATERIA 12 V) CTL

Código: Fábrika: Unidade:  
**47766** ALFACELL UN/1  
F1 F4

UN: R\$ 5,64 AV: R\$ 11,29 15: R\$ 11,52  
30: R\$ 11,75 45: R\$ 11,99 60: R\$ 12,23



PILHA COMUM GDE D 1.V R20P/2SC 2X1

Código: Fábrika: Unidade:  
**50675** ALFACELL PT/2  
F1 F4

UN: R\$ 3,59 AV: R\$ 7,18 15: R\$ 7,33  
30: R\$ 7,48 45: R\$ 7,63 60: R\$ 7,78



PILHA COMUM MED C 1.5 R14P/2SC 2X1

Código: Fábrika: Unidade:  
**50676** ALFACELL PT/2  
F1 F4

UN: R\$ 0,56 AV: R\$ 33,89 15: R\$ 34,59  
30: R\$ 35,29 45: R\$ 35,99 60: R\$ 36,71



PILHA LONGA DUR PALITO 1.5V AAA RX4 15X4

Código: Fábrika: Unidade:  
**28654** RELINX CX/60  
F1 F4

UN: R\$ 0,68 AV: R\$ 41,08 15: R\$ 41,93  
30: R\$ 42,77 45: R\$ 43,63 60: R\$ 44,50



PILHA LONGA DUR PEQ 1.5V AA RX-3 15X4

Código: Fábrika: Unidade:  
**31768** RELINX CX/60  
F1 F4

UN: R\$ 6,15 AV: R\$ 6,15 15: R\$ 6,28  
30: R\$ 6,41 45: R\$ 6,53 60: R\$ 6,67



PILHA MED C UN

Código: Fábrika: Unidade:  
**42932** ALFACELL CR/1  
F1 F4

UN: R\$ 8,47 AV: R\$ 33,89 15: R\$ 34,59  
30: R\$ 35,29 45: R\$ 35,99 60: R\$ 36,71



PILHA PALITO AAA RECARREGAVEL 4X1

Código: Fábrika: Unidade:  
**19648** KNUP CR/4  
F1 F4

UN: R\$ 8,73 AV: R\$ 17,45 15: R\$ 17,82  
30: R\$ 18,17 45: R\$ 18,54 60: R\$ 19,91



PILHA PALITO AAA 1200MAH RECARR CTL 2X1

Código: Fábrika: Unidade:  
**21669** ALFACELL CR/2  
F1 F4

UN: R\$ 2,44 AV: R\$ 9,76 15: R\$ 9,96  
30: R\$ 10,16 45: R\$ 10,36 60: R\$ 10,57



PILHA PALITO ALCALINA AAA 1.5V LR03 4X1

Código: Fábrika: Unidade:  
**21797** ALFACELL CR/4  
F1 F4

UN: R\$ 1,18 AV: R\$ 4,73 15: R\$ 4,82  
30: R\$ 4,92 45: R\$ 5,02 60: R\$ 5,12



PILHA PALITO COMUM AAA 1.5V R03P/4B 4X1  
Código: Fábriça: Unidade:  
**50673** ALFACELL CR/4  
F1 F4

UN: R\$ 0,58 AV: R\$ 34,91 15: R\$ 35,64  
30: R\$ 36,35 45: R\$ 37,08 60: R\$ 37,82



PILHA PALITO 1.5V AAA R03 15X4  
Código: Fábriça: Unidade:  
**29374** FUTURO CX/60  
F1 F4

UN: R\$ 2,00 AV: R\$ 30,05 15: R\$ 30,67  
30: R\$ 31,29 45: R\$ 31,91 60: R\$ 32,55



PILHA PALITO 1.5V AAA R03P/2SG 15X2  
Código: Fábriça: Unidade:  
**50964** ALFACELL CX/15  
F1 F4

UN: R\$ 0,95 AV: R\$ 38,15 15: R\$ 38,95  
30: R\$ 39,72 45: R\$ 40,52 60: R\$ 41,33



PILHA PALITO 1.5V AAA R03P/4SGT 10X4  
Código: Fábriça: Unidade:  
**46606** ALFACELL CX/40  
F1 F4

UN: R\$ 10,27 AV: R\$ 20,53 15: R\$ 20,96  
30: R\$ 21,38 45: R\$ 21,81 60: R\$ 22,24



PILHA PEQ AA 1800MAH RECAR 2007 CTL 2X1  
Código: Fábriça: Unidade:  
**46241** ALFACELL CR/2  
F1 F4

UN: R\$ 10,89 AV: R\$ 21,78 15: R\$ 22,23  
30: R\$ 22,67 45: R\$ 23,13 60: R\$ 23,59



PILHA PEQ AA 2300MAH RECAR 2013 CTL 2X1  
Código: Fábriça: Unidade:  
**47293** ALFACELL CR/2  
F1 F4

UN: R\$ 1,34 AV: R\$ 5,34 15: R\$ 5,45  
30: R\$ 5,56 45: R\$ 5,67 60: R\$ 5,79



PILHA PEQ COMUM AA 1.5V R6P/4B 4X1  
Código: Fábriça: Unidade:  
**50674** ALFACELL CR/4  
F1 F4

UN: R\$ 4,83 AV: R\$ 48,28 15: R\$ 49,28  
30: R\$ 50,27 45: R\$ 51,28 60: R\$ 52,30



PILHA PEQ 1.5V AA R6P/4SGT 10X4  
Código: Fábriça: Unidade:  
**49922** ALFACELL CX/10  
F1 F4

UN: R\$ 4,11 AV: R\$ 41,08 15: R\$ 41,93  
30: R\$ 42,77 45: R\$ 43,63 60: R\$ 44,50



PINO PORTA LAMPADA BRANCO EF06 10X1  
Código: Fábriça: Unidade:  
**49220** GIROFLASH PT/10  
F1 F4

UN: R\$ 0,22 AV: R\$ 21,83 15: R\$ 22,28  
30: R\$ 22,73 45: R\$ 23,18 60: R\$ 23,65



PINO P/RELOGIO PULSO ACQUA 100X1  
Código: Fábriça: Unidade:  
**19989** RDE CE/100  
F1 F4

UN: R\$ 277,33 AV: R\$ 277,33 15: R\$ 283,11  
30: R\$ 288,77 45: R\$ 294,55 60: R\$ 300,44



PISTOLA LAVADORA DE ALTA PRESSAO  
Código: Fábriça: Unidade:  
**39172** HAI BRASIL UN/1  
F1 F4

UN: R\$ 9,04 AV: R\$ 45,19 15: R\$ 46,13  
30: R\$ 47,05 45: R\$ 47,99 60: R\$ 48,95

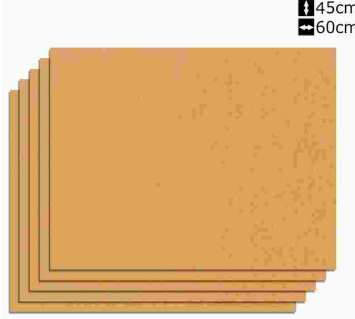

PLACA CORTICA 45X60X1MM 606 5X1  
Código: Fábriça: Unidade:  
**45600** CORTIARTE PT/5  
F1 F4

UN: R\$ 9,76 AV: R\$ 9,76 15: R\$ 9,96  
30: R\$ 10,16 45: R\$ 10,36 60: R\$ 10,57



PLACA DEC 3MM 20X30CM MDF BAR B1  
Código: Fábriça: Unidade:  
**36396** P A SOUZA UN/1  
F1 F4

UN: R\$ 10,26 AV: R\$ 10,26 15: R\$ 10,48  
30: R\$ 10,69 45: R\$ 10,90 60: R\$ 11,12



PLACA DEC 3MM 20X30CM MDF FRASES F1  
Código: Fábriça: Unidade:  
**36393** P A SOUZA UN/1  
F1 F4

UN: R\$ 9,76 AV: R\$ 9,76 15: R\$ 9,96  
30: R\$ 10,16 45: R\$ 10,36 60: R\$ 10,57

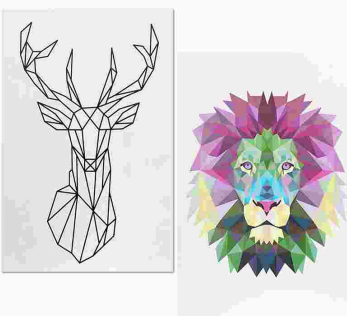

PLACA DEC 3MM 20X30CM MDF GEOMETRICO G1  
Código: Fábriça: Unidade:  
**36395** P A SOUZA UN/1  
F1 F4

UN: R\$ 9,76 AV: R\$ 9,76 15: R\$ 9,96  
30: R\$ 10,16 45: R\$ 10,36 60: R\$ 10,57



PLACA DEC 3MM 20X30CM MDF INFANTIL I1  
Código: Fábriça: Unidade:  
**36397** P A SOUZA UN/1  
F1 F4

UN: R\$ 9,76 AV: R\$ 9,76 15: R\$ 9,96  
30: R\$ 10,16 45: R\$ 10,36 60: R\$ 10,57

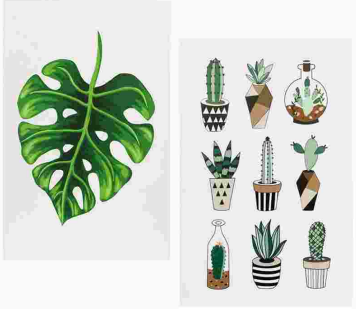

PLACA DEC 3MM 20X30CM MDF TROPICAL T1  
Código: Fábrika: Unidade:  
**36394** P A SOUZA UN/1  
F1 F4

UN: R\$ 17,15 AV: R\$ 17,15 15: R\$ 17,51  
30: R\$ 17,86 45: R\$ 18,22 60: R\$ 18,58



PLACA DEC 3MM 20X30CM MOLD BAR B3  
Código: Fábrika: Unidade:  
**45648** P A SOUZA UN/1  
F1 F4

UN: R\$ 17,15 AV: R\$ 17,15 15: R\$ 17,51  
30: R\$ 17,86 45: R\$ 18,22 60: R\$ 18,58



PLACA DEC 3MM 20X30CM MOLD FRASES F3  
Código: Fábrika: Unidade:  
**45650** P A SOUZA UN/1  
F1 F4

UN: R\$ 17,15 AV: R\$ 17,15 15: R\$ 17,51  
30: R\$ 17,86 45: R\$ 18,22 60: R\$ 18,58

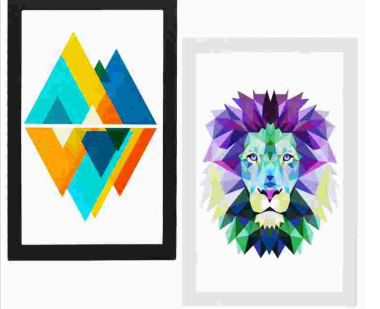

PLACA DEC 3MM 20X30CM MOLD GEOMETRICO G3  
Código: Fábrika: Unidade:  
**45654** P A SOUZA UN/1  
F1 F4

UN: R\$ 17,15 AV: R\$ 17,15 15: R\$ 17,51  
30: R\$ 17,86 45: R\$ 18,22 60: R\$ 18,58



PLACA DEC 3MM 20X30CM MOLD INFANTIL I3  
Código: Fábrika: Unidade:  
**45652** P A SOUZA UN/1  
F1 F4

UN: R\$ 17,15 AV: R\$ 17,15 15: R\$ 17,51  
30: R\$ 17,86 45: R\$ 18,22 60: R\$ 18,58



PLACA DEC 3MM 20X30CM MOLD TROPICAL T3  
Código: Fábrika: Unidade:  
**45656** P A SOUZA UN/1  
F1 F4

UN: R\$ 24,96 AV: R\$ 24,96 15: R\$ 25,48  
30: R\$ 25,99 45: R\$ 26,51 60: R\$ 27,04



PLACA DEC 3MM 20X30CM MOLD/VID BAR B5  
Código: Fábrika: Unidade:  
**45649** P A SOUZA UN/1  
F1 F4

UN: R\$ 24,96 AV: R\$ 24,96 15: R\$ 25,48  
30: R\$ 25,99 45: R\$ 26,51 60: R\$ 27,04



PLACA DEC 3MM 20X30CM MOLD/VID FRASES F5  
Código: Fábrika: Unidade:  
**45651** P A SOUZA UN/1  
F1 F4

UN: R\$ 24,96 AV: R\$ 24,96 15: R\$ 25,48  
30: R\$ 25,99 45: R\$ 26,51 60: R\$ 27,04

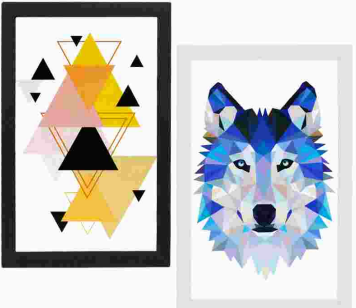

PLACA DEC 3MM 20X30CM MOLD/VID GEOMET G5  
Código: Fábrika: Unidade:  
**45655** P A SOUZA UN/1  
F1 F4

UN: R\$ 24,96 AV: R\$ 24,96 15: R\$ 25,48  
30: R\$ 25,99 45: R\$ 26,51 60: R\$ 27,04



PLACA DEC 3MM 20X30CM MOLD/VID INFANT I5  
Código: Fábrika: Unidade:  
**45653** P A SOUZA UN/1  
F1 F4

UN: R\$ 24,96 AV: R\$ 24,96 15: R\$ 25,48  
30: R\$ 25,99 45: R\$ 26,51 60: R\$ 27,04



PLACA DEC 3MM 20X30CM MOLD/VID TROPIC T5  
Código: Fábrika: Unidade:  
**45657** P A SOUZA UN/1  
F1 F4

UN: R\$ 15,40 AV: R\$ 15,40 15: R\$ 15,72  
30: R\$ 16,03 45: R\$ 16,35 60: R\$ 16,68



PLACA DECORATIVA JACK DANIELS 29X19CM  
Código: Fábrika: Unidade:  
**41745** DEBIASI UN/1  
F1 F4

UN: R\$ 12,33 AV: R\$ 12,33 15: R\$ 12,58  
30: R\$ 12,83 45: R\$ 13,09 60: R\$ 13,35



POCHETE COURINO AMASSA 2 DIV PRETA 13036  
Código: Fábrika: Unidade:  
**40503** GLX UN/1  
F1 F4

UN: R\$ 18,48 AV: R\$ 18,48 15: R\$ 18,86  
30: R\$ 19,24 45: R\$ 19,63 60: R\$ 20,02



POCHETE LONA 3 DIVISOES  
Código: Fábrika: Unidade:  
**11926** CJL UN/1  
F1 F4

UN: R\$ 12,33 AV: R\$ 12,33 15: R\$ 12,58  
30: R\$ 12,83 45: R\$ 13,09 60: R\$ 13,35

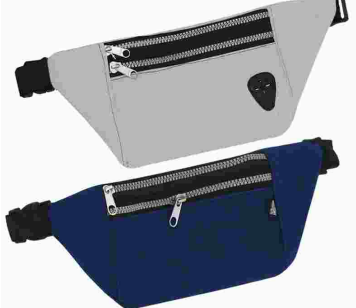

POCHETE SUEDE COLOR 2 DIVISOES 13018  
Código: Fábrika: Unidade:  
**40492** GLX UN/1  
F1 F4

UN: R\$ 3,07 AV: R\$ 3,07 15: R\$ 3,14  
30: R\$ 3,20 45: R\$ 3,26 60: R\$ 3,33



POMPOM BOLA 20MM AMARELO 10X1  
Código: Fábrika: Unidade:  
**50197** BB PT/1  
F1 F4

UN: R\$ 3,07 AV: R\$ 3,07 15: R\$ 3,14  
30: R\$ 3,20 45: R\$ 3,26 60: R\$ 3,33



POMPOM BOLA 20MM BRANCO 10X1

Código: Fábrica: Unidade:  
**45226** BB PT/1  
F1 F4

UN: R\$ 3,07 AV: R\$ 3,07 15: R\$ 3,14  
30: R\$ 3,20 45: R\$ 3,26 60: R\$ 3,33



POMPOM BOLA 20MM LILAS 10X1

Código: Fábrica: Unidade:  
**50201** BB PT/1  
F1 F4

UN: R\$ 3,07 AV: R\$ 3,07 15: R\$ 3,14  
30: R\$ 3,20 45: R\$ 3,26 60: R\$ 3,33



POMPOM BOLA 20MM PRETO 10X1

Código: Fábrica: Unidade:  
**50198** BB PT/1  
F1 F4

UN: R\$ 3,07 AV: R\$ 3,07 15: R\$ 3,14  
30: R\$ 3,20 45: R\$ 3,26 60: R\$ 3,33



POMPOM BOLA 20MM VERDE 10X1

Código: Fábrica: Unidade:  
**50199** BB PT/1  
F1 F4

UN: R\$ 3,07 AV: R\$ 3,07 15: R\$ 3,14  
30: R\$ 3,20 45: R\$ 3,26 60: R\$ 3,33



POMPOM BOLA 20MM VERMELHO 10X1

Código: Fábrica: Unidade:  
**50200** BB PT/1  
F1 F4

UN: R\$ 0,31 AV: R\$ 30,82 15: R\$ 31,46  
30: R\$ 32,09 45: R\$ 32,73 60: R\$ 33,38



PONTA P/TACO DE BILHAR 10MM CX 100X1

Código: Fábrica: Unidade:  
**36492** BLESSED CX/100  
F1 F4

UN: R\$ 0,73 AV: R\$ 8,71 15: R\$ 8,89  
30: R\$ 9,07 45: R\$ 9,25 60: R\$ 9,43



PORTA CARTAO CRED PLAST RIGIDO 12X1

Código: Fábrica: Unidade:  
**21046** ITALY'S DZ/12  
F1 F4

UN: R\$ 5,77 AV: R\$ 5,77 15: R\$ 5,89  
30: R\$ 6,01 45: R\$ 6,13 60: R\$ 6,25



PORTA ESCOVA PLAST C/ SABONETEIRA 0339

Código: Fábrica: Unidade:  
**41030** MARILU UN/1  
F1 F4

UN: R\$ 8,21 AV: R\$ 8,21 15: R\$ 8,38  
30: R\$ 8,55 45: R\$ 8,72 60: R\$ 8,89

05 cm  
15 cm  
19 cm



PORTA MOEDAS BALCAO MC035

Código: Fábrica: Unidade:  
**18517** BUDEPLAST UN/1  
F1 F4

UN: R\$ 4,11 AV: R\$ 4,11 15: R\$ 4,19  
30: R\$ 4,28 45: R\$ 4,36 60: R\$ 4,45

2,5 cm  
6,5 cm  
09 cm



PORTA MOEDAS DE BOLSO MB033

Código: Fábrica: Unidade:  
**33059** BUDEPLAST UN/1  
F1 F4

UN: R\$ 5,14 AV: R\$ 5,14 15: R\$ 5,24  
30: R\$ 5,35 45: R\$ 5,45 60: R\$ 5,56

6,5 cm  
3,5 cm  
16,5 cm



PORTA MOEDAS DE PERUEIRO MP034

Código: Fábrica: Unidade:  
**33060** BUDEPLAST UN/1  
F1 F4

UN: R\$ 58,04 AV: R\$ 58,04 15: R\$ 59,25  
30: R\$ 60,43 45: R\$ 61,64 60: R\$ 62,88



PORTA RET AGUA 10X15CM FORMATURA 2335

Código: Fábrica: Unidade:  
**39047** BRASFOOT UN/1  
F1 F4

UN: R\$ 6,97 AV: R\$ 6,97 15: R\$ 7,12  
30: R\$ 7,26 45: R\$ 7,41 60: R\$ 7,56



PORTA RET MAD 10X15CM ACET 46 MOD 115

Código: Fábrica: Unidade:  
**13849** P A SOUZA UN/1  
F1 F4

UN: R\$ 6,97 AV: R\$ 6,97 15: R\$ 7,12  
30: R\$ 7,26 45: R\$ 7,41 60: R\$ 7,56



PORTA RET MAD 10X15CM ACET 50 MOD 116

Código: Fábrica: Unidade:  
**8828** P A SOUZA UN/1  
F1 F4

UN: R\$ 6,97 AV: R\$ 6,97 15: R\$ 7,12  
30: R\$ 7,26 45: R\$ 7,41 60: R\$ 7,56



PORTA RET MAD 10X15CM ACET 65 MOD 010

Código: Fábrica: Unidade:  
**6482** P A SOUZA UN/1  
F1 F4

UN: R\$ 6,97 AV: R\$ 6,97 15: R\$ 7,12  
30: R\$ 7,26 45: R\$ 7,41 60: R\$ 7,56



PORTA RET MAD 10X15CM ACET 1015

Código: Fábrica: Unidade:  
**40979** SANTA RITA UN/1  
F1 F4

UN: R\$ 6,97 AV: R\$ 6,97 15: R\$ 7,12  
30: R\$ 7,26 45: R\$ 7,41 60: R\$ 7,56



PORTA RET MAD 10X15CM ACET 146 MOD 020  
Código: Fábrica: Unidade:  
**8822** P A SOUZA UN/1  
F1 F4

UN: R\$ 10,26 AV: R\$ 10,26 15: R\$ 10,48  
30: R\$ 10,69 45: R\$ 10,90 60: R\$ 11,12



PORTA RET MAD 10X15CM RUSTIC ACET 005  
Código: Fábrica: Unidade:  
**45763** MOLDULAC UN/1  
F1 F4

UN: R\$ 8,99 AV: R\$ 8,99 15: R\$ 8,99  
30: R\$ 8,99 45: R\$ 8,99 60: R\$ 8,99



PORTA RET MAD 10X15CM VIDRO EXTRA LUXO  
Código: Fábrica: Unidade:  
**48746** SANTA RITA UN/1  
F1 F4

UN: R\$ 9,13 AV: R\$ 9,13 15: R\$ 9,32  
30: R\$ 9,51 45: R\$ 9,70 60: R\$ 9,89



PORTA RET MAD 10X15CM VIDRO 101 MOD 010  
Código: Fábrica: Unidade:  
**22768** P A SOUZA UN/1  
F1 F4

UN: R\$ 9,13 AV: R\$ 9,13 15: R\$ 9,32  
30: R\$ 9,51 45: R\$ 9,70 60: R\$ 9,89



PORTA RET MAD 10X15CM VIDRO 106 MOD 115  
Código: Fábrica: Unidade:  
**22263** P A SOUZA UN/1  
F1 F4

UN: R\$ 9,13 AV: R\$ 9,13 15: R\$ 9,32  
30: R\$ 9,51 45: R\$ 9,70 60: R\$ 9,89



PORTA RET MAD 10X15CM VIDRO 111 MOD 116  
Código: Fábrica: Unidade:  
**15943** P A SOUZA UN/1  
F1 F4

UN: R\$ 14,79 AV: R\$ 14,79 15: R\$ 15,10  
30: R\$ 15,40 45: R\$ 15,71 60: R\$ 16,02



PORTA RET MAD 10X15CM VIDRO 126 MOD 080  
Código: Fábrica: Unidade:  
**45710** P A SOUZA UN/1  
F1 F4

UN: R\$ 9,13 AV: R\$ 9,13 15: R\$ 9,32  
30: R\$ 9,51 45: R\$ 9,70 60: R\$ 9,89



PORTA RET MAD 10X15CM VIDRO 186 MOD 020  
Código: Fábrica: Unidade:  
**15941** P A SOUZA UN/1  
F1 F4

UN: R\$ 6,93 AV: R\$ 6,93 15: R\$ 7,08  
30: R\$ 7,22 45: R\$ 7,36 60: R\$ 7,51

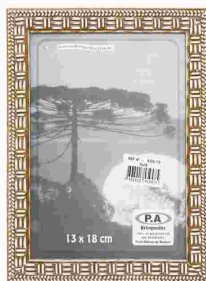

PORTA RET MAD 13X18CM ACET 47 MOD 115  
Código: Fábrica: Unidade:  
**7745** P A SOUZA UN/1  
F1 F4

UN: R\$ 6,93 AV: R\$ 6,93 15: R\$ 7,08  
30: R\$ 7,22 45: R\$ 7,36 60: R\$ 7,51



PORTA RET MAD 13X18CM ACET 51 MOD 116  
Código: Fábrica: Unidade:  
**17552** P A SOUZA UN/1  
F1 F4

UN: R\$ 6,93 AV: R\$ 6,93 15: R\$ 7,08  
30: R\$ 7,22 45: R\$ 7,36 60: R\$ 7,51



PORTA RET MAD 13X18CM ACET 147 MOD 020  
Código: Fábrica: Unidade:  
**18519** P A SOUZA UN/1  
F1 F4

UN: R\$ 14,25 AV: R\$ 14,25 15: R\$ 14,54  
30: R\$ 14,84 45: R\$ 15,13 60: R\$ 15,43



PORTA RET MAD 13X18CM ACET 152 MOD 141  
Código: Fábrica: Unidade:  
**45715** P A SOUZA UN/1  
F1 F4

UN: R\$ 10,94 AV: R\$ 10,94 15: R\$ 11,17  
30: R\$ 11,39 45: R\$ 11,62 60: R\$ 11,85



PORTA RET MAD 13X18CM ACET 157 MOD 133  
Código: Fábrica: Unidade:  
**45693** P A SOUZA UN/1  
F1 F4

UN: R\$ 14,23 AV: R\$ 14,23 15: R\$ 14,52  
30: R\$ 14,81 45: R\$ 15,11 60: R\$ 15,41



PORTA RET MAD 13X18CM ACET 162 MOD 167  
Código: Fábrica: Unidade:  
**45700** P A SOUZA UN/1  
F1 F4

UN: R\$ 13,34 AV: R\$ 13,34 15: R\$ 13,62  
30: R\$ 13,89 45: R\$ 14,17 60: R\$ 14,46



PORTA RET MAD 13X18CM VIDRO EXTRA LUXO  
Código: Fábrica: Unidade:  
**48747** SANTA RITA UN/1  
F1 F4

UN: R\$ 10,22 AV: R\$ 10,22 15: R\$ 10,43  
30: R\$ 10,64 45: R\$ 10,86 60: R\$ 11,07

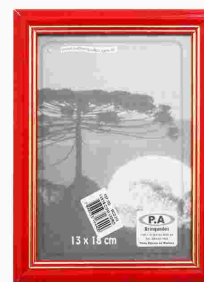

PORTA RET MAD 13X18CM VIDRO 102 MOD 010  
Código: Fábrica: Unidade:  
**35227** P A SOUZA UN/1  
F1 F4

UN: R\$ 10,22 AV: R\$ 10,22 15: R\$ 10,43  
30: R\$ 10,64 45: R\$ 10,86 60: R\$ 11,07



PORTA RET MAD 13X18CM VIDRO 107 MOD 115  
Código: Fábrica: Unidade:  
**35229** P A SOUZA UN/1  
F1 F4

UN: R\$ 10,22 AV: R\$ 10,22 15: R\$ 10,43  
30: R\$ 10,64 45: R\$ 10,86 60: R\$ 11,07



PORTA RET MAD 13X18CM VIDRO 112 MOD 116  
Código: Fábrica: Unidade:  
**35228** P A SOUZA UN/1  
F1 F4

UN: R\$ 14,37 AV: R\$ 14,37 15: R\$ 14,67  
30: R\$ 14,96 45: R\$ 15,26 60: R\$ 15,57

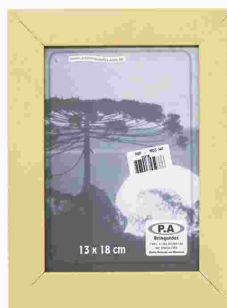

PORTA RET MAD 13X18CM VIDRO 117 MOD 040  
Código: Fábrica: Unidade:  
**45686** P A SOUZA UN/1  
F1 F4

UN: R\$ 14,37 AV: R\$ 14,37 15: R\$ 14,67  
30: R\$ 14,96 45: R\$ 15,26 60: R\$ 15,57

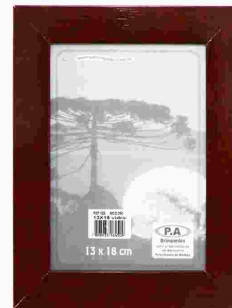

PORTA RET MAD 13X18CM VIDRO 122 MOD 050  
Código: Fábrica: Unidade:  
**45691** P A SOUZA UN/1  
F1 F4

UN: R\$ 17,33 AV: R\$ 17,33 15: R\$ 17,69  
30: R\$ 18,04 45: R\$ 18,40 60: R\$ 18,77



PORTA RET MAD 13X18CM VIDRO 127 MOD 080  
Código: Fábrica: Unidade:  
**45711** P A SOUZA UN/1  
F1 F4

UN: R\$ 14,37 AV: R\$ 14,37 15: R\$ 14,67  
30: R\$ 14,96 45: R\$ 15,26 60: R\$ 15,57



PORTA RET MAD 13X18CM VIDRO 177 MOD 133  
Código: Fábrica: Unidade:  
**45696** P A SOUZA UN/1  
F1 F4

UN: R\$ 17,33 AV: R\$ 17,33 15: R\$ 17,69  
30: R\$ 18,04 45: R\$ 18,40 60: R\$ 18,77



PORTA RET MAD 13X18CM VIDRO 182 MOD 167  
Código: Fábrica: Unidade:  
**45703** P A SOUZA UN/1  
F1 F4

UN: R\$ 10,22 AV: R\$ 10,22 15: R\$ 10,43  
30: R\$ 10,64 45: R\$ 10,86 60: R\$ 11,07



PORTA RET MAD 13X18CM VIDRO 187 MOD 020  
Código: Fábrica: Unidade:  
**16456** P A SOUZA UN/1  
F1 F4

UN: R\$ 17,33 AV: R\$ 17,33 15: R\$ 17,69  
30: R\$ 18,04 45: R\$ 18,40 60: R\$ 18,77



PORTA RET MAD 13X18CM VIDRO 192 MOD 141  
Código: Fábrica: Unidade:  
**45683** P A SOUZA UN/1  
F1 F4

UN: R\$ 16,41 AV: R\$ 16,41 15: R\$ 16,76  
30: R\$ 17,09 45: R\$ 17,43 60: R\$ 17,78



PORTA RET MAD 15X21CM RUSTIC ACET 005  
Código: Fábrica: Unidade:  
**45764** MOLDULAC UN/1  
F1 F4

UN: R\$ 15,40 AV: R\$ 15,40 15: R\$ 15,72  
30: R\$ 16,03 45: R\$ 16,35 60: R\$ 16,68



PORTA RET MAD 15X21CM VIDRO EXTRA LUXO  
Código: Fábrica: Unidade:  
**48748** SANTA RITA UN/1  
F1 F4

UN: R\$ 12,32 AV: R\$ 12,32 15: R\$ 12,57  
30: R\$ 12,82 45: R\$ 13,08 60: R\$ 13,34



PORTA RET MAD 20X25CM ACET  
Código: Fábrica: Unidade:  
**48749** SANTA RITA UN/1  
F1 F4

UN: R\$ 17,82 AV: R\$ 17,82 15: R\$ 18,19  
30: R\$ 18,56 45: R\$ 18,93 60: R\$ 19,31



PORTA RET MAD 20X25CM ACET 44 MOD 050  
Código: Fábrica: Unidade:  
**45664** P A SOUZA UN/1  
F1 F4

UN: R\$ 10,73 AV: R\$ 10,73 15: R\$ 10,96  
30: R\$ 11,18 45: R\$ 11,40 60: R\$ 11,63

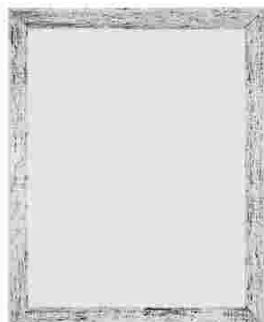

PORTA RET MAD 20X25CM ACET 49 MOD 115  
Código: Fábrica: Unidade:  
**8824** P A SOUZA UN/1  
F1 F4

UN: R\$ 20,53 AV: R\$ 20,53 15: R\$ 20,96  
30: R\$ 21,38 45: R\$ 21,81 60: R\$ 22,24

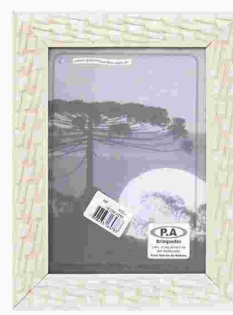

PORTA RET MAD 20X25CM ACET 57 MOD 080  
Código: Fábrica: Unidade:  
**45709** P A SOUZA UN/1  
F1 F4

UN: R\$ 10,73 AV: R\$ 10,73 15: R\$ 10,96  
30: R\$ 11,18 45: R\$ 11,40 60: R\$ 11,63



PORTA RET MAD 20X25CM ACET 68 MOD 010  
Código: Fábrica: Unidade:  
**14933** P A SOUZA UN/1  
F1 F4

UN: R\$ 10,73 AV: R\$ 10,73 15: R\$ 10,96  
30: R\$ 11,18 45: R\$ 11,40 60: R\$ 11,63



PORTA RET MAD 20X25CM ACET 149 MOD 020  
Código: Fábrika: Unidade:  
**7747** P A SOUZA UN/1  
F1 F4

UN: R\$ 20,53 AV: R\$ 20,53 15: R\$ 20,96  
30: R\$ 21,38 45: R\$ 21,81 60: R\$ 22,24



PORTA RET MAD 20X25CM ACET 154 MOD 141  
Código: Fábrika: Unidade:  
**45717** P A SOUZA UN/1  
F1 F4

UN: R\$ 17,82 AV: R\$ 17,82 15: R\$ 18,19  
30: R\$ 18,56 45: R\$ 18,93 60: R\$ 19,31



PORTA RET MAD 20X25CM ACET 159 MOD 133  
Código: Fábrika: Unidade:  
**45695** P A SOUZA UN/1  
F1 F4

UN: R\$ 20,53 AV: R\$ 20,53 15: R\$ 20,96  
30: R\$ 21,38 45: R\$ 21,81 60: R\$ 22,24

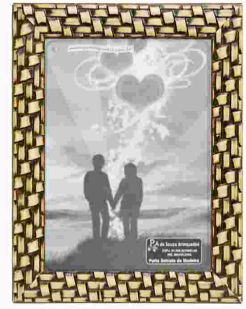

PORTA RET MAD 20X25CM ACET 164 MOD 167  
Código: Fábrika: Unidade:  
**45702** P A SOUZA UN/1  
F1 F4

UN: R\$ 22,59 AV: R\$ 22,59 15: R\$ 23,06  
30: R\$ 23,52 45: R\$ 23,99 60: R\$ 24,47



PORTA RET MAD 20X25CM RUSTIC ACET 005  
Código: Fábrika: Unidade:  
**45765** MOLDULAC UN/1  
F1 F4

UN: R\$ 15,82 AV: R\$ 15,82 15: R\$ 16,15  
30: R\$ 16,47 45: R\$ 16,80 60: R\$ 17,14



PORTA RET MAD 20X25CM VIDRO 104 MOD 010  
Código: Fábrika: Unidade:  
**23462** P A SOUZA UN/1  
F1 F4

UN: R\$ 15,82 AV: R\$ 15,82 15: R\$ 16,15  
30: R\$ 16,47 45: R\$ 16,80 60: R\$ 17,14

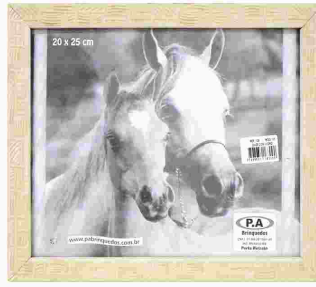

PORTA RET MAD 20X25CM VIDRO 109 MOD 115  
Código: Fábrika: Unidade:  
**22770** P A SOUZA UN/1  
F1 F4

UN: R\$ 15,82 AV: R\$ 15,82 15: R\$ 16,15  
30: R\$ 16,47 45: R\$ 16,80 60: R\$ 17,14

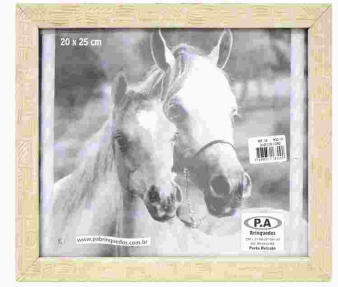

PORTA RET MAD 20X25CM VIDRO 114 MOD 116  
Código: Fábrika: Unidade:  
**23463** P A SOUZA UN/1  
F1 F4

UN: R\$ 21,16 AV: R\$ 21,16 15: R\$ 21,60  
30: R\$ 22,03 45: R\$ 22,47 60: R\$ 22,92



PORTA RET MAD 20X25CM VIDRO 124 MOD 050  
Código: Fábrika: Unidade:  
**45663** P A SOUZA UN/1  
F1 F4

UN: R\$ 24,96 AV: R\$ 24,96 15: R\$ 25,48  
30: R\$ 25,99 45: R\$ 26,51 60: R\$ 27,04

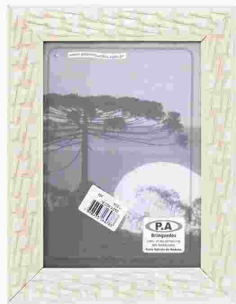

PORTA RET MAD 20X25CM VIDRO 129 MOD 080  
Código: Fábrika: Unidade:  
**45713** P A SOUZA UN/1  
F1 F4

UN: R\$ 21,16 AV: R\$ 21,16 15: R\$ 21,60  
30: R\$ 22,03 45: R\$ 22,47 60: R\$ 22,92



PORTA RET MAD 20X25CM VIDRO 179 MOD 133  
Código: Fábrika: Unidade:  
**45698** P A SOUZA UN/1  
F1 F4

UN: R\$ 24,86 AV: R\$ 24,86 15: R\$ 25,38  
30: R\$ 25,88 45: R\$ 26,40 60: R\$ 26,93

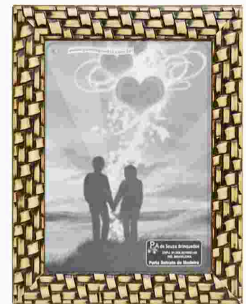

PORTA RET MAD 20X25CM VIDRO 184 MOD 167  
Código: Fábrika: Unidade:  
**45705** P A SOUZA UN/1  
F1 F4

UN: R\$ 15,82 AV: R\$ 15,82 15: R\$ 16,15  
30: R\$ 16,47 45: R\$ 16,80 60: R\$ 17,14



PORTA RET MAD 20X25CM VIDRO 189/6 MOD20  
Código: Fábrika: Unidade:  
**22265** P A SOUZA UN/1  
F1 F4

UN: R\$ 24,86 AV: R\$ 24,86 15: R\$ 25,38  
30: R\$ 25,88 45: R\$ 26,40 60: R\$ 26,93



PORTA RET MAD 20X25CM VIDRO 194 MOD 141  
Código: Fábrika: Unidade:  
**45685** P A SOUZA UN/1  
F1 F4

UN: R\$ 12,32 AV: R\$ 12,32 15: R\$ 12,57  
30: R\$ 12,82 45: R\$ 13,08 60: R\$ 13,34



PORTA RET MAD 20X25CM VIDRO 25035  
Código: Fábrika: Unidade:  
**50215** CASITA UN/1  
F1 F4

UN: R\$ 21,16 AV: R\$ 21,16 15: R\$ 21,60  
30: R\$ 22,03 45: R\$ 22,47 60: R\$ 22,92



PORTA RET MAD 20X25CM VIDRO119 MOD 040  
Código: Fábrika: Unidade:  
**45662** P A SOUZA UN/1  
F1 F4

UN: R\$ 14,37 AV: R\$ 14,37 15: R\$ 14,67  
30: R\$ 14,96 45: R\$ 15,26 60: R\$ 15,57



PORTA RET MAD 20X30CM ACET

Código: 48750 Fábrica: SANTA RITA Unidade: UN/1  
F1 F4

UN: R\$ 23,62 AV: R\$ 23,62 15: R\$ 24,11  
30: R\$ 24,59 45: R\$ 25,08 60: R\$ 25,58

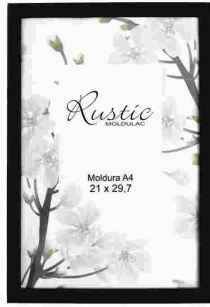

PORTA RET MAD 21X30CM RUSTIC ACET 005

Código: 45766 Fábrica: MOLDULAC Unidade: UN/1  
F1 F4

UN: R\$ 38,00 AV: R\$ 38,00 15: R\$ 38,79  
30: R\$ 39,56 45: R\$ 40,35 60: R\$ 41,16



PORTA RET MAD 30X40CM RUSTIC ACET 005

Código: 45767 Fábrica: MOLDULAC Unidade: UN/1  
F1 F4

UN: R\$ 9,24 AV: R\$ 9,24 15: R\$ 9,44  
30: R\$ 9,63 45: R\$ 9,82 60: R\$ 10,02



PORTA RET PLAST VD 10X15CM BIKE 9110

Código: 25928 Fábrica: YING FA Unidade: UN/1  
F1 F4

UN: R\$ 7,70 AV: R\$ 7,70 15: R\$ 7,86  
30: R\$ 8,02 45: R\$ 8,18 60: R\$ 8,35

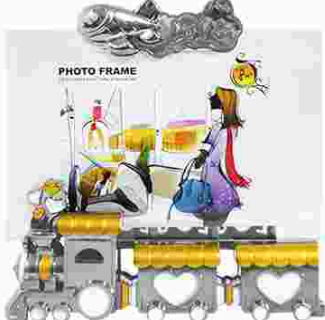

PORTA RET PLAST VD 10X15CM TREM 9084

Código: 28234 Fábrica: YING FA Unidade: UN/1  
F1 F4

UN: R\$ 46,21 AV: R\$ 46,21 15: R\$ 47,18  
30: R\$ 48,12 45: R\$ 49,08 60: R\$ 50,06



PORTA RETRATO VIDRO 10X10 DUPLO VC 11633

Código: 41152 Fábrica: BRASFOOT Unidade: CJ/1  
F1 F4

UN: R\$ 46,43 AV: R\$ 46,43 15: R\$ 47,40  
30: R\$ 48,35 45: R\$ 49,31 60: R\$ 50,30



PORTA RETRATO VIDRO 10X15 ATLETICO 2673

Código: 39131 Fábrica: BRASFOOT Unidade: UN/1  
F1 F4

UN: R\$ 46,43 AV: R\$ 46,43 15: R\$ 47,40  
30: R\$ 48,35 45: R\$ 49,31 60: R\$ 50,30



PORTA RETRATO VIDRO 10X15 CRUZEIRO 2674

Código: 39132 Fábrica: BRASFOOT Unidade: UN/1  
F1 F4

UN: R\$ 33,89 AV: R\$ 33,89 15: R\$ 34,59  
30: R\$ 35,29 45: R\$ 35,99 60: R\$ 36,71



PORTA RETRATO VIDRO 10X15 MAE 11627

Código: 41153 Fábrica: BRASFOOT Unidade: UN/1  
F1 F4

UN: R\$ 0,36 AV: R\$ 0,36 15: R\$ 0,37  
30: R\$ 0,37 45: R\$ 0,38 60: R\$ 0,39



PRATO DE PAPELÃO N 03 17,5CM UN

Código: 49860 Fábrica: PITPRATOS Unidade: UN/1  
F1 F4

UN: R\$ 0,81 AV: R\$ 0,81 15: R\$ 0,83  
30: R\$ 0,85 45: R\$ 0,86 60: R\$ 0,88



PRATO DE PAPELÃO N 06 25CM UN

Código: 49861 Fábrica: PITPRATOS Unidade: UN/1  
F1 F4

UN: R\$ 1,22 AV: R\$ 1,22 15: R\$ 1,25  
30: R\$ 1,27 45: R\$ 1,30 60: R\$ 1,32



PRATO DE PAPELÃO N 09 32CM UN

Código: 49862 Fábrica: PITPRATOS Unidade: UN/1  
F1 F4

UN: R\$ 1,53 AV: R\$ 1,53 15: R\$ 1,56  
30: R\$ 1,59 45: R\$ 1,63 60: R\$ 1,66



PRATO DE PAPELÃO N12 UN

Código: 47741 Fábrica: PITPRATOS Unidade: UN/1  
F1 F4

UN: R\$ 6,16 AV: R\$ 61,62 15: R\$ 62,91  
30: R\$ 64,16 45: R\$ 65,45 60: R\$ 66,76

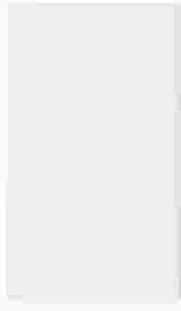

PROTETOR ACRILICO RIGIDO DUT 10X1

Código: 30483 Fábrica: MP Unidade: PT/10  
F1 F4

UN: R\$ 6,15 AV: R\$ 6,15 15: R\$ 6,28  
30: R\$ 6,41 45: R\$ 6,53 60: R\$ 6,67



PROTETOR DE RALO PVC 185X185MM 127

Código: 41830 Fábrica: LIDER PLUS Unidade: UN/1  
F1 F4

UN: R\$ 15,20 AV: R\$ 15,20 15: R\$ 15,52  
30: R\$ 15,83 45: R\$ 16,15 60: R\$ 16,47



PROTETOR PORTA 80CM NAPA PRETO 80-12

Código: 41816 Fábrica: SECULLUS Unidade: UN/1  
F1 F4

UN: R\$ 0,71 AV: R\$ 35,44 15: R\$ 36,18  
30: R\$ 36,90 45: R\$ 37,64 60: R\$ 38,39

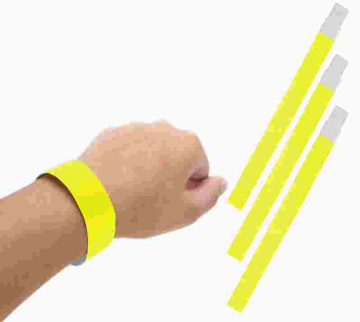

PULSEIRA IDENTIFICACAO TYVEK AMAREL 50X1

Código: 42282 Fábrica: MAXI BANDS Unidade: PT/50 F1 F4

UN: R\$ 0,71 AV: R\$ 35,44 15: R\$ 36,18  
30: R\$ 36,90 45: R\$ 37,64 60: R\$ 38,39



PULSEIRA IDENTIFICACAO TYVEK LARANJ 50X1

Código: 42284 Fábrica: MAXI BANDS Unidade: PT/50 F1 F4

UN: R\$ 0,71 AV: R\$ 35,44 15: R\$ 36,18  
30: R\$ 36,90 45: R\$ 37,64 60: R\$ 38,39

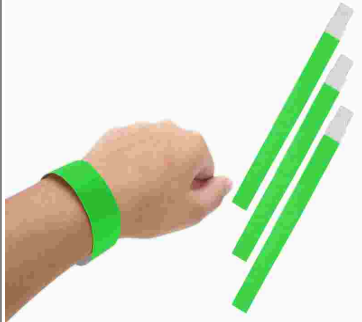

PULSEIRA IDENTIFICACAO TYVEK VERDE 50X1

Código: 42285 Fábrica: MAXI BANDS Unidade: PT/50 F1 F4

UN: R\$ 0,71 AV: R\$ 35,44 15: R\$ 36,18  
30: R\$ 36,90 45: R\$ 37,64 60: R\$ 38,39



PULSEIRA IDENTIFICACAO TYVEK VERMEL 50X1

Código: 42286 Fábrica: MAXI BANDS Unidade: PT/50 F1 F4

UN: R\$ 1,03 AV: R\$ 12,32 15: R\$ 12,57  
30: R\$ 12,82 45: R\$ 13,08 60: R\$ 13,34



PULSEIRA OLODUM FINA 1373 12X1

Código: 33283 Fábrica: NOVIDADE Unidade: PT/12 F1 F4

UN: R\$ 2,05 AV: R\$ 24,64 15: R\$ 25,16  
30: R\$ 25,66 45: R\$ 26,17 60: R\$ 26,70



PULSEIRA OLODUM GROSSA 1117 12X1

Código: 33285 Fábrica: NOVIDADE Unidade: PT/12 F1 F4

UN: R\$ 2,57 AV: R\$ 12,84 15: R\$ 13,11  
30: R\$ 13,37 45: R\$ 13,64 60: R\$ 13,91



PULSEIRA RELOGIO TP COURO 16MM MARR 5X1

Código: 37640 Fábrica: GENCLAS Unidade: PT/5 F4

UN: R\$ 2,57 AV: R\$ 12,84 15: R\$ 13,11  
30: R\$ 13,37 45: R\$ 13,64 60: R\$ 13,91



PULSEIRA RELOGIO TP COURO 18MM PTO 5X1

Código: 37635 Fábrica: GENCLAS Unidade: PT/5 F1 F4

UN: R\$ 2,57 AV: R\$ 12,84 15: R\$ 13,11  
30: R\$ 13,37 45: R\$ 13,64 60: R\$ 13,91



PULSEIRA RELOGIO TP COURO 20MM MARR 5X1

Código: 37637 Fábrica: GENCLAS Unidade: PT/5 F4

UN: R\$ 2,57 AV: R\$ 12,84 15: R\$ 13,11  
30: R\$ 13,37 45: R\$ 13,64 60: R\$ 13,91



PULSEIRA RELOGIO TP COURO 20MM PTO 5X1

Código: 37636 Fábrica: GENCLAS Unidade: PT/5 F1 F4

UN: R\$ 2,57 AV: R\$ 12,84 15: R\$ 13,11  
30: R\$ 13,37 45: R\$ 13,64 60: R\$ 13,91



PULSEIRA RELOGIO TP COURO 22MM MARR 5X1

Código: 37639 Fábrica: GENCLAS Unidade: PT/5 F4

UN: R\$ 2,57 AV: R\$ 12,84 15: R\$ 13,11  
30: R\$ 13,37 45: R\$ 13,64 60: R\$ 13,91



PULSEIRA RELOGIO TP COURO 22MM PTO 5X1

Código: 37638 Fábrica: GENCLAS Unidade: PT/5 F1 F4

UN: R\$ 13,34 AV: R\$ 13,34 15: R\$ 13,62  
30: R\$ 13,89 45: R\$ 14,17 60: R\$ 14,46



PULSEIRA SILICONE P/MONTAR C/MALET 12X40

Código: 34467 Fábrica: NOVIDADE Unidade: KI/1 F1 F4

UN: R\$ 41,08 AV: R\$ 41,08 15: R\$ 41,93  
30: R\$ 42,77 45: R\$ 43,63 60: R\$ 44,50



QUADRO CAIXA PORTA ROLHA 28X44CM 2844

Código: 40980 Fábrica: SANTA RITA Unidade: UN/1 F1 F4

UN: R\$ 7,18 AV: R\$ 7,18 15: R\$ 7,33  
30: R\$ 7,48 45: R\$ 7,63 60: R\$ 7,78



QUADRO MADEIRA 20X20CM 2020

Código: 48751 Fábrica: SANTA RITA Unidade: UN/1 F1 F4

UN: R\$ 4,83 AV: R\$ 4,83 15: R\$ 4,93  
30: R\$ 5,03 45: R\$ 5,13 60: R\$ 5,23

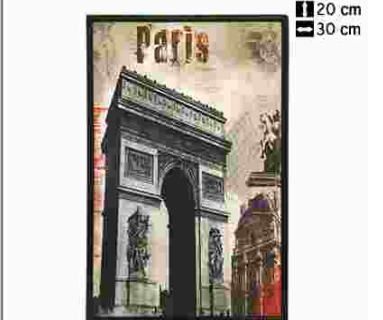

QUADRO PLAST P/ FIXAR 20X30CM 52597

Código: 32628 Fábrica: 20 COMERCIAL Unidade: UN/1 F1 F4

UN: R\$ 9,24 AV: R\$ 9,24 15: R\$ 9,44  
 30: R\$ 9,63 45: R\$ 9,82 60: R\$ 10,02  
 11 25 cm  
 52 cm



QUADRO PLAST P/ FIXAR 25X52CM 52601  
 Código: Fábrica: Unidade:  
**32631** 20 COMERCIAL UN/1  
 F1 F4

UN: R\$ 7,60 AV: R\$ 7,60 15: R\$ 7,76  
 30: R\$ 7,91 45: R\$ 8,07 60: R\$ 8,23  
 11 37 cm  
 26 cm



QUADRO PLAST P/ FIXAR 26X37CM 52598  
 Código: Fábrica: Unidade:  
**32629** 20 COMERCIAL UN/1  
 F1 F4

UN: R\$ 10,07 AV: R\$ 10,07 15: R\$ 10,28  
 30: R\$ 10,48 45: R\$ 10,69 60: R\$ 10,91  
 11 38 cm 38 cm



QUADRO PLAST P/ FIXAR 38X38CM 52599  
 Código: Fábrica: Unidade:  
**32630** 20 COMERCIAL UN/1  
 F1 F4

UN: R\$ 10,89 AV: R\$ 10,89 15: R\$ 11,12  
 30: R\$ 11,34 45: R\$ 11,56 60: R\$ 11,80  
 11 38 cm  
 48 cm

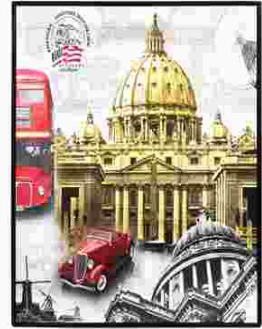

QUADRO PLAST P/ FIXAR 38X48CM 52600  
 Código: Fábrica: Unidade:  
**32632** 20 COMERCIAL UN/1  
 F1 F4

UN: R\$ 7,18 AV: R\$ 7,18 15: R\$ 7,33  
 30: R\$ 7,48 45: R\$ 7,63 60: R\$ 7,78

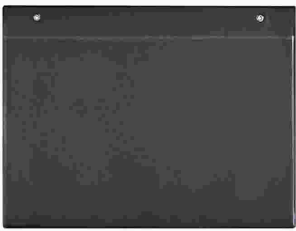

QUADRO PLAST P/QUADRO HORARIO OF UN  
 Código: Fábrica: Unidade:  
**47029** ACP UN/1  
 F1 F4

UN: R\$ 7,19 AV: R\$ 71,89 15: R\$ 73,39  
 30: R\$ 74,86 45: R\$ 76,36 60: R\$ 77,88



QUADRO PLAST P/QUADRO HORARIO OF 10X1  
 Código: Fábrica: Unidade:  
**41789** MP PT/10  
 F1 F4

UN: R\$ 7,18 AV: R\$ 7,18 15: R\$ 7,33  
 30: R\$ 7,48 45: R\$ 7,63 60: R\$ 7,78

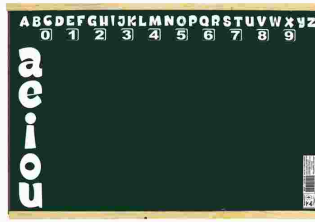

QUADRO VERDE (LOUISA) 25X39CM 2539  
 Código: Fábrica: Unidade:  
**40978** SANTA RITA UN/1  
 F1 F4

UN: R\$ 24,24 AV: R\$ 24,24 15: R\$ 24,75  
 30: R\$ 25,24 45: R\$ 25,75 60: R\$ 26,26  
 11 30 cm  
 40 cm



QUADRO 30X40 MOLD VINTAGE QDVT-022  
 Código: Fábrica: Unidade:  
**35189** MM QUADROS UN/1  
 F1 F4

UN: R\$ 42,55 AV: R\$ 42,55 15: R\$ 43,43  
 30: R\$ 44,30 45: R\$ 45,19 60: R\$ 46,09  
 11 50 cm  
 70 cm



QUADRO 50X70CM RESIN MOLD 2,5CM ANIMAL  
 Código: Fábrica: Unidade:  
**40791** MM QUADROS UN/1  
 F1 F4

UN: R\$ 42,55 AV: R\$ 42,55 15: R\$ 43,43  
 30: R\$ 44,30 45: R\$ 45,19 60: R\$ 46,09  
 11 50 cm  
 70 cm



QUADRO 50X70CM RESIN MOLD 2,5CM FLORAL  
 Código: Fábrica: Unidade:  
**40792** MM QUADROS UN/1  
 F1 F4

UN: R\$ 42,55 AV: R\$ 42,55 15: R\$ 43,43  
 30: R\$ 44,30 45: R\$ 45,19 60: R\$ 46,09  
 11 50 cm  
 70 cm



QUADRO 50X70CM RESIN MOLD 2,5CM PAISAGEM  
 Código: Fábrica: Unidade:  
**40790** MM QUADROS UN/1  
 F1 F4

UN: R\$ 0,16 AV: R\$ 11,29 15: R\$ 11,52  
 30: R\$ 11,75 45: R\$ 11,99 60: R\$ 12,23



RABICO MEIA LISO COLOR 3,5CM 2551 12X6  
 Código: Fábrica: Unidade:  
**28034** MISS FRANCE PT/72  
 F1 F4

UN: R\$ 0,13 AV: R\$ 10,26 15: R\$ 10,48  
 30: R\$ 10,69 45: R\$ 10,90 60: R\$ 11,12



RABICO MEIA LISO COLOR 3,5CM 2575 80X1  
 Código: Fábrica: Unidade:  
**50960** MISS FRANCE PT/80  
 F1 F4

UN: R\$ 0,29 AV: R\$ 20,53 15: R\$ 20,96  
 30: R\$ 21,38 45: R\$ 21,81 60: R\$ 22,24



RABICO MEIA LISO PRETO MED 4801 12X6  
 Código: Fábrica: Unidade:  
**32221** HAI BRASIL PT/72  
 F1 F4

UN: R\$ 0,13 AV: R\$ 10,26 15: R\$ 10,48  
 30: R\$ 10,69 45: R\$ 10,90 60: R\$ 11,12



RABICO MEIA LISO PRETO 3,5CM 2582 80X1  
 Código: Fábrica: Unidade:  
**50961** MISS FRANCE PT/80  
 F1 F4

UN: R\$ 0,07 AV: R\$ 1,44 15: R\$ 1,47  
 30: R\$ 1,50 45: R\$ 1,53 60: R\$ 1,56

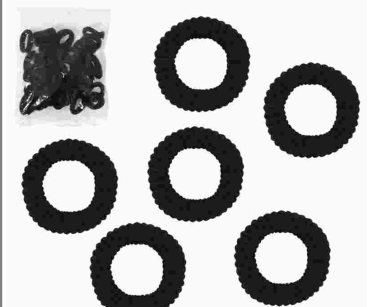

RABICO PP PRETO 20X1  
 Código: Fábrica: Unidade:  
**22454** KM PT/20  
 F1 F4

UN: R\$ 0,94 AV: R\$ 11,29 15: R\$ 11,52  
30: R\$ 11,75 45: R\$ 11,99 60: R\$ 12,23



RABICO SILICONE PRETO C/100 12X1 4325  
Código: Fábrika: Unidade:  
**49757** SQ CT/12  
F1 F4

UN: R\$ 67,80 AV: R\$ 67,80 15: R\$ 69,21  
30: R\$ 70,59 45: R\$ 72,00 60: R\$ 73,44



RADIO MICROFONE USB C/LUZ 1308  
Código: Fábrika: Unidade:  
**33671** AGUIABRANCA CX/1  
F1 F4

UN: R\$ 24,99 AV: R\$ 24,99 15: R\$ 24,99  
30: R\$ 24,99 45: R\$ 24,99 60: R\$ 24,99



RAQUETE MATA MOSQUITOS RECARREG 110/220V  
Código: Fábrika: Unidade:  
**27980** PRO UN/1  
F1 F4

UN: R\$ 6,06 AV: R\$ 60,59 15: R\$ 61,86  
30: R\$ 63,09 45: R\$ 64,36 60: R\$ 65,64



RECEPTACULO PORCELANA EMBORR NF16 10X1  
Código: Fábrika: Unidade:  
**44379** GIROFLASH PT/10  
F1 F4

UN: R\$ 17,45 AV: R\$ 17,45 15: R\$ 17,82  
30: R\$ 18,17 45: R\$ 18,54 60: R\$ 18,91



RELOGIO PAREDE CASINHA 21X25CM  
Código: Fábrika: Unidade:  
**47901** YINS UN/1  
F1 F4

UN: R\$ 26,70 AV: R\$ 26,70 15: R\$ 27,25  
30: R\$ 27,80 45: R\$ 28,35 60: R\$ 28,92



RELOGIO PAREDE OCTO PILHA CAFE PTO 07  
Código: Fábrika: Unidade:  
**32427** GAMA UN/1  
F1 F4

UN: R\$ 26,70 AV: R\$ 26,70 15: R\$ 27,25  
30: R\$ 27,80 45: R\$ 28,35 60: R\$ 28,92



RELOGIO PAREDE OCTO PILHA CARROS BCO 07  
Código: Fábrika: Unidade:  
**44453** GAMA UN/1  
F1 F4

UN: R\$ 26,70 AV: R\$ 26,70 15: R\$ 27,25  
30: R\$ 27,80 45: R\$ 28,35 60: R\$ 28,92



RELOGIO PAREDE OCTO PILHA CARROS PTO 07  
Código: Fábrika: Unidade:  
**36206** GAMA UN/1  
F1 F4

UN: R\$ 26,70 AV: R\$ 26,70 15: R\$ 27,25  
30: R\$ 27,80 45: R\$ 28,35 60: R\$ 28,92



RELOGIO PAREDE OCTO PILHA CORUJA PTO 07  
Código: Fábrika: Unidade:  
**44454** GAMA UN/1  
F1 F4

UN: R\$ 26,70 AV: R\$ 26,70 15: R\$ 27,25  
30: R\$ 27,80 45: R\$ 28,35 60: R\$ 28,92



RELOGIO PAREDE OCTO PILHA FILIPENSES BCO  
Código: Fábrika: Unidade:  
**46542** GAMA UN/1  
F1 F4

UN: R\$ 26,70 AV: R\$ 26,70 15: R\$ 27,25  
30: R\$ 27,80 45: R\$ 28,35 60: R\$ 28,92



RELOGIO PAREDE OCTO PILHA FILIPENSES PTO  
Código: Fábrika: Unidade:  
**32431** GAMA UN/1  
F1 F4

UN: R\$ 26,70 AV: R\$ 26,70 15: R\$ 27,25  
30: R\$ 27,80 45: R\$ 28,35 60: R\$ 28,92



RELOGIO PAREDE OCTO PILHA FRUTAS PTO 007  
Código: Fábrika: Unidade:  
**32425** GAMA UN/1  
F1 F4

UN: R\$ 26,70 AV: R\$ 26,70 15: R\$ 27,25  
30: R\$ 27,80 45: R\$ 28,35 60: R\$ 28,92



RELOGIO PAREDE OCTO PILHA GALINHA PTO 07  
Código: Fábrika: Unidade:  
**49282** GAMA UN/1  
F1 F4

UN: R\$ 26,70 AV: R\$ 26,70 15: R\$ 27,25  
30: R\$ 27,80 45: R\$ 28,35 60: R\$ 28,92



RELOGIO PAREDE OCTO PILHA MAMAE 1 PHR007  
Código: Fábrika: Unidade:  
**34902** GAMA UN/1  
F1 F4

UN: R\$ 26,70 AV: R\$ 26,70 15: R\$ 27,25  
30: R\$ 27,80 45: R\$ 28,35 60: R\$ 28,92



RELOGIO PAREDE OCTO PILHA MAMAE 2 PTO 07  
Código: Fábrika: Unidade:  
**49281** GAMA UN/1  
F1 F4

UN: R\$ 26,70 AV: R\$ 26,70 15: R\$ 27,25  
30: R\$ 27,80 45: R\$ 28,35 60: R\$ 28,92



RELOGIO PAREDE OCTO PILHA PET DOG BCO 07  
Código: Fábrika: Unidade:  
**44452** GAMA UN/1  
F1 F4

UN: R\$ 26,70 AV: R\$ 26,70 15: R\$ 27,25  
30: R\$ 27,80 45: R\$ 28,35 60: R\$ 28,92



RELOGIO PAREDE OCTO PILHA PET DOG PTO 07

Código: Fábrika: Unidade:  
**33434** GAMA UN/1  
F1 F4

UN: R\$ 26,70 AV: R\$ 26,70 15: R\$ 27,25  
30: R\$ 27,80 45: R\$ 28,35 60: R\$ 28,92



RELOGIO PAREDE OCTO PILHA SALMOS BCO 07

Código: Fábrika: Unidade:  
**44451** GAMA UN/1  
F1 F4

UN: R\$ 26,70 AV: R\$ 26,70 15: R\$ 27,25  
30: R\$ 27,80 45: R\$ 28,35 60: R\$ 28,92



RELOGIO PAREDE RED PILHA DEC BCO AMAR 03

Código: Fábrika: Unidade:  
**41679** OMEGA UN/1  
F1 F4

UN: R\$ 26,70 AV: R\$ 26,70 15: R\$ 27,25  
30: R\$ 27,80 45: R\$ 28,35 60: R\$ 28,92



RELOGIO PAREDE RED PILHA DEC BCO AZUL 03

Código: Fábrika: Unidade:  
**43840** OMEGA UN/1  
F1 F4

UN: R\$ 26,70 AV: R\$ 26,70 15: R\$ 27,25  
30: R\$ 27,80 45: R\$ 28,35 60: R\$ 28,92



RELOGIO PAREDE RED PILHA DESIGNER PHR 03

Código: Fábrika: Unidade:  
**32435** OMEGA UN/1  
F1 F4

UN: R\$ 26,70 AV: R\$ 26,70 15: R\$ 27,25  
30: R\$ 27,80 45: R\$ 28,35 60: R\$ 28,92



RELOGIO PAREDE RED PILHA FRUTAS BCO 03

Código: Fábrika: Unidade:  
**33433** OMEGA UN/1  
F1 F4

UN: R\$ 26,70 AV: R\$ 26,70 15: R\$ 27,25  
30: R\$ 27,80 45: R\$ 28,35 60: R\$ 28,92



RELOGIO PAREDE RED PILHA FRUTAS PTO 03

Código: Fábrika: Unidade:  
**46808** OMEGA UN/1  
F1 F4

UN: R\$ 26,70 AV: R\$ 26,70 15: R\$ 27,25  
30: R\$ 27,80 45: R\$ 28,35 60: R\$ 28,92



RELOGIO PAREDE RED PILHA JESUS BCO 03

Código: Fábrika: Unidade:  
**44449** OMEGA UN/1  
F1 F4

UN: R\$ 26,70 AV: R\$ 26,70 15: R\$ 27,25  
30: R\$ 27,80 45: R\$ 28,35 60: R\$ 28,92



RELOGIO PAREDE RED PILHA LONDON PHR 03

Código: Fábrika: Unidade:  
**32434** OMEGA UN/1  
F1 F4

UN: R\$ 26,70 AV: R\$ 26,70 15: R\$ 27,25  
30: R\$ 27,80 45: R\$ 28,35 60: R\$ 28,92



RELOGIO PAREDE RED PILHA MAMAE 1 BCO 03

Código: Fábrika: Unidade:  
**44448** OMEGA UN/1  
F1 F4

UN: R\$ 26,70 AV: R\$ 26,70 15: R\$ 27,25  
30: R\$ 27,80 45: R\$ 28,35 60: R\$ 28,92



RELOGIO PAREDE RED PILHA MAMAE 1 PTO 03

Código: Fábrika: Unidade:  
**34903** OMEGA UN/1  
F1 F4

UN: R\$ 26,70 AV: R\$ 26,70 15: R\$ 27,25  
30: R\$ 27,80 45: R\$ 28,35 60: R\$ 28,92



RELOGIO PAREDE RED PILHA MAMAE 2 BCO 03

Código: Fábrika: Unidade:  
**38086** OMEGA UN/1  
F1 F4

UN: R\$ 26,70 AV: R\$ 26,70 15: R\$ 27,25  
30: R\$ 27,80 45: R\$ 28,35 60: R\$ 28,92



RELOGIO PAREDE RED PILHA MAMAE 2 PTO 03

Código: Fábrika: Unidade:  
**34904** OMEGA UN/1  
F1 F4

UN: R\$ 26,70 AV: R\$ 26,70 15: R\$ 27,25  
30: R\$ 27,80 45: R\$ 28,35 60: R\$ 28,92

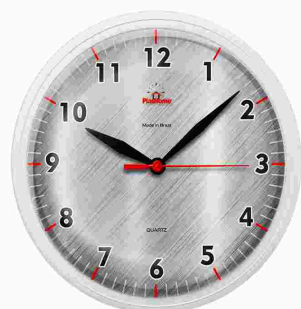

RELOGIO PAREDE RED PILHA MODERNO BCO 03

Código: Fábrika: Unidade:  
**32429** OMEGA UN/1  
F1 F4

UN: R\$ 26,70 AV: R\$ 26,70 15: R\$ 27,25  
30: R\$ 27,80 45: R\$ 28,35 60: R\$ 28,92

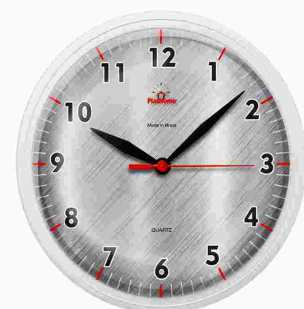

RELOGIO PAREDE RED PILHA MODERNO PTO 03

Código: Fábrika: Unidade:  
**39711** OMEGA UN/1  
F1 F4

UN: R\$ 26,70 AV: R\$ 26,70 15: R\$ 27,25  
30: R\$ 27,80 45: R\$ 28,35 60: R\$ 28,92



RELOGIO PAREDE RED PILHA N S APAREC BCO3

Código: Fábrika: Unidade:  
**32432** OMEGA UN/1  
F1 F4

UN: R\$ 26,70 AV: R\$ 26,70 15: R\$ 27,25  
30: R\$ 27,80 45: R\$ 28,35 60: R\$ 28,92



RELOGIO PAREDE RED PILHA NATUREZA BCO 03

Código: Fábrika: Unidade:  
**32428** OMEGA UN/1  
F1 F4

UN: R\$ 26,70 AV: R\$ 26,70 15: R\$ 27,25  
30: R\$ 27,80 45: R\$ 28,35 60: R\$ 28,92



RELOGIO PAREDE RED PILHA PARIS BCO 03

Código: Fábrika: Unidade:  
**38083** OMEGA UN/1  
F1 F4

UN: R\$ 26,70 AV: R\$ 26,70 15: R\$ 27,25  
30: R\$ 27,80 45: R\$ 28,35 60: R\$ 28,92



RELOGIO PAREDE RED PILHA PARIS PTO 03

Código: Fábrika: Unidade:  
**37840** OMEGA UN/1  
F1 F4

UN: R\$ 26,70 AV: R\$ 26,70 15: R\$ 27,25  
30: R\$ 27,80 45: R\$ 28,35 60: R\$ 28,92



RELOGIO PAREDE RED PILHA PTO PTO 03

Código: Fábrika: Unidade:  
**34901** OMEGA UN/1  
F1 F4

UN: R\$ 26,70 AV: R\$ 26,70 15: R\$ 27,25  
30: R\$ 27,80 45: R\$ 28,35 60: R\$ 28,92



RELOGIO PAREDE RED PILHA TACA MUN BCO 03

Código: Fábrika: Unidade:  
**39713** OMEGA UN/1  
F1 F4

UN: R\$ 26,70 AV: R\$ 26,70 15: R\$ 27,25  
30: R\$ 27,80 45: R\$ 28,35 60: R\$ 28,92



RELOGIO PAREDE RED PILHA VACA PTO 03

Código: Fábrika: Unidade:  
**32424** OMEGA UN/1  
F1 F4

UN: R\$ 18,48 AV: R\$ 18,48 15: R\$ 18,86  
30: R\$ 19,24 45: R\$ 19,63 60: R\$ 20,02



RELOGIO PAREDE RED SOFT EUCATEX 30 CM

Código: Fábrika: Unidade:  
**40981** SANTA RITA UN/1  
F1 F4

UN: R\$ 33,89 AV: R\$ 33,89 15: R\$ 34,59  
30: R\$ 35,29 45: R\$ 35,99 60: R\$ 36,71

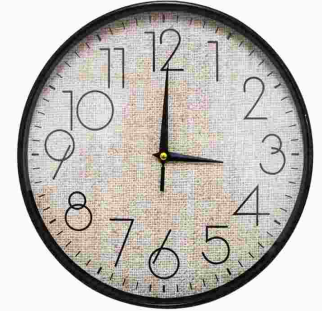

RELOGIO PAREDE RED 30CM PILHA AA 164

Código: Fábrika: Unidade:  
**50228** FUTURO UN/1  
F1 F4

UN: R\$ 82,17 AV: R\$ 82,17 15: R\$ 83,88  
30: R\$ 85,56 45: R\$ 87,27 60: R\$ 89,01



RELOGIO PAREDE 2010 PILHA MUSICAL

Código: Fábrika: Unidade:  
**26561** YING FA UN/1  
F1 F4

UN: R\$ 30,82 AV: R\$ 30,82 15: R\$ 31,46  
30: R\$ 32,09 45: R\$ 32,73 60: R\$ 33,38



RELOGIO PULSO AQUA GRANDE

Código: Fábrika: Unidade:  
**3616** AQUA UN/1  
F4

UN: R\$ 30,82 AV: R\$ 30,82 15: R\$ 31,46  
30: R\$ 32,09 45: R\$ 32,73 60: R\$ 33,38



RELOGIO PULSO AQUA PEQUENO

Código: Fábrika: Unidade:  
**25160** AQUA UN/1  
F4

UN: R\$ 30,81 AV: R\$ 30,81 15: R\$ 31,45  
30: R\$ 32,08 45: R\$ 32,72 60: R\$ 33,37



RELOGIO PULSO DIGITAL EMBORR SPORT

Código: Fábrika: Unidade:  
**21589** NR UN/1  
F4

UN: R\$ 12,33 AV: R\$ 12,33 15: R\$ 12,58  
30: R\$ 12,83 45: R\$ 13,09 60: R\$ 13,35



RELOGIO PULSO EMB DIGITAL COLOR FEM

Código: Fábrika: Unidade:  
**40748** FELE UN/1  
F1 F4

UN: R\$ 30,82 AV: R\$ 30,82 15: R\$ 31,46  
30: R\$ 32,09 45: R\$ 32,73 60: R\$ 33,38



RELOGIO PULSO EMBORRACHADO CASIO

Código: Fábrika: Unidade:  
**23434** CASIO UN/1  
F4

UN: R\$ 30,82 AV: R\$ 30,82 15: R\$ 31,46  
30: R\$ 32,09 45: R\$ 32,73 60: R\$ 33,38



RELOGIO PULSO FEM METAL

Código: Fábrika: Unidade:  
**27325** NR UN/1  
F1 F4

UN: R\$ 14,37 AV: R\$ 14,37 15: R\$ 14,67  
30: R\$ 14,96 45: R\$ 15,26 60: R\$ 15,57



RELOGIO PULSO METAL CASIO DOURADO

Código: Fábrika: Unidade:  
**35010** CASIO UN/1  
F1 F4

UN: R\$ 20,53 AV: R\$ 20,53 15: R\$ 20,96  
30: R\$ 21,38 45: R\$ 21,81 60: R\$ 22,24



RELOGIO PULSO METAL CASIO GRAFITE

Código: Fábrica: Unidade:  
**41269** CASIO UN/1  
F4

UN: R\$ 14,37 AV: R\$ 14,37 15: R\$ 14,67  
30: R\$ 14,96 45: R\$ 15,26 60: R\$ 15,57



RELOGIO PULSO METAL CASIO PRATA

Código: Fábrica: Unidade:  
**35009** CASIO UN/1  
F4

UN: R\$ 14,37 AV: R\$ 14,37 15: R\$ 14,67  
30: R\$ 14,96 45: R\$ 15,26 60: R\$ 15,57



RELOGIO PULSO METAL CASIO ROSE GOLD

Código: Fábrica: Unidade:  
**41270** CASIO UN/1  
F4

UN: R\$ 12,33 AV: R\$ 12,33 15: R\$ 12,58  
30: R\$ 12,83 45: R\$ 13,09 60: R\$ 13,35



RELOGIO PULSO METAL FEMININO

Código: Fábrica: Unidade:  
**40744** FELE UN/1  
F1 F4

UN: R\$ 12,33 AV: R\$ 12,33 15: R\$ 12,58  
30: R\$ 12,83 45: R\$ 13,09 60: R\$ 13,35



RELOGIO PULSO METAL MASCULINO

Código: Fábrica: Unidade:  
**40745** FELE UN/1  
F1 F4

UN: R\$ 34,91 AV: R\$ 34,91 15: R\$ 35,64  
30: R\$ 36,35 45: R\$ 37,08 60: R\$ 37,82



RELOGIO PULSO PULSEIRA METAL DOURADO

Código: Fábrica: Unidade:  
**23440** SP UN/1  
F1 F4

UN: R\$ 11,30 AV: R\$ 11,30 15: R\$ 11,53  
30: R\$ 11,77 45: R\$ 12,00 60: R\$ 12,24



RELOGIO PULSO SILICONE COLOR FEM

Código: Fábrica: Unidade:  
**40749** FELE UN/1  
F1 F4

UN: R\$ 10,79 AV: R\$ 10,79 15: R\$ 11,01  
30: R\$ 11,23 45: R\$ 11,46 60: R\$ 11,68



RELOGIO PULSO SILICONE DIGITAL

Código: Fábrica: Unidade:  
**40743** FELE UN/1  
F1 F4

UN: R\$ 12,33 AV: R\$ 12,33 15: R\$ 12,58  
30: R\$ 12,83 45: R\$ 13,09 60: R\$ 13,35



RELOGIO PULSO SILICONE MASC

Código: Fábrica: Unidade:  
**40750** FELE UN/1  
F1 F4

UN: R\$ 12,33 AV: R\$ 12,33 15: R\$ 12,58  
30: R\$ 12,83 45: R\$ 13,09 60: R\$ 13,35



RELOGIO PULSO TP COURO FEM

Código: Fábrica: Unidade:  
**40746** FELE UN/1  
F1 F4

UN: R\$ 1,77 AV: R\$ 8,86 15: R\$ 9,05  
30: R\$ 9,23 45: R\$ 9,42 60: R\$ 9,60



ROLHA CONICA 19X23X19MM 94 5X1

Código: Fábrica: Unidade:  
**45630** CORTIARTE PT/5  
F1 F4

UN: R\$ 1,60 AV: R\$ 80,11 15: R\$ 81,78  
30: R\$ 83,42 45: R\$ 85,08 60: R\$ 86,79



ROLHA CONICA 19X23X19MM 94 50X1

Código: Fábrica: Unidade:  
**49133** CORTIARTE PT/50  
F1 F4

UN: R\$ 0,04 AV: R\$ 18,48 15: R\$ 18,86  
30: R\$ 19,24 45: R\$ 19,63 60: R\$ 20,02



SACO PLAST BOB 20X30CM PICOTADO 500X1

Código: Fábrica: Unidade:  
**44364** ECO ROLL RL/500  
F1 F4

UN: R\$ 0,05 AV: R\$ 25,67 15: R\$ 26,20  
30: R\$ 26,73 45: R\$ 27,26 60: R\$ 27,81



SACO PLAST BOB 30X30CM PICOTADO 500X1 5K

Código: Fábrica: Unidade:  
**44759** VERTEX RL/500  
F1 F4

UN: R\$ 0,15 AV: R\$ 59,27 15: R\$ 60,50  
30: R\$ 61,71 45: R\$ 62,95 60: R\$ 64,21



SACO PLAST BOB 40X60CM PICOTADO 400X1

Código: Fábrica: Unidade:  
**44368** ECO ROLL PT/400  
F1 F4

UN: R\$ 0,88 AV: R\$ 43,81 15: R\$ 44,72  
30: R\$ 45,62 45: R\$ 46,53 60: R\$ 47,46



SACO PLAST LIXO AZUL 59X62CM 30L 50X1

Código: Fábrica: Unidade:  
**50102** VERTEX PT/50  
F1 F4

UN: R\$ 0,15 AV: R\$ 15,40 15: R\$ 15,72  
30: R\$ 16,03 45: R\$ 16,35 60: R\$ 16,68



SACO PLAST LIXO PTO 39CMX58CM 15L 100X1  
Código: 50844 Fábrica: POLIFILME Unidade: RL/100 F1 F4

UN: R\$ 0,29 AV: R\$ 14,37 15: R\$ 14,67  
30: R\$ 14,96 45: R\$ 15,26 60: R\$ 15,57



SACO PLAST LIXO PTO 59X62CM 30L 50X1  
Código: 50830 Fábrica: POLIFILME Unidade: RL/50 F1 F4

UN: R\$ 0,48 AV: R\$ 14,37 15: R\$ 14,67  
30: R\$ 14,96 45: R\$ 15,26 60: R\$ 15,57



SACO PLAST LIXO PTO 63CMX80CM 50L 30X1  
Código: 50832 Fábrica: POLIFILME Unidade: RL/30 F1 F4

UN: R\$ 0,80 AV: R\$ 14,37 15: R\$ 14,67  
30: R\$ 14,96 45: R\$ 15,26 60: R\$ 15,57



SACO PLAST LIXO PTO 75CMX105CM 100L 18X1  
Código: 50831 Fábrica: POLIFILME Unidade: RL/18 F1 F4

UN: R\$ 1,31 AV: R\$ 32,86 15: R\$ 33,54  
30: R\$ 34,22 45: R\$ 34,90 60: R\$ 35,60



SACO PLAST LIXO PTO 75CMX1,05M 100L 25X1  
Código: 44363 Fábrica: VERTEX Unidade: RL/25 F1 F4

UN: R\$ 0,32 AV: R\$ 2,57 15: R\$ 2,62  
30: R\$ 2,67 45: R\$ 2,73 60: R\$ 2,78

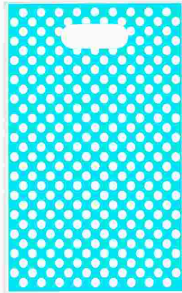

SACOLA PLAST PRES 16X25CM BOLIN AZUL 8X1  
Código: 39570 Fábrica: VMP Unidade: PT/8 F1 F4

UN: R\$ 0,32 AV: R\$ 2,57 15: R\$ 2,62  
30: R\$ 2,67 45: R\$ 2,73 60: R\$ 2,78

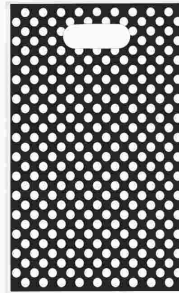

SACOLA PLAST PRES 16X25CM BOLIN PRET 8X1  
Código: 39569 Fábrica: VMP Unidade: PT/8 F1 F4

UN: R\$ 0,32 AV: R\$ 2,57 15: R\$ 2,62  
30: R\$ 2,67 45: R\$ 2,73 60: R\$ 2,78

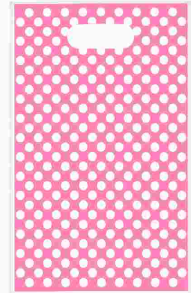

SACOLA PLAST PRES 16X25CM BOLIN ROSA 8X1  
Código: 39568 Fábrica: VMP Unidade: PT/8 F1 F4

UN: R\$ 0,32 AV: R\$ 2,57 15: R\$ 2,62  
30: R\$ 2,67 45: R\$ 2,73 60: R\$ 2,78

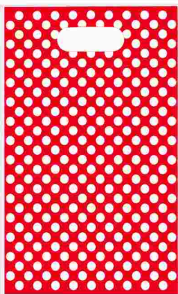

SACOLA PLAST PRES 16X25CM BOLIN VERM 8X1  
Código: 39567 Fábrica: VMP Unidade: PT/8 F1 F4

UN: R\$ 0,32 AV: R\$ 2,57 15: R\$ 2,62  
30: R\$ 2,67 45: R\$ 2,73 60: R\$ 2,78

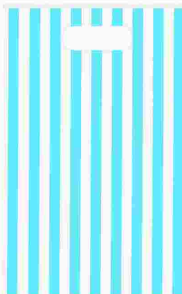

SACOLA PLAST PRES 16X25CM LISTR AZUL 8X1  
Código: 39572 Fábrica: VMP Unidade: PT/8 F1 F4

UN: R\$ 0,32 AV: R\$ 2,57 15: R\$ 2,62  
30: R\$ 2,67 45: R\$ 2,73 60: R\$ 2,78



SACOLA PLAST PRES 16X25CM LISTR ROSA 8X1  
Código: 39565 Fábrica: VMP Unidade: PT/8 F1 F4

UN: R\$ 0,32 AV: R\$ 2,57 15: R\$ 2,62  
30: R\$ 2,67 45: R\$ 2,73 60: R\$ 2,78

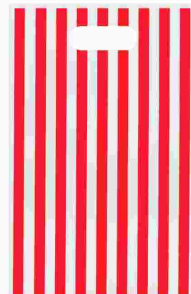

SACOLA PLAST PRES 16X25CM LISTR VERM 8X1  
Código: 39564 Fábrica: VMP Unidade: PT/8 F1 F4

UN: R\$ 71,89 AV: R\$ 71,89 15: R\$ 73,39  
30: R\$ 74,86 45: R\$ 76,36 60: R\$ 77,88

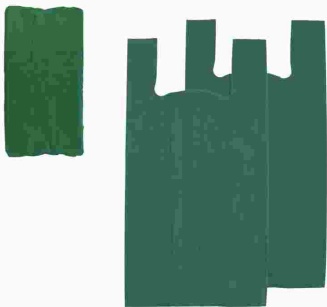

SACOLA PLAST RECIC 30X40CM P VERDE 3KG  
Código: 47257 Fábrica: MAXIPLASTICO Unidade: PT/1 F1 F4

UN: R\$ 118,12 AV: R\$ 118,12 15: R\$ 120,58  
30: R\$ 122,99 45: R\$ 125,45 60: R\$ 127,96

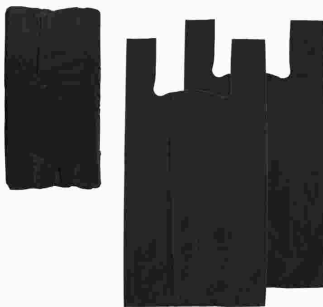

SACOLA PLAST RECIC 40X50CM M PRETA 5KG  
Código: 44605 Fábrica: MAXIPLASTICO Unidade: PT/1 F1 F4

UN: R\$ 123,25 AV: R\$ 123,25 15: R\$ 125,82  
30: R\$ 128,34 45: R\$ 130,90 60: R\$ 133,52

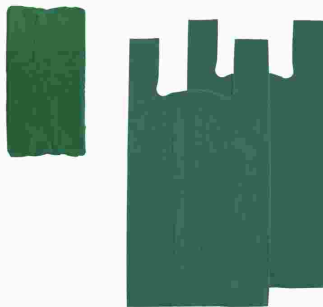

SACOLA PLAST RECIC 40X50CM M VERDE 5KG  
Código: 44608 Fábrica: MAXIPLASTICO Unidade: PT/1 F1 F4

UN: R\$ 123,25 AV: R\$ 123,25 15: R\$ 125,82  
30: R\$ 128,34 45: R\$ 130,90 60: R\$ 133,52

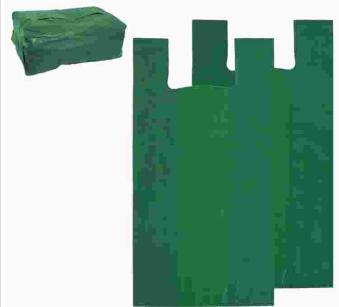

SACOLA PLAST RECIC 50X60CM G VERDE 5KG  
Código: 44609 Fábrica: MAXIPLASTICO Unidade: PT/1 F1 F4

UN: R\$ 123,25 AV: R\$ 123,25 15: R\$ 125,82  
30: R\$ 128,34 45: R\$ 130,90 60: R\$ 133,52



SACOLA PLAST RECIC 60X75CM GG VERDE 5KG  
Código: Fábrica: Unidade:  
**44610** MAXIPLASTICO PT/1  
F1 F4

UN: R\$ 123,25 AV: R\$ 123,25 15: R\$ 125,82  
30: R\$ 128,34 45: R\$ 130,90 60: R\$ 133,52



SACOLA PLAST RECIC 80X100CM XG VERDE 5KG  
Código: Fábrica: Unidade:  
**44611** MAXIPLASTICO PT/1  
F1 F4

UN: R\$ 46,21 AV: R\$ 46,21 15: R\$ 47,18  
30: R\$ 48,12 45: R\$ 49,08 60: R\$ 50,06

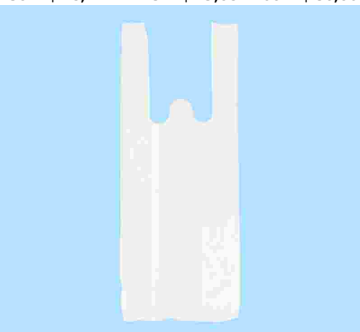

SACOLA PLAST 25X35CM BRANCA 1000X1  
Código: Fábrica: Unidade:  
**47373** PACK-FORT PT/1  
F1 F4

UN: R\$ 30,56 AV: R\$ 30,56 15: R\$ 31,20  
30: R\$ 31,82 45: R\$ 32,46 60: R\$ 33,11



SOMBRINHA 8V DUP GIG CB CURV MAN 401.1  
Código: Fábrica: Unidade:  
**17656** MIZPA UN/1  
F1 F4

UN: R\$ 30,56 AV: R\$ 30,56 15: R\$ 31,20  
30: R\$ 31,82 45: R\$ 32,46 60: R\$ 33,11



SOMBRINHA 8V DUP GIG CB RETO MAN 403.3  
Código: Fábrica: Unidade:  
**17649** MIZPA UN/1  
F1 F4

UN: R\$ 19,99 AV: R\$ 19,99 15: R\$ 19,99  
30: R\$ 19,99 45: R\$ 19,99 60: R\$ 19,99



SOMBRINHA 8V INF C/APITO AUT 5169-CD  
Código: Fábrica: Unidade:  
**24724** RISOVIT UN/1  
F1 F4

UN: R\$ 29,78 AV: R\$ 29,78 15: R\$ 30,40  
30: R\$ 31,01 45: R\$ 31,63 60: R\$ 32,26



SOMBRINHA 8V LONG XAD CB RET AU 1223-A3  
Código: Fábrica: Unidade:  
**17662** HIMEB UN/1  
F1 F4

UN: R\$ 55,76 AV: R\$ 55,76 15: R\$ 56,92  
30: R\$ 58,06 45: R\$ 59,22 60: R\$ 60,40



SOMBRINHA 8V LONGA CB CURV MAD AUT AZUL  
Código: Fábrica: Unidade:  
**46902** MIZPA UN/1  
F1 F4

UN: R\$ 55,76 AV: R\$ 55,76 15: R\$ 56,92  
30: R\$ 58,06 45: R\$ 59,22 60: R\$ 60,40



SOMBRINHA 8V LONGA CB CURV MAD AUT ROSA  
Código: Fábrica: Unidade:  
**46905** MIZPA UN/1  
F1 F4

UN: R\$ 55,76 AV: R\$ 55,76 15: R\$ 56,92  
30: R\$ 58,06 45: R\$ 59,22 60: R\$ 60,40



SOMBRINHA 8V LONGA CB CURV MAD AUT VERD  
Código: Fábrica: Unidade:  
**46903** MIZPA UN/1  
F1 F4

UN: R\$ 55,76 AV: R\$ 55,76 15: R\$ 56,92  
30: R\$ 58,06 45: R\$ 59,22 60: R\$ 60,40



SOMBRINHA 8V LONGA CB CURV MAD AUT VERM  
Código: Fábrica: Unidade:  
**46904** MIZPA UN/1  
F1 F4

UN: R\$ 24,41 AV: R\$ 24,41 15: R\$ 24,91  
30: R\$ 25,41 45: R\$ 25,92 60: R\$ 26,44



SOMBRINHA 8V LONGA TRANSP AUT 50008  
Código: Fábrica: Unidade:  
**50133** CASITA UN/1  
F1 F4

UN: R\$ 41,08 AV: R\$ 41,08 15: R\$ 41,93  
30: R\$ 42,77 45: R\$ 43,63 60: R\$ 44,50



SOMBRINHA 8V MED NEON CB CURVO AUT  
Código: Fábrica: Unidade:  
**41069** M.BRILHANTE UN/1  
F1 F4

UN: R\$ 27,72 AV: R\$ 27,72 15: R\$ 28,30  
30: R\$ 28,87 45: R\$ 29,45 60: R\$ 30,03



SOMBRINHA 8V MINI DUPLA FACE MAN 3154H  
Código: Fábrica: Unidade:  
**45863** HIMEB UN/1  
F1 F4

UN: R\$ 25,67 AV: R\$ 25,67 15: R\$ 26,20  
30: R\$ 26,73 45: R\$ 27,26 60: R\$ 27,81



SOMBRINHA 8V MINI DUPLA FACE MAN 3954Y  
Código: Fábrica: Unidade:  
**45864** LURS UN/1  
F1 F4

UN: R\$ 25,67 AV: R\$ 25,67 15: R\$ 26,20  
30: R\$ 26,73 45: R\$ 27,26 60: R\$ 27,81



SOMBRINHA 8V MINI MAN C/BOLSA 13265/565  
Código: Fábrica: Unidade:  
**23592** ELITE UN/1  
F1 F4

UN: R\$ 15,99 AV: R\$ 15,99 15: R\$ 15,99  
30: R\$ 15,99 45: R\$ 15,99 60: R\$ 15,99



SOMBRINHA 8V MINI MAN 3959

Código: **24537** Fábrica: RISOVI/HIMEB Unidade: UN/1 F1 F4

UN: R\$ 20,53 AV: R\$ 20,53 15: R\$ 20,96  
30: R\$ 21,38 45: R\$ 21,81 60: R\$ 22,24



SOMBRINHA 8V MINI MAN 908.8

Código: **14096** Fábrica: MIZPA Unidade: UN/1 F1 F4

UN: R\$ 20,53 AV: R\$ 20,53 15: R\$ 20,96  
30: R\$ 21,38 45: R\$ 21,81 60: R\$ 22,24



SOMBRINHA 8V MINI MAN 909.9

Código: **14088** Fábrica: MIZPA Unidade: UN/1 F1 F4

UN: R\$ 20,53 AV: R\$ 20,53 15: R\$ 20,96  
30: R\$ 21,38 45: R\$ 21,81 60: R\$ 22,24



SOMBRINHA 8V MINI MAN 916.6

Código: **14101** Fábrica: MIZPA Unidade: UN/1 F1 F4

UN: R\$ 20,53 AV: R\$ 20,53 15: R\$ 20,96  
30: R\$ 21,38 45: R\$ 21,81 60: R\$ 22,24



SOMBRINHA 8V MINI MAN 917.7

Código: **12057** Fábrica: MIZPA Unidade: UN/1 F1 F4

UN: R\$ 18,99 AV: R\$ 18,99 15: R\$ 18,99  
30: R\$ 18,99 45: R\$ 18,99 60: R\$ 18,99



SOMBRINHA 8V MINI XADREZ 3953

Código: **13329** Fábrica: HIMEB Unidade: UN/1 F1 F4

UN: R\$ 16,99 AV: R\$ 16,99 15: R\$ 16,99  
30: R\$ 16,99 45: R\$ 16,99 60: R\$ 16,99



SOMBRINHA INF MONSTER HIGH 14436

Código: **34554** Fábrica: BRIZI Unidade: UN/1 F1 F4

UN: R\$ 51,35 AV: R\$ 51,35 15: R\$ 52,42  
30: R\$ 53,47 45: R\$ 54,54 60: R\$ 55,63



SOMBRINHA 10V GIG 2 DOBRAS MAN 3789

Código: **34036** Fábrica: HIMEB Unidade: UN/1 F1 F4

UN: R\$ 34,99 AV: R\$ 34,99 15: R\$ 34,99  
30: R\$ 34,99 45: R\$ 34,99 60: R\$ 34,99



SOMBRINHA 10V GIG 3 DOBRAS MAN 3750S

Código: **45861** Fábrica: LURS Unidade: UN/1 F1 F4

UN: R\$ 41,08 AV: R\$ 41,08 15: R\$ 41,93  
30: R\$ 42,77 45: R\$ 43,63 60: R\$ 44,50



SOMBRINHA 10V GIG 3 DOBRAS MAN 3750X

Código: **34076** Fábrica: LURS Unidade: UN/1 F1 F4

UN: R\$ 26,19 AV: R\$ 26,19 15: R\$ 26,74  
30: R\$ 27,27 45: R\$ 27,82 60: R\$ 28,38



SOMBRINHA 16V LONGA CETIM AUT 5000S

Código: **24601** Fábrica: CASITA Unidade: UN/1 F1 F4

UN: R\$ 22,99 AV: R\$ 22,99 15: R\$ 22,99  
30: R\$ 22,99 45: R\$ 22,99 60: R\$ 22,99



SOMBRINHA 16V LONGA CETIM AUT 5088-16

Código: **12084** Fábrica: RISOVIT Unidade: UN/1 F1 F4

UN: R\$ 30,30 AV: R\$ 30,30 15: R\$ 30,93  
30: R\$ 31,55 45: R\$ 32,18 60: R\$ 32,83



SOMBRINHA 16V LONGA CETIM AUT 5088-16G

Código: **45747** Fábrica: HIMEB Unidade: UN/1 F1 F4

UN: R\$ 29,99 AV: R\$ 29,99 15: R\$ 29,99  
30: R\$ 29,99 45: R\$ 29,99 60: R\$ 29,99



SOMBRINHA 16V LONGA FORRO DUPLO 1816

Código: **28825** Fábrica: RISOVIT Unidade: UN/1 F1 F4

UN: R\$ 15,99 AV: R\$ 15,99 15: R\$ 15,99  
30: R\$ 15,99 45: R\$ 15,99 60: R\$ 15,99



SOMBRINHA 7V MINI C/CAPA 50014

Código: **14750** Fábrica: CASITA Unidade: UN/1 F1 F4

UN: R\$ 19,19 AV: R\$ 19,19 15: R\$ 19,59  
30: R\$ 19,98 45: R\$ 20,38 60: R\$ 20,79



SOMBRINHA 8V MINI ESTAMP MAN 1290

Código: **14089** Fábrica: ELITE Unidade: UN/1 F1 F4

UN: R\$ 17,45 AV: R\$ 17,45 15: R\$ 17,82  
30: R\$ 18,17 45: R\$ 18,54 60: R\$ 18,91



SOQUETE 3 MTS C/RABICHO PRETO CTL 32150

Código: F1 F4  
Fábrica: LIDER PLUS  
Unidade: UN/1

**31023**

UN: R\$ 22,59 AV: R\$ 22,59 15: R\$ 23,06  
30: R\$ 23,52 45: R\$ 23,99 60: R\$ 24,47



SOQUETE 5 MTS C/RABICHO PRETO CTL 32151

Código: F1 F4  
Fábrica: LIDER PLUS  
Unidade: UN/1

**31024**

UN: R\$ 4,41 AV: R\$ 44,07 15: R\$ 44,98  
30: R\$ 45,88 45: R\$ 46,80 60: R\$ 47,74



SOQUETE C/RABICHO EF10 10X1

Código: PT/10  
Fábrica: GIROFLASH  
Unidade: F1 F4

**39385**

UN: R\$ 34,91 AV: R\$ 34,91 15: R\$ 35,64  
30: R\$ 36,35 45: R\$ 37,08 60: R\$ 37,82



SOQUETE 10 MTS C/RABICHO PRETO CTL 32152

Código: F1 F4  
Fábrica: LIDER PLUS  
Unidade: UN/1

**31025**

UN: R\$ 102,71 AV: R\$ 102,71 15: R\$ 104,85  
30: R\$ 106,95 45: R\$ 109,09 60: R\$ 111,27



SUPORTE CELULAR VEIC CLIPE DE MOLA 30

Código: F1 F4  
Fábrica: DOTCELL  
Unidade: UN/1

**50296**

UN: R\$ 41,08 AV: R\$ 41,08 15: R\$ 41,93  
30: R\$ 42,77 45: R\$ 43,63 60: R\$ 44,50



SUPORTE GUIDAO MOTO C/CAPA CEL 8678

Código: F1 F4  
Fábrica: INOVA  
Unidade: UN/1

**35343**

UN: R\$ 36,98 AV: R\$ 36,98 15: R\$ 37,75  
30: R\$ 38,50 45: R\$ 39,27 60: R\$ 40,06



SUPORTE MOVEL P/CELULAR ZM-16

Código: F1 F4  
Fábrica: INOVA  
Unidade: UN/1

**38235**

UN: R\$ 10,48 AV: R\$ 10,48 15: R\$ 10,70  
30: R\$ 10,91 45: R\$ 11,13 60: R\$ 11,35



SUPORTE MOVEL P/CELULAR 7056

Código: F1 F4  
Fábrica: BLESSED  
Unidade: UN/1

**40808**

UN: R\$ 0,62 AV: R\$ 61,62 15: R\$ 62,91  
30: R\$ 64,16 45: R\$ 65,45 60: R\$ 66,76



SUPORTE PEGA BALAO 33CM CRISTAL 100X1

Código: F1 F4  
Fábrica: KLFESTAS  
Unidade: PT/100

**48599**

UN: R\$ 6,21 AV: R\$ 6,21 15: R\$ 6,34  
30: R\$ 6,47 45: R\$ 6,60 60: R\$ 6,73



SUPORTE PLAST C/VENTOSA P/CELULAR 1083

Código: F1 F4  
Fábrica: AGUIABRANCA  
Unidade: UN/1

**38223**

UN: R\$ 13,35 AV: R\$ 13,35 15: R\$ 13,63  
30: R\$ 13,90 45: R\$ 14,18 60: R\$ 14,47



SUPORTE PLAST DE BICICLETA P/CELULAR 771

Código: F1 F4  
Fábrica: AGUIABRANCA  
Unidade: UN/1

**36447**

UN: R\$ 0,31 AV: R\$ 30,81 15: R\$ 31,45  
30: R\$ 32,08 45: R\$ 32,72 60: R\$ 33,37



TAMPA PLAST 28MM GARRAFA PET AZUL 100X1

Código: F1 F4  
Fábrica: ARBRA  
Unidade: PT/100

**50850**

UN: R\$ 0,31 AV: R\$ 30,81 15: R\$ 31,45  
30: R\$ 32,08 45: R\$ 32,72 60: R\$ 33,37



TAMPA PLAST 28MM GARRAFA PET BRANC 100X1

Código: F1 F4  
Fábrica: ARBRA  
Unidade: PT/100

**50847**

UN: R\$ 6,18 AV: R\$ 74,22 15: R\$ 75,76  
30: R\$ 77,28 45: R\$ 78,82 60: R\$ 80,40



TANGA AD COTTON 202 G LISA 12X1

Código: F1 F4  
Fábrica: LELE LULU  
Unidade: PT/12

**22014**

UN: R\$ 6,18 AV: R\$ 74,22 15: R\$ 75,76  
30: R\$ 77,28 45: R\$ 78,82 60: R\$ 80,40



TANGA AD COTTON 202 M 12X1

Código: F1 F4  
Fábrica: LELE LULU  
Unidade: PT/12

**22013**

UN: R\$ 6,18 AV: R\$ 74,22 15: R\$ 75,76  
30: R\$ 77,28 45: R\$ 78,82 60: R\$ 80,40



TANGA AD COTTON 202 P LISA 12X1

Código: F1 F4  
Fábrica: LELE LULU  
Unidade: PT/12

**22015**

UN: R\$ 8,55 AV: R\$ 102,62 15: R\$ 104,76  
30: R\$ 106,85 45: R\$ 108,99 60: R\$ 111,17



TANGA AD COTTON 210 G EXP EST 12X1  
Código: Fábrika: Unidade:  
**37334** LELE LULU PT/12  
F1 F4

UN: R\$ 8,55 AV: R\$ 102,62 15: R\$ 104,76  
30: R\$ 106,85 45: R\$ 108,99 60: R\$ 111,17



TANGA AD COTTON 210 P 12X1  
Código: Fábrika: Unidade:  
**29545** LELE LULU PT/12  
F1 F4

UN: R\$ 8,55 AV: R\$ 102,62 15: R\$ 104,76  
30: R\$ 106,85 45: R\$ 108,99 60: R\$ 111,17



TANGA AD COTTON 210 GG EXP EST 12X1  
Código: Fábrika: Unidade:  
**37335** LELE LULU PT/12  
F1 F4

UN: R\$ 8,55 AV: R\$ 102,62 15: R\$ 104,76  
30: R\$ 106,85 45: R\$ 108,99 60: R\$ 111,17



TANGA AD COTTON 210.1 GG EXP LISO 12X1  
Código: Fábrika: Unidade:  
**29548** LELE LULU PT/12  
F1 F4

UN: R\$ 8,55 AV: R\$ 102,62 15: R\$ 104,76  
30: R\$ 106,85 45: R\$ 108,99 60: R\$ 111,17



TANGA AD COTTON 210.1 M EXP LISO 12X1  
Código: Fábrika: Unidade:  
**29546** LELE LULU PT/12  
F1 F4

UN: R\$ 8,56 AV: R\$ 102,71 15: R\$ 104,85  
30: R\$ 106,95 45: R\$ 109,09 60: R\$ 111,27



TANGA AD COTTON 210.1 P EXP LISO 12X1  
Código: Fábrika: Unidade:  
**40739** LELE LULU PT/12  
F1 F4

UN: R\$ 6,09 AV: R\$ 73,03 15: R\$ 74,56  
30: R\$ 76,05 45: R\$ 77,57 60: R\$ 79,12



TANGA AD MICROFIBRA 210 G LISA 12X1  
Código: Fábrika: Unidade:  
**36321** LELE LULU PT/12  
F1 F4

UN: R\$ 6,09 AV: R\$ 73,03 15: R\$ 74,56  
30: R\$ 76,05 45: R\$ 77,57 60: R\$ 79,12



TANGA AD MICROFIBRA 210 M LISA 12X1  
Código: Fábrika: Unidade:  
**36320** LELE LULU PT/12  
F1 F4

UN: R\$ 6,09 AV: R\$ 73,03 15: R\$ 74,56  
30: R\$ 76,05 45: R\$ 77,57 60: R\$ 79,12



TANGA AD MICROFIBRA 210 P LISA 12X1  
Código: Fábrika: Unidade:  
**38494** LELE LULU PT/12  
F1 F4

UN: R\$ 6,09 AV: R\$ 73,03 15: R\$ 74,56  
30: R\$ 76,05 45: R\$ 77,57 60: R\$ 79,12



TANGA AD MICROFIBRA 210 G EST 12X1  
Código: Fábrika: Unidade:  
**32685** LELE LULU PT/12  
F1 F4

UN: R\$ 6,09 AV: R\$ 73,03 15: R\$ 74,56  
30: R\$ 76,05 45: R\$ 77,57 60: R\$ 79,12



TANGA AD MICROFIBRA 210 GG EST 12X1  
Código: Fábrika: Unidade:  
**32686** LELE LULU PT/12  
F1 F4

UN: R\$ 6,09 AV: R\$ 73,03 15: R\$ 74,56  
30: R\$ 76,05 45: R\$ 77,57 60: R\$ 79,12



TANGA AD MICROFIBRA 210 M EST 12X1  
Código: Fábrika: Unidade:  
**32684** LELE LULU PT/12  
F1 F4

UN: R\$ 6,09 AV: R\$ 73,03 15: R\$ 74,56  
30: R\$ 76,05 45: R\$ 77,57 60: R\$ 79,12



TANGA AD MICROFIBRA 210 P EST 12X1  
Código: Fábrika: Unidade:  
**32683** LELE LULU PT/12  
F1 F4

UN: R\$ 6,89 AV: R\$ 82,69 15: R\$ 84,41  
30: R\$ 86,10 45: R\$ 87,82 60: R\$ 89,58



TANGAO AD COTTON 203 G ESTAMP 12X1  
Código: Fábrika: Unidade:  
**32681** LELE LULU PT/12  
F1 F4

UN: R\$ 6,89 AV: R\$ 82,69 15: R\$ 84,41  
30: R\$ 86,10 45: R\$ 87,82 60: R\$ 89,58



TANGAO AD COTTON 203 GG 12X1  
Código: Fábrika: Unidade:  
**32682** LELE LULU PT/12  
F1 F4

UN: R\$ 6,89 AV: R\$ 82,69 15: R\$ 84,41  
30: R\$ 86,10 45: R\$ 87,82 60: R\$ 89,58



TANGAO AD COTTON 203 M ESTAMP 12X1  
Código: Fábrika: Unidade:  
**32680** LELE LULU PT/12  
F1 F4

UN: R\$ 10,27 AV: R\$ 123,26 15: R\$ 125,83  
30: R\$ 128,35 45: R\$ 130,92 60: R\$ 133,53



TANGAO AD COTTON 211 GG EXP ESTAM 12X1  
Código: Fábrika: Unidade:  
**32679** LELE LULU PT/12  
F1 F4

UN: R\$ 10,27 AV: R\$ 123,26 15: R\$ 125,83  
30: R\$ 128,35 45: R\$ 130,92 60: R\$ 133,53



TANGAO AD COTTON 211.1 G EXP LISO 12X1  
Código: Fábrika: Unidade:  
**37331** LELE LULU PT/12  
F1 F4

UN: R\$ 10,27 AV: R\$ 123,26 15: R\$ 125,83  
30: R\$ 128,35 45: R\$ 130,92 60: R\$ 133,53



TANGAO AD COTTON 211.1 GG EXP LISO 12X1  
Código: Fábrika: Unidade:  
**37330** LELE LULU PT/12  
F1 F4

UN: R\$ 10,27 AV: R\$ 123,26 15: R\$ 125,83  
30: R\$ 128,35 45: R\$ 130,92 60: R\$ 133,53



TANGAO AD COTTON 211.1 M EXP LISO 12X1  
Código: Fábrika: Unidade:  
**37332** LELE LULU PT/12  
F1 F4

UN: R\$ 10,27 AV: R\$ 123,26 15: R\$ 125,83  
30: R\$ 128,35 45: R\$ 130,92 60: R\$ 133,53



TANGAO AD COTTON 211.2 G ESTAMP 12X1  
Código: Fábrika: Unidade:  
**32678** LELE LULU PT/12  
F1 F4

UN: R\$ 10,27 AV: R\$ 123,26 15: R\$ 125,83  
30: R\$ 128,35 45: R\$ 130,92 60: R\$ 133,53



TANGAO AD COTTON 211.2 GG ESTAMP 12X1  
Código: Fábrika: Unidade:  
**39704** LELE LULU PT/12  
F1 F4

UN: R\$ 10,27 AV: R\$ 123,26 15: R\$ 125,83  
30: R\$ 128,35 45: R\$ 130,92 60: R\$ 133,53



TANGAO AD COTTON 211.2 M ESTAMP 12X1  
Código: Fábrika: Unidade:  
**39702** LELE LULU PT/12  
F1 F4

UN: R\$ 15,90 AV: R\$ 15,90 15: R\$ 16,24  
30: R\$ 16,56 45: R\$ 16,89 60: R\$ 17,23

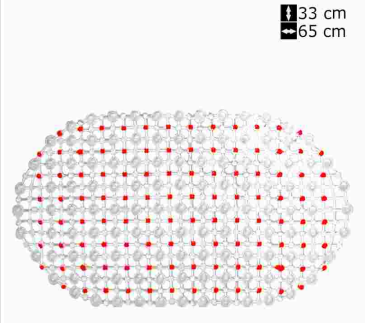

TAPETE ANTID C/VENTOSA 65CM 1111  
Código: Fábrika: Unidade:  
**44516** NICOBEM UN/1  
F1 F4

UN: R\$ 13,34 AV: R\$ 13,34 15: R\$ 13,62  
30: R\$ 13,89 45: R\$ 14,17 60: R\$ 14,46

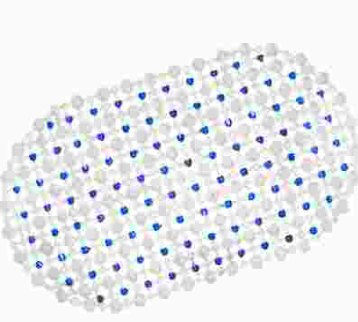

TAPETE ANTID MASSAGEADOR 34X64CM 0080  
Código: Fábrika: Unidade:  
**25340** TALBERG UN/1  
F1 F4

UN: R\$ 64,25 AV: R\$ 64,25 15: R\$ 65,59  
30: R\$ 66,90 45: R\$ 68,24 60: R\$ 69,60



TAPETE ANTID 70CM 582  
Código: Fábrika: Unidade:  
**46435** HOME UN/1  
F1 F4

UN: R\$ 35,95 AV: R\$ 35,95 15: R\$ 36,70  
30: R\$ 37,44 45: R\$ 38,18 60: R\$ 38,95

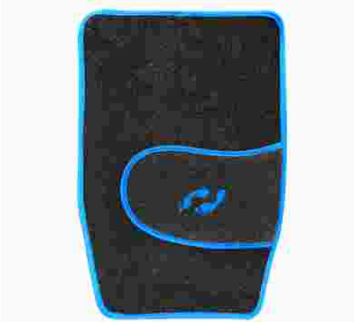

TAPETE CARPETE AUTOMOTIVO C/4 PCS 57722  
Código: Fábrika: Unidade:  
**25449** YING FA UN/1  
F1 F4

UN: R\$ 0,31 AV: R\$ 18,49 15: R\$ 18,87  
30: R\$ 19,25 45: R\$ 19,64 60: R\$ 20,03



TATUAGEM SORTIDA 20X3 MY19-6  
Código: Fábrika: Unidade:  
**27808** MB YOUSSEF PT/60  
F1 F4

UN: R\$ 71,89 AV: R\$ 71,89 15: R\$ 73,39  
30: R\$ 74,86 45: R\$ 76,36 60: R\$ 77,88



TELEFONE C/FIO KXT102  
Código: Fábrika: Unidade:  
**14622** HAI BRASIL UN/1  
F1 F4

UN: R\$ 13,34 AV: R\$ 13,34 15: R\$ 13,62  
30: R\$ 13,89 45: R\$ 14,17 60: R\$ 14,46



TESOURA ACO INOX CABO PP EMB GRANDE  
Código: Fábrika: Unidade:  
**14676** LYKE UN/1  
F1 F4

UN: R\$ 17,05 AV: R\$ 17,05 15: R\$ 17,41  
30: R\$ 17,75 45: R\$ 18,11 60: R\$ 18,47



TESOURA INOX BARBEIRO 3,8" 163-5  
Código: Fábrika: Unidade:  
**14439** MUNDIAL UN/1  
F1 F4

UN: R\$ 28,21 AV: R\$ 28,21 15: R\$ 28,79  
30: R\$ 29,37 45: R\$ 29,96 60: R\$ 30,56

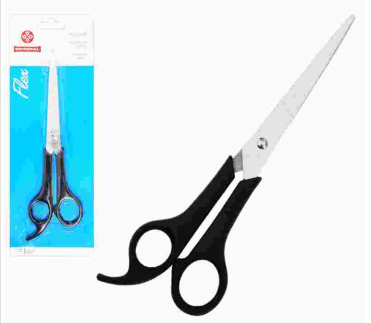

TESOURA INOX BARBEIRO 7,5" 163-7  
Código: Fábrika: Unidade:  
**14440** MUNDIAL UN/1  
F1 F4

UN: R\$ 10,79 AV: R\$ 10,79 15: R\$ 11,01  
30: R\$ 11,23 45: R\$ 11,46 60: R\$ 11,68



TESOURA INOX CB EMB 25CM 10" CTL 707  
Código: Fábrica: Unidade:  
**49612** WINMAX UN/1  
F1 F4

UN: R\$ 4,71 AV: R\$ 4,71 15: R\$ 4,81  
30: R\$ 4,91 45: R\$ 5,01 60: R\$ 5,11



TESOURA INOX MULTIUSO 19 CM 7,5" 2085  
Código: Fábrica: Unidade:  
**50140** GP6 CR/1  
F1 F4

UN: R\$ 5,64 AV: R\$ 5,64 15: R\$ 5,76  
30: R\$ 5,87 45: R\$ 5,99 60: R\$ 6,11



TESOURA INOX MULTIUSO 20 CM ALFA 671  
Código: Fábrica: Unidade:  
**48679** PLANETA UN/1  
F1 F4

UN: R\$ 5,64 AV: R\$ 5,64 15: R\$ 5,76  
30: R\$ 5,87 45: R\$ 5,99 60: R\$ 6,11



TESOURA INOX MULTIUSO 20 CM 8" 2087  
Código: Fábrica: Unidade:  
**50139** GP6 CR/1  
F1 F4

UN: R\$ 4,92 AV: R\$ 4,92 15: R\$ 5,02  
30: R\$ 5,12 45: R\$ 5,23 60: R\$ 5,33



TESOURA INOX MULTIUSO 5 1/2 ALFA 669  
Código: Fábrica: Unidade:  
**47991** PLANETA UN/1  
F1 F4

UN: R\$ 7,18 AV: R\$ 7,18 15: R\$ 7,33  
30: R\$ 7,48 45: R\$ 7,63 60: R\$ 7,78



TESOURA INOX P/COSTURA 24CM 9,5" 4224  
Código: Fábrica: Unidade:  
**41083** IDEA UN/1  
F1 F4

UN: R\$ 51,35 AV: R\$ 51,35 15: R\$ 52,42  
30: R\$ 53,47 45: R\$ 54,54 60: R\$ 55,63



TESOURA INOX P/COSTURA 8" 2534  
Código: Fábrica: Unidade:  
**43396** SEKICH UN/1  
F1 F4

UN: R\$ 8,21 AV: R\$ 8,21 15: R\$ 8,38  
30: R\$ 8,55 45: R\$ 8,72 60: R\$ 8,89



TESOURA INOX P/UNHAS CURVA CTL 1235  
Código: Fábrica: Unidade:  
**37870** SEKICH CR/1  
F1 F4

UN: R\$ 8,21 AV: R\$ 8,21 15: R\$ 8,38  
30: R\$ 8,55 45: R\$ 8,72 60: R\$ 8,89



TESOURA INOX P/UNHAS RETA CTL 1234  
Código: Fábrica: Unidade:  
**8896** SEKICH CR/1  
F1 F4

UN: R\$ 4,92 AV: R\$ 4,92 15: R\$ 5,02  
30: R\$ 5,12 45: R\$ 5,23 60: R\$ 5,33



TESOURA INOX USO GERAL 14 CM CTL HA55  
Código: Fábrica: Unidade:  
**30637** HAI BRASIL UN/1  
F1 F4

UN: R\$ 4,99 AV: R\$ 4,99 15: R\$ 4,99  
30: R\$ 4,99 45: R\$ 4,99 60: R\$ 4,99



TESOURA INOX USO GERAL 17 CM 6,5" CTL  
Código: Fábrica: Unidade:  
**39246** ALIANCA UN/1  
F1 F4

UN: R\$ 6,67 AV: R\$ 6,67 15: R\$ 6,81  
30: R\$ 6,94 45: R\$ 7,08 60: R\$ 7,22



TESOURA INOX USO GERAL 19 CM CTL HA75  
Código: Fábrica: Unidade:  
**30636** HAI BRASIL UN/1  
F1 F4

UN: R\$ 9,86 AV: R\$ 9,86 15: R\$ 10,07  
30: R\$ 10,27 45: R\$ 10,47 60: R\$ 10,68



TESOURA INOX USO GERAL 21 CM CTL 2102  
Código: Fábrica: Unidade:  
**29923** BRW UN/1  
F1 F4

UN: R\$ 14,79 AV: R\$ 14,79 15: R\$ 15,10  
30: R\$ 15,40 45: R\$ 15,71 60: R\$ 16,02



TESOURA INOX 13CM ZIG ZAG CTL 22542  
Código: Fábrica: Unidade:  
**48404** ACRILEX CR/1  
F1 F4

UN: R\$ 4,00 AV: R\$ 4,00 15: R\$ 4,08  
30: R\$ 4,16 45: R\$ 4,24 60: R\$ 4,33



TESOURA INOX 13CM 5" CTL 147-23  
Código: Fábrica: Unidade:  
**44766** NICOBEM UN/1  
F1 F4

UN: R\$ 4,26 AV: R\$ 4,26 15: R\$ 4,35  
30: R\$ 4,44 45: R\$ 4,53 60: R\$ 4,62



TESOURA INOX 14 CM 5,5" CTL 147-40  
Código: Fábrica: Unidade:  
**44765** NICOBEM UN/1  
F1 F4

UN: R\$ 5,43 AV: R\$ 5,43 15: R\$ 5,55  
30: R\$ 5,66 45: R\$ 5,77 60: R\$ 5,89



TESOURA INOX 17CM 7" 7239  
Código: Fábrika: Unidade:  
**43584** IDEA CR/1  
F1 F4

UN: R\$ 8,81 AV: R\$ 8,81 15: R\$ 9,00  
30: R\$ 9,18 45: R\$ 9,36 60: R\$ 9,55



TESOURA MULTI-USO CB PRETO 17 CM 864  
Código: Fábrika: Unidade:  
**41905** LYKE UN/1  
F1 F4

UN: R\$ 66,76 AV: R\$ 66,76 15: R\$ 68,15  
30: R\$ 69,51 45: R\$ 70,90 60: R\$ 72,32



TESOURA PICOTAR INOX 23CM ZIG ZAG 9"  
Código: Fábrika: Unidade:  
**45076** NYBC UN/1  
F1 F4

UN: R\$ 4,96 AV: R\$ 29,78 15: R\$ 30,40  
30: R\$ 31,01 45: R\$ 31,63 60: R\$ 32,26



TINTOL 45 GRS AMARELO CANARIO 2 6X1  
Código: Fábrika: Unidade:  
**12785** TUPY PT/6  
F1 F4

UN: R\$ 4,96 AV: R\$ 29,78 15: R\$ 30,40  
30: R\$ 31,01 45: R\$ 31,63 60: R\$ 32,26



TINTOL 45 GRS AZUL INDIGO 22 6X1  
Código: Fábrika: Unidade:  
**12777** TUPY PT/6  
F1 F4

UN: R\$ 4,96 AV: R\$ 29,78 15: R\$ 30,40  
30: R\$ 31,01 45: R\$ 31,63 60: R\$ 32,26



TINTOL 45 GRS AZUL MARINHO 23 6X1  
Código: Fábrika: Unidade:  
**12776** TUPY PT/6  
F1 F4

UN: R\$ 4,62 AV: R\$ 27,70 15: R\$ 28,28  
30: R\$ 28,85 45: R\$ 29,42 60: R\$ 30,01



TINTOL 45 GRS AZUL TURQUESA 13 6X1  
Código: Fábrika: Unidade:  
**39340** GUARANY PT/6  
F1 F4

UN: R\$ 4,96 AV: R\$ 29,78 15: R\$ 30,40  
30: R\$ 31,01 45: R\$ 31,63 60: R\$ 32,26



TINTOL 45 GRS AZUL TURQUESA 21 6X1  
Código: Fábrika: Unidade:  
**12778** TUPY PT/6  
F1 F4

UN: R\$ 4,62 AV: R\$ 27,70 15: R\$ 28,28  
30: R\$ 28,85 45: R\$ 29,42 60: R\$ 30,01



TINTOL 45 GRS AZUL 17 6X1  
Código: Fábrika: Unidade:  
**39339** GUARANY PT/6  
F1 F4

UN: R\$ 4,96 AV: R\$ 29,78 15: R\$ 30,40  
30: R\$ 31,01 45: R\$ 31,63 60: R\$ 32,26



TINTOL 45 GRS BEGE 30 6X1  
Código: Fábrika: Unidade:  
**12773** TUPY PT/6  
F1 F4

UN: R\$ 4,96 AV: R\$ 29,78 15: R\$ 30,40  
30: R\$ 31,01 45: R\$ 31,63 60: R\$ 32,26



TINTOL 45 GRS BORDO 16 6X1  
Código: Fábrika: Unidade:  
**12780** TUPY PT/6  
F1 F4

UN: R\$ 4,96 AV: R\$ 29,78 15: R\$ 30,40  
30: R\$ 31,01 45: R\$ 31,63 60: R\$ 32,26



TINTOL 45 GRS CINZA 34 6X1  
Código: Fábrika: Unidade:  
**12771** TUPY PT/6  
F1 F4

UN: R\$ 4,96 AV: R\$ 29,78 15: R\$ 30,40  
30: R\$ 31,01 45: R\$ 31,63 60: R\$ 32,26



TINTOL 45 GRS LARANJA CALIFORNIA 06 6X1  
Código: Fábrika: Unidade:  
**20568** TUPY PT/6  
F1 F4

UN: R\$ 4,96 AV: R\$ 29,78 15: R\$ 30,40  
30: R\$ 31,01 45: R\$ 31,63 60: R\$ 32,26



TINTOL 45 GRS LILAS 18 6X1  
Código: Fábrika: Unidade:  
**20564** TUPY PT/6  
F1 F4

UN: R\$ 4,62 AV: R\$ 27,70 15: R\$ 28,28  
30: R\$ 28,85 45: R\$ 29,42 60: R\$ 30,01



TINTOL 45 GRS MARROM 27 6X1  
Código: Fábrika: Unidade:  
**39341** GUARANY PT/6  
F1 F4

UN: R\$ 4,96 AV: R\$ 29,78 15: R\$ 30,40  
30: R\$ 31,01 45: R\$ 31,63 60: R\$ 32,26



TINTOL 45 GRS MARROM 32 6X1  
Código: Fábrika: Unidade:  
**12772** TUPY PT/6  
F1 F4

UN: R\$ 4,96 AV: R\$ 29,78 15: R\$ 30,40  
30: R\$ 31,01 45: R\$ 31,63 60: R\$ 32,26



TINTOL 45 GRS PINK 13 6X1

Código: Fábrika: Unidade:  
**12782** TUPY PT/6  
F1 F4

UN: R\$ 4,96 AV: R\$ 29,78 15: R\$ 30,40  
30: R\$ 31,01 45: R\$ 31,63 60: R\$ 32,26



TINTOL 45 GRS PRETO 36 6X1

Código: Fábrika: Unidade:  
**12319** TUPY PT/6  
F1 F4

UN: R\$ 4,96 AV: R\$ 29,78 15: R\$ 30,40  
30: R\$ 31,01 45: R\$ 31,63 60: R\$ 32,26



TINTOL 45 GRS ROSA 9 6X1

Código: Fábrika: Unidade:  
**12783** TUPY PT/6  
F1 F4

UN: R\$ 4,96 AV: R\$ 29,78 15: R\$ 30,40  
30: R\$ 31,01 45: R\$ 31,63 60: R\$ 32,26



TINTOL 45 GRS ROXO 19 6X1

Código: Fábrika: Unidade:  
**20005** TUPY PT/6  
F1 F4

UN: R\$ 513,59 AV: R\$ 513,59 15: R\$ 524,29  
30: R\$ 534,78 45: R\$ 545,47 60: R\$ 556,38

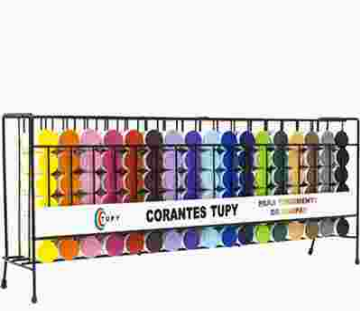

TINTOL 45 GRS SORT C/EXPOSITOR 102X1

Código: Fábrika: Unidade:  
**31368** TUPY EX/1  
F1 F4

UN: R\$ 4,96 AV: R\$ 29,78 15: R\$ 30,40  
30: R\$ 31,01 45: R\$ 31,63 60: R\$ 32,26



TINTOL 45 GRS VERDE PRIMAVERA 26 6X1

Código: Fábrika: Unidade:  
**20566** TUPY PT/6  
F1 F4

UN: R\$ 4,96 AV: R\$ 29,78 15: R\$ 30,40  
30: R\$ 31,01 45: R\$ 31,63 60: R\$ 32,26



TINTOL 45 GRS VERDE 28 6X1

Código: Fábrika: Unidade:  
**12774** TUPY PT/6  
F1 F4

UN: R\$ 4,96 AV: R\$ 29,78 15: R\$ 30,40  
30: R\$ 31,01 45: R\$ 31,63 60: R\$ 32,26



TINTOL 45 GRS VERMELHO 15 6X1

Código: Fábrika: Unidade:  
**12781** TUPY PT/6  
F1 F4

UN: R\$ 1,65 AV: R\$ 19,85 15: R\$ 20,26  
30: R\$ 20,66 45: R\$ 21,08 60: R\$ 21,50



TIRA CHINELO SLIM 25/26 SORT 12X1

Código: Fábrika: Unidade:  
**27529** BRASILEIRINH DZ/12  
F1 F4

UN: R\$ 1,65 AV: R\$ 16,54 15: R\$ 16,88  
30: R\$ 17,22 45: R\$ 17,56 60: R\$ 17,92



TIRA CHINELO SLIM 29/30 SORT 10X1

Código: Fábrika: Unidade:  
**31348** BRASILEIRINH PT/10  
F1 F4

UN: R\$ 1,65 AV: R\$ 16,54 15: R\$ 16,88  
30: R\$ 17,22 45: R\$ 17,56 60: R\$ 17,92

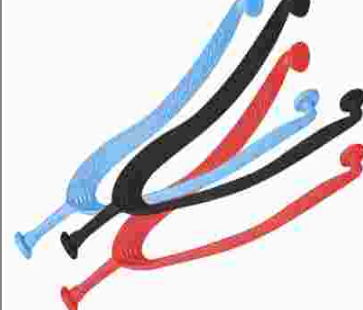

TIRA CHINELO SLIM 31/32 SORT 10X1

Código: Fábrika: Unidade:  
**31846** BRASILEIRINH PT/10  
F1 F4

UN: R\$ 1,65 AV: R\$ 16,54 15: R\$ 16,88  
30: R\$ 17,22 45: R\$ 17,56 60: R\$ 17,92



TIRA CHINELO SLIM 33/34 PRETO 10X1

Código: Fábrika: Unidade:  
**39821** BRASILEIRINH PT/10  
F1 F4

UN: R\$ 1,65 AV: R\$ 16,54 15: R\$ 16,88  
30: R\$ 17,22 45: R\$ 17,56 60: R\$ 17,92



TIRA CHINELO SLIM 33/34 SORT 10X1

Código: Fábrika: Unidade:  
**28158** BRASILEIRINH PT/10  
F1 F4

UN: R\$ 1,65 AV: R\$ 16,54 15: R\$ 16,88  
30: R\$ 17,22 45: R\$ 17,56 60: R\$ 17,92



TIRA CHINELO SLIM 35/36 DOURADO 10X1

Código: Fábrika: Unidade:  
**25197** BRASILEIRINH PT/10  
F1 F4

UN: R\$ 1,65 AV: R\$ 16,54 15: R\$ 16,88  
30: R\$ 17,22 45: R\$ 17,56 60: R\$ 17,92



TIRA CHINELO SLIM 35/36 PRETO 10X1

Código: Fábrika: Unidade:  
**25167** BRASILEIRINH PT/10  
F1 F4

UN: R\$ 1,65 AV: R\$ 19,85 15: R\$ 20,26  
30: R\$ 20,66 45: R\$ 21,08 60: R\$ 21,50



TIRA CHINELO TRAD 25/26 LILAS 12X1

Código: Fábrika: Unidade:  
**27485** BRASILEIRINH DZ/12  
F1 F4

UN: R\$ 1,65 AV: R\$ 16,54 15: R\$ 16,88  
30: R\$ 17,22 45: R\$ 17,56 60: R\$ 17,92

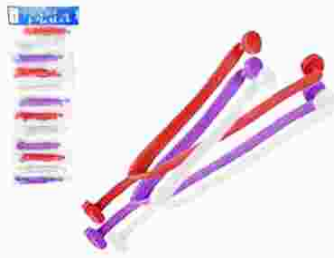

TIRA CHINELO TRAD 25/26 SORT 10X1

Código: **31400** Fábrica: **BRASILEIRINH** Unidade: **PT/10 F1 F4**

UN: R\$ 1,98 AV: R\$ 19,85 15: R\$ 20,26  
30: R\$ 20,66 45: R\$ 21,08 60: R\$ 21,50



TIRA CHINELO TRAD 27/28 SORT 10X1

Código: **27490** Fábrica: **BRASILEIRINH** Unidade: **PT/10 F1 F4**

UN: R\$ 1,65 AV: R\$ 16,54 15: R\$ 16,88  
30: R\$ 17,22 45: R\$ 17,56 60: R\$ 17,92



TIRA CHINELO TRAD 29/30 SORT 10X1

Código: **28169** Fábrica: **BRASILEIRINH** Unidade: **PT/10 F1 F4**

UN: R\$ 1,65 AV: R\$ 16,54 15: R\$ 16,88  
30: R\$ 17,22 45: R\$ 17,56 60: R\$ 17,92



TIRA CHINELO TRAD 33/34 AZUL 10X1

Código: **24966** Fábrica: **BRASILEIRINH** Unidade: **PT/10 F1 F4**

UN: R\$ 1,65 AV: R\$ 16,54 15: R\$ 16,88  
30: R\$ 17,22 45: R\$ 17,56 60: R\$ 17,92



TIRA CHINELO TRAD 33/34 PRETO 10X1

Código: **25074** Fábrica: **BRASILEIRINH** Unidade: **PT/10 F1 F4**

UN: R\$ 1,65 AV: R\$ 16,54 15: R\$ 16,88  
30: R\$ 17,22 45: R\$ 17,56 60: R\$ 17,92

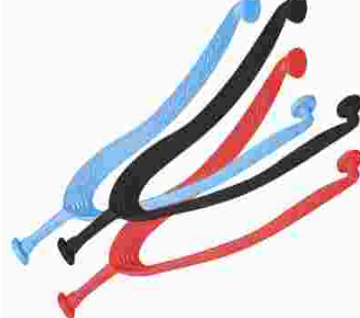

TIRA CHINELO TRAD 33/34 SORT 10X1

Código: **28171** Fábrica: **BRASILEIRINH** Unidade: **PT/10 F1 F4**

UN: R\$ 1,65 AV: R\$ 16,54 15: R\$ 16,88  
30: R\$ 17,22 45: R\$ 17,56 60: R\$ 17,92

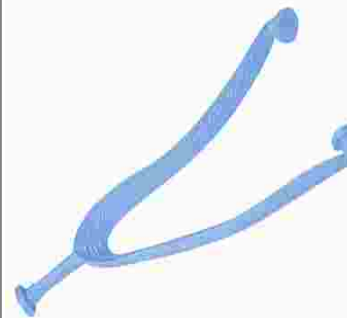

TIRA CHINELO TRAD 35/36 AZUL 10X1

Código: **25145** Fábrica: **BRASILEIRINH** Unidade: **PT/10 F1 F4**

UN: R\$ 2,13 AV: R\$ 21,31 15: R\$ 21,76  
30: R\$ 22,19 45: R\$ 22,64 60: R\$ 23,09



TIRA CHINELO TRAD 35/36 BRANCO 10X1

Código: **25102** Fábrica: **BRASILEIRINH** Unidade: **PT/10 F1 F4**

UN: R\$ 1,65 AV: R\$ 16,54 15: R\$ 16,88  
30: R\$ 17,22 45: R\$ 17,56 60: R\$ 17,92



TIRA CHINELO TRAD 35/36 PRETO 10X1

Código: **25025** Fábrica: **BRASILEIRINH** Unidade: **PT/10 F1 F4**

UN: R\$ 1,65 AV: R\$ 16,54 15: R\$ 16,88  
30: R\$ 17,22 45: R\$ 17,56 60: R\$ 17,92



TIRA CHINELO TRAD 37/38 PRETO 10X1

Código: **25026** Fábrica: **BRASILEIRINH** Unidade: **PT/10 F1 F4**

UN: R\$ 1,65 AV: R\$ 16,54 15: R\$ 16,88  
30: R\$ 17,22 45: R\$ 17,56 60: R\$ 17,92



TIRA CHINELO TRAD 39/40 AZUL 10X1

Código: **30670** Fábrica: **BRASILEIRINH** Unidade: **PT/10 F1 F4**

UN: R\$ 1,65 AV: R\$ 16,54 15: R\$ 16,88  
30: R\$ 17,22 45: R\$ 17,56 60: R\$ 17,92



TIRA CHINELO TRAD 39/40 PRETO 10X1

Código: **25084** Fábrica: **BRASILEIRINH** Unidade: **PT/10 F1 F4**

UN: R\$ 1,65 AV: R\$ 16,54 15: R\$ 16,88  
30: R\$ 17,22 45: R\$ 17,56 60: R\$ 17,92



TIRA CHINELO TRAD 41/42 AZUL 10X1

Código: **25058** Fábrica: **BRASILEIRINH** Unidade: **PT/10 F1 F4**

UN: R\$ 1,65 AV: R\$ 16,54 15: R\$ 16,88  
30: R\$ 17,22 45: R\$ 17,56 60: R\$ 17,92



TIRA CHINELO TRAD 41/42 PRETO 10X1

Código: **24988** Fábrica: **BRASILEIRINH** Unidade: **PT/10 F1 F4**

UN: R\$ 1,65 AV: R\$ 16,54 15: R\$ 16,88  
30: R\$ 17,22 45: R\$ 17,56 60: R\$ 17,92



TIRA CHINELO TRAD 43/44 AZUL 10X1

Código: **28092** Fábrica: **BRASILEIRINH** Unidade: **PT/10 F1 F4**

UN: R\$ 1,65 AV: R\$ 16,54 15: R\$ 16,88  
30: R\$ 17,22 45: R\$ 17,56 60: R\$ 17,92



TIRA CHINELO TRAD 43/44 PRETO 10X1

Código: **30640** Fábrica: **BRASILEIRINH** Unidade: **PT/10 F1 F4**

UN: R\$ 3,08 AV: R\$ 30,81 15: R\$ 31,45  
30: R\$ 32,08 45: R\$ 32,72 60: R\$ 33,37

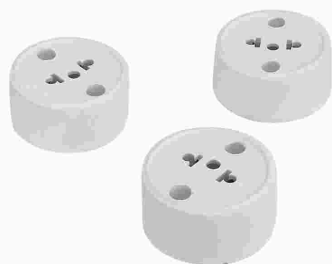

TOMADA EXTERNA 10X1

Código: Fábrika: Unidade:  
**36947** AMOF PT/10  
F1 F4

UN: R\$ 3,59 AV: R\$ 35,94 15: R\$ 36,69  
30: R\$ 37,42 45: R\$ 38,17 60: R\$ 38,94



TOMADA PINO FEMEA 10A 2PIN EF08 10X1

Código: Fábrika: Unidade:  
**36948** GIROFLASH PT/10  
F1 F4

UN: R\$ 7,58 AV: R\$ 75,76 15: R\$ 77,33  
30: R\$ 78,88 45: R\$ 80,46 60: R\$ 82,07



TOMADA QUADRUPLA GF12 10X1

Código: Fábrika: Unidade:  
**39386** GIROFLASH PT/10  
F1 F4

UN: R\$ 12,99 AV: R\$ 12,99 15: R\$ 12,99  
30: R\$ 12,99 45: R\$ 12,99 60: R\$ 12,99



TOUCA AD LISA PRETA MZ5100AQ

Código: Fábrika: Unidade:  
**44565** DOTAD UN/1  
F1 F4

UN: R\$ 9,99 AV: R\$ 9,99 15: R\$ 9,99  
30: R\$ 9,99 45: R\$ 9,99 60: R\$ 9,99



TOUCA AD LISA PRETA MZ5150

Código: Fábrika: Unidade:  
**44564** DOTAD UN/1  
F1 F4

UN: R\$ 17,98 AV: R\$ 17,98 15: R\$ 18,35  
30: R\$ 18,72 45: R\$ 19,09 60: R\$ 19,47



TOUCA AD SPORTS FORRO DUPLO MZ5107G-1

Código: Fábrika: Unidade:  
**44563** DOTAD UN/1  
F1 F4

UN: R\$ 14,99 AV: R\$ 14,99 15: R\$ 14,99  
30: R\$ 14,99 45: R\$ 14,99 60: R\$ 14,99



TOUCA INVERNO LISTRADO SPORTS MZ5109CD

Código: Fábrika: Unidade:  
**44461** DOTAD UN/1  
F1 F4

UN: R\$ 17,45 AV: R\$ 17,45 15: R\$ 17,82  
30: R\$ 18,17 45: R\$ 18,54 60: R\$ 18,91



TOUCA LA AD LISA C/DOBRA 2139

Código: Fábrika: Unidade:  
**14151** GLX UN/1  
F1 F4

UN: R\$ 23,62 AV: R\$ 23,62 15: R\$ 24,11  
30: R\$ 24,59 45: R\$ 25,08 60: R\$ 25,58



TOUCA LA AD LISTRADA GROSSA S/DOBRA 2170

Código: Fábrika: Unidade:  
**14150** GLX UN/1  
F1 F4

UN: R\$ 21,56 AV: R\$ 21,56 15: R\$ 22,01  
30: R\$ 22,45 45: R\$ 22,90 60: R\$ 23,36



TOUCA LA AD MOLETON SILKADA 2117

Código: Fábrika: Unidade:  
**42221** PITY UN/1  
F1 F4

UN: R\$ 15,99 AV: R\$ 15,99 15: R\$ 15,99  
30: R\$ 15,99 45: R\$ 15,99 60: R\$ 15,99



TOUCA LA AD S/DOBRA 2134M

Código: Fábrika: Unidade:  
**36824** GLX UN/1  
F1 F4

UN: R\$ 6,75 AV: R\$ 6,75 15: R\$ 6,75  
30: R\$ 6,75 45: R\$ 6,75 60: R\$ 6,75



TOUCA LA AD TRAD FEM (GORRO) 3195

Código: Fábrika: Unidade:  
**41819** GLX UN/1  
F1 F4

UN: R\$ 6,75 AV: R\$ 6,75 15: R\$ 6,75  
30: R\$ 6,75 45: R\$ 6,75 60: R\$ 6,75

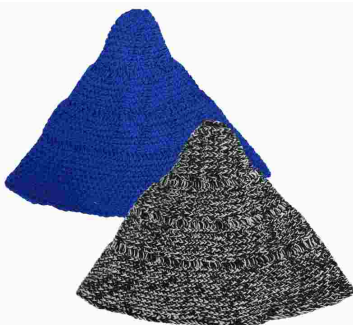

TOUCA LA AD TRAD FEM (GORRO) 3197

Código: Fábrika: Unidade:  
**41820** GLX UN/1  
F1 F4

UN: R\$ 24,64 AV: R\$ 24,64 15: R\$ 25,16  
30: R\$ 25,66 45: R\$ 26,17 60: R\$ 26,70



TOUCA LA INF F.DUPLO BICHIN C/OLHOS 109

Código: Fábrika: Unidade:  
**18059** LURS UN/1  
F1 F4

UN: R\$ 27,99 AV: R\$ 27,99 15: R\$ 27,99  
30: R\$ 27,99 45: R\$ 27,99 60: R\$ 27,99



TOUCA LA INF F.DUPLO C/POMPOM 0867

Código: Fábrika: Unidade:  
**17657** LURS UN/1  
F1 F4

UN: R\$ 10,27 AV: R\$ 10,27 15: R\$ 10,49  
30: R\$ 10,70 45: R\$ 10,91 60: R\$ 11,13



TOUCA LA INFANTIL 6106

Código: Fábrika: Unidade:  
**36829** GLX UN/1  
F1 F4

UN: R\$ 17,45 AV: R\$ 17,45 15: R\$ 17,82  
30: R\$ 18,17 45: R\$ 18,54 60: R\$ 18,91



TOUCA NINJA MOTOQUEIRO

Código: Fábrica: Unidade:  
**27124** DOTAD UN/1  
F1 F4

UN: R\$ 21,26 AV: R\$ 21,26 15: R\$ 21,71  
30: R\$ 22,14 45: R\$ 22,58 60: R\$ 23,03



TRAVA ANTI FURTO P/BIKE 5009

Código: Fábrica: Unidade:  
**40349** RED STAR UN/1  
F1 F4

UN: R\$ 44,16 AV: R\$ 44,16 15: R\$ 45,08  
30: R\$ 45,98 45: R\$ 46,90 60: R\$ 47,84



TUBO LATEX (GARROTE) 200 15 MTS

Código: Fábrica: Unidade:  
**825** UMUARAMA PT/1  
F1 F4

UN: R\$ 66,76 AV: R\$ 66,76 15: R\$ 68,15  
30: R\$ 69,51 45: R\$ 70,90 60: R\$ 72,32



TUBO LATEX (GARROTE) 201 15 MTS

Código: Fábrica: Unidade:  
**824** UMUARAMA PT/1  
F1 F4

UN: R\$ 87,30 AV: R\$ 87,30 15: R\$ 89,12  
30: R\$ 90,90 45: R\$ 92,72 60: R\$ 94,58



TUBO LATEX (GARROTE) 203 15 MTS

Código: Fábrica: Unidade:  
**369** UMUARAMA PT/1  
F1 F4

UN: R\$ 61,62 AV: R\$ 61,62 15: R\$ 62,91  
30: R\$ 64,16 45: R\$ 65,45 60: R\$ 66,76  
110 cm

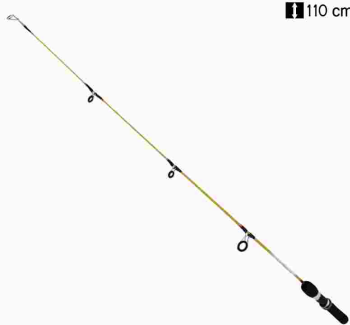

VARA PESCA 1,10 MTS

Código: Fábrica: Unidade:  
**4884** WMF UN/1  
F4

UN: R\$ 54,43 AV: R\$ 54,43 15: R\$ 55,57  
30: R\$ 56,68 45: R\$ 57,81 60: R\$ 58,97



VARA PESCA 1,20 MTS

Código: Fábrica: Unidade:  
**30024** TAUE UN/1  
F4

UN: R\$ 80,64 AV: R\$ 80,64 15: R\$ 82,32  
30: R\$ 83,96 45: R\$ 85,64 60: R\$ 87,35



VARA PESCA 1,60 M TAUE

Código: Fábrica: Unidade:  
**27772** TAUE UN/1  
F4

UN: R\$ 88,75 AV: R\$ 88,75 15: R\$ 90,60  
30: R\$ 92,41 45: R\$ 94,26 60: R\$ 96,14



VARA PESCA 1,65 MTS

Código: Fábrica: Unidade:  
**27098** SOL UN/1  
F4

UN: R\$ 0,37 AV: R\$ 1,83 15: R\$ 1,87  
30: R\$ 1,90 45: R\$ 1,94 60: R\$ 1,98



VEDANTE 1/2 PLAST (BUCHA TORNEIRA) 5X1

Código: Fábrica: Unidade:  
**49740** NOVA ERA PT/5  
F1 F4

UN: R\$ 0,37 AV: R\$ 1,83 15: R\$ 1,87  
30: R\$ 1,90 45: R\$ 1,94 60: R\$ 1,98



VEDANTE 3/4 PLAST (BUCHA TORNEIRA) 5X1

Código: Fábrica: Unidade:  
**49741** NOVA MARCA PT/5  
F1 F4

UN: R\$ 0,41 AV: R\$ 82,17 15: R\$ 83,88  
30: R\$ 85,56 45: R\$ 87,27 60: R\$ 89,01



VEDANTE 3/4 SILIC (BUCHA TORNEIRA) 200X1

Código: Fábrica: Unidade:  
**32894** UNO PLASTIC PT/200  
F1 F4

UN: R\$ 0,92 AV: R\$ 4,61 15: R\$ 4,71  
30: R\$ 4,80 45: R\$ 4,90 60: R\$ 5,00

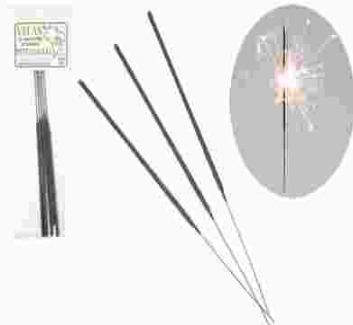

VELA ANIV MAGICA ESTRELA 5X1

Código: Fábrica: Unidade:  
**19366** BRASILEIRINH PT/5  
F1 F4

UN: R\$ 2,70 AV: R\$ 26,96 15: R\$ 27,53  
30: R\$ 28,08 45: R\$ 28,64 60: R\$ 29,21



VELA ANIV MED C/GLITER ? AZUL 10X1

Código: Fábrica: Unidade:  
**28026** BRASILEIRINH PT/10  
F1 F4

UN: R\$ 2,70 AV: R\$ 26,96 15: R\$ 27,53  
30: R\$ 28,08 45: R\$ 28,64 60: R\$ 29,21



VELA ANIV MED C/GLITER ? BCA 10X1

Código: Fábrica: Unidade:  
**28027** BRASILEIRINH PT/10  
F1 F4

UN: R\$ 2,70 AV: R\$ 26,96 15: R\$ 27,53  
30: R\$ 28,08 45: R\$ 28,64 60: R\$ 29,21



VELA ANIV MED C/GLITER ? ROSA 10X1

Código: Fábrica: Unidade:  
**28028** BRASILEIRINH PT/10  
F1 F4

UN: R\$ 2,43 AV: R\$ 400,60 15: R\$ 408,94  
30: R\$ 417,12 45: R\$ 425,46 60: R\$ 433,97



VELA ANIV MED C/GLITER KIT 165 C/EXPOSIT

Código: 27649 Fábrica: BRASILEIRINH Unidade: KT/165 F1 F4

UN: R\$ 2,70 AV: R\$ 26,96 15: R\$ 27,53  
30: R\$ 28,08 45: R\$ 28,64 60: R\$ 29,21



VELA ANIV MED C/GLITER 0 AZUL 10X1

Código: 27982 Fábrica: BRASILEIRINH Unidade: PT/10 F1 F4

UN: R\$ 2,70 AV: R\$ 26,96 15: R\$ 27,53  
30: R\$ 28,08 45: R\$ 28,64 60: R\$ 29,21



VELA ANIV MED C/GLITER 0 BCA 10X1

Código: 27992 Fábrica: BRASILEIRINH Unidade: PT/10 F1 F4

UN: R\$ 2,70 AV: R\$ 26,96 15: R\$ 27,53  
30: R\$ 28,08 45: R\$ 28,64 60: R\$ 29,21



VELA ANIV MED C/GLITER 0 ROSA 10X1

Código: 28002 Fábrica: BRASILEIRINH Unidade: PT/10 F1 F4

UN: R\$ 2,70 AV: R\$ 26,96 15: R\$ 27,53  
30: R\$ 28,08 45: R\$ 28,64 60: R\$ 29,21



VELA ANIV MED C/GLITER 1 AZUL 10X1

Código: 27983 Fábrica: BRASILEIRINH Unidade: PT/10 F1 F4

UN: R\$ 2,70 AV: R\$ 26,96 15: R\$ 27,53  
30: R\$ 28,08 45: R\$ 28,64 60: R\$ 29,21



VELA ANIV MED C/GLITER 1 BCA 10X1

Código: 27993 Fábrica: BRASILEIRINH Unidade: PT/10 F1 F4

UN: R\$ 2,70 AV: R\$ 26,96 15: R\$ 27,53  
30: R\$ 28,08 45: R\$ 28,64 60: R\$ 29,21



VELA ANIV MED C/GLITER 1 ROSA 10X1

Código: 28003 Fábrica: BRASILEIRINH Unidade: PT/10 F1 F4

UN: R\$ 2,70 AV: R\$ 26,96 15: R\$ 27,53  
30: R\$ 28,08 45: R\$ 28,64 60: R\$ 29,21



VELA ANIV MED C/GLITER 2 AZUL 10X1

Código: 27984 Fábrica: BRASILEIRINH Unidade: PT/10 F1 F4

UN: R\$ 2,70 AV: R\$ 26,96 15: R\$ 27,53  
30: R\$ 28,08 45: R\$ 28,64 60: R\$ 29,21



VELA ANIV MED C/GLITER 2 BCA 10X1

Código: 27994 Fábrica: BRASILEIRINH Unidade: PT/10 F1 F4

UN: R\$ 2,70 AV: R\$ 26,96 15: R\$ 27,53  
30: R\$ 28,08 45: R\$ 28,64 60: R\$ 29,21



VELA ANIV MED C/GLITER 2 ROSA 10X1

Código: 28004 Fábrica: BRASILEIRINH Unidade: PT/10 F1 F4

UN: R\$ 2,70 AV: R\$ 26,96 15: R\$ 27,53  
30: R\$ 28,08 45: R\$ 28,64 60: R\$ 29,21



VELA ANIV MED C/GLITER 3 AZUL 10X1

Código: 27985 Fábrica: BRASILEIRINH Unidade: PT/10 F1 F4

UN: R\$ 2,70 AV: R\$ 26,96 15: R\$ 27,53  
30: R\$ 28,08 45: R\$ 28,64 60: R\$ 29,21



VELA ANIV MED C/GLITER 3 BCA 10X1

Código: 27995 Fábrica: BRASILEIRINH Unidade: PT/10 F1 F4

UN: R\$ 2,70 AV: R\$ 26,96 15: R\$ 27,53  
30: R\$ 28,08 45: R\$ 28,64 60: R\$ 29,21



VELA ANIV MED C/GLITER 3 ROSA 10X1

Código: 28005 Fábrica: BRASILEIRINH Unidade: PT/10 F1 F4

UN: R\$ 2,70 AV: R\$ 26,96 15: R\$ 27,53  
30: R\$ 28,08 45: R\$ 28,64 60: R\$ 29,21



VELA ANIV MED C/GLITER 4 AZUL 10X1

Código: 27986 Fábrica: BRASILEIRINH Unidade: PT/10 F1 F4

UN: R\$ 2,70 AV: R\$ 26,96 15: R\$ 27,53  
30: R\$ 28,08 45: R\$ 28,64 60: R\$ 29,21



VELA ANIV MED C/GLITER 4 BCA 10X1

Código: 27996 Fábrica: BRASILEIRINH Unidade: PT/10 F1 F4

UN: R\$ 2,70 AV: R\$ 26,96 15: R\$ 27,53  
30: R\$ 28,08 45: R\$ 28,64 60: R\$ 29,21



VELA ANIV MED C/GLITER 4 ROSA 10X1

Código: 28006 Fábrica: BRASILEIRINH Unidade: PT/10 F1 F4

UN: R\$ 2,70 AV: R\$ 26,96 15: R\$ 27,53  
30: R\$ 28,08 45: R\$ 28,64 60: R\$ 29,21



VELA ANIV MED C/GLITER 5 AZUL 10X1

Código: 27987 Fábrica: BRASILEIRINH Unidade: PT/10 F1 F4

UN: R\$ 2,70 AV: R\$ 26,96 15: R\$ 27,53  
30: R\$ 28,08 45: R\$ 28,64 60: R\$ 29,21



VELA ANIV MED C/GLITER 5 BCA 10X1

Código: 27997 Fábrica: BRASILEIRINH Unidade: PT/10 F1 F4

UN: R\$ 2,70 AV: R\$ 26,96 15: R\$ 27,53  
30: R\$ 28,08 45: R\$ 28,64 60: R\$ 29,21



VELA ANIV MED C/GLITER 5 ROSA 10X1

Código: 28007 Fábrica: BRASILEIRINH Unidade: PT/10 F1 F4

UN: R\$ 2,70 AV: R\$ 26,96 15: R\$ 27,53  
30: R\$ 28,08 45: R\$ 28,64 60: R\$ 29,21



VELA ANIV MED C/GLITER 6 AZUL 10X1

Código: 27988 Fábrica: BRASILEIRINH Unidade: PT/10 F1 F4

UN: R\$ 2,70 AV: R\$ 26,96 15: R\$ 27,53  
30: R\$ 28,08 45: R\$ 28,64 60: R\$ 29,21



VELA ANIV MED C/GLITER 6 BCA 10X1

Código: 27998 Fábrica: BRASILEIRINH Unidade: PT/10 F1 F4

UN: R\$ 2,70 AV: R\$ 26,96 15: R\$ 27,53  
30: R\$ 28,08 45: R\$ 28,64 60: R\$ 29,21



VELA ANIV MED C/GLITER 6 ROSA 10X1

Código: 28008 Fábrica: BRASILEIRINH Unidade: PT/10 F1 F4

UN: R\$ 2,70 AV: R\$ 26,96 15: R\$ 27,53  
30: R\$ 28,08 45: R\$ 28,64 60: R\$ 29,21



VELA ANIV MED C/GLITER 7 AZUL 10X1

Código: 27989 Fábrica: BRASILEIRINH Unidade: PT/10 F1 F4

UN: R\$ 2,70 AV: R\$ 26,96 15: R\$ 27,53  
30: R\$ 28,08 45: R\$ 28,64 60: R\$ 29,21



VELA ANIV MED C/GLITER 7 BCA 10X1

Código: 27999 Fábrica: BRASILEIRINH Unidade: PT/10 F1 F4

UN: R\$ 2,70 AV: R\$ 26,96 15: R\$ 27,53  
30: R\$ 28,08 45: R\$ 28,64 60: R\$ 29,21



VELA ANIV MED C/GLITER 7 ROSA 10X1

Código: 28009 Fábrica: BRASILEIRINH Unidade: PT/10 F1 F4

UN: R\$ 2,70 AV: R\$ 26,96 15: R\$ 27,53  
30: R\$ 28,08 45: R\$ 28,64 60: R\$ 29,21



VELA ANIV MED C/GLITER 8 AZUL 10X1

Código: 27990 Fábrica: BRASILEIRINH Unidade: PT/10 F1 F4

UN: R\$ 2,70 AV: R\$ 26,96 15: R\$ 27,53  
30: R\$ 28,08 45: R\$ 28,64 60: R\$ 29,21



VELA ANIV MED C/GLITER 8 BCA 10X1

Código: 28000 Fábrica: BRASILEIRINH Unidade: PT/10 F1 F4

UN: R\$ 2,70 AV: R\$ 26,96 15: R\$ 27,53  
30: R\$ 28,08 45: R\$ 28,64 60: R\$ 29,21



VELA ANIV MED C/GLITER 8 ROSA 10X1

Código: 28010 Fábrica: BRASILEIRINH Unidade: PT/10 F1 F4

UN: R\$ 2,70 AV: R\$ 26,96 15: R\$ 27,53  
30: R\$ 28,08 45: R\$ 28,64 60: R\$ 29,21



VELA ANIV MED C/GLITER 9 AZUL 10X1

Código: 27991 Fábrica: BRASILEIRINH Unidade: PT/10 F1 F4

UN: R\$ 2,70 AV: R\$ 26,96 15: R\$ 27,53  
30: R\$ 28,08 45: R\$ 28,64 60: R\$ 29,21



VELA ANIV MED C/GLITER 9 BCA 10X1

Código: 28001 Fábrica: BRASILEIRINH Unidade: PT/10 F1 F4

UN: R\$ 2,70 AV: R\$ 26,96 15: R\$ 27,53  
30: R\$ 28,08 45: R\$ 28,64 60: R\$ 29,21



VELA ANIV MED C/GLITER 9 ROSA 10X1

Código: 28011 Fábrica: BRASILEIRINH Unidade: PT/10 F1 F4

UN: R\$ 6,67 AV: R\$ 6,67 15: R\$ 6,81  
30: R\$ 6,94 45: R\$ 7,08 60: R\$ 7,22



VELA FONTE LUMINOSA (VULCAO)

Código: 27606 Fábrica: BRASILEIRINH Unidade: PT/1 F1 F4

UN: R\$ 12,41 AV: R\$ 148,93 15: R\$ 152,04  
30: R\$ 155,08 45: R\$ 158,18 60: R\$ 161,34



VELA P/FILTRO CRISTAL C/CARVAO ATIV 12X1

Código: 26517 Fábrica: MINERAL Unidade: DZ/12 F1 F4

UN: R\$ 9,42 AV: R\$ 112,98 15: R\$ 115,34  
30: R\$ 117,64 45: R\$ 120,00 60: R\$ 122,40



VELA P/FILTRO CRISTAL 69 12X1

Código: 8044 Fábrica: MINERAL Unidade: DZ/12 F1 F4

UN: R\$ 8,73 AV: R\$ 8,73 15: R\$ 8,91  
30: R\$ 9,09 45: R\$ 9,27 60: R\$ 9,46

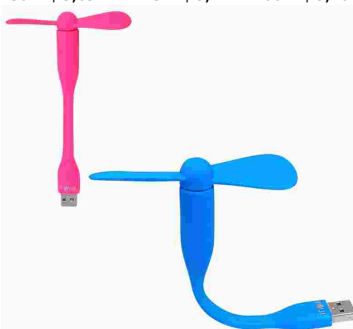

VENTILADOR MINI USB 14 CM 98

Código: 37045 Fábrica: INOVA Unidade: UN/1 F1 F4

UN: R\$ 225,97 AV: R\$ 225,97 15: R\$ 230,68  
30: R\$ 235,30 45: R\$ 240,00 60: R\$ 244,80



VENTILADOR PEDESTAL 127V C/LUZ 3001A

Código: 30661 Fábrica: FUTURO Unidade: CX/1 F1 F4

UN: R\$ 0,20 AV: R\$ 2,98 15: R\$ 3,04  
30: R\$ 3,10 45: R\$ 3,16 60: R\$ 3,23



FIXA CABO MIGUELAO 8MM GF16 15X1

Código: 39784 Fábrica: GIRIFLASH Unidade: PT/15 F1 F4