

UN: R\$ 2,00 AV: R\$ 19,96 15: R\$ 20,37
30: R\$ 20,78 45: R\$ 21,20 60: R\$ 21,62



ADESIVO GDE MORANGUINHO 10X1

Código: Fábrika: Unidade:
46744 STICKERS PT/10
F1 F4

UN: R\$ 2,00 AV: R\$ 19,96 15: R\$ 20,37
30: R\$ 20,78 45: R\$ 21,20 60: R\$ 21,62



ADESIVO GDE RELEVO BEN 10 10X1

Código: Fábrika: Unidade:
37278 STICKERS PT/10
F1 F4

UN: R\$ 2,00 AV: R\$ 19,96 15: R\$ 20,37
30: R\$ 20,78 45: R\$ 21,20 60: R\$ 21,62



ADESIVO GDE RELEVO BETTY BOOP 10X1

Código: Fábrika: Unidade:
37274 STICKERS PT/10
F1 F4

UN: R\$ 2,00 AV: R\$ 19,96 15: R\$ 20,37
30: R\$ 20,78 45: R\$ 21,20 60: R\$ 21,62



ADESIVO GDE RELEVO GATA MARIE 10X1

Código: Fábrika: Unidade:
37272 STICKERS PT/10
F1 F4

UN: R\$ 2,00 AV: R\$ 19,96 15: R\$ 20,37
30: R\$ 20,78 45: R\$ 21,20 60: R\$ 21,62



ADESIVO GDE RELEVO HELLO KITTY 10X1

Código: Fábrika: Unidade:
37275 STICKERS PT/10
F1 F4

UN: R\$ 2,00 AV: R\$ 19,96 15: R\$ 20,37
30: R\$ 20,78 45: R\$ 21,20 60: R\$ 21,62



ADESIVO GDE RELEVO JOLIE 10X1

Código: Fábrika: Unidade:
37281 STICKERS PT/10
F1 F4

UN: R\$ 2,00 AV: R\$ 19,96 15: R\$ 20,37
30: R\$ 20,78 45: R\$ 21,20 60: R\$ 21,62



ADESIVO GDE RELEVO MORANGUINHO 10X1

Código: Fábrika: Unidade:
37273 STICKERS PT/10
F1 F4

UN: R\$ 2,00 AV: R\$ 19,96 15: R\$ 20,37
30: R\$ 20,78 45: R\$ 21,20 60: R\$ 21,62



ADESIVO GDE RELEVO PALMEIRAS 10X1

Código: Fábrika: Unidade:
44252 STICKERS PT/10
F1 F4

UN: R\$ 2,00 AV: R\$ 19,96 15: R\$ 20,37
30: R\$ 20,78 45: R\$ 21,20 60: R\$ 21,62



ADESIVO GDE RELEVO PUCCA 10X1

Código: Fábrika: Unidade:
37277 STICKERS PT/10
F1 F4

UN: R\$ 2,00 AV: R\$ 19,96 15: R\$ 20,37
30: R\$ 20,78 45: R\$ 21,20 60: R\$ 21,62



ADESIVO GDE RELEVO SAO PAULO 10X1

Código: Fábrika: Unidade:
37279 STICKERS PT/10
F1 F4

UN: R\$ 2,00 AV: R\$ 19,96 15: R\$ 20,37
30: R\$ 20,78 45: R\$ 21,20 60: R\$ 21,62



ADESIVO GDE RELEVO SORTIDO 10X1

Código: Fábrika: Unidade:
40709 STICKERS PT/10
F1 F4

UN: R\$ 2,00 AV: R\$ 19,96 15: R\$ 20,37
30: R\$ 20,78 45: R\$ 21,20 60: R\$ 21,62



ADESIVO GDE RELEVO VASCO 10X1

Código: Fábrika: Unidade:
37280 STICKERS PT/10
F1 F4

UN: R\$ 2,99 AV: R\$ 29,94 15: R\$ 30,57
30: R\$ 31,18 45: R\$ 31,80 60: R\$ 32,44



ADESIVO GIGANTE BARBIE 10X1

Código: Fábrika: Unidade:
37851 STICKERS PT/10
F1 F4

UN: R\$ 1,66 AV: R\$ 19,96 15: R\$ 20,37
30: R\$ 20,78 45: R\$ 21,20 60: R\$ 21,62



ADESIVO GRANDE BORBOLETAS 12X1

Código: Fábrika: Unidade:
36429 STICKERS DZ/12
F4

UN: R\$ 1,66 AV: R\$ 19,96 15: R\$ 20,37
30: R\$ 20,78 45: R\$ 21,20 60: R\$ 21,62



ADESIVO GRANDE HELLO KITTY 12X1

Código: Fábrika: Unidade:
37266 STICKERS DZ/12
F1 F4

UN: R\$ 1,66 AV: R\$ 19,96 15: R\$ 20,37
30: R\$ 20,78 45: R\$ 21,20 60: R\$ 21,62



ADESIVO GRANDE NUMEROS 12X1

Código: Fábrika: Unidade:
29715 STICKERS DZ/12
F1 F4

UN: R\$ 1,66 AV: R\$ 19,96 15: R\$ 20,37
30: R\$ 20,78 45: R\$ 21,20 60: R\$ 21,62



ADESIVO GRANDE PIU PIU 12X1

Código: Fábrika: Unidade:
20769 STICKERS DZ/12
F4

UN: R\$ 1,66 AV: R\$ 19,96 15: R\$ 20,37
30: R\$ 20,78 45: R\$ 21,20 60: R\$ 21,62



ADESIVO GRANDE SMURFS 12X1

Código: Fábrika: Unidade:
37267 STICKERS DZ/12
F1 F4

UN: R\$ 1,66 AV: R\$ 19,96 15: R\$ 20,37
30: R\$ 20,78 45: R\$ 21,20 60: R\$ 21,62



ADESIVO GRANDE SNOOPY 12X1

Código: Fábrika: Unidade:
18179 STICKERS DZ/12
F1 F4

UN: R\$ 1,66 AV: R\$ 19,96 15: R\$ 20,37
30: R\$ 20,78 45: R\$ 21,20 60: R\$ 21,62



ADESIVO GRANDE SORTIDO 12X1

Código: Fábrika: Unidade:
20606 STICKERS DZ/12
F1 F4

UN: R\$ 1,66 AV: R\$ 19,96 15: R\$ 20,37
30: R\$ 20,78 45: R\$ 21,20 60: R\$ 21,62



ADESIVO GRANDE SUPER PODEROSAS 12X1

Código: Fábrika: Unidade:
37269 STICKERS DZ/12
F1 F4

UN: R\$ 1,66 AV: R\$ 19,96 15: R\$ 20,37
30: R\$ 20,78 45: R\$ 21,20 60: R\$ 21,62



ADESIVO GRANDE TURMA DA MONICA 12X1

Código: Fábrika: Unidade:
29664 STICKERS DZ/12
F1 F4

UN: R\$ 1,50 AV: R\$ 14,97 15: R\$ 15,28
30: R\$ 15,58 45: R\$ 15,90 60: R\$ 16,21



ADESIVO MED BRASIL 10X1

Código: Fábrika: Unidade:
51072 STICKERS PT/10
F1 F4

UN: R\$ 1,50 AV: R\$ 14,97 15: R\$ 15,28
30: R\$ 15,58 45: R\$ 15,90 60: R\$ 16,21



ADESIVO MED RELEVO SORTIDO 10X1

Código: Fábrika: Unidade:
47212 STICKERS PT/10
F1 F4

UN: R\$ 0,33 AV: R\$ 3,98 15: R\$ 4,07
30: R\$ 4,15 45: R\$ 4,23 60: R\$ 4,32



ADESIVO P BAHIA 12X1

Código: Fábrika: Unidade:
22034 STICKERS DZ/12
F1 F4

UN: R\$ 0,33 AV: R\$ 3,98 15: R\$ 4,07
30: R\$ 4,15 45: R\$ 4,23 60: R\$ 4,32



ADESIVO P BARBIE 12X1

Código: Fábrika: Unidade:
22025 STICKERS DZ/12
F1 F4

UN: R\$ 0,33 AV: R\$ 3,98 15: R\$ 4,07
30: R\$ 4,15 45: R\$ 4,23 60: R\$ 4,32



ADESIVO P BARNEY E SEUS AMIGOS 12X1

Código: Fábrika: Unidade:
46737 STICKERS DZ/12
F1 F4

UN: R\$ 0,33 AV: R\$ 3,98 15: R\$ 4,07
30: R\$ 4,15 45: R\$ 4,23 60: R\$ 4,32



ADESIVO P BAT MAN 12X1

Código: Fábrika: Unidade:
25021 STICKERS DZ/12
F1 F4

UN: R\$ 0,33 AV: R\$ 3,98 15: R\$ 4,07
30: R\$ 4,15 45: R\$ 4,23 60: R\$ 4,32



ADESIVO P BORBOLETAS 12X1

Código: Fábrika: Unidade:
24028 STICKERS DZ/12
F1 F4

UN: R\$ 0,33 AV: R\$ 3,98 15: R\$ 4,07
30: R\$ 4,15 45: R\$ 4,23 60: R\$ 4,32



ADESIVO P CARROS 12X1

Código: Fábrika: Unidade:
18175 STICKERS DZ/12
F1 F4

UN: R\$ 0,33 AV: R\$ 3,98 15: R\$ 4,07
30: R\$ 4,15 45: R\$ 4,23 60: R\$ 4,32



ADESIVO P COCORICO 12X1

Código: Fábrika: Unidade:
25721 STICKERS DZ/12
F4

UN: R\$ 0,33 AV: R\$ 3,98 15: R\$ 4,07
30: R\$ 4,15 45: R\$ 4,23 60: R\$ 4,32



ADESIVO P CORACAO 12X1

Código: Fábrika: Unidade:
22028 STICKERS DZ/12
F1 F4

UN: R\$ 0,33 AV: R\$ 3,98 15: R\$ 4,07
30: R\$ 4,15 45: R\$ 4,23 60: R\$ 4,32



ADESIVO P CORINTHIANS 12X1
Código: Fábrica: Unidade:
51080 STICKERS DZ/12
F1 F4

UN: R\$ 0,33 AV: R\$ 3,98 15: R\$ 4,07
30: R\$ 4,15 45: R\$ 4,23 60: R\$ 4,32



ADESIVO P CORUJAS 12X1
Código: Fábrica: Unidade:
34866 STICKERS DZ/12
F1 F4

UN: R\$ 0,33 AV: R\$ 3,98 15: R\$ 4,07
30: R\$ 4,15 45: R\$ 4,23 60: R\$ 4,32



ADESIVO P CRUZEIRO 12X1
Código: Fábrica: Unidade:
24853 STICKERS DZ/12
F1 F4

UN: R\$ 0,33 AV: R\$ 3,98 15: R\$ 4,07
30: R\$ 4,15 45: R\$ 4,23 60: R\$ 4,32

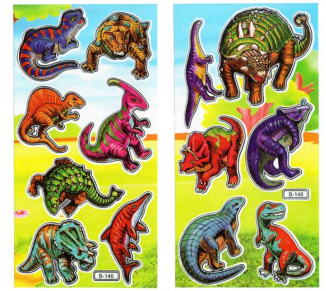

ADESIVO P DINOSSAUROS 12X1
Código: Fábrica: Unidade:
50427 STICKERS DZ/12
F1 F4

UN: R\$ 0,33 AV: R\$ 3,98 15: R\$ 4,07
30: R\$ 4,15 45: R\$ 4,23 60: R\$ 4,32



ADESIVO P DRAGON BALL Z 12X1
Código: Fábrica: Unidade:
4536 STICKERS DZ/12
F1 F4

UN: R\$ 0,33 AV: R\$ 3,98 15: R\$ 4,07
30: R\$ 4,15 45: R\$ 4,23 60: R\$ 4,32



ADESIVO P ESTRELAS BRILHA NO ESCURO 12X1
Código: Fábrica: Unidade:
22030 STICKERS DZ/12
F4

UN: R\$ 0,33 AV: R\$ 3,98 15: R\$ 4,07
30: R\$ 4,15 45: R\$ 4,23 60: R\$ 4,32



ADESIVO P GARFIELD 12X1
Código: Fábrica: Unidade:
16431 STICKERS DZ/12
F1 F4

UN: R\$ 0,33 AV: R\$ 3,98 15: R\$ 4,07
30: R\$ 4,15 45: R\$ 4,23 60: R\$ 4,32



ADESIVO P GASPARZINHO 12X1
Código: Fábrica: Unidade:
51112 STICKERS DZ/12
F4

UN: R\$ 0,33 AV: R\$ 3,98 15: R\$ 4,07
30: R\$ 4,15 45: R\$ 4,23 60: R\$ 4,32



ADESIVO P HELLO KITT 12X1
Código: Fábrica: Unidade:
22036 STICKERS DZ/12
F1 F4

UN: R\$ 0,33 AV: R\$ 3,98 15: R\$ 4,07
30: R\$ 4,15 45: R\$ 4,23 60: R\$ 4,32



ADESIVO P LETRAS 12X1
Código: Fábrica: Unidade:
7354 STICKERS DZ/12
F1 F4

UN: R\$ 0,33 AV: R\$ 3,98 15: R\$ 4,07
30: R\$ 4,15 45: R\$ 4,23 60: R\$ 4,32



ADESIVO P NARUTO 12X1
Código: Fábrica: Unidade:
51114 STICKERS DZ/12
F4

UN: R\$ 0,33 AV: R\$ 3,98 15: R\$ 4,07
30: R\$ 4,15 45: R\$ 4,23 60: R\$ 4,32



ADESIVO P NATAL 12X1
Código: Fábrica: Unidade:
37231 STICKERS DZ/12
F1 F4

UN: R\$ 0,33 AV: R\$ 3,98 15: R\$ 4,07
30: R\$ 4,15 45: R\$ 4,23 60: R\$ 4,32



ADESIVO P NUMEROS 12X1
Código: Fábrica: Unidade:
4758 STICKERS DZ/12
F4

UN: R\$ 0,33 AV: R\$ 3,98 15: R\$ 4,07
30: R\$ 4,15 45: R\$ 4,23 60: R\$ 4,32



ADESIVO P OS INCRIVEIS 12X1
Código: Fábrica: Unidade:
25724 STICKERS DZ/12
F1 F4

UN: R\$ 0,33 AV: R\$ 3,98 15: R\$ 4,07
30: R\$ 4,15 45: R\$ 4,23 60: R\$ 4,32



ADESIVO P PALMEIRAS 12X1
Código: Fábrica: Unidade:
37229 STICKERS DZ/12
F1 F4

UN: R\$ 0,33 AV: R\$ 3,98 15: R\$ 4,07
30: R\$ 4,15 45: R\$ 4,23 60: R\$ 4,32



ADESIVO P PIU PIU 12X1
Código: Fábrica: Unidade:
24029 STICKERS DZ/12
F1 F4

UN: R\$ 0,33 AV: R\$ 3,98 15: R\$ 4,07
30: R\$ 4,15 45: R\$ 4,23 60: R\$ 4,32



ADESIVO P POKEMON 12X1

Código: Fábrika: Unidade:
30531 STICKERS DZ/12
F1 F4

UN: R\$ 0,33 AV: R\$ 3,98 15: R\$ 4,07
30: R\$ 4,15 45: R\$ 4,23 60: R\$ 4,32



ADESIVO P POWER RANGERS 12X1

Código: Fábrika: Unidade:
22029 STICKERS DZ/12
F1 F4

UN: R\$ 0,33 AV: R\$ 3,98 15: R\$ 4,07
30: R\$ 4,15 45: R\$ 4,23 60: R\$ 4,32



ADESIVO P PRINCESAS 12X1

Código: Fábrika: Unidade:
18181 STICKERS DZ/12
F1 F4

UN: R\$ 0,33 AV: R\$ 3,98 15: R\$ 4,07
30: R\$ 4,15 45: R\$ 4,23 60: R\$ 4,32



ADESIVO P SAO PAUL 12X1

Código: Fábrika: Unidade:
37230 STICKERS DZ/12
F1 F4

UN: R\$ 0,33 AV: R\$ 3,98 15: R\$ 4,07
30: R\$ 4,15 45: R\$ 4,23 60: R\$ 4,32

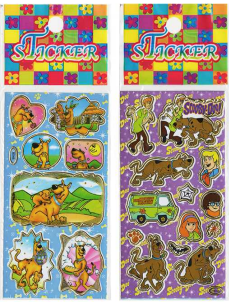

ADESIVO P SCOOBY DOO 12X1

Código: Fábrika: Unidade:
24851 STICKERS DZ/12
F4

UN: R\$ 0,33 AV: R\$ 3,98 15: R\$ 4,07
30: R\$ 4,15 45: R\$ 4,23 60: R\$ 4,32



ADESIVO P SMILINGUIDO 12X1

Código: Fábrika: Unidade:
22031 STICKERS DZ/12
F4

UN: R\$ 0,33 AV: R\$ 3,98 15: R\$ 4,07
30: R\$ 4,15 45: R\$ 4,23 60: R\$ 4,32



ADESIVO P SORTIDO 12X1

Código: Fábrika: Unidade:
3806 STICKERS DZ/12
F1 F4

UN: R\$ 0,33 AV: R\$ 3,98 15: R\$ 4,07
30: R\$ 4,15 45: R\$ 4,23 60: R\$ 4,32



ADESIVO P SPIDERMAN 12X1

Código: Fábrika: Unidade:
22033 STICKERS DZ/12
F4

UN: R\$ 0,33 AV: R\$ 3,98 15: R\$ 4,07
30: R\$ 4,15 45: R\$ 4,23 60: R\$ 4,32



ADESIVO P SUPER MARIO 12X1

Código: Fábrika: Unidade:
18180 STICKERS DZ/12
F1 F4

UN: R\$ 0,33 AV: R\$ 3,98 15: R\$ 4,07
30: R\$ 4,15 45: R\$ 4,23 60: R\$ 4,32



ADESIVO P SUPER PODEROSAS 12X1

Código: Fábrika: Unidade:
18174 STICKERS DZ/12
F1 F4

UN: R\$ 0,33 AV: R\$ 3,98 15: R\$ 4,07
30: R\$ 4,15 45: R\$ 4,23 60: R\$ 4,32



ADESIVO P YU GI OH 12X1

Código: Fábrika: Unidade:
51113 STICKERS DZ/12
F4

UN: R\$ 2,10 AV: R\$ 2,10 15: R\$ 2,14
30: R\$ 2,18 45: R\$ 2,23 60: R\$ 2,27



ADESIVO PAREDE WALL STICKER P DECORATIVO

Código: Fábrika: Unidade:
16429 HAI BRASIL UN/1
F1 F4

UN: R\$ 1,50 AV: R\$ 14,97 15: R\$ 15,28
30: R\$ 15,58 45: R\$ 15,90 60: R\$ 16,21



ADESIVO PEQ RELEVO BEN 10 10X1

Código: Fábrika: Unidade:
46103 STICKERS PT/10
F1 F4

UN: R\$ 1,50 AV: R\$ 14,97 15: R\$ 15,28
30: R\$ 15,58 45: R\$ 15,90 60: R\$ 16,21



ADESIVO PEQ RELEVO BETY BOOP 10X1

Código: Fábrika: Unidade:
46093 STICKERS PT/10
F1 F4

UN: R\$ 1,50 AV: R\$ 14,97 15: R\$ 15,28
30: R\$ 15,58 45: R\$ 15,90 60: R\$ 16,21



ADESIVO PEQ RELEVO HELLO KITTY 10X1

Código: Fábrika: Unidade:
46104 STICKERS PT/10
F1 F4

UN: R\$ 1,50 AV: R\$ 14,97 15: R\$ 15,28
30: R\$ 15,58 45: R\$ 15,90 60: R\$ 16,21



ADESIVO PEQ RELEVO JOLIE 10X1

Código: Fábrika: Unidade:
46101 STICKERS PT/10
F1 F4

UN: R\$ 1,50 AV: R\$ 14,97 15: R\$ 15,28
30: R\$ 15,58 45: R\$ 15,90 60: R\$ 16,21



ADESIVO PEQ RELEVO MICKEY MINNIE 10X11

Código: Fábrika: Unidade:
47213 STICKERS PT/10 UN/1
F1 F4

UN: R\$ 23,95 AV: R\$ 23,95 15: R\$ 24,45
30: R\$ 24,94 45: R\$ 25,44 60: R\$ 25,95



AGENDA PERMAN DIARI 15X21CM 406PGS 6102

Código: Fábrika: Unidade:
42633 CIRCULO UN/1
F1 F4

UN: R\$ 24,95 AV: R\$ 24,95 15: R\$ 25,47
30: R\$ 25,98 45: R\$ 26,50 60: R\$ 27,03



AGENDA PERMAN ESP COR 11X15CM 176FL 2005

Código: Fábrika: Unidade:
43756 WIN PAPER UN/1
F1 F4

UN: R\$ 24,95 AV: R\$ 24,95 15: R\$ 25,47
30: R\$ 25,98 45: R\$ 26,50 60: R\$ 27,03



AGENDA PERMAN ESP GLI 11X15CM 176FL 2006

Código: Fábrika: Unidade:
43760 WIN PAPER UN/1
F1 F4

UN: R\$ 24,95 AV: R\$ 24,95 15: R\$ 25,47
30: R\$ 25,98 45: R\$ 26,50 60: R\$ 27,03



AGENDA PERMAN ESP MAR 11X15CM 176FL 2004

Código: Fábrika: Unidade:
43755 WIN PAPER UN/1
F1 F4

UN: R\$ 20,96 AV: R\$ 20,96 15: R\$ 21,39
30: R\$ 21,82 45: R\$ 22,26 60: R\$ 22,70



AGENDA PERMAN ESP 11X15CM 176FL 2001

Código: Fábrika: Unidade:
43757 WIN PAPER UN/1
F1 F4

UN: R\$ 20,96 AV: R\$ 20,96 15: R\$ 21,39
30: R\$ 21,82 45: R\$ 22,26 60: R\$ 22,70



AGENDA PERMAN ESP 11X15CM 176FL 2002

Código: Fábrika: Unidade:
43759 WIN PAPER UN/1
F1 F4

UN: R\$ 24,95 AV: R\$ 24,95 15: R\$ 25,47
30: R\$ 25,98 45: R\$ 26,50 60: R\$ 27,03

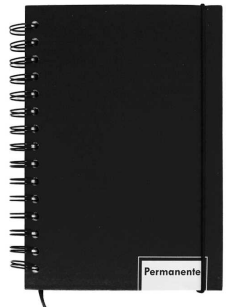

AGENDA PERMAN ESP 11X15CM 320PAG 10046

Código: Fábrika: Unidade:
42815 WIN PAPER UN/1
F1 F4

UN: R\$ 24,95 AV: R\$ 24,95 15: R\$ 25,47
30: R\$ 25,98 45: R\$ 26,50 60: R\$ 27,03

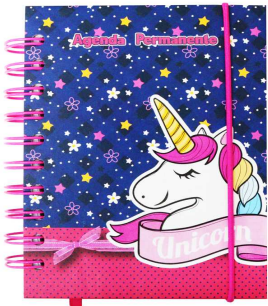

AGENDA PERMAN ESP 11X15CM 352 PAG 1021

Código: Fábrika: Unidade:
43777 WIN PAPER UN/1
F1 F4

UN: R\$ 24,95 AV: R\$ 24,95 15: R\$ 25,47
30: R\$ 25,98 45: R\$ 26,50 60: R\$ 27,03



AGENDA PERMAN ESP 15X11CM 320PAG 10002

Código: Fábrika: Unidade:
43812 WIN PAPER UN/1
F1 F4

UN: R\$ 34,93 AV: R\$ 34,93 15: R\$ 35,66
30: R\$ 36,38 45: R\$ 37,10 60: R\$ 37,84



AGENDA PERMAN ESP 15X21CM 160FL 2007

Código: Fábrika: Unidade:
43761 WIN PAPER UN/1
F1 F4

UN: R\$ 34,93 AV: R\$ 34,93 15: R\$ 35,66
30: R\$ 36,38 45: R\$ 37,10 60: R\$ 37,84

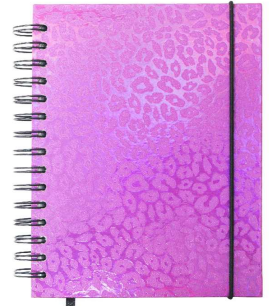

AGENDA PERMAN ESP 15X21CM 160FL 2009

Código: Fábrika: Unidade:
43762 WIN PAPER UN/1
F1 F4

UN: R\$ 29,94 AV: R\$ 29,94 15: R\$ 30,57
30: R\$ 31,18 45: R\$ 31,80 60: R\$ 32,44



AGENDA PERMAN ESP 15X21CM 320 PAG 52344

Código: Fábrika: Unidade:
42939 WIN PAPER UN/1
F1 F4

UN: R\$ 31,94 AV: R\$ 31,94 15: R\$ 32,60
30: R\$ 33,26 45: R\$ 33,92 60: R\$ 34,60

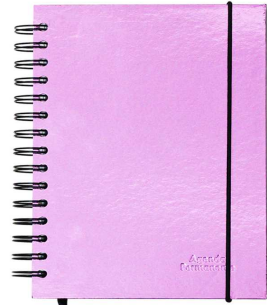

AGENDA PERMAN ESP 15X21CM 320PAG 10005

Código: Fábrika: Unidade:
43763 WIN PAPER UN/1
F1 F4

UN: R\$ 29,94 AV: R\$ 29,94 15: R\$ 30,57
30: R\$ 31,18 45: R\$ 31,80 60: R\$ 32,44

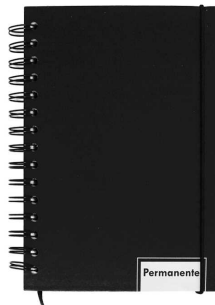

AGENDA PERMAN ESPIR 15X21CM 320PAG 1006

Código: Fábrika: Unidade:
42816 WINPAPER UN/1
F1 F4

UN: R\$ 13,97 AV: R\$ 13,97 15: R\$ 14,26
30: R\$ 14,54 45: R\$ 14,83 60: R\$ 15,13



AGENDA PERMAN INF 17X11,8CM 64PAG 1487

Código: Fábrika: Unidade:
42817 WIN PAPER UN/1
F1 F4

UN: R\$ 29,94 AV: R\$ 29,94 15: R\$ 30,57
30: R\$ 31,18 45: R\$ 31,80 60: R\$ 32,44



AGENDA PERMAN SOCIAL 15X21CM 320PAG 1015
Código: Fábrica: Unidade:
15905 WINPAPER UN/1
F1 F4

UN: R\$ 21,95 AV: R\$ 21,95 15: R\$ 22,41
30: R\$ 22,86 45: R\$ 23,32 60: R\$ 23,78



AGENDA PERMANENTE 14X20CM 122FLS
Código: Fábrica: Unidade:
41330 ARTS GRAF UN/1
F1 F4

UN: R\$ 28,94 AV: R\$ 28,94 15: R\$ 29,55
30: R\$ 30,14 45: R\$ 30,74 60: R\$ 31,36



AGENDA PERMANENTE 15X21CM 320 PGS 50010
Código: Fábrica: Unidade:
48386 WIN PAPER UN/1
F1 F4

UN: R\$ 19,96 AV: R\$ 19,96 15: R\$ 20,37
30: R\$ 20,78 45: R\$ 21,20 60: R\$ 21,62



AGENDA PLANNER 10,5X15CM 320PAG 5004
Código: Fábrica: Unidade:
43531 WIN PAPER UN/1
F1 F4

UN: R\$ 7,98 AV: R\$ 7,98 15: R\$ 8,14
30: R\$ 8,31 45: R\$ 8,47 60: R\$ 8,64

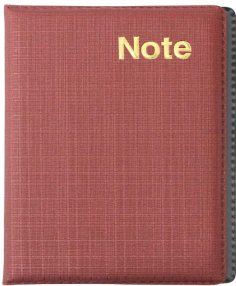

AGENDA TELEFONIC 14X10CM COURO SINT 101
Código: Fábrica: Unidade:
43780 WIN PAPER UN/1
F1 F4

UN: R\$ 34,93 AV: R\$ 34,93 15: R\$ 35,66
30: R\$ 36,38 45: R\$ 37,10 60: R\$ 37,84



AGENDA 2025 EXECUTIVA 15X21CM ESP 320 PG
Código: Fábrica: Unidade:
48398 WIN PAPER UN/1
F1 F4

UN: R\$ 29,94 AV: R\$ 29,94 15: R\$ 30,57
30: R\$ 31,18 45: R\$ 31,80 60: R\$ 32,44



AGENDA 2025 13,2X20CM 328PAG C/HORAS
Código: Fábrica: Unidade:
42404 NOVO OLHAR UN/1
F1 F4

UN: R\$ 98,84 AV: R\$ 98,84 15: R\$ 100,90
30: R\$ 102,92 45: R\$ 104,98 60: R\$ 107,08



AGENDA 2025 20X27CM ESP 200 FOLHAS
Código: Fábrica: Unidade:
49244 TILIBRA UN/1
F1 F4

UN: R\$ 28,45 AV: R\$ 28,45 15: R\$ 29,05
30: R\$ 29,63 45: R\$ 30,22 60: R\$ 30,83



AGENDA 2026 1307X18,7XM 168 PGS
Código: Fábrica: Unidade:
29796 RIO MASTER UN/1
F1 F4

UN: R\$ 0,24 AV: R\$ 9,47 15: R\$ 9,67
30: R\$ 9,87 45: R\$ 10,06 60: R\$ 10,26
5 cm

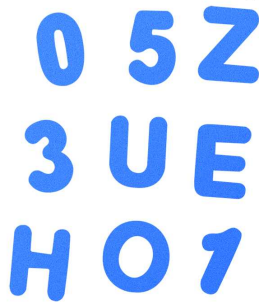

ALFABETO E NUMEROS EVA 5CM AMARELO 40X1
Código: Fábrica: Unidade:
38589 BRASILPAPERS PT/40
F1 F4

UN: R\$ 0,24 AV: R\$ 9,47 15: R\$ 9,67
30: R\$ 9,87 45: R\$ 10,06 60: R\$ 10,26
5 cm



ALFABETO E NUMEROS EVA 5CM BRANCO 40X1
Código: Fábrica: Unidade:
38590 BRASILPAPERS PT/40
F1 F4

UN: R\$ 0,24 AV: R\$ 9,47 15: R\$ 9,67
30: R\$ 9,87 45: R\$ 10,06 60: R\$ 10,26
5 cm

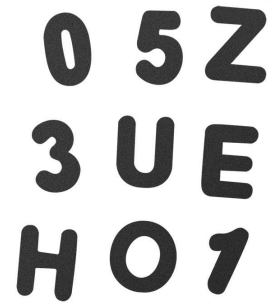

ALFABETO E NUMEROS EVA 5CM PRETO 40X1
Código: Fábrica: Unidade:
38595 BRASILPAPERS PT/40
F1 F4

UN: R\$ 0,24 AV: R\$ 9,47 15: R\$ 9,67
30: R\$ 9,87 45: R\$ 10,06 60: R\$ 10,26
5 cm

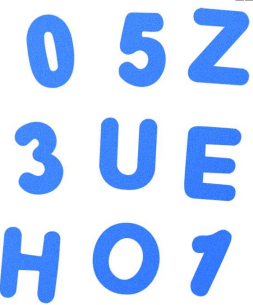

ALFABETO E NUMEROS EVA 5CM ROSA 40X1
Código: Fábrica: Unidade:
38593 BRASILPAPERS PT/40
F1 F4

UN: R\$ 0,24 AV: R\$ 9,47 15: R\$ 9,67
30: R\$ 9,87 45: R\$ 10,06 60: R\$ 10,26
5 cm



ALFABETO E NUMEROS EVA 5CM SORTIDO 40X1
Código: Fábrica: Unidade:
38594 BRASILPAPERS PT/40
F1 F4

UN: R\$ 0,24 AV: R\$ 9,47 15: R\$ 9,67
30: R\$ 9,87 45: R\$ 10,06 60: R\$ 10,26
5 cm

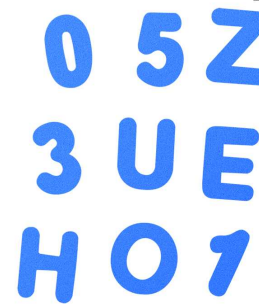

ALFABETO E NUMEROS EVA 5CM VERDE 40X1
Código: Fábrica: Unidade:
38592 BRASILPAPERS PT/40
F1 F4

UN: R\$ 0,95 AV: R\$ 9,47 15: R\$ 9,67
30: R\$ 9,87 45: R\$ 10,06 60: R\$ 10,26
13 cm

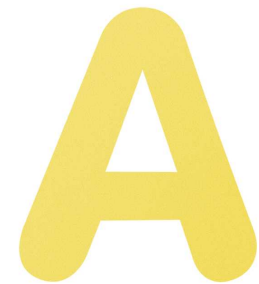

ALFABETO EVA 13CM LETRA A AMARELO 10X1
Código: Fábrica: Unidade:
38623 BRASILPAPERS PT/10
F4

UN: R\$ 0,95 AV: R\$ 9,47 15: R\$ 9,67
30: R\$ 9,87 45: R\$ 10,06 60: R\$ 10,26
13 cm

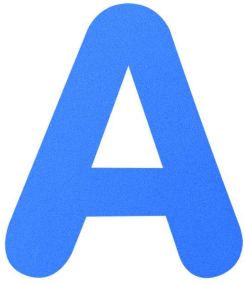

ALFABETO EVA 13CM LETRA A AZUL 10X1
Código: 38737 Fábrica: BRASILPAPERS Unidade: PT/10 F4

UN: R\$ 0,95 AV: R\$ 9,47 15: R\$ 9,67
30: R\$ 9,87 45: R\$ 10,06 60: R\$ 10,26
13 cm

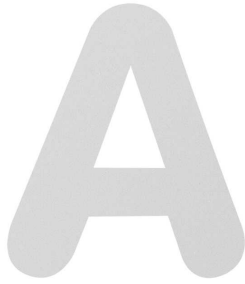

ALFABETO EVA 13CM LETRA A BRANCO 10X1
Código: 38710 Fábrica: BRASILPAPERS Unidade: PT/10 F4

UN: R\$ 0,95 AV: R\$ 9,47 15: R\$ 9,67
30: R\$ 9,87 45: R\$ 10,06 60: R\$ 10,26
13 cm

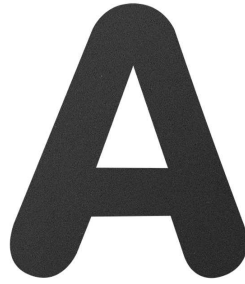

ALFABETO EVA 13CM LETRA A PRETO 10X1
Código: 38633 Fábrica: BRASILPAPERS Unidade: PT/10 F4

UN: R\$ 0,95 AV: R\$ 9,47 15: R\$ 9,67
30: R\$ 9,87 45: R\$ 10,06 60: R\$ 10,26
13 cm



ALFABETO EVA 13CM LETRA A ROSA 10X1
Código: 38596 Fábrica: BRASILPAPERS Unidade: PT/10 F4

UN: R\$ 0,95 AV: R\$ 9,47 15: R\$ 9,67
30: R\$ 9,87 45: R\$ 10,06 60: R\$ 10,26
13 cm

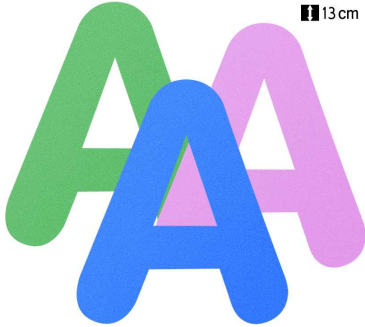

ALFABETO EVA 13CM LETRA A SORTIDO 10X1
Código: 38821 Fábrica: BRASILPAPERS Unidade: PT/10 F4

UN: R\$ 0,95 AV: R\$ 9,47 15: R\$ 9,67
30: R\$ 9,87 45: R\$ 10,06 60: R\$ 10,26
13 cm

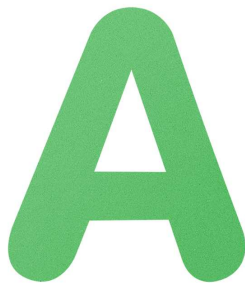

ALFABETO EVA 13CM LETRA A VERDE 10X1
Código: 38767 Fábrica: BRASILPAPERS Unidade: PT/10 F4

UN: R\$ 0,95 AV: R\$ 9,47 15: R\$ 9,67
30: R\$ 9,87 45: R\$ 10,06 60: R\$ 10,26
13 cm



ALFABETO EVA 13CM LETRA A VERMELHO 10X1
Código: 38794 Fábrica: BRASILPAPERS Unidade: PT/10 F4

UN: R\$ 0,95 AV: R\$ 9,47 15: R\$ 9,67
30: R\$ 9,87 45: R\$ 10,06 60: R\$ 10,26
13 cm



ALFABETO EVA 13CM LETRA B AMARELO 10X1
Código: 38709 Fábrica: BRASILPAPERS Unidade: PT/10 F4

UN: R\$ 0,95 AV: R\$ 9,47 15: R\$ 9,67
30: R\$ 9,87 45: R\$ 10,06 60: R\$ 10,26
13 cm



ALFABETO EVA 13CM LETRA B AZUL 10X1
Código: 38738 Fábrica: BRASILPAPERS Unidade: PT/10 F4

UN: R\$ 0,95 AV: R\$ 9,47 15: R\$ 9,67
30: R\$ 9,87 45: R\$ 10,06 60: R\$ 10,26
13 cm



ALFABETO EVA 13CM LETRA B BRANCO 10X1
Código: 38711 Fábrica: BRASILPAPERS Unidade: PT/10 F4

UN: R\$ 0,95 AV: R\$ 9,47 15: R\$ 9,67
30: R\$ 9,87 45: R\$ 10,06 60: R\$ 10,26
13 cm



ALFABETO EVA 13CM LETRA B PRETO 10X1
Código: 38634 Fábrica: BRASILPAPERS Unidade: PT/10 F4

UN: R\$ 0,95 AV: R\$ 9,47 15: R\$ 9,67
30: R\$ 9,87 45: R\$ 10,06 60: R\$ 10,26
13 cm



ALFABETO EVA 13CM LETRA B VERDE 10X1
Código: 38768 Fábrica: BRASILPAPERS Unidade: PT/10 F4

UN: R\$ 0,95 AV: R\$ 9,47 15: R\$ 9,67
30: R\$ 9,87 45: R\$ 10,06 60: R\$ 10,26
13 cm



ALFABETO EVA 13CM LETRA B VERMELHO 10X1
Código: 38795 Fábrica: BRASILPAPERS Unidade: PT/10 F4

UN: R\$ 0,95 AV: R\$ 9,47 15: R\$ 9,67
30: R\$ 9,87 45: R\$ 10,06 60: R\$ 10,26
13 cm



ALFABETO EVA 13CM LETRA C AMARELO 10X1
Código: 38682 Fábrica: BRASILPAPERS Unidade: PT/10 F4

UN: R\$ 0,95 AV: R\$ 9,47 15: R\$ 9,67
30: R\$ 9,87 45: R\$ 10,06 60: R\$ 10,26
13 cm



ALFABETO EVA 13CM LETRA Ç AMARELO 10X1
Código: 38697 Fábrica: BRASILPAPERS Unidade: PT/10 F4

UN: R\$ 0,95 AV: R\$ 9,47 15: R\$ 9,67
30: R\$ 9,87 45: R\$ 10,06 60: R\$ 10,26
13 cm



ALFABETO EVA 13CM LETRA C AZUL 10X1
Código: 38739 Fábrica: BRASILPAPERS Unidade: PT/10 F4

UN: R\$ 0,95 AV: R\$ 9,47 15: R\$ 9,67
30: R\$ 9,87 45: R\$ 10,06 60: R\$ 10,26
13 cm



ALFABETO EVA 13CM LETRA Ç AZUL 10X1
Código: 38766 Fábrica: BRASILPAPERS Unidade: PT/10 F4

UN: R\$ 0,95 AV: R\$ 9,47 15: R\$ 9,67
30: R\$ 9,87 45: R\$ 10,06 60: R\$ 10,26
13 cm

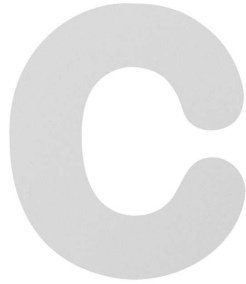

ALFABETO EVA 13CM LETRA C BRANCO 10X1
Código: 38712 Fábrica: BRASILPAPERS Unidade: PT/10 F4

UN: R\$ 0,95 AV: R\$ 9,47 15: R\$ 9,67
30: R\$ 9,87 45: R\$ 10,06 60: R\$ 10,26
13 cm



ALFABETO EVA 13CM LETRA Ç BRANCO 10X1
Código: 38736 Fábrica: BRASILPAPERS Unidade: PT/10 F4

UN: R\$ 0,95 AV: R\$ 9,47 15: R\$ 9,67
30: R\$ 9,87 45: R\$ 10,06 60: R\$ 10,26
13 cm

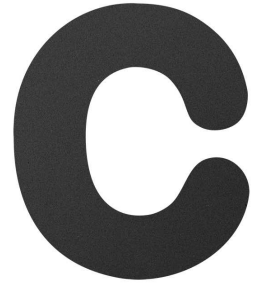

ALFABETO EVA 13CM LETRA C PRETO 10X1
Código: 38639 Fábrica: BRASILPAPERS Unidade: PT/10 F4

UN: R\$ 0,95 AV: R\$ 9,47 15: R\$ 9,67
30: R\$ 9,87 45: R\$ 10,06 60: R\$ 10,26
13 cm

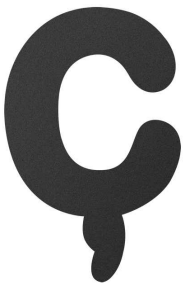

ALFABETO EVA 13CM LETRA Ç PRETO 10X1
Código: 38702 Fábrica: BRASILPAPERS Unidade: PT/10 F4

UN: R\$ 0,95 AV: R\$ 9,47 15: R\$ 9,67
30: R\$ 9,87 45: R\$ 10,06 60: R\$ 10,26
13 cm

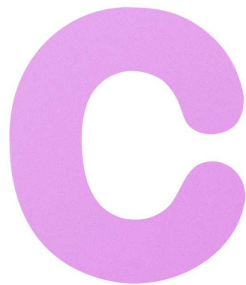

ALFABETO EVA 13CM LETRA C ROSA 10X1
Código: 38598 Fábrica: BRASILPAPERS Unidade: PT/10 F4

UN: R\$ 0,95 AV: R\$ 9,47 15: R\$ 9,67
30: R\$ 9,87 45: R\$ 10,06 60: R\$ 10,26
13 cm



ALFABETO EVA 13CM LETRA Ç ROSA 10X1
Código: 38622 Fábrica: BRASILPAPERS Unidade: PT/10 F4

UN: R\$ 0,95 AV: R\$ 9,47 15: R\$ 9,67
30: R\$ 9,87 45: R\$ 10,06 60: R\$ 10,26
13 cm

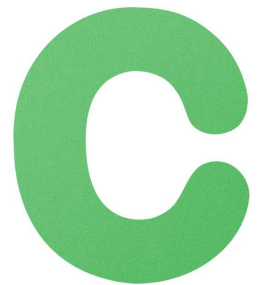

ALFABETO EVA 13CM LETRA C VERDE 10X1
Código: 38769 Fábrica: BRASILPAPERS Unidade: PT/10 F4

UN: R\$ 0,95 AV: R\$ 9,47 15: R\$ 9,67
30: R\$ 9,87 45: R\$ 10,06 60: R\$ 10,26
13 cm



ALFABETO EVA 13CM LETRA Ç VERDE 10X1
Código: 38793 Fábrica: BRASILPAPERS Unidade: PT/10 F4

UN: R\$ 0,95 AV: R\$ 9,47 15: R\$ 9,67
30: R\$ 9,87 45: R\$ 10,06 60: R\$ 10,26
13 cm

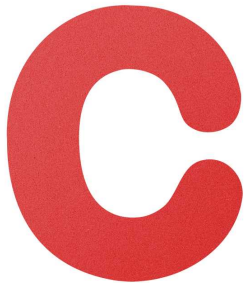

ALFABETO EVA 13CM LETRA C VERMELHO 10X1
Código: 38796 Fábrica: BRASILPAPERS Unidade: PT/10 F4

UN: R\$ 0,95 AV: R\$ 9,47 15: R\$ 9,67
30: R\$ 9,87 45: R\$ 10,06 60: R\$ 10,26
13 cm



ALFABETO EVA 13CM LETRA D AMARELO 10X1
Código: 38624 Fábrica: BRASILPAPERS Unidade: PT/10 F4

UN: R\$ 0,95 AV: R\$ 9,47 15: R\$ 9,67
30: R\$ 9,87 45: R\$ 10,06 60: R\$ 10,26
13 cm



ALFABETO EVA 13CM LETRA D AZUL 10X1
Código: 38740 Fábrica: BRASILPAPERS Unidade: PT/10 F4

UN: R\$ 0,95 AV: R\$ 9,47 15: R\$ 9,67
30: R\$ 9,87 45: R\$ 10,06 60: R\$ 10,26
13 cm

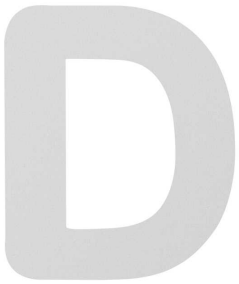

ALFABETO EVA 13CM LETRA D BRANCO 10X1
Código: 38713 Fábrica: BRASILPAPERS Unidade: PT/10 F4

UN: R\$ 0,95 AV: R\$ 9,47 15: R\$ 9,67
30: R\$ 9,87 45: R\$ 10,06 60: R\$ 10,26
13 cm

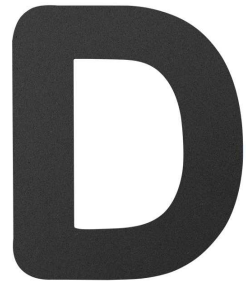

ALFABETO EVA 13CM LETRA D PRETO 10X1
Código: 38636 Fábrica: BRASILPAPERS Unidade: PT/10 F4

UN: R\$ 0,95 AV: R\$ 9,47 15: R\$ 9,67
30: R\$ 9,87 45: R\$ 10,06 60: R\$ 10,26
13 cm



ALFABETO EVA 13CM LETRA D ROSA 10X1
Código: 38599 Fábrica: BRASILPAPERS Unidade: PT/10 F4

UN: R\$ 0,95 AV: R\$ 9,47 15: R\$ 9,67
30: R\$ 9,87 45: R\$ 10,06 60: R\$ 10,26
13 cm



ALFABETO EVA 13CM LETRA D VERDE 10X1
Código: 38770 Fábrica: BRASILPAPERS Unidade: PT/10 F4

UN: R\$ 0,95 AV: R\$ 9,47 15: R\$ 9,67
30: R\$ 9,87 45: R\$ 10,06 60: R\$ 10,26
13cm



ALFABETO EVA 13CM LETRA D VERMELHO 10X1
Código: 38797 Fábrica: BRASILPAPERS Unidade: PT/10 F4

UN: R\$ 0,95 AV: R\$ 9,47 15: R\$ 9,67
30: R\$ 9,87 45: R\$ 10,06 60: R\$ 10,26
13cm



ALFABETO EVA 13CM LETRA E AMARELO 10X1
Código: 38683 Fábrica: BRASILPAPERS Unidade: PT/10 F4

UN: R\$ 0,95 AV: R\$ 9,47 15: R\$ 9,67
30: R\$ 9,87 45: R\$ 10,06 60: R\$ 10,26
13cm



ALFABETO EVA 13CM LETRA E AZUL 10X1
Código: 38741 Fábrica: BRASILPAPERS Unidade: PT/10 F4

UN: R\$ 0,95 AV: R\$ 9,47 15: R\$ 9,67
30: R\$ 9,87 45: R\$ 10,06 60: R\$ 10,26
13cm



ALFABETO EVA 13CM LETRA E BRANCO 10X1
Código: 38714 Fábrica: BRASILPAPERS Unidade: PT/10 F4

UN: R\$ 0,95 AV: R\$ 9,47 15: R\$ 9,67
30: R\$ 9,87 45: R\$ 10,06 60: R\$ 10,26
13cm

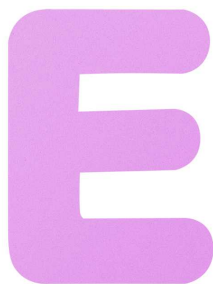

ALFABETO EVA 13CM LETRA E ROSA 10X1
Código: 38600 Fábrica: BRASILPAPERS Unidade: PT/10 F4

UN: R\$ 0,95 AV: R\$ 9,47 15: R\$ 9,67
30: R\$ 9,87 45: R\$ 10,06 60: R\$ 10,26
13cm

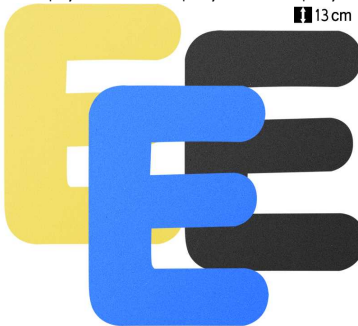

ALFABETO EVA 13CM LETRA E SORTIDO 10X1
Código: 38825 Fábrica: BRASILPAPERS Unidade: PT/10 F4

UN: R\$ 0,95 AV: R\$ 9,47 15: R\$ 9,67
30: R\$ 9,87 45: R\$ 10,06 60: R\$ 10,26
13cm



ALFABETO EVA 13CM LETRA E VERDE 10X1
Código: 38771 Fábrica: BRASILPAPERS Unidade: PT/10 F4

UN: R\$ 0,95 AV: R\$ 9,47 15: R\$ 9,67
30: R\$ 9,87 45: R\$ 10,06 60: R\$ 10,26
13cm



ALFABETO EVA 13CM LETRA E VERMELHO 10X1
Código: 38798 Fábrica: BRASILPAPERS Unidade: PT/10 F4

UN: R\$ 0,95 AV: R\$ 9,47 15: R\$ 9,67
30: R\$ 9,87 45: R\$ 10,06 60: R\$ 10,26
13cm



ALFABETO EVA 13CM LETRA F AMARELO 10X1
Código: 38625 Fábrica: BRASILPAPERS Unidade: PT/10 F4

UN: R\$ 0,95 AV: R\$ 9,47 15: R\$ 9,67
30: R\$ 9,87 45: R\$ 10,06 60: R\$ 10,26
13cm

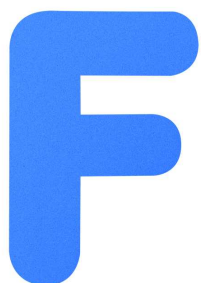

ALFABETO EVA 13CM LETRA F AZUL 10X1
Código: 38742 Fábrica: BRASILPAPERS Unidade: PT/10 F4

UN: R\$ 0,95 AV: R\$ 9,47 15: R\$ 9,67
30: R\$ 9,87 45: R\$ 10,06 60: R\$ 10,26
13cm



ALFABETO EVA 13CM LETRA F BRANCO 10X1
Código: 38715 Fábrica: BRASILPAPERS Unidade: PT/10 F4

UN: R\$ 0,95 AV: R\$ 9,47 15: R\$ 9,67
30: R\$ 9,87 45: R\$ 10,06 60: R\$ 10,26
13cm

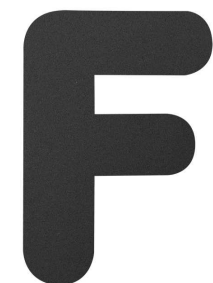

ALFABETO EVA 13CM LETRA F PRETO 10X1
Código: 38640 Fábrica: BRASILPAPERS Unidade: PT/10 F4

UN: R\$ 0,95 AV: R\$ 9,47 15: R\$ 9,67
30: R\$ 9,87 45: R\$ 10,06 60: R\$ 10,26
13cm

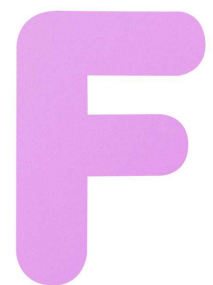

ALFABETO EVA 13CM LETRA F ROSA 10X1
Código: 38601 Fábrica: BRASILPAPERS Unidade: PT/10 F4

UN: R\$ 0,95 AV: R\$ 9,47 15: R\$ 9,67
30: R\$ 9,87 45: R\$ 10,06 60: R\$ 10,26
13cm



ALFABETO EVA 13CM LETRA F VERDE 10X1
Código: 38777 Fábrica: BRASILPAPERS Unidade: PT/10 F4

UN: R\$ 0,95 AV: R\$ 9,47 15: R\$ 9,67
30: R\$ 9,87 45: R\$ 10,06 60: R\$ 10,26
13cm

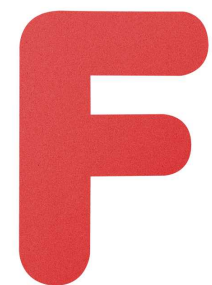

ALFABETO EVA 13CM LETRA F VERMELHO 10X1
Código: 38799 Fábrica: BRASILPAPERS Unidade: PT/10 F4

UN: R\$ 0,95 AV: R\$ 9,47 15: R\$ 9,67
30: R\$ 9,87 45: R\$ 10,06 60: R\$ 10,26
13cm



ALFABETO EVA 13CM LETRA G AMARELO 10X1
Código: 38626 Fábrica: BRASILPAPERS Unidade: PT/10 F4

UN: R\$ 0,95 AV: R\$ 9,47 15: R\$ 9,67
30: R\$ 9,87 45: R\$ 10,06 60: R\$ 10,26
13 cm



ALFABETO EVA 13CM LETRA G AZUL 10X1
Código: 38743 Fábrica: BRASILPAPERS Unidade: PT/10 F4

UN: R\$ 0,95 AV: R\$ 9,47 15: R\$ 9,67
30: R\$ 9,87 45: R\$ 10,06 60: R\$ 10,26
13 cm



ALFABETO EVA 13CM LETRA G BRANCO 10X1
Código: 38716 Fábrica: BRASILPAPERS Unidade: PT/10 F4

UN: R\$ 0,95 AV: R\$ 9,47 15: R\$ 9,67
30: R\$ 9,87 45: R\$ 10,06 60: R\$ 10,26
13 cm



ALFABETO EVA 13CM LETRA G PRETO 10X1
Código: 38641 Fábrica: BRASILPAPERS Unidade: PT/10 F4

UN: R\$ 0,95 AV: R\$ 9,47 15: R\$ 9,67
30: R\$ 9,87 45: R\$ 10,06 60: R\$ 10,26
13 cm



ALFABETO EVA 13CM LETRA G ROSA 10X1
Código: 38602 Fábrica: BRASILPAPERS Unidade: PT/10 F4

UN: R\$ 0,95 AV: R\$ 9,47 15: R\$ 9,67
30: R\$ 9,87 45: R\$ 10,06 60: R\$ 10,26
13 cm



ALFABETO EVA 13CM LETRA G VERDE 10X1
Código: 38772 Fábrica: BRASILPAPERS Unidade: PT/10 F4

UN: R\$ 0,95 AV: R\$ 9,47 15: R\$ 9,67
30: R\$ 9,87 45: R\$ 10,06 60: R\$ 10,26
13 cm



ALFABETO EVA 13CM LETRA G VERMELHO 10X1
Código: 38800 Fábrica: BRASILPAPERS Unidade: PT/10 F4

UN: R\$ 0,95 AV: R\$ 9,47 15: R\$ 9,67
30: R\$ 9,87 45: R\$ 10,06 60: R\$ 10,26
13 cm



ALFABETO EVA 13CM LETRA H AMARELO 10X1
Código: 38684 Fábrica: BRASILPAPERS Unidade: PT/10 F4

UN: R\$ 0,95 AV: R\$ 9,47 15: R\$ 9,67
30: R\$ 9,87 45: R\$ 10,06 60: R\$ 10,26
13 cm



ALFABETO EVA 13CM LETRA H AZUL 10X1
Código: 38744 Fábrica: BRASILPAPERS Unidade: PT/10 F4

UN: R\$ 0,95 AV: R\$ 9,47 15: R\$ 9,67
30: R\$ 9,87 45: R\$ 10,06 60: R\$ 10,26
13 cm



ALFABETO EVA 13CM LETRA H BRANCO 10X1
Código: 38717 Fábrica: BRASILPAPERS Unidade: PT/10 F4

UN: R\$ 0,95 AV: R\$ 9,47 15: R\$ 9,67
30: R\$ 9,87 45: R\$ 10,06 60: R\$ 10,26
13 cm

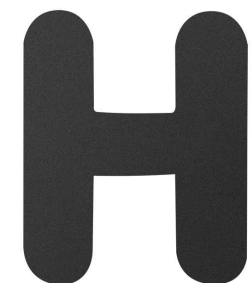

ALFABETO EVA 13CM LETRA H PRETO 10X1
Código: 38704 Fábrica: BRASILPAPERS Unidade: PT/10 F4

UN: R\$ 0,95 AV: R\$ 9,47 15: R\$ 9,67
30: R\$ 9,87 45: R\$ 10,06 60: R\$ 10,26
13 cm



ALFABETO EVA 13CM LETRA H ROSA 10X1
Código: 38603 Fábrica: BRASILPAPERS Unidade: PT/10 F4

UN: R\$ 0,95 AV: R\$ 9,47 15: R\$ 9,67
30: R\$ 9,87 45: R\$ 10,06 60: R\$ 10,26
13 cm



ALFABETO EVA 13CM LETRA H VERDE 10X1
Código: 38773 Fábrica: BRASILPAPERS Unidade: PT/10 F4

UN: R\$ 0,95 AV: R\$ 9,47 15: R\$ 9,67
30: R\$ 9,87 45: R\$ 10,06 60: R\$ 10,26
13 cm

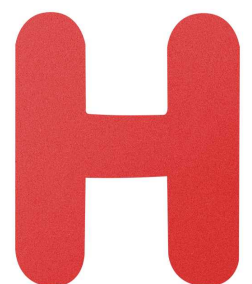

ALFABETO EVA 13CM LETRA H VERMELHO 10X1
Código: 38801 Fábrica: BRASILPAPERS Unidade: PT/10 F4

UN: R\$ 0,95 AV: R\$ 9,47 15: R\$ 9,67
30: R\$ 9,87 45: R\$ 10,06 60: R\$ 10,26
13 cm



ALFABETO EVA 13CM LETRA I AMARELO 10X1
Código: 38685 Fábrica: BRASILPAPERS Unidade: PT/10 F4

UN: R\$ 0,95 AV: R\$ 9,47 15: R\$ 9,67
30: R\$ 9,87 45: R\$ 10,06 60: R\$ 10,26
13 cm



ALFABETO EVA 13CM LETRA I AZUL 10X1
Código: 38745 Fábrica: BRASILPAPERS Unidade: PT/10 F4

UN: R\$ 0,95 AV: R\$ 9,47 15: R\$ 9,67
30: R\$ 9,87 45: R\$ 10,06 60: R\$ 10,26
13 cm



ALFABETO EVA 13CM LETRA I BRANCO 10X1
Código: 38718 Fábrica: BRASILPAPERS Unidade: PT/10 F4

UN: R\$ 0,95 AV: R\$ 9,47 15: R\$ 9,67
30: R\$ 9,87 45: R\$ 10,06 60: R\$ 10,26

13 cm



ALFABETO EVA 13CM LETRA I PRETO 10X1

Código: 38637 Fábrica: BRASILPAPERS Unidade: PT/10 F4

UN: R\$ 0,95 AV: R\$ 9,47 15: R\$ 9,67
30: R\$ 9,87 45: R\$ 10,06 60: R\$ 10,26

13 cm



ALFABETO EVA 13CM LETRA I ROSA 10X1

Código: 38604 Fábrica: BRASILPAPERS Unidade: PT/10 F4

UN: R\$ 0,95 AV: R\$ 9,47 15: R\$ 9,67
30: R\$ 9,87 45: R\$ 10,06 60: R\$ 10,26

13 cm



ALFABETO EVA 13CM LETRA I SORTIDO 10X1

Código: 38829 Fábrica: BRASILPAPERS Unidade: PT/10 F4

UN: R\$ 0,95 AV: R\$ 9,47 15: R\$ 9,67
30: R\$ 9,87 45: R\$ 10,06 60: R\$ 10,26

13 cm



ALFABETO EVA 13CM LETRA I VERDE 10X1

Código: 38774 Fábrica: BRASILPAPERS Unidade: PT/10 F4

UN: R\$ 0,95 AV: R\$ 9,47 15: R\$ 9,67
30: R\$ 9,87 45: R\$ 10,06 60: R\$ 10,26

13 cm



ALFABETO EVA 13CM LETRA I VERMELHO 10X1

Código: 38806 Fábrica: BRASILPAPERS Unidade: PT/10 F4

UN: R\$ 0,95 AV: R\$ 9,47 15: R\$ 9,67
30: R\$ 9,87 45: R\$ 10,06 60: R\$ 10,26

13 cm



ALFABETO EVA 13CM LETRA J AMARELO 10X1

Código: 38627 Fábrica: BRASILPAPERS Unidade: PT/10 F4

UN: R\$ 0,95 AV: R\$ 9,47 15: R\$ 9,67
30: R\$ 9,87 45: R\$ 10,06 60: R\$ 10,26

13 cm

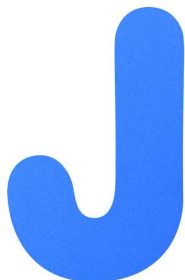

ALFABETO EVA 13CM LETRA J AZUL 10X1

Código: 38746 Fábrica: BRASILPAPERS Unidade: PT/10 F4

UN: R\$ 0,95 AV: R\$ 9,47 15: R\$ 9,67
30: R\$ 9,87 45: R\$ 10,06 60: R\$ 10,26

13 cm



ALFABETO EVA 13CM LETRA J BRANCO 10X1

Código: 38719 Fábrica: BRASILPAPERS Unidade: PT/10 F4

UN: R\$ 0,95 AV: R\$ 9,47 15: R\$ 9,67
30: R\$ 9,87 45: R\$ 10,06 60: R\$ 10,26

13 cm

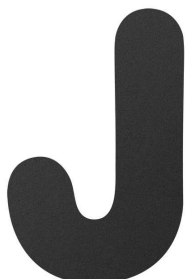

ALFABETO EVA 13CM LETRA J PRETO 10X1

Código: 38642 Fábrica: BRASILPAPERS Unidade: PT/10 F4

UN: R\$ 0,95 AV: R\$ 9,47 15: R\$ 9,67
30: R\$ 9,87 45: R\$ 10,06 60: R\$ 10,26

13 cm

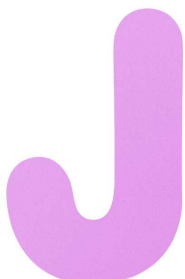

ALFABETO EVA 13CM LETRA J ROSA 10X1

Código: 38605 Fábrica: BRASILPAPERS Unidade: PT/10 F4

UN: R\$ 0,95 AV: R\$ 9,47 15: R\$ 9,67
30: R\$ 9,87 45: R\$ 10,06 60: R\$ 10,26

13 cm

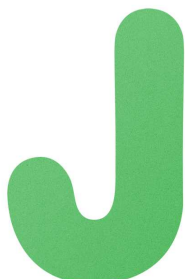

ALFABETO EVA 13CM LETRA J VERDE 10X1

Código: 38775 Fábrica: BRASILPAPERS Unidade: PT/10 F4

UN: R\$ 0,95 AV: R\$ 9,47 15: R\$ 9,67
30: R\$ 9,87 45: R\$ 10,06 60: R\$ 10,26

13 cm



ALFABETO EVA 13CM LETRA J VERMELHO 10X1

Código: 38802 Fábrica: BRASILPAPERS Unidade: PT/10 F4

UN: R\$ 0,95 AV: R\$ 9,47 15: R\$ 9,67
30: R\$ 9,87 45: R\$ 10,06 60: R\$ 10,26

13 cm

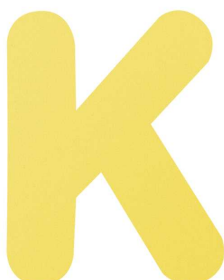

ALFABETO EVA 13CM LETRA K AMARELO 10X1

Código: 38686 Fábrica: BRASILPAPERS Unidade: PT/10 F4

UN: R\$ 0,95 AV: R\$ 9,47 15: R\$ 9,67
30: R\$ 9,87 45: R\$ 10,06 60: R\$ 10,26

13 cm

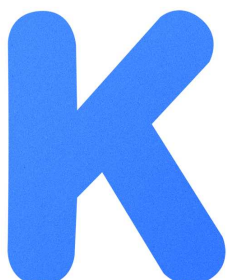

ALFABETO EVA 13CM LETRA K AZUL 10X1

Código: 38747 Fábrica: BRASILPAPERS Unidade: PT/10 F4

UN: R\$ 0,95 AV: R\$ 9,47 15: R\$ 9,67
30: R\$ 9,87 45: R\$ 10,06 60: R\$ 10,26

13 cm

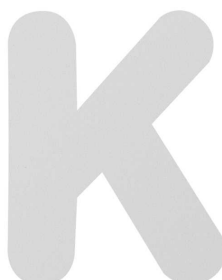

ALFABETO EVA 13CM LETRA K BRANCO 10X1

Código: 38720 Fábrica: BRASILPAPERS Unidade: PT/10 F4

UN: R\$ 0,95 AV: R\$ 9,47 15: R\$ 9,67
30: R\$ 9,87 45: R\$ 10,06 60: R\$ 10,26

13 cm

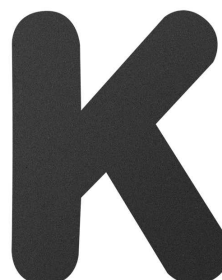

ALFABETO EVA 13CM LETRA K PRETO 10X1

Código: 38698 Fábrica: BRASILPAPERS Unidade: PT/10 F4

UN: R\$ 0,95 AV: R\$ 9,47 15: R\$ 9,67
30: R\$ 9,87 45: R\$ 10,06 60: R\$ 10,26
13 cm



ALFABETO EVA 13CM LETRA K ROSA 10X1
Código: 38606 Fábrica: BRASILPAPERS Unidade: PT/10 F4

UN: R\$ 0,95 AV: R\$ 9,47 15: R\$ 9,67
30: R\$ 9,87 45: R\$ 10,06 60: R\$ 10,26
13 cm



ALFABETO EVA 13CM LETRA K SORTIDO 10X1
Código: 38831 Fábrica: BRASILPAPERS Unidade: PT/10 F4

UN: R\$ 0,95 AV: R\$ 9,47 15: R\$ 9,67
30: R\$ 9,87 45: R\$ 10,06 60: R\$ 10,26
13 cm

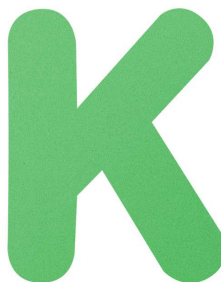

ALFABETO EVA 13CM LETRA K VERDE 10X1
Código: 38776 Fábrica: BRASILPAPERS Unidade: PT/10 F4

UN: R\$ 0,95 AV: R\$ 9,47 15: R\$ 9,67
30: R\$ 9,87 45: R\$ 10,06 60: R\$ 10,26
13 cm



ALFABETO EVA 13CM LETRA K VERMELHO 10X1
Código: 38803 Fábrica: BRASILPAPERS Unidade: PT/10 F4

UN: R\$ 0,95 AV: R\$ 9,47 15: R\$ 9,67
30: R\$ 9,87 45: R\$ 10,06 60: R\$ 10,26
13 cm

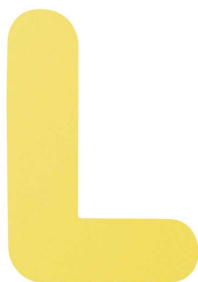

ALFABETO EVA 13CM LETRA L AMARELO 10X1
Código: 38628 Fábrica: BRASILPAPERS Unidade: PT/10 F4

UN: R\$ 0,95 AV: R\$ 9,47 15: R\$ 9,67
30: R\$ 9,87 45: R\$ 10,06 60: R\$ 10,26
13 cm



ALFABETO EVA 13CM LETRA L AZUL 10X1
Código: 38748 Fábrica: BRASILPAPERS Unidade: PT/10 F4

UN: R\$ 0,95 AV: R\$ 9,47 15: R\$ 9,67
30: R\$ 9,87 45: R\$ 10,06 60: R\$ 10,26
13 cm

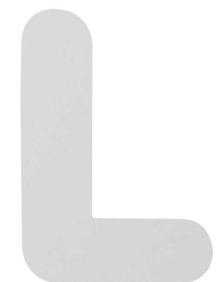

ALFABETO EVA 13CM LETRA L BRANCO 10X1
Código: 38721 Fábrica: BRASILPAPERS Unidade: PT/10 F4

UN: R\$ 0,95 AV: R\$ 9,47 15: R\$ 9,67
30: R\$ 9,87 45: R\$ 10,06 60: R\$ 10,26
13 cm



ALFABETO EVA 13CM LETRA L PRETO 10X1
Código: 38643 Fábrica: BRASILPAPERS Unidade: PT/10 F4

UN: R\$ 0,95 AV: R\$ 9,47 15: R\$ 9,67
30: R\$ 9,87 45: R\$ 10,06 60: R\$ 10,26
13 cm

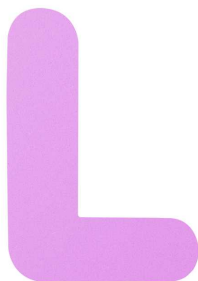

ALFABETO EVA 13CM LETRA L ROSA 10X1
Código: 38607 Fábrica: BRASILPAPERS Unidade: PT/10 F4

UN: R\$ 0,95 AV: R\$ 9,47 15: R\$ 9,67
30: R\$ 9,87 45: R\$ 10,06 60: R\$ 10,26
13 cm

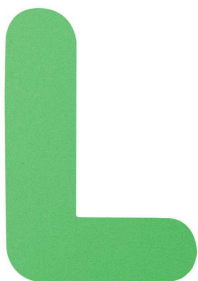

ALFABETO EVA 13CM LETRA L VERDE 10X1
Código: 38778 Fábrica: BRASILPAPERS Unidade: PT/10 F4

UN: R\$ 0,95 AV: R\$ 9,47 15: R\$ 9,67
30: R\$ 9,87 45: R\$ 10,06 60: R\$ 10,26
13 cm

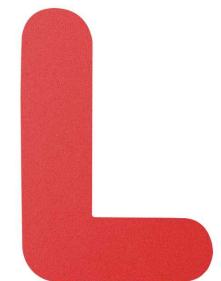

ALFABETO EVA 13CM LETRA L VERMELHO 10X1
Código: 38804 Fábrica: BRASILPAPERS Unidade: PT/10 F4

UN: R\$ 0,95 AV: R\$ 9,47 15: R\$ 9,67
30: R\$ 9,87 45: R\$ 10,06 60: R\$ 10,26
13 cm

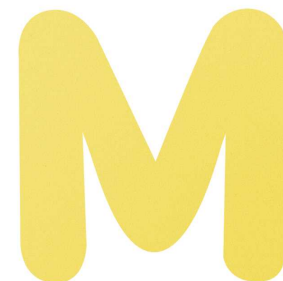

ALFABETO EVA 13CM LETRA M AMARELO 10X1
Código: 38629 Fábrica: BRASILPAPERS Unidade: PT/10 F4

UN: R\$ 0,95 AV: R\$ 9,47 15: R\$ 9,67
30: R\$ 9,87 45: R\$ 10,06 60: R\$ 10,26
13 cm



ALFABETO EVA 13CM LETRA M AZUL 10X1
Código: 38749 Fábrica: BRASILPAPERS Unidade: PT/10 F4

UN: R\$ 0,95 AV: R\$ 9,47 15: R\$ 9,67
30: R\$ 9,87 45: R\$ 10,06 60: R\$ 10,26
13 cm



ALFABETO EVA 13CM LETRA M BRANCO 10X1
Código: 38722 Fábrica: BRASILPAPERS Unidade: PT/10 F4

UN: R\$ 0,95 AV: R\$ 9,47 15: R\$ 9,67
30: R\$ 9,87 45: R\$ 10,06 60: R\$ 10,26
13 cm



ALFABETO EVA 13CM LETRA M PRETO 10X1
Código: 38638 Fábrica: BRASILPAPERS Unidade: PT/10 F4

UN: R\$ 0,95 AV: R\$ 9,47 15: R\$ 9,67
30: R\$ 9,87 45: R\$ 10,06 60: R\$ 10,26
13 cm



ALFABETO EVA 13CM LETRA M ROSA 10X1
Código: 38608 Fábrica: BRASILPAPERS Unidade: PT/10 F4

UN: R\$ 0,95 AV: R\$ 9,47 15: R\$ 9,67
30: R\$ 9,87 45: R\$ 10,06 60: R\$ 10,26
13 cm



ALFABETO EVA 13CM LETRA M VERDE 10X1

Código: 38779 Fábrica: BRASILPAPERS Unidade: PT/10 F4

UN: R\$ 0,95 AV: R\$ 9,47 15: R\$ 9,67
30: R\$ 9,87 45: R\$ 10,06 60: R\$ 10,26
13 cm

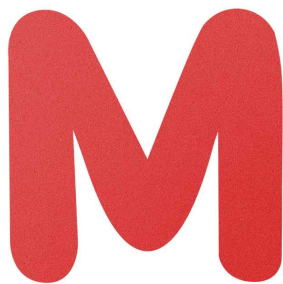

ALFABETO EVA 13CM LETRA M VERMELHO 10X1

Código: 38805 Fábrica: BRASILPAPERS Unidade: PT/10 F4

UN: R\$ 0,95 AV: R\$ 9,47 15: R\$ 9,67
30: R\$ 9,87 45: R\$ 10,06 60: R\$ 10,26
13 cm



ALFABETO EVA 13CM LETRA N AMARELO 10X1

Código: 38687 Fábrica: BRASILPAPERS Unidade: PT/10 F4

UN: R\$ 0,95 AV: R\$ 9,47 15: R\$ 9,67
30: R\$ 9,87 45: R\$ 10,06 60: R\$ 10,26
13 cm



ALFABETO EVA 13CM LETRA N AZUL 10X1

Código: 38750 Fábrica: BRASILPAPERS Unidade: PT/10 F4

UN: R\$ 0,95 AV: R\$ 9,47 15: R\$ 9,67
30: R\$ 9,87 45: R\$ 10,06 60: R\$ 10,26
13 cm



ALFABETO EVA 13CM LETRA N BRANCO 10X1

Código: 38723 Fábrica: BRASILPAPERS Unidade: PT/10 F4

UN: R\$ 0,95 AV: R\$ 9,47 15: R\$ 9,67
30: R\$ 9,87 45: R\$ 10,06 60: R\$ 10,26
13 cm



ALFABETO EVA 13CM LETRA N PRETO 10X1

Código: 38699 Fábrica: BRASILPAPERS Unidade: PT/10 F4

UN: R\$ 0,95 AV: R\$ 9,47 15: R\$ 9,67
30: R\$ 9,87 45: R\$ 10,06 60: R\$ 10,26
13 cm



ALFABETO EVA 13CM LETRA N ROSA 10X1

Código: 38609 Fábrica: BRASILPAPERS Unidade: PT/10 F4

UN: R\$ 0,95 AV: R\$ 9,47 15: R\$ 9,67
30: R\$ 9,87 45: R\$ 10,06 60: R\$ 10,26
13 cm

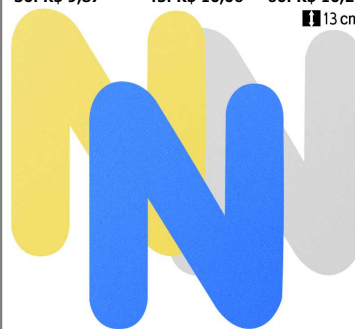

ALFABETO EVA 13CM LETRA N SORTIDO 10X1

Código: 38834 Fábrica: BRASILPAPERS Unidade: PT/10 F4

UN: R\$ 0,95 AV: R\$ 9,47 15: R\$ 9,67
30: R\$ 9,87 45: R\$ 10,06 60: R\$ 10,26
13 cm

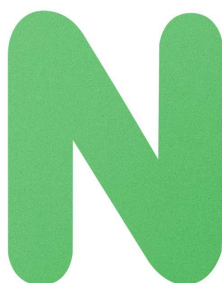

ALFABETO EVA 13CM LETRA N VERDE 10X1

Código: 38780 Fábrica: BRASILPAPERS Unidade: PT/10 F4

UN: R\$ 0,95 AV: R\$ 9,47 15: R\$ 9,67
30: R\$ 9,87 45: R\$ 10,06 60: R\$ 10,26
13 cm



ALFABETO EVA 13CM LETRA N VERMELHO 10X1

Código: 38807 Fábrica: BRASILPAPERS Unidade: PT/10 F4

UN: R\$ 0,95 AV: R\$ 9,47 15: R\$ 9,67
30: R\$ 9,87 45: R\$ 10,06 60: R\$ 10,26
13 cm

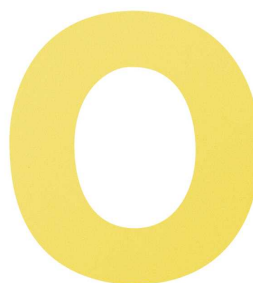

ALFABETO EVA 13CM LETRA O AMARELO 10X1

Código: 38688 Fábrica: BRASILPAPERS Unidade: PT/10 F4

UN: R\$ 0,95 AV: R\$ 9,47 15: R\$ 9,67
30: R\$ 9,87 45: R\$ 10,06 60: R\$ 10,26
13 cm

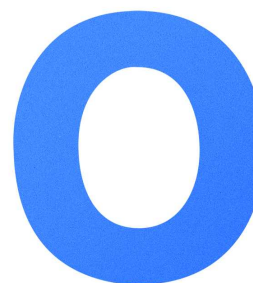

ALFABETO EVA 13CM LETRA O AZUL 10X1

Código: 38751 Fábrica: BRASILPAPERS Unidade: PT/10 F4

UN: R\$ 0,95 AV: R\$ 9,47 15: R\$ 9,67
30: R\$ 9,87 45: R\$ 10,06 60: R\$ 10,26
13 cm

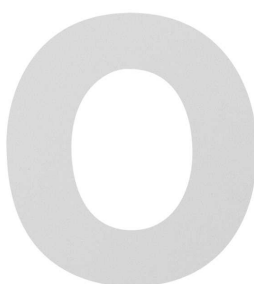

ALFABETO EVA 13CM LETRA O BRANCO 10X1

Código: 38724 Fábrica: BRASILPAPERS Unidade: PT/10 F4

UN: R\$ 0,95 AV: R\$ 9,47 15: R\$ 9,67
30: R\$ 9,87 45: R\$ 10,06 60: R\$ 10,26
13 cm

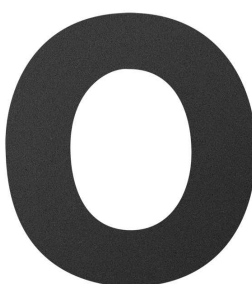

ALFABETO EVA 13CM LETRA O PRETO 10X1

Código: 38644 Fábrica: BRASILPAPERS Unidade: PT/10 F4

UN: R\$ 0,95 AV: R\$ 9,47 15: R\$ 9,67
30: R\$ 9,87 45: R\$ 10,06 60: R\$ 10,26
13 cm

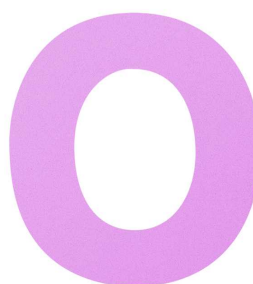

ALFABETO EVA 13CM LETRA O ROSA 10X1

Código: 38610 Fábrica: BRASILPAPERS Unidade: PT/10 F4

UN: R\$ 0,95 AV: R\$ 9,47 15: R\$ 9,67
30: R\$ 9,87 45: R\$ 10,06 60: R\$ 10,26
13 cm

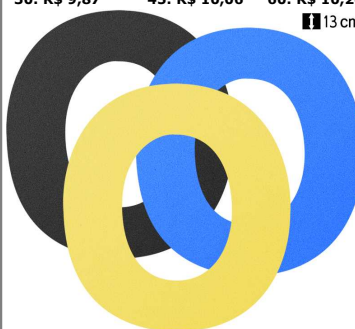

ALFABETO EVA 13CM LETRA O SORTIDO 10X1

Código: 38835 Fábrica: BRASILPAPERS Unidade: PT/10 F4

UN: R\$ 0,95 AV: R\$ 9,47 15: R\$ 9,67
30: R\$ 9,87 45: R\$ 10,06 60: R\$ 10,26
13 cm

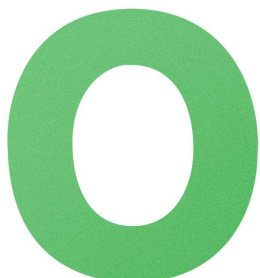

ALFABETO EVA 13CM LETRA O VERDE 10X1
Código: 38781 Fábrica: BRASILPAPERS Unidade: PT/10 F4

UN: R\$ 0,95 AV: R\$ 9,47 15: R\$ 9,67
30: R\$ 9,87 45: R\$ 10,06 60: R\$ 10,26
13 cm

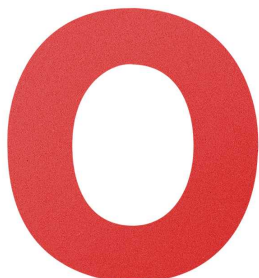

ALFABETO EVA 13CM LETRA O VERMELHO 10X1
Código: 38808 Fábrica: BRASILPAPERS Unidade: PT/10 F4

UN: R\$ 0,95 AV: R\$ 9,47 15: R\$ 9,67
30: R\$ 9,87 45: R\$ 10,06 60: R\$ 10,26
13 cm



ALFABETO EVA 13CM LETRA P AMARELO 10X1
Código: 38630 Fábrica: BRASILPAPERS Unidade: PT/10 F4

UN: R\$ 0,95 AV: R\$ 9,47 15: R\$ 9,67
30: R\$ 9,87 45: R\$ 10,06 60: R\$ 10,26
13 cm



ALFABETO EVA 13CM LETRA P AZUL 10X1
Código: 38752 Fábrica: BRASILPAPERS Unidade: PT/10 F4

UN: R\$ 0,95 AV: R\$ 9,47 15: R\$ 9,67
30: R\$ 9,87 45: R\$ 10,06 60: R\$ 10,26
13 cm



ALFABETO EVA 13CM LETRA P BRANCO 10X1
Código: 38725 Fábrica: BRASILPAPERS Unidade: PT/10 F4

UN: R\$ 0,95 AV: R\$ 9,47 15: R\$ 9,67
30: R\$ 9,87 45: R\$ 10,06 60: R\$ 10,26
13 cm

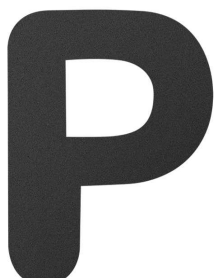

ALFABETO EVA 13CM LETRA P PRETO 10X1
Código: 38645 Fábrica: BRASILPAPERS Unidade: PT/10 F4

UN: R\$ 0,95 AV: R\$ 9,47 15: R\$ 9,67
30: R\$ 9,87 45: R\$ 10,06 60: R\$ 10,26
13 cm



ALFABETO EVA 13CM LETRA P ROSA 10X1
Código: 38611 Fábrica: BRASILPAPERS Unidade: PT/10 F4

UN: R\$ 0,95 AV: R\$ 9,47 15: R\$ 9,67
30: R\$ 9,87 45: R\$ 10,06 60: R\$ 10,26
13 cm



ALFABETO EVA 13CM LETRA P VERDE 10X1
Código: 38782 Fábrica: BRASILPAPERS Unidade: PT/10 F4

UN: R\$ 0,95 AV: R\$ 9,47 15: R\$ 9,67
30: R\$ 9,87 45: R\$ 10,06 60: R\$ 10,26
13 cm

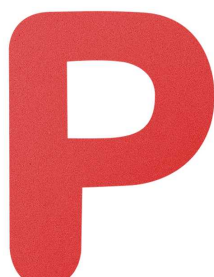

ALFABETO EVA 13CM LETRA P VERMELHO 10X1
Código: 38809 Fábrica: BRASILPAPERS Unidade: PT/10 F4

UN: R\$ 0,95 AV: R\$ 9,47 15: R\$ 9,67
30: R\$ 9,87 45: R\$ 10,06 60: R\$ 10,26
13 cm

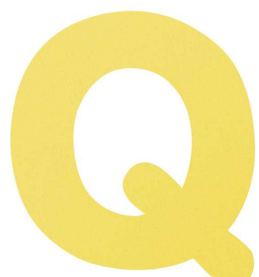

ALFABETO EVA 13CM LETRA Q AMARELO 10X1
Código: 38689 Fábrica: BRASILPAPERS Unidade: PT/10 F4

UN: R\$ 0,95 AV: R\$ 9,47 15: R\$ 9,67
30: R\$ 9,87 45: R\$ 10,06 60: R\$ 10,26
13 cm



ALFABETO EVA 13CM LETRA Q AZUL 10X1
Código: 38753 Fábrica: BRASILPAPERS Unidade: PT/10 F4

UN: R\$ 0,95 AV: R\$ 9,47 15: R\$ 9,67
30: R\$ 9,87 45: R\$ 10,06 60: R\$ 10,26
13 cm



ALFABETO EVA 13CM LETRA Q BRANCO 10X1
Código: 38726 Fábrica: BRASILPAPERS Unidade: PT/10 F4

UN: R\$ 0,95 AV: R\$ 9,47 15: R\$ 9,67
30: R\$ 9,87 45: R\$ 10,06 60: R\$ 10,26
13 cm

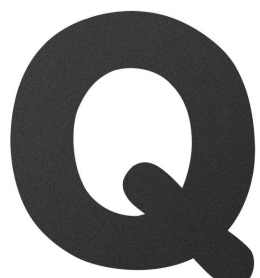

ALFABETO EVA 13CM LETRA Q PRETO 10X1
Código: 38706 Fábrica: BRASILPAPERS Unidade: PT/10 F4

UN: R\$ 0,95 AV: R\$ 9,47 15: R\$ 9,67
30: R\$ 9,87 45: R\$ 10,06 60: R\$ 10,26
13 cm

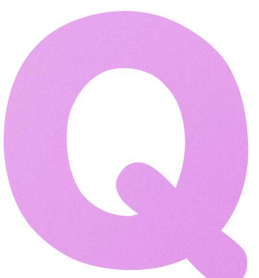

ALFABETO EVA 13CM LETRA Q ROSA 10X1
Código: 38612 Fábrica: BRASILPAPERS Unidade: PT/10 F4

UN: R\$ 0,95 AV: R\$ 9,47 15: R\$ 9,67
30: R\$ 9,87 45: R\$ 10,06 60: R\$ 10,26
13 cm



ALFABETO EVA 13CM LETRA Q VERDE 10X1
Código: 38783 Fábrica: BRASILPAPERS Unidade: PT/10 F4

UN: R\$ 0,95 AV: R\$ 9,47 15: R\$ 9,67
30: R\$ 9,87 45: R\$ 10,06 60: R\$ 10,26
13 cm

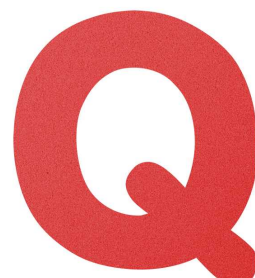

ALFABETO EVA 13CM LETRA Q VERMELHO 10X1
Código: 38810 Fábrica: BRASILPAPERS Unidade: PT/10 F4

UN: R\$ 0,95 AV: R\$ 9,47 15: R\$ 9,67
30: R\$ 9,87 45: R\$ 10,06 60: R\$ 10,26
13 cm

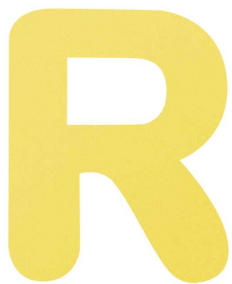

ALFABETO EVA 13CM LETRA R AMARELO 10X1
Código: 38631 Fábrica: BRASILPAPERS Unidade: PT/10 F4

UN: R\$ 0,95 AV: R\$ 9,47 15: R\$ 9,67
30: R\$ 9,87 45: R\$ 10,06 60: R\$ 10,26
13 cm



ALFABETO EVA 13CM LETRA R AZUL 10X1
Código: 38754 Fábrica: BRASILPAPERS Unidade: PT/10 F4

UN: R\$ 0,95 AV: R\$ 9,47 15: R\$ 9,67
30: R\$ 9,87 45: R\$ 10,06 60: R\$ 10,26
13 cm

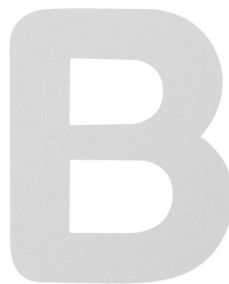

ALFABETO EVA 13CM LETRA R BRANCO 10X1
Código: 38727 Fábrica: BRASILPAPERS Unidade: PT/10 F4

UN: R\$ 0,95 AV: R\$ 9,47 15: R\$ 9,67
30: R\$ 9,87 45: R\$ 10,06 60: R\$ 10,26
13 cm



ALFABETO EVA 13CM LETRA R PRETO 10X1
Código: 38646 Fábrica: BRASILPAPERS Unidade: PT/10 F4

UN: R\$ 0,95 AV: R\$ 9,47 15: R\$ 9,67
30: R\$ 9,87 45: R\$ 10,06 60: R\$ 10,26
13 cm



ALFABETO EVA 13CM LETRA R ROSA 10X1
Código: 38613 Fábrica: BRASILPAPERS Unidade: PT/10 F4

UN: R\$ 0,95 AV: R\$ 9,47 15: R\$ 9,67
30: R\$ 9,87 45: R\$ 10,06 60: R\$ 10,26
13 cm



ALFABETO EVA 13CM LETRA R VERDE 10X1
Código: 38784 Fábrica: BRASILPAPERS Unidade: PT/10 F4

UN: R\$ 0,95 AV: R\$ 9,47 15: R\$ 9,67
30: R\$ 9,87 45: R\$ 10,06 60: R\$ 10,26
13 cm



ALFABETO EVA 13CM LETRA R VERMELHO 10X1
Código: 38811 Fábrica: BRASILPAPERS Unidade: PT/10 F4

UN: R\$ 0,95 AV: R\$ 9,47 15: R\$ 9,67
30: R\$ 9,87 45: R\$ 10,06 60: R\$ 10,26
13 cm



ALFABETO EVA 13CM LETRA S AMARELO 10X1
Código: 38632 Fábrica: BRASILPAPERS Unidade: PT/10 F4

UN: R\$ 0,95 AV: R\$ 9,47 15: R\$ 9,67
30: R\$ 9,87 45: R\$ 10,06 60: R\$ 10,26
13 cm

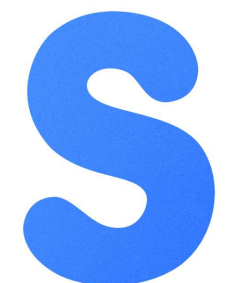

ALFABETO EVA 13CM LETRA S AZUL 10X1
Código: 38758 Fábrica: BRASILPAPERS Unidade: PT/10 F4

UN: R\$ 0,95 AV: R\$ 9,47 15: R\$ 9,67
30: R\$ 9,87 45: R\$ 10,06 60: R\$ 10,26
13 cm



ALFABETO EVA 13CM LETRA S BRANCO 10X1
Código: 38728 Fábrica: BRASILPAPERS Unidade: PT/10 F4

UN: R\$ 0,95 AV: R\$ 9,47 15: R\$ 9,67
30: R\$ 9,87 45: R\$ 10,06 60: R\$ 10,26
13 cm



ALFABETO EVA 13CM LETRA S PRETO 10X1
Código: 38647 Fábrica: BRASILPAPERS Unidade: PT/10 F4

UN: R\$ 0,95 AV: R\$ 9,47 15: R\$ 9,67
30: R\$ 9,87 45: R\$ 10,06 60: R\$ 10,26
13 cm



ALFABETO EVA 13CM LETRA S ROSA 10X1
Código: 38614 Fábrica: BRASILPAPERS Unidade: PT/10 F4

UN: R\$ 0,95 AV: R\$ 9,47 15: R\$ 9,67
30: R\$ 9,87 45: R\$ 10,06 60: R\$ 10,26
13 cm



ALFABETO EVA 13CM LETRA S VERDE 10X1
Código: 38785 Fábrica: BRASILPAPERS Unidade: PT/10 F4

UN: R\$ 0,95 AV: R\$ 9,47 15: R\$ 9,67
30: R\$ 9,87 45: R\$ 10,06 60: R\$ 10,26
13 cm



ALFABETO EVA 13CM LETRA S VERMELHO 10X1
Código: 38812 Fábrica: BRASILPAPERS Unidade: PT/10 F4

UN: R\$ 0,95 AV: R\$ 9,47 15: R\$ 9,67
30: R\$ 9,87 45: R\$ 10,06 60: R\$ 10,26
13 cm

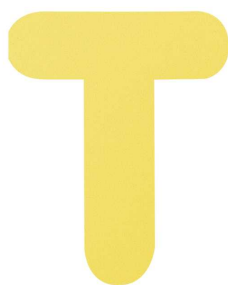

ALFABETO EVA 13CM LETRA T AMARELO 10X1
Código: 38690 Fábrica: BRASILPAPERS Unidade: PT/10 F4

UN: R\$ 0,95 AV: R\$ 9,47 15: R\$ 9,67
30: R\$ 9,87 45: R\$ 10,06 60: R\$ 10,26
13 cm

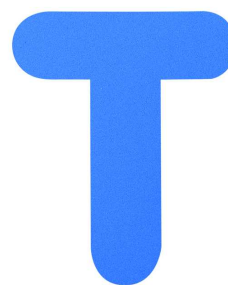

ALFABETO EVA 13CM LETRA T AZUL 10X1
Código: 38759 Fábrica: BRASILPAPERS Unidade: PT/10 F4

UN: R\$ 0,95 AV: R\$ 9,47 15: R\$ 9,67
30: R\$ 9,87 45: R\$ 10,06 60: R\$ 10,26
13 cm

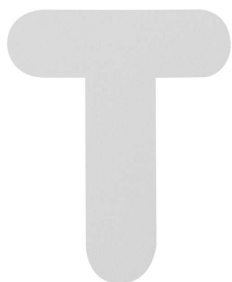

ALFABETO EVA 13CM LETRA T BRANCO 10X1
Código: 38729 Fábrica: BRASILPAPERS Unidade: PT/10 F4

UN: R\$ 0,95 AV: R\$ 9,47 15: R\$ 9,67
30: R\$ 9,87 45: R\$ 10,06 60: R\$ 10,26
13 cm

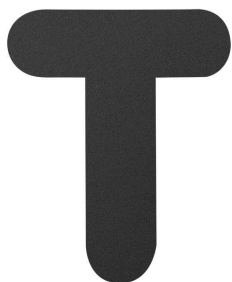

ALFABETO EVA 13CM LETRA T PRETO 10X1
Código: 38703 Fábrica: BRASILPAPERS Unidade: PT/10 F4

UN: R\$ 0,95 AV: R\$ 9,47 15: R\$ 9,67
30: R\$ 9,87 45: R\$ 10,06 60: R\$ 10,26
13 cm



ALFABETO EVA 13CM LETRA T ROSA 10X1
Código: 38615 Fábrica: BRASILPAPERS Unidade: PT/10 F4

UN: R\$ 0,95 AV: R\$ 9,47 15: R\$ 9,67
30: R\$ 9,87 45: R\$ 10,06 60: R\$ 10,26
13 cm

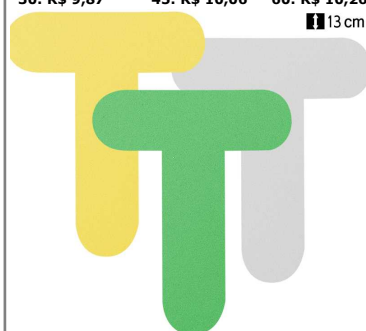

ALFABETO EVA 13CM LETRA T SORTIDO 10X1
Código: 38840 Fábrica: BRASILPAPERS Unidade: PT/10 F4

UN: R\$ 0,95 AV: R\$ 9,47 15: R\$ 9,67
30: R\$ 9,87 45: R\$ 10,06 60: R\$ 10,26
13 cm

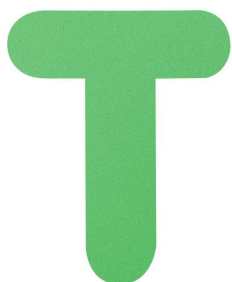

ALFABETO EVA 13CM LETRA T VERDE 10X1
Código: 38786 Fábrica: BRASILPAPERS Unidade: PT/10 F4

UN: R\$ 0,95 AV: R\$ 9,47 15: R\$ 9,67
30: R\$ 9,87 45: R\$ 10,06 60: R\$ 10,26
13 cm

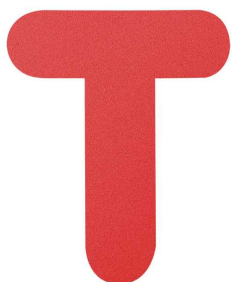

ALFABETO EVA 13CM LETRA T VERMELHO 10X1
Código: 38813 Fábrica: BRASILPAPERS Unidade: PT/10 F4

UN: R\$ 0,95 AV: R\$ 9,47 15: R\$ 9,67
30: R\$ 9,87 45: R\$ 10,06 60: R\$ 10,26
13 cm



ALFABETO EVA 13CM LETRA U AMARELO 10X1
Código: 38691 Fábrica: BRASILPAPERS Unidade: PT/10 F4

UN: R\$ 0,95 AV: R\$ 9,47 15: R\$ 9,67
30: R\$ 9,87 45: R\$ 10,06 60: R\$ 10,26
13 cm

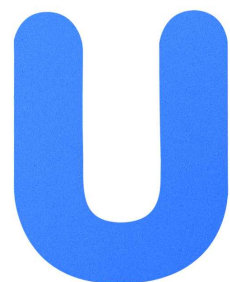

ALFABETO EVA 13CM LETRA U AZUL 10X1
Código: 38760 Fábrica: BRASILPAPERS Unidade: PT/10 F4

UN: R\$ 0,95 AV: R\$ 9,47 15: R\$ 9,67
30: R\$ 9,87 45: R\$ 10,06 60: R\$ 10,26
13 cm

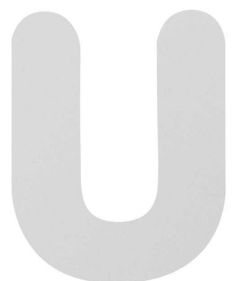

ALFABETO EVA 13CM LETRA U BRANCO 10X1
Código: 38730 Fábrica: BRASILPAPERS Unidade: PT/10 F4

UN: R\$ 0,95 AV: R\$ 9,47 15: R\$ 9,67
30: R\$ 9,87 45: R\$ 10,06 60: R\$ 10,26
13 cm

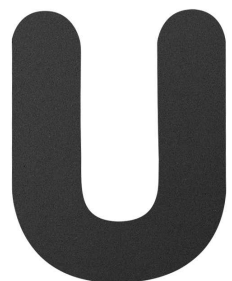

ALFABETO EVA 13CM LETRA U PRETO 10X1
Código: 38648 Fábrica: BRASILPAPERS Unidade: PT/10 F4

UN: R\$ 0,95 AV: R\$ 9,47 15: R\$ 9,67
30: R\$ 9,87 45: R\$ 10,06 60: R\$ 10,26
13 cm



ALFABETO EVA 13CM LETRA U ROSA 10X1
Código: 38616 Fábrica: BRASILPAPERS Unidade: PT/10 F4

UN: R\$ 0,95 AV: R\$ 9,47 15: R\$ 9,67
30: R\$ 9,87 45: R\$ 10,06 60: R\$ 10,26
13 cm

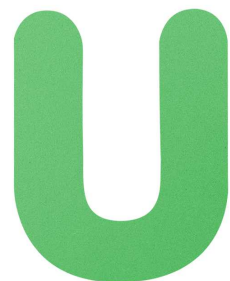

ALFABETO EVA 13CM LETRA U VERDE 10X1
Código: 38787 Fábrica: BRASILPAPERS Unidade: PT/10 F4

UN: R\$ 0,95 AV: R\$ 9,47 15: R\$ 9,67
30: R\$ 9,87 45: R\$ 10,06 60: R\$ 10,26
13 cm



ALFABETO EVA 13CM LETRA U VERMELHO 10X1
Código: 38814 Fábrica: BRASILPAPERS Unidade: PT/10 F4

UN: R\$ 0,95 AV: R\$ 9,47 15: R\$ 9,67
30: R\$ 9,87 45: R\$ 10,06 60: R\$ 10,26
13 cm



ALFABETO EVA 13CM LETRA V AMARELO 10X1
Código: 38692 Fábrica: BRASILPAPERS Unidade: PT/10 F4

UN: R\$ 0,95 AV: R\$ 9,47 15: R\$ 9,67
30: R\$ 9,87 45: R\$ 10,06 60: R\$ 10,26
13 cm



ALFABETO EVA 13CM LETRA V AZUL 10X1
Código: 38761 Fábrica: BRASILPAPERS Unidade: PT/10 F4

UN: R\$ 0,95 AV: R\$ 9,47 15: R\$ 9,67
30: R\$ 9,87 45: R\$ 10,06 60: R\$ 10,26
13 cm



ALFABETO EVA 13CM LETRA V BRANCO 10X1
Código: 38731 Fábrica: BRASILPAPERS Unidade: PT/10 F4

UN: R\$ 0,95 AV: R\$ 9,47 15: R\$ 9,67
30: R\$ 9,87 45: R\$ 10,06 60: R\$ 10,26
13 cm



ALFABETO EVA 13CM LETRA V PRETO 10X1
Código: 38707 Fábrica: BRASILPAPERS Unidade: PT/10 F4

UN: R\$ 0,95 AV: R\$ 9,47 15: R\$ 9,67
30: R\$ 9,87 45: R\$ 10,06 60: R\$ 10,26
13 cm



ALFABETO EVA 13CM LETRA V VERDE 10X1
Código: 38788 Fábrica: BRASILPAPERS Unidade: PT/10 F4

UN: R\$ 0,95 AV: R\$ 9,47 15: R\$ 9,67
30: R\$ 9,87 45: R\$ 10,06 60: R\$ 10,26
13 cm



ALFABETO EVA 13CM LETRA V VERMELHO 10X1
Código: 38815 Fábrica: BRASILPAPERS Unidade: PT/10 F4

UN: R\$ 0,95 AV: R\$ 9,47 15: R\$ 9,67
30: R\$ 9,87 45: R\$ 10,06 60: R\$ 10,26
13 cm



ALFABETO EVA 13CM LETRA W AMARELO 10X1
Código: 38693 Fábrica: BRASILPAPERS Unidade: PT/10 F4

UN: R\$ 0,95 AV: R\$ 9,47 15: R\$ 9,67
30: R\$ 9,87 45: R\$ 10,06 60: R\$ 10,26
13 cm



ALFABETO EVA 13CM LETRA W AZUL 10X1
Código: 38762 Fábrica: BRASILPAPERS Unidade: PT/10 F4

UN: R\$ 0,95 AV: R\$ 9,47 15: R\$ 9,67
30: R\$ 9,87 45: R\$ 10,06 60: R\$ 10,26
13 cm



ALFABETO EVA 13CM LETRA W BRANCO 10X1
Código: 38732 Fábrica: BRASILPAPERS Unidade: PT/10 F4

UN: R\$ 0,95 AV: R\$ 9,47 15: R\$ 9,67
30: R\$ 9,87 45: R\$ 10,06 60: R\$ 10,26
13 cm



ALFABETO EVA 13CM LETRA W PRETO 10X1
Código: 38708 Fábrica: BRASILPAPERS Unidade: PT/10 F4

UN: R\$ 0,95 AV: R\$ 9,47 15: R\$ 9,67
30: R\$ 9,87 45: R\$ 10,06 60: R\$ 10,26
13 cm



ALFABETO EVA 13CM LETRA W ROSA 10X1
Código: 38618 Fábrica: BRASILPAPERS Unidade: PT/10 F4

UN: R\$ 0,95 AV: R\$ 9,47 15: R\$ 9,67
30: R\$ 9,87 45: R\$ 10,06 60: R\$ 10,26
13 cm



ALFABETO EVA 13CM LETRA W VERDE 10X1
Código: 38792 Fábrica: BRASILPAPERS Unidade: PT/10 F4

UN: R\$ 0,95 AV: R\$ 9,47 15: R\$ 9,67
30: R\$ 9,87 45: R\$ 10,06 60: R\$ 10,26
13 cm



ALFABETO EVA 13CM LETRA X AMARELO 10X1
Código: 38694 Fábrica: BRASILPAPERS Unidade: PT/10 F4

UN: R\$ 0,95 AV: R\$ 9,47 15: R\$ 9,67
30: R\$ 9,87 45: R\$ 10,06 60: R\$ 10,26
13 cm



ALFABETO EVA 13CM LETRA X AZUL 10X1
Código: 38763 Fábrica: BRASILPAPERS Unidade: PT/10 F4

UN: R\$ 0,95 AV: R\$ 9,47 15: R\$ 9,67
30: R\$ 9,87 45: R\$ 10,06 60: R\$ 10,26
13 cm



ALFABETO EVA 13CM LETRA X BRANCO 10X1
Código: 38733 Fábrica: BRASILPAPERS Unidade: PT/10 F4

UN: R\$ 0,95 AV: R\$ 9,47 15: R\$ 9,67
30: R\$ 9,87 45: R\$ 10,06 60: R\$ 10,26
13 cm



ALFABETO EVA 13CM LETRA X PRETO 10X1
Código: 38700 Fábrica: BRASILPAPERS Unidade: PT/10 F4

UN: R\$ 0,95 AV: R\$ 9,47 15: R\$ 9,67
30: R\$ 9,87 45: R\$ 10,06 60: R\$ 10,26
13 cm



ALFABETO EVA 13CM LETRA X ROSA 10X1
Código: 38619 Fábrica: BRASILPAPERS Unidade: PT/10 F4

UN: R\$ 0,95 AV: R\$ 9,47 15: R\$ 9,67
30: R\$ 9,87 45: R\$ 10,06 60: R\$ 10,26
13 cm



ALFABETO EVA 13CM LETRA X VERDE 10X1
Código: 38789 Fábrica: BRASILPAPERS Unidade: PT/10 F4

UN: R\$ 0,95 AV: R\$ 9,47 15: R\$ 9,67
30: R\$ 9,87 45: R\$ 10,06 60: R\$ 10,26
13 cm



ALFABETO EVA 13CM LETRA X VERMELHO 10X1
Código: 38816 Fábrica: BRASILPAPERS Unidade: PT/10 F4

UN: R\$ 0,95 AV: R\$ 9,47 15: R\$ 9,67
30: R\$ 9,87 45: R\$ 10,06 60: R\$ 10,26
13 cm



ALFABETO EVA 13CM LETRA Y AMARELO 10X1
Código: 38695 Fábrica: BRASILPAPERS Unidade: PT/10 F4

UN: R\$ 0,95 AV: R\$ 9,47 15: R\$ 9,67
30: R\$ 9,87 45: R\$ 10,06 60: R\$ 10,26
13 cm



ALFABETO EVA 13CM LETRA Y AZUL 10X1
Código: 38764 Fábrica: BRASILPAPERS Unidade: PT/10 F4

UN: R\$ 0,95 AV: R\$ 9,47 15: R\$ 9,67
30: R\$ 9,87 45: R\$ 10,06 60: R\$ 10,26
13 cm



ALFABETO EVA 13CM LETRA Y BRANCO 10X1
Código: 38734 Fábrica: BRASILPAPERS Unidade: PT/10 F4

UN: R\$ 0,95 AV: R\$ 9,47 15: R\$ 9,67
30: R\$ 9,87 45: R\$ 10,06 60: R\$ 10,26
13 cm



ALFABETO EVA 13CM LETRA Y PRETO 10X1
Código: 38705 Fábrica: BRASILPAPERS Unidade: PT/10 F4

UN: R\$ 0,95 AV: R\$ 9,47 15: R\$ 9,67
30: R\$ 9,87 45: R\$ 10,06 60: R\$ 10,26
13 cm



ALFABETO EVA 13CM LETRA Y VERDE 10X1
Código: 38790 Fábrica: BRASILPAPERS Unidade: PT/10 F4

UN: R\$ 0,95 AV: R\$ 9,47 15: R\$ 9,67
30: R\$ 9,87 45: R\$ 10,06 60: R\$ 10,26
13 cm

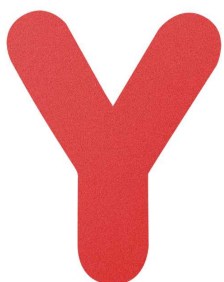

ALFABETO EVA 13CM LETRA Y VERMELHO 10X1
Código: 38819 Fábrica: BRASILPAPERS Unidade: PT/10 F4

UN: R\$ 0,95 AV: R\$ 9,47 15: R\$ 9,67
30: R\$ 9,87 45: R\$ 10,06 60: R\$ 10,26
13 cm



ALFABETO EVA 13CM LETRA Z AMARELO 10X1
Código: 38696 Fábrica: BRASILPAPERS Unidade: PT/10 F4

UN: R\$ 0,95 AV: R\$ 9,47 15: R\$ 9,67
30: R\$ 9,87 45: R\$ 10,06 60: R\$ 10,26
13 cm



ALFABETO EVA 13CM LETRA Z AZUL 10X1
Código: 38765 Fábrica: BRASILPAPERS Unidade: PT/10 F4

UN: R\$ 0,95 AV: R\$ 9,47 15: R\$ 9,67
30: R\$ 9,87 45: R\$ 10,06 60: R\$ 10,26
13 cm



ALFABETO EVA 13CM LETRA Z BRANCO 10X1
Código: 38735 Fábrica: BRASILPAPERS Unidade: PT/10 F4

UN: R\$ 0,95 AV: R\$ 9,47 15: R\$ 9,67
30: R\$ 9,87 45: R\$ 10,06 60: R\$ 10,26
13 cm



ALFABETO EVA 13CM LETRA Z PRETO 10X1
Código: 38701 Fábrica: BRASILPAPERS Unidade: PT/10 F4

UN: R\$ 0,95 AV: R\$ 9,47 15: R\$ 9,67
30: R\$ 9,87 45: R\$ 10,06 60: R\$ 10,26
13 cm



ALFABETO EVA 13CM LETRA Z ROSA 10X1
Código: 38621 Fábrica: BRASILPAPERS Unidade: PT/10 F4

UN: R\$ 0,95 AV: R\$ 9,47 15: R\$ 9,67
30: R\$ 9,87 45: R\$ 10,06 60: R\$ 10,26
13 cm



ALFABETO EVA 13CM LETRA Z SORTIDO 10X1
Código: 38846 Fábrica: BRASILPAPERS Unidade: PT/10 F4

UN: R\$ 0,95 AV: R\$ 9,47 15: R\$ 9,67
30: R\$ 9,87 45: R\$ 10,06 60: R\$ 10,26
13 cm



ALFABETO EVA 13CM LETRA Z VERDE 10X1
Código: 38791 Fábrica: BRASILPAPERS Unidade: PT/10 F4

UN: R\$ 0,95 AV: R\$ 9,47 15: R\$ 9,67
30: R\$ 9,87 45: R\$ 10,06 60: R\$ 10,26
13 cm



ALFABETO EVA 13CM LETRA Z VERMELHO 10X1
Código: 38817 Fábrica: BRASILPAPERS Unidade: PT/10 F4

UN: R\$ 7,31 AV: R\$ 7,31 15: R\$ 7,46
30: R\$ 7,61 45: R\$ 7,76 60: R\$ 7,92



ALMOFADA CARIMBO N3 S/TINTA 105X64MM 168
Código: 45069 Fábrica: CARBRINK Unidade: UN/1 F1 F4

UN: R\$ 6,78 AV: R\$ 6,78 15: R\$ 6,92
30: R\$ 7,06 45: R\$ 7,20 60: R\$ 7,34



ALMOFADA P/CARIMBO N2 PRETA ENTINTADA
Código: 41963 Fábrica: CARBRINK Unidade: UN/1 F1 F4

UN: R\$ 8,59 AV: R\$ 8,59 15: R\$ 8,77
30: R\$ 8,94 45: R\$ 9,12 60: R\$ 9,30



ALMOFADA P/CARIMBO N3 AZUL ENTINTADA
Código: 10460 Fábrica: CARBRINK Unidade: UN/1
F1 F4

UN: R\$ 7,66 AV: R\$ 7,66 15: R\$ 7,82
30: R\$ 7,97 45: R\$ 8,13 60: R\$ 8,30



ALMOFADA P/CARIMBO N3 AZUL TPA METAL 772
Código: 23964 Fábrica: MASTERPRINT Unidade: UN/1
F1 F4

UN: R\$ 8,59 AV: R\$ 8,59 15: R\$ 8,77
30: R\$ 8,94 45: R\$ 9,12 60: R\$ 9,30



ALMOFADA P/CARIMBO N3 PRETA ENTINTADA
Código: 15529 Fábrica: CARBRINK Unidade: UN/1
F1 F4

UN: R\$ 7,66 AV: R\$ 7,66 15: R\$ 7,82
30: R\$ 7,97 45: R\$ 8,13 60: R\$ 8,30



ALMOFADA P/CARIMBO N3 PRETO TPA METAL 773
Código: 41732 Fábrica: MASTERPRINT Unidade: UN/1
F1 F4

UN: R\$ 8,59 AV: R\$ 8,59 15: R\$ 8,77
30: R\$ 8,94 45: R\$ 9,12 60: R\$ 9,30



ALMOFADA P/CARIMBO N3 VERM ENTINTADA
Código: 41801 Fábrica: CARBRINK Unidade: UN/1
F1 F4

UN: R\$ 7,66 AV: R\$ 7,66 15: R\$ 7,82
30: R\$ 7,97 45: R\$ 8,13 60: R\$ 8,30



ALMOFADA P/CARIMBO N3 VERM TPA METAL 774
Código: 41733 Fábrica: MASTERPRINT Unidade: UN/1
F1 F4

UN: R\$ 5,19 AV: R\$ 5,19 15: R\$ 5,30
30: R\$ 5,41 45: R\$ 5,51 60: R\$ 5,62



ALMOFADA P/CARIMBO N3 VERMELHA ENTINTADA
Código: 6792 Fábrica: RADEX Unidade: UN/1
F1 F4

UN: R\$ 14,97 AV: R\$ 14,97 15: R\$ 15,28
30: R\$ 15,58 45: R\$ 15,90 60: R\$ 16,21



ALMOFADA P/CARIMBO N4 AZUL ENTINTADA 173
Código: 42250 Fábrica: CARBRINK Unidade: UN/1
F1 F4

UN: R\$ 14,97 AV: R\$ 14,97 15: R\$ 15,28
30: R\$ 15,58 45: R\$ 15,90 60: R\$ 16,21



ALMOFADA P/CARIMBO N4 PRETA ENTINTADA 74
Código: 41964 Fábrica: CARBRINK Unidade: UN/1
F1 F4

UN: R\$ 11,65 AV: R\$ 139,77 15: R\$ 142,68
30: R\$ 145,53 45: R\$ 148,44 60: R\$ 151,41



ANILINA ALCOOL 4GRS SORTIDO 12X1
Código: 45520 Fábrica: GLIART Unidade: DZ/12
F1 F4

UN: R\$ 4,98 AV: R\$ 4,98 15: R\$ 5,09
30: R\$ 5,19 45: R\$ 5,29 60: R\$ 5,40



APAGADOR P/QUADRO BCO ANATOMICO EVA 331
Código: 45632 Fábrica: CORTIARTE Unidade: UN/1
F1 F4

UN: R\$ 6,48 AV: R\$ 6,48 15: R\$ 6,61
30: R\$ 6,75 45: R\$ 6,88 60: R\$ 7,02



APAGADOR P/QUADRO BRANCO C/DEP P/MAR 469
Código: 41804 Fábrica: CARBRINK Unidade: UN/1
F1 F4

UN: R\$ 6,34 AV: R\$ 6,34 15: R\$ 6,47
30: R\$ 6,60 45: R\$ 6,73 60: R\$ 6,87



APAGADOR P/QUADRO BRANCO C/IMA 3100
Código: 44127 Fábrica: MASTERPRINT Unidade: UN/1
F1 F4

UN: R\$ 39,91 AV: R\$ 39,91 15: R\$ 40,74
30: R\$ 41,55 45: R\$ 42,38 60: R\$ 43,23



APAGADOR P/QUADRO BRANCO C/2 MARCADORES
Código: 48222 Fábrica: ROKE Unidade: KI/1
F1 F4

UN: R\$ 34,96 AV: R\$ 34,96 15: R\$ 34,96
30: R\$ 34,96 45: R\$ 34,96 60: R\$ 34,96



APAGADOR P/QUADRO BRANCO C/4 MARCADORES
Código: 46413 Fábrica: KAZ Unidade: KI/1
F1 F4

UN: R\$ 13,43 AV: R\$ 13,43 15: R\$ 13,71
30: R\$ 13,98 45: R\$ 14,26 60: R\$ 14,55



APAGADOR P/QUADRO BRANCO FLIP TOP 102
Código: 43193 Fábrica: BRW Unidade: UN/1
F1 F4

UN: R\$ 6,34 AV: R\$ 6,34 15: R\$ 6,47
30: R\$ 6,60 45: R\$ 6,73 60: R\$ 6,87



APAGADOR P/QUADRO BRANCO MAGNETICO AZUL

Código: Fábrika: Unidade:
11221 BRW UN/1
F1 F4

UN: R\$ 5,98 AV: R\$ 5,98 15: R\$ 6,11
30: R\$ 6,23 45: R\$ 6,35 60: R\$ 6,48



APAGADOR P/QUADRO BRANCO 468/470

Código: Fábrika: Unidade:
41805 CARBRINK UN/1
F1 F4

UN: R\$ 8,98 AV: R\$ 8,98 15: R\$ 9,16
30: R\$ 9,35 45: R\$ 9,53 60: R\$ 9,72



APAGADOR P/QUADRO C/SUPORTE VERDE 8189

Código: Fábrika: Unidade:
11222 SOUZA/STALO UN/1
F1 F4

UN: R\$ 8,48 AV: R\$ 8,48 15: R\$ 8,65
30: R\$ 8,83 45: R\$ 9,00 60: R\$ 9,18



APAGADOR P/QUADRO MAD C/DEPOSITO 324

Código: Fábrika: Unidade:
45631 CORTIARTE UN/1
F1 F4

UN: R\$ 2,55 AV: R\$ 2,55 15: R\$ 2,60
30: R\$ 2,65 45: R\$ 2,70 60: R\$ 2,76



APAGADOR P/QUADRO MADEIRA 320

Código: Fábrika: Unidade:
6835 CORTIARTE UN/1
F1 F4

UN: R\$ 1,21 AV: R\$ 28,94 15: R\$ 29,55
30: R\$ 30,14 45: R\$ 30,74 60: R\$ 31,36



APONTADOR C/DEP BLOCO 6CM 4531 24X1

Código: Fábrika: Unidade:
9579 LEO&LEO CX/24
F1 F4

UN: R\$ 3,58 AV: R\$ 3,58 15: R\$ 3,66
30: R\$ 3,73 45: R\$ 3,81 60: R\$ 3,88



APONTADOR C/DEP C/BORRACHA HONGSI

Código: Fábrika: Unidade:
40910 TRIS UN/1
F1 F4

UN: R\$ 1,79 AV: R\$ 21,47 15: R\$ 21,91
30: R\$ 22,35 45: R\$ 22,80 60: R\$ 23,25



APONTADOR C/DEP CESTINHA DUPLA 4568 12X1

Código: Fábrika: Unidade:
40914 LEO&LEO CX/12
F1 F4

UN: R\$ 2,50 AV: R\$ 29,95 15: R\$ 30,58
30: R\$ 31,19 45: R\$ 31,81 60: R\$ 32,45



APONTADOR C/DEP CILINDR METAL BETTY 12X1

Código: Fábrika: Unidade:
38550 SUMMIT CX/12
F4

UN: R\$ 0,83 AV: R\$ 19,96 15: R\$ 20,37
30: R\$ 20,78 45: R\$ 21,20 60: R\$ 21,62



APONTADOR C/DEP CORCAO HANNAH MONT 24X1

Código: Fábrika: Unidade:
38549 TRIS CX/24
F1 F4

UN: R\$ 3,98 AV: R\$ 3,98 15: R\$ 4,07
30: R\$ 4,15 45: R\$ 4,23 60: R\$ 4,32



APONTADOR C/DEP DUPLA LOL SURPRISE 3060

Código: Fábrika: Unidade:
41614 LOL UN/1
F4

UN: R\$ 2,72 AV: R\$ 32,62 15: R\$ 33,30
30: R\$ 33,96 45: R\$ 34,64 60: R\$ 35,34



APONTADOR C/DEP OVAL DUPLA 12X1

Código: Fábrika: Unidade:
49268 COLORARE CX/12
F1 F4

UN: R\$ 2,33 AV: R\$ 27,95 15: R\$ 28,53
30: R\$ 29,10 45: R\$ 29,68 60: R\$ 30,27



APONTADOR C/DEP OVAL DUPLA 4534 12X1

Código: Fábrika: Unidade:
41613 LEO&LEO CX/12
F1 F4

UN: R\$ 2,58 AV: R\$ 2,58 15: R\$ 2,63
30: R\$ 2,68 45: R\$ 2,74 60: R\$ 2,79



APONTADOR C/DEP OVAL DUPLA 4752 SOLAPA

Código: Fábrika: Unidade:
47390 LEO&LEO UN/1
F1 F4

UN: R\$ 2,33 AV: R\$ 28,01 15: R\$ 28,59
30: R\$ 29,16 45: R\$ 29,74 60: R\$ 30,34



APONTADOR C/DEP OVAL DUPLA 903891 12X1

Código: Fábrika: Unidade:
49942 BAZZE CX/12
F1 F4

UN: R\$ 2,81 AV: R\$ 33,70 15: R\$ 34,40
30: R\$ 35,09 45: R\$ 35,79 60: R\$ 36,50



APONTADOR C/DEP OVAL PLAST 2005 12X1

Código: Fábrika: Unidade:
21472 BRW CX/12
F1 F4

UN: R\$ 2,39 AV: R\$ 57,33 15: R\$ 58,52
30: R\$ 59,69 45: R\$ 60,89 60: R\$ 62,10



APONTADOR C/DEP OVAL 5CM 2003 24X1
Código: 47014 Fábrica: BRW Unidade: CX/24 F1 F4

UN: R\$ 0,96 AV: R\$ 46,28 15: R\$ 47,24
30: R\$ 48,18 45: R\$ 49,15 60: R\$ 50,13



APONTADOR C/DEP PLAST QUAD 1207 48X1
Código: 46751 Fábrica: MASTERPRINT Unidade: CX/48 F1 F4

UN: R\$ 1,08 AV: R\$ 25,84 15: R\$ 26,38
30: R\$ 26,90 45: R\$ 27,44 60: R\$ 27,99



APONTADOR C/DEP PLAST RET 1208 24X1
Código: 49274 Fábrica: MASTERPRINT Unidade: CX/24 F1 F4

UN: R\$ 1,04 AV: R\$ 24,93 15: R\$ 25,45
30: R\$ 25,96 45: R\$ 26,48 60: R\$ 27,01



APONTADOR C/DEP RET BLOCO 4CM 040 24X1
Código: 49265 Fábrica: COLORARE Unidade: CX/24 F1 F4

UN: R\$ 1,16 AV: R\$ 27,95 15: R\$ 28,53
30: R\$ 29,10 45: R\$ 29,68 60: R\$ 30,27



APONTADOR C/DEP RETANG HIGH SCHOOL 24X1
Código: 21140 Fábrica: TRIS Unidade: CX/24 F1 F4

UN: R\$ 59,89 AV: R\$ 59,89 15: R\$ 61,14
30: R\$ 62,36 45: R\$ 63,61 60: R\$ 64,88



APONTADOR ELETRIC AUTOMAT PILHA AA 245
Código: 46741 Fábrica: KAZ Unidade: UN/1 F1 F4

UN: R\$ 1,08 AV: R\$ 25,95 15: R\$ 26,49
30: R\$ 27,02 45: R\$ 27,56 60: R\$ 28,11



APONTADOR METAL RET CLASSICO 4207 24X1
Código: 44243 Fábrica: LEO&LEO Unidade: CX/24 F1 F4

UN: R\$ 1,57 AV: R\$ 37,74 15: R\$ 38,53
30: R\$ 39,30 45: R\$ 40,08 60: R\$ 40,88



APONTADOR METAL RET SIMPLES 4209 24X1
Código: 6557 Fábrica: LEO&LEO Unidade: CX/24 F1 F4

UN: R\$ 1,00 AV: R\$ 23,95 15: R\$ 24,45
30: R\$ 24,94 45: R\$ 25,44 60: R\$ 25,95



APONTADOR METAL RET 20026 24X1
Código: 50684 Fábrica: WINPAPER Unidade: CX/24 F1 F4

UN: R\$ 1,00 AV: R\$ 19,97 15: R\$ 20,38
30: R\$ 20,79 45: R\$ 21,21 60: R\$ 21,63



APONTADOR METAL 5579 20X1
Código: 14682 Fábrica: GOLLER Unidade: CX/20 F1 F4

UN: R\$ 0,57 AV: R\$ 13,58 15: R\$ 13,86
30: R\$ 14,14 45: R\$ 14,42 60: R\$ 14,71



APONTADOR PLAST C/DEP MINI 4540 24X1
Código: 42143 Fábrica: LEO&LEO Unidade: CX/24 F1 F4

UN: R\$ 7,48 AV: R\$ 7,48 15: R\$ 7,63
30: R\$ 7,79 45: R\$ 7,94 60: R\$ 8,10



APONTADOR PLAST MANIVELA MANUAL 20207
Código: 44750 Fábrica: WIN PAPER Unidade: UN/1 F1 F4

UN: R\$ 0,39 AV: R\$ 9,34 15: R\$ 9,53
30: R\$ 9,72 45: R\$ 9,91 60: R\$ 10,11



APONTADOR RED SIMPLES 0322 24X1
Código: 42594 Fábrica: LEO&LEO Unidade: CX/24 F1 F4

UN: R\$ 0,29 AV: R\$ 6,98 15: R\$ 7,12
30: R\$ 7,27 45: R\$ 7,41 60: R\$ 7,56



APONTADOR RET SIMPLES 10400 24X1
Código: 29998 Fábrica: GATTE Unidade: CX/24 F1 F4

UN: R\$ 0,29 AV: R\$ 6,98 15: R\$ 7,12
30: R\$ 7,27 45: R\$ 7,41 60: R\$ 7,56



APONTADOR RET SIMPLES 4529 24X1
Código: 40918 Fábrica: LEO&LEO Unidade: CX/24 F1 F4

UN: R\$ 0,40 AV: R\$ 39,93 15: R\$ 40,76
30: R\$ 41,57 45: R\$ 42,40 60: R\$ 43,25



APONTADOR RETANGULAR PLAST 1203 100X1
Código: 21138 Fábrica: BRW Unidade: PT/100 F1 F4

UN: R\$ 0,20 AV: R\$ 20,47 15: R\$ 20,89
30: R\$ 21,31 45: R\$ 21,74 60: R\$ 22,17

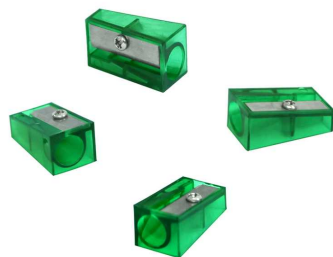

APONTADOR TRIANGULO RETANG PLAST 100X1

Código: 37997 Fábrica: FELE Unidade: PT/100
F1 F4

UN: R\$ 16,72 AV: R\$ 16,72 15: R\$ 17,07
30: R\$ 17,41 45: R\$ 17,76 60: R\$ 18,12



AREIA MAGICA CORES 200 GRS MASSA UN

Código: 43024 Fábrica: ACRILEX Unidade: UN/1
F1 F4

UN: R\$ 37,93 AV: R\$ 37,93 15: R\$ 38,72
30: R\$ 39,49 45: R\$ 40,28 60: R\$ 41,09



AREIA MAGICA 550 GRS 101 VERDE

Código: 44847 Fábrica: ACRILEX Unidade: UN/1
F1 F4

UN: R\$ 37,93 AV: R\$ 37,93 15: R\$ 38,72
30: R\$ 39,49 45: R\$ 40,28 60: R\$ 41,09



AREIA MAGICA 550 GRS 105 LARANJA

Código: 44848 Fábrica: ACRILEX Unidade: UN/1
F1 F4

UN: R\$ 37,93 AV: R\$ 37,93 15: R\$ 38,72
30: R\$ 39,49 45: R\$ 40,28 60: R\$ 41,09



AREIA MAGICA 550 GRS 106 ROXO

Código: 44850 Fábrica: ACRILEX Unidade: UN/1
F1 F4

UN: R\$ 37,93 AV: R\$ 37,93 15: R\$ 38,72
30: R\$ 39,49 45: R\$ 40,28 60: R\$ 41,09



AREIA MAGICA 550 GRS 107 ROSA MARAVILHA

Código: 44849 Fábrica: ACRILEX Unidade: UN/1
F1 F4

UN: R\$ 37,93 AV: R\$ 37,93 15: R\$ 38,72
30: R\$ 39,49 45: R\$ 40,28 60: R\$ 41,09



AREIA MAGICA 550 GRS 109 AZUL

Código: 44846 Fábrica: ACRILEX Unidade: UN/1
F1 F4

UN: R\$ 8,98 AV: R\$ 8,98 15: R\$ 9,16
30: R\$ 9,35 45: R\$ 9,53 60: R\$ 9,72



AVENTAL INF C/BOLSO ARCO IRI 49,5X39,5CM

Código: 41704 Fábrica: LEO&LEO Unidade: UN/1
F1 F4

UN: R\$ 9,97 AV: R\$ 9,97 15: R\$ 10,18
30: R\$ 10,39 45: R\$ 10,59 60: R\$ 10,81



AVENTAL INF C/BOLSO CRISTAL 49,5X39,5CM

Código: 41693 Fábrica: LEO&LEO Unidade: UN/1
F1 F4

UN: R\$ 9,97 AV: R\$ 9,97 15: R\$ 10,18
30: R\$ 10,39 45: R\$ 10,59 60: R\$ 10,81



AVENTAL INF C/BOLSO DINO 49,5X39,5CM

Código: 46356 Fábrica: LEO&LEO Unidade: UN/1
F1 F4

UN: R\$ 9,97 AV: R\$ 9,97 15: R\$ 10,18
30: R\$ 10,39 45: R\$ 10,59 60: R\$ 10,81



AVENTAL INF C/BOLSO FUND MAR 49,5X39,5CM

Código: 46355 Fábrica: LEO&LEO Unidade: UN/1
F1 F4

UN: R\$ 11,27 AV: R\$ 11,27 15: R\$ 11,51
30: R\$ 11,74 45: R\$ 11,97 60: R\$ 12,21



AVENTAL INF C/BOLSO JOY 48X39,5CM 79644

Código: 46354 Fábrica: LEO&LEO Unidade: UN/1
F1 F4

UN: R\$ 10,43 AV: R\$ 10,43 15: R\$ 10,65
30: R\$ 10,86 45: R\$ 11,08 60: R\$ 11,30



AVENTAL INF ESC AZUL 40X45CM 10214AZ

Código: 46107 Fábrica: ACP Unidade: UN/1
F1 F4

UN: R\$ 10,43 AV: R\$ 10,43 15: R\$ 10,65
30: R\$ 10,86 45: R\$ 11,08 60: R\$ 11,30

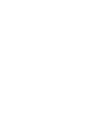

AVENTAL INF ESC CRISTAL 40X45CM 10214CR

Código: 46105 Fábrica: ACP Unidade: UN/1
F1 F4

UN: R\$ 10,43 AV: R\$ 10,43 15: R\$ 10,65
30: R\$ 10,86 45: R\$ 11,08 60: R\$ 11,30



AVENTAL INF ESC ROSA 41X46CM 10214RS

Código: 46106 Fábrica: ACP Unidade: UN/1
F1 F4

UN: R\$ 5,91 AV: R\$ 5,91 15: R\$ 6,03
30: R\$ 6,15 45: R\$ 6,28 60: R\$ 6,40



AVENTAL INF NYLON PP 34X47CM EST/LISO 20

Código: 49682 Fábrica: MARIO BRITO Unidade: UN/1
F1 F4

UN: R\$ 11,77 AV: R\$ 11,77 15: R\$ 12,02
30: R\$ 12,26 45: R\$ 12,50 60: R\$ 12,75



BASE ACRILICA ARTESANATO 120 ML 3412
Código: Fábrica: Unidade:
44815 ACRILEX UN/1
F1 F4

UN: R\$ 21,39 AV: R\$ 21,39 15: R\$ 21,83
30: R\$ 22,27 45: R\$ 22,71 60: R\$ 23,17



BASE ACRILICA ARTESANATO 250 ML 3425
Código: Fábrica: Unidade:
44816 ACRILEX UN/1
F1 F4

UN: R\$ 1,85 AV: R\$ 36,93 15: R\$ 37,70
30: R\$ 38,45 45: R\$ 39,22 60: R\$ 40,01

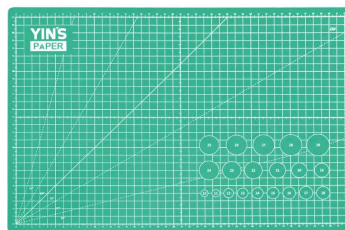

BASE DE CORTE A3 DUPLA FACE 7856
Código: Fábrica: Unidade:
48346 YIN'S PAPER PT/20
F1 F4

UN: R\$ 13,97 AV: R\$ 13,97 15: R\$ 14,26
30: R\$ 14,54 45: R\$ 14,83 60: R\$ 15,13



BETUME 100 ML 15810
Código: Fábrica: Unidade:
44818 ACRILEX UN/1
F1 F4

UN: R\$ 32,94 AV: R\$ 32,94 15: R\$ 33,62
30: R\$ 34,30 45: R\$ 34,98 60: R\$ 35,68



BIBLIO CANTO L METAL 2X1
Código: Fábrica: Unidade:
49526 CARBRINK PT/1
F1 F4

UN: R\$ 16,97 AV: R\$ 33,94 15: R\$ 34,64
30: R\$ 35,34 45: R\$ 36,04 60: R\$ 36,76



BIBLIO CANTO L 684 2X1
Código: Fábrica: Unidade:
45502 ACRINIL PT/2
F1 F4

UN: R\$ 29,94 AV: R\$ 29,94 15: R\$ 30,57
30: R\$ 31,18 45: R\$ 31,80 60: R\$ 32,44



BLOCO ANOT C/CANETA 13X18,5CM 80FLS 2155
Código: Fábrica: Unidade:
43779 WIN PAPER UN/1
F1 F4

UN: R\$ 46,91 AV: R\$ 46,91 15: R\$ 47,89
30: R\$ 48,85 45: R\$ 49,83 60: R\$ 50,82



BLOCO AQUARELA A3 300GR 12 FLS FILIART
Código: Fábrica: Unidade:
50267 USAPEL PT/1
F1 F4

UN: R\$ 4,16 AV: R\$ 24,95 15: R\$ 25,47
30: R\$ 25,98 45: R\$ 26,50 60: R\$ 27,03

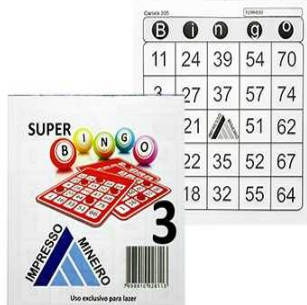

BLOCO BINGO PQ 100 CARTELAS 1 A 75 6X1
Código: Fábrica: Unidade:
12544 PARRKE PT/6
F1 F4

UN: R\$ 3,15 AV: R\$ 3,15 15: R\$ 3,21
30: R\$ 3,27 45: R\$ 3,34 60: R\$ 3,41



BLOCO CD ANOT 120F 7,3X7,4CM 1117
Código: Fábrica: Unidade:
44799 WIN PAPER UN/1
F1 F4

UN: R\$ 2,90 AV: R\$ 2,90 15: R\$ 2,96
30: R\$ 3,01 45: R\$ 3,08 60: R\$ 3,14



BLOCO P/ANOTACOES S/P 100X138SERR 50FLS
Código: Fábrica: Unidade:
42696 PARRKE UN/1
F1 F4

UN: R\$ 8,98 AV: R\$ 89,85 15: R\$ 91,72
30: R\$ 93,55 45: R\$ 95,42 60: R\$ 97,33



BLOCO PAPEL A4 MILIMETRADO 50FLS 10X1
Código: Fábrica: Unidade:
17969 PARRKE PT/10
F1 F4

UN: R\$ 7,39 AV: R\$ 73,87 15: R\$ 75,41
30: R\$ 76,92 45: R\$ 78,46 60: R\$ 80,03



BLOCO PAPEL QUADRICULADO A4 50FLS 10X1
Código: Fábrica: Unidade:
14424 PARRKE PT/10
F1 F4

UN: R\$ 4,79 AV: R\$ 47,92 15: R\$ 48,92
30: R\$ 49,90 45: R\$ 50,90 60: R\$ 51,92

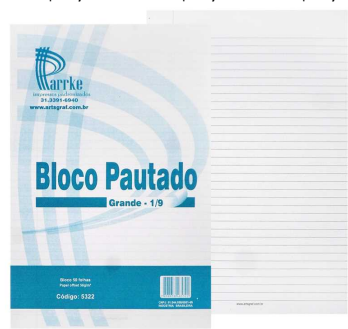

BLOCO PAUTADO GDE 1/9 S/COPIA 50FL 10X1
Código: Fábrica: Unidade:
21417 PARRKE PT/10
F1 F4

UN: R\$ 3,73 AV: R\$ 74,56 15: R\$ 76,11
30: R\$ 77,64 45: R\$ 79,19 60: R\$ 80,77



BLOCO PAUTADO PEQ 1/18 S/COPIA 50FL 20X1
Código: Fábrica: Unidade:
21570 PARRKE PT/20
F1 F4

UN: R\$ 0,84 AV: R\$ 33,45 15: R\$ 34,14
30: R\$ 34,83 45: R\$ 35,52 60: R\$ 36,23



BLOCO RASCUNHO 7X10CM 50FLS 40X1
Código: Fábrica: Unidade:
17971 PARRKE PT/40
F1 F4

UN: R\$ 2,00 AV: R\$ 39,93 15: R\$ 40,76
30: R\$ 41,57 45: R\$ 42,40 60: R\$ 43,25



BLOCO RASCUNHO 10X15CM 50FLS 20X1
Código: 17970 Fábrica: PARRKE Unidade: PT/20 F1 F4

UN: R\$ 0,03 AV: R\$ 14,73 15: R\$ 15,03
30: R\$ 15,33 45: R\$ 15,64 60: R\$ 15,95



BLOCO RECADOS 76X76MM 500X1
Código: 46250 Fábrica: IMPORIENTE Unidade: CX/500 F1 F4

UN: R\$ 9,65 AV: R\$ 289,53 15: R\$ 295,56
30: R\$ 301,47 45: R\$ 307,50 60: R\$ 313,65



BOBINA CALCULADORA 57MM 22MTS 2VIAS 30X1
Código: 29191 Fábrica: PRIMUS Unidade: CX/30 F1 F4

UN: R\$ 2,66 AV: R\$ 79,86 15: R\$ 81,53
30: R\$ 83,16 45: R\$ 84,82 60: R\$ 86,52



BOBINA CALCULADORA 57MM 30MTS 1VIA 30X1
Código: 21580 Fábrica: PRIMUS Unidade: CX/30 F1 F4

UN: R\$ 17,96 AV: R\$ 17,96 15: R\$ 18,34
30: R\$ 18,70 45: R\$ 19,08 60: R\$ 19,46



BOBINA FAX 30 MTS
Código: 26060 Fábrica: PRIMUS Unidade: RL/1 F1 F4

UN: R\$ 4,99 AV: R\$ 149,75 15: R\$ 152,87
30: R\$ 155,93 45: R\$ 159,05 60: R\$ 162,23



BOBINA TERMICA 57MMX30M 1VIA 30X1
Código: 27782 Fábrica: PRIMUS Unidade: CX/30 F1 F4

UN: R\$ 48,91 AV: R\$ 48,91 15: R\$ 49,93
30: R\$ 50,93 45: R\$ 51,95 60: R\$ 52,99



BOBINA TERMICA 57MMX300M 1VIA BRANCA
Código: 29790 Fábrica: PRIMUS Unidade: UN/1 F1 F4

UN: R\$ 5,62 AV: R\$ 168,45 15: R\$ 171,96
30: R\$ 175,40 45: R\$ 178,91 60: R\$ 182,48



BOBINA TERMICA 57MMX40M 1VIA 30X1
Código: 50249 Fábrica: PRIMUS Unidade: CX/30 F1 F4

UN: R\$ 5,98 AV: R\$ 5,98 15: R\$ 6,11
30: R\$ 6,23 45: R\$ 6,35 60: R\$ 6,48



BOBINA TERMICA 79MM UN
Código: 42947 Fábrica: PRIMUS Unidade: UN/1 F1 F4

UN: R\$ 5,80 AV: R\$ 173,92 15: R\$ 177,54
30: R\$ 181,10 45: R\$ 184,72 60: R\$ 188,41



BOBINA TERMICA 79MMX30M 1VIA 30X1
Código: 27758 Fábrica: CLEAR/PRIMUS Unidade: CX/30 F1 F4

UN: R\$ 0,29 AV: R\$ 57,86 15: R\$ 59,06
30: R\$ 60,24 45: R\$ 61,45 60: R\$ 62,68

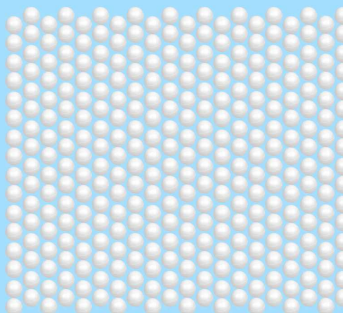

BOLA ISOPOR MOLD EPS DIAM 8MM 200X1
Código: 48276 Fábrica: ISOMAX Unidade: PT/200 F1 F4

UN: R\$ 0,21 AV: R\$ 41,92 15: R\$ 42,80
30: R\$ 43,65 45: R\$ 44,53 60: R\$ 45,42

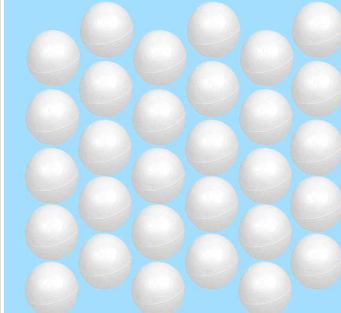

BOLA ISOPOR MOLD EPS DIAM 15MM 200X1
Código: 48275 Fábrica: ISOMAX Unidade: PT/200 F1 F4

UN: R\$ 0,48 AV: R\$ 47,91 15: R\$ 48,91
30: R\$ 49,89 45: R\$ 50,89 60: R\$ 51,91

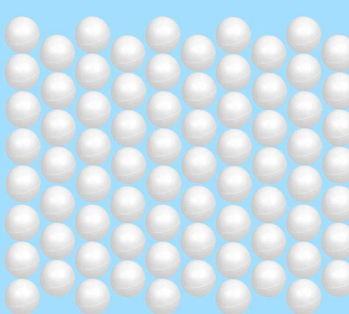

BOLA ISOPOR MOLD EPS DIAM 20MM 100X1
Código: 48277 Fábrica: ISOMAX Unidade: PT/100 F1 F4

UN: R\$ 0,42 AV: R\$ 41,92 15: R\$ 42,80
30: R\$ 43,65 45: R\$ 44,53 60: R\$ 45,42

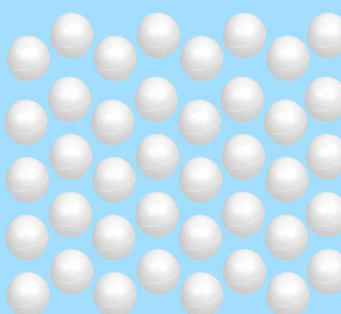

BOLA ISOPOR MOLD EPS DIAM 25MM 100X1
Código: 48278 Fábrica: ISOMAX Unidade: PT/100 F1 F4

UN: R\$ 0,61 AV: R\$ 60,89 15: R\$ 62,16
30: R\$ 63,40 45: R\$ 64,67 60: R\$ 65,97

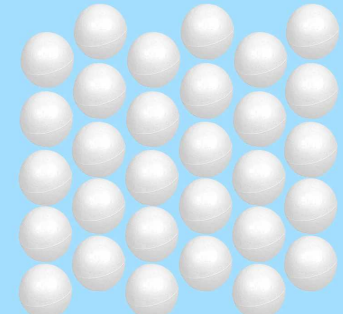

BOLA ISOPOR MOLD EPS DIAM 30MM 100X1
Código: 47956 Fábrica: ISOMAX Unidade: PT/100 F1 F4

UN: R\$ 0,56 AV: R\$ 55,50 15: R\$ 56,66
30: R\$ 57,79 45: R\$ 58,95 60: R\$ 60,13

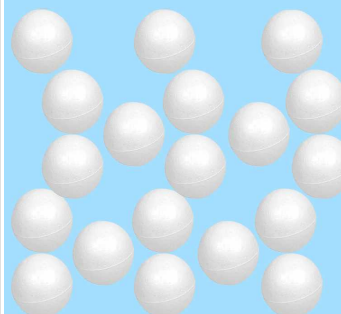

BOLA ISOPOR MOLD EPS DIAM 35MM 100X1
Código: 30106 Fábrica: ISOMAX Unidade: PT/100 F1 F4

UN: R\$ 1,46 AV: R\$ 58,21 15: R\$ 59,42
30: R\$ 60,61 45: R\$ 61,82 60: R\$ 63,06

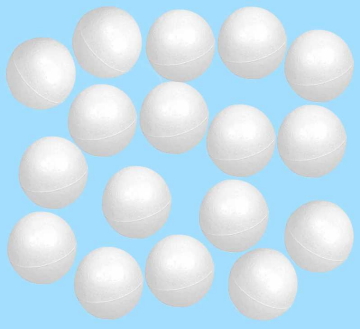

BOLA ISOPOR MOLD EPS DIAM 40MM 40X1

Código: 30107 Fábrica: ISOMAX Unidade: PT/40 F1 F4

UN: R\$ 1,31 AV: R\$ 65,53 15: R\$ 66,89
30: R\$ 68,23 45: R\$ 69,59 60: R\$ 70,98

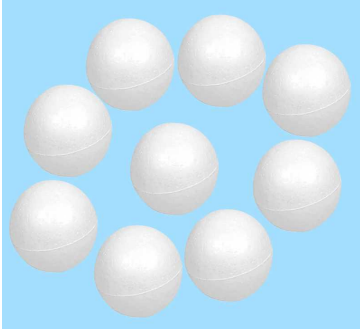

BOLA ISOPOR MOLD EPS DIAM 50MM 50X1

Código: 30108 Fábrica: ISOMAX Unidade: PT/50 F1 F4

UN: R\$ 2,46 AV: R\$ 73,87 15: R\$ 75,41
30: R\$ 76,92 45: R\$ 78,46 60: R\$ 80,03



BOLA ISOPOR MOLD EPS DIAM 60MM 30X1

Código: 30109 Fábrica: ISOMAX Unidade: PT/30 F1 F4

UN: R\$ 3,19 AV: R\$ 79,86 15: R\$ 81,53
30: R\$ 83,16 45: R\$ 84,82 60: R\$ 86,52



BOLA ISOPOR MOLD EPS DIAM 70MM 25X1

Código: 47957 Fábrica: ISOMAX Unidade: PT/25 F1 F4

UN: R\$ 2,67 AV: R\$ 66,64 15: R\$ 68,03
30: R\$ 69,39 45: R\$ 70,78 60: R\$ 72,20

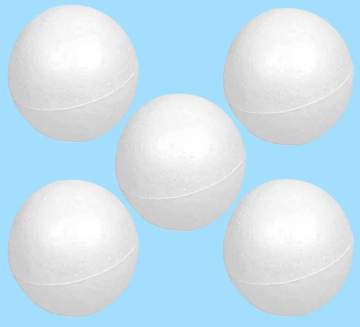

BOLA ISOPOR MOLD EPS DIAM 75MM 25X1

Código: 30092 Fábrica: ISOMAX Unidade: PT/25 F1 F4

UN: R\$ 4,64 AV: R\$ 92,84 15: R\$ 94,78
30: R\$ 96,67 45: R\$ 98,60 60: R\$ 100,58



BOLA ISOPOR MOLD EPS DIAM 80MM 20X1

Código: 48279 Fábrica: ISOMAX Unidade: PT/20 F1 F4

UN: R\$ 4,24 AV: R\$ 84,85 15: R\$ 86,62
30: R\$ 88,35 45: R\$ 90,12 60: R\$ 91,92



BOLA ISOPOR MOLD EPS DIAM 90MM 12X1

Código: 48280 Fábrica: ISOMAX Unidade: PT/20 F1 F4

UN: R\$ 6,26 AV: R\$ 62,65 15: R\$ 63,95
30: R\$ 65,23 45: R\$ 66,54 60: R\$ 67,87



BOLA ISOPOR MOLD EPS DIAM 100MM 10X1

Código: 30110 Fábrica: ISOMAX Unidade: PT/10 F1 F4

UN: R\$ 13,31 AV: R\$ 79,86 15: R\$ 81,53
30: R\$ 83,16 45: R\$ 84,82 60: R\$ 86,52



BOLA ISOPOR MOLD EPS DIAM 125MM 6X1

Código: 30940 Fábrica: ISOMAX Unidade: PT/6 F1 F4

UN: R\$ 14,57 AV: R\$ 72,87 15: R\$ 74,39
30: R\$ 75,88 45: R\$ 77,40 60: R\$ 78,94



BOLA ISOPOR MOLD EPS DIAM 150MM 5X1

Código: 30941 Fábrica: ISOMAX Unidade: PT/5 F1 F4

UN: R\$ 19,97 AV: R\$ 79,86 15: R\$ 81,53
30: R\$ 83,16 45: R\$ 84,82 60: R\$ 86,52



BOLA ISOPOR MOLD EPS DIAM 175MM 4X1

Código: 30942 Fábrica: ISOMAX Unidade: PT/4 F1 F4

UN: R\$ 29,54 AV: R\$ 88,61 15: R\$ 90,45
30: R\$ 92,26 45: R\$ 94,11 60: R\$ 95,99



BOLA ISOPOR MOLD EPS DIAM 200MM 3X1

Código: 30943 Fábrica: ISOMAX Unidade: PT/3 F1 F4

UN: R\$ 32,20 AV: R\$ 64,40 15: R\$ 65,74
30: R\$ 67,05 45: R\$ 68,39 60: R\$ 69,76



BOLA ISOPOR MOLD EPS DIAM 250MM 2X1

Código: 30944 Fábrica: ISOMAX Unidade: PT/2 F1 F4

UN: R\$ 58,90 AV: R\$ 58,90 15: R\$ 60,12
30: R\$ 61,33 45: R\$ 62,55 60: R\$ 63,80



BOLA ISOPOR MOLD EPS DIAM 300MM 1X1

Código: 30945 Fábrica: ISOMAX Unidade: UN/1 F1 F4

UN: R\$ 2,99 AV: R\$ 2,99 15: R\$ 3,05
30: R\$ 3,11 45: R\$ 3,17 60: R\$ 3,23



BOLO ISOPOR REDONDO CIRCULO 100X100MM

Código: 41302 Fábrica: ISOMAX Unidade: PT/1 F1 F4

UN: R\$ 17,96 AV: R\$ 17,96 15: R\$ 18,34
30: R\$ 18,70 45: R\$ 19,08 60: R\$ 19,46



BOLO ISOPOR REDONDO 250X250X100MM

Código: 35706 Fábrica: ISOMAX Unidade: PT/1 F1 F4

UN: R\$ 26,07 AV: R\$ 26,07 15: R\$ 26,61
30: R\$ 27,14 45: R\$ 27,69 60: R\$ 28,24



BOLo ISOPOR REDONDO 350X350X100MM
Código: Fábrica: Unidade:
35707 ISOMAX PT/1
F1 F4

UN: R\$ 0,16 AV: R\$ 15,96 15: R\$ 16,30
30: R\$ 16,62 45: R\$ 16,96 60: R\$ 17,29



BORRACHA PONTEIRA 100X1
Código: Fábrica: Unidade:
41967 VMP CX/100
F1 F4

UN: R\$ 1,82 AV: R\$ 43,58 15: R\$ 44,49
30: R\$ 45,38 45: R\$ 46,29 60: R\$ 47,21



BORRACHA ANATOM PRETA TS2000 24X1
Código: Fábrica: Unidade:
31873 ECOLE CX/24
F1 F4

UN: R\$ 0,72 AV: R\$ 28,85 15: R\$ 29,45
30: R\$ 30,04 45: R\$ 30,64 60: R\$ 31,26



BORRACHA BICOLOR 40 40X1
Código: Fábrica: Unidade:
18703 RED BOR/ZAP CX/40
F1 F4

UN: R\$ 1,30 AV: R\$ 51,91 15: R\$ 52,99
30: R\$ 54,05 45: R\$ 55,13 60: R\$ 56,23



BORRACHA BICOLOR 906281 40X1
Código: Fábrica: Unidade:
49941 BAZZE CX/40
F1 F4

UN: R\$ 1,75 AV: R\$ 41,93 15: R\$ 42,81
30: R\$ 43,66 45: R\$ 44,54 60: R\$ 45,43



BORRACHA BRANCA OVAL GDE BOR6008 24X1
Código: Fábrica: Unidade:
32951 CLASSE CX/24
F1 F4

UN: R\$ 0,36 AV: R\$ 17,96 15: R\$ 18,34
30: R\$ 18,70 45: R\$ 19,08 60: R\$ 19,46



BORRACHA BRANCA PONTEIRA 50X1
Código: Fábrica: Unidade:
28029 RED BOR CX/50
F1 F4

UN: R\$ 0,68 AV: R\$ 1,36 15: R\$ 1,39
30: R\$ 1,41 45: R\$ 1,44 60: R\$ 1,47



BORRACHA BRANCA 2B BLISTER 7351 2X1
Código: Fábrica: Unidade:
46950 YIN'S PAPER PT/2
F1 F4

UN: R\$ 1,00 AV: R\$ 19,96 15: R\$ 20,37
30: R\$ 20,78 45: R\$ 21,20 60: R\$ 21,62



BORRACHA BRANCA 20 GRANDE 20X1
Código: Fábrica: Unidade:
13146 PREMIER CX/20
F1 F4

UN: R\$ 0,99 AV: R\$ 19,79 15: R\$ 20,20
30: R\$ 20,60 45: R\$ 21,02 60: R\$ 21,44



BORRACHA BRANCA 20 GRANDE 20X1
Código: Fábrica: Unidade:
49263 COLORARE CX/20
F1 F4

UN: R\$ 0,95 AV: R\$ 18,96 15: R\$ 19,35
30: R\$ 19,74 45: R\$ 20,14 60: R\$ 20,54



BORRACHA BRANCA 20 4420 20X1
Código: Fábrica: Unidade:
41695 LEO&LEO CX/20
F1 F4

UN: R\$ 0,45 AV: R\$ 17,94 15: R\$ 18,32
30: R\$ 18,68 45: R\$ 19,06 60: R\$ 19,44



BORRACHA BRANCA 40 MEDIA 40X1
Código: Fábrica: Unidade:
50791 BAZZE CX/40
F1 F4

UN: R\$ 0,52 AV: R\$ 20,96 15: R\$ 21,39
30: R\$ 21,82 45: R\$ 22,26 60: R\$ 22,70



BORRACHA BRANCA 40 MEDIA 40X1
Código: Fábrica: Unidade:
49266 COLORARE CX/40
F1 F4

UN: R\$ 0,51 AV: R\$ 20,60 15: R\$ 21,03
30: R\$ 21,45 45: R\$ 21,88 60: R\$ 22,31



BORRACHA BRANCA 40 MEDIA 40X1
Código: Fábrica: Unidade:
13147 RED BOR CX/40
F1 F4

UN: R\$ 0,47 AV: R\$ 18,96 15: R\$ 19,35
30: R\$ 19,74 45: R\$ 20,14 60: R\$ 20,54



BORRACHA BRANCA 40 4419 40X1
Código: Fábrica: Unidade:
41694 LEO&LEO CX/40
F1 F4

UN: R\$ 0,33 AV: R\$ 19,80 15: R\$ 20,21
30: R\$ 20,62 45: R\$ 21,03 60: R\$ 21,45



BORRACHA BRANCA 60 PEQUENA 60X1
Código: Fábrica: Unidade:
49264 COLORARE CX/60
F1 F4

UN: R\$ 0,36 AV: R\$ 21,64 15: R\$ 22,09
30: R\$ 22,53 45: R\$ 22,98 60: R\$ 23,44



BORRACHA BRANCA 60 PEQUENA 60X1

Código: 13148 Fábrica: PREMIER/RED Unidade: CX/60 F1 F4

UN: R\$ 0,25 AV: R\$ 14,97 15: R\$ 15,28
30: R\$ 15,58 45: R\$ 15,90 60: R\$ 16,21



BORRACHA BRANCA 60 20072 60X1

Código: 50683 Fábrica: WINPAPER Unidade: CX/60 F1 F4

UN: R\$ 0,31 AV: R\$ 18,62 15: R\$ 19,01
30: R\$ 19,39 45: R\$ 19,78 60: R\$ 20,17



BORRACHA BRANCA 60 4418 60X1

Código: 41696 Fábrica: LEO&LEO Unidade: CX/60 F1 F4

UN: R\$ 1,46 AV: R\$ 34,93 15: R\$ 35,66
30: R\$ 36,38 45: R\$ 37,10 60: R\$ 37,84



BORRACHA COLORIDA 4126 24X1

Código: 41650 Fábrica: LEO&LEO Unidade: C//24 F1 F4

UN: R\$ 1,00 AV: R\$ 4,98 15: R\$ 5,09
30: R\$ 5,19 45: R\$ 5,29 60: R\$ 5,40



BORRACHA KIT CHAPEU/BOTA/BOCAFLOR 5X1

Código: 41676 Fábrica: MONALIZA Unidade: CR/5 F4

UN: R\$ 0,33 AV: R\$ 7,99 15: R\$ 8,15
30: R\$ 8,32 45: R\$ 8,48 60: R\$ 8,65



BORRACHA MECANICA (REFIL) 24X1

Código: 12047 Fábrica: JL Unidade: PT/24 F1 F4

UN: R\$ 1,08 AV: R\$ 25,96 15: R\$ 26,50
30: R\$ 27,03 45: R\$ 27,57 60: R\$ 28,12



BORRACHA PLAST HANNAH MONTANA 24X1

Código: 38554 Fábrica: TRIS Unidade: CX/24 F1 F4

UN: R\$ 1,08 AV: R\$ 25,96 15: R\$ 26,50
30: R\$ 27,03 45: R\$ 27,57 60: R\$ 28,12



BORRACHA PLAST HIGH SCHOOL MUSICAL 24X1

Código: 38555 Fábrica: TRIS Unidade: CX/24 F1 F4

UN: R\$ 0,16 AV: R\$ 7,68 15: R\$ 7,84
30: R\$ 7,99 45: R\$ 8,15 60: R\$ 8,32



BORRACHA PONTEIRA BRANCA 4352 48X1

Código: 42145 Fábrica: LEO&LEO Unidade: C//48 F1 F4

UN: R\$ 1,16 AV: R\$ 27,95 15: R\$ 28,53
30: R\$ 29,10 45: R\$ 29,68 60: R\$ 30,27



BORRACHA QUAD BRANCA CAPA PLAST 584 24X1

Código: 41227 Fábrica: LEO&LEO Unidade: CX/24 F1 F4

UN: R\$ 1,23 AV: R\$ 29,45 15: R\$ 30,07
30: R\$ 30,67 45: R\$ 31,28 60: R\$ 31,91



BORRACHA QUADR BRANCA C/CAPA PLAST 24X1

Código: 44116 Fábrica: PLANETA Unidade: CX/24 F1 F4

UN: R\$ 1,21 AV: R\$ 14,48 15: R\$ 14,78
30: R\$ 15,07 45: R\$ 15,38 60: R\$ 15,68



BORRACHA SILVER P C/CAPA PLAST 7147 12X1

Código: 23220 Fábrica: GOLLER Unidade: CX/12 F1 F4

UN: R\$ 1,44 AV: R\$ 21,67 15: R\$ 22,12
30: R\$ 22,56 45: R\$ 23,01 60: R\$ 23,47



BORRACHA VERDE 15 GRANDE 15X1

Código: 4253 Fábrica: RED BOR/PREM Unidade: CX/15 F1 F4

UN: R\$ 0,70 AV: R\$ 2,80 15: R\$ 2,85
30: R\$ 2,91 45: R\$ 2,97 60: R\$ 3,03



BORRACHA 40 MEDIA 4X1 CTL

Código: 33832 Fábrica: GOLLER Unidade: CT/4 F1 F4

UN: R\$ 0,66 AV: R\$ 7,94 15: R\$ 7,94
30: R\$ 7,94 45: R\$ 7,94 60: R\$ 7,94



BROCAL 3 GRS AZUL 12X1

Código: 6755 Fábrica: CITY BRILHO Unidade: CX/12 F1 F4

UN: R\$ 0,66 AV: R\$ 7,94 15: R\$ 7,94
30: R\$ 7,94 45: R\$ 7,94 60: R\$ 7,94



BROCAL 3 GRS DOURADO 12X1

Código: 6760 Fábrica: CITY BRILHO Unidade: CX/12 F1 F4

UN: R\$ 0,66 AV: R\$ 7,94 15: R\$ 7,94
30: R\$ 7,94 45: R\$ 7,94 60: R\$ 7,94



BROCAL 3 GRS MULTICOR 12X1

Código: 6759 Fábrica: CITY BRILHO Unidade: CX/12 F1 F4

UN: R\$ 0,66 AV: R\$ 7,94 15: R\$ 7,94
30: R\$ 7,94 45: R\$ 7,94 60: R\$ 7,94



BROCAL 3 GRS PEROLADO 12X1

Código: 6758 Fábrica: CITY BRILHO Unidade: CX/12 F1 F4

UN: R\$ 0,66 AV: R\$ 7,94 15: R\$ 7,94
30: R\$ 7,94 45: R\$ 7,94 60: R\$ 7,94



BROCAL 3 GRS PINK 12X1

Código: 6907 Fábrica: CITY BRILHO Unidade: CX/12 F1 F4

UN: R\$ 0,66 AV: R\$ 7,94 15: R\$ 7,94
30: R\$ 7,94 45: R\$ 7,94 60: R\$ 7,94



BROCAL 3 GRS PRATA 12X1

Código: 25 Fábrica: CITY BRILHO Unidade: CX/12 F1 F4

UN: R\$ 0,66 AV: R\$ 7,94 15: R\$ 7,94
30: R\$ 7,94 45: R\$ 7,94 60: R\$ 7,94



BROCAL 3 GRS PRETO 12X1

Código: 21975 Fábrica: CITY BRILHO Unidade: CX/12 F1 F4

UN: R\$ 0,66 AV: R\$ 7,94 15: R\$ 7,94
30: R\$ 7,94 45: R\$ 7,94 60: R\$ 7,94



BROCAL 3 GRS ROSA 12X1

Código: 6761 Fábrica: CITY BRILHO Unidade: CX/12 F1 F4

UN: R\$ 0,66 AV: R\$ 7,94 15: R\$ 7,94
30: R\$ 7,94 45: R\$ 7,94 60: R\$ 7,94



BROCAL 3 GRS ROXO 12X1

Código: 7477 Fábrica: CITY BRILHO Unidade: CX/12 F1 F4

UN: R\$ 0,66 AV: R\$ 7,94 15: R\$ 7,94
30: R\$ 7,94 45: R\$ 7,94 60: R\$ 7,94



BROCAL 3 GRS VERDE 12X1

Código: 6756 Fábrica: CITY BRILHO Unidade: CX/12 F1 F4

UN: R\$ 0,66 AV: R\$ 7,94 15: R\$ 7,94
30: R\$ 7,94 45: R\$ 7,94 60: R\$ 7,94



BROCAL 3 GRS VERMELHO 12X1

Código: 6757 Fábrica: CITY BRILHO Unidade: CX/12 F1 F4

UN: R\$ 10,78 AV: R\$ 10,78 15: R\$ 11,01
30: R\$ 11,23 45: R\$ 11,45 60: R\$ 11,68



BROCAL 100 GRS AZUL PISCINA

Código: 43646 Fábrica: CITY BRILHO Unidade: PT/1 F1 F4

UN: R\$ 10,78 AV: R\$ 10,78 15: R\$ 11,01
30: R\$ 11,23 45: R\$ 11,45 60: R\$ 11,68



BROCAL 100 GRS AZUL ROYAL

Código: 43649 Fábrica: CITY BRILHO Unidade: PT/1 F1 F4

UN: R\$ 10,78 AV: R\$ 10,78 15: R\$ 11,01
30: R\$ 11,23 45: R\$ 11,45 60: R\$ 11,68



BROCAL 100 GRS AZUL TURQUESA

Código: 43647 Fábrica: CITY BRILHO Unidade: PT/1 F1 F4

UN: R\$ 10,78 AV: R\$ 10,78 15: R\$ 11,01
30: R\$ 11,23 45: R\$ 11,45 60: R\$ 11,68



BROCAL 100 GRS MARROM

Código: 43648 Fábrica: CITY BRILHO Unidade: PT/1 F1 F4

UN: R\$ 10,78 AV: R\$ 10,78 15: R\$ 11,01
30: R\$ 11,23 45: R\$ 11,45 60: R\$ 11,68



BROCAL 100 GRS OURO

Código: 26352 Fábrica: CITY BRILHO Unidade: PT/1 F1 F4

UN: R\$ 10,78 AV: R\$ 10,78 15: R\$ 11,01
30: R\$ 11,23 45: R\$ 11,45 60: R\$ 11,68



BROCAL 100 GRS PEROLADO

Código: 26359 Fábrica: CITY BRILHO Unidade: PT/1 F1 F4

UN: R\$ 10,78 AV: R\$ 10,78 15: R\$ 11,01
30: R\$ 11,23 45: R\$ 11,45 60: R\$ 11,68



BROCAL 100 GRS PINK

Código: 26357 Fábrica: CITY BRILHO Unidade: PT/1 F1 F4

UN: R\$ 10,78 AV: R\$ 10,78 15: R\$ 11,01
30: R\$ 11,23 45: R\$ 11,45 60: R\$ 11,68



BROCAL 100 GRS PRATA

Código: 26353 Fábrica: CITY BRILHO Unidade: PT/1 F1 F4

UN: R\$ 10,78 AV: R\$ 10,78 15: R\$ 11,01
30: R\$ 11,23 45: R\$ 11,45 60: R\$ 11,68



BROCAL 100 GRS PRETO

Código: 21647 Fábrica: CITY BRILHO Unidade: PT/1 F1 F4

UN: R\$ 10,78 AV: R\$ 10,78 15: R\$ 11,01
30: R\$ 11,23 45: R\$ 11,45 60: R\$ 11,68



BROCAL 100 GRS ROSA

Código: 26356 Fábrica: CITY BRILHO Unidade: PT/1 F1 F4

UN: R\$ 10,78 AV: R\$ 10,78 15: R\$ 11,01
30: R\$ 11,23 45: R\$ 11,45 60: R\$ 11,68



BROCAL 100 GRS ROXO

Código: 26361 Fábrica: CITY BRILHO Unidade: PT/1 F1 F4

UN: R\$ 10,78 AV: R\$ 10,78 15: R\$ 11,01
30: R\$ 11,23 45: R\$ 11,45 60: R\$ 11,68



BROCAL 100 GRS VERDE BANDEIRA

Código: 26355 Fábrica: CITY BRILHO Unidade: PT/1 F1 F4

UN: R\$ 10,78 AV: R\$ 10,78 15: R\$ 11,01
30: R\$ 11,23 45: R\$ 11,45 60: R\$ 11,68



BROCAL 100 GRS VERDE OLIVA

Código: 43645 Fábrica: CITY BRILHO Unidade: PT/1 F1 F4

UN: R\$ 10,78 AV: R\$ 10,78 15: R\$ 11,01
30: R\$ 11,23 45: R\$ 11,45 60: R\$ 11,68



BROCAL 100 GRS VERMELHO

Código: 26354 Fábrica: CITY BRILHO Unidade: PT/1 F1 F4

UN: R\$ 44,92 AV: R\$ 44,92 15: R\$ 45,85
30: R\$ 46,77 45: R\$ 47,71 60: R\$ 48,66



BROCAL 500 GRS AZUL

Código: 43637 Fábrica: CITY BRILHO Unidade: PT/1 F1 F4

UN: R\$ 44,92 AV: R\$ 44,92 15: R\$ 45,85
30: R\$ 46,77 45: R\$ 47,71 60: R\$ 48,66



BROCAL 500 GRS OURO

Código: 43639 Fábrica: CITY BRILHO Unidade: PT/1 F1 F4

UN: R\$ 44,92 AV: R\$ 44,92 15: R\$ 45,85
30: R\$ 46,77 45: R\$ 47,71 60: R\$ 48,66



BROCAL 500 GRS PRATA

Código: 43640 Fábrica: CITY BRILHO Unidade: PT/1 F1 F4

UN: R\$ 44,92 AV: R\$ 44,92 15: R\$ 45,85
30: R\$ 46,77 45: R\$ 47,71 60: R\$ 48,66



BROCAL 500 GRS PRETO

Código: 43641 Fábrica: CITY BRILHO Unidade: PT/1 F1 F4

UN: R\$ 44,92 AV: R\$ 44,92 15: R\$ 45,85
30: R\$ 46,77 45: R\$ 47,71 60: R\$ 48,66



BROCAL 500 GRS ROSA

Código: 43642 Fábrica: CITY BRILHO Unidade: PT/1 F1 F4

UN: R\$ 44,92 AV: R\$ 44,92 15: R\$ 45,85
30: R\$ 46,77 45: R\$ 47,71 60: R\$ 48,66



BROCAL 500 GRS VERDE

Código: 43643 Fábrica: CITY BRILHO Unidade: PT/1 F1 F4

UN: R\$ 44,92 AV: R\$ 44,92 15: R\$ 45,85
30: R\$ 46,77 45: R\$ 47,71 60: R\$ 48,66



BROCAL 500 GRS VERMELHO

Código: 43644 Fábrica: CITY BRILHO Unidade: PT/1 F1 F4

UN: R\$ 6,19 AV: R\$ 61,89 15: R\$ 63,18
30: R\$ 64,44 45: R\$ 65,73 60: R\$ 67,05



CADERNETA CD 1/8 ESP 96FLS FURRY BE 10X1

Código: 20343 Fábrica: MAXMA Unidade: PT/10 F1 F4

UN: R\$ 6,19 AV: R\$ 61,89 15: R\$ 63,18
30: R\$ 64,44 45: R\$ 65,73 60: R\$ 67,05



CADERNETA CD 1/8 ESP 96FLS LOUISE 10X1

Código: 34002 Fábrica: MAXIMA Unidade: PT/10 F1 F4

UN: R\$ 6,19 AV: R\$ 61,89 15: R\$ 63,18
30: R\$ 64,44 45: R\$ 65,73 60: R\$ 67,05



CADERNETA CD 1/8 ESP 96FLS LOVE 10X1
Código: 33609 Fábrica: MAXIMA Unidade: PT/10 F1 F4

UN: R\$ 6,19 AV: R\$ 61,89 15: R\$ 63,18
30: R\$ 64,44 45: R\$ 65,73 60: R\$ 67,05



CADERNETA CD 1/8 ESP 96FLS MAXICARS10X1
Código: 33999 Fábrica: MAXIMA Unidade: PT/10 F1 F4

UN: R\$ 6,19 AV: R\$ 61,89 15: R\$ 63,18
30: R\$ 64,44 45: R\$ 65,73 60: R\$ 67,05



CADERNETA CD 1/8 ESP 96FLS X-PHOTO 10X1
Código: 34001 Fábrica: MAXIMA Unidade: PT/10 F1 F4

UN: R\$ 6,19 AV: R\$ 61,89 15: R\$ 63,18
30: R\$ 64,44 45: R\$ 65,73 60: R\$ 67,05



CADERNETA CD 1/8 ESP 96FLS X-SPIDER 10X1
Código: 33997 Fábrica: MAXIMA Unidade: PT/10 F1 F4

UN: R\$ 6,19 AV: R\$ 61,89 15: R\$ 63,18
30: R\$ 64,44 45: R\$ 65,73 60: R\$ 67,05



CADERNETA CD 1/8 ESP 96FLS X-SPORT 10X1
Código: 33998 Fábrica: MAXIMA Unidade: PT/10 F1 F4

UN: R\$ 2,25 AV: R\$ 89,85 15: R\$ 91,72
30: R\$ 93,55 45: R\$ 95,42 60: R\$ 97,33



CADERNETA 1/16 APONTAMENTO 40FLS 40X1
Código: 45842 Fábrica: CREDEAL Unidade: PT/40 F1 F4

UN: R\$ 2,00 AV: R\$ 79,86 15: R\$ 81,53
30: R\$ 83,16 45: R\$ 84,82 60: R\$ 86,52



CADERNETA 1/16 BOLSO ESPIRAL 40FLS 40X1
Código: 12473 Fábrica: PAUTA/NOVA Unidade: PT/40 F1 F4

UN: R\$ 1,60 AV: R\$ 79,86 15: R\$ 81,53
30: R\$ 83,16 45: R\$ 84,82 60: R\$ 86,52



CADERNETA 1/16 BOLSO ESPIRAL 40FLS 50X1
Código: 45819 Fábrica: NEEDS Unidade: PT/50 F1 F4

UN: R\$ 2,40 AV: R\$ 47,91 15: R\$ 48,91
30: R\$ 49,89 45: R\$ 50,89 60: R\$ 51,91



CADERNETA 1/8 ANOTACOES 48FLS ESP 20X1
Código: 20286 Fábrica: PANAMER/CRED Unidade: PT/20 F1 F4

UN: R\$ 4,79 AV: R\$ 47,91 15: R\$ 48,91
30: R\$ 49,89 45: R\$ 50,89 60: R\$ 51,91



CADERNETA 1/8 ANOTACOES 96FLS ESP 10X1
Código: 5252 Fábrica: CREDEAL Unidade: PT/10 F1 F4

UN: R\$ 1,66 AV: R\$ 49,91 15: R\$ 50,95
30: R\$ 51,97 45: R\$ 53,01 60: R\$ 54,07



CADERNETA 1/8 DEVE/HAVER 16FLS 30X1
Código: 15707 Fábrica: PARRKE Unidade: PT/30 F1 F4

UN: R\$ 3,94 AV: R\$ 39,40 15: R\$ 39,40
30: R\$ 39,40 45: R\$ 39,40 60: R\$ 39,40



CADERNETA 1/8 ESP 96FLS 10X1
Código: 42912 Fábrica: NEEDS Unidade: PT/10 F1 F4

UN: R\$ 9,97 AV: R\$ 39,90 15: R\$ 40,73
30: R\$ 41,54 45: R\$ 42,37 60: R\$ 43,22



CADERNO 1MAT 96FLS UNIVERS FLEX 4X1
Código: 44110 Fábrica: ROMITEC Unidade: PT/4 F1 F4

UN: R\$ 9,97 AV: R\$ 49,87 15: R\$ 50,91
30: R\$ 51,93 45: R\$ 52,97 60: R\$ 54,03



CADERNO 1MAT 96FLS UNIVERS FLEX 5X1
Código: 45252 Fábrica: ROMITEC Unidade: PT/5 F1 F4

UN: R\$ 18,97 AV: R\$ 94,84 15: R\$ 96,81
30: R\$ 98,75 45: R\$ 100,73 60: R\$ 102,74



CADERNO ALIBOMBOM CD 80F 123 C/P VD 5X1
Código: 33780 Fábrica: MAXIMA Unidade: PT/5 F1 F4

UN: R\$ 18,97 AV: R\$ 94,84 15: R\$ 96,81
30: R\$ 98,75 45: R\$ 100,73 60: R\$ 102,74



CADERNO ALIBOMBOM CD 80F 123 S/P AZ 5X1
Código: 33781 Fábrica: MAXIMA Unidade: PT/5 F1 F4

UN: R\$ 18,97 AV: R\$ 94,84 15: R\$ 96,81
30: R\$ 98,75 45: R\$ 100,73 60: R\$ 102,74



CADERNO ALIBOMBOM CD 80F 123X C/P VM 5X1
Código: Fábrika: Unidade:
23696 MAXIMA PT/5
F1 F4

UN: R\$ 13,97 AV: R\$ 139,72 15: R\$ 142,63
30: R\$ 145,48 45: R\$ 148,39 60: R\$ 151,36



CADERNO ALIBOMBOM CF 60F 123 C/P VD 10X1
Código: Fábrika: Unidade:
33779 MAXIMA PT/10
F1 F4

UN: R\$ 13,97 AV: R\$ 13,97 15: R\$ 14,26
30: R\$ 14,54 45: R\$ 14,83 60: R\$ 15,13



CADERNO ALIBOMBOM CF 60F 123 S/P AZ
Código: Fábrika: Unidade:
40756 MAXIMA UN/1
F1 F4

UN: R\$ 13,97 AV: R\$ 139,72 15: R\$ 142,63
30: R\$ 145,48 45: R\$ 148,39 60: R\$ 151,36



CADERNO ALIBOMBOM CF 60F 123X C/P VM 10X
Código: Fábrika: Unidade:
23695 MAXIMA PT/10
F1 F4

UN: R\$ 59,89 AV: R\$ 59,89 15: R\$ 61,14
30: R\$ 62,36 45: R\$ 63,61 60: R\$ 64,88

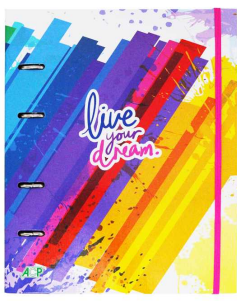

CADERNO ARG PP 80FLS STYLES DREAM C/6DIV
Código: Fábrika: Unidade:
46055 ACP UN/1
F1 F4

UN: R\$ 59,89 AV: R\$ 59,89 15: R\$ 61,14
30: R\$ 62,36 45: R\$ 63,61 60: R\$ 64,88



CADERNO ARG PP 80FLS STYLES LOVE C/6DIV
Código: Fábrika: Unidade:
46102 ACP UN/1
F1 F4

UN: R\$ 44,92 AV: R\$ 44,92 15: R\$ 45,85
30: R\$ 46,77 45: R\$ 47,71 60: R\$ 48,66



CADERNO ARG PP 96FLS SWEET C/6DIV AZUL
Código: Fábrika: Unidade:
46099 ACP UN/1
F1 F4

UN: R\$ 44,92 AV: R\$ 44,92 15: R\$ 45,85
30: R\$ 46,77 45: R\$ 47,71 60: R\$ 48,66



CADERNO ARG PP 96FLS SWEET C/6DIV PRETO
Código: Fábrika: Unidade:
46100 ACP UN/1
F1 F4

UN: R\$ 44,92 AV: R\$ 44,92 15: R\$ 45,85
30: R\$ 46,77 45: R\$ 47,71 60: R\$ 48,66



CADERNO ARG PP 96FLS SWEET C/6DIV ROSA
Código: Fábrika: Unidade:
46098 ACP UN/1
F1 F4

UN: R\$ 59,89 AV: R\$ 59,89 15: R\$ 61,14
30: R\$ 62,36 45: R\$ 63,61 60: R\$ 64,88

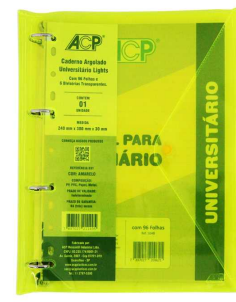

CADERNO ARG PVC 96FLS C/6DIV AMARELO
Código: Fábrika: Unidade:
46089 ACP UN/1
F1 F4

UN: R\$ 59,89 AV: R\$ 59,89 15: R\$ 61,14
30: R\$ 62,36 45: R\$ 63,61 60: R\$ 64,88

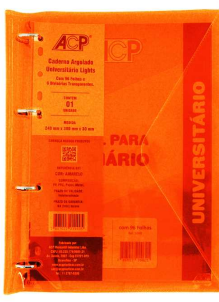

CADERNO ARG PVC 96FLS C/6DIV LARANJA
Código: Fábrika: Unidade:
46091 ACP UN/1
F1 F4

UN: R\$ 59,89 AV: R\$ 59,89 15: R\$ 61,14
30: R\$ 62,36 45: R\$ 63,61 60: R\$ 64,88

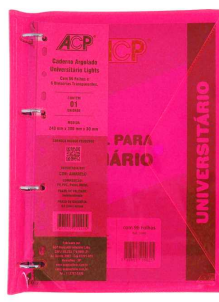

CADERNO ARG PVC 96FLS C/6DIV PINK
Código: Fábrika: Unidade:
46090 ACP UN/1
F1 F4

UN: R\$ 59,89 AV: R\$ 59,89 15: R\$ 61,14
30: R\$ 62,36 45: R\$ 63,61 60: R\$ 64,88

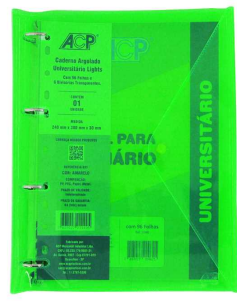

CADERNO ARG PVC 96FLS C/6DIV VERDE
Código: Fábrika: Unidade:
46088 ACP UN/1
F1 F4

UN: R\$ 61,89 AV: R\$ 61,89 15: R\$ 63,18
30: R\$ 64,44 45: R\$ 65,73 60: R\$ 67,05



CADERNO ARG PVC 96FLS POA C/6DIV LILAS
Código: Fábrika: Unidade:
46092 ACP UN/1
F1 F4

UN: R\$ 61,89 AV: R\$ 61,89 15: R\$ 63,18
30: R\$ 64,44 45: R\$ 65,73 60: R\$ 67,05

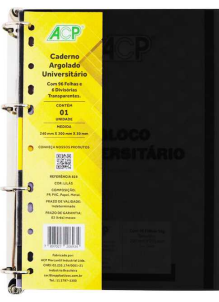

CADERNO ARG PVC 96FLS POA C/6DIV PRETO
Código: Fábrika: Unidade:
46094 ACP UN/1
F1 F4

UN: R\$ 61,89 AV: R\$ 61,89 15: R\$ 63,18
30: R\$ 64,44 45: R\$ 65,73 60: R\$ 67,05

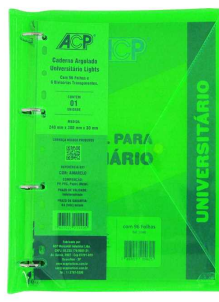

CADERNO ARG PVC 96FLS POA C/6DIV ROSA
Código: Fábrika: Unidade:
46095 ACP UN/1
F1 F4

UN: R\$ 83,86 AV: R\$ 83,86 15: R\$ 85,60
30: R\$ 87,31 45: R\$ 89,06 60: R\$ 90,84



CADERNO ARG 96FLS SWEET C/6DIV P LAP LIL
Código: Fábrica: Unidade:
46127 ACP UN/1
F1 F4

UN: R\$ 83,86 AV: R\$ 83,86 15: R\$ 85,60
30: R\$ 87,31 45: R\$ 89,06 60: R\$ 90,84



CADERNO ARG 96FLS SWEET C/6DIV P LAP ROS
Código: Fábrica: Unidade:
46126 ACP UN/1
F1 F4

UN: R\$ 18,96 AV: R\$ 189,65 15: R\$ 193,60
30: R\$ 197,47 45: R\$ 201,42 60: R\$ 205,45

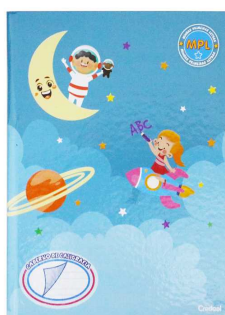

CADERNO BROCCD 40FLS CALIGRAFIA 10X1
Código: Fábrica: Unidade:
50702 CREDEAL PT/10
F1 F4

UN: R\$ 11,98 AV: R\$ 59,89 15: R\$ 61,14
30: R\$ 62,36 45: R\$ 63,61 60: R\$ 64,88



CADERNO BROCCD 80FLS C/P AMARELO 5X1
Código: Fábrica: Unidade:
49100 CREDEAL/MAXI PT/5
F1 F4

UN: R\$ 11,98 AV: R\$ 59,89 15: R\$ 61,14
30: R\$ 62,36 45: R\$ 63,61 60: R\$ 64,88



CADERNO BROCCD 80FLS C/P AZUL 5X1
Código: Fábrica: Unidade:
49099 CREDEAL/MAXI PT/5
F1 F4

UN: R\$ 13,98 AV: R\$ 69,88 15: R\$ 71,33
30: R\$ 72,76 45: R\$ 74,22 60: R\$ 75,70



CADERNO BROCCD 80FLS C/P LALA PETS 5X1
Código: Fábrica: Unidade:
43807 CREDEAL PT/5
F1 F4

UN: R\$ 11,98 AV: R\$ 59,89 15: R\$ 61,14
30: R\$ 62,36 45: R\$ 63,61 60: R\$ 64,88

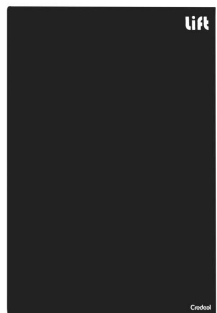

CADERNO BROCCD 80FLS C/P PRETO 5X1
Código: Fábrica: Unidade:
49103 CREDEAL PT/5
F1 F4

UN: R\$ 11,98 AV: R\$ 59,89 15: R\$ 61,14
30: R\$ 62,36 45: R\$ 63,61 60: R\$ 64,88



CADERNO BROCCD 80FLS C/P VERDE 5X1
Código: Fábrica: Unidade:
49102 CREDEAL/MAXI PT/5
F1 F4

UN: R\$ 11,98 AV: R\$ 59,89 15: R\$ 61,14
30: R\$ 62,36 45: R\$ 63,61 60: R\$ 64,88

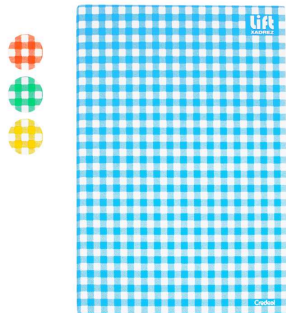

CADERNO BROCCD 80FLS C/P XADREZ 5X1
Código: Fábrica: Unidade:
49104 CREDEAL PT/5
F1 F4

UN: R\$ 12,98 AV: R\$ 64,89 15: R\$ 66,24
30: R\$ 67,56 45: R\$ 68,91 60: R\$ 70,29

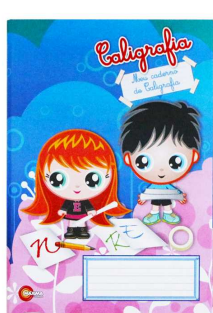

CADERNO BROCCD 96FLS CALIGRAFIA 5X1
Código: Fábrica: Unidade:
33996 MAXIMA PT/5
F1 F4

UN: R\$ 13,38 AV: R\$ 66,88 15: R\$ 68,28
30: R\$ 69,64 45: R\$ 71,03 60: R\$ 72,46

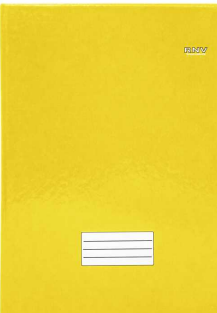

CADERNO BROCCD 96FLS C/P AMARELO 5X1
Código: Fábrica: Unidade:
19351 MAXIM/CREDEA PT/5
F1 F4

UN: R\$ 13,38 AV: R\$ 66,88 15: R\$ 68,28
30: R\$ 69,64 45: R\$ 71,03 60: R\$ 72,46



CADERNO BROCCD 96FLS C/P AZUL 5X1
Código: Fábrica: Unidade:
20603 MAXIMA PT/5
F1 F4

UN: R\$ 11,18 AV: R\$ 559,09 15: R\$ 570,74
30: R\$ 582,16 45: R\$ 593,80 60: R\$ 605,68



CADERNO BROCCD 96FLS C/P DEC FEM 50X1
Código: Fábrica: Unidade:
50893 MAXIMA CX/50
F1 F4

UN: R\$ 11,18 AV: R\$ 559,09 15: R\$ 570,74
30: R\$ 582,16 45: R\$ 593,80 60: R\$ 605,68



CADERNO BROCCD 96FLS C/P DEC MASC 50X1
Código: Fábrica: Unidade:
50894 MAXIMA CX/50
F1 F4

UN: R\$ 13,98 AV: R\$ 69,88 15: R\$ 71,33
30: R\$ 72,76 45: R\$ 74,22 60: R\$ 75,70

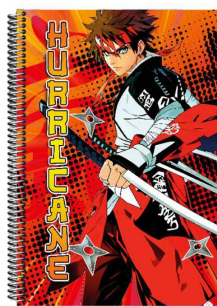

CADERNO BROCCD 96FLS C/P HURRACANE 5X1
Código: Fábrica: Unidade:
46626 MAXIMA PT/5
F1 F4

UN: R\$ 13,98 AV: R\$ 69,88 15: R\$ 71,33
30: R\$ 72,76 45: R\$ 74,22 60: R\$ 75,70



CADERNO BROCCD 96FLS C/P I LIKE 5X1
Código: Fábrica: Unidade:
43311 MAXIMA PT/5
F1 F4

UN: R\$ 13,98 AV: R\$ 69,88 15: R\$ 71,33
30: R\$ 72,76 45: R\$ 74,22 60: R\$ 75,70



CADERNO BROCD CD 96FLS C/P LALA FEM 5X1
Código: 43808 Fábrica: CREDEAL Unidade: PT/5 F1 F4

UN: R\$ 13,98 AV: R\$ 69,88 15: R\$ 71,33
30: R\$ 72,76 45: R\$ 74,22 60: R\$ 75,70



CADERNO BROCD CD 96FLS C/P LALA MASC 5X1
Código: 29792 Fábrica: CREDEAL Unidade: PT/5 F1 F4

UN: R\$ 13,38 AV: R\$ 66,88 15: R\$ 68,28
30: R\$ 69,64 45: R\$ 71,03 60: R\$ 72,46



CADERNO BROCD CD 96FLS C/P LARANJA 5X1
Código: 40827 Fábrica: MAXIMA Unidade: PT/5 F1 F4

UN: R\$ 13,98 AV: R\$ 69,88 15: R\$ 71,33
30: R\$ 72,76 45: R\$ 74,22 60: R\$ 75,70

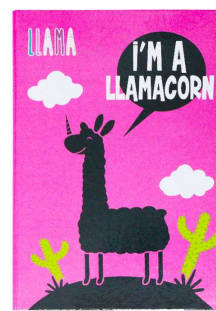

CADERNO BROCD CD 96FLS C/P LLAMAS 5X1
Código: 44979 Fábrica: MAXIMA Unidade: PT/5 F1 F4

UN: R\$ 13,98 AV: R\$ 69,88 15: R\$ 71,33
30: R\$ 72,76 45: R\$ 74,22 60: R\$ 75,70



CADERNO BROCD CD 96FLS C/P LOUISE 5X1
Código: 33263 Fábrica: MAXIMA Unidade: PT/5 F1 F4

UN: R\$ 13,98 AV: R\$ 69,88 15: R\$ 71,33
30: R\$ 72,76 45: R\$ 74,22 60: R\$ 75,70

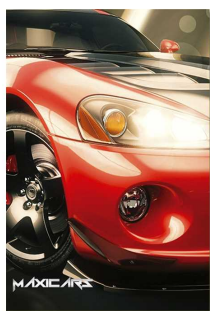

CADERNO BROCD CD 96FLS C/P MAXICARS 5X1
Código: 36291 Fábrica: MAXIMA Unidade: PT/5 F1 F4

UN: R\$ 13,38 AV: R\$ 66,88 15: R\$ 68,28
30: R\$ 69,64 45: R\$ 71,03 60: R\$ 72,46

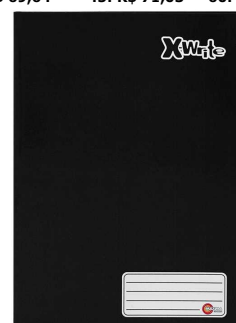

CADERNO BROCD CD 96FLS C/P PRETO 5X1
Código: 40826 Fábrica: MAXIMA Unidade: PT/5 F1 F4

UN: R\$ 13,98 AV: R\$ 69,88 15: R\$ 71,33
30: R\$ 72,76 45: R\$ 74,22 60: R\$ 75,70

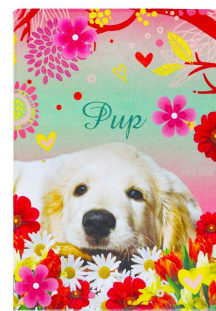

CADERNO BROCD CD 96FLS C/P PUP 5X1
Código: 33268 Fábrica: MAXIMA Unidade: PT/5 F1 F4

UN: R\$ 13,98 AV: R\$ 69,88 15: R\$ 71,33
30: R\$ 72,76 45: R\$ 74,22 60: R\$ 75,70



CADERNO BROCD CD 96FLS C/P SEASON 5X1
Código: 31549 Fábrica: MAXIMA Unidade: PT/5 F1 F4

UN: R\$ 13,38 AV: R\$ 66,88 15: R\$ 68,28
30: R\$ 69,64 45: R\$ 71,03 60: R\$ 72,46



CADERNO BROCD CD 96FLS C/P VERDE 5X1
Código: 23502 Fábrica: MAX/CRED/TIL Unidade: PT/5 F1 F4

UN: R\$ 13,38 AV: R\$ 66,88 15: R\$ 68,28
30: R\$ 69,64 45: R\$ 71,03 60: R\$ 72,46



CADERNO BROCD CD 96FLS C/P VERMELHO 5X1
Código: 20641 Fábrica: MAXIM/CREDEA Unidade: PT/5 F1 F4

UN: R\$ 13,38 AV: R\$ 66,88 15: R\$ 68,28
30: R\$ 69,64 45: R\$ 71,03 60: R\$ 72,46

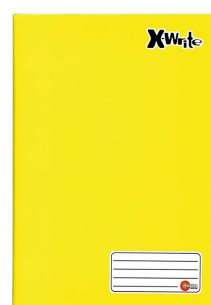

CADERNO BROCD CD 96FLS S/P AMARELO 5X1
Código: 20643 Fábrica: MAXIMA Unidade: PT/5 F1 F4

UN: R\$ 13,38 AV: R\$ 66,88 15: R\$ 68,28
30: R\$ 69,64 45: R\$ 71,03 60: R\$ 72,46



CADERNO BROCD CD 96FLS S/P AZUL 5X1
Código: 36312 Fábrica: MAXIMA Unidade: PT/5 F1 F4

UN: R\$ 13,98 AV: R\$ 69,88 15: R\$ 71,33
30: R\$ 72,76 45: R\$ 74,22 60: R\$ 75,70



CADERNO BROCD CD 96FLS S/P CORUJAS 5X1
Código: 49460 Fábrica: MAXIMA Unidade: PT/5 F1 F4

UN: R\$ 13,98 AV: R\$ 69,88 15: R\$ 71,33
30: R\$ 72,76 45: R\$ 74,22 60: R\$ 75,70



CADERNO BROCD CD 96FLS S/P FLAMINGOS 5X1
Código: 50891 Fábrica: MAXIMA Unidade: PT/5 F1 F4

UN: R\$ 13,98 AV: R\$ 69,88 15: R\$ 71,33
30: R\$ 72,76 45: R\$ 74,22 60: R\$ 75,70



CADERNO BROCD CD 96FLS S/P LOUISES 5X1
Código: 50890 Fábrica: MAXIMA Unidade: PT/5 F1 F4

UN: R\$ 13,38 AV: R\$ 66,88 15: R\$ 68,28
30: R\$ 69,64 45: R\$ 71,03 60: R\$ 72,46



CADERNO BROCCD 96FLS S/P VERDE 5X1
Código: Fábrica: Unidade:
20600 MAXIMA PT/5
F1 F4

UN: R\$ 13,38 AV: R\$ 66,88 15: R\$ 68,28
30: R\$ 69,64 45: R\$ 71,03 60: R\$ 72,46

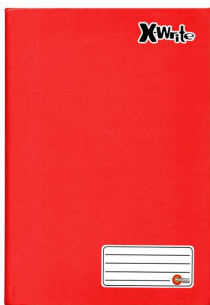

CADERNO BROCCD 96FLS S/P VERMELHO 5X1
Código: Fábrica: Unidade:
20604 MAXIMA PT/5
F1 F4

UN: R\$ 13,98 AV: R\$ 69,88 15: R\$ 71,33
30: R\$ 72,76 45: R\$ 74,22 60: R\$ 75,70

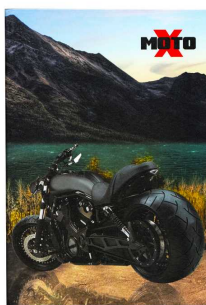

CADERNO BROCCD 96FLS S/P X-MOTO 5X1
Código: Fábrica: Unidade:
50892 MAXIMA PT/5
F1 F4

UN: R\$ 2,50 AV: R\$ 49,91 15: R\$ 50,95
30: R\$ 51,97 45: R\$ 53,01 60: R\$ 54,07



CADERNO BROCCF 40FL 1/4 CALIGRAFIA 20X1
Código: Fábrica: Unidade:
43376 CREDEAL PT/20
F1 F4

UN: R\$ 3,99 AV: R\$ 39,93 15: R\$ 40,76
30: R\$ 41,57 45: R\$ 42,40 60: R\$ 43,25



CADERNO BROCCF 48FLS CALIGRAFIA 10X1
Código: Fábrica: Unidade:
42917 NEEDS PT/10
F1 F4

UN: R\$ 11,98 AV: R\$ 119,80 15: R\$ 122,29
30: R\$ 124,74 45: R\$ 127,23 60: R\$ 129,78

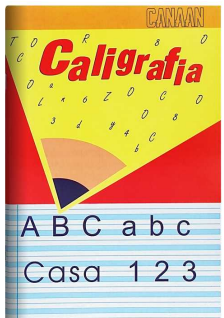

CADERNO BROCCF 60FLS CALIGRAFIA 10X1
Código: Fábrica: Unidade:
19853 MINEIRO PT/10
F1 F4

UN: R\$ 5,99 AV: R\$ 59,89 15: R\$ 61,14
30: R\$ 62,36 45: R\$ 63,61 60: R\$ 64,88



CADERNO BROCCF 60FLS C/P 10X1
Código: Fábrica: Unidade:
50903 MAXIMA PT/10
F1 F4

UN: R\$ 5,99 AV: R\$ 59,89 15: R\$ 61,14
30: R\$ 62,36 45: R\$ 63,61 60: R\$ 64,88



CADERNO BROCCF 60FLS S/P 10X1
Código: Fábrica: Unidade:
50904 MAXIMA PT/10
F1 F4

UN: R\$ 6,99 AV: R\$ 69,88 15: R\$ 71,33
30: R\$ 72,76 45: R\$ 74,22 60: R\$ 75,70



CADERNO BROCCF 80FL 1MA AMIGAS 10X1
Código: Fábrica: Unidade:
43818 FORONI PT/10
F1 F4

UN: R\$ 6,99 AV: R\$ 69,88 15: R\$ 71,33
30: R\$ 72,76 45: R\$ 74,22 60: R\$ 75,70



CADERNO BROCCF 80FLS 1MAT JUDY 10X1
Código: Fábrica: Unidade:
43832 FORONI PT/10
F1 F4

UN: R\$ 6,52 AV: R\$ 97,83 15: R\$ 99,87
30: R\$ 101,87 45: R\$ 103,91 60: R\$ 105,98



CADERNO BROCCF 60FLS C/P LALA 15X1
Código: Fábrica: Unidade:
19556 CREDEAL PT/15
F1 F4

UN: R\$ 6,49 AV: R\$ 64,89 15: R\$ 66,24
30: R\$ 67,56 45: R\$ 68,91 60: R\$ 70,29



CADERNO BROCCF 60FLS C/P 10X1
Código: Fábrica: Unidade:
9737 MAXIMA/JAND PT/10
F1 F4

UN: R\$ 8,49 AV: R\$ 84,85 15: R\$ 86,62
30: R\$ 88,35 45: R\$ 90,12 60: R\$ 91,92

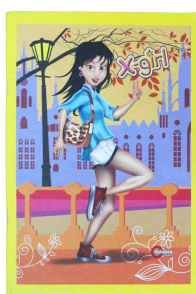

CADERNO BROCCF 80FLS C/P LALA 10X1
Código: Fábrica: Unidade:
4043 CREDEAL PT/10
F1 F4

UN: R\$ 8,49 AV: R\$ 84,85 15: R\$ 86,62
30: R\$ 88,35 45: R\$ 90,12 60: R\$ 91,92



CADERNO BROCCF 80FLS C/P 10X1
Código: Fábrica: Unidade:
14644 MAXIMA PT/10
F1 F4

UN: R\$ 8,98 AV: R\$ 89,85 15: R\$ 91,72
30: R\$ 93,55 45: R\$ 95,42 60: R\$ 97,33



CADERNO BROCCF 96FLS C/P 10X1
Código: Fábrica: Unidade:
40828 MAXIMA PT/10
F1 F4

UN: R\$ 8,29 AV: R\$ 82,86 15: R\$ 84,58
30: R\$ 86,28 45: R\$ 88,00 60: R\$ 89,76

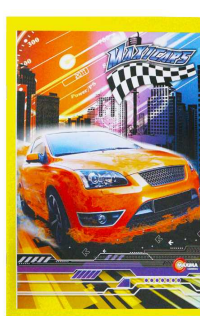

CADERNO BROCCF 96FLS S/P 10X1
Código: Fábrica: Unidade:
35513 MAXIMA/PANAM PT/10
F1 F4

UN: R\$ 5,98 AV: R\$ 5,98 15: R\$ 6,11
30: R\$ 6,23 45: R\$ 6,35 60: R\$ 6,48



CADERNO BROC 1/4 CD 40FLS PAUTA VERDE
Código: Fábriça: Unidade:
42308 NEEDS UN/1
F1 F4

UN: R\$ 5,79 AV: R\$ 28,94 15: R\$ 29,55
30: R\$ 30,14 45: R\$ 30,74 60: R\$ 31,36



CADERNO BROC 1/4 CD 96FLS CECI 5X1
Código: Fábriça: Unidade:
50896 MAXIMA PT/5
F1 F4

UN: R\$ 5,79 AV: R\$ 28,94 15: R\$ 29,55
30: R\$ 30,14 45: R\$ 30,74 60: R\$ 31,36



CADERNO BROC 1/4 CD 96FLS CHILLIN 5X1
Código: Fábriça: Unidade:
40824 MAXIMA PT/5
F1 F4

UN: R\$ 5,79 AV: R\$ 28,94 15: R\$ 29,55
30: R\$ 30,14 45: R\$ 30,74 60: R\$ 31,36



CADERNO BROC 1/4 CD 96FLS CORUJAS 5X1
Código: Fábriça: Unidade:
34003 MAXIMA PT/5
F1 F4

UN: R\$ 5,79 AV: R\$ 28,94 15: R\$ 29,55
30: R\$ 30,14 45: R\$ 30,74 60: R\$ 31,36

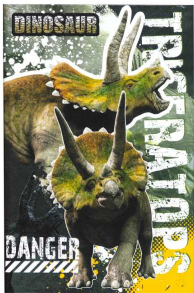

CADERNO BROC 1/4 CD 96FLS DINO 5X1
Código: Fábriça: Unidade:
36127 MAXIMA PT/5
F1 F4

UN: R\$ 5,79 AV: R\$ 28,94 15: R\$ 29,55
30: R\$ 30,14 45: R\$ 30,74 60: R\$ 31,36



CADERNO BROC 1/4 CD 96FLS FLAMINGO 5X1
Código: Fábriça: Unidade:
40841 MAXIMA PT/5
F1 F4

UN: R\$ 5,79 AV: R\$ 28,94 15: R\$ 29,55
30: R\$ 30,14 45: R\$ 30,74 60: R\$ 31,36

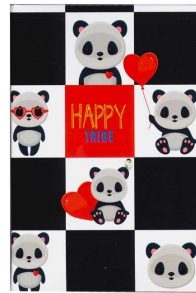

CADERNO BROC 1/4 CD 96FLS HAPPY TRIB 5X1
Código: Fábriça: Unidade:
50897 MAXIMA PT/5
F1 F4

UN: R\$ 5,79 AV: R\$ 28,94 15: R\$ 29,55
30: R\$ 30,14 45: R\$ 30,74 60: R\$ 31,36



CADERNO BROC 1/4 CD 96FLS HURRANE 5X1
Código: Fábriça: Unidade:
50895 MAXIMA PT/5
F1 F4

UN: R\$ 5,79 AV: R\$ 28,94 15: R\$ 29,55
30: R\$ 30,14 45: R\$ 30,74 60: R\$ 31,36

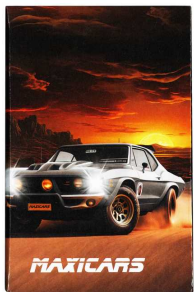

CADERNO BROC 1/4 CD 96FLS MAXICARS 5X1
Código: Fábriça: Unidade:
34434 MAXIMA PT/5
F1 F4

UN: R\$ 5,79 AV: R\$ 28,94 15: R\$ 29,55
30: R\$ 30,14 45: R\$ 30,74 60: R\$ 31,36



CADERNO BROC 1/4 CD 96FLS MERMAID 5X1
Código: Fábriça: Unidade:
40825 MAXIMA PT/5
F1 F4

UN: R\$ 5,79 AV: R\$ 28,94 15: R\$ 29,55
30: R\$ 30,14 45: R\$ 30,74 60: R\$ 31,36



CADERNO BROC 1/4 CD 96FLS PUP 5X1
Código: Fábriça: Unidade:
34004 MAXIMA PT/5
F1 F4

UN: R\$ 5,79 AV: R\$ 28,94 15: R\$ 29,55
30: R\$ 30,14 45: R\$ 30,74 60: R\$ 31,36



CADERNO BROC 1/4 CD 96FLS UNICORNS 5X1
Código: Fábriça: Unidade:
34006 MAXIMA PT/5
F1 F4

UN: R\$ 5,79 AV: R\$ 28,94 15: R\$ 29,55
30: R\$ 30,14 45: R\$ 30,74 60: R\$ 31,36



CADERNO BROC 1/4 CD 96FLS X-MOTO 5X1
Código: Fábriça: Unidade:
34010 MAXIMA PT/5
F1 F4

UN: R\$ 5,79 AV: R\$ 28,94 15: R\$ 29,55
30: R\$ 30,14 45: R\$ 30,74 60: R\$ 31,36



CADERNO BROC 1/4 CD 96FLS X-ROBOTS 5X1
Código: Fábriça: Unidade:
34011 MAXIMA PT/5
F1 F4

UN: R\$ 5,79 AV: R\$ 28,94 15: R\$ 29,55
30: R\$ 30,14 45: R\$ 30,74 60: R\$ 31,36

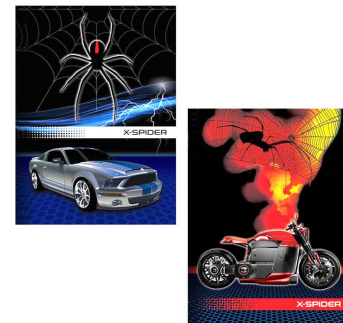

CADERNO BROC 1/4 CD 96FLS X-SPIDER 5X1
Código: Fábriça: Unidade:
34009 MAXIMA PT/5
F1 F4

UN: R\$ 2,49 AV: R\$ 49,80 15: R\$ 49,80
30: R\$ 49,80 45: R\$ 49,80 60: R\$ 49,80



CADERNO BROC 1/4 FLEX 48FLS C/P 20X1
Código: Fábriça: Unidade:
13440 MAXIM/CREDEA PT/20
F1 F4

UN: R\$ 3,49 AV: R\$ 69,88 15: R\$ 71,33
30: R\$ 72,76 45: R\$ 74,22 60: R\$ 75,70



CADERNO BROC 1/4 FLEX 60 FLS 20X1
Código: Fábrika: Unidade:
43269 JANDAINHA PT/20
F1 F4

UN: R\$ 4,49 AV: R\$ 44,92 15: R\$ 45,85
30: R\$ 46,77 45: R\$ 47,71 60: R\$ 48,66

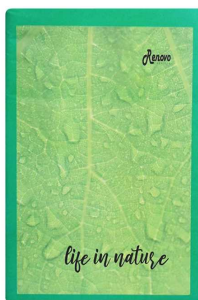

CADERNO BROC 1/4 FLEX 96FLS C/P 10X1
Código: Fábrika: Unidade:
160 MAXIMA/JA PT/10
F1 F4

UN: R\$ 2,79 AV: R\$ 27,95 15: R\$ 28,53
30: R\$ 29,10 45: R\$ 29,68 60: R\$ 30,27



CADERNO BROC 1/4 QUADRICULADO 80FLS 10X1
Código: Fábrika: Unidade:
44715 SULAMERICANA PT/10
F1 F4

UN: R\$ 2,94 AV: R\$ 58,90 15: R\$ 60,12
30: R\$ 61,33 45: R\$ 62,55 60: R\$ 63,80



CADERNO BROC 40 FLS 1/4 CALIGRAFIA 20X1
Código: Fábrika: Unidade:
14041 PANAMERICANA PT/20
F1 F4

UN: R\$ 10,98 AV: R\$ 54,90 15: R\$ 56,05
30: R\$ 57,17 45: R\$ 58,31 60: R\$ 59,48



CADERNO CD 1MAT 80 FLS POP 5X1
Código: Fábrika: Unidade:
34080 CADERSIL PT/5
F1 F4

UN: R\$ 12,47 AV: R\$ 49,88 15: R\$ 50,92
30: R\$ 51,94 45: R\$ 52,98 60: R\$ 54,04



CADERNO CD 1MAT 80FLS ESSENC PRETO 4X1
Código: Fábrika: Unidade:
50701 CREDEAL PT/4
F1 F4

UN: R\$ 11,98 AV: R\$ 59,89 15: R\$ 61,14
30: R\$ 62,36 45: R\$ 63,61 60: R\$ 64,88



CADERNO CD 1MAT 80FLS ESSENCIALE 5X1
Código: Fábrika: Unidade:
43658 CREDEAL PT/5
F1 F4

UN: R\$ 12,48 AV: R\$ 49,91 15: R\$ 50,95
30: R\$ 51,97 45: R\$ 53,01 60: R\$ 54,07



CADERNO CD 1MAT 80FLS MY COLL MASC 4X1
Código: Fábrika: Unidade:
50417 CREDEAL PT/4
F1 F4

UN: R\$ 12,48 AV: R\$ 49,91 15: R\$ 50,95
30: R\$ 51,97 45: R\$ 53,01 60: R\$ 54,07



CADERNO CD 1MAT 80FLS PERFORMANCE 4X1
Código: Fábrika: Unidade:
49105 CREDEAL PT/4
F1 F4

UN: R\$ 14,97 AV: R\$ 14,97 15: R\$ 15,28
30: R\$ 15,58 45: R\$ 15,90 60: R\$ 16,21



CADERNO CD 1MAT 96FLS AYRTON SENA UN
Código: Fábrika: Unidade:
40099 POMBO UN/1
F1 F4

UN: R\$ 14,97 AV: R\$ 89,85 15: R\$ 91,72
30: R\$ 93,55 45: R\$ 95,42 60: R\$ 97,33

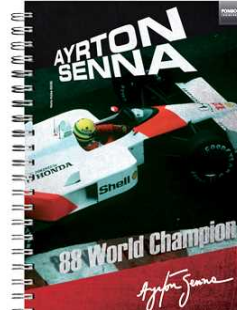

CADERNO CD 1MAT 96FLS AYRTON SENA 6X1
Código: Fábrika: Unidade:
27829 POMBO PT/6
F1 F4

UN: R\$ 10,97 AV: R\$ 65,83 15: R\$ 67,21
30: R\$ 68,55 45: R\$ 69,92 60: R\$ 71,32

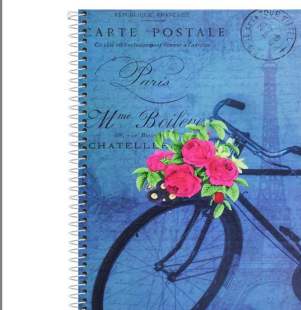

CADERNO CD 1MAT 96FLS BICYCLE 6X1
Código: Fábrika: Unidade:
33757 MAXIMA PT/6
F1 F4

UN: R\$ 11,65 AV: R\$ 69,88 15: R\$ 71,33
30: R\$ 72,76 45: R\$ 74,22 60: R\$ 75,70

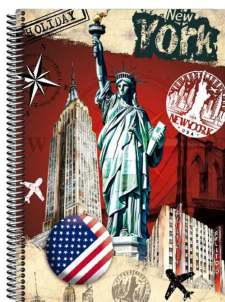

CADERNO CD 1MAT 96FLS CITY TOUR 6X1
Código: Fábrika: Unidade:
33269 MAXIMA PT/6
F1 F4

UN: R\$ 12,15 AV: R\$ 72,87 15: R\$ 74,39
30: R\$ 75,88 45: R\$ 77,40 60: R\$ 78,94



CADERNO CD 1MAT 96FLS COPDOGS B/A 6X1
Código: Fábrika: Unidade:
50901 MAXIMA PT/6
F1 F4

UN: R\$ 12,15 AV: R\$ 72,87 15: R\$ 74,39
30: R\$ 75,88 45: R\$ 77,40 60: R\$ 78,94



CADERNO CD 1MAT 96FLS DINO B/A 6X1
Código: Fábrika: Unidade:
36305 MAXIMA PT/6
F1 F4

UN: R\$ 12,15 AV: R\$ 72,87 15: R\$ 74,39
30: R\$ 75,88 45: R\$ 77,40 60: R\$ 78,94



CADERNO CD 1MAT 96FLS FLAMINGO B/A 6X1
Código: Fábrika: Unidade:
33777 MAXIMA PT/6
F1 F4

UN: R\$ 11,65 AV: R\$ 69,88 15: R\$ 71,33
30: R\$ 72,76 45: R\$ 74,22 60: R\$ 75,70

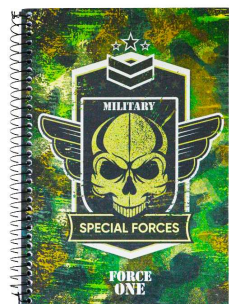

CADERNO CD 1MAT 96FLS FORCE ONE 6X1

Código: Fábrika: Unidade:
44814 MAXIMA PT/6
F1 F4

UN: R\$ 12,15 AV: R\$ 72,87 15: R\$ 74,39
30: R\$ 75,88 45: R\$ 77,40 60: R\$ 78,94



CADERNO CD 1MAT 96FLS FURRY BEA B/A 6X1

Código: Fábrika: Unidade:
37733 MAXIMA PT/6
F1 F4

UN: R\$ 14,97 AV: R\$ 14,97 15: R\$ 15,28
30: R\$ 15,58 45: R\$ 15,90 60: R\$ 16,21

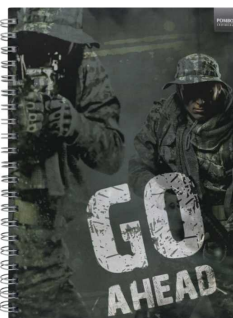

CADERNO CD 1MAT 96FLS GO AHEAD UN

Código: Fábrika: Unidade:
33356 POMBO UN/1
F1 F4

UN: R\$ 11,65 AV: R\$ 69,88 15: R\$ 71,33
30: R\$ 72,76 45: R\$ 74,22 60: R\$ 75,70

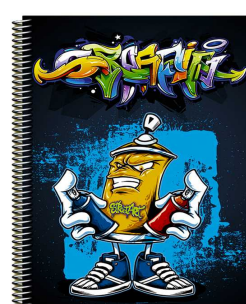

CADERNO CD 1MAT 96FLS GRAFFIX 6X1

Código: Fábrika: Unidade:
36131 MAXIMA PT/6
F1 F4

UN: R\$ 13,73 AV: R\$ 54,90 15: R\$ 56,05
30: R\$ 57,17 45: R\$ 58,31 60: R\$ 59,48

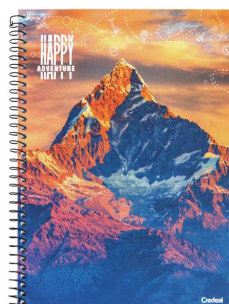

CADERNO CD 1MAT 96FLS HAPPY ADVENTU 4X1

Código: Fábrika: Unidade:
45838 CREDEAL PT/4
F1 F4

UN: R\$ 72,87 AV: R\$ 72,87 15: R\$ 74,39
30: R\$ 75,88 45: R\$ 77,40 60: R\$ 78,94



CADERNO CD 1MAT 96FLS HAPPY TRI B/A 5X1

Código: Fábrika: Unidade:
23718 MAXIMA UN/1
F1 F4

UN: R\$ 11,65 AV: R\$ 69,88 15: R\$ 71,33
30: R\$ 72,76 45: R\$ 74,22 60: R\$ 75,70



CADERNO CD 1MAT 96FLS JEANS WORLD 6X1

Código: Fábrika: Unidade:
29793 MAXIMA PT/6
F1 F4

UN: R\$ 11,65 AV: R\$ 69,88 15: R\$ 71,33
30: R\$ 72,76 45: R\$ 74,22 60: R\$ 75,70



CADERNO CD 1MAT 96FLS LINDINHAS 6X1

Código: Fábrika: Unidade:
26482 MAXIMA PT/6
F1 F4

UN: R\$ 12,15 AV: R\$ 72,87 15: R\$ 74,39
30: R\$ 75,88 45: R\$ 77,40 60: R\$ 78,94



CADERNO CD 1MAT 96FLS LOUISE B/A 6X1

Código: Fábrika: Unidade:
37735 MAXIMA PT/6
F1 F4

UN: R\$ 11,65 AV: R\$ 69,88 15: R\$ 71,33
30: R\$ 72,76 45: R\$ 74,22 60: R\$ 75,70

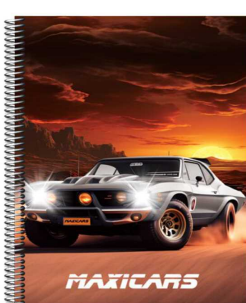

CADERNO CD 1MAT 96FLS MAXICARS 6X1

Código: Fábrika: Unidade:
26637 MAXIMA PT/6
F1 F4

UN: R\$ 11,65 AV: R\$ 69,88 15: R\$ 71,33
30: R\$ 72,76 45: R\$ 74,22 60: R\$ 75,70



CADERNO CD 1MAT 96FLS NATURE 6X1

Código: Fábrika: Unidade:
34308 MAXIMA PT/6
F1 F4

UN: R\$ 11,65 AV: R\$ 69,88 15: R\$ 71,33
30: R\$ 72,76 45: R\$ 74,22 60: R\$ 75,70



CADERNO CD 1MAT 96FLS OP ART 6X1

Código: Fábrika: Unidade:
40833 MAXIMA PT/6
F1 F4

UN: R\$ 11,65 AV: R\$ 69,88 15: R\$ 71,33
30: R\$ 72,76 45: R\$ 74,22 60: R\$ 75,70

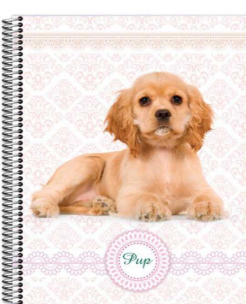

CADERNO CD 1MAT 96FLS PUP 6X1

Código: Fábrika: Unidade:
26478 MAXIMA PT/6
F1 F4

UN: R\$ 12,15 AV: R\$ 72,87 15: R\$ 74,39
30: R\$ 75,88 45: R\$ 77,40 60: R\$ 78,94

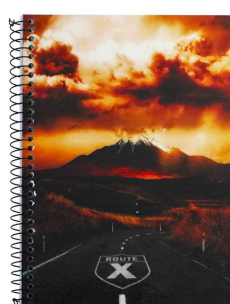

CADERNO CD 1MAT 96FLS ROUTE B/A 6X1

Código: Fábrika: Unidade:
50900 MAXIMA PT/6
F1 F4

UN: R\$ 12,15 AV: R\$ 72,87 15: R\$ 74,39
30: R\$ 75,88 45: R\$ 77,40 60: R\$ 78,94



CADERNO CD 1MAT 96FLS SEASON B/A 6X1

Código: Fábrika: Unidade:
33758 MAXIMA PT/6
F1 F4

UN: R\$ 11,65 AV: R\$ 69,88 15: R\$ 71,33
30: R\$ 72,76 45: R\$ 74,22 60: R\$ 75,70

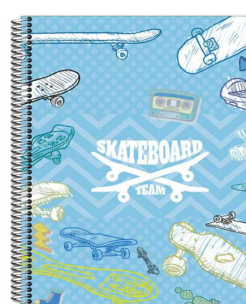

CADERNO CD 1MAT 96FLS SKATE 6X1

Código: Fábrika: Unidade:
37825 MAXIMA PT/6
F1 F4

UN: R\$ 12,15 AV: R\$ 72,87 15: R\$ 74,39
30: R\$ 75,88 45: R\$ 77,40 60: R\$ 78,94



CADERNO CD 1MAT 96FLS SUPER CHI B/A 6X1
Código: Fábrika: Unidade:
37990 MAXIMA PT/6
F1 F4

UN: R\$ 11,65 AV: R\$ 69,88 15: R\$ 71,33
30: R\$ 72,76 45: R\$ 74,22 60: R\$ 75,70

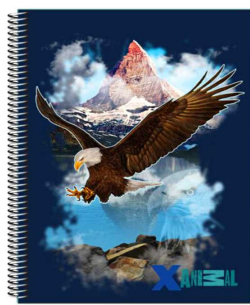

CADERNO CD 1MAT 96FLS X-ANIMAL 6X1
Código: Fábrika: Unidade:
26480 MAXIMA PT/6
F1 F4

UN: R\$ 12,15 AV: R\$ 72,87 15: R\$ 74,39
30: R\$ 75,88 45: R\$ 77,40 60: R\$ 78,94

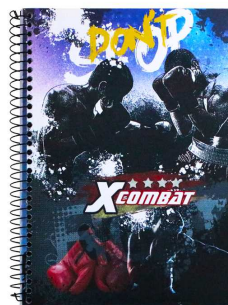

CADERNO CD 1MAT 96FLS X-COMBAT B/A 6X1
Código: Fábrika: Unidade:
30653 MAXIMA PT/6
F1 F4

UN: R\$ 11,65 AV: R\$ 69,88 15: R\$ 71,33
30: R\$ 72,76 45: R\$ 74,22 60: R\$ 75,70

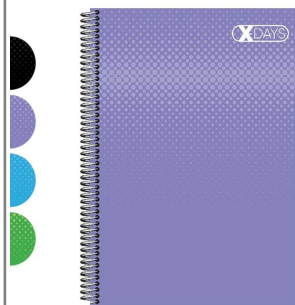

CADERNO CD 1MAT 96FLS X-DAYS 6X1
Código: Fábrika: Unidade:
50703 MAXIMA PT/6
F1 F4

UN: R\$ 11,65 AV: R\$ 69,88 15: R\$ 71,33
30: R\$ 72,76 45: R\$ 74,22 60: R\$ 75,70

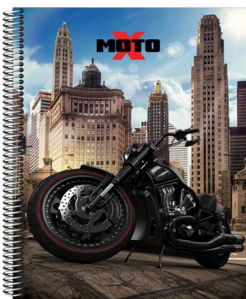

CADERNO CD 1MAT 96FLS X-MOTO 6X1
Código: Fábrika: Unidade:
26676 MAXIMA PT/6
F1 F4

UN: R\$ 11,65 AV: R\$ 69,88 15: R\$ 71,33
30: R\$ 72,76 45: R\$ 74,22 60: R\$ 75,70



CADERNO CD 1MAT 96FLS X-PHOTO 6X1
Código: Fábrika: Unidade:
27459 MAXIMA PT/6
F1 F4

UN: R\$ 11,65 AV: R\$ 69,88 15: R\$ 71,33
30: R\$ 72,76 45: R\$ 74,22 60: R\$ 75,70

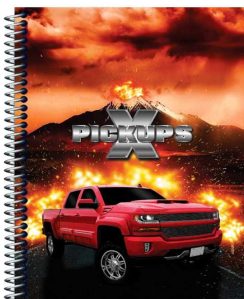

CADERNO CD 1MAT 96FLS X-PICKUP 6X1
Código: Fábrika: Unidade:
26484 MAXIMA PT/6
F1 F4

UN: R\$ 11,65 AV: R\$ 69,88 15: R\$ 71,33
30: R\$ 72,76 45: R\$ 74,22 60: R\$ 75,70

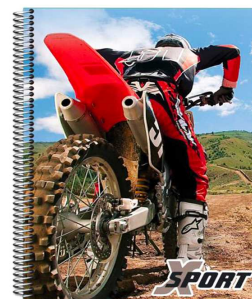

CADERNO CD 1MAT 96FLS X-SPORT 6X1
Código: Fábrika: Unidade:
29812 MAXIMA PT/6
F1 F4

UN: R\$ 11,65 AV: R\$ 69,88 15: R\$ 71,33
30: R\$ 72,76 45: R\$ 74,22 60: R\$ 75,70



CADERNO CD 1MAT 96FLS X-STUDIO 6X1
Código: Fábrika: Unidade:
32516 MAXIMA PT/6
F1 F4

UN: R\$ 11,65 AV: R\$ 69,88 15: R\$ 71,33
30: R\$ 72,76 45: R\$ 74,22 60: R\$ 75,70

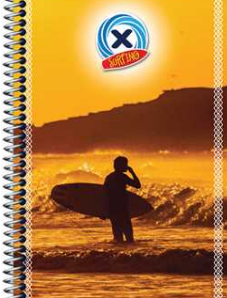

CADERNO CD 1MAT 96FLS X-SURFING 6X1
Código: Fábrika: Unidade:
33270 MAXIMA PT/6
F1 F4

UN: R\$ 12,48 AV: R\$ 49,91 15: R\$ 50,95
30: R\$ 51,97 45: R\$ 53,01 60: R\$ 54,07



CADERNO CD 1MAT 96FLS 177X240MM 4X1
Código: Fábrika: Unidade:
50440 TILIBRA PT/4
F1 F4

UN: R\$ 8,98 AV: R\$ 8,98 15: R\$ 9,16
30: R\$ 9,35 45: R\$ 9,53 60: R\$ 9,72



CADERNO CD PEDAG QUADRICULADO 48FLS UN
Código: Fábrika: Unidade:
45827 NEEDS UN/1
F1 F4

UN: R\$ 8,98 AV: R\$ 89,85 15: R\$ 91,72
30: R\$ 93,55 45: R\$ 95,42 60: R\$ 97,33



CADERNO CD PEDAG QUADRICULADO 48FLS 10X1
Código: Fábrika: Unidade:
45822 NEEDS PT/10
F1 F4

UN: R\$ 18,22 AV: R\$ 72,87 15: R\$ 74,39
30: R\$ 75,88 45: R\$ 77,40 60: R\$ 78,94

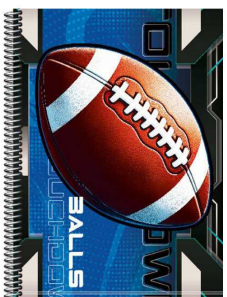

CADERNO CD 10MAT 160FLS BALLS 4X1
Código: Fábrika: Unidade:
50898 MAXIMA PT/4
F1 F4

UN: R\$ 22,95 AV: R\$ 22,95 15: R\$ 23,43
30: R\$ 23,90 45: R\$ 24,38 60: R\$ 24,87



CADERNO CD 10MAT 160FLS GO AHEAD UN
Código: Fábrika: Unidade:
33361 POMBO UN/1
F1 F4

UN: R\$ 24,96 AV: R\$ 149,75 15: R\$ 152,87
30: R\$ 155,93 45: R\$ 159,05 60: R\$ 162,23



CADERNO CD 10MAT 160FLS GO AHEAD 6X1
Código: Fábrika: Unidade:
32805 POMBO PT/6
F1 F4

UN: R\$ 18,22 AV: R\$ 72,87 15: R\$ 74,39
30: R\$ 75,88 45: R\$ 77,40 60: R\$ 78,94

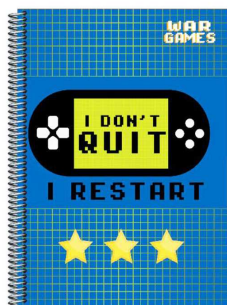

CADERNO CD 10MAT 160FLS WAR GAME 4X1
Código: 50899 Fábrica: MAXIMA Unidade: PT/4 F1 F4

UN: R\$ 19,96 AV: R\$ 59,89 15: R\$ 61,14
30: R\$ 62,36 45: R\$ 63,61 60: R\$ 64,88



CADERNO CD 10MAT 200 FLS X-SPIDE B/A 3X1
Código: 38175 Fábrica: MAXIMA Unidade: PT/3 F1 F4

UN: R\$ 21,96 AV: R\$ 87,85 15: R\$ 89,68
30: R\$ 91,47 45: R\$ 93,30 60: R\$ 95,17

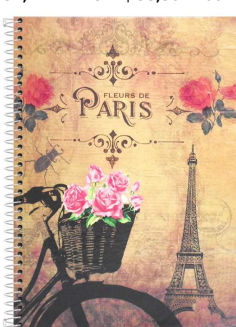

CADERNO CD 10MAT 200FLS BICYCLE 4X1
Código: 33766 Fábrica: MAXIMA Unidade: PT/4 F1 F4

UN: R\$ 20,96 AV: R\$ 83,83 15: R\$ 85,57
30: R\$ 87,28 45: R\$ 89,03 60: R\$ 90,81

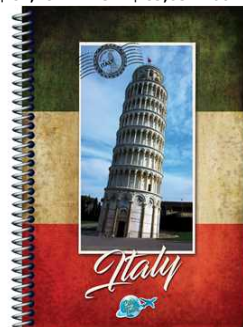

CADERNO CD 10MAT 200FLS CITY TOUR 4X1
Código: 33261 Fábrica: MAXIMA Unidade: PT/4 F1 F4

UN: R\$ 21,96 AV: R\$ 87,85 15: R\$ 89,68
30: R\$ 91,47 45: R\$ 93,30 60: R\$ 95,17



CADERNO CD 10MAT 200FLS FORCE ONE 4X1
Código: 50709 Fábrica: MAXIMA Unidade: PT/4 F1 F4

UN: R\$ 24,95 AV: R\$ 99,80 15: R\$ 101,88
30: R\$ 103,92 45: R\$ 106,00 60: R\$ 108,12

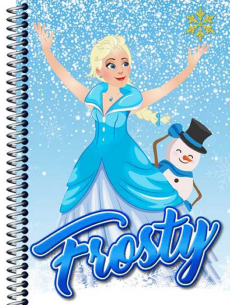

CADERNO CD 10MAT 200FLS FROSTY B/A 4X1
Código: 33765 Fábrica: MAXIMA Unidade: PT/4 F1 F4

UN: R\$ 21,96 AV: R\$ 87,85 15: R\$ 89,68
30: R\$ 91,47 45: R\$ 93,30 60: R\$ 95,17

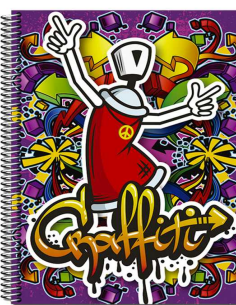

CADERNO CD 10MAT 200FLS GRAFFIX 4X1
Código: 36289 Fábrica: MAXIMA Unidade: PT/4 F1 F4

UN: R\$ 26,29 AV: R\$ 78,86 15: R\$ 80,51
30: R\$ 82,12 45: R\$ 83,76 60: R\$ 85,43

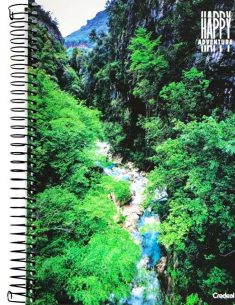

CADERNO CD 10MAT 200FLS HAPPY ADVENT 3X1
Código: 43657 Fábrica: CREDEAL Unidade: PT/3 F1 F4

UN: R\$ 20,96 AV: R\$ 83,83 15: R\$ 85,57
30: R\$ 87,28 45: R\$ 89,03 60: R\$ 90,81



CADERNO CD 10MAT 200FLS JEANS WORLD 4X1
Código: 24633 Fábrica: MAXIMA Unidade: PT/4 F1 F4

UN: R\$ 21,96 AV: R\$ 87,85 15: R\$ 89,68
30: R\$ 91,47 45: R\$ 93,30 60: R\$ 95,17

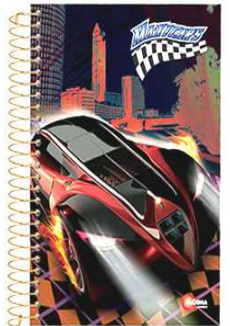

CADERNO CD 10MAT 200FLS MAXICARS 4X1
Código: 24635 Fábrica: MAXIMA Unidade: PT/4 F1 F4

UN: R\$ 24,96 AV: R\$ 74,87 15: R\$ 76,43
30: R\$ 77,96 45: R\$ 79,52 60: R\$ 81,11



CADERNO CD 10MAT 200FLS MY COLL FEM 3X1
Código: 43804 Fábrica: CREDEAL Unidade: PT/3 F1 F4

UN: R\$ 23,29 AV: R\$ 69,88 15: R\$ 71,33
30: R\$ 72,76 45: R\$ 74,22 60: R\$ 75,70



CADERNO CD 10MAT 200FLS MY COLL MASC 3X1
Código: 43803 Fábrica: CREDEAL Unidade: PT/3 F1 F4

UN: R\$ 20,96 AV: R\$ 83,83 15: R\$ 85,57
30: R\$ 87,28 45: R\$ 89,03 60: R\$ 90,81

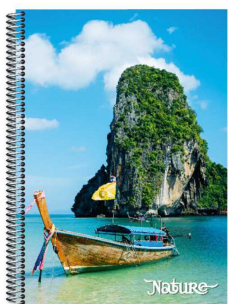

CADERNO CD 10MAT 200FLS NATURE 4X1
Código: 50706 Fábrica: MAXIMA Unidade: PT/4 F1 F4

UN: R\$ 24,95 AV: R\$ 99,80 15: R\$ 101,88
30: R\$ 103,92 45: R\$ 106,00 60: R\$ 108,12



CADERNO CD 10MAT 200FLS PUP B/A4X1
Código: 37682 Fábrica: MAXIMA Unidade: PT/4 F1 F4

UN: R\$ 21,96 AV: R\$ 87,85 15: R\$ 89,68
30: R\$ 91,47 45: R\$ 93,30 60: R\$ 95,17

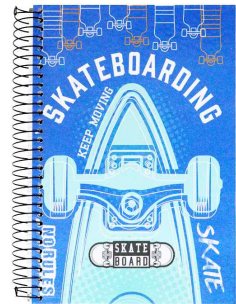

CADERNO CD 10MAT 200FLS SKATE 4X1
Código: 34348 Fábrica: MAXIMA Unidade: PT/4 F1 F4

UN: R\$ 21,96 AV: R\$ 87,85 15: R\$ 89,68
30: R\$ 91,47 45: R\$ 93,30 60: R\$ 95,17

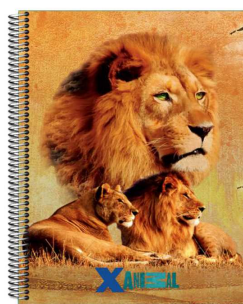

CADERNO CD 10MAT 200FLS X-ANIMAL 4X1
Código: 24634 Fábrica: MAXIMA Unidade: PT/4 F1 F4

UN: R\$ 21,96 AV: R\$ 87,85 15: R\$ 89,68
30: R\$ 91,47 45: R\$ 93,30 60: R\$ 95,17

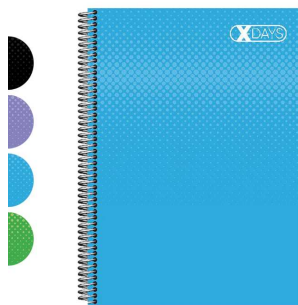

CADERNO CD 10MAT 200FLS X-DAYS 4X1
Código: Fábrica: Unidade:
50704 MAXIMA PT/4
F1 F4

UN: R\$ 21,96 AV: R\$ 87,85 15: R\$ 89,68
30: R\$ 91,47 45: R\$ 93,30 60: R\$ 95,17

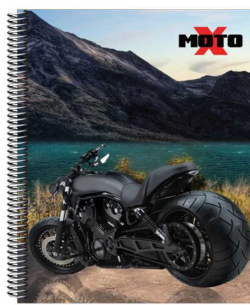

CADERNO CD 10MAT 200FLS X-MOTO 4X1
Código: Fábrica: Unidade:
20653 MAXIMA PT/4
F1 F4

UN: R\$ 21,96 AV: R\$ 87,85 15: R\$ 89,68
30: R\$ 91,47 45: R\$ 93,30 60: R\$ 95,17



CADERNO CD 10MAT 200FLS X-PHOTO 4X1
Código: Fábrica: Unidade:
24319 MAXIMA PT/4
F1 F4

UN: R\$ 21,96 AV: R\$ 87,85 15: R\$ 89,68
30: R\$ 91,47 45: R\$ 93,30 60: R\$ 95,17

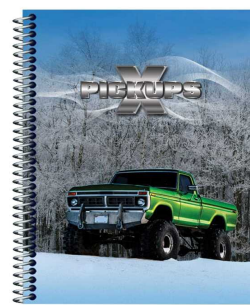

CADERNO CD 10MAT 200FLS X-PICKUP 4X1
Código: Fábrica: Unidade:
26288 MAXIMA PT/4
F1 F4

UN: R\$ 21,96 AV: R\$ 87,85 15: R\$ 89,68
30: R\$ 91,47 45: R\$ 93,30 60: R\$ 95,17



CADERNO CD 10MAT 200FLS X-SPORTS 4X1
Código: Fábrica: Unidade:
24305 MAXIMA PT/4
F1 F4

UN: R\$ 21,96 AV: R\$ 87,85 15: R\$ 89,68
30: R\$ 91,47 45: R\$ 93,30 60: R\$ 95,17

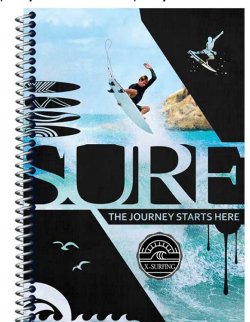

CADERNO CD 10MAT 200FLS X-SURFING 4X1
Código: Fábrica: Unidade:
28777 MAXIMA PT/4
F1 F4

UN: R\$ 6,99 AV: R\$ 6,99 15: R\$ 6,99
30: R\$ 6,99 45: R\$ 6,99 60: R\$ 6,99



CADERNO CD 1/4 ESP 96FLS UN
Código: Fábrica: Unidade:
45865 SULAMERICANA PT/1
F1 F4

UN: R\$ 10,89 AV: R\$ 10,89 15: R\$ 10,89
30: R\$ 10,89 45: R\$ 10,89 60: R\$ 10,89

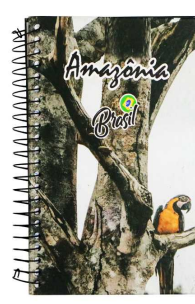

CADERNO CD 1/4 ESP 200FLS UN
Código: Fábrica: Unidade:
45768 NEEDS UN/1
F1 F4

UN: R\$ 10,98 AV: R\$ 43,92 15: R\$ 44,83
30: R\$ 45,73 45: R\$ 46,65 60: R\$ 47,58



CADERNO CD 1/4 ESP 200FLS X-PHOTO 4X1
Código: Fábrica: Unidade:
34013 MAXIMA PT/4
F1 F4

UN: R\$ 31,61 AV: R\$ 94,84 15: R\$ 96,81
30: R\$ 98,75 45: R\$ 100,73 60: R\$ 102,74

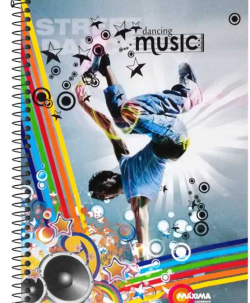

CADERNO CD 15MAT 300FLS DANCING B/A 3X1
Código: Fábrica: Unidade:
36669 MAXIMA PT/3
F1 F4

UN: R\$ 31,61 AV: R\$ 94,84 15: R\$ 96,81
30: R\$ 98,75 45: R\$ 100,73 60: R\$ 102,74

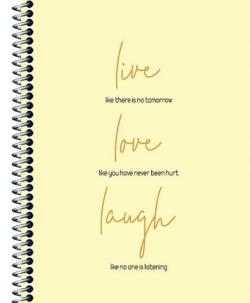

CADERNO CD 15MAT 300FLS I LIKE B/A 3X1
Código: Fábrica: Unidade:
36134 MAXIMA PT/3
F1 F4

UN: R\$ 26,62 AV: R\$ 79,86 15: R\$ 81,53
30: R\$ 83,16 45: R\$ 84,82 60: R\$ 86,52

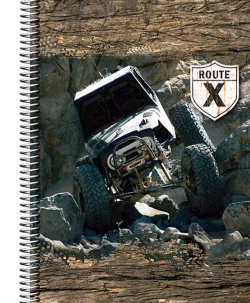

CADERNO CD 15MAT 300FLS ROUTE 3X1
Código: Fábrica: Unidade:
37992 MAXIMA PT/3
F1 F4

UN: R\$ 26,62 AV: R\$ 79,86 15: R\$ 81,53
30: R\$ 83,16 45: R\$ 84,82 60: R\$ 86,52



CADERNO CD 15MAT 300FLS WONDERLA B/A 3X1
Código: Fábrica: Unidade:
36687 MAXIMA PT/3
F1 F4

UN: R\$ 29,28 AV: R\$ 87,85 15: R\$ 89,68
30: R\$ 91,47 45: R\$ 93,30 60: R\$ 95,17



CADERNO CD 15MAT 300FLS X-ANIMAL 3X1
Código: Fábrica: Unidade:
20658 MAXIMA PT/3
F1 F4

UN: R\$ 29,28 AV: R\$ 87,85 15: R\$ 89,68
30: R\$ 91,47 45: R\$ 93,30 60: R\$ 95,17



CADERNO CD 15MAT 300FLS X-DAYS 3X1
Código: Fábrica: Unidade:
50705 MAXIMA PT/3
F1 F4

UN: R\$ 28,28 AV: R\$ 84,85 15: R\$ 86,62
30: R\$ 88,35 45: R\$ 90,12 60: R\$ 91,92



CADERNO CD 15MAT 300FLS X-GIRLS 3X1
Código: Fábrica: Unidade:
24380 MAXIMA PT/3
F1 F4

UN: R\$ 29,28 AV: R\$ 87,85 15: R\$ 89,68
30: R\$ 91,47 45: R\$ 93,30 60: R\$ 95,17



CADERNO CD 15MAT 300FLS X-PHOTO 3X1

Código: Fábrika: Unidade:
24308 MAXIMA PT/3
F1 F4

UN: R\$ 26,62 AV: R\$ 79,86 15: R\$ 81,53
30: R\$ 83,16 45: R\$ 84,82 60: R\$ 86,52

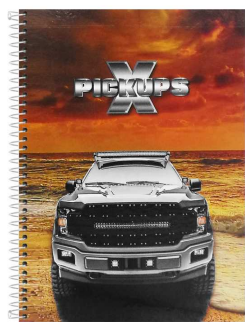

CADERNO CD 15MAT 300FLS X-PICKUP 3X1

Código: Fábrika: Unidade:
33769 MAXIMA PT/3
F1 F4

UN: R\$ 28,95 AV: R\$ 86,85 15: R\$ 88,66
30: R\$ 90,43 45: R\$ 92,24 60: R\$ 94,09



CADERNO CD 16MAT 320FLS LINDINHAS 3X1

Código: Fábrika: Unidade:
37821 MAXIMA PT/3
F1 F4

UN: R\$ 37,44 AV: R\$ 74,87 15: R\$ 76,43
30: R\$ 77,96 45: R\$ 79,52 60: R\$ 81,11

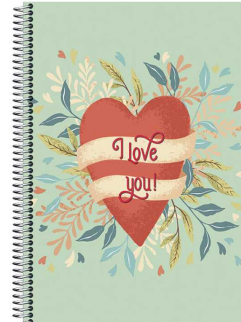

CADERNO CD 20MAT 400FLS LOVE B/A 2X1

Código: Fábrika: Unidade:
37988 MAXIMA PT/2
F1 F4

UN: R\$ 44,92 AV: R\$ 89,85 15: R\$ 91,72
30: R\$ 93,55 45: R\$ 95,42 60: R\$ 97,33



CADERNO CD 20MAT 400FLS SPACE B/A 2X1

Código: Fábrika: Unidade:
38164 PANAMERICANA PT/2
F1 F4

UN: R\$ 44,92 AV: R\$ 89,85 15: R\$ 91,72
30: R\$ 93,55 45: R\$ 95,42 60: R\$ 97,33

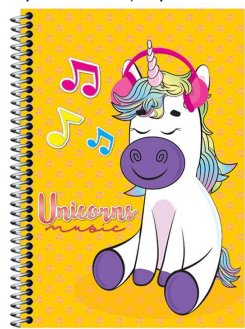

CADERNO CD 20MAT 400FLS UNICORNS B/A2X1

Código: Fábrika: Unidade:
36650 MAXIMA PT/2
F1 F4

UN: R\$ 42,93 AV: R\$ 85,85 15: R\$ 87,64
30: R\$ 89,39 45: R\$ 91,18 60: R\$ 93,01



CADERNO CD 20MAT 400FLS X-GIRLS 2X1

Código: Fábrika: Unidade:
24383 MAXIMA PT/2
F1 F4

UN: R\$ 37,44 AV: R\$ 74,87 15: R\$ 76,43
30: R\$ 77,96 45: R\$ 79,52 60: R\$ 81,11

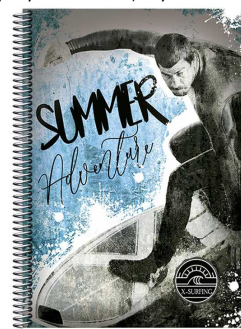

CADERNO CD 20MAT 400FLS X-SURFIN B/A 2X1

Código: Fábrika: Unidade:
37823 MAXIMA PT/2
F1 F4

UN: R\$ 36,29 AV: R\$ 72,58 15: R\$ 74,10
30: R\$ 75,58 45: R\$ 77,09 60: R\$ 78,63



CADERNO CD 20MAT 400FLS X-SURFING 2X1

Código: Fábrika: Unidade:
33776 MAXIMA PT/2
F1 F4

UN: R\$ 11,97 AV: R\$ 11,97 15: R\$ 12,22
30: R\$ 12,46 45: R\$ 12,71 60: R\$ 12,97



CADERNO CD 40FLS CALIGRA 19X24CM PAUVERD

Código: Fábrika: Unidade:
48077 SAO DOMINGOS UN/1
F1 F4

UN: R\$ 9,47 AV: R\$ 9,47 15: R\$ 9,67
30: R\$ 9,87 45: R\$ 10,06 60: R\$ 10,26



CADERNO COST C/FLEX 25X18CM 32FLS C/P UN

Código: Fábrika: Unidade:
47917 YIN'S PAPER UN/1
F1 F4

UN: R\$ 3,99 AV: R\$ 39,93 15: R\$ 40,76
30: R\$ 41,57 45: R\$ 42,40 60: R\$ 43,25



CADERNO COST 1/4 CD 48FLS AMARE C/P10X1

Código: Fábrika: Unidade:
24896 MAXIMA PT/10
F1 F4

UN: R\$ 3,99 AV: R\$ 39,93 15: R\$ 40,76
30: R\$ 41,57 45: R\$ 42,40 60: R\$ 43,25



CADERNO COST 1/4 CD 48FLS AZUL C/P 10X1

Código: Fábrika: Unidade:
23221 MAXIMA PT/10
F1 F4

UN: R\$ 5,59 AV: R\$ 27,95 15: R\$ 28,53
30: R\$ 29,10 45: R\$ 29,68 60: R\$ 30,27

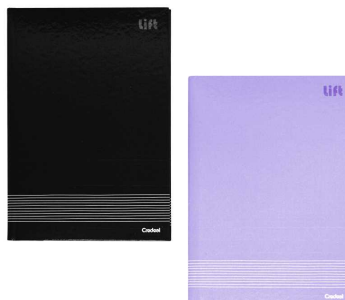

CADERNO COST 1/4 CD 48FLS COLOR C/P 5X1

Código: Fábrika: Unidade:
45791 CREDEAL PT/5
F1 F4

UN: R\$ 5,99 AV: R\$ 29,94 15: R\$ 30,57
30: R\$ 31,18 45: R\$ 31,80 60: R\$ 32,44



CADERNO COST 1/4 CD 48FLS C/P MAGIC 5X1

Código: Fábrika: Unidade:
38465 NOVA PT/5
F1 F4

UN: R\$ 3,99 AV: R\$ 39,93 15: R\$ 40,76
30: R\$ 41,57 45: R\$ 42,40 60: R\$ 43,25



CADERNO COST 1/4 CD 48FLS VERDE C/P10X1

Código: Fábrika: Unidade:
27066 MAXIMA PT/10
F1 F4

UN: R\$ 3,99 AV: R\$ 39,93 15: R\$ 40,76
30: R\$ 41,57 45: R\$ 42,40 60: R\$ 43,25



CADERNO COST 1/4 CD 48FLS VERME C/P10X1
Código: Fábrica: Unidade:
26636 MAXIMA PT/10
F1 F4

UN: R\$ 7,48 AV: R\$ 37,39 15: R\$ 38,17
30: R\$ 38,93 45: R\$ 39,71 60: R\$ 40,51



CADERNO COST 1/4 CD 96FLS AZUL C/P 5X1
Código: Fábrica: Unidade:
6166 MAXIM/CREDEA PT/5
F1 F4

UN: R\$ 7,99 AV: R\$ 79,86 15: R\$ 81,53
30: R\$ 83,16 45: R\$ 84,82 60: R\$ 86,52



CADERNO COST 1/4 CD 96FLS BARBI C/P 10X1
Código: Fábrica: Unidade:
35593 FORONI PT/10
F1 F4

UN: R\$ 6,99 AV: R\$ 69,88 15: R\$ 71,33
30: R\$ 72,76 45: R\$ 74,22 60: R\$ 75,70



CADERNO COST 1/4 CD 96FLS FEM C/P 10X1
Código: Fábrica: Unidade:
35335 RENOVO PT/10
F1 F4

UN: R\$ 7,48 AV: R\$ 37,39 15: R\$ 38,17
30: R\$ 38,93 45: R\$ 39,71 60: R\$ 40,51



CADERNO COST 1/4 CD 96FLS VERDE C/P 5X1
Código: Fábrica: Unidade:
19572 MAXIM/CREDEA PT/5
F1 F4

UN: R\$ 7,48 AV: R\$ 37,39 15: R\$ 38,17
30: R\$ 38,93 45: R\$ 39,71 60: R\$ 40,51



CADERNO COST 1/4 CD 96FLS VERME C/P 5X1
Código: Fábrica: Unidade:
6167 CREDEAL PT/5
F1 F4

UN: R\$ 7,99 AV: R\$ 39,93 15: R\$ 40,76
30: R\$ 41,57 45: R\$ 42,40 60: R\$ 43,25

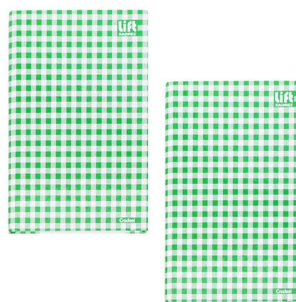

CADERNO COST 1/4 CD 96FLS XADREZ C/P 5X1
Código: Fábrica: Unidade:
43656 CREDEAL PT/5
F1 F4

UN: R\$ 2,89 AV: R\$ 57,71 15: R\$ 58,91
30: R\$ 60,09 45: R\$ 61,29 60: R\$ 62,52



CADERNO DESENHO BROCH 1/4 FLEX 40FL 20X1
Código: Fábrica: Unidade:
46800 JANDAIA PT/20
F1 F4

UN: R\$ 13,98 AV: R\$ 69,88 15: R\$ 71,33
30: R\$ 72,76 45: R\$ 74,22 60: R\$ 75,70



CADERNO DESENHO CD GR MILIMETR 96FLS 5X1
Código: Fábrica: Unidade:
42916 NEEDS PT/5
F1 F4

UN: R\$ 9,28 AV: R\$ 9,28 15: R\$ 9,47
30: R\$ 9,66 45: R\$ 9,85 60: R\$ 10,05



CADERNO DESENHO CD GR 48FLS S/SEDA UN
Código: Fábrica: Unidade:
46731 NEEDS UN/1
F1 F4

UN: R\$ 8,98 AV: R\$ 89,85 15: R\$ 91,72
30: R\$ 93,55 45: R\$ 95,42 60: R\$ 97,33



CADERNO DESENHO CD GR 48FLS S/SEDA 10X1
Código: Fábrica: Unidade:
1364 MAXIMA PT/10
F1 F4

UN: R\$ 14,53 AV: R\$ 72,65 15: R\$ 74,17
30: R\$ 75,65 45: R\$ 77,16 60: R\$ 78,71



CADERNO DESENHO CD GR 80FLS VERDE 5X1
Código: Fábrica: Unidade:
50689 CREDEAL PT/5
F1 F4

UN: R\$ 27,45 AV: R\$ 109,81 15: R\$ 112,10
30: R\$ 114,34 45: R\$ 116,63 60: R\$ 118,96



CADERNO DESENHO CD MEIA PAUTA 40FLS 4X1
Código: Fábrica: Unidade:
49107 CREDEAL PT/4
F1 F4

UN: R\$ 9,98 AV: R\$ 99,83 15: R\$ 101,91
30: R\$ 103,95 45: R\$ 106,03 60: R\$ 108,15



CADERNO DESENHO CF GR 48FLS C/SEDA 10X1
Código: Fábrica: Unidade:
14042 CREDEAL PT/10
F1 F4

UN: R\$ 5,99 AV: R\$ 59,89 15: R\$ 61,14
30: R\$ 62,36 45: R\$ 63,61 60: R\$ 64,88



CADERNO DESENHO CF GR 48FLS S/SEDA 10X1
Código: Fábrica: Unidade:
43631 CREDEAL PT/10
F1 F4

UN: R\$ 2,99 AV: R\$ 44,92 15: R\$ 45,85
30: R\$ 46,77 45: R\$ 47,71 60: R\$ 48,66



CADERNO DESENHO ESP 1/4 FLEX 40FL 15X1
Código: Fábrica: Unidade:
46946 PANAMERICANA PT/15
F1 F4

UN: R\$ 5,99 AV: R\$ 59,89 15: R\$ 61,14
30: R\$ 62,36 45: R\$ 63,61 60: R\$ 64,88



CADERNO DESENHO GR 48FLS S/SEDA FLE 10X1
Código: 24704 Fábrica: MAXIMA Unidade: PT/10 F1 F4

UN: R\$ 8,98 AV: R\$ 89,85 15: R\$ 91,72
30: R\$ 93,55 45: R\$ 95,42 60: R\$ 97,33



CADERNO DESENHO GR 96FLS S/SEDA FLE 10X1
Código: 19178 Fábrica: NEEDS Unidade: PT/10 F1 F4

UN: R\$ 9,98 AV: R\$ 49,91 15: R\$ 50,95
30: R\$ 51,97 45: R\$ 53,01 60: R\$ 54,07

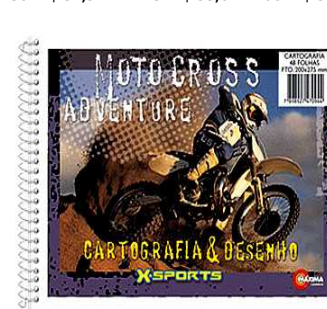

CADERNO DESENHO GR 96FLS S/SEDA FLEX 5X1
Código: 24703 Fábrica: MAXIMA Unidade: PT/5 F1 F4

UN: R\$ 6,59 AV: R\$ 32,94 15: R\$ 33,62
30: R\$ 34,30 45: R\$ 34,98 60: R\$ 35,68



CADERNO ESP 1/4 CD 96FLS PRINCY 5X1
Código: 38462 Fábrica: NOVA Unidade: PT/5 F1 F4

UN: R\$ 2,99 AV: R\$ 59,89 15: R\$ 61,14
30: R\$ 62,36 45: R\$ 63,61 60: R\$ 64,88



CADERNO ESP 1/4 FLEX 48FLS C/P 20X1
Código: 23469 Fábrica: MAXIMA Unidade: PT/20 F1 F4

UN: R\$ 5,99 AV: R\$ 59,89 15: R\$ 61,14
30: R\$ 62,36 45: R\$ 63,61 60: R\$ 64,88



CADERNO ESP 1/4 FLEX 96FLS C/P 10X1
Código: 1366 Fábrica: MAXI/3B/PAN Unidade: PT/10 F1 F4

UN: R\$ 3,98 AV: R\$ 3,98 15: R\$ 4,07
30: R\$ 4,15 45: R\$ 4,23 60: R\$ 4,32

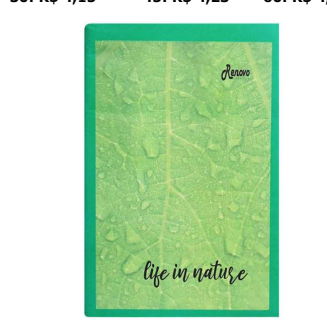

CADERNO FLEX 1/4 96FLS C/P UN
Código: 42446 Fábrica: MAXIMA Unidade: UN/1 F1 F4

UN: R\$ 11,97 AV: R\$ 11,97 15: R\$ 12,22
30: R\$ 12,46 45: R\$ 12,71 60: R\$ 12,97

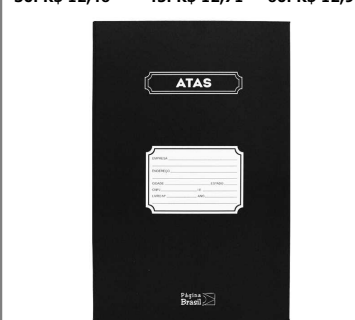

CADERNO LIVRO ATA 50FLS UN
Código: 42149 Fábrica: PAGINABRASIL Unidade: UN/1 F1 F4

UN: R\$ 11,98 AV: R\$ 119,80 15: R\$ 122,29
30: R\$ 124,74 45: R\$ 127,23 60: R\$ 129,78



CADERNO LIVRO ATA 50FLS 10X1
Código: 8038 Fábrica: PAGINABRASIL Unidade: PT/10 F1 F4

UN: R\$ 39,93 AV: R\$ 39,93 15: R\$ 40,76
30: R\$ 41,57 45: R\$ 42,40 60: R\$ 43,25

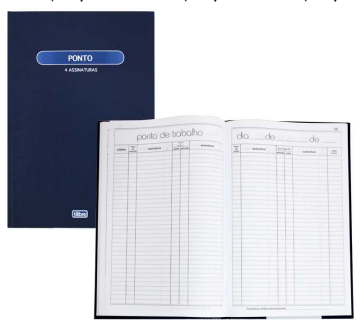

CADERNO LIVRO ATA 100FLS GDE UN
Código: 42052 Fábrica: TILIBRA Unidade: UN/1 F1 F4

UN: R\$ 19,19 AV: R\$ 19,19 15: R\$ 19,59
30: R\$ 19,98 45: R\$ 20,38 60: R\$ 20,79



CADERNO LIVRO ATA 100FLS UN
Código: 41692 Fábrica: GRIFFE/PAGIN Unidade: UN/1 F1 F4

UN: R\$ 34,93 AV: R\$ 34,93 15: R\$ 35,66
30: R\$ 36,38 45: R\$ 37,10 60: R\$ 37,84



CADERNO LIVRO ATA 200FLS UN
Código: 41685 Fábrica: PAGINABRASIL Unidade: UN/1 F1 F4

UN: R\$ 34,94 AV: R\$ 104,82 15: R\$ 107,01
30: R\$ 109,15 45: R\$ 111,33 60: R\$ 113,56



CADERNO LIVRO ATA 200FLS 3X1
Código: 35263 Fábrica: PAGINABRASIL Unidade: PT/3 F1 F4

UN: R\$ 8,58 AV: R\$ 42,92 15: R\$ 43,82
30: R\$ 44,69 45: R\$ 45,59 60: R\$ 46,50

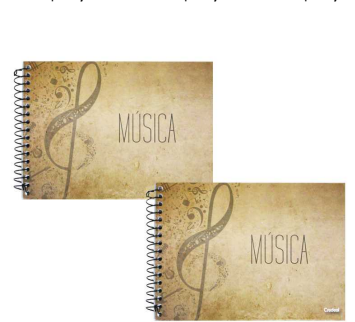

CADERNO MUSICA CD 1/4 ESP 80 FLS 5X1
Código: 43536 Fábrica: CREDEAL Unidade: PT/5 F1 F4

UN: R\$ 8,58 AV: R\$ 42,92 15: R\$ 43,82
30: R\$ 44,69 45: R\$ 45,59 60: R\$ 46,50



CADERNO MUSICA CF ESP 50 FLS 5X1
Código: 43635 Fábrica: CREDEAL Unidade: PT/5 F1 F4

UN: R\$ 24,95 AV: R\$ 24,95 15: R\$ 25,47
30: R\$ 25,98 45: R\$ 26,50 60: R\$ 27,03

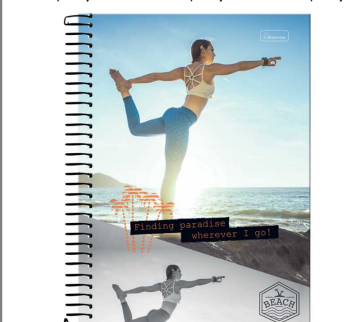

CADERNO PASTA 10MAT 200FLS BEACH B/A
Código: 21566 Fábrica: CADERSIL Unidade: UN/1 F1 F4

UN: R\$ 4,24 AV: R\$ 4,24 15: R\$ 4,33
30: R\$ 4,42 45: R\$ 4,51 60: R\$ 4,60



CAIXA ARQ MORTO OF PARDO 36X24X13CM UN
Código: 12480 Fábrica: DELPAP/JUSSA Unidade: UN/1
F1 F4

UN: R\$ 14,68 AV: R\$ 14,68 15: R\$ 14,98
30: R\$ 15,28 45: R\$ 15,59 60: R\$ 15,90



CAIXA ARQ MORTO POLION 30X18,5X39CM AZUL
Código: 49909 Fábrica: POLIBRAS Unidade: PT/1
F1 F4

UN: R\$ 6,74 AV: R\$ 6,74 15: R\$ 6,88
30: R\$ 7,02 45: R\$ 7,16 60: R\$ 7,30



CAIXA ARQ MORTO POLIONDA
Código: 8979 Fábrica: ALAPLAST Unidade: UN/1
F1 F4

UN: R\$ 6,74 AV: R\$ 6,74 15: R\$ 6,88
30: R\$ 7,02 45: R\$ 7,16 60: R\$ 7,30



CAIXA ARQ MORTO POLIONDA AMARELO
Código: 41183 Fábrica: ALAPLAST Unidade: UN/1
F1 F4

UN: R\$ 6,74 AV: R\$ 6,74 15: R\$ 6,88
30: R\$ 7,02 45: R\$ 7,16 60: R\$ 7,30



CAIXA ARQ MORTO POLIONDA AZUL
Código: 46080 Fábrica: ALAPLAST Unidade: UN/1
F1 F4

UN: R\$ 6,74 AV: R\$ 6,74 15: R\$ 6,88
30: R\$ 7,02 45: R\$ 7,16 60: R\$ 7,30



CAIXA ARQ MORTO POLIONDA BRANCO
Código: 46081 Fábrica: ALAPLAST Unidade: UN/1
F1 F4

UN: R\$ 6,74 AV: R\$ 6,74 15: R\$ 6,88
30: R\$ 7,02 45: R\$ 7,16 60: R\$ 7,30



CAIXA ARQ MORTO POLIONDA CINZA
Código: 41184 Fábrica: ALAPLAST Unidade: UN/1
F1 F4

UN: R\$ 12,87 AV: R\$ 643,60 15: R\$ 657,01
30: R\$ 670,15 45: R\$ 683,55 60: R\$ 697,22



CAIXA ARQ MORTO POLIONDA GIG AMARELO 50X1
Código: 42420 Fábrica: ALAPLAST Unidade: PT/50
F1 F4

UN: R\$ 12,87 AV: R\$ 12,87 15: R\$ 13,14
30: R\$ 13,40 45: R\$ 13,67 60: R\$ 13,94



CAIXA ARQ MORTO POLIONDA GIG AMARELO UN
Código: 48783 Fábrica: ALAPLAST Unidade: UN/1
F1 F4

UN: R\$ 12,87 AV: R\$ 12,87 15: R\$ 13,14
30: R\$ 13,40 45: R\$ 13,67 60: R\$ 13,94



CAIXA ARQ MORTO POLIONDA GIG AZUL UN
Código: 48779 Fábrica: ALAPLAST Unidade: UN/1
F1 F4

UN: R\$ 12,87 AV: R\$ 12,87 15: R\$ 13,14
30: R\$ 13,40 45: R\$ 13,67 60: R\$ 13,94



CAIXA ARQ MORTO POLIONDA GIG CINZA UN
Código: 48782 Fábrica: ALAPLAST Unidade: UN/1
F1 F4

UN: R\$ 12,87 AV: R\$ 643,60 15: R\$ 657,01
30: R\$ 670,15 45: R\$ 683,55 60: R\$ 697,22



CAIXA ARQ MORTO POLIONDA GIG PRETA 50X1
Código: 43872 Fábrica: ALAPLAST Unidade: PT/50
F1 F4

UN: R\$ 12,87 AV: R\$ 12,87 15: R\$ 13,14
30: R\$ 13,40 45: R\$ 13,67 60: R\$ 13,94



CAIXA ARQ MORTO POLIONDA GIG PRETO UN
Código: 48784 Fábrica: ALAPLAST Unidade: UN/1
F1 F4

UN: R\$ 12,87 AV: R\$ 12,87 15: R\$ 13,14
30: R\$ 13,40 45: R\$ 13,67 60: R\$ 13,94



CAIXA ARQ MORTO POLIONDA GIG VERDE UN
Código: 48786 Fábrica: ALAPLAST Unidade: UN/1
F1 F4

UN: R\$ 12,87 AV: R\$ 643,60 15: R\$ 657,01
30: R\$ 670,15 45: R\$ 683,55 60: R\$ 697,22



CAIXA ARQ MORTO POLIONDA GIG VERDE 50X1
Código: 43293 Fábrica: ALAPLAST Unidade: PT/50
F1 F4

UN: R\$ 12,87 AV: R\$ 643,60 15: R\$ 657,01
30: R\$ 670,15 45: R\$ 683,55 60: R\$ 697,22



CAIXA ARQ MORTO POLIONDA GIG VERMEL 50X1
Código: 42419 Fábrica: ALAPLAST Unidade: PT/50
F1 F4

UN: R\$ 12,87 AV: R\$ 12,87 15: R\$ 13,14
30: R\$ 13,40 45: R\$ 13,67 60: R\$ 13,94



CAIXA ARQ MORTO POLIONDA GIG VERMELHO UN
Código: Fábrica: Unidade:
48785 ALAPLAST UN/1
F1 F4

UN: R\$ 6,74 AV: R\$ 336,96 15: R\$ 343,98
30: R\$ 350,86 45: R\$ 357,88 60: R\$ 365,03



CAIXA ARQ MORTO POLIONDA PRAT AMARE 50X1
Código: Fábrica: Unidade:
42425 ALAPLAST PT/50
F1 F4

UN: R\$ 6,74 AV: R\$ 336,96 15: R\$ 343,98
30: R\$ 350,86 45: R\$ 357,88 60: R\$ 365,03



CAIXA ARQ MORTO POLIONDA PRAT CINZA 50X1
Código: Fábrica: Unidade:
42426 ALAPLAST PT/50
F1 F4

UN: R\$ 6,74 AV: R\$ 336,96 15: R\$ 343,98
30: R\$ 350,86 45: R\$ 357,88 60: R\$ 365,03



CAIXA ARQ MORTO POLIONDA PRAT PRETA 50X1
Código: Fábrica: Unidade:
43079 ALAPLAST PT/50
F1 F4

UN: R\$ 6,74 AV: R\$ 336,96 15: R\$ 343,98
30: R\$ 350,86 45: R\$ 357,88 60: R\$ 365,03

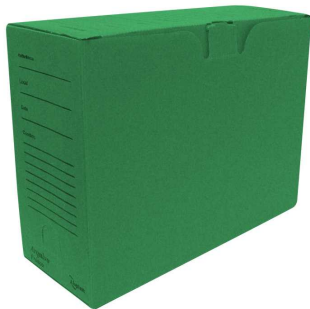

CAIXA ARQ MORTO POLIONDA PRAT VERDE 50X1
Código: Fábrica: Unidade:
42424 ALAPLAST PT/50
F1 F4

UN: R\$ 6,74 AV: R\$ 336,96 15: R\$ 343,98
30: R\$ 350,86 45: R\$ 357,88 60: R\$ 365,03



CAIXA ARQ MORTO POLIONDA PRAT VERME 50X1
Código: Fábrica: Unidade:
42695 ALAPLAST PT/50
F1 F4

UN: R\$ 6,74 AV: R\$ 6,74 15: R\$ 6,88
30: R\$ 7,02 45: R\$ 7,16 60: R\$ 7,30



CAIXA ARQ MORTO POLIONDA PRETO
Código: Fábrica: Unidade:
46079 ALAPLAST UN/1
F1 F4

UN: R\$ 6,74 AV: R\$ 6,74 15: R\$ 6,88
30: R\$ 7,02 45: R\$ 7,16 60: R\$ 7,30



CAIXA ARQ MORTO POLIONDA VERDE
Código: Fábrica: Unidade:
13256 ALAPLAST UN/1
F1 F4

UN: R\$ 6,74 AV: R\$ 6,74 15: R\$ 6,88
30: R\$ 7,02 45: R\$ 7,16 60: R\$ 7,30



CAIXA ARQ MORTO POLIONDA VERMELHO
Código: Fábrica: Unidade:
41182 ALAPLAST UN/1
F1 F4

UN: R\$ 45,28 AV: R\$ 45,28 15: R\$ 46,22
30: R\$ 47,15 45: R\$ 48,09 60: R\$ 49,05



CAIXA ARQ MULTIBOX POLIOND GDE AMADEIRAD
Código: Fábrica: Unidade:
43786 ALAPLAST UN/1
F1 F4

UN: R\$ 45,28 AV: R\$ 45,28 15: R\$ 46,22
30: R\$ 47,15 45: R\$ 48,09 60: R\$ 49,05



CAIXA ARQ MULTIBOX POLIOND GDE AZUL
Código: Fábrica: Unidade:
43301 ALAPLAST UN/1
F1 F4

UN: R\$ 45,28 AV: R\$ 45,28 15: R\$ 46,22
30: R\$ 47,15 45: R\$ 48,09 60: R\$ 49,05



CAIXA ARQ MULTIBOX POLIOND GDE PRETO
Código: Fábrica: Unidade:
43785 ALAPLAST UN/1
F1 F4

UN: R\$ 35,29 AV: R\$ 35,29 15: R\$ 36,03
30: R\$ 36,75 45: R\$ 37,48 60: R\$ 38,23



CAIXA ARQ MULTIBOX POLIOND MED AMADEIRAD
Código: Fábrica: Unidade:
43788 ALAPLAST UN/1
F1 F4

UN: R\$ 35,29 AV: R\$ 35,29 15: R\$ 36,03
30: R\$ 36,75 45: R\$ 37,48 60: R\$ 38,23



CAIXA ARQ MULTIBOX POLIOND MED AZUL
Código: Fábrica: Unidade:
43300 ALAPLAST UN/1
F1 F4

UN: R\$ 35,29 AV: R\$ 35,29 15: R\$ 36,03
30: R\$ 36,75 45: R\$ 37,48 60: R\$ 38,23



CAIXA ARQ MULTIBOX POLIOND MED PRETO
Código: Fábrica: Unidade:
43787 ALAPLAST UN/1
F1 F4

UN: R\$ 0,75 AV: R\$ 37,29 15: R\$ 38,07
30: R\$ 38,83 45: R\$ 39,61 60: R\$ 40,40



CAIXA ARQ P/PASTA SUSPENSA CRISTAL
Código: Fábrica: Unidade:
42735 DELLO PT/50
F1 F4

UN: R\$ 37,29 AV: R\$ 37,29 15: R\$ 38,07
30: R\$ 38,83 45: R\$ 39,61 60: R\$ 40,40



CAIXA ARQ P/PASTA SUSPensa PRETA
Código: 42742 Fábrica: DELLO Unidade: UN/1
F1 F4

UN: R\$ 46,65 AV: R\$ 46,65 15: R\$ 47,62
30: R\$ 48,57 45: R\$ 49,54 60: R\$ 50,53



CAIXA CORRESP DUPLA FUME 37X25,5CM 46
Código: 48057 Fábrica: MAXCRIL Unidade: UN/1
F1 F4

UN: R\$ 44,43 AV: R\$ 44,43 15: R\$ 45,35
30: R\$ 46,26 45: R\$ 47,19 60: R\$ 48,13



CAIXA CORRESP DUPLA PRETA 25X35CM 217
Código: 41799 Fábrica: CARBRINK Unidade: UN/1
F1 F4

UN: R\$ 22,21 AV: R\$ 22,21 15: R\$ 22,68
30: R\$ 23,13 45: R\$ 23,59 60: R\$ 24,07



CAIXA CORRESP SIMPL CRISTAL 37X25,5CM 43
Código: 48058 Fábrica: MAXCRIL Unidade: UN/1
F1 F4

UN: R\$ 21,95 AV: R\$ 21,95 15: R\$ 22,41
30: R\$ 22,86 45: R\$ 23,32 60: R\$ 23,78



CAIXA CORRESP SIMPLS PRETA 25X35CM 216
Código: 41797 Fábrica: CARBRINK Unidade: UN/1
F1 F4

UN: R\$ 68,88 AV: R\$ 68,88 15: R\$ 70,31
30: R\$ 71,72 45: R\$ 73,16 60: R\$ 74,62



CAIXA CORRESP TRIPLA CRIST 37X25,2CM 50
Código: 44676 Fábrica: MAXCRIL Unidade: UN/1
F1 F4

UN: R\$ 64,89 AV: R\$ 64,89 15: R\$ 66,24
30: R\$ 67,56 45: R\$ 68,91 60: R\$ 70,29



CAIXA CORRESP TRIPLA PRETA NOV VAZAD 441
Código: 50770 Fábrica: CARBRINK Unidade: UN/1
F1 F4

UN: R\$ 66,59 AV: R\$ 66,59 15: R\$ 67,98
30: R\$ 69,34 45: R\$ 70,73 60: R\$ 72,14



CAIXA CORRESP TRIPLA PRETA 25X35CM 218
Código: 41798 Fábrica: CARBRINK Unidade: UN/1
F1 F4

UN: R\$ 32,94 AV: R\$ 32,94 15: R\$ 33,62
30: R\$ 34,30 45: R\$ 34,98 60: R\$ 35,68

21cm
28cm
37cm



CAIXA ORG KRAFT RESINADA 37X28X21CM 1021
Código: 45744 Fábrica: JUSSARA Unidade: UN/1
F1 F4

UN: R\$ 34,93 AV: R\$ 34,93 15: R\$ 35,66
30: R\$ 36,38 45: R\$ 37,10 60: R\$ 37,84

21cm
31cm
44cm



CAIXA ORG KRAFT RESINADA 46X32X23CM 1022
Código: 45745 Fábrica: JUSSARA Unidade: UN/1
F1 F4

UN: R\$ 99,83 AV: R\$ 99,83 15: R\$ 101,91
30: R\$ 103,95 45: R\$ 106,03 60: R\$ 108,15



CAIXA ORGANIZADORA POLIIONDA LISA MED UN
Código: 43012 Fábrica: ALAPLAST Unidade: UN/1
F1 F4

UN: R\$ 1,60 AV: R\$ 39,93 15: R\$ 40,76
30: R\$ 41,57 45: R\$ 42,40 60: R\$ 43,25



CAIXA PAPELAO CV N00 CORREIO 1005 25X1
Código: 42700 Fábrica: SANTECK Unidade: PT/25
F1 F4

UN: R\$ 2,60 AV: R\$ 64,89 15: R\$ 66,24
30: R\$ 67,56 45: R\$ 68,91 60: R\$ 70,29



CAIXA PAPELAO CV N01 CORREIO 1000 25X1
Código: 39979 Fábrica: SANTECK Unidade: PT/25
F1 F4

UN: R\$ 4,58 AV: R\$ 109,81 15: R\$ 112,10
30: R\$ 114,34 45: R\$ 116,63 60: R\$ 118,96



CAIXA PAPELAO CV N02 CORREIO 1002 25X1
Código: 39980 Fábrica: SANTECK Unidade: PT/24
F1 F4

UN: R\$ 8,71 AV: R\$ 217,64 15: R\$ 222,18
30: R\$ 226,62 45: R\$ 231,15 60: R\$ 235,77



CAIXA PAPELAO CV N04 CORREIO 1004 25X1
Código: 42702 Fábrica: SANTECK Unidade: PT/25
F1 F4

UN: R\$ 5,27 AV: R\$ 5,27 15: R\$ 5,38
30: R\$ 5,49 45: R\$ 5,60 60: R\$ 5,71



CAIXA PVC PORTA TRECOS BARBIE 2558
Código: 15404 Fábrica: POLIBRAS. Unidade: UN/1
F1 F4

10 cm
19 cm
28 cm

UN: R\$ 14,68 AV: R\$ 14,68 15: R\$ 14,98
30: R\$ 15,28 45: R\$ 15,59 60: R\$ 15,90



CALCULADORA 8 DIG A PILHA MJ-658A

Código: Fábrika: Unidade:
13084 MJ UN/1
F1 F4

UN: R\$ 20,96 AV: R\$ 20,96 15: R\$ 21,39
30: R\$ 21,82 45: R\$ 22,26 60: R\$ 22,70



CALCULADORA 8 DIG MED KK-800A BAT

Código: Fábrika: Unidade:
41647 GATE UN/1
F1 F4

UN: R\$ 20,96 AV: R\$ 20,96 15: R\$ 21,39
30: R\$ 21,82 45: R\$ 22,26 60: R\$ 22,70



CALCULADORA 8 DIG MED KK-8008V BAT

Código: Fábrika: Unidade:
41648 GATE UN/1
F1 F4

UN: R\$ 7,98 AV: R\$ 7,98 15: R\$ 8,14
30: R\$ 8,31 45: R\$ 8,47 60: R\$ 8,64



CALCULADORA 8 DIG PQ PILHA AA S/API 402

Código: Fábrika: Unidade:
23639 RELINX UN/1
F1 F4

UN: R\$ 25,95 AV: R\$ 25,95 15: R\$ 26,49
30: R\$ 27,02 45: R\$ 27,56 60: R\$ 28,11



CALCULADORA CIENTIF 10+2 DIG BATER 9318C

Código: Fábrika: Unidade:
35296 IDEA UN/1
F1 F4

UN: R\$ 19,96 AV: R\$ 19,96 15: R\$ 20,37
30: R\$ 20,78 45: R\$ 21,20 60: R\$ 21,62



CALCULADORA CIENTIFICA 12DIG 240 FUNC 82

Código: Fábrika: Unidade:
49908 MJ UN/1
F1 F4

UN: R\$ 27,95 AV: R\$ 27,95 15: R\$ 28,53
30: R\$ 29,10 45: R\$ 29,68 60: R\$ 30,27



CALCULADORA 12 DIG COLOR PILHA 9136D-12

Código: Fábrika: Unidade:
43292 XHADAY UN/1
F1 F4

UN: R\$ 22,99 AV: R\$ 22,99 15: R\$ 22,99
30: R\$ 22,99 45: R\$ 22,99 60: R\$ 22,99



CALCULADORA 12 DIG PILHA AA 0036

Código: Fábrika: Unidade:
46867 PLANETA UN/1
F1 F4

UN: R\$ 19,96 AV: R\$ 19,96 15: R\$ 20,37
30: R\$ 20,78 45: R\$ 21,20 60: R\$ 21,62



CALCULADORA 12 DIG PILHA 837B

Código: Fábrika: Unidade:
42231 MJ UN/1
F1 F4

UN: R\$ 28,94 AV: R\$ 28,94 15: R\$ 29,55
30: R\$ 30,14 45: R\$ 30,74 60: R\$ 31,36



CALCULADORA 12 DIG PILHA 838B-12

Código: Fábrika: Unidade:
43204 XHADAY UN/1
F1 F4

UN: R\$ 13,71 AV: R\$ 13,71 15: R\$ 13,99
30: R\$ 14,27 45: R\$ 14,56 60: R\$ 14,85



CALCULADORA 8 DIG BAT C/APITO 9844

Código: Fábrika: Unidade:
22056 DOTAD UN/1
F1 F4

UN: R\$ 23,95 AV: R\$ 23,95 15: R\$ 24,45
30: R\$ 24,94 45: R\$ 25,44 60: R\$ 25,95



CALCULADORA 8+2 DIG CIENTIF PILH AA 7722

Código: Fábrika: Unidade:
47929 YIN'S PAPER UN/1
F1 F4

UN: R\$ 0,40 AV: R\$ 19,96 15: R\$ 20,37
30: R\$ 20,78 45: R\$ 21,20 60: R\$ 21,62



CANAETA P/ENCADERNACAO A4 PRETA 50X1

Código: Fábrika: Unidade:
41677 PLASPIRAL PT/50
F1 F4

UN: R\$ 4,04 AV: R\$ 4,04 15: R\$ 4,13
30: R\$ 4,21 45: R\$ 4,29 60: R\$ 4,38



CANETA CORRETIVA UN

Código: Fábrika: Unidade:
42508 MASTERPRINT UN/1
F1 F4

UN: R\$ 3,74 AV: R\$ 44,92 15: R\$ 45,85
30: R\$ 46,77 45: R\$ 47,71 60: R\$ 48,66



CANETA CORRETIVA 4ML 131 12X1

Código: Fábrika: Unidade:
46415 KAZ CX/12
F1 F4

UN: R\$ 2,91 AV: R\$ 34,93 15: R\$ 35,66
30: R\$ 36,38 45: R\$ 37,10 60: R\$ 37,84



CANETA CORRETIVA 7 ML 904539 12X1

Código: Fábrika: Unidade:
49494 BAZZE DZ/12
F1 F4

UN: R\$ 3,20 AV: R\$ 76,86 15: R\$ 78,46
30: R\$ 80,03 45: R\$ 81,63 60: R\$ 83,26



CANETA CORRETIVA 7ML 435 24X1
Código: 13096 Fábrica: MASTERPRINT Unidade: CX/24 F1 F4

UN: R\$ 4,37 AV: R\$ 104,82 15: R\$ 107,01
30: R\$ 109,15 45: R\$ 111,33 60: R\$ 113,56



CANETA CORRETIVA 8ML 242203 24X1
Código: 44107 Fábrica: FUTURO Unidade: CX/24 F1 F4

UN: R\$ 4,98 AV: R\$ 4,98 15: R\$ 5,09
30: R\$ 5,19 45: R\$ 5,29 60: R\$ 5,40



CANETA DETECTORA DE DH FALSO CTL 96059
Código: 40934 Fábrica: JOCAROFFICE Unidade: CR/1 F1 F4

UN: R\$ 1,80 AV: R\$ 21,57 15: R\$ 22,01
30: R\$ 22,46 45: R\$ 22,90 60: R\$ 23,36



CANETA ESF CLIC 0.55MM BROW 12X1
Código: 48561 Fábrica: NEWPEN Unidade: DZ/12 F1 F4

UN: R\$ 1,80 AV: R\$ 21,57 15: R\$ 22,01
30: R\$ 22,46 45: R\$ 22,90 60: R\$ 23,36



CANETA ESF CLIC 0.55MM GREEN 12X1
Código: 48560 Fábrica: NEWPEN Unidade: DZ/12 F1 F4

UN: R\$ 1,80 AV: R\$ 21,57 15: R\$ 22,01
30: R\$ 22,46 45: R\$ 22,90 60: R\$ 23,36



CANETA ESF CLIC 0.55MM LIGHT GREEN 12X1
Código: 48563 Fábrica: NEWPEN Unidade: DZ/12 F1 F4

UN: R\$ 1,80 AV: R\$ 21,57 15: R\$ 22,01
30: R\$ 22,46 45: R\$ 22,90 60: R\$ 23,36



CANETA ESF CLIC 0.55MM LIGHT PINK 12X1
Código: 48562 Fábrica: NEWPEN Unidade: DZ/12 F1 F4

UN: R\$ 1,80 AV: R\$ 21,57 15: R\$ 22,01
30: R\$ 22,46 45: R\$ 22,90 60: R\$ 23,36



CANETA ESF CLIC 0.55MM SILVER 12X1
Código: 48559 Fábrica: NEWPEN Unidade: DZ/12 F1 F4

UN: R\$ 1,80 AV: R\$ 21,57 15: R\$ 22,01
30: R\$ 22,46 45: R\$ 22,90 60: R\$ 23,36



CANETA ESF CLIC 0.55MM YELLOW 12X1
Código: 48564 Fábrica: NEWPEN Unidade: DZ/12 F1 F4

UN: R\$ 2,68 AV: R\$ 128,78 15: R\$ 131,47
30: R\$ 134,10 45: R\$ 136,78 60: R\$ 139,51



CANETA ESF CLIC 1.0MM AZUL 1135 48X1
Código: 48556 Fábrica: NEWPEN Unidade: CX/48 F1 F4

UN: R\$ 2,68 AV: R\$ 128,78 15: R\$ 131,47
30: R\$ 134,10 45: R\$ 136,78 60: R\$ 139,51



CANETA ESF CLIC 1.0MM PRETA 1134 48X1
Código: 48557 Fábrica: NEWPEN Unidade: CX/48 F1 F4

UN: R\$ 1,39 AV: R\$ 69,44 15: R\$ 70,89
30: R\$ 72,30 45: R\$ 73,75 60: R\$ 75,22



CANETA ESF CRISTAL 0.8MM AZUL FINA 50X1
Código: 31710 Fábrica: BIC Unidade: CX/50 F1 F4

UN: R\$ 1,39 AV: R\$ 69,44 15: R\$ 70,89
30: R\$ 72,30 45: R\$ 73,75 60: R\$ 75,22



CANETA ESF CRISTAL 0.8MM PRETA FINA 50X1
Código: 29642 Fábrica: BIC Unidade: CX/50 F1 F4

UN: R\$ 1,10 AV: R\$ 54,91 15: R\$ 56,06
30: R\$ 57,18 45: R\$ 58,32 60: R\$ 59,49



CANETA ESF CRISTAL 0.8MM VERM FINA 50X1
Código: 34032 Fábrica: BIC Unidade: CX/50 F1 F4

UN: R\$ 1,06 AV: R\$ 52,91 15: R\$ 54,01
30: R\$ 55,09 45: R\$ 56,19 60: R\$ 57,31



CANETA ESF CRISTAL 1.0MM AZUL MED 50X1
Código: 12538 Fábrica: BIC Unidade: CX/50 F1 F4

UN: R\$ 1,06 AV: R\$ 52,91 15: R\$ 54,01
30: R\$ 55,09 45: R\$ 56,19 60: R\$ 57,31



CANETA ESF CRISTAL 1.0MM VERM MED 50X1
Código: 29783 Fábrica: BIC Unidade: CX/50 F1 F4

UN: R\$ 2,47 AV: R\$ 61,85 15: R\$ 63,14
30: R\$ 64,40 45: R\$ 65,69 60: R\$ 67,00



CANETA ESF CRISTAL 1.6MM AZUL BOLD 25X1

Código: Fábrica: Unidade:
50120 BIC CX/25
F1 F4

UN: R\$ 2,47 AV: R\$ 61,85 15: R\$ 63,14
30: R\$ 64,40 45: R\$ 65,69 60: R\$ 67,00



CANETA ESF CRISTAL 1.6MM PRETA BOLD 25X1

Código: Fábrica: Unidade:
50121 BIC CX/25
F1 F4

UN: R\$ 27,95 AV: R\$ 27,95 15: R\$ 28,53
30: R\$ 29,10 45: R\$ 29,68 60: R\$ 30,27



CANETA ESF FIXO AZUL C/CORRENTE+RECARG

Código: Fábrica: Unidade:
48573 NEWPEN UN/1
F1 F4

UN: R\$ 3,16 AV: R\$ 37,93 15: R\$ 38,72
30: R\$ 39,49 45: R\$ 40,28 60: R\$ 41,09



CANETA ESF GELOCIY 0.5MM AZUL FINA 12X1

Código: Fábrica: Unidade:
50122 BIC CX/12
F1 F4

UN: R\$ 3,16 AV: R\$ 37,93 15: R\$ 38,72
30: R\$ 39,49 45: R\$ 40,28 60: R\$ 41,09



CANETA ESF GELOCIY 0.5MM PT/VM FINA 12X1

Código: Fábrica: Unidade:
50123 BIC CX/12
F1 F4

UN: R\$ 1,41 AV: R\$ 16,96 15: R\$ 17,32
30: R\$ 17,66 45: R\$ 18,02 60: R\$ 18,38



CANETA ESF INOX 1.0MM AZUL 12X1

Código: Fábrica: Unidade:
43815 PILOT CX/12
F1 F4

UN: R\$ 1,41 AV: R\$ 16,96 15: R\$ 17,32
30: R\$ 17,66 45: R\$ 18,02 60: R\$ 18,38



CANETA ESF INOX 1.0MM PRETA 12X1

Código: Fábrica: Unidade:
43816 PILOT CX/12
F1 F4

UN: R\$ 1,41 AV: R\$ 16,96 15: R\$ 17,32
30: R\$ 17,66 45: R\$ 18,02 60: R\$ 18,38



CANETA ESF INOX 1.0MM VERMELHO 12X1

Código: Fábrica: Unidade:
43817 PILOT CX/12
F1 F4

UN: R\$ 1,29 AV: R\$ 128,78 15: R\$ 131,47
30: R\$ 134,10 45: R\$ 136,78 60: R\$ 139,51



CANETA ESF 0.7 AZUL 100X1

Código: Fábrica: Unidade:
35991 COMPACTOR CX/100
F1 F4

UN: R\$ 1,30 AV: R\$ 64,89 15: R\$ 66,24
30: R\$ 67,56 45: R\$ 68,91 60: R\$ 70,29



CANETA ESF 0.7 AZUL 50X1

Código: Fábrica: Unidade:
4082 COMPACTOR CX/50
F1 F4

UN: R\$ 2,80 AV: R\$ 69,88 15: R\$ 71,33
30: R\$ 72,76 45: R\$ 74,22 60: R\$ 75,70



CANETA ESF 0.7 MM MY TECH AZUL 7330 25X1

Código: Fábrica: Unidade:
46362 JOCAROFFICE PT/25
F1 F4

UN: R\$ 2,80 AV: R\$ 69,88 15: R\$ 71,33
30: R\$ 72,76 45: R\$ 74,22 60: R\$ 75,70



CANETA ESF 0.7 MM MY TECH PRETO 25X1

Código: Fábrica: Unidade:
46363 JOCAROFFICE CX/25
F1 F4

UN: R\$ 2,80 AV: R\$ 69,88 15: R\$ 71,33
30: R\$ 72,76 45: R\$ 74,22 60: R\$ 75,70



CANETA ESF 0.7 MM MY TECH VERMELHO 25X1

Código: Fábrica: Unidade:
46364 JOCAROFFICE CX/25
F1 F4

UN: R\$ 1,92 AV: R\$ 95,84 15: R\$ 97,83
30: R\$ 99,79 45: R\$ 101,79 60: R\$ 103,82



CANETA ESF 0.7 MM PICNIC COLORIDA 50X1

Código: Fábrica: Unidade:
46376 LEO&LEO PT/50
F1 F4

UN: R\$ 1,08 AV: R\$ 12,97 15: R\$ 13,24
30: R\$ 13,50 45: R\$ 13,77 60: R\$ 14,05



CANETA ESF 0.7 MM SILK AZUL 12X1

Código: Fábrica: Unidade:
42730 JOCAROFFICE CX/12
F1 F4

UN: R\$ 1,08 AV: R\$ 12,97 15: R\$ 13,24
30: R\$ 13,50 45: R\$ 13,77 60: R\$ 14,05



CANETA ESF 0.7 MM SILK PRETO 12X1

Código: Fábrica: Unidade:
42731 JOCAROFFICE CX/12
F1 F4

UN: R\$ 3,16 AV: R\$ 25,31 15: R\$ 25,84
30: R\$ 26,35 45: R\$ 26,88 60: R\$ 27,42



CANETA ESF 0.7 MM TIP CLICK 97945 8X1
Código: 46361 Fábrica: JOCAROFFICE Unidade: CT/8 F1 F4

UN: R\$ 1,30 AV: R\$ 64,89 15: R\$ 66,24
30: R\$ 67,56 45: R\$ 68,91 60: R\$ 70,29



CANETA ESF 0.7 PRETA 50X1
Código: 3198 Fábrica: COMPACTOR Unidade: CX/50 F1 F4

UN: R\$ 1,60 AV: R\$ 39,93 15: R\$ 40,76
30: R\$ 41,57 45: R\$ 42,40 60: R\$ 43,25



CANETA ESF 0.7 ROSA PINK 25X1
Código: 35994 Fábrica: COMPACTOR Unidade: CX/25 F1 F4

UN: R\$ 1,30 AV: R\$ 64,89 15: R\$ 66,24
30: R\$ 67,56 45: R\$ 68,91 60: R\$ 70,29



CANETA ESF 0.7 VERMELHA 50X1
Código: 3199 Fábrica: COMPACTOR Unidade: CX/50 F1 F4

UN: R\$ 1,60 AV: R\$ 39,93 15: R\$ 40,76
30: R\$ 41,57 45: R\$ 42,40 60: R\$ 43,25



CANETA ESF 0.7 VIOLETA 25X1
Código: 35995 Fábrica: COMPACTOR Unidade: CX/25 F1 F4

UN: R\$ 1,54 AV: R\$ 36,93 15: R\$ 37,70
30: R\$ 38,45 45: R\$ 39,22 60: R\$ 40,01



CANETA ESF 0.7MM AZUL POTE 57718 24X1
Código: 48172 Fábrica: CIS Unidade: PT/24 F1 F4

UN: R\$ 2,09 AV: R\$ 10,47 15: R\$ 10,69
30: R\$ 10,91 45: R\$ 11,12 60: R\$ 11,35



CANETA ESF 0.7MM ESPIRAL 98159 5X1
Código: 46391 Fábrica: KAZ Unidade: CT/5 F1 F4

UN: R\$ 14,97 AV: R\$ 59,87 15: R\$ 61,12
30: R\$ 62,34 45: R\$ 63,59 60: R\$ 64,86



CANETA ESF 0.7MM GEL AZUL/PT/VM 4X1
Código: 48221 Fábrica: SHARPIE Unidade: CR/4 F1 F4

UN: R\$ 6,98 AV: R\$ 13,97 15: R\$ 14,26
30: R\$ 14,54 45: R\$ 14,83 60: R\$ 15,13



CANETA ESF 0.7MM INKJOY GEL RETRATIL 2X1
Código: 48206 Fábrica: PAPER MATE Unidade: CR/2 F1 F4

UN: R\$ 6,74 AV: R\$ 26,95 15: R\$ 27,51
30: R\$ 28,06 45: R\$ 28,62 60: R\$ 29,19



CANETA ESF 0.7MM INKJOY GEL RETRATIL 4X1
Código: 48207 Fábrica: PAPER MATE Unidade: CR/4 F1 F4

UN: R\$ 56,58 AV: R\$ 56,58 15: R\$ 57,76
30: R\$ 58,91 45: R\$ 60,09 60: R\$ 61,29



CANETA ESF 0.7MM KIT 5 CORES
Código: 46249 Fábrica: PILOT Unidade: KT/1 F1 F4

UN: R\$ 1,54 AV: R\$ 36,93 15: R\$ 37,70
30: R\$ 38,45 45: R\$ 39,22 60: R\$ 40,01



CANETA ESF 0.7MM PRETA POTE 57719 24X1
Código: 48173 Fábrica: CIS Unidade: PT/24 F1 F4

UN: R\$ 1,54 AV: R\$ 36,93 15: R\$ 37,70
30: R\$ 38,45 45: R\$ 39,22 60: R\$ 40,01



CANETA ESF 0.7MM SORT POTE 57717 24X1
Código: 48174 Fábrica: CIS Unidade: PT/24 F1 F4

UN: R\$ 11,31 AV: R\$ 135,77 15: R\$ 138,60
30: R\$ 141,37 45: R\$ 144,20 60: R\$ 147,08



CANETA ESF 0.7MM SUPER GRIP LARANJA 12X1
Código: 46150 Fábrica: PILOT Unidade: CX/12 F1 F4

UN: R\$ 11,31 AV: R\$ 135,77 15: R\$ 138,60
30: R\$ 141,37 45: R\$ 144,20 60: R\$ 147,08

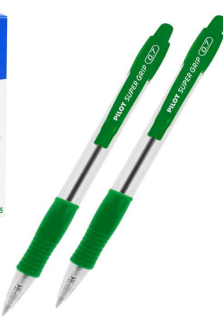

CANETA ESF 0.7MM SUPER GRIP VERDE 12X1
Código: 46152 Fábrica: PILOT Unidade: CX/12 F1 F4

UN: R\$ 11,31 AV: R\$ 135,77 15: R\$ 138,60
30: R\$ 141,37 45: R\$ 144,20 60: R\$ 147,08



CANETA ESF 0.7MM SUPER GRIP VERMELH 12X1
Código: 46154 Fábrica: PILOT Unidade: CX/12 F1 F4

UN: R\$ 11,31 AV: R\$ 135,77 15: R\$ 138,60
30: R\$ 141,37 45: R\$ 144,20 60: R\$ 147,08



CANETA ESF 0.7MM SUPER GRIP VIOLETA 12X1
Código: 46153 Fábrica: PILOT Unidade: CX/12 F1 F4

UN: R\$ 2,19 AV: R\$ 6,58 15: R\$ 6,72
30: R\$ 6,85 45: R\$ 6,99 60: R\$ 7,13



CANETA ESF 0.7MM WAVE 3 CORES 3X1
Código: 49498 Fábrica: BAZZE Unidade: PT/3 F1 F4

UN: R\$ 1,76 AV: R\$ 42,33 15: R\$ 43,21
30: R\$ 44,08 45: R\$ 44,96 60: R\$ 45,86



CANETA ESF 0.7MM WAVE 3CORES POTE 24X1
Código: 49496 Fábrica: BAZZE Unidade: PT/24 F1 F4

UN: R\$ 1,02 AV: R\$ 50,82 15: R\$ 51,88
30: R\$ 52,91 45: R\$ 53,97 60: R\$ 55,05



CANETA ESF 0.8MM PONTA FINA AZUL 50X1
Código: 20614 Fábrica: INJEX PEN Unidade: CX/50 F1 F4

UN: R\$ 1,02 AV: R\$ 50,82 15: R\$ 51,88
30: R\$ 52,91 45: R\$ 53,97 60: R\$ 55,05



CANETA ESF 0.8MM PONTA FINA PRETA 50X1
Código: 20617 Fábrica: INJEX PEN Unidade: CX/50 F1 F4

UN: R\$ 1,02 AV: R\$ 50,82 15: R\$ 51,88
30: R\$ 52,91 45: R\$ 53,97 60: R\$ 55,05



CANETA ESF 0.8MM PONTA FINA VERMELH 50X1
Código: 20615 Fábrica: INJEX PEN Unidade: CX/50 F1 F4

UN: R\$ 1,10 AV: R\$ 54,90 15: R\$ 56,05
30: R\$ 57,17 45: R\$ 58,31 60: R\$ 59,48



CANETA ESF 1.0 ECONOMIC FINA AZUL 50X1
Código: 47847 Fábrica: COMPACTOR Unidade: CX/50 F1 F4

UN: R\$ 1,10 AV: R\$ 54,90 15: R\$ 56,05
30: R\$ 57,17 45: R\$ 58,31 60: R\$ 59,48



CANETA ESF 1.0 ECONOMIC FINA PRETA 50X1
Código: 47848 Fábrica: COMPACTOR Unidade: CX/50 F1 F4

UN: R\$ 1,10 AV: R\$ 54,90 15: R\$ 56,05
30: R\$ 57,17 45: R\$ 58,31 60: R\$ 59,48



CANETA ESF 1.0 ECONOMIC FINA VERMEL 50X1
Código: 47849 Fábrica: COMPACTOR Unidade: CX/50 F1 F4

UN: R\$ 0,90 AV: R\$ 89,85 15: R\$ 91,72
30: R\$ 93,55 45: R\$ 95,42 60: R\$ 97,33



CANETA ESF 1.0 ECONOMIC MED AZUL 100X1
Código: 35992 Fábrica: COMPACTOR Unidade: CX/100 F1 F4

UN: R\$ 1,00 AV: R\$ 49,91 15: R\$ 50,95
30: R\$ 51,97 45: R\$ 53,01 60: R\$ 54,07



CANETA ESF 1.0 ECONOMIC MED AZUL 50X1
Código: 27813 Fábrica: COMPACTOR Unidade: CX/50 F1 F4

UN: R\$ 0,90 AV: R\$ 89,85 15: R\$ 91,72
30: R\$ 93,55 45: R\$ 95,42 60: R\$ 97,33



CANETA ESF 1.0 ECONOMIC MED VERMEL 100X1
Código: 50416 Fábrica: COMPACTOR Unidade: CX/100 F1 F4

UN: R\$ 1,00 AV: R\$ 49,91 15: R\$ 50,95
30: R\$ 51,97 45: R\$ 53,01 60: R\$ 54,07



CANETA ESF 1.0 ECONOMIC MED VERMEL 50X1
Código: 31347 Fábrica: COMPACTOR Unidade: CX/50 F1 F4

UN: R\$ 1,62 AV: R\$ 38,93 15: R\$ 39,74
30: R\$ 40,53 45: R\$ 41,34 60: R\$ 42,17



CANETA ESF 1.0MM COLOR MINI 04577 24X1
Código: 49955 Fábrica: BAZZE WAVE Unidade: CX/24 F1 F4

UN: R\$ 1,95 AV: R\$ 46,91 15: R\$ 47,89
30: R\$ 48,85 45: R\$ 49,83 60: R\$ 50,82



CANETA ESF 1.0MM COLOR 653358 24X1
Código: 49954 Fábrica: BAZZE WAVE Unidade: CX/24 F1 F4

UN: R\$ 2,21 AV: R\$ 13,25 15: R\$ 13,52
30: R\$ 13,80 45: R\$ 14,07 60: R\$ 14,35



CANETA ESF 1.0MM COR PASTEIS 98154 6X1
Código: 46388 Fábrica: KAZ Unidade: CT/6 F1 F4

UN: R\$ 2,11 AV: R\$ 10,57 15: R\$ 10,79
30: R\$ 11,01 45: R\$ 11,23 60: R\$ 11,45



CANETA ESF 1.0MM CORES 98118 5X1

Código: 46389 Fábrica: KAZ Unidade: CT/5 F1 F4

UN: R\$ 2,25 AV: R\$ 53,90 15: R\$ 55,03
30: R\$ 56,13 45: R\$ 57,25 60: R\$ 58,39



CANETA ESF 1.0MM DUO AZ/VM POTE 24X1

Código: 48558 Fábrica: NEWPEN Unidade: CX/24 F1 F4

UN: R\$ 0,86 AV: R\$ 42,92 15: R\$ 43,82
30: R\$ 44,69 45: R\$ 45,59 60: R\$ 46,50



CANETA ESF 1.0MM HEXAG AZUL 402 50X1

Código: 49945 Fábrica: BAZZE SIX Unidade: CX/50 F1 F4

UN: R\$ 0,86 AV: R\$ 42,92 15: R\$ 43,82
30: R\$ 44,69 45: R\$ 45,59 60: R\$ 46,50



CANETA ESF 1.0MM HEXAG PRETA 3396 50X1

Código: 49946 Fábrica: BAZZE SIX Unidade: CX/50 F1 F4

UN: R\$ 0,86 AV: R\$ 42,92 15: R\$ 43,82
30: R\$ 44,69 45: R\$ 45,59 60: R\$ 46,50



CANETA ESF 1.0MM HEXAG VERMEL 419 50X1

Código: 49944 Fábrica: BAZZE SIX Unidade: CX/50 F1 F4

UN: R\$ 2,47 AV: R\$ 24,68 15: R\$ 25,19
30: R\$ 25,70 45: R\$ 26,21 60: R\$ 26,74



CANETA ESF 1.0MM HYPER COLOR 97921 10X1

Código: 46357 Fábrica: JOCAROFFICE Unidade: CT/10 F1 F4

UN: R\$ 1,75 AV: R\$ 13,97 15: R\$ 14,26
30: R\$ 14,54 45: R\$ 14,83 60: R\$ 15,13



CANETA ESF 1.0MM JET LUX 8X1

Código: 48154 Fábrica: COMPACTOR Unidade: CR/8 F1 F4

UN: R\$ 3,16 AV: R\$ 37,93 15: R\$ 38,72
30: R\$ 39,49 45: R\$ 40,28 60: R\$ 41,09



CANETA ESF 1.0MM OURO 12X1

Código: 8456 Fábrica: CIS Unidade: DZ/12 F1 F4

UN: R\$ 2,33 AV: R\$ 55,90 15: R\$ 57,07
30: R\$ 58,21 45: R\$ 59,37 60: R\$ 60,56



CANETA ESF 1.0MM OURO/PRATA 1415 24X1

Código: 49952 Fábrica: BAZZE WAVE Unidade: CX/24 F1 F4

UN: R\$ 1,91 AV: R\$ 7,63 15: R\$ 7,79
30: R\$ 7,94 45: R\$ 8,10 60: R\$ 8,26



CANETA ESF 1.0MM PEROLA 4 CORES 4X1

Código: 20678 Fábrica: INJEX PEN Unidade: PT/4 F1 F4

UN: R\$ 0,80 AV: R\$ 39,93 15: R\$ 40,76
30: R\$ 41,57 45: R\$ 42,40 60: R\$ 43,25



CANETA ESF 1.0MM PONTA MED AZUL 50X1

Código: 20621 Fábrica: INJEX PEN Unidade: CX/50 F1 F4

UN: R\$ 1,59 AV: R\$ 4,77 15: R\$ 4,87
30: R\$ 4,97 45: R\$ 5,07 60: R\$ 5,17



CANETA ESF 1.0MM PONTA MED AZ/VM/PT 3X1

Código: 47259 Fábrica: INJEX PEN Unidade: PT/3 F1 F4

UN: R\$ 0,80 AV: R\$ 39,93 15: R\$ 40,76
30: R\$ 41,57 45: R\$ 42,40 60: R\$ 43,25



CANETA ESF 1.0MM PONTA MED PRETA 50X1

Código: 20618 Fábrica: INJEX PEN Unidade: CX/50 F1 F4

UN: R\$ 0,80 AV: R\$ 39,93 15: R\$ 40,76
30: R\$ 41,57 45: R\$ 42,40 60: R\$ 43,25



CANETA ESF 1.0MM PONTA MED VERMELHA 50X1

Código: 20620 Fábrica: INJEX PEN Unidade: CX/50 F1 F4

UN: R\$ 3,15 AV: R\$ 37,84 15: R\$ 38,63
30: R\$ 39,40 45: R\$ 40,19 60: R\$ 40,99



CANETA ESF 1.0MM PRATA 12X1

Código: 48348 Fábrica: CIS Unidade: DZ/12 F1 F4

UN: R\$ 1,55 AV: R\$ 15,47 15: R\$ 15,79
30: R\$ 16,10 45: R\$ 16,43 60: R\$ 16,75



CANETA ESF 1.0MM TENDENCE 98146 10X1

Código: 46390 Fábrica: KAZ Unidade: CT/10 F1 F4

UN: R\$ 11,23 AV: R\$ 134,72 15: R\$ 137,53
30: R\$ 140,28 45: R\$ 143,09 60: R\$ 145,95



CANETA ESF 1.0MM 4 CORES MED 12X1
Código: Fábrika: Unidade:
50124 BIC CX/12
F1 F4

UN: R\$ 2,62 AV: R\$ 10,47 15: R\$ 10,69
30: R\$ 10,91 45: R\$ 11,12 60: R\$ 11,35



CANETA ESF 1.2MM 4 CORES MED FASHION
Código: Fábrika: Unidade:
6895 BIC CR/4
F1 F4

UN: R\$ 19,96 AV: R\$ 19,96 15: R\$ 20,37
30: R\$ 20,78 45: R\$ 21,20 60: R\$ 21,62



CANETA EXECUTIVA ATENA ESCRITA PRETA CX
Código: Fábrika: Unidade:
47910 YIN'S PAPER UN/1
F1 F4

UN: R\$ 59,89 AV: R\$ 59,89 15: R\$ 61,14
30: R\$ 62,36 45: R\$ 63,61 60: R\$ 64,88



CANETA FIXA METAL C/CORRENTE CTL 234
Código: Fábrika: Unidade:
46781 CARBRINK CR/1
F1 F4

UN: R\$ 2,83 AV: R\$ 16,96 15: R\$ 17,32
30: R\$ 17,66 45: R\$ 18,02 60: R\$ 18,38



CANETA FLAIR BOLD 1.2MM PONTA POROSA 6X1
Código: Fábrika: Unidade:
48209 PAPER MATE CR/6
F1 F4

UN: R\$ 6,32 AV: R\$ 37,93 15: R\$ 38,72
30: R\$ 39,49 45: R\$ 40,28 60: R\$ 41,09



CANETA GEL GLITTER 1.0MM COLOR 980 6X1
Código: Fábrika: Unidade:
41900 LYKE CR/6
F1 F4

UN: R\$ 4,16 AV: R\$ 49,91 15: R\$ 50,95
30: R\$ 51,97 45: R\$ 53,01 60: R\$ 54,07



CANETA GEL GLITTER 1,0MM PRATA 1120 12X1
Código: Fábrika: Unidade:
42593 JOCAROFFICE CR/12
F1 F4

UN: R\$ 4,16 AV: R\$ 49,91 15: R\$ 50,95
30: R\$ 51,97 45: R\$ 53,01 60: R\$ 54,07



CANETA GEL GLITTER 1.0MM PRATA 12X1
Código: Fábrika: Unidade:
41932 TRIS CR/12
F1 F4

UN: R\$ 2,82 AV: R\$ 112,81 15: R\$ 115,16
30: R\$ 117,46 45: R\$ 119,81 60: R\$ 122,21



CANETA GEL GLITTER 1.0MM SORT 97933 40X1
Código: Fábrika: Unidade:
46159 JOCAROFFICE PT/40
F1 F4

UN: R\$ 5,99 AV: R\$ 5,99 15: R\$ 6,12
30: R\$ 6,24 45: R\$ 6,36 60: R\$ 6,49



CANETA GEL METAL 0.7MM OURO/PRATA UN
Código: Fábrika: Unidade:
42830 JOCAROFFICE UN/1
F1 F4

UN: R\$ 5,82 AV: R\$ 34,93 15: R\$ 35,66
30: R\$ 36,38 45: R\$ 37,10 60: R\$ 37,84



CANETA GEL NEON 1.0MM COLOR 966 6X1
Código: Fábrika: Unidade:
41901 LYKE CR/6
F1 F4

UN: R\$ 5,49 AV: R\$ 65,86 15: R\$ 67,24
30: R\$ 68,58 45: R\$ 69,95 60: R\$ 71,35



CANETA GEL 0.5 MM APAGAVEL AZUL 251 12X1
Código: Fábrika: Unidade:
48169 MJ CX/12
F1 F4

UN: R\$ 5,49 AV: R\$ 65,86 15: R\$ 67,24
30: R\$ 68,58 45: R\$ 69,95 60: R\$ 71,35



CANETA GEL 0.5 MM APAGAVEL AZUL 606 12X1
Código: Fábrika: Unidade:
48167 MJ CX/12
F1 F4

UN: R\$ 5,49 AV: R\$ 65,86 15: R\$ 67,24
30: R\$ 68,58 45: R\$ 69,95 60: R\$ 71,35



CANETA GEL 0.5 MM APAGAVEL AZUL 998 12X1
Código: Fábrika: Unidade:
48168 MJ CX/12
F1 F4

UN: R\$ 3,42 AV: R\$ 27,35 15: R\$ 27,92
30: R\$ 28,47 45: R\$ 29,04 60: R\$ 29,62



CANETA GEL 0.55 MM POP UP 97924 8X1
Código: Fábrika: Unidade:
46360 JOCAROFFICE CT/8
F1 F4

UN: R\$ 2,77 AV: R\$ 138,65 15: R\$ 141,54
30: R\$ 144,37 45: R\$ 147,25 60: R\$ 150,20



CANETA GEL 0.7 MM HAPPY 5 CORES 50X1
Código: Fábrika: Unidade:
46366 JOCAROFFICE PT/50
F1 F4

UN: R\$ 2,90 AV: R\$ 145,24 15: R\$ 148,26
30: R\$ 151,23 45: R\$ 154,25 60: R\$ 157,34



CANETA GEL 0.7 MM RAINBOW 6 CORES 50X1

Código: Fábrika: Unidade:
46365 JOCAROFFICE PT/50
F1 F4

UN: R\$ 3,48 AV: R\$ 20,88 15: R\$ 21,31
30: R\$ 21,74 45: R\$ 22,17 60: R\$ 22,62



CANETA GEL 0.7 MM RAINBOW 97936 6X1

Código: Fábrika: Unidade:
46359 JOCAROFFICE CT/6
F1 F4

UN: R\$ 3,62 AV: R\$ 28,94 15: R\$ 29,55
30: R\$ 30,14 45: R\$ 30,74 60: R\$ 31,36



CANETA GEL 1.0 MM CORES 232214 8X1

Código: Fábrika: Unidade:
46384 FUTURO CT/8
F1 F4

UN: R\$ 4,39 AV: R\$ 43,92 15: R\$ 44,83
30: R\$ 45,73 45: R\$ 46,65 60: R\$ 47,58



CANETA GEL 1.0MM GLITTER 98121 10X1

Código: Fábrika: Unidade:
46393 KAZ CT/10
F1 F4

UN: R\$ 3,73 AV: R\$ 18,66 15: R\$ 19,05
30: R\$ 19,43 45: R\$ 19,82 60: R\$ 20,21



CANETA GEL 1.0MM GLITTER 98152 6X1

Código: Fábrika: Unidade:
46392 KAZ CT/5
F1 F4

UN: R\$ 2,41 AV: R\$ 14,48 15: R\$ 14,78
30: R\$ 15,07 45: R\$ 15,38 60: R\$ 15,68



CANETA HIDROG 0.4 MM 6 CORES 6183

Código: Fábrika: Unidade:
40676 GOLLER CR/6
F1 F4

UN: R\$ 2,50 AV: R\$ 29,94 15: R\$ 30,57
30: R\$ 31,18 45: R\$ 31,80 60: R\$ 32,44



CANETA HIDROG 0.4 FINELINER AZUL ES 12X1

Código: Fábrika: Unidade:
43607 BRW PT/12
F1 F4

UN: R\$ 2,50 AV: R\$ 29,94 15: R\$ 30,57
30: R\$ 31,18 45: R\$ 31,80 60: R\$ 32,44



CANETA HIDROG 0.4 FINELINER PINK NE 12X1

Código: Fábrika: Unidade:
44992 BRW PT/12
F1 F4

UN: R\$ 2,50 AV: R\$ 29,94 15: R\$ 30,57
30: R\$ 31,18 45: R\$ 31,80 60: R\$ 32,44



CANETA HIDROG 0.4 FINELINER PRETO 12X1

Código: Fábrika: Unidade:
44991 BRW PT/12
F1 F4

UN: R\$ 2,02 AV: R\$ 12,12 15: R\$ 12,37
30: R\$ 12,62 45: R\$ 12,87 60: R\$ 13,13



CANETA HIDROG 0.4 FINELINER SORT 6X1

Código: Fábrika: Unidade:
46827 BRW PT/6
F1 F4

UN: R\$ 21,95 AV: R\$ 21,95 15: R\$ 22,41
30: R\$ 22,86 45: R\$ 23,32 60: R\$ 23,78



CANETA HIDROGRAFICA BIG 12 CORES 4585

Código: Fábrika: Unidade:
42590 LEO&LEO CR/1
F1 F4

UN: R\$ 1,41 AV: R\$ 16,96 15: R\$ 17,32
30: R\$ 17,66 45: R\$ 18,02 60: R\$ 18,38



CANETA KILOMETRICA 0.7MM AZUL 12X1

Código: Fábrika: Unidade:
45522 PAPER MATE CX/12
F1 F4

UN: R\$ 1,40 AV: R\$ 69,86 15: R\$ 71,31
30: R\$ 72,74 45: R\$ 74,19 60: R\$ 75,68



CANETA KILOMETRICA 0.7MM AZUL 50X1

Código: Fábrika: Unidade:
29037 PAPER MATE CX/50
F1 F4

UN: R\$ 1,40 AV: R\$ 69,86 15: R\$ 71,31
30: R\$ 72,74 45: R\$ 74,19 60: R\$ 75,68



CANETA KILOMETRICA 0.7MM PRETA 50X1

Código: Fábrika: Unidade:
29038 PAPER MATE CX/50
F1 F4

UN: R\$ 1,41 AV: R\$ 16,96 15: R\$ 17,32
30: R\$ 17,66 45: R\$ 18,02 60: R\$ 18,38



CANETA KILOMETRICA 0.7MM PRETO 12X1

Código: Fábrika: Unidade:
45523 PAPER MATE CX/12
F1 F4

UN: R\$ 1,40 AV: R\$ 69,86 15: R\$ 71,31
30: R\$ 72,74 45: R\$ 74,19 60: R\$ 75,68



CANETA KILOMETRICA 0.7MM VERMELHO 50X1

Código: Fábrika: Unidade:
29908 PAPER MATE CX/50
F1 F4

UN: R\$ 0,96 AV: R\$ 47,91 15: R\$ 48,91
30: R\$ 49,89 45: R\$ 50,89 60: R\$ 51,91



CANETA KILOMETRICA 1.0MM AZUL 50X1
Código: Fábrika: Unidade:
26807 PAPER MATE CX/50
F1 F4

UN: R\$ 2,99 AV: R\$ 11,97 15: R\$ 12,22
30: R\$ 12,46 45: R\$ 12,71 60: R\$ 12,97



CANETA KILOMETRICA 1.0MM COLOR 4X1
Código: Fábrika: Unidade:
29841 PAPER MATE PT/4
F1 F4

UN: R\$ 2,74 AV: R\$ 21,95 15: R\$ 22,41
30: R\$ 22,86 45: R\$ 23,32 60: R\$ 23,78



CANETA KILOMETRICA 1.0MM COLOR 8X1
Código: Fábrika: Unidade:
26805 PAPER MATE PT/8
F1 F4

UN: R\$ 2,69 AV: R\$ 26,95 15: R\$ 27,51
30: R\$ 28,06 45: R\$ 28,62 60: R\$ 29,19



CANETA KILOMETRICA 1.0MM COLOR 10X1
Código: Fábrika: Unidade:
45521 PAPER MATE PT/10
F1 F4

UN: R\$ 2,50 AV: R\$ 59,89 15: R\$ 61,14
30: R\$ 62,36 45: R\$ 63,61 60: R\$ 64,88



CANETA KILOMETRICA 1.0MM COLOR 24X1
Código: Fábrika: Unidade:
26787 PAPER MATE PT/24
F1 F4

UN: R\$ 0,83 AV: R\$ 49,91 15: R\$ 50,95
30: R\$ 51,97 45: R\$ 53,01 60: R\$ 54,07



CANETA KILOMETRICA 1.0MM POP AZUL 60X1
Código: Fábrika: Unidade:
45524 PAPER MATE CX/60
F1 F4

UN: R\$ 0,83 AV: R\$ 49,91 15: R\$ 50,95
30: R\$ 51,97 45: R\$ 53,01 60: R\$ 54,07



CANETA KILOMETRICA 1.0MM POP PRETA 60X1
Código: Fábrika: Unidade:
45525 PAPER MATE CX/60
F1 F4

UN: R\$ 0,83 AV: R\$ 49,91 15: R\$ 50,95
30: R\$ 51,97 45: R\$ 53,01 60: R\$ 54,07



CANETA KILOMETRICA 1.0MM POP VERMEL 60X1
Código: Fábrika: Unidade:
45526 PAPER MATE CX/60
F1 F4

UN: R\$ 1,99 AV: R\$ 23,93 15: R\$ 24,43
30: R\$ 24,92 45: R\$ 25,42 60: R\$ 25,93



CANETA KILOMETRICA 1.0MM RETR AZUL 12X1
Código: Fábrika: Unidade:
48208 PAPER MATE CX/12
F1 F4

UN: R\$ 1,91 AV: R\$ 22,96 15: R\$ 23,44
30: R\$ 23,91 45: R\$ 24,39 60: R\$ 24,88



CANETA KILOMETRICA 1.0MM RETR AZUL 12X1
Código: Fábrika: Unidade:
41619 PAPER MATE CX/12
F1 F4

UN: R\$ 0,96 AV: R\$ 47,91 15: R\$ 48,91
30: R\$ 49,89 45: R\$ 50,89 60: R\$ 51,91



CANETA KILOMETRICA 1.0MM VERMELHA 50X1
Código: Fábrika: Unidade:
26806 PAPER MATE CX/50
F1 F4

UN: R\$ 6,43 AV: R\$ 32,15 15: R\$ 32,82
30: R\$ 33,47 45: R\$ 34,14 60: R\$ 34,83



CANETA MARC PERMANENTE COSMIC COLOR 5X1
Código: Fábrika: Unidade:
48217 SHARPIE CR/5
F1 F4

UN: R\$ 18,94 AV: R\$ 18,94 15: R\$ 19,33
30: R\$ 19,72 45: R\$ 20,12 60: R\$ 20,52



CANETA MARC PERMANENTE FINA PRATA CTL
Código: Fábrika: Unidade:
48214 SHARPIE CR/1
F1 F4

UN: R\$ 9,28 AV: R\$ 9,28 15: R\$ 9,47
30: R\$ 9,66 45: R\$ 9,85 60: R\$ 10,05



CANETA MARC PERMANENTE FINA PRETO CTL
Código: Fábrika: Unidade:
48218 SHARPIE CR/1
F1 F4

UN: R\$ 1,16 AV: R\$ 13,97 15: R\$ 14,26
30: R\$ 14,54 45: R\$ 14,83 60: R\$ 15,13



CANETA MARC PERMANENTE FINA VERM 12X1
Código: Fábrika: Unidade:
48215 SHARPIE CX/12
F1 F4

UN: R\$ 6,24 AV: R\$ 49,91 15: R\$ 50,95
30: R\$ 51,97 45: R\$ 53,01 60: R\$ 54,07



CANETA MARC PERMANENTE 8 CORES BRUSH TIP
Código: Fábrika: Unidade:
48219 SHARPIE CR/8
F1 F4

UN: R\$ 3,49 AV: R\$ 41,92 15: R\$ 42,80
30: R\$ 43,65 45: R\$ 44,53 60: R\$ 45,42



CANETA MARCA CD/DVD PONT DUPLA AZUL 12X1
Código: 49956 Fábrica: BAZZE Unidade: DZ/12 F1 F4

UN: R\$ 3,49 AV: R\$ 41,92 15: R\$ 42,80
30: R\$ 43,65 45: R\$ 44,53 60: R\$ 45,42



CANETA MARCA CD/DVD PONT DUPLA PTO 12X1
Código: 49957 Fábrica: BAZZE Unidade: DZ/12 F1 F4

UN: R\$ 2,50 AV: R\$ 29,94 15: R\$ 30,57
30: R\$ 31,18 45: R\$ 31,80 60: R\$ 32,44



CANETA MARCA CD/DVD/RETROP VERDE 12X1
Código: 43741 Fábrica: FIX PAPER Unidade: DZ/12 F1 F4

UN: R\$ 2,33 AV: R\$ 27,95 15: R\$ 28,53
30: R\$ 29,10 45: R\$ 29,68 60: R\$ 30,27



CANETA MARCA CD/RETROPROJ VERMELHA 12X1
Código: 24884 Fábrica: ONDA Unidade: DZ/12 F1 F4

UN: R\$ 9,47 AV: R\$ 9,47 15: R\$ 9,67
30: R\$ 9,87 45: R\$ 10,06 60: R\$ 10,26



CANETA MARCADOR TECIDO PERM 501 AZUL
Código: 41765 Fábrica: ACRILEX Unidade: UN/1 F1 F4

UN: R\$ 9,47 AV: R\$ 9,47 15: R\$ 9,67
30: R\$ 9,87 45: R\$ 10,06 60: R\$ 10,26



CANETA MARCADOR TECIDO PERM 503 AZUL
Código: 43538 Fábrica: ACRILEX Unidade: UN/1 F1 F4

UN: R\$ 9,47 AV: R\$ 9,47 15: R\$ 9,67
30: R\$ 9,87 45: R\$ 10,06 60: R\$ 10,26



CANETA MARCADOR TECIDO PERM 507 VERMELH
Código: 41768 Fábrica: ACRILEX Unidade: UN/1 F1 F4

UN: R\$ 9,47 AV: R\$ 9,47 15: R\$ 9,67
30: R\$ 9,87 45: R\$ 10,06 60: R\$ 10,26



CANETA MARCADOR TECIDO PERM 510 VERDE
Código: 44976 Fábrica: ACRILEX Unidade: UN/1 F1 F4

UN: R\$ 9,47 AV: R\$ 9,47 15: R\$ 9,67
30: R\$ 9,87 45: R\$ 10,06 60: R\$ 10,26



CANETA MARCADOR TECIDO PERM 513 VERDE
Código: 41764 Fábrica: ACRILEX Unidade: UN/1 F1 F4

UN: R\$ 9,47 AV: R\$ 9,47 15: R\$ 9,67
30: R\$ 9,87 45: R\$ 10,06 60: R\$ 10,26



CANETA MARCADOR TECIDO PERM 516 VIOLETA
Código: 44975 Fábrica: ACRILEX Unidade: UN/1 F1 F4

UN: R\$ 9,47 AV: R\$ 9,47 15: R\$ 9,67
30: R\$ 9,87 45: R\$ 10,06 60: R\$ 10,26



CANETA MARCADOR TECIDO PERM 517 LARANJA
Código: 44974 Fábrica: ACRILEX Unidade: UN/1 F1 F4

UN: R\$ 9,47 AV: R\$ 9,47 15: R\$ 9,67
30: R\$ 9,87 45: R\$ 10,06 60: R\$ 10,26



CANETA MARCADOR TECIDO PERM 520 PRETO
Código: 41767 Fábrica: ACRILEX Unidade: UN/1 F1 F4

UN: R\$ 9,47 AV: R\$ 9,47 15: R\$ 9,67
30: R\$ 9,87 45: R\$ 10,06 60: R\$ 10,26



CANETA MARCADOR TECIDO PERM 531 MARROM
Código: 43539 Fábrica: ACRILEX Unidade: UN/1 F1 F4

UN: R\$ 9,47 AV: R\$ 9,47 15: R\$ 9,67
30: R\$ 9,87 45: R\$ 10,06 60: R\$ 10,26



CANETA MARCADOR TECIDO PERM 537 ROSA
Código: 44973 Fábrica: ACRILEX Unidade: UN/1 F1 F4

UN: R\$ 9,47 AV: R\$ 9,47 15: R\$ 9,67
30: R\$ 9,87 45: R\$ 10,06 60: R\$ 10,26



CANETA MARCADOR TECIDO PERM 565 VINHO
Código: 43540 Fábrica: ACRILEX Unidade: UN/1 F1 F4

UN: R\$ 4,48 AV: R\$ 4,48 15: R\$ 4,58
30: R\$ 4,67 45: R\$ 4,76 60: R\$ 4,86



CANETA MARCADOR TECIDO PRETO 4917015
Código: 46846 Fábrica: ONDA Unidade: CR/1 F1 F4

UN: R\$ 1,91 AV: R\$ 22,95 15: R\$ 23,43
30: R\$ 23,90 45: R\$ 24,38 60: R\$ 24,87



CANETA 0.4MM MARCA CD/DVD/RETR 7530 12X1
Código: Fábrika: Unidade:
48148 YIN'S PAPER DZ/12
F1 F4

UN: R\$ 4,82 AV: R\$ 28,94 15: R\$ 29,55
30: R\$ 30,14 45: R\$ 30,74 60: R\$ 31,36



CANETA 0.4MM MICROLINE SORT 6X1
Código: Fábrika: Unidade:
48155 COMPACTOR CR/6
F1 F4

UN: R\$ 4,84 AV: R\$ 48,42 15: R\$ 49,43
30: R\$ 50,42 45: R\$ 51,43 60: R\$ 52,46



CANETA 0.4MM MICROLINE SORT 10X1
Código: Fábrika: Unidade:
48156 COMPACTOR CR/10
F1 F4

UN: R\$ 4,98 AV: R\$ 59,79 15: R\$ 61,04
30: R\$ 62,26 45: R\$ 63,51 60: R\$ 64,78



CANETA 0.4MM MICROLINE SORT 12X1
Código: Fábrika: Unidade:
35993 COMPACTOR CR/12
F1 F4

UN: R\$ 1,85 AV: R\$ 18,47 15: R\$ 18,86
30: R\$ 19,23 45: R\$ 19,62 60: R\$ 20,01



CANETA 0.4MM MICROLINER AMARELO 7409 10X1
Código: Fábrika: Unidade:
48301 YIN'S PAPER CX/10
F1 F4

UN: R\$ 1,90 AV: R\$ 18,96 15: R\$ 19,35
30: R\$ 19,74 45: R\$ 20,14 60: R\$ 20,54



CANETA 0.4MM MICROLINER LILAS 7379 10X1
Código: Fábrika: Unidade:
47922 YIN'S PAPER CX/10
F1 F4

UN: R\$ 1,90 AV: R\$ 18,96 15: R\$ 19,35
30: R\$ 19,74 45: R\$ 20,14 60: R\$ 20,54



CANETA 0.4MM MICROLINER ROSA 7378 10X1
Código: Fábrika: Unidade:
47920 YIN'S PAPER CX/10
F1 F4

UN: R\$ 1,90 AV: R\$ 18,96 15: R\$ 19,35
30: R\$ 19,74 45: R\$ 20,14 60: R\$ 20,54



CANETA 0.4MM MICROLINER VERDE 7380 10X1
Código: Fábrika: Unidade:
47921 YIN'S PAPER CX/10
F1 F4

UN: R\$ 1,90 AV: R\$ 18,96 15: R\$ 19,35
30: R\$ 19,74 45: R\$ 20,14 60: R\$ 20,54



CANETA 0.4MM MICROLINER VERMEL 7377 10X1
Código: Fábrika: Unidade:
47919 YIN'S PAPER CX/10
F1 F4

UN: R\$ 2,99 AV: R\$ 14,97 15: R\$ 15,28
30: R\$ 15,58 45: R\$ 15,90 60: R\$ 16,21



CANETA 1.0MM COLOR 5X1
Código: Fábrika: Unidade:
46278 MOLIN CR/5
F1 F4

UN: R\$ 11,97 AV: R\$ 11,97 15: R\$ 12,22
30: R\$ 12,46 45: R\$ 12,71 60: R\$ 12,97



CANETINHA HIDR NEO PEN GIG 12 CORES
Código: Fábrika: Unidade:
6897 COMPACTOR CX/1
F1 F4

UN: R\$ 25,95 AV: R\$ 25,95 15: R\$ 26,49
30: R\$ 27,02 45: R\$ 27,56 60: R\$ 28,11



CANETINHA HIDR NEO PEN GIG 24 CORES UN
Código: Fábrika: Unidade:
47862 COMPACTOR CX/1
F1 F4

UN: R\$ 5,98 AV: R\$ 5,98 15: R\$ 6,11
30: R\$ 6,23 45: R\$ 6,35 60: R\$ 6,48



CANETINHA HIDR NEO PEN MIRIM 06 CORES
Código: Fábrika: Unidade:
45062 COMPACTOR CX/1
F1 F4

UN: R\$ 10,97 AV: R\$ 10,97 15: R\$ 11,20
30: R\$ 11,43 45: R\$ 11,65 60: R\$ 11,89



CANETINHA HIDR NEO PEN MIRIM 12 CORES
Código: Fábrika: Unidade:
45061 COMPACTOR CX/1
F1 F4

UN: R\$ 1,00 AV: R\$ 6,98 15: R\$ 7,12
30: R\$ 7,27 45: R\$ 7,41 60: R\$ 7,56



CANETINHA HIDR PQ GROSSA 07 CORES CS-007
Código: Fábrika: Unidade:
45221 MCAVM PT/7
F1 F4

UN: R\$ 3,58 AV: R\$ 3,58 15: R\$ 3,66
30: R\$ 3,73 45: R\$ 3,81 60: R\$ 3,88



CANETINHA HIDROCOR 6 CORES 614878
Código: Fábrika: Unidade:
49958 BAZZE WAVE CR/1
F1 F4

UN: R\$ 5,98 AV: R\$ 5,98 15: R\$ 6,11
30: R\$ 6,23 45: R\$ 6,35 60: R\$ 6,48



CANETINHA HIDROCOR 12 CORES UN 614816
Código: 49959 Fábrica: BAZZE WAVE Unidade: CR/1 F1 F4

UN: R\$ 13,38 AV: R\$ 13,38 15: R\$ 13,66
30: R\$ 13,93 45: R\$ 14,21 60: R\$ 14,49



CANETINHA HIDROCOR 24 CORES WAVE CTL
Código: 41933 Fábrica: TRIS Unidade: CT/1 F1 F4

UN: R\$ 13,81 AV: R\$ 82,87 15: R\$ 84,59
30: R\$ 86,29 45: R\$ 88,01 60: R\$ 89,77



CANETINHA HIDROCOR 24 CORES 6X1
Código: 38256 Fábrica: WALEU Unidade: PT/6 F1 F4

UN: R\$ 10,97 AV: R\$ 10,97 15: R\$ 11,20
30: R\$ 11,43 45: R\$ 11,65 60: R\$ 11,89



CANETINHA HIDROGRAFICA 06 CORES 720
Código: 41649 Fábrica: LEO&LEO Unidade: CR/1 F1 F4

UN: R\$ 5,82 AV: R\$ 69,88 15: R\$ 71,33
30: R\$ 72,76 45: R\$ 74,22 60: R\$ 75,70



CANETINHA HIDROGRAFICA 12 CORES 12X1
Código: 49270 Fábrica: COLORARE Unidade: PT/12 F1 F4

UN: R\$ 0,50 AV: R\$ 49,91 15: R\$ 50,95
30: R\$ 51,97 45: R\$ 53,01 60: R\$ 54,07

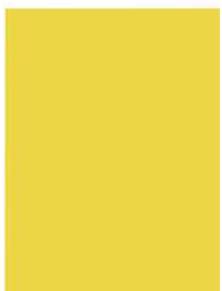

CAPA LINE A4 FRENTE AMARELO ENCAD 100X1
Código: 30450 Fábrica: LASSANE Unidade: PT/100 F1 F4

UN: R\$ 0,50 AV: R\$ 49,91 15: R\$ 50,95
30: R\$ 51,97 45: R\$ 53,01 60: R\$ 54,07

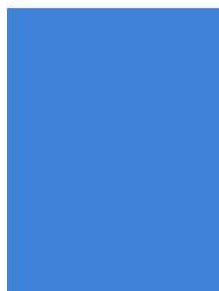

CAPA LINE A4 FRENTE AZUL ENCAD 100X1
Código: 30452 Fábrica: LASSANE Unidade: PT/100 F1 F4

UN: R\$ 0,50 AV: R\$ 49,91 15: R\$ 50,95
30: R\$ 51,97 45: R\$ 53,01 60: R\$ 54,07



CAPA LINE A4 FRENTE FUME ENCAD 100X1
Código: 36622 Fábrica: LASSANE Unidade: PT/100 F1 F4

UN: R\$ 0,50 AV: R\$ 49,91 15: R\$ 50,95
30: R\$ 51,97 45: R\$ 53,01 60: R\$ 54,07

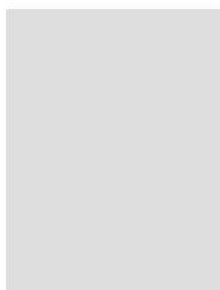

CAPA LINE A4 FRENTE INCOLOR ENCAD 100X1
Código: 8955 Fábrica: LASSANE Unidade: PT/100 F1 F4

UN: R\$ 0,50 AV: R\$ 49,91 15: R\$ 50,95
30: R\$ 51,97 45: R\$ 53,01 60: R\$ 54,07



CAPA LINE A4 FRENTE ROSA ENCAD 100X1
Código: 36621 Fábrica: LASSANE Unidade: PT/100 F1 F4

UN: R\$ 0,50 AV: R\$ 49,91 15: R\$ 50,95
30: R\$ 51,97 45: R\$ 53,01 60: R\$ 54,07



CAPA LINE A4 FRENTE VERMELHO ENCAD 100X1
Código: 30453 Fábrica: LASSANE Unidade: PT/100 F1 F4

UN: R\$ 0,50 AV: R\$ 49,91 15: R\$ 50,95
30: R\$ 51,97 45: R\$ 53,01 60: R\$ 54,07



CAPA LINE A4 FUNDO AMARELO ENCAD 10X1
Código: 30451 Fábrica: LASSANE Unidade: PT/100 F1 F4

UN: R\$ 0,50 AV: R\$ 49,91 15: R\$ 50,95
30: R\$ 51,97 45: R\$ 53,01 60: R\$ 54,07

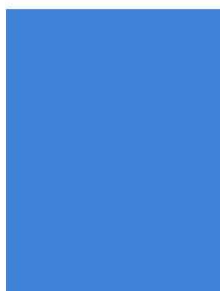

CAPA LINE A4 FUNDO AZUL ENCAD 100X1
Código: 30454 Fábrica: LASSANE Unidade: PT/100 F1 F4

UN: R\$ 0,40 AV: R\$ 39,93 15: R\$ 40,76
30: R\$ 41,57 45: R\$ 42,40 60: R\$ 43,25

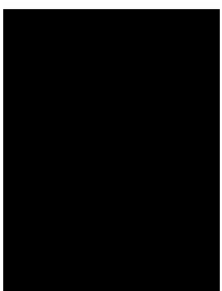

CAPA LINE A4 FUNDO PRETO ENCAD 100X1
Código: 8957 Fábrica: LASSANE Unidade: PT/100 F1 F4

UN: R\$ 0,50 AV: R\$ 49,91 15: R\$ 50,95
30: R\$ 51,97 45: R\$ 53,01 60: R\$ 54,07



CAPA LINE A4 FUNDO VERDE ENCAD 100X1
Código: 30456 Fábrica: LASSANE Unidade: PT/100 F1 F4

UN: R\$ 0,50 AV: R\$ 49,91 15: R\$ 50,95
30: R\$ 51,97 45: R\$ 53,01 60: R\$ 54,07

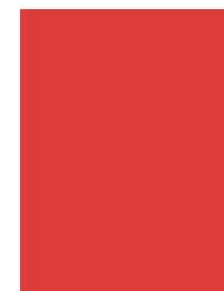

CAPA LINE A4 FUNDO VERMELHO ENCAD 100X1
Código: 30455 Fábrica: LASSANE Unidade: PT/100 F1 F4

UN: R\$ 0,90 AV: R\$ 89,85 15: R\$ 91,72
30: R\$ 93,55 45: R\$ 95,42 60: R\$ 97,33



CAPA LINE OF2 FRENTE INCOLOR ENCAD 100X1
Código: 41849 Fábrica: LASSANE Unidade: PT/100 F1 F4

UN: R\$ 1,40 AV: R\$ 69,88 15: R\$ 71,33
30: R\$ 72,76 45: R\$ 74,22 60: R\$ 75,70

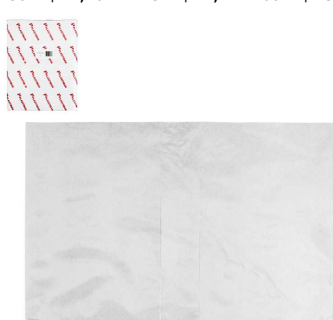

CAPA P/CADERNO BROCHURAO TRANSP 50X1
Código: 21621 Fábrica: PLASTIBAN Unidade: PT/50 F1 F4

UN: R\$ 1,20 AV: R\$ 59,89 15: R\$ 61,14
30: R\$ 62,36 45: R\$ 63,61 60: R\$ 64,88



CAPA P/CADERNO CD 1/4 48/96 FLS HP3 50X1
Código: 41284 Fábrica: HP PLAST Unidade: PT/50 F1 F4

UN: R\$ 1,20 AV: R\$ 59,89 15: R\$ 61,14
30: R\$ 62,36 45: R\$ 63,61 60: R\$ 64,88



CAPA P/CADERNO DESENHO SOLTA HP25 50X1
Código: 41282 Fábrica: HP PLAST Unidade: PT/50 F1 F4

UN: R\$ 1,40 AV: R\$ 69,88 15: R\$ 71,33
30: R\$ 72,76 45: R\$ 74,22 60: R\$ 75,70

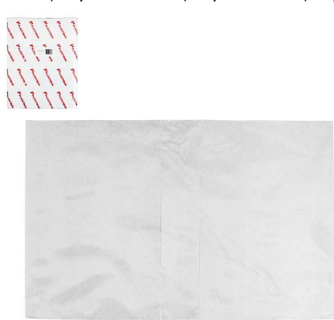

CAPA P/CADERNO UNIVERSITARIO TRANSP 50X1
Código: 21623 Fábrica: PLASTIBAN Unidade: PT/50 F1 F4

UN: R\$ 1,20 AV: R\$ 59,89 15: R\$ 61,14
30: R\$ 62,36 45: R\$ 63,61 60: R\$ 64,88



CAPA P/CADERNO 1/4 48/96 FLS HP2 50X1
Código: 41283 Fábrica: HP PLAST Unidade: PT/50 F1 F4

UN: R\$ 2,86 AV: R\$ 285,54 15: R\$ 291,49
30: R\$ 297,32 45: R\$ 303,27 60: R\$ 309,33



CARBONO COST 44X66CM RISC/BOR AMAR 100X1
Código: 48067 Fábrica: PRINTERS Unidade: CE/100 F1 F4

UN: R\$ 2,86 AV: R\$ 285,54 15: R\$ 291,49
30: R\$ 297,32 45: R\$ 303,27 60: R\$ 309,33

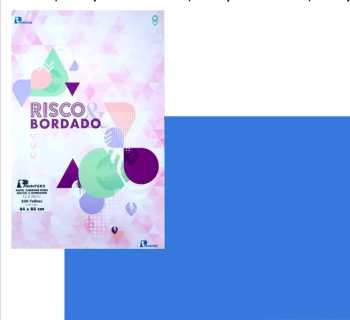

CARBONO COST 44X66CM RISC/BOR AZUL 100X1
Código: 48066 Fábrica: PRINTERS Unidade: CE/100 F1 F4

UN: R\$ 2,86 AV: R\$ 285,54 15: R\$ 291,49
30: R\$ 297,32 45: R\$ 303,27 60: R\$ 309,33



CARBONO COST 44X66CM RISC/BOR BCO 100X1
Código: 48068 Fábrica: PRINTERS Unidade: CE/100 F1 F4

UN: R\$ 2,86 AV: R\$ 285,54 15: R\$ 291,49
30: R\$ 297,32 45: R\$ 303,27 60: R\$ 309,33



CARBONO COST 44X66CM RISC/BOR PTO 100X1
Código: 48069 Fábrica: PRINTERS Unidade: CE/100 F1 F4

UN: R\$ 2,86 AV: R\$ 285,54 15: R\$ 291,49
30: R\$ 297,32 45: R\$ 303,27 60: R\$ 309,33



CARBONO COST 44X66CM RISC/BOR VERM 100X1
Código: 50833 Fábrica: PRINTERS Unidade: CE/100 F1 F4

UN: R\$ 0,60 AV: R\$ 59,90 15: R\$ 61,15
30: R\$ 62,38 45: R\$ 63,62 60: R\$ 64,90



CARBONO DUPLA FACE AZUL 5861 100X1
Código: 22898 Fábrica: GOLLER Unidade: CX/100 F1 F4

UN: R\$ 0,54 AV: R\$ 53,88 15: R\$ 55,01
30: R\$ 56,11 45: R\$ 57,23 60: R\$ 58,37



CARBONO DUPLA FACE AZUL 98688 100X1
Código: 48323 Fábrica: BAZZE Unidade: CX/100 F1 F4

UN: R\$ 0,45 AV: R\$ 44,92 15: R\$ 45,85
30: R\$ 46,77 45: R\$ 47,71 60: R\$ 48,66



CARBONO DUPLA FACE ROXO 17139 100X1
Código: 41926 Fábrica: TRIS Unidade: CX/100 F1 F4

UN: R\$ 0,50 AV: R\$ 49,91 15: R\$ 50,95
30: R\$ 51,97 45: R\$ 53,01 60: R\$ 54,07



CARBONO FILM AZUL 1 FACE 100X1
Código: 6845 Fábrica: KORES Unidade: CE/100 F1 F4

UN: R\$ 4,16 AV: R\$ 49,91 15: R\$ 50,95
30: R\$ 51,97 45: R\$ 53,01 60: R\$ 54,07

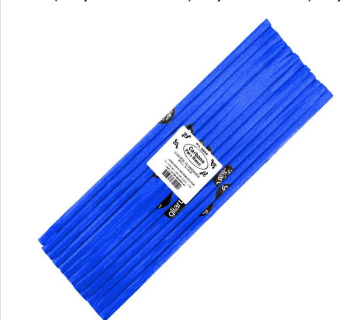

CARBONO P/RISCO 33X44CM AZUL 2602 12X1
Código: 45504 Fábrica: GLIART Unidade: PT/12 F1 F4

UN: R\$ 4,16 AV: R\$ 49,91 15: R\$ 50,95
30: R\$ 51,97 45: R\$ 53,01 60: R\$ 54,07



CARBONO P/RISCO 33X44CM BRANCO 2601 12X1
Código: Fábrika: Unidade:
36251 GLIART PT/12
F1 F4

UN: R\$ 0,60 AV: R\$ 59,89 15: R\$ 61,14
30: R\$ 62,36 45: R\$ 63,61 60: R\$ 64,88



CARBONO 1 FACE PRETO A4 100X1
Código: Fábrika: Unidade:
6844 GRAMP LINE PT/100
F1 F4

UN: R\$ 17,96 AV: R\$ 17,96 15: R\$ 18,34
30: R\$ 18,70 45: R\$ 19,08 60: R\$ 19,46



CARIMBO AUTOM AUTO ENTINTAD 14X38MM 2501
Código: Fábrika: Unidade:
46649 CARBRINK UN/1
F1 F4

UN: R\$ 21,95 AV: R\$ 21,95 15: R\$ 22,41
30: R\$ 22,86 45: R\$ 23,32 60: R\$ 23,78



CARIMBO AUTOM AUTO ENTINTAD 18X47MM 2521
Código: Fábrika: Unidade:
50134 CARBRINK UN/1
F1 F4

UN: R\$ 42,92 AV: R\$ 42,92 15: R\$ 43,82
30: R\$ 44,69 45: R\$ 45,59 60: R\$ 46,50



CARIMBO AUTOM AUTO ENTINTAD 60X40MM 2521
Código: Fábrika: Unidade:
50987 CARBRINK UN/1
F1 F4

UN: R\$ 234,62 AV: R\$ 234,62 15: R\$ 239,51
30: R\$ 244,30 45: R\$ 249,19 60: R\$ 254,17



CARIMBO AUTOM NUMERADOR 6 DIG
Código: Fábrika: Unidade:
49177 CARBRINK UN/1
F1 F4

UN: R\$ 24,66 AV: R\$ 24,66 15: R\$ 25,17
30: R\$ 25,68 45: R\$ 26,19 60: R\$ 26,72



CARIMBO ENTINTADO INF NUMEROS 10X1
Código: Fábrika: Unidade:
41974 VMP UN/1
F1 F4

UN: R\$ 2,64 AV: R\$ 68,59 15: R\$ 70,02
30: R\$ 71,42 45: R\$ 72,85 60: R\$ 74,30



CARIMBO ENTINTADO INF SORT 2 26X1
Código: Fábrika: Unidade:
46010 VMP CX/26
F1 F4

UN: R\$ 2,64 AV: R\$ 68,59 15: R\$ 70,02
30: R\$ 71,42 45: R\$ 72,85 60: R\$ 74,30



CARIMBO ENTINTADO INF SORT 3 26X1
Código: Fábrika: Unidade:
46011 VMP CX/26
F1 F4

UN: R\$ 86,72 AV: R\$ 86,72 15: R\$ 88,53
30: R\$ 90,30 45: R\$ 92,10 60: R\$ 93,95



CARIMBOS ALFABETO MAD 28PCS 50932
Código: Fábrika: Unidade:
49529 XALINGO UN/1
F1 F4

UN: R\$ 48,06 AV: R\$ 48,06 15: R\$ 49,06
30: R\$ 50,05 45: R\$ 51,05 60: R\$ 52,07



CARIMBOS ANIMAIS SITIO MAD C/GIZ 50787
Código: Fábrika: Unidade:
49554 XALINGO UN/1
F1 F4

UN: R\$ 33,59 AV: R\$ 33,59 15: R\$ 34,29
30: R\$ 34,97 45: R\$ 35,67 60: R\$ 36,38



CARIMBOS FOFOSAURUS MAD C/GIZ CER 54287
Código: Fábrika: Unidade:
49527 XALINGO UN/1
F1 F4

UN: R\$ 86,72 AV: R\$ 86,72 15: R\$ 88,53
30: R\$ 90,30 45: R\$ 92,10 60: R\$ 93,95



CARIMBOS LETRAS E NUMEROS MAD 40PC 50910
Código: Fábrika: Unidade:
49528 XALINGO UN/1
F1 F4

UN: R\$ 29,07 AV: R\$ 29,07 15: R\$ 29,68
30: R\$ 30,27 45: R\$ 30,88 60: R\$ 31,50



CARIMBOS VOGAIS MAD MINHA ESCOLINHA 1543
Código: Fábrika: Unidade:
49821 XALINGO UN/1
F1 F4

UN: R\$ 3,79 AV: R\$ 75,87 15: R\$ 77,45
30: R\$ 79,00 45: R\$ 80,58 60: R\$ 82,19



CARNE GPS (GUIA PREVIDENCIA SOCIAL) 20X1
Código: Fábrika: Unidade:
24938 PARRKE PT/20
F1 F4

UN: R\$ 0,09 AV: R\$ 9,35 15: R\$ 9,54
30: R\$ 9,73 45: R\$ 9,93 60: R\$ 10,12



CARTA COBRANCA 100X1
Código: Fábrika: Unidade:
1330 UNICART CE/100
F1 F4

UN: R\$ 1,68 AV: R\$ 16,82 15: R\$ 17,17
30: R\$ 17,52 45: R\$ 17,87 60: R\$ 18,22



CARTAO G-11 REF 155 BODAS 10X1

Código: Fábrika: Unidade:
5129 UNICART PT/10
F1 F4

UN: R\$ 0,18 AV: R\$ 17,96 15: R\$ 18,34
30: R\$ 18,70 45: R\$ 19,08 60: R\$ 19,46

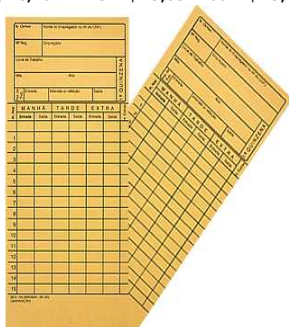

CARTAO PONTO MENSAL SIMPLES 100X1

Código: Fábrika: Unidade:
27101 GRIFFE PT/100
F1 F4

UN: R\$ 0,27 AV: R\$ 13,38 15: R\$ 13,66
30: R\$ 13,93 45: R\$ 14,21 60: R\$ 14,49



CARTAZ ALUGA-SE 157X320MM 50X1

Código: Fábrika: Unidade:
39289 TAMOIO PT/50
F1 F4

UN: R\$ 0,27 AV: R\$ 13,38 15: R\$ 13,66
30: R\$ 13,93 45: R\$ 14,21 60: R\$ 14,49



CARTAZ VENDE-SE 157X320MM 50X1

Código: Fábrika: Unidade:
39290 TAMOIO PT/50
F1 F4

UN: R\$ 2,40 AV: R\$ 47,91 15: R\$ 48,91
30: R\$ 49,89 45: R\$ 50,89 60: R\$ 51,91

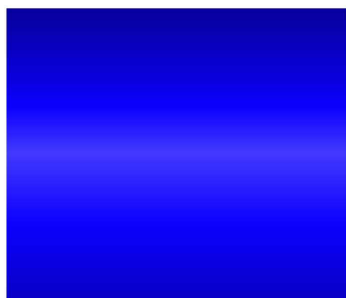

CARTOLINA LAMINADA 48X58CM AZUL 20X1

Código: Fábrika: Unidade:
12804 EMBALE PT/20
F1 F4

UN: R\$ 2,40 AV: R\$ 47,91 15: R\$ 48,91
30: R\$ 49,89 45: R\$ 50,89 60: R\$ 51,91



CARTOLINA LAMINADA 48X58CM OURO 20X1

Código: Fábrika: Unidade:
12805 EMBALE PT/20
F1 F4

UN: R\$ 2,40 AV: R\$ 47,91 15: R\$ 48,91
30: R\$ 49,89 45: R\$ 50,89 60: R\$ 51,91



CARTOLINA LAMINADA 48X58CM PINK 20X1

Código: Fábrika: Unidade:
12806 EMBALE PT/20
F1 F4

UN: R\$ 2,00 AV: R\$ 39,93 15: R\$ 40,76
30: R\$ 41,57 45: R\$ 42,40 60: R\$ 43,25

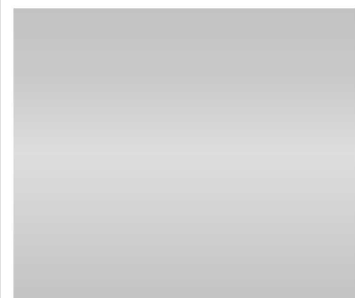

CARTOLINA LAMINADA 48X58CM PRATA 20X1

Código: Fábrika: Unidade:
7134 EMBALE PT/20
F1 F4

UN: R\$ 2,40 AV: R\$ 47,91 15: R\$ 48,91
30: R\$ 49,89 45: R\$ 50,89 60: R\$ 51,91



CARTOLINA LAMINADA 48X58CM VERDE 20X1

Código: Fábrika: Unidade:
12807 EMBALE PT/20
F1 F4

UN: R\$ 2,40 AV: R\$ 47,91 15: R\$ 48,91
30: R\$ 49,89 45: R\$ 50,89 60: R\$ 51,91



CARTOLINA LAMINADA 48X58CM VERMELHO 20X1

Código: Fábrika: Unidade:
12808 EMBALE PT/20
F1 F4

UN: R\$ 1,20 AV: R\$ 119,80 15: R\$ 122,29
30: R\$ 124,74 45: R\$ 127,23 60: R\$ 129,78

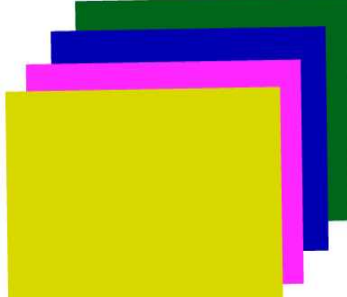

CARTOLINA SORTIDA 100X1

Código: Fábrika: Unidade:
29236 MINASPEL CE/100
F1 F4

UN: R\$ 1,10 AV: R\$ 109,81 15: R\$ 112,10
30: R\$ 114,34 45: R\$ 116,63 60: R\$ 118,96



CARTOLINA 47X65CM AMARELA 100X1

Código: Fábrika: Unidade:
13184 MINASPEL CE/100
F1 F4

UN: R\$ 1,10 AV: R\$ 109,81 15: R\$ 112,10
30: R\$ 114,34 45: R\$ 116,63 60: R\$ 118,96



CARTOLINA 47X65CM AZUL 100X1

Código: Fábrika: Unidade:
13186 MINASPEL CE/100
F1 F4

UN: R\$ 0,90 AV: R\$ 89,85 15: R\$ 91,72
30: R\$ 93,55 45: R\$ 95,42 60: R\$ 97,33



CARTOLINA 47X65CM BRANCA 100X1

Código: Fábrika: Unidade:
838 MINASPEL CE/100
F1 F4

UN: R\$ 1,10 AV: R\$ 109,81 15: R\$ 112,10
30: R\$ 114,34 45: R\$ 116,63 60: R\$ 118,96



CARTOLINA 47X65CM ROSA 100X1

Código: Fábrika: Unidade:
13185 MINASPEL CE/100
F1 F4

UN: R\$ 1,10 AV: R\$ 109,81 15: R\$ 112,10
30: R\$ 114,34 45: R\$ 116,63 60: R\$ 118,96



CARTOLINA 47X65CM VERDE 100X1

Código: Fábrika: Unidade:
13187 MINASPEL CE/100
F1 F4

UN: R\$ 62,89 AV: R\$ 62,89 15: R\$ 64,20
30: R\$ 65,48 45: R\$ 66,79 60: R\$ 68,13



CAVALETE P/TELA PINTURA NEO 071 CM 9922
Código: Fábrica: Unidade:
47878 STALO UN/1
F1 F4

UN: R\$ 1,60 AV: R\$ 79,86 15: R\$ 81,53
30: R\$ 83,16 45: R\$ 84,82 60: R\$ 86,52



CD-R GRAVAVEL 80 MIN 700 MB 50X1
Código: Fábrica: Unidade:
18272 MAKETECH PT/50
F1 F4

UN: R\$ 1,87 AV: R\$ 14,97 15: R\$ 15,28
30: R\$ 15,58 45: R\$ 15,90 60: R\$ 16,21



CHAVEIRO E ETIQUETA CORES C/SUORTE 8X1
Código: Fábrica: Unidade:
48056 MAXCRIL CR/8
F1 F4

UN: R\$ 1,37 AV: R\$ 164,74 15: R\$ 168,17
30: R\$ 171,53 45: R\$ 174,96 60: R\$ 178,46



CHAVEIRO E ETIQUETA CORES POTE 120X1
Código: Fábrica: Unidade:
40483 ACRINIL C//120
F1 F4

UN: R\$ 1,35 AV: R\$ 64,89 15: R\$ 66,24
30: R\$ 67,56 45: R\$ 68,91 60: R\$ 70,29



CHAVEIRO E ETIQUETA CORES POTE 48X1
Código: Fábrica: Unidade:
46742 KAZ C//48
F1 F4

UN: R\$ 1,76 AV: R\$ 105,88 15: R\$ 108,09
30: R\$ 110,25 45: R\$ 112,45 60: R\$ 114,70



CHAVEIRO E ETIQUETA CORES POTE 60X1
Código: Fábrica: Unidade:
40482 ACRIMET C//60
F1 F4

UN: R\$ 1,37 AV: R\$ 164,74 15: R\$ 168,17
30: R\$ 171,53 45: R\$ 174,96 60: R\$ 178,46



CHAVEIRO E ETIQUETA CRISTAL POTE 120X1
Código: Fábrica: Unidade:
46008 ACRINIL C//120
F1 F4

UN: R\$ 1,52 AV: R\$ 36,44 15: R\$ 37,20
30: R\$ 37,94 45: R\$ 38,70 60: R\$ 39,48



CHAVEIRO E ETIQUETA CRISTAL POTE 24X1
Código: Fábrica: Unidade:
46007 ACRINIL C//24
F1 F4

UN: R\$ 292,03 AV: R\$ 292,03 15: R\$ 298,12
30: R\$ 304,08 45: R\$ 310,16 60: R\$ 316,36



CLAVICULARIO UN
Código: Fábrica: Unidade:
43476 MENNO UN/1
F1 F4

UN: R\$ 12,26 AV: R\$ 12,26 15: R\$ 12,52
30: R\$ 12,77 45: R\$ 13,02 60: R\$ 13,28



CLIPS 0 METAL P/PAPEL 500 GRS
Código: Fábrica: Unidade:
11059 BRW CX/1
F1 F4

UN: R\$ 0,02 AV: R\$ 18,47 15: R\$ 18,86
30: R\$ 19,23 45: R\$ 19,62 60: R\$ 20,01



CLIPS 0 METAL P/PAPEL 770X1
Código: Fábrica: Unidade:
35869 LVC CX/770
F1 F4

UN: R\$ 0,02 AV: R\$ 19,55 15: R\$ 20,18
30: R\$ 20,78 45: R\$ 21,40 60: R\$ 22,05



CLIPS 1 P/PAPEL 500G
Código: Fábrica: Unidade:
24776 GASPER CX/940
F1 F4

UN: R\$ 0,03 AV: R\$ 2,99 15: R\$ 3,05
30: R\$ 3,11 45: R\$ 3,17 60: R\$ 3,23



CLIPS 1/0 METAL P/PAPEL 100X1
Código: Fábrica: Unidade:
41773 JUSSARA CX/100
F1 F4

UN: R\$ 0,03 AV: R\$ 2,99 15: R\$ 3,05
30: R\$ 3,11 45: R\$ 3,17 60: R\$ 3,23



CLIPS 1/0 METAL P/PAPEL 100X1
Código: Fábrica: Unidade:
42187 BACCHI CX/100
F1 F4

UN: R\$ 0,02 AV: R\$ 18,47 15: R\$ 18,86
30: R\$ 19,23 45: R\$ 19,62 60: R\$ 20,01



CLIPS 1/0 (0) METAL P/PAPEL 770X1
Código: Fábrica: Unidade:
44183 BACCHI CX/770
F1 F4

UN: R\$ 0,02 AV: R\$ 14,97 15: R\$ 15,28
30: R\$ 15,58 45: R\$ 15,90 60: R\$ 16,21



CLIPS 2 METAL ORGAN PENSAMENTOS 800X1
Código: Fábrica: Unidade:
22489 CHAPARRAU CX/800
F1 F4

UN: R\$ 0,03 AV: R\$ 2,99 15: R\$ 3,05
30: R\$ 3,11 45: R\$ 3,17 60: R\$ 3,23



CLIPS 2 METAL P/PAPEL 28MM 7553 100X1

Código: 48141 Fábrica: YIN'S PAPER Unidade: CX/100 F1 F4

UN: R\$ 0,03 AV: R\$ 18,47 15: R\$ 18,86
30: R\$ 19,23 45: R\$ 19,62 60: R\$ 20,01

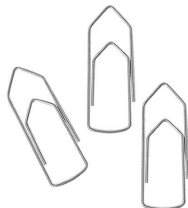

CLIPS 2/0 (0)METAL P/PAPEL APROX 720X1

Código: 27438 Fábrica: BRW Unidade: CX/720 F1 F4

UN: R\$ 0,03 AV: R\$ 18,47 15: R\$ 18,86
30: R\$ 19,23 45: R\$ 19,62 60: R\$ 20,01

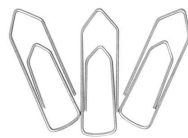

CLIPS 2/0 (00) METAL P/PAPEL 720X1

Código: 44182 Fábrica: BACCHI Unidade: CX/720 F1 F4

UN: R\$ 0,02 AV: R\$ 1,99 15: R\$ 2,03
30: R\$ 2,07 45: R\$ 2,11 60: R\$ 2,15



CLIPS 3 METAL P/PAPEL 25MM 7552 100X1

Código: 48140 Fábrica: YIN'S PAPER Unidade: CX/100 F1 F4

UN: R\$ 0,01 AV: R\$ 9,98 15: R\$ 10,19
30: R\$ 10,40 45: R\$ 10,60 60: R\$ 10,82



CLIPS 3 METAL P/PAPEL 500 GRS

Código: 26699 Fábrica: CHAPARRAU Unidade: CX/960 F1 F4

UN: R\$ 0,02 AV: R\$ 18,96 15: R\$ 19,35
30: R\$ 19,74 45: R\$ 20,14 60: R\$ 20,54

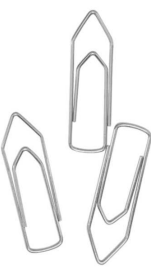

CLIPS 3 METAL P/PAPEL 960X1

Código: 41609 Fábrica: LVC Unidade: CX/960 F1 F4

UN: R\$ 0,06 AV: R\$ 3,21 15: R\$ 3,28
30: R\$ 3,35 45: R\$ 3,41 60: R\$ 3,48



CLIPS 3/0 METAL P/PAPEL 50X1

Código: 46895 Fábrica: JUSSARA Unidade: CX/50 F1 F4

UN: R\$ 0,03 AV: R\$ 14,97 15: R\$ 15,28
30: R\$ 15,58 45: R\$ 15,90 60: R\$ 16,21



CLIPS 3/0 METAL P/PAPEL 440X1

Código: 35866 Fábrica: LVC Unidade: CX/440 F1 F4

UN: R\$ 0,04 AV: R\$ 14,97 15: R\$ 15,28
30: R\$ 15,58 45: R\$ 15,90 60: R\$ 16,21



CLIPS 4/0 METAL P/PAPEL 400X1

Código: 35868 Fábrica: LVC Unidade: CX/400 F1 F4

UN: R\$ 0,06 AV: R\$ 2,99 15: R\$ 3,05
30: R\$ 3,11 45: R\$ 3,17 60: R\$ 3,23

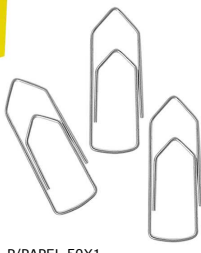

CLIPS 4/0 METAL P/PAPEL 50X1

Código: 43522 Fábrica: TOP Unidade: CX/50 F1 F4

UN: R\$ 0,11 AV: R\$ 5,48 15: R\$ 5,60
30: R\$ 5,71 45: R\$ 5,82 60: R\$ 5,94



CLIPS 6/0 METAL P/PAPEL 50X1

Código: 46898 Fábrica: JUSSARA Unidade: CX/50 F1 F4

UN: R\$ 0,08 AV: R\$ 17,76 15: R\$ 18,13
30: R\$ 18,49 45: R\$ 18,86 60: R\$ 19,24



CLIPS 6/0 METAL P/PAPEL 220X1

Código: 46897 Fábrica: JUSSARA Unidade: CX/220 F1 F4

UN: R\$ 0,07 AV: R\$ 3,48 15: R\$ 3,56
30: R\$ 3,63 45: R\$ 3,70 60: R\$ 3,77



CLIPS 6/0 METAL P/PAPEL 50X1

Código: 42587 Fábrica: BACCHI Unidade: CX/50 F1 F4

UN: R\$ 0,11 AV: R\$ 18,56 15: R\$ 18,95
30: R\$ 19,33 45: R\$ 19,71 60: R\$ 20,11



CLIPS 8/0 METAL P/PAPEL 170X1

Código: 46899 Fábrica: JUSSARA Unidade: CX/170 F1 F4

UN: R\$ 0,11 AV: R\$ 18,56 15: R\$ 18,95
30: R\$ 19,33 45: R\$ 19,71 60: R\$ 20,11

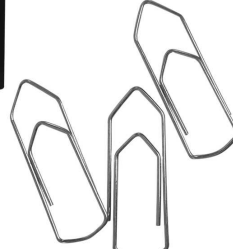

CLIPS 8/0 METAL P/PAPEL 170X1

Código: 35867 Fábrica: CHAPARRAU Unidade: CX/170 F1 F4

UN: R\$ 0,11 AV: R\$ 18,56 15: R\$ 18,95
30: R\$ 19,33 45: R\$ 19,71 60: R\$ 20,11



CLIPS 8/0 METAL P/PAPEL 170X1

Código: 42664 Fábrica: TOP/BACCHI Unidade: CX/170 F1 F4

UN: R\$ 0,13 AV: R\$ 3,18 15: R\$ 3,25
30: R\$ 3,32 45: R\$ 3,38 60: R\$ 3,45



CLIPS 8/0 METAL P/PAPEL 25X1
Código: 42743 Fábrica: BACCHI Unidade: CX/25 F1 F4

UN: R\$ 0,12 AV: R\$ 2,99 15: R\$ 3,05
30: R\$ 3,11 45: R\$ 3,17 60: R\$ 3,23



CLIPS 8/0 METAL P/PAPEL 25X1
Código: 34104 Fábrica: CHAPARRAU Unidade: CX/25 F1 F4

UN: R\$ 0,32 AV: R\$ 18,96 15: R\$ 19,35
30: R\$ 19,74 45: R\$ 20,14 60: R\$ 20,54



CLIPS BINDER 15MM PRETO 292200 60X1
Código: 46380 Fábrica: FUTURO Unidade: PT/60 F1 F4

UN: R\$ 0,37 AV: R\$ 14,97 15: R\$ 15,28
30: R\$ 15,58 45: R\$ 15,90 60: R\$ 16,21



CLIPS BINDER 19MM (PRENDADOR) COLOR 40X1
Código: 41931 Fábrica: TRIS Unidade: PT/40 F1 F4

UN: R\$ 0,52 AV: R\$ 24,95 15: R\$ 25,47
30: R\$ 25,98 45: R\$ 26,50 60: R\$ 27,03



CLIPS BINDER 25MM COLOR 48X1
Código: 41930 Fábrica: TRIS Unidade: PT/48 F1 F4

UN: R\$ 0,79 AV: R\$ 18,96 15: R\$ 19,35
30: R\$ 19,74 45: R\$ 20,14 60: R\$ 20,54



CLIPS BINDER 32MM PRETO 618913 24X1
Código: 49940 Fábrica: BAZZE Unidade: PT/24 F1 F4

UN: R\$ 1,28 AV: R\$ 30,70 15: R\$ 31,34
30: R\$ 31,97 45: R\$ 32,61 60: R\$ 33,26



CLIPS BINDER 41MM PRETO 292204 24X1
Código: 46379 Fábrica: FUTURO Unidade: PT/24 F1 F4

UN: R\$ 2,08 AV: R\$ 24,95 15: R\$ 25,47
30: R\$ 25,98 45: R\$ 26,50 60: R\$ 27,03



CLIPS BINDER 51MM PRETO 93092 12X1
Código: 42727 Fábrica: JOCAROFFICE Unidade: PT/12 F1 F4

UN: R\$ 0,16 AV: R\$ 4,78 15: R\$ 4,88
30: R\$ 4,98 45: R\$ 5,08 60: R\$ 5,18

2,5 cm



CLIPS MINI PRENDADOR MAD 2,5CM COLOR30X1
Código: 44510 Fábrica: ALIANCA Unidade: PT/30 F1 F4

UN: R\$ 0,04 AV: R\$ 4,29 15: R\$ 4,38
30: R\$ 4,47 45: R\$ 4,56 60: R\$ 4,65



CLIPS MINI 5 GALVANIZADO P/PAPEL 100X1
Código: 46070 Fábrica: BACCHI Unidade: CX/100 F1 F4

UN: R\$ 0,03 AV: R\$ 3,09 15: R\$ 3,15
30: R\$ 3,21 45: R\$ 3,28 60: R\$ 3,34



CLIPS P/PAPEL COLOR 28MM 80207 100X1
Código: 44541 Fábrica: WIN PAPER Unidade: CX/100 F1 F4

UN: R\$ 0,03 AV: R\$ 2,99 15: R\$ 3,05
30: R\$ 3,11 45: R\$ 3,17 60: R\$ 3,23



CLIPS P/PAPEL NIQUEL 5 MINI 80193 100X1
Código: 44743 Fábrica: WIN PAPER Unidade: CX/100 F1 F4

UN: R\$ 1,05 AV: R\$ 104,82 15: R\$ 107,01
30: R\$ 109,15 45: R\$ 111,33 60: R\$ 113,56



CLIPS REMOVIVEL JACARE C/ALCA 100X1
Código: 9732 Fábrica: DAC Unidade: CE/100 F1 F4

UN: R\$ 0,30 AV: R\$ 5,48 15: R\$ 5,60
30: R\$ 5,71 45: R\$ 5,82 60: R\$ 5,94



CLIPS 10/0 METAL P/PAPEL 18X1
Código: 44186 Fábrica: BACCHI Unidade: CX/18 F1 F4

UN: R\$ 0,27 AV: R\$ 27,95 15: R\$ 28,53
30: R\$ 29,10 45: R\$ 29,68 60: R\$ 30,27



CLIPS 12/0 METAL P/PAPEL 105X1
Código: 44188 Fábrica: BACCHI Unidade: CX/105 F1 F4

UN: R\$ 0,39 AV: R\$ 4,68 15: R\$ 4,78
30: R\$ 4,88 45: R\$ 4,97 60: R\$ 5,07



CLIPS 12/0 METAL P/PAPEL 12X1
Código: 44187 Fábrica: BACCHI Unidade: CX/12 F1 F4

UN: R\$ 6,65 AV: R\$ 39,93 15: R\$ 40,76
30: R\$ 41,57 45: R\$ 42,40 60: R\$ 43,25



COLA ISOPOR & EVA 90 GRS COLA MAIS 6X1
Código: Fábrica: Unidade:
42574 COLA MAIS PT/6
F1 F4

UN: R\$ 1,79 AV: R\$ 10,73 15: R\$ 10,96
30: R\$ 11,18 45: R\$ 11,40 60: R\$ 11,63



COLA 25 GRS 6 CORES C/GLITTER SORT
Código: Fábrica: Unidade:
46433 KAZ CX/6
F1 F4

UN: R\$ 10,97 AV: R\$ 10,97 15: R\$ 11,20
30: R\$ 11,43 45: R\$ 11,65 60: R\$ 11,89



COLA ADESIVO INSTANTANEO 20 GRS UN
Código: Fábrica: Unidade:
42934 GLIART UN/1
F1 F4

UN: R\$ 4,56 AV: R\$ 4,56 15: R\$ 4,66
30: R\$ 4,75 45: R\$ 4,85 60: R\$ 4,94



COLA ADESIVO PVC P/CANO 17 GRS UN
Código: Fábrica: Unidade:
50754 TEK BOND UN/1
F1 F4

UN: R\$ 58,21 AV: R\$ 58,21 15: R\$ 59,42
30: R\$ 60,61 45: R\$ 61,82 60: R\$ 63,06



COLA ADESIVO SPRAY CONTATO 500ML
Código: Fábrica: Unidade:
50979 TEK BOND UN/1
F1 F4

UN: R\$ 4,48 AV: R\$ 4,48 15: R\$ 4,58
30: R\$ 4,67 45: R\$ 4,76 60: R\$ 4,86



COLA BASTAO 10 GRS
Código: Fábrica: Unidade:
15350 ACRILEX UN/1
F1 F4

UN: R\$ 3,58 AV: R\$ 35,82 15: R\$ 36,57
30: R\$ 37,30 45: R\$ 38,05 60: R\$ 38,81



COLA BASTAO 10 GRS 02710 10X1
Código: Fábrica: Unidade:
41326 ACRILEX PT/10
F1 F4

UN: R\$ 1,08 AV: R\$ 12,97 15: R\$ 13,24
30: R\$ 13,50 45: R\$ 13,77 60: R\$ 14,05



COLA BASTAO 10 GRS 10101 12X1
Código: Fábrica: Unidade:
41327 GATTE KIDS DZ/12
F1 F4

UN: R\$ 1,19 AV: R\$ 14,28 15: R\$ 14,57
30: R\$ 14,87 45: R\$ 15,16 60: R\$ 15,47



COLA BASTAO 10 GRS 12X1
Código: Fábrica: Unidade:
50031 BAZZE CX/12
F1 F4

UN: R\$ 1,91 AV: R\$ 22,91 15: R\$ 23,39
30: R\$ 23,86 45: R\$ 24,34 60: R\$ 24,82



COLA BASTAO 20 GRS 12X1
Código: Fábrica: Unidade:
50032 BAZZE CX/12
F1 F4

UN: R\$ 2,65 AV: R\$ 31,77 15: R\$ 32,43
30: R\$ 33,08 45: R\$ 33,74 60: R\$ 34,42



COLA BASTAO 20 GRS 12X1
Código: Fábrica: Unidade:
50759 MARIPEL CX/12
F1 F4

UN: R\$ 2,89 AV: R\$ 17,33 15: R\$ 17,69
30: R\$ 18,05 45: R\$ 18,41 60: R\$ 18,78



COLA BASTAO 40 GRS 6X1
Código: Fábrica: Unidade:
50207 BAZZE CX/6
F1 F4

UN: R\$ 3,48 AV: R\$ 3,48 15: R\$ 3,56
30: R\$ 3,63 45: R\$ 3,70 60: R\$ 3,77



COLA BRANCA 40 GRS UN
Código: Fábrica: Unidade:
51069 TEK BOND UN/1
F1 F4

UN: R\$ 0,85 AV: R\$ 71,27 15: R\$ 73,54
30: R\$ 75,75 45: R\$ 78,02 60: R\$ 80,36



COLA BRANCA 40 GRS 84X1
Código: Fábrica: Unidade:
30509 COPLAMIX CX/84
F1 F4

UN: R\$ 15,72 AV: R\$ 15,72 15: R\$ 16,05
30: R\$ 16,37 45: R\$ 16,70 60: R\$ 17,03



COLA BRANCA 1 KG
Código: Fábrica: Unidade:
42575 FIRST UN/1
F1 F4

UN: R\$ 49,91 AV: R\$ 49,91 15: R\$ 50,95
30: R\$ 51,97 45: R\$ 53,01 60: R\$ 54,07



COLA BRANCA 1 KG EXTRA USO PROFISSIONAL
Código: Fábrica: Unidade:
1181 APLICOLA UN/1
F1 F4

UN: R\$ 15,72 AV: R\$ 15,72 15: R\$ 16,05
30: R\$ 16,37 45: R\$ 16,70 60: R\$ 17,03



COLA BRANCA 1 KG NEW MAGIC
Código: Fábrica: Unidade:
19689 NEW MAGIC UN/1
F1 F4

UN: R\$ 6,98 AV: R\$ 6,98 15: R\$ 7,12
30: R\$ 7,27 45: R\$ 7,41 60: R\$ 7,56



COLA BRANCA 100 GRS ACRILEX UN
Código: Fábrica: Unidade:
40900 ACRILEX UN/1
F1 F4

UN: R\$ 3,33 AV: R\$ 19,96 15: R\$ 20,37
30: R\$ 20,78 45: R\$ 21,20 60: R\$ 21,62



COLA BRANCA 110 GRS COLA MAIS 6X1
Código: Fábrica: Unidade:
45152 COLA MAIS PT/6
F1 F4

UN: R\$ 2,89 AV: R\$ 2,89 15: R\$ 2,95
30: R\$ 3,00 45: R\$ 3,06 60: R\$ 3,13



COLA BRANCA 110 GRS COLA UN
Código: Fábrica: Unidade:
46511 COLA MAIS UN/1
F1 F4

UN: R\$ 1,75 AV: R\$ 1,75 15: R\$ 1,78
30: R\$ 1,82 45: R\$ 1,86 60: R\$ 1,89



COLA BRANCA 37 GRS UN
Código: Fábrica: Unidade:
42019 ACRILEX UN/1
F1 F4

UN: R\$ 1,67 AV: R\$ 1,67 15: R\$ 1,70
30: R\$ 1,74 45: R\$ 1,77 60: R\$ 1,81



COLA BRANCA 40 GRS COLEX UN
Código: Fábrica: Unidade:
46797 INJEX PEN UN/1
F1 F4

UN: R\$ 1,90 AV: R\$ 136,78 15: R\$ 139,63
30: R\$ 142,42 45: R\$ 145,27 60: R\$ 148,18



COLA BRANCA 40 GRS NEW MAGIC 72X1
Código: Fábrica: Unidade:
30112 NEW MAGIC CX/72
F1 F4

UN: R\$ 1,67 AV: R\$ 1,67 15: R\$ 1,70
30: R\$ 1,74 45: R\$ 1,77 60: R\$ 1,81



COLA BRANCA 40 GRS UN
Código: Fábrica: Unidade:
42783 NEW MAGIC UN/1
F1 F4

UN: R\$ 1,66 AV: R\$ 19,96 15: R\$ 20,37
30: R\$ 20,78 45: R\$ 21,20 60: R\$ 21,62



COLA BRANCA 40 GRS 12X1
Código: Fábrica: Unidade:
44031 PALHACINHO DZ/12
F1 F4

UN: R\$ 10,97 AV: R\$ 10,97 15: R\$ 11,20
30: R\$ 11,43 45: R\$ 11,65 60: R\$ 11,89



COLA BRANCA 500 GRS
Código: Fábrica: Unidade:
3347 COPLAMIX UN/1
F1 F4

UN: R\$ 11,93 AV: R\$ 11,93 15: R\$ 12,18
30: R\$ 12,42 45: R\$ 12,67 60: R\$ 12,92



COLA BRANCA 500 GRS
Código: Fábrica: Unidade:
42576 COLA MAIS UN/1
F1 F4

UN: R\$ 2,99 AV: R\$ 2,99 15: R\$ 3,05
30: R\$ 3,11 45: R\$ 3,17 60: R\$ 3,23



COLA BRANCA 90 GRS NEW MAGIC UN
Código: Fábrica: Unidade:
50642 NEW MAGIC UN/1
F1 F4

UN: R\$ 3,12 AV: R\$ 149,75 15: R\$ 152,87
30: R\$ 155,93 45: R\$ 159,05 60: R\$ 162,23



COLA BRANCA 90 GRS NEW MAGIC 48X1
Código: Fábrica: Unidade:
35872 NEW MAGIC CX/48
F1 F4

UN: R\$ 3,16 AV: R\$ 18,96 15: R\$ 19,35
30: R\$ 19,74 45: R\$ 20,14 60: R\$ 20,54



COLA BRANCA 90 GRS NEW MAGIC 6X1
Código: Fábrica: Unidade:
27904 NEW MAGIC CX/6
F1 F4

UN: R\$ 6,98 AV: R\$ 6,98 15: R\$ 7,12
30: R\$ 7,27 45: R\$ 7,41 60: R\$ 7,56



COLA BRANCA 90 GRS UN
Código: Fábrica: Unidade:
51070 TEK BOND UN/1
F1 F4

UN: R\$ 2,79 AV: R\$ 33,43 15: R\$ 34,12
30: R\$ 34,81 45: R\$ 35,50 60: R\$ 36,21



COLA BRANCA 90 GRS 12X1
Código: Fábrica: Unidade:
19086 PALHACINHO PT/12
F1 F4

UN: R\$ 2,83 AV: R\$ 16,96 15: R\$ 17,32
30: R\$ 17,66 45: R\$ 18,02 60: R\$ 18,38



COLA BRANCA 90 GRS 6X1
Código: Fábrika: Unidade:
39834 COLA MAIS/IR PT/6
F1 F4

UN: R\$ 2,99 AV: R\$ 11,97 15: R\$ 12,22
30: R\$ 12,46 45: R\$ 12,71 60: R\$ 12,97



COLA BRILHANTE VERD C/GLITTER 25 GRS 4X1
Código: Fábrika: Unidade:
5826 APLICOLA CX/4
F1 F4

UN: R\$ 3,16 AV: R\$ 18,96 15: R\$ 19,35
30: R\$ 19,74 45: R\$ 20,14 60: R\$ 20,54



COLA BRILHANTE 6 COR SORT C/GLIT 25 GRS
Código: Fábrika: Unidade:
3352 APLICOLA CX/6
F1 F4

UN: R\$ 1,91 AV: R\$ 11,45 15: R\$ 11,69
30: R\$ 11,92 45: R\$ 12,16 60: R\$ 12,41



COLA C/GLITTER 25 GRS 6 CORES SORT
Código: Fábrika: Unidade:
46256 COLA MAIS CX/6
F1 F4

UN: R\$ 2,24 AV: R\$ 8,98 15: R\$ 9,16
30: R\$ 9,35 45: R\$ 9,53 60: R\$ 9,72



COLA COLORIDA 23 GRS 4 CORES SORT
Código: Fábrika: Unidade:
45280 ACRILEX CX/4
F1 F4

UN: R\$ 2,16 AV: R\$ 12,97 15: R\$ 13,24
30: R\$ 13,50 45: R\$ 13,77 60: R\$ 14,05



COLA COLORIDA 23 GRS 6 CORES SORT
Código: Fábrika: Unidade:
19855 ACRILEX CX/6
F1 F4

UN: R\$ 5,48 AV: R\$ 5,48 15: R\$ 5,60
30: R\$ 5,71 45: R\$ 5,82 60: R\$ 5,94



COLA EVA E ISOPOR 35 GRS UN
Código: Fábrika: Unidade:
48424 ACRILEX UN/1
F1 F4

UN: R\$ 16,96 AV: R\$ 16,96 15: R\$ 17,32
30: R\$ 17,66 45: R\$ 18,02 60: R\$ 18,38



COLA GEL 120 ML DECOUPAGE MULTICOL 18112
Código: Fábrika: Unidade:
44819 ACRILEX UN/1
F1 F4

UN: R\$ 11,67 AV: R\$ 11,67 15: R\$ 11,91
30: R\$ 12,15 45: R\$ 12,40 60: R\$ 12,64



COLA GEL 60 GRS DECOUPAGE MULTICOLAG 1816
Código: Fábrika: Unidade:
43612 ACRILEX UN/1
F1 F4

UN: R\$ 7,46 AV: R\$ 89,58 15: R\$ 91,44
30: R\$ 93,27 45: R\$ 95,14 60: R\$ 97,04



COLA INSTAN 20 GRS ALTA VISCOSIDAD 12X1
Código: Fábrika: Unidade:
47928 YIN'S PAPER CX/12
F1 F4

UN: R\$ 11,88 AV: R\$ 118,81 15: R\$ 121,28
30: R\$ 123,71 45: R\$ 126,18 60: R\$ 128,71



COLA INSTAN 20 GRS ARTESANATO N1 10X1
Código: Fábrika: Unidade:
48639 TEK BOND CX/10
F1 F4

UN: R\$ 11,88 AV: R\$ 118,81 15: R\$ 121,28
30: R\$ 123,71 45: R\$ 126,18 60: R\$ 128,71



COLA INSTAN 20 GRS ARTESANATO N2 10X1
Código: Fábrika: Unidade:
48640 TEK BOND CX/10
F1 F4

UN: R\$ 11,88 AV: R\$ 118,81 15: R\$ 121,28
30: R\$ 123,71 45: R\$ 126,18 60: R\$ 128,71



COLA INSTAN 20 GRS ARTESANATO N3 10X1
Código: Fábrika: Unidade:
48641 TEK BOND CX/10
F1 F4

UN: R\$ 3,83 AV: R\$ 22,95 15: R\$ 23,43
30: R\$ 23,90 45: R\$ 24,38 60: R\$ 24,87



COLA ISOPOR & EVA 35 GRS COLA MAIS 6X1
Código: Fábrika: Unidade:
39833 COLA MAIS PT/6
F1 F4

UN: R\$ 11,40 AV: R\$ 11,40 15: R\$ 11,64
30: R\$ 11,87 45: R\$ 12,11 60: R\$ 12,35



COLA MADEIRA 100 GRS UN
Código: Fábrika: Unidade:
50720 TEK BOND UN/1
F1 F4

UN: R\$ 6,98 AV: R\$ 6,98 15: R\$ 7,12
30: R\$ 7,27 45: R\$ 7,41 60: R\$ 7,56



COLA PANO 35 GRS 16812 UN
Código: Fábrika: Unidade:
44822 ACRILEX UN/1
F1 F4

UN: R\$ 6,98 AV: R\$ 6,98 15: R\$ 7,12
30: R\$ 7,27 45: R\$ 7,41 60: R\$ 7,56



COLA PANO 37 GRS 16840 UN
Código: Fábrica: Unidade:
45497 ACRILEX UN/1
F1 F4

UN: R\$ 14,97 AV: R\$ 14,97 15: R\$ 15,28
30: R\$ 15,58 45: R\$ 15,90 60: R\$ 16,21



COLA PANO 100 GRS (TECIDO) UN
Código: Fábrica: Unidade:
45402 ACRILEX UN/1
F1 F4

UN: R\$ 44,92 AV: R\$ 44,92 15: R\$ 45,85
30: R\$ 46,77 45: R\$ 47,71 60: R\$ 48,66



COLA PERMANENTE 250 GRS UN
Código: Fábrica: Unidade:
50266 ACRILEX UN/1
F1 F4

UN: R\$ 6,68 AV: R\$ 6,68 15: R\$ 6,82
30: R\$ 6,95 45: R\$ 7,09 60: R\$ 7,24



COLA PERMANENTE 37 GRS UN
Código: Fábrica: Unidade:
42950 ACRILEX UN/1
F1 F4

UN: R\$ 5,15 AV: R\$ 5,15 15: R\$ 5,26
30: R\$ 5,36 45: R\$ 5,47 60: R\$ 5,58



COLA PERMANENTE 37 GRS UN
Código: Fábrica: Unidade:
50733 TEK BOND UN/1
F1 F4

UN: R\$ 0,53 AV: R\$ 4,24 15: R\$ 4,33
30: R\$ 4,42 45: R\$ 4,51 60: R\$ 4,60



COLA QUENTE FINA REFIL 175 8X1
Código: Fábrica: Unidade:
30471 FUTURO PT/8
F1 F4

UN: R\$ 1,32 AV: R\$ 6,58 15: R\$ 6,72
30: R\$ 6,85 45: R\$ 6,99 60: R\$ 7,13



COLA QUENTE GROSSA REFIL 176 5X1
Código: Fábrica: Unidade:
50225 FUTURO PT/5
F1 F4

UN: R\$ 61,20 AV: R\$ 61,20 15: R\$ 62,48
30: R\$ 63,73 45: R\$ 65,00 60: R\$ 66,30



COLA QUENTE 1 KG FINA REFIL APROX 77X1
Código: Fábrica: Unidade:
5953 PLANETA KG/1
F1 F4

UN: R\$ 49,99 AV: R\$ 49,99 15: R\$ 49,99
30: R\$ 49,99 45: R\$ 49,99 60: R\$ 49,99



COLA QUENTE 1 KG FINA REFIL 84X1
Código: Fábrica: Unidade:
50027 BAZZE KG/1
F1 F4

UN: R\$ 49,99 AV: R\$ 49,99 15: R\$ 49,99
30: R\$ 49,99 45: R\$ 49,99 60: R\$ 49,99



COLA QUENTE 1 KG GROSSA REFIL APROX 32X1
Código: Fábrica: Unidade:
3016 IB/REN/FU/PL KG/1
F1 F4

UN: R\$ 59,89 AV: R\$ 59,89 15: R\$ 61,14
30: R\$ 62,36 45: R\$ 63,61 60: R\$ 64,88



COLA QUENTE 1 KG GROSSA REFIL APROX 32X1
Código: Fábrica: Unidade:
46425 KAZ KG/1
F1 F4

UN: R\$ 8,98 AV: R\$ 8,98 15: R\$ 9,16
30: R\$ 9,35 45: R\$ 9,53 60: R\$ 9,72



COLA SILICONE LIQUIDA 100ML UN
Código: Fábrica: Unidade:
31876 LEO&LEO UN/1
F1 F4

UN: R\$ 5,83 AV: R\$ 5,83 15: R\$ 5,95
30: R\$ 6,07 45: R\$ 6,19 60: R\$ 6,32



COLA SILICONE LIQUIDA 54 GRS UN
Código: Fábrica: Unidade:
48950 LEO&LEO UN/1
F1 F4

UN: R\$ 4,90 AV: R\$ 29,40 15: R\$ 30,02
30: R\$ 30,62 45: R\$ 31,23 60: R\$ 31,85



COLA SILICONE LIQUIDA 54 GRS 60ML 6X1
Código: Fábrica: Unidade:
50029 BAZZE CX/6
F1 F4

UN: R\$ 5,99 AV: R\$ 71,88 15: R\$ 73,38
30: R\$ 74,85 45: R\$ 76,35 60: R\$ 77,87



COLA SILICONE LIQUIDA 60 GRS 0060 12X1
Código: Fábrica: Unidade:
33685 BRW CX/12
F1 F4

UN: R\$ 7,32 AV: R\$ 87,85 15: R\$ 89,68
30: R\$ 91,47 45: R\$ 93,30 60: R\$ 95,17



COLA SILICONE LIQUIDA 90 GRS 100ML 12X1
Código: Fábrica: Unidade:
41705 LEO&LEO CX/12
F1 F4

UN: R\$ 7,35 AV: R\$ 44,10 15: R\$ 45,02
30: R\$ 45,92 45: R\$ 46,84 60: R\$ 47,77



COLA SILICONE LÍQUIDA 90 GRS 100ML 6X1
Código: Fábrika: Unidade:
50030 BAZZE CX/6
F1 F4

UN: R\$ 1,04 AV: R\$ 12,48 15: R\$ 12,74
30: R\$ 12,99 45: R\$ 13,25 60: R\$ 13,52



COLA SUPER COLA TP SUP BOND 3 GRS 12X1
Código: Fábrika: Unidade:
21631 WINMAX/HAI CR/12
F1 F4

UN: R\$ 3,31 AV: R\$ 3,31 15: R\$ 3,38
30: R\$ 3,45 45: R\$ 3,52 60: R\$ 3,59



COLA TEK BOND INSTAN 2 GRS BLISTER UN
Código: Fábrika: Unidade:
51068 TEK BOND CR/1
F1 F4

UN: R\$ 20,07 AV: R\$ 20,07 15: R\$ 20,49
30: R\$ 20,90 45: R\$ 21,31 60: R\$ 21,74



COLA TRANSP ECOLOGICA 1 KG APLICOLA
Código: Fábrika: Unidade:
45578 APLICOLA UN/1
F1 F4

UN: R\$ 1,73 AV: R\$ 124,80 15: R\$ 127,40
30: R\$ 129,95 45: R\$ 132,55 60: R\$ 135,20



COLA TRANSP ECOLOGICA 40 GRS APLIC 72X1
Código: Fábrika: Unidade:
30111 APLICOLA CX/72
F1 F4

UN: R\$ 2,89 AV: R\$ 138,77 15: R\$ 141,66
30: R\$ 144,49 45: R\$ 147,38 60: R\$ 150,33



COLA TRANSP 90 GRS ECOLOGICA APLIC 48X1
Código: Fábrika: Unidade:
36330 APLICOLA CX/48
F1 F4

UN: R\$ 2,75 AV: R\$ 2,75 15: R\$ 2,80
30: R\$ 2,86 45: R\$ 2,92 60: R\$ 2,97



COLA TRANSPARENTE 37 GRS 19937
Código: Fábrika: Unidade:
21340 ACRILEX UN/1
F1 F4

UN: R\$ 5,95 AV: R\$ 5,95 15: R\$ 6,07
30: R\$ 6,20 45: R\$ 6,32 60: R\$ 6,45



COLA 35 GRS C/GLITTER 102 AMARELO LIMAO
Código: Fábrika: Unidade:
47787 ACRILEX UN/1
F1 F4

UN: R\$ 5,95 AV: R\$ 5,95 15: R\$ 6,07
30: R\$ 6,20 45: R\$ 6,32 60: R\$ 6,45



COLA 35 GRS C/GLITTER 105 LARANJA
Código: Fábrika: Unidade:
47788 ACRILEX UN/1
F1 F4

UN: R\$ 5,95 AV: R\$ 5,95 15: R\$ 6,07
30: R\$ 6,20 45: R\$ 6,32 60: R\$ 6,45



COLA 35 GRS C/GLITTER 201 AMARELO OURO
Código: Fábrika: Unidade:
47789 ACRILEX UN/1
F1 F4

UN: R\$ 5,95 AV: R\$ 5,95 15: R\$ 6,07
30: R\$ 6,20 45: R\$ 6,32 60: R\$ 6,45



COLA 35 GRS C/GLITTER 202 PRATA
Código: Fábrika: Unidade:
47790 ACRILEX UN/1
F1 F4

UN: R\$ 5,95 AV: R\$ 5,95 15: R\$ 6,07
30: R\$ 6,20 45: R\$ 6,32 60: R\$ 6,45



COLA 35 GRS C/GLITTER 204 AZUL
Código: Fábrika: Unidade:
47791 ACRILEX UN/1
F1 F4

UN: R\$ 5,95 AV: R\$ 5,95 15: R\$ 6,07
30: R\$ 6,20 45: R\$ 6,32 60: R\$ 6,45



COLA 35 GRS C/GLITTER 205 VERMELHO
Código: Fábrika: Unidade:
47792 ACRILEX UN/1
F1 F4

UN: R\$ 5,95 AV: R\$ 5,95 15: R\$ 6,07
30: R\$ 6,20 45: R\$ 6,32 60: R\$ 6,45



COLA 35 GRS C/GLITTER 206 VERDE BANDEIRA
Código: Fábrika: Unidade:
47793 ACRILEX UN/1
F1 F4

UN: R\$ 5,95 AV: R\$ 5,95 15: R\$ 6,07
30: R\$ 6,20 45: R\$ 6,32 60: R\$ 6,45



COLA 35 GRS C/GLITTER 207 VIOLETA
Código: Fábrika: Unidade:
47794 ACRILEX UN/1
F1 F4

UN: R\$ 5,95 AV: R\$ 5,95 15: R\$ 6,07
30: R\$ 6,20 45: R\$ 6,32 60: R\$ 6,45



COLA 35 GRS C/GLITTER 209 CRISTAL
Código: Fábrika: Unidade:
47795 ACRILEX UN/1
F1 F4

UN: R\$ 5,95 AV: R\$ 5,95 15: R\$ 6,07
30: R\$ 6,20 45: R\$ 6,32 60: R\$ 6,45



COLA 35 GRS C/GLITER 221 CEU ESTRELADO
Código: Fábrika: Unidade:
47796 ACRILEX UN/1
F1 F4

UN: R\$ 5,95 AV: R\$ 5,95 15: R\$ 6,07
30: R\$ 6,20 45: R\$ 6,32 60: R\$ 6,45



COLA 35 GRS C/GLITER 527 PINK
Código: Fábrika: Unidade:
47797 ACRILEX UN/1
F1 F4

UN: R\$ 5,95 AV: R\$ 5,95 15: R\$ 6,07
30: R\$ 6,20 45: R\$ 6,32 60: R\$ 6,45



COLA 35 GRS C/GLITER 528 LILAS
Código: Fábrika: Unidade:
47798 ACRILEX UN/1
F1 F4

UN: R\$ 0,07 AV: R\$ 5,18 15: R\$ 5,29
30: R\$ 5,40 45: R\$ 5,50 60: R\$ 5,61



COLCHETE LATONADO N02 1,6CM 40FLS 72X1
Código: Fábrika: Unidade:
47228 FIX PAPER CX/72
F1 F4

UN: R\$ 0,07 AV: R\$ 5,28 15: R\$ 5,39
30: R\$ 5,50 45: R\$ 5,61 60: R\$ 5,72



COLCHETE LATONADO N03 1,7CM 60FLS 72X1
Código: Fábrika: Unidade:
47229 FIX PAPER CX/72
F1 F4

UN: R\$ 0,07 AV: R\$ 5,38 15: R\$ 5,49
30: R\$ 5,60 45: R\$ 5,72 60: R\$ 5,83



COLCHETE LATONADO N04 2,2CM 80FLS 72X1
Código: Fábrika: Unidade:
47230 FIX PAPER CX/72
F1 F4

UN: R\$ 0,08 AV: R\$ 5,99 15: R\$ 6,11
30: R\$ 6,24 45: R\$ 6,36 60: R\$ 6,49



COLCHETE LATONADO N05 2,6CM 110FLS 72X1
Código: Fábrika: Unidade:
47231 FIX PAPER CX/72
F1 F4

UN: R\$ 0,10 AV: R\$ 6,88 15: R\$ 7,02
30: R\$ 7,16 45: R\$ 7,31 60: R\$ 7,45



COLCHETE LATONADO N06 2,8CM 120FLS 72X1
Código: Fábrika: Unidade:
47232 FIX PAPER CX/72
F1 F4

UN: R\$ 0,10 AV: R\$ 6,98 15: R\$ 7,12
30: R\$ 7,27 45: R\$ 7,41 60: R\$ 7,56

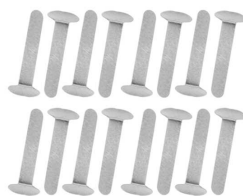

COLCHETE LATONADO N07 3,2CM 140FLS 72X1
Código: Fábrika: Unidade:
47233 FIX PAPER CX/72
F1 F4

UN: R\$ 0,12 AV: R\$ 8,88 15: R\$ 9,06
30: R\$ 9,24 45: R\$ 9,43 60: R\$ 9,62

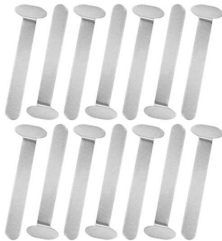

COLCHETE LATONADO N08 4CM 180FLS 72X1
Código: Fábrika: Unidade:
47234 FIX PAPER CX/72
F1 F4

UN: R\$ 0,14 AV: R\$ 9,97 15: R\$ 10,18
30: R\$ 10,39 45: R\$ 10,59 60: R\$ 10,81



COLCHETE LATONADO N09 4,5CM 200FLS 72X1
Código: Fábrika: Unidade:
47235 FIX PAPER CX/72
F1 F4

UN: R\$ 0,15 AV: R\$ 10,47 15: R\$ 10,69
30: R\$ 10,91 45: R\$ 11,12 60: R\$ 11,35

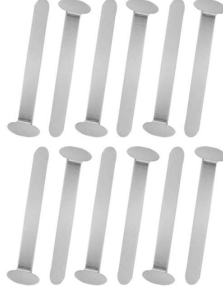

COLCHETE LATONADO N10 5CM 210FLS 72X1
Código: Fábrika: Unidade:
47236 FIX PAPER CX/72
F1 F4

UN: R\$ 0,18 AV: R\$ 12,97 15: R\$ 13,24
30: R\$ 13,50 45: R\$ 13,77 60: R\$ 14,05



COLCHETE LATONADO N11 5,5CM 240FLS 72X1
Código: Fábrika: Unidade:
47237 FIX PAPER CX/72
F1 F4

UN: R\$ 0,18 AV: R\$ 12,97 15: R\$ 13,24
30: R\$ 13,50 45: R\$ 13,77 60: R\$ 14,05



COLCHETE LATONADO N12 6CM 270FLS 72X1
Código: Fábrika: Unidade:
47239 FIX PAPER CX/72
F1 F4

UN: R\$ 0,22 AV: R\$ 15,96 15: R\$ 16,30
30: R\$ 16,62 45: R\$ 16,96 60: R\$ 17,29



COLCHETE LATONADO N13 7,5CM 360FLS 72X1
Código: Fábrika: Unidade:
47240 FIX PAPER CX/72
F1 F4

UN: R\$ 0,22 AV: R\$ 15,67 15: R\$ 16,00
30: R\$ 16,32 45: R\$ 16,65 60: R\$ 16,98



COLCHETE LATONADO N14 8,2CM 400FLS 72X1
Código: Fábrika: Unidade:
47241 FIX PAPER CX/72
F1 F4

UN: R\$ 0,28 AV: R\$ 19,96 15: R\$ 20,37
30: R\$ 20,78 45: R\$ 21,20 60: R\$ 21,62



COLCHETE LATONADO N15 10CM 450FLS 72X1
Código: 43718 Fábrica: FIX PAPER Unidade: CX/72 F1 F4

UN: R\$ 0,29 AV: R\$ 20,96 15: R\$ 21,39
30: R\$ 21,82 45: R\$ 22,26 60: R\$ 22,70



COLCHETE LATONADO N17 11CM 455FLS 72X1
Código: 47242 Fábrica: FIX PAPER Unidade: CX/72 F1 F4

UN: R\$ 0,14 AV: R\$ 9,97 15: R\$ 10,18
30: R\$ 10,39 45: R\$ 10,59 60: R\$ 10,81



COLCHETE METAL N07 3,2CM 140 FLS 72X1
Código: 43513 Fábrica: BACCHI Unidade: CX/72 F1 F4

UN: R\$ 0,17 AV: R\$ 11,97 15: R\$ 12,22
30: R\$ 12,46 45: R\$ 12,71 60: R\$ 12,97



COLCHETE METAL N09 4,5CM 200 FLS 72X1
Código: 43515 Fábrica: BACCHI Unidade: CX/72 F1 F4

UN: R\$ 0,25 AV: R\$ 17,96 15: R\$ 18,34
30: R\$ 18,70 45: R\$ 19,08 60: R\$ 19,46



COLCHETE METAL N11 5,5CM 240 FLS 72X1
Código: 43514 Fábrica: BACCHI Unidade: CX/72 F1 F4

UN: R\$ 0,30 AV: R\$ 21,95 15: R\$ 22,41
30: R\$ 22,86 45: R\$ 23,32 60: R\$ 23,78



COLCHETE METAL N13 7,5CM 360 FLS 72X1
Código: 43516 Fábrica: BACCHI Unidade: CX/72 F1 F4

UN: R\$ 8,32 AV: R\$ 99,83 15: R\$ 101,91
30: R\$ 103,95 45: R\$ 106,03 60: R\$ 108,15



COMPASSO JOLLY 12X1
Código: 6889 Fábrica: COMPACTOR Unidade: CX/12 F1 F4

UN: R\$ 11,97 AV: R\$ 11,97 15: R\$ 12,22
30: R\$ 12,46 45: R\$ 12,71 60: R\$ 12,97



COMPASSO METAL C/ESTOJO GRAFITE EXT 7302
Código: 48345 Fábrica: YIN'S PAPER Unidade: UN/1 F1 F4

UN: R\$ 8,69 AV: R\$ 8,69 15: R\$ 8,87
30: R\$ 9,04 45: R\$ 9,23 60: R\$ 9,41



COMPASSO METAL C/ESTOJO 4458
Código: 42599 Fábrica: LEO&LEO Unidade: UN/1 F1 F4

UN: R\$ 18,96 AV: R\$ 18,96 15: R\$ 19,35
30: R\$ 19,74 45: R\$ 20,14 60: R\$ 20,54



COMPASSO PINUS P/GIZCM 2930
Código: 49901 Fábrica: SOUZA Unidade: UN/1 F1 F4

UN: R\$ 21,95 AV: R\$ 21,95 15: R\$ 22,41
30: R\$ 22,86 45: R\$ 23,32 60: R\$ 23,78



CONE ISOPOR 360X140MM
Código: 30093 Fábrica: ISOMAX Unidade: UN/1 F1 F4

UN: R\$ 0,20 AV: R\$ 2,00 15: R\$ 2,04
30: R\$ 2,08 45: R\$ 2,12 60: R\$ 2,16



CONVITE SIMPLES ANIVERSARIO 10X1
Código: 29839 Fábrica: UNICART Unidade: PT/10 F1 F4

UN: R\$ 0,20 AV: R\$ 2,00 15: R\$ 2,04
30: R\$ 2,08 45: R\$ 2,12 60: R\$ 2,16



CONVITE SIMPLES CHA COZINHA/PANELA 10X1
Código: 5130 Fábrica: UNICART Unidade: PT/10 F1 F4

UN: R\$ 0,20 AV: R\$ 2,00 15: R\$ 2,04
30: R\$ 2,08 45: R\$ 2,12 60: R\$ 2,16



CONVITE SIMPLES CHA DO BEBE AZUL 10X1
Código: 5600 Fábrica: UNICART Unidade: PT/10 F1 F4

UN: R\$ 0,20 AV: R\$ 2,00 15: R\$ 2,04
30: R\$ 2,08 45: R\$ 2,12 60: R\$ 2,16



CONVITE SIMPLES CHA DO BEBE ROSA 10X1
Código: 32365 Fábrica: UNICART Unidade: PT/10 F1 F4

UN: R\$ 0,73 AV: R\$ 4,38 15: R\$ 4,47
30: R\$ 4,56 45: R\$ 4,66 60: R\$ 4,75



CORCAO EVA 8CM GLITER VERMELHO 6X1
Código: 47913 Fábrica: YIN'S PAPER Unidade: PT/6 F1 F4

UN: R\$ 5,19 AV: R\$ 5,19 15: R\$ 5,30
30: R\$ 5,41 45: R\$ 5,51 60: R\$ 5,62



CORACAO 15 GRS MULTICOR

Código: 59436 Fábrica: MINAS BRILHO Unidade: PT/1 F1 F4

UN: R\$ 1,41 AV: R\$ 16,97 15: R\$ 17,33
30: R\$ 17,67 45: R\$ 18,03 60: R\$ 18,39



CORACAO 3 GR MULTICOR 12X1

Código: 15078 Fábrica: MINAS BRILHO Unidade: DZ/12 F1 F4

UN: R\$ 3,98 AV: R\$ 3,98 15: R\$ 4,07
30: R\$ 4,15 45: R\$ 4,23 60: R\$ 4,32



CORANTE LIQ 10 ML ANILINA AMARELO DAM

Código: 50304 Fábrica: MIX Unidade: UN/1 F1 F4

UN: R\$ 3,98 AV: R\$ 3,98 15: R\$ 4,07
30: R\$ 4,15 45: R\$ 4,23 60: R\$ 4,32



CORANTE LIQ 10 ML ANILINA AMARELO GEMA

Código: 50357 Fábrica: MIX Unidade: UN/1 F1 F4

UN: R\$ 3,98 AV: R\$ 3,98 15: R\$ 4,07
30: R\$ 4,15 45: R\$ 4,23 60: R\$ 4,32



CORANTE LIQ 10 ML ANILINA AZUL JEANS

Código: 50301 Fábrica: MIX Unidade: UN/1 F1 F4

UN: R\$ 3,98 AV: R\$ 3,98 15: R\$ 4,07
30: R\$ 4,15 45: R\$ 4,23 60: R\$ 4,32



CORANTE LIQ 10 ML ANILINA BRANCO LEITE

Código: 50358 Fábrica: MIX Unidade: UN/1 F1 F4

UN: R\$ 3,98 AV: R\$ 3,98 15: R\$ 4,07
30: R\$ 4,15 45: R\$ 4,23 60: R\$ 4,32



CORANTE LIQ 10 ML ANILINA LARANJA

Código: 50352 Fábrica: MIX Unidade: UN/1 F1 F4

UN: R\$ 3,98 AV: R\$ 3,98 15: R\$ 4,07
30: R\$ 4,15 45: R\$ 4,23 60: R\$ 4,32



CORANTE LIQ 10 ML ANILINA MARROM CHOCOLA

Código: 50354 Fábrica: MIX Unidade: UN/1 F1 F4

UN: R\$ 3,98 AV: R\$ 3,98 15: R\$ 4,07
30: R\$ 4,15 45: R\$ 4,23 60: R\$ 4,32



CORANTE LIQ 10 ML ANILINA PRETO INTENSO

Código: 50302 Fábrica: MIX Unidade: UN/1 F1 F4

UN: R\$ 3,98 AV: R\$ 3,98 15: R\$ 4,07
30: R\$ 4,15 45: R\$ 4,23 60: R\$ 4,32



CORANTE LIQ 10 ML ANILINA ROSA CEREJA

Código: 50356 Fábrica: MIX Unidade: UN/1 F1 F4

UN: R\$ 3,98 AV: R\$ 3,98 15: R\$ 4,07
30: R\$ 4,15 45: R\$ 4,23 60: R\$ 4,32



CORANTE LIQ 10 ML ANILINA ROSA PINK

Código: 50350 Fábrica: MIX Unidade: UN/1 F1 F4

UN: R\$ 3,98 AV: R\$ 3,98 15: R\$ 4,07
30: R\$ 4,15 45: R\$ 4,23 60: R\$ 4,32



CORANTE LIQ 10 ML ANILINA VERDE FOLHA

Código: 50303 Fábrica: MIX Unidade: UN/1 F1 F4

UN: R\$ 3,98 AV: R\$ 3,98 15: R\$ 4,07
30: R\$ 4,15 45: R\$ 4,23 60: R\$ 4,32



CORANTE LIQ 10 ML ANILINA VERDE HORTELA

Código: 50349 Fábrica: MIX Unidade: UN/1 F1 F4

UN: R\$ 3,98 AV: R\$ 3,98 15: R\$ 4,07
30: R\$ 4,15 45: R\$ 4,23 60: R\$ 4,32



CORANTE LIQ 10 ML ANILINA VERDE LIMAO

Código: 50355 Fábrica: MIX Unidade: UN/1 F1 F4

UN: R\$ 3,98 AV: R\$ 3,98 15: R\$ 4,07
30: R\$ 4,15 45: R\$ 4,23 60: R\$ 4,32



CORANTE LIQ 10 ML ANILINA VERMELHO MORAN

Código: 50305 Fábrica: MIX Unidade: UN/1 F1 F4

UN: R\$ 3,98 AV: R\$ 3,98 15: R\$ 4,07
30: R\$ 4,15 45: R\$ 4,23 60: R\$ 4,32



CORANTE LIQ 10 ML ANILINA VERMELHO NATAL

Código: 50353 Fábrica: MIX Unidade: UN/1 F1 F4

UN: R\$ 3,98 AV: R\$ 3,98 15: R\$ 4,07
30: R\$ 4,15 45: R\$ 4,23 60: R\$ 4,32



CORANTE LIQ 10 ML ANILINA VINHO BORDO

Código: Fábrika: Unidade:
50351 MIX UN/1
F1 F4

UN: R\$ 2,50 AV: R\$ 24,95 15: R\$ 25,47
30: R\$ 25,98 45: R\$ 26,50 60: R\$ 27,03



CORDAO P/CRACHA C/JACARE 40CM AZUL 10X1

Código: Fábrika: Unidade:
45601 KAZ PT/10
F1 F4

UN: R\$ 2,49 AV: R\$ 24,86 15: R\$ 25,38
30: R\$ 25,89 45: R\$ 26,40 60: R\$ 26,93



CORDAO P/CRACHA C/JACARE 40CM PRETO 10X1

Código: Fábrika: Unidade:
45602 KAZ PT/10
F1 F4

UN: R\$ 3,49 AV: R\$ 34,93 15: R\$ 35,66
30: R\$ 36,38 45: R\$ 37,10 60: R\$ 37,84



CORDAO P/CRACHA C/JACARE 40CM VERDE 10X1

Código: Fábrika: Unidade:
45603 DAC PT/10
F1 F4

UN: R\$ 2,62 AV: R\$ 31,45 15: R\$ 32,10
30: R\$ 32,75 45: R\$ 33,40 60: R\$ 34,07



CORRETIVO LIQUIDO REFIX 18 ML 12X1

Código: Fábrika: Unidade:
49503 TRIS DZ/12
F1 F4

UN: R\$ 2,79 AV: R\$ 2,79 15: R\$ 2,84
30: R\$ 2,90 45: R\$ 2,96 60: R\$ 3,02



CORRETIVO LIQUIDO 18 ML UN

Código: Fábrika: Unidade:
42298 NEW MAGIC EC UN/1
F1 F4

UN: R\$ 2,99 AV: R\$ 35,93 15: R\$ 36,68
30: R\$ 37,41 45: R\$ 38,16 60: R\$ 38,93



CORRETIVO LIQUIDO 18 ML 12X1

Código: Fábrika: Unidade:
3348 NEW MAGIC DZ/12
F1 F4

UN: R\$ 0,39 AV: R\$ 38,93 15: R\$ 39,74
30: R\$ 40,53 45: R\$ 41,34 60: R\$ 42,17



CRACHA BH-05 9,3X6,7CM 100X1

Código: Fábrika: Unidade:
41787 MP CE/100
F1 F4

UN: R\$ 0,46 AV: R\$ 45,93 15: R\$ 46,88
30: R\$ 47,82 45: R\$ 48,78 60: R\$ 49,75



CRACHA HORIZ AB LAT 7X10CM C-9 100X1

Código: Fábrika: Unidade:
46175 ACP PT/100
F1 F4

UN: R\$ 0,46 AV: R\$ 45,93 15: R\$ 46,88
30: R\$ 47,82 45: R\$ 48,78 60: R\$ 49,75



CRACHA HORIZ AB SUP 7X10CM C-9/S 100X1

Código: Fábrika: Unidade:
46172 ACP CE/100
F1 F4

UN: R\$ 1,64 AV: R\$ 164,04 15: R\$ 167,45
30: R\$ 170,80 45: R\$ 174,22 60: R\$ 177,70



CRACHA HORIZ C/PRESILH 7X10CM C-7 100X1

Código: Fábrika: Unidade:
46204 ACP CE/100
F1 F4

UN: R\$ 1,22 AV: R\$ 12,23 15: R\$ 12,49
30: R\$ 12,73 45: R\$ 12,99 60: R\$ 13,25



CUBO ISOPOR 100X100X100MM 10X1

Código: Fábrika: Unidade:
30094 ISOMAX PT/10
F1 F4

UN: R\$ 0,80 AV: R\$ 7,99 15: R\$ 8,15
30: R\$ 8,32 45: R\$ 8,48 60: R\$ 8,65

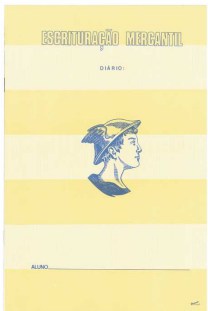

DIARIO DE ESCRITURACAO MERCANTIL 10X1

Código: Fábrika: Unidade:
28916 GRAMULI PT/10
F1 F4

UN: R\$ 4,48 AV: R\$ 4,48 15: R\$ 4,58
30: R\$ 4,67 45: R\$ 4,76 60: R\$ 4,86



DICIONARIO MINI ESPANHOL 101

Código: Fábrika: Unidade:
42686 CULTURAMA UN/1
F1 F4

UN: R\$ 5,98 AV: R\$ 5,98 15: R\$ 6,11
30: R\$ 6,23 45: R\$ 6,35 60: R\$ 6,48

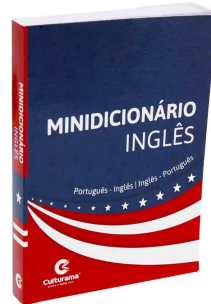

DICIONARIO MINI INGLES 102

Código: Fábrika: Unidade:
42687 CULTURAMA UN/1
F1 F4

UN: R\$ 3,98 AV: R\$ 3,98 15: R\$ 4,07
30: R\$ 4,15 45: R\$ 4,23 60: R\$ 4,32

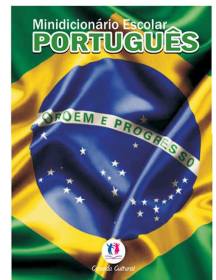

DICIONARIO MINI PORTUGUES JORNAL

Código: Fábrika: Unidade:
33425 CIRANDACULT UN/1
F1 F4

UN: R\$ 2,29 AV: R\$ 2,29 15: R\$ 2,33
30: R\$ 2,38 45: R\$ 2,43 60: R\$ 2,48



DICIONARIO MINI PORTUGUES JORNAL
Código: Fábrika: Unidade:
12962 CIRANDA CULT UN/1
F1 F4

UN: R\$ 5,98 AV: R\$ 5,98 15: R\$ 6,11
30: R\$ 6,23 45: R\$ 6,35 60: R\$ 6,48



DICIONARIO MINI PORTUGUES 103
Código: Fábrika: Unidade:
42688 CULTURAMA UN/1
F1 F4

UN: R\$ 5,78 AV: R\$ 5,78 15: R\$ 5,90
30: R\$ 6,02 45: R\$ 6,14 60: R\$ 6,26



DICIONARIO MINI SCOTTINI ESPANHOL
Código: Fábrika: Unidade:
48484 TODOLIVRO UN/1
F1 F4

UN: R\$ 5,78 AV: R\$ 5,78 15: R\$ 5,90
30: R\$ 6,02 45: R\$ 6,14 60: R\$ 6,26



DICIONARIO MINI SCOTTINI INGLES
Código: Fábrika: Unidade:
30919 TODOLIVRO UN/1
F1 F4

UN: R\$ 5,78 AV: R\$ 5,78 15: R\$ 5,90
30: R\$ 6,02 45: R\$ 6,14 60: R\$ 6,26

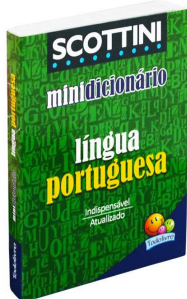

DICIONARIO MINI SCOTTINI PORTUGUES
Código: Fábrika: Unidade:
30918 TODOLIVRO UN/1
F1 F4

UN: R\$ 8,24 AV: R\$ 8,24 15: R\$ 8,41
30: R\$ 8,58 45: R\$ 8,75 60: R\$ 8,92



DILUENTE P/TINTA TECIDO 60 ML 19360 UN
Código: Fábrika: Unidade:
44983 ACRILEX UN/1
F1 F4

UN: R\$ 19,76 AV: R\$ 19,76 15: R\$ 20,17
30: R\$ 20,57 45: R\$ 20,98 60: R\$ 21,40



DISPLAY FRONTAL A4 31X23X0,3CM 10090013
Código: Fábrika: Unidade:
44677 MAXCRIL UN/1
F1 F4

UN: R\$ 4,98 AV: R\$ 4,98 15: R\$ 5,09
30: R\$ 5,19 45: R\$ 5,29 60: R\$ 5,40



DIVISORIA P/ FICHARIO 12 MATERIAS 855
Código: Fábrika: Unidade:
19469 ACP UN/1
F1 F4

UN: R\$ 1,70 AV: R\$ 84,86 15: R\$ 86,63
30: R\$ 88,36 45: R\$ 90,13 60: R\$ 91,93



DVD-R GRAVAVEL 120 MIN 4,7 GB 50X1
Código: Fábrika: Unidade:
14632 MAKETECH PT/50
F1 F4

UN: R\$ 40,19 AV: R\$ 40,19 15: R\$ 41,02
30: R\$ 41,84 45: R\$ 42,68 60: R\$ 43,53



ELASTICO P/DINH N18 (GOMINHA) KG 1200X1
Código: Fábrika: Unidade:
28031 RED BOR PT/1
F1 F4

UN: R\$ 5,38 AV: R\$ 5,38 15: R\$ 5,49
30: R\$ 5,60 45: R\$ 5,72 60: R\$ 5,83



ELASTICO P/DINH N18 (GOMINHA) 100G 120X1
Código: Fábrika: Unidade:
13142 PREMIER/MAMU PT/1
F1 F4

UN: R\$ 5,28 AV: R\$ 5,28 15: R\$ 5,39
30: R\$ 5,50 45: R\$ 5,61 60: R\$ 5,72



ELASTICO P/DINH N18 (GOMINHA) 100X1
Código: Fábrika: Unidade:
41228 PREMIER PT/1
F1 F4

UN: R\$ 9,97 AV: R\$ 9,97 15: R\$ 10,18
30: R\$ 10,39 45: R\$ 10,59 60: R\$ 10,81



ELASTICO P/DINH N18 (GOMINHA) 200X1
Código: Fábrika: Unidade:
41226 MERCUR PT/1
F1 F4

UN: R\$ 2,17 AV: R\$ 2,17 15: R\$ 2,21
30: R\$ 2,26 45: R\$ 2,30 60: R\$ 2,35



ELASTICO P/DINH N18 (GOMINHA) 25G 30X1
Código: Fábrika: Unidade:
28030 PREMIER CX/1
F1 F4

UN: R\$ 12,97 AV: R\$ 12,97 15: R\$ 13,24
30: R\$ 13,50 45: R\$ 13,77 60: R\$ 14,05



ELASTICO P/DINH N18 (GOMINHA) 250G 300X1
Código: Fábrika: Unidade:
49144 PREMIER PT/1
F1 F4

UN: R\$ 3,56 AV: R\$ 3,56 15: R\$ 3,64
30: R\$ 3,71 45: R\$ 3,79 60: R\$ 3,86



ELASTICO P/DINH N18 (GOMINHA) 50G 60X1
Código: Fábrika: Unidade:
22488 PREMIER PT/1
F1 F4

UN: R\$ 21,95 AV: R\$ 21,95 15: R\$ 22,41
30: R\$ 22,86 45: R\$ 23,32 60: R\$ 23,78



ELASTICO P/DINH N18 (GOMINHA)500G 600X1
Código: Fábrika: Unidade:
35961 PREMIER PT/1
F1 F4

UN: R\$ 34,93 AV: R\$ 34,93 15: R\$ 35,66
30: R\$ 36,38 45: R\$ 37,10 60: R\$ 37,84



EMBALAGEM PLAST BOBINA 25CM KG
Código: Fábrika: Unidade:
46254 ACP KG/1
F1 F4

UN: R\$ 0,37 AV: R\$ 92,84 15: R\$ 94,78
30: R\$ 96,67 45: R\$ 98,60 60: R\$ 100,58

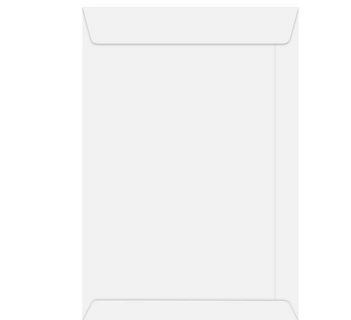

ENVELOPE BRANCO SACO 176X250MM O25 250X1
Código: Fábrika: Unidade:
28126 REIPEL CX/250
F1 F4

UN: R\$ 0,70 AV: R\$ 69,88 15: R\$ 71,33
30: R\$ 72,76 45: R\$ 74,22 60: R\$ 75,70



ENVELOPE BRANCO SACO 176X250MM 725 100X1
Código: Fábrika: Unidade:
19602 SCRITY CX/100
F1 F4

UN: R\$ 0,44 AV: R\$ 109,81 15: R\$ 112,10
30: R\$ 114,34 45: R\$ 116,63 60: R\$ 118,96

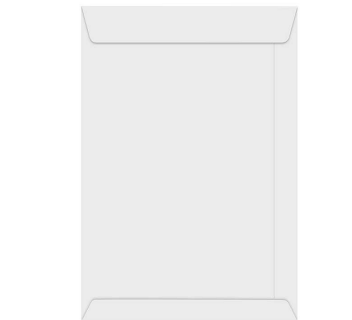

ENVELOPE BRANCO SACO 200X280MM O28 250X1
Código: Fábrika: Unidade:
12189 REIPEL CX/250
F1 F4

UN: R\$ 0,52 AV: R\$ 129,78 15: R\$ 132,49
30: R\$ 135,14 45: R\$ 137,84 60: R\$ 140,60

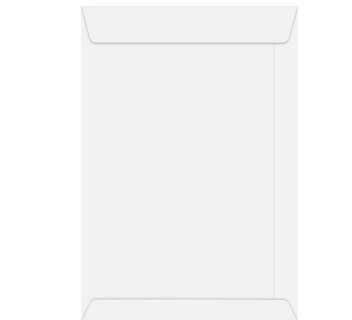

ENVELOPE BRANCO SACO 229X324MM O32 250X1
Código: Fábrika: Unidade:
28127 REIPEL/SCRIT CX/250
F1 F4

UN: R\$ 0,60 AV: R\$ 59,89 15: R\$ 61,14
30: R\$ 62,36 45: R\$ 63,61 60: R\$ 64,88



ENVELOPE BRANCO SACO 229X324MM 732 100X1
Código: Fábrika: Unidade:
27863 SCRITY CX/100
F1 F4

UN: R\$ 0,60 AV: R\$ 149,75 15: R\$ 152,87
30: R\$ 155,93 45: R\$ 159,05 60: R\$ 162,23

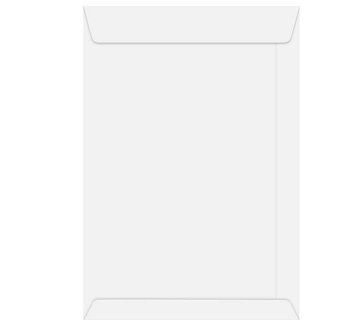

ENVELOPE BRANCO SACO 240X340MM O34 250X1
Código: Fábrika: Unidade:
28128 REIPEL/SCRIT CX/250
F1 F4

UN: R\$ 0,70 AV: R\$ 69,88 15: R\$ 71,33
30: R\$ 72,76 45: R\$ 74,22 60: R\$ 75,70



ENVELOPE BRANCO SACO 240X340MM 734 100X1
Código: Fábrika: Unidade:
28125 SCRITY CX/100
F1 F4

UN: R\$ 0,72 AV: R\$ 179,70 15: R\$ 183,45
30: R\$ 187,11 45: R\$ 190,86 60: R\$ 194,67

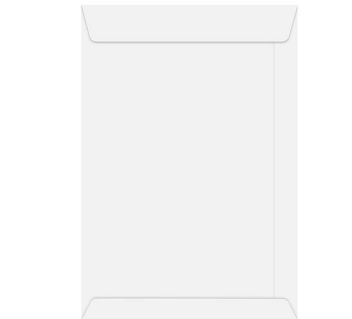

ENVELOPE BRANCO SACO 260X360MM O36 250X1
Código: Fábrika: Unidade:
46598 REIPEL CX/250
F1 F4

UN: R\$ 0,80 AV: R\$ 79,86 15: R\$ 81,53
30: R\$ 83,16 45: R\$ 84,82 60: R\$ 86,52



ENVELOPE BRANCO SACO 260X360MM 100X1
Código: Fábrika: Unidade:
46918 SCRITY CX/100
F1 F4

UN: R\$ 1,00 AV: R\$ 99,83 15: R\$ 101,91
30: R\$ 103,95 45: R\$ 106,03 60: R\$ 108,15



ENVELOPE BRANCO SACO 310X410MM 100X1
Código: Fábrika: Unidade:
50623 REIPEL CX/100
F1 F4

UN: R\$ 0,23 AV: R\$ 22,95 15: R\$ 23,43
30: R\$ 23,90 45: R\$ 24,38 60: R\$ 24,87



ENVELOPE BRANCO 121X190MM 100X1
Código: Fábrika: Unidade:
50630 REIPEL CX/100
F1 F4

UN: R\$ 0,80 AV: R\$ 79,86 15: R\$ 81,53
30: R\$ 83,16 45: R\$ 84,82 60: R\$ 86,52



ENVELOPE COM 110X162MM AZUL BAHAMA 100X1
Código: Fábrika: Unidade:
45240 AGAPE CE/100
F1 F4

UN: R\$ 0,80 AV: R\$ 79,86 15: R\$ 81,53
30: R\$ 83,16 45: R\$ 84,82 60: R\$ 86,52

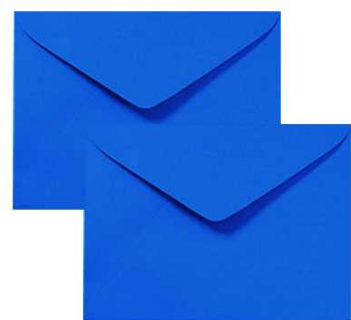

ENVELOPE COM 110X162MM AZUL GRECIA 100X1
Código: Fábrika: Unidade:
35303 AGAPE CE/100
F1 F4

UN: R\$ 0,80 AV: R\$ 79,86 15: R\$ 81,53
30: R\$ 83,16 45: R\$ 84,82 60: R\$ 86,52



ENVELOPE COM 110X162MM AZUL GRECIA 100X1
Código: Fábrika: Unidade:
45238 AGAPE CE/100
F1 F4

UN: R\$ 0,80 AV: R\$ 79,86 15: R\$ 81,53
30: R\$ 83,16 45: R\$ 84,82 60: R\$ 86,52



ENVELOPE COM 110X162MM AZUL P SEGU 100X1
Código: Fábrica: Unidade:
45239 AGAPE CE/100
F1 F4

UN: R\$ 0,80 AV: R\$ 79,86 15: R\$ 81,53
30: R\$ 83,16 45: R\$ 84,82 60: R\$ 86,52



ENVELOPE COM 110X162MM LARANJ CART 100X1
Código: Fábrica: Unidade:
45245 AGAPE CE/100
F1 F4

UN: R\$ 0,80 AV: R\$ 79,86 15: R\$ 81,53
30: R\$ 83,16 45: R\$ 84,82 60: R\$ 86,52



ENVELOPE COM 110X162MM LILAS AMSTE 100X1
Código: Fábrica: Unidade:
45250 AGAPE CE/100
F1 F4

UN: R\$ 0,80 AV: R\$ 79,86 15: R\$ 81,53
30: R\$ 83,16 45: R\$ 84,82 60: R\$ 86,52



ENVELOPE COM 110X162MM PRETO LOS A 100X1
Código: Fábrica: Unidade:
45242 AGAPE CE/100
F1 F4

UN: R\$ 0,80 AV: R\$ 39,93 15: R\$ 40,76
30: R\$ 41,57 45: R\$ 42,40 60: R\$ 43,25

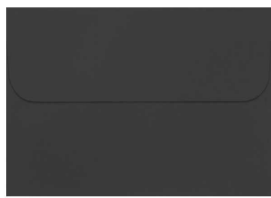

ENVELOPE COM 110X162MM PRETO 50X1
Código: Fábrica: Unidade:
35881 AGAPE PT/50
F1 F4

UN: R\$ 0,80 AV: R\$ 79,86 15: R\$ 81,53
30: R\$ 83,16 45: R\$ 84,82 60: R\$ 86,52



ENVELOPE COM 110X162MM RECICLADO 100X1
Código: Fábrica: Unidade:
45249 AGAPE CE/100
F1 F4

UN: R\$ 0,80 AV: R\$ 79,86 15: R\$ 81,53
30: R\$ 83,16 45: R\$ 84,82 60: R\$ 86,52



ENVELOPE COM 110X162MM ROSA CHICLE 100X1
Código: Fábrica: Unidade:
45247 AGAPE CE/100
F1 F4

UN: R\$ 0,80 AV: R\$ 39,93 15: R\$ 40,76
30: R\$ 41,57 45: R\$ 42,40 60: R\$ 43,25

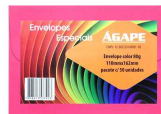

ENVELOPE COM 110X162MM ROSA 50X1
Código: Fábrica: Unidade:
35883 AGAPE PT/50
F1 F4

UN: R\$ 0,80 AV: R\$ 79,86 15: R\$ 81,53
30: R\$ 83,16 45: R\$ 84,82 60: R\$ 86,52



ENVELOPE COM 110X162MM VERDE BRASI 100X1
Código: Fábrica: Unidade:
45246 AGAPE CE/100
F1 F4

UN: R\$ 0,80 AV: R\$ 79,86 15: R\$ 81,53
30: R\$ 83,16 45: R\$ 84,82 60: R\$ 86,52



ENVELOPE COM 110X162MM VERMELH TOQ 100X1
Código: Fábrica: Unidade:
14398 AGAPE CE/100
F1 F4

UN: R\$ 0,19 AV: R\$ 18,96 15: R\$ 19,35
30: R\$ 19,74 45: R\$ 20,14 60: R\$ 20,54

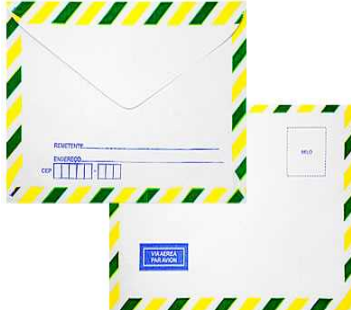

ENVELOPE COM 114X162MM AEREO 015 100X1
Código: Fábrica: Unidade:
498 SCRITY CE/100
F1 F4

UN: R\$ 0,80 AV: R\$ 79,86 15: R\$ 81,53
30: R\$ 83,16 45: R\$ 84,82 60: R\$ 86,52



ENVELOPE COM 114X162MM AMARELO RIO 100X1
Código: Fábrica: Unidade:
45241 AGAPE CE/100
F1 F4

UN: R\$ 0,80 AV: R\$ 79,86 15: R\$ 81,53
30: R\$ 83,16 45: R\$ 84,82 60: R\$ 86,52



ENVELOPE COM 114X162MM AZUL GRECIA 100X1
Código: Fábrica: Unidade:
15932 SCRITY CE/100
F1 F4

UN: R\$ 0,80 AV: R\$ 79,86 15: R\$ 81,53
30: R\$ 83,16 45: R\$ 84,82 60: R\$ 86,52

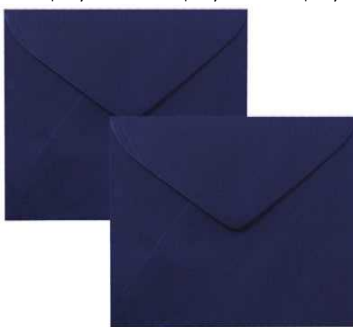

ENVELOPE COM 114X162MM AZUL P SEG 100X1
Código: Fábrica: Unidade:
14397 SCRITY CE/100
F1 F4

UN: R\$ 0,80 AV: R\$ 39,93 15: R\$ 40,76
30: R\$ 41,57 45: R\$ 42,40 60: R\$ 43,25



ENVELOPE COM 114X162MM AZUL P SEGUR 50X1
Código: Fábrica: Unidade:
35884 AGAPE PT/50
F1 F4

UN: R\$ 0,16 AV: R\$ 159,73 15: R\$ 163,06
30: R\$ 166,32 45: R\$ 169,65 60: R\$ 173,04

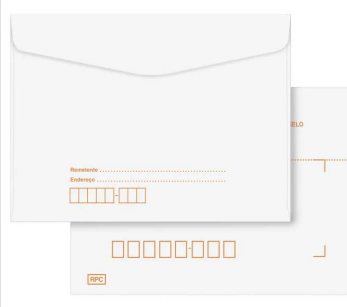

ENVELOPE COM 114X162MM BCO C/CEP 1000X1
Código: Fábrica: Unidade:
37408 SCRITY CX/1000
F1 F4

UN: R\$ 0,17 AV: R\$ 16,96 15: R\$ 17,32
30: R\$ 17,66 45: R\$ 18,02 60: R\$ 18,38



ENVELOPE COM 114X162MM BCO S/CEP 100X1
Código: Fábrica: Unidade:
2299 SCRITY CE/100
F1 F4

UN: R\$ 0,16 AV: R\$ 159,73 15: R\$ 163,06
30: R\$ 166,32 45: R\$ 169,65 60: R\$ 173,04



ENVELOPE COM 114X162MM BCO S/CEP 1000X1
Código: Fábrica: Unidade:
14396 REIPEL/SCRIT CX/1000
F1 F4

UN: R\$ 0,80 AV: R\$ 79,86 15: R\$ 81,53
30: R\$ 83,16 45: R\$ 84,82 60: R\$ 86,52



ENVELOPE COM 114X162MM CREM MARFIM 100X1
Código: Fábrica: Unidade:
9136 SCRITY CE/100
F1 F4

UN: R\$ 0,80 AV: R\$ 79,86 15: R\$ 81,53
30: R\$ 83,16 45: R\$ 84,82 60: R\$ 86,52



ENVELOPE COM 114X162MM CREME 100X1
Código: Fábrica: Unidade:
45248 AGAPE CE/100
F1 F4

UN: R\$ 0,80 AV: R\$ 79,86 15: R\$ 81,53
30: R\$ 83,16 45: R\$ 84,82 60: R\$ 86,52



ENVELOPE COM 114X162MM LARANJA CAR 100X1
Código: Fábrica: Unidade:
14399 SCRITY CE/100
F1 F4

UN: R\$ 0,80 AV: R\$ 39,93 15: R\$ 40,76
30: R\$ 41,57 45: R\$ 42,40 60: R\$ 43,25



ENVELOPE COM 114X162MM LILAS 50X1
Código: Fábrica: Unidade:
35882 AGAPE PT/50
F1 F4

UN: R\$ 0,23 AV: R\$ 229,62 15: R\$ 234,41
30: R\$ 239,09 45: R\$ 243,88 60: R\$ 248,75

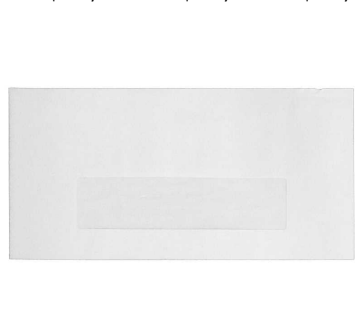

ENVELOPE COM 114X162MM OFIC JANEL 1000X1
Código: Fábrica: Unidade:
45059 CELUCAT CX/1000
F1 F4

UN: R\$ 0,80 AV: R\$ 79,86 15: R\$ 81,53
30: R\$ 83,16 45: R\$ 84,82 60: R\$ 86,52



ENVELOPE COM 114X162MM PRETO LOS 100X1
Código: Fábrica: Unidade:
43813 SCRITY CE/100
F1 F4

UN: R\$ 79,86 AV: R\$ 79,86 15: R\$ 81,53
30: R\$ 83,16 45: R\$ 84,82 60: R\$ 86,52



ENVELOPE COM 114X162MM VERDE BRASI 100X1
Código: Fábrica: Unidade:
44180 SCRITY PT/1
F1 F4

UN: R\$ 0,80 AV: R\$ 79,86 15: R\$ 81,53
30: R\$ 83,16 45: R\$ 84,82 60: R\$ 86,52



ENVELOPE COM 114X162MM VERDE BUENO 100X1
Código: Fábrica: Unidade:
45243 AGAPE CE/100
F1 F4

UN: R\$ 0,80 AV: R\$ 79,86 15: R\$ 81,53
30: R\$ 83,16 45: R\$ 84,82 60: R\$ 86,52



ENVELOPE COM 114X162MM VERDE NEON 100X1
Código: Fábrica: Unidade:
45244 AGAPE CE/100
F1 F4

UN: R\$ 0,21 AV: R\$ 20,96 15: R\$ 21,39
30: R\$ 21,82 45: R\$ 22,26 60: R\$ 22,70



ENVELOPE COM 114X229MM OFICIO 020 100X1
Código: Fábrica: Unidade:
7135 SCRITY CE/100
F1 F4

UN: R\$ 0,18 AV: R\$ 183,21 15: R\$ 187,02
30: R\$ 190,76 45: R\$ 194,58 60: R\$ 198,47



ENVELOPE COM 114X229MM OFICIO 020 1000X1
Código: Fábrica: Unidade:
20438 REIPEL/SCRIT CX/1000
F1 F4

UN: R\$ 1,00 AV: R\$ 49,91 15: R\$ 50,95
30: R\$ 51,97 45: R\$ 53,01 60: R\$ 54,07



ENVELOPE CONV AZUL ESC 160X220MM 50X1
Código: Fábrica: Unidade:
35891 AGAPE PT/50
F1 F4

UN: R\$ 1,20 AV: R\$ 59,89 15: R\$ 61,14
30: R\$ 62,36 45: R\$ 63,61 60: R\$ 64,88



ENVELOPE CONV CINZ METAL 163X225MM 50X1
Código: Fábrica: Unidade:
35591 ROMITEC C//50
F1 F4

UN: R\$ 1,00 AV: R\$ 49,91 15: R\$ 50,95
30: R\$ 51,97 45: R\$ 53,01 60: R\$ 54,07



ENVELOPE CONV CREME 160X220MM 50X1
Código: Fábrica: Unidade:
41547 AGAPE PT/50
F1 F4

UN: R\$ 1,00 AV: R\$ 99,83 15: R\$ 101,91
30: R\$ 103,95 45: R\$ 106,03 60: R\$ 108,15



ENVELOPE CONV LILAS AMST 160X235MM 100X1
Código: Fábrika: Unidade:
43822 SCRITY CE/100
F1 F4

UN: R\$ 1,00 AV: R\$ 49,91 15: R\$ 50,95
30: R\$ 51,97 45: R\$ 53,01 60: R\$ 54,07



ENVELOPE CONV LILAS 160X220MM 50X1
Código: Fábrika: Unidade:
35890 AGAPE PT/50
F1 F4

UN: R\$ 1,00 AV: R\$ 49,91 15: R\$ 50,95
30: R\$ 51,97 45: R\$ 53,01 60: R\$ 54,07

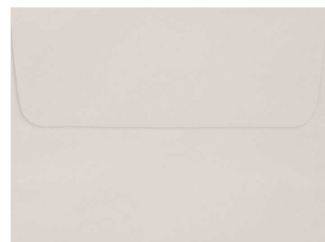

ENVELOPE CONV MARFIM 160X220MM 50X1
Código: Fábrika: Unidade:
35892 AGAPE PT/50
F1 F4

UN: R\$ 1,00 AV: R\$ 99,83 15: R\$ 101,91
30: R\$ 103,95 45: R\$ 106,03 60: R\$ 108,15



ENVELOPE CONV MARFIM 160X235MM 100X1
Código: Fábrika: Unidade:
43825 SCRITY CE/100
F1 F4

UN: R\$ 1,20 AV: R\$ 59,89 15: R\$ 61,14
30: R\$ 62,36 45: R\$ 63,61 60: R\$ 64,88



ENVELOPE CONV PINK 163X225MM 50X1 3230
Código: Fábrika: Unidade:
35589 ROMITEC C//50
F1 F4

UN: R\$ 1,00 AV: R\$ 49,91 15: R\$ 50,95
30: R\$ 51,97 45: R\$ 53,01 60: R\$ 54,07

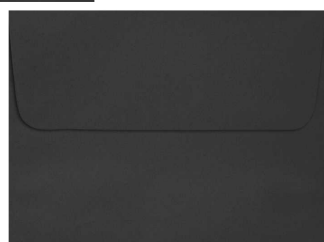

ENVELOPE CONV PRETO 160X220MM 50X1
Código: Fábrika: Unidade:
35887 AGAPE PT/50
F1 F4

UN: R\$ 1,00 AV: R\$ 99,83 15: R\$ 101,91
30: R\$ 103,95 45: R\$ 106,03 60: R\$ 108,15

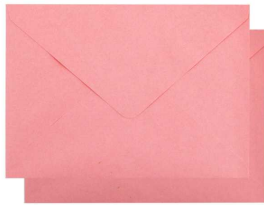

ENVELOPE CONV ROSA FIDJI 160X235MM 100X1
Código: Fábrika: Unidade:
43820 SCRITY CE/100
F1 F4

UN: R\$ 1,20 AV: R\$ 59,89 15: R\$ 61,14
30: R\$ 62,36 45: R\$ 63,61 60: R\$ 64,88



ENVELOPE CONV ROSA METAL 163X225MM 50X1
Código: Fábrika: Unidade:
35590 ROMITEC C//50
F1 F4

UN: R\$ 1,00 AV: R\$ 49,91 15: R\$ 50,95
30: R\$ 51,97 45: R\$ 53,01 60: R\$ 54,07



ENVELOPE CONV ROSA 160X220MM 50X1
Código: Fábrika: Unidade:
35886 AGAPE PT/50
F1 F4

UN: R\$ 1,00 AV: R\$ 99,83 15: R\$ 101,91
30: R\$ 103,95 45: R\$ 106,03 60: R\$ 108,15



ENVELOPE CONV ROXO 163X225MM 100X1
Código: Fábrika: Unidade:
35592 ROMITEC C//100
F1 F4

UN: R\$ 1,00 AV: R\$ 99,83 15: R\$ 101,91
30: R\$ 103,95 45: R\$ 106,03 60: R\$ 108,15



ENVELOPE CONV VERD BRASI 160X235MM 100X1
Código: Fábrika: Unidade:
43821 SCRITY CE/100
F1 F4

UN: R\$ 1,00 AV: R\$ 49,91 15: R\$ 50,95
30: R\$ 51,97 45: R\$ 53,01 60: R\$ 54,07

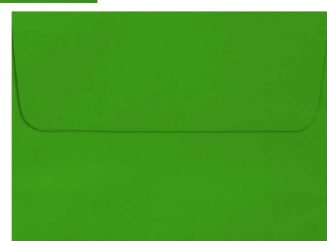

ENVELOPE CONV VERDE BAND 160X220MM 50X1
Código: Fábrika: Unidade:
35888 AGAPE PT/50
F1 F4

UN: R\$ 1,00 AV: R\$ 99,83 15: R\$ 101,91
30: R\$ 103,95 45: R\$ 106,03 60: R\$ 108,15



ENVELOPE CONV VERM TOQUI 160X235MM 100X1
Código: Fábrika: Unidade:
43823 SCRITY CE/100
F1 F4

UN: R\$ 1,00 AV: R\$ 49,91 15: R\$ 50,95
30: R\$ 51,97 45: R\$ 53,01 60: R\$ 54,07



ENVELOPE CONV VERMELHO 160X220MM 50X1
Código: Fábrika: Unidade:
35889 AGAPE PT/50
F1 F4

UN: R\$ 0,28 AV: R\$ 27,95 15: R\$ 28,53
30: R\$ 29,10 45: R\$ 29,68 60: R\$ 30,27

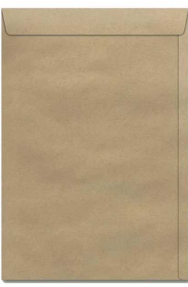

ENVELOPE KRAFT SACO 110X170MM 100X1
Código: Fábrika: Unidade:
50629 REIPEL CX/100
F1 F4

UN: R\$ 0,26 AV: R\$ 64,89 15: R\$ 66,24
30: R\$ 67,56 45: R\$ 68,91 60: R\$ 70,29



ENVELOPE KRAFT SACO 110X170MM KN17 250X1
Código: Fábrika: Unidade:
15929 SCRITY CX/250
F1 F4

UN: R\$ 0,24 AV: R\$ 59,89 15: R\$ 61,14
30: R\$ 62,36 45: R\$ 63,61 60: R\$ 64,88



ENVELOPE KRAFT SACO 125X176MM KN18 250X1
Código: Fábrica: Unidade:
29999 SCRITY CX/250
F1 F4

UN: R\$ 0,32 AV: R\$ 79,86 15: R\$ 81,53
30: R\$ 83,16 45: R\$ 84,82 60: R\$ 86,52



ENVELOPE KRAFT SACO 162X229MM KN23 250X1
Código: Fábrica: Unidade:
47016 REIPEL CX/250
F1 F4

UN: R\$ 0,36 AV: R\$ 89,85 15: R\$ 91,72
30: R\$ 93,55 45: R\$ 95,42 60: R\$ 97,33



ENVELOPE KRAFT SACO 176X250MM KN18 250X1
Código: Fábrica: Unidade:
9124 SCRITY CX/250
F1 F4

UN: R\$ 0,40 AV: R\$ 39,93 15: R\$ 40,76
30: R\$ 41,57 45: R\$ 42,40 60: R\$ 43,25



ENVELOPE KRAFT SACO 176X250MM 325 100X1
Código: Fábrica: Unidade:
12188 SCRITY CX/100
F1 F4

UN: R\$ 0,38 AV: R\$ 95,84 15: R\$ 97,83
30: R\$ 99,79 45: R\$ 101,79 60: R\$ 103,82



ENVELOPE KRAFT SACO 200X280MM KN28 250X1
Código: Fábrica: Unidade:
26698 SCRITY CX/250
F1 F4

UN: R\$ 0,50 AV: R\$ 49,91 15: R\$ 50,95
30: R\$ 51,97 45: R\$ 53,01 60: R\$ 54,07



ENVELOPE KRAFT SACO 200X280MM 353 100X1
Código: Fábrica: Unidade:
19796 SCRITY CX/100
F1 F4

UN: R\$ 0,40 AV: R\$ 199,67 15: R\$ 203,83
30: R\$ 207,91 45: R\$ 212,06 60: R\$ 216,31



ENVELOPE KRAFT SACO 200X280MM 38 500X1
Código: Fábrica: Unidade:
45056 CELUCAT CX/500
F1 F4

UN: R\$ 0,40 AV: R\$ 99,95 15: R\$ 99,95
30: R\$ 99,95 45: R\$ 99,95 60: R\$ 99,95



ENVELOPE KRAFT SACO 229X324MM KN32 250X1
Código: Fábrica: Unidade:
23223 SCRITY CX/250
F1 F4

UN: R\$ 0,50 AV: R\$ 49,91 15: R\$ 50,95
30: R\$ 51,97 45: R\$ 53,01 60: R\$ 54,07



ENVELOPE KRAFT SACO 229X324MM 332 100X1
Código: Fábrica: Unidade:
9128 CELUCAT/SCRI CX/100
F1 F4

UN: R\$ 0,50 AV: R\$ 123,79 15: R\$ 126,37
30: R\$ 128,90 45: R\$ 131,48 60: R\$ 134,11

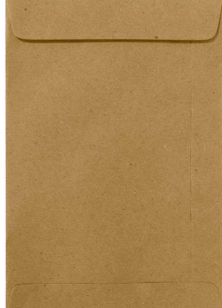

ENVELOPE KRAFT SACO 240X340MM KN34 250X1
Código: Fábrica: Unidade:
8469 SCRITY CX/250
F1 F4

UN: R\$ 0,52 AV: R\$ 129,78 15: R\$ 132,49
30: R\$ 135,14 45: R\$ 137,84 60: R\$ 140,60



ENVELOPE KRAFT SACO 250X353MM KN35 250X1
Código: Fábrica: Unidade:
6044 REIPEL/SCRI CX/250
F1 F4

UN: R\$ 0,56 AV: R\$ 139,77 15: R\$ 142,68
30: R\$ 145,53 45: R\$ 148,44 60: R\$ 151,41



ENVELOPE KRAFT SACO 260X360MM KN36 250X1
Código: Fábrica: Unidade:
42635 REIPEL CX/250
F1 F4

UN: R\$ 0,56 AV: R\$ 139,77 15: R\$ 142,68
30: R\$ 145,53 45: R\$ 148,44 60: R\$ 151,41



ENVELOPE KRAFT SACO 260X360MM KN36 250X1
Código: Fábrica: Unidade:
19031 SCRITY CX/250
F1 F4

UN: R\$ 0,72 AV: R\$ 179,70 15: R\$ 183,45
30: R\$ 187,11 45: R\$ 190,86 60: R\$ 194,67

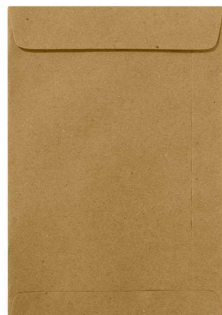

ENVELOPE KRAFT SACO 310X410MM KN41 250X1
Código: Fábrica: Unidade:
42626 REIPEL/CELUC CX/250
F1 F4

UN: R\$ 1,00 AV: R\$ 99,83 15: R\$ 101,91
30: R\$ 103,95 45: R\$ 106,03 60: R\$ 108,15



ENVELOPE KRAFT SACO 310X410MM 341 100X1
Código: Fábrica: Unidade:
42073 SCRITY CX/100
F1 F4

UN: R\$ 1,40 AV: R\$ 139,77 15: R\$ 142,68
30: R\$ 145,53 45: R\$ 148,44 60: R\$ 151,41



ENVELOPE KRAFT SACO 370X470MM 347 100X1
Código: Fábrica: Unidade:
44179 SCRITY/CELUC CX/100
F1 F4

UN: R\$ 0,30 AV: R\$ 29,94 15: R\$ 30,57
30: R\$ 31,18 45: R\$ 31,80 60: R\$ 32,44



ENVELOPE OURO SACO 110X170MM 100X1
Código: Fábrica: Unidade:
50628 REIPEL CX/100
F1 F4

UN: R\$ 39,93 AV: R\$ 39,93 15: R\$ 40,76
30: R\$ 41,57 45: R\$ 42,40 60: R\$ 43,25



ENVELOPE OURO SACO 162X229MM KO 100X1
Código: Fábrica: Unidade:
50625 REIPEL PT/1
F1 F4

UN: R\$ 0,36 AV: R\$ 89,85 15: R\$ 91,72
30: R\$ 93,55 45: R\$ 95,42 60: R\$ 97,33



ENVELOPE OURO SACO 162X229MM KO23 250X1
Código: Fábrica: Unidade:
47616 REIPEL CX/250
F1 F4

UN: R\$ 0,49 AV: R\$ 48,91 15: R\$ 49,93
30: R\$ 50,93 45: R\$ 51,95 60: R\$ 52,99



ENVELOPE OURO SACO 185X248MM 100X1
Código: Fábrica: Unidade:
50624 REIPEL CX/100
F1 F4

UN: R\$ 0,60 AV: R\$ 149,75 15: R\$ 152,87
30: R\$ 155,93 45: R\$ 159,05 60: R\$ 162,23



ENVELOPE OURO SACO 240X340MM KO34 250X1
Código: Fábrica: Unidade:
47595 REIPEL CX/250
F1 F4

UN: R\$ 0,40 AV: R\$ 39,93 15: R\$ 40,76
30: R\$ 41,57 45: R\$ 42,40 60: R\$ 43,25



ENVELOPE VIS 80GR AMAR RJ 72X108MM 100X1
Código: Fábrica: Unidade:
12192 SCRITY CE/100
F1 F4

UN: R\$ 0,40 AV: R\$ 39,93 15: R\$ 40,76
30: R\$ 41,57 45: R\$ 42,40 60: R\$ 43,25



ENVELOPE VIS 80GR AMARELO 75X115MM 100X1
Código: Fábrica: Unidade:
9137 AGAPE CE/100
F1 F4

UN: R\$ 0,40 AV: R\$ 39,93 15: R\$ 40,76
30: R\$ 41,57 45: R\$ 42,40 60: R\$ 43,25



ENVELOPE VIS 80GR AZUL BA 72X108MM 100X1
Código: Fábrica: Unidade:
43827 SCRITY CE/100
F1 F4

UN: R\$ 0,40 AV: R\$ 19,96 15: R\$ 20,37
30: R\$ 20,78 45: R\$ 21,20 60: R\$ 21,62



ENVELOPE VIS 80GR AZUL ESC 75X115MM 50X1
Código: Fábrica: Unidade:
44667 AGAPE PT/50
F1 F4

UN: R\$ 0,40 AV: R\$ 39,93 15: R\$ 40,76
30: R\$ 41,57 45: R\$ 42,40 60: R\$ 43,25



ENVELOPE VIS 80GR AZUL GR 72X108MM 100X1
Código: Fábrica: Unidade:
43826 SCRITY CE/100
F1 F4

UN: R\$ 0,40 AV: R\$ 39,93 15: R\$ 40,76
30: R\$ 41,57 45: R\$ 42,40 60: R\$ 43,25



ENVELOPE VIS 80GR AZUL 75X115MM 100X1
Código: Fábrica: Unidade:
12191 AGAPE CE/100
F1 F4

UN: R\$ 0,40 AV: R\$ 39,93 15: R\$ 40,76
30: R\$ 41,57 45: R\$ 42,40 60: R\$ 43,25



ENVELOPE VIS 80GR BEGE 78X115MM 100X1
Código: Fábrica: Unidade:
12190 AGAPE CE/100
F1 F4

UN: R\$ 0,40 AV: R\$ 19,96 15: R\$ 20,37
30: R\$ 20,78 45: R\$ 21,20 60: R\$ 21,62



ENVELOPE VIS 80GR LILAS 75X115MM 50X1
Código: Fábrica: Unidade:
35879 AGAPE PT/50
F1 F4

UN: R\$ 0,40 AV: R\$ 39,93 15: R\$ 40,76
30: R\$ 41,57 45: R\$ 42,40 60: R\$ 43,25



ENVELOPE VIS 80GR MARFIM 72X108MM 100X1
Código: Fábrica: Unidade:
43829 SCRITY CE/100
F1 F4

UN: R\$ 0,40 AV: R\$ 39,93 15: R\$ 40,76
30: R\$ 41,57 45: R\$ 42,40 60: R\$ 43,25



ENVELOPE VIS 80GR PRETO L 72X108MM 100X1
Código: Fábrica: Unidade:
43830 SCRITY CE/100
F1 F4

UN: R\$ 0,40 AV: R\$ 19,96 15: R\$ 20,37
30: R\$ 20,78 45: R\$ 21,20 60: R\$ 21,62



ENVELOPE VIS 80GR PRETO 75X115MM 50X1
Código: Fábrica: Unidade:
35880 AGAPE PT/50
F1 F4

UN: R\$ 0,40 AV: R\$ 39,93 15: R\$ 40,76
30: R\$ 41,57 45: R\$ 42,40 60: R\$ 43,25



ENVELOPE VIS 80GR ROSA CA 72X108MM 100X1
Código: Fábrika: Unidade:
12193 SCRITY CE/100
F1 F4

UN: R\$ 0,40 AV: R\$ 39,93 15: R\$ 40,76
30: R\$ 41,57 45: R\$ 42,40 60: R\$ 43,25



ENVELOPE VIS 80GR ROSA CL 78X115MM 100X1
Código: Fábrika: Unidade:
14400 AGAPE CE/100
F1 F4

UN: R\$ 0,40 AV: R\$ 39,93 15: R\$ 40,76
30: R\$ 41,57 45: R\$ 42,40 60: R\$ 43,25



ENVELOPE VIS 80GR ROSA FI 72X108MM 100X1
Código: Fábrika: Unidade:
43831 SCRITY CE/100
F1 F4

UN: R\$ 0,40 AV: R\$ 39,93 15: R\$ 40,76
30: R\$ 41,57 45: R\$ 42,40 60: R\$ 43,25



ENVELOPE VIS 80GR ROSA 75X115MM 100X1
Código: Fábrika: Unidade:
9139 AGAPE CE/100
F1 F4

UN: R\$ 0,40 AV: R\$ 19,96 15: R\$ 20,37
30: R\$ 20,78 45: R\$ 21,20 60: R\$ 21,62



ENVELOPE VIS 80GR ROSA 75X115MM 50X1
Código: Fábrika: Unidade:
35878 AGAPE PT/50
F1 F4

UN: R\$ 0,40 AV: R\$ 39,93 15: R\$ 40,76
30: R\$ 41,57 45: R\$ 42,40 60: R\$ 43,25



ENVELOPE VIS 80GR VERDE T 72X108MM 100X1
Código: Fábrika: Unidade:
43828 SCRITY CE/100
F1 F4

UN: R\$ 0,40 AV: R\$ 39,93 15: R\$ 40,76
30: R\$ 41,57 45: R\$ 42,40 60: R\$ 43,25



ENVELOPE VIS 80GR VERDE 75X115MM 100X1
Código: Fábrika: Unidade:
35304 AGAPE CE/100
F1 F4

UN: R\$ 0,40 AV: R\$ 39,93 15: R\$ 40,76
30: R\$ 41,57 45: R\$ 42,40 60: R\$ 43,25



ENVELOPE VIS 80GR VERM T 72X108MM 100X1
Código: Fábrika: Unidade:
29596 SCRITY CE/100
F1 F4

UN: R\$ 35,93 AV: R\$ 35,93 15: R\$ 36,68
30: R\$ 37,41 45: R\$ 38,16 60: R\$ 38,93

130cm



ESCALIMETRO 30CM METAL 2008
Código: Fábrika: Unidade:
46743 KAZ UN/1
F1 F4

UN: R\$ 28,45 AV: R\$ 28,45 15: R\$ 29,05
30: R\$ 29,63 45: R\$ 30,22 60: R\$ 30,83

130cm



ESCALIMETRO 30CM PLAST 970107
Código: Fábrika: Unidade:
46745 KAZ UN/1
F1 F4

UN: R\$ 12,63 AV: R\$ 12,63 15: R\$ 12,89
30: R\$ 13,15 45: R\$ 13,41 60: R\$ 13,68

16,4 cm



ESPATULA PLAST ARTIST PINTURA 16,4CM 548
Código: Fábrika: Unidade:
45492 CONDOR UN/1
F1 F4

UN: R\$ 12,74 AV: R\$ 12,74 15: R\$ 13,01
30: R\$ 13,27 45: R\$ 13,53 60: R\$ 13,80

17,2 cm



ESPATULA PLAST ARTIST PINTURA 17,2CM 541
Código: Fábrika: Unidade:
45495 CONDOR UN/1
F1 F4

UN: R\$ 12,74 AV: R\$ 12,74 15: R\$ 13,01
30: R\$ 13,27 45: R\$ 13,53 60: R\$ 13,80

18 cm



ESPATULA PLAST ARTIST PINTURA 18CM 543
Código: Fábrika: Unidade:
45494 CONDOR UN/1
F1 F4

UN: R\$ 14,97 AV: R\$ 14,97 15: R\$ 15,28
30: R\$ 15,58 45: R\$ 15,90 60: R\$ 16,21

21 cm



ESPATULA PLAST ARTIST PINTURA 21CM 545
Código: Fábrika: Unidade:
45493 CONDOR UN/1
F1 F4

UN: R\$ 3,31 AV: R\$ 3,31 15: R\$ 3,38
30: R\$ 3,45 45: R\$ 3,52 60: R\$ 3,59



ESPATULA PLAST 14CM 992 86314
Código: Fábrika: Unidade:
45485 CONDOR UN/1
F1 F4

UN: R\$ 16,12 AV: R\$ 80,62 15: R\$ 82,30
30: R\$ 83,95 45: R\$ 85,63 60: R\$ 87,34

30 cm

26 cm



ESPELHADO AUTOADES HEXAGONOS 30X26CM 6X1
Código: Fábrika: Unidade:
39820 LEO&LEO PT/5
F1 F4

UN: R\$ 0,40 AV: R\$ 39,93 15: R\$ 40,76
30: R\$ 41,57 45: R\$ 42,40 60: R\$ 43,25

12mm
70 folhas

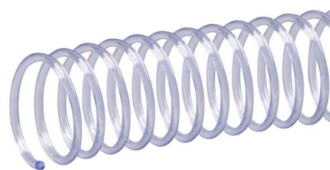

ESPIRAL CRIS 12MM 70 FLS P/ ENCADERNACAO
Código: Fábrica: Unidade:
8999 AFORPLASTIC PT/100
F1 F4

UN: R\$ 0,65 AV: R\$ 64,89 15: R\$ 66,24
30: R\$ 67,56 45: R\$ 68,91 60: R\$ 70,29

17mm
100 folhas

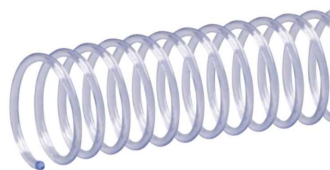

ESPIRAL CRIS 17MM 100 FLS P/ ENCAD 100X1
Código: Fábrica: Unidade:
9001 AFORPLASTIC PT/100
F1 F4

UN: R\$ 0,86 AV: R\$ 59,89 15: R\$ 61,14
30: R\$ 62,36 45: R\$ 63,61 60: R\$ 64,88

20mm
120 folhas

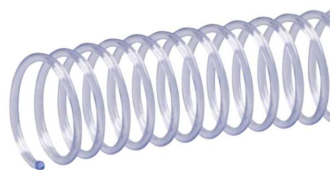

ESPIRAL CRIS 20MM 120 FLS P/ ENCADERNACA
Código: Fábrica: Unidade:
9002 AFROPLASTIC PT/70
F1 F4

UN: R\$ 3,74 AV: R\$ 59,89 15: R\$ 61,14
30: R\$ 62,36 45: R\$ 63,61 60: R\$ 64,88

45mm
450 folhas

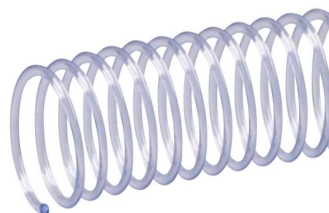

ESPIRAL CRIS 45MM 450 FLS P/ ENCADERNACA
Código: Fábrica: Unidade:
9008 AFORPLASTIC PT/16
F1 F4

UN: R\$ 0,19 AV: R\$ 18,76 15: R\$ 19,15
30: R\$ 19,53 45: R\$ 19,92 60: R\$ 20,32

07mm



ESPIRAL PTO 07 MM 25 FLS P/ ENCAD 100X1
Código: Fábrica: Unidade:
8980 AFORPLASTIC PT/100
F1 F4

UN: R\$ 0,27 AV: R\$ 26,95 15: R\$ 27,51
30: R\$ 28,06 45: R\$ 28,62 60: R\$ 29,19

09 mm



ESPIRAL PTO 09 MM 50 FLS P/ ENCAD 100X1
Código: Fábrica: Unidade:
8981 AFORPLASTIC PT/100
F1 F4

UN: R\$ 0,35 AV: R\$ 34,93 15: R\$ 35,66
30: R\$ 36,38 45: R\$ 37,10 60: R\$ 37,84

12 mm



ESPIRAL PTO 12 MM 70 FLS P/ ENCAD 100X1
Código: Fábrica: Unidade:
8982 AFORPLASTIC PT/100
F1 F4

UN: R\$ 0,40 AV: R\$ 39,93 15: R\$ 40,76
30: R\$ 41,57 45: R\$ 42,40 60: R\$ 43,25



ESPIRAL PTO 14 MM 85 FLS P/ ENCAD 100X1
Código: Fábrica: Unidade:
8983 AFORPLASTIC PT/100
F1 F4

UN: R\$ 0,50 AV: R\$ 49,91 15: R\$ 50,95
30: R\$ 51,97 45: R\$ 53,01 60: R\$ 54,07

17mm



ESPIRAL PTO 17 MM 100 FLS P/ ENCAD 100X1
Código: Fábrica: Unidade:
8984 AFORPLASTIC PT/100
F1 F4

UN: R\$ 0,62 AV: R\$ 49,91 15: R\$ 50,95
30: R\$ 51,97 45: R\$ 53,01 60: R\$ 54,07



ESPIRAL PTO 20 MM 120 FLS P/ ENCAD 80X1
Código: Fábrica: Unidade:
8985 AFORPLASTIC PT/80
F1 F4

UN: R\$ 0,83 AV: R\$ 49,91 15: R\$ 50,95
30: R\$ 51,97 45: R\$ 53,01 60: R\$ 54,07

23mm

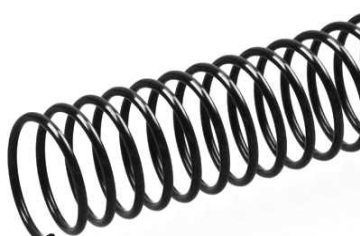

ESPIRAL PTO 23 MM 140 FLS P/ ENCAD 60X1
Código: Fábrica: Unidade:
8986 AFORPLASTIC PT/60
F1 F4

UN: R\$ 1,04 AV: R\$ 49,91 15: R\$ 50,95
30: R\$ 51,97 45: R\$ 53,01 60: R\$ 54,07



ESPIRAL PTO 25 MM 160 FLS P/ ENCAD 48X1
Código: Fábrica: Unidade:
8987 AFORPLASTIC PT/48
F1 F4

UN: R\$ 1,53 AV: R\$ 54,90 15: R\$ 56,05
30: R\$ 57,17 45: R\$ 58,31 60: R\$ 59,48

29mm



ESPIRAL PTO 29 MM 200 FLS P/ ENCAD 36X1
Código: Fábrica: Unidade:
8988 AFORPLASTIC PT/36
F1 F4

UN: R\$ 1,85 AV: R\$ 49,91 15: R\$ 50,95
30: R\$ 51,97 45: R\$ 53,01 60: R\$ 54,07

33mm



ESPIRAL PTO 33 MM 300 FLS P/ ENCAD 27X1
Código: Fábrica: Unidade:
8989 AFORPLASTIC PT/27
F1 F4

UN: R\$ 2,77 AV: R\$ 49,91 15: R\$ 50,95
30: R\$ 51,97 45: R\$ 53,01 60: R\$ 54,07

40mm



ESPIRAL PTO 40 MM 400 FLS P/ ENCAD 18X1
Código: Fábrica: Unidade:
8990 AFORPLASTIC PT/18
F1 F4

UN: R\$ 3,33 AV: R\$ 49,91 15: R\$ 50,95
30: R\$ 51,97 45: R\$ 53,01 60: R\$ 54,07

45mm



ESPIRAL PTO 45 MM 450 FLS P/ ENCAD 15X1
Código: Fábrica: Unidade:
8992 AFORPLASTIC PT/15
F1 F4

UN: R\$ 4,16 AV: R\$ 49,91 15: R\$ 50,95
30: R\$ 51,97 45: R\$ 53,01 60: R\$ 54,07



ESPIRAL PTO 50 MM 500 FLS P/ ENCAD 12X1
Código: Fábrika: Unidade:
8994 AFORPLASTIC PT/12
F1 F4

UN: R\$ 19,96 AV: R\$ 19,96 15: R\$ 20,37
30: R\$ 20,78 45: R\$ 21,20 60: R\$ 21,62

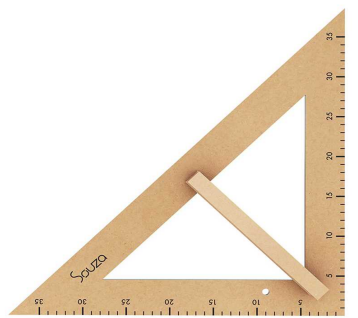

ESQUADRO MDF 45 GRAUS 2934
Código: Fábrika: Unidade:
49903 SOUZA UN/1
F1 F4

UN: R\$ 19,96 AV: R\$ 19,96 15: R\$ 20,37
30: R\$ 20,78 45: R\$ 21,20 60: R\$ 21,62

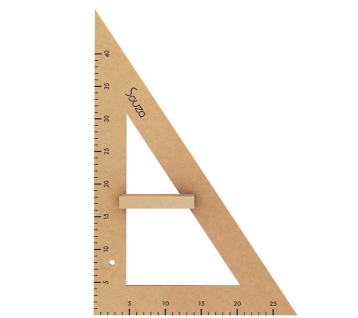

ESQUADRO MDF 60 GRAUS 2936
Código: Fábrika: Unidade:
49902 SOUZA UN/1
F1 F4

UN: R\$ 0,17 AV: R\$ 1,69 15: R\$ 1,72
30: R\$ 1,76 45: R\$ 1,79 60: R\$ 1,83



ESQUADRO 30° FLEXIVEL COLOR 218
Código: Fábrika: Unidade:
44742 WIN PAPER PT/10
F1 F4

UN: R\$ 1,40 AV: R\$ 13,97 15: R\$ 14,26
30: R\$ 14,54 45: R\$ 14,83 60: R\$ 15,13



ESQUADRO 45 GRAUS 10X1
Código: Fábrika: Unidade:
10110 WALEU PT/10
F1 F4

UN: R\$ 1,41 AV: R\$ 14,13 15: R\$ 14,42
30: R\$ 14,71 45: R\$ 15,00 60: R\$ 15,30

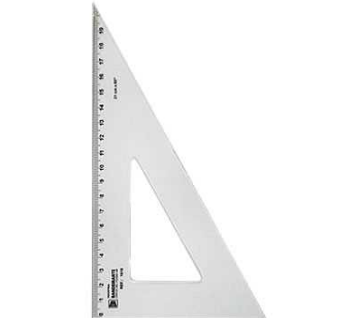

ESQUADRO 60 GRAUS 10X1
Código: Fábrika: Unidade:
23662 WALEU PT/10
F1 F4

UN: R\$ 6,98 AV: R\$ 6,98 15: R\$ 7,12
30: R\$ 7,27 45: R\$ 7,41 60: R\$ 7,56



ESTECAS KIT P/ESCUPIR 7640 8X1
Código: Fábrika: Unidade:
47937 YIN'S PAPER KI/1
F1 F4

UN: R\$ 42,92 AV: R\$ 42,92 15: R\$ 43,82
30: R\$ 44,69 45: R\$ 45,59 60: R\$ 46,50



ESTILETE CORTADOR CIRCUL MANUAL EVA 45MM
Código: Fábrika: Unidade:
48729 LEO&LEO CR/1
F1 F4

UN: R\$ 2,08 AV: R\$ 24,95 15: R\$ 25,47
30: R\$ 25,98 45: R\$ 26,50 60: R\$ 27,03



ESTILETE ESTREITO 9MM COLOR 12X1
Código: Fábrika: Unidade:
39908 FUTURO DZ/12
F1 F4

UN: R\$ 1,21 AV: R\$ 28,94 15: R\$ 29,55
30: R\$ 30,14 45: R\$ 30,74 60: R\$ 31,36



ESTILETE ESTREITO 9MM COLOR 450 24X1
Código: Fábrika: Unidade:
6768 MASTERPRINT CX/24
F1 F4

UN: R\$ 1,50 AV: R\$ 17,96 15: R\$ 18,34
30: R\$ 18,70 45: R\$ 19,08 60: R\$ 19,46



ESTILETE ESTREITO 9MM COLOR 91410 12X1
Código: Fábrika: Unidade:
50666 LEOARTE DZ/12
F1 F4

UN: R\$ 7,58 AV: R\$ 7,58 15: R\$ 7,74
30: R\$ 7,89 45: R\$ 8,05 60: R\$ 8,21



ESTILETE ESTREITO 9MM PLAST EMBOR 91419
Código: Fábrika: Unidade:
42603 JOCAROFFICE UN/1
F1 F4

UN: R\$ 7,48 AV: R\$ 7,48 15: R\$ 7,63
30: R\$ 7,79 45: R\$ 7,94 60: R\$ 8,10



ESTILETE ESTREITO 10MM PLAST EMBOR 5434
Código: Fábrika: Unidade:
43281 MAGAGIFT UN/1
F1 F4

UN: R\$ 8,98 AV: R\$ 8,98 15: R\$ 9,16
30: R\$ 9,35 45: R\$ 9,53 60: R\$ 9,72



ESTILETE LARGO 18MM CB EMBORR CTL 900517
Código: Fábrika: Unidade:
48320 BAZZE CR/1
F1 F4

UN: R\$ 13,47 AV: R\$ 13,47 15: R\$ 13,75
30: R\$ 14,02 45: R\$ 14,30 60: R\$ 14,59



ESTILETE LARGO 18MM CB EMBORRA CTL 1804
Código: Fábrika: Unidade:
23642 BRW UN/1
F1 F4

UN: R\$ 1,66 AV: R\$ 19,96 15: R\$ 20,37
30: R\$ 20,78 45: R\$ 21,20 60: R\$ 21,62



ESTILETE LARGO 18MM COLOR CTL 12X1
Código: Fábrika: Unidade:
44810 FBG DZ/12
F1 F4

UN: R\$ 3,74 AV: R\$ 44,92 15: R\$ 45,85
30: R\$ 46,77 45: R\$ 47,71 60: R\$ 48,66



ESTILETE LARGO 18MM COLOR NA CX 12X1
Código: Fábrika: Unidade:
19317 FUTURO DZ/12
F1 F4

UN: R\$ 21,95 AV: R\$ 21,95 15: R\$ 22,41
30: R\$ 22,86 45: R\$ 23,32 60: R\$ 23,78



ESTILETE LARGO 18MM METAL EMBORR 91421
Código: Fábrika: Unidade:
42592 LEO&LEO UN/1
F1 F4

UN: R\$ 10,70 AV: R\$ 10,70 15: R\$ 10,93
30: R\$ 11,14 45: R\$ 11,37 60: R\$ 11,59



ESTILETE LARGO 18MM PLAST C/5LAMINAS
Código: Fábrika: Unidade:
46746 KAZ CT/1
F1 F4

UN: R\$ 10,47 AV: R\$ 10,47 15: R\$ 10,69
30: R\$ 10,91 45: R\$ 11,12 60: R\$ 11,35



ESTILETE LARGO 18MM PLAST TR GIRAT 1883
Código: Fábrika: Unidade:
46432 KAZ CT/1
F1 F4

UN: R\$ 2,04 AV: R\$ 2,04 15: R\$ 2,08
30: R\$ 2,12 45: R\$ 2,16 60: R\$ 2,21



ESTOJO ESCOLAR LATA CILINDRICO C/APONT 6
Código: Fábrika: Unidade:
15288 ALFA RIO UN/1
F1 F4

UN: R\$ 7,80 AV: R\$ 93,63 15: R\$ 95,58
30: R\$ 97,49 45: R\$ 99,44 60: R\$ 101,43



ESTOJO PLAST MULTIUSO COLOR 190 12X1
Código: Fábrika: Unidade:
37678 MAMITA PT/12
F1 F4

UN: R\$ 0,81 AV: R\$ 9,73 15: R\$ 9,94
30: R\$ 10,14 45: R\$ 10,34 60: R\$ 10,55



ESTRELINHA 2,3 GRS C/FURO COLOR 12X1
Código: Fábrika: Unidade:
46910 GLITTER VMP CT/12
F1 F4

UN: R\$ 0,96 AV: R\$ 11,48 15: R\$ 11,72
30: R\$ 11,96 45: R\$ 12,19 60: R\$ 12,44



ESTRELINHA 3 GR 12X1
Código: Fábrika: Unidade:
15077 CITY BRILHO DZ/12
F1 F4

UN: R\$ 0,13 AV: R\$ 26,41 15: R\$ 26,96
30: R\$ 27,50 45: R\$ 28,05 60: R\$ 28,61



ETIQUETA ADESIV TERMICA 10X15CM 200X1
Código: Fábrika: Unidade:
46981 MASTERPRINT RL/200
F1 F4

UN: R\$ 0,64 AV: R\$ 63,60 15: R\$ 64,92
30: R\$ 66,22 45: R\$ 67,55 60: R\$ 68,90



ETIQUETA ADESIVA A4 BCA 210X297MM 100X1
Código: Fábrika: Unidade:
48111 JUSSARA PT/100
F1 F4

UN: R\$ 0,64 AV: R\$ 63,60 15: R\$ 64,92
30: R\$ 66,22 45: R\$ 67,55 60: R\$ 68,90



ETIQUETA ADESIVA BCA 216X279MM 100X1
Código: Fábrika: Unidade:
48112 JUSSARA PT/100
F1 F4

UN: R\$ 47,92 AV: R\$ 47,92 15: R\$ 48,92
30: R\$ 49,90 45: R\$ 50,90 60: R\$ 51,92

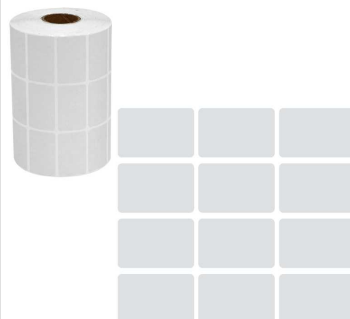

ETIQUETA ADESIVA 33X21X3 30MTS
Código: Fábrika: Unidade:
40124 PRIMUS RL/1
F1 F4

UN: R\$ 0,09 AV: R\$ 8,98 15: R\$ 9,16
30: R\$ 9,35 45: R\$ 9,53 60: R\$ 9,72



ETIQUETA DEC C/AMOR 300 100X1
Código: Fábrika: Unidade:
2903 KARINA RL/100
F1 F4

UN: R\$ 0,09 AV: R\$ 8,98 15: R\$ 9,16
30: R\$ 9,35 45: R\$ 9,53 60: R\$ 9,72



ETIQUETA DEC C/CARINHO DE/PARA 01 100X1
Código: Fábrika: Unidade:
18827 KARINA RL/100
F1 F4

UN: R\$ 0,09 AV: R\$ 8,98 15: R\$ 9,16
30: R\$ 9,35 45: R\$ 9,53 60: R\$ 9,72



ETIQUETA DEC C/CARINHO 435 100X1
Código: Fábrika: Unidade:
18755 KARINA RL/100
F1 F4

UN: R\$ 0,09 AV: R\$ 8,98 15: R\$ 9,16
30: R\$ 9,35 45: R\$ 9,53 60: R\$ 9,72



ETIQUETA DEC C/CARINHO 536 100X1
Código: Fábrika: Unidade:
16057 KARINA RL/100
F1 F4

UN: R\$ 0,09 AV: R\$ 8,98 15: R\$ 9,16
30: R\$ 9,35 45: R\$ 9,53 60: R\$ 9,72



ETIQUETA DEC DE/PARA 503 100X1

Código: Fábrica: Unidade:
16035 KARINA RL/100
F1 F4

UN: R\$ 0,09 AV: R\$ 8,98 15: R\$ 9,16
30: R\$ 9,35 45: R\$ 9,53 60: R\$ 9,72



ETIQUETA DEC FELICIDADES 70 100X1

Código: Fábrica: Unidade:
16052 KARINA RL/100
F1 F4

UN: R\$ 0,09 AV: R\$ 8,98 15: R\$ 9,16
30: R\$ 9,35 45: R\$ 9,53 60: R\$ 9,72



ETIQUETA DEC FELICIDADES DE/PA 256 100X1

Código: Fábrica: Unidade:
16036 KARINA RL/100
F1 F4

UN: R\$ 0,09 AV: R\$ 8,98 15: R\$ 9,16
30: R\$ 9,35 45: R\$ 9,53 60: R\$ 9,72



ETIQUETA DEC FELICIDADES DE/PA 548 100X1

Código: Fábrica: Unidade:
41878 KARINA RL/100
F1 F4

UN: R\$ 0,09 AV: R\$ 8,98 15: R\$ 9,16
30: R\$ 9,35 45: R\$ 9,53 60: R\$ 9,72



ETIQUETA DEC FELICIDADES 005 100X1

Código: Fábrica: Unidade:
14169 KARINA RL/100
F1 F4

UN: R\$ 0,09 AV: R\$ 8,98 15: R\$ 9,16
30: R\$ 9,35 45: R\$ 9,53 60: R\$ 9,72



ETIQUETA DEC FELICIDADES 278 100X1

Código: Fábrica: Unidade:
3094 KARINA RL/100
F1 F4

UN: R\$ 0,09 AV: R\$ 8,98 15: R\$ 9,16
30: R\$ 9,35 45: R\$ 9,53 60: R\$ 9,72



ETIQUETA DEC FELICIDADES 295 100X1

Código: Fábrica: Unidade:
10846 KARINA RL/100
F1 F4

UN: R\$ 0,09 AV: R\$ 8,98 15: R\$ 9,16
30: R\$ 9,35 45: R\$ 9,53 60: R\$ 9,72



ETIQUETA DEC FELICIDADES 585 100X1

Código: Fábrica: Unidade:
16061 KARINA RL/100
F1 F4

UN: R\$ 0,09 AV: R\$ 8,98 15: R\$ 9,16
30: R\$ 9,35 45: R\$ 9,53 60: R\$ 9,72



ETIQUETA DEC FELICIDADES 628 100X1

Código: Fábrica: Unidade:
16026 KARINA RL/100
F1 F4

UN: R\$ 0,09 AV: R\$ 8,98 15: R\$ 9,16
30: R\$ 9,35 45: R\$ 9,53 60: R\$ 9,72



ETIQUETA DEC JESUS TE AMA 08 100X1

Código: Fábrica: Unidade:
30927 KARINA RL/100
F1 F4

UN: R\$ 0,09 AV: R\$ 8,98 15: R\$ 9,16
30: R\$ 9,35 45: R\$ 9,53 60: R\$ 9,72



ETIQUETA DEC MENINHA DE PARA 50 100X1

Código: Fábrica: Unidade:
31887 KARINA RL/100
F1 F4

UN: R\$ 0,09 AV: R\$ 8,98 15: R\$ 9,16
30: R\$ 9,35 45: R\$ 9,53 60: R\$ 9,72



ETIQUETA DEC PARABENS 125 100X1

Código: Fábrica: Unidade:
18819 KARINA RL/100
F1 F4

UN: R\$ 0,09 AV: R\$ 8,98 15: R\$ 9,16
30: R\$ 9,35 45: R\$ 9,53 60: R\$ 9,72

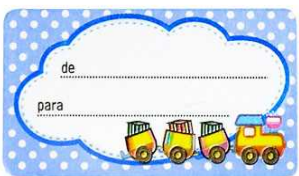

ETIQUETA DEC TRENZINHO DE PARA 95 100X1

Código: Fábrica: Unidade:
31886 KARINA RL/100
F1 F4

UN: R\$ 0,09 AV: R\$ 8,98 15: R\$ 9,16
30: R\$ 9,35 45: R\$ 9,53 60: R\$ 9,72



ETIQUETA DEC URSINHO DE PARA 97 100X1

Código: Fábrica: Unidade:
31888 KARINA RL/100
F1 F4

UN: R\$ 0,12 AV: R\$ 1,49 15: R\$ 1,52
30: R\$ 1,55 45: R\$ 1,58 60: R\$ 1,61



ETIQUETA ESC AUTO ADES 78X35MM VERD 12X1

Código: Fábrica: Unidade:
47934 YIN'S PAPER PT/12
F1 F4

UN: R\$ 0,12 AV: R\$ 1,49 15: R\$ 1,52
30: R\$ 1,55 45: R\$ 1,58 60: R\$ 1,61



ETIQUETA ESC AUTO ADES 78X35MM VERM 2X1

Código: Fábrica: Unidade:
47933 YIN'S PAPER PT/12
F1 F4

UN: R\$ 0,19 AV: R\$ 1,49 15: R\$ 1,52
30: R\$ 1,55 45: R\$ 1,58 60: R\$ 1,61



ETIQUETA ESC AUTO ADES 80X53MM AZUL 8X1
Código: 47931 Fábrica: YIN'S PAPER Unidade: PT/8 F1 F4

UN: R\$ 0,19 AV: R\$ 1,49 15: R\$ 1,52
30: R\$ 1,55 45: R\$ 1,58 60: R\$ 1,61



ETIQUETA ESC AUTO ADES 80X53MM SORT 8X1
Código: 47932 Fábrica: YIN'S PAPER Unidade: PT/8 F1 F4

UN: R\$ 0,07 AV: R\$ 8,46 15: R\$ 8,63
30: R\$ 8,81 45: R\$ 9,98 60: R\$ 9,16



ETIQUETA ESC DEC ATLETICO 6X20
Código: 23310 Fábrica: MINEIRO Unidade: PT/120 F1 F4

UN: R\$ 0,07 AV: R\$ 8,46 15: R\$ 8,63
30: R\$ 8,81 45: R\$ 9,98 60: R\$ 9,16



ETIQUETA ESC DEC BARBIE 6X20
Código: 9471 Fábrica: MINEIRO Unidade: PT/120 F1 F4

UN: R\$ 0,16 AV: R\$ 9,88 15: R\$ 10,09
30: R\$ 10,29 45: R\$ 10,50 60: R\$ 10,71



ETIQUETA ESC DEC CARROS GLITER 6X10
Código: 23302 Fábrica: MINEIRO Unidade: PT/60 F1 F4

UN: R\$ 0,07 AV: R\$ 8,46 15: R\$ 8,63
30: R\$ 8,81 45: R\$ 9,98 60: R\$ 9,16



ETIQUETA ESC DEC CARROSEL 6X20
Código: 15624 Fábrica: MINEIRO Unidade: PT/120 F1 F4

UN: R\$ 0,07 AV: R\$ 8,46 15: R\$ 8,63
30: R\$ 8,81 45: R\$ 9,98 60: R\$ 9,16

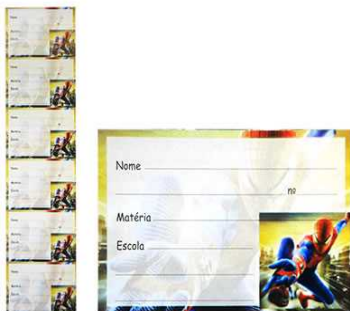

ETIQUETA ESC DEC HOMEM ARANHA 6X20
Código: 23325 Fábrica: MINEIRO Unidade: PT/120 F1 F4

UN: R\$ 0,07 AV: R\$ 8,46 15: R\$ 8,63
30: R\$ 8,81 45: R\$ 9,98 60: R\$ 9,16



ETIQUETA ESC DEC HOT WELLS 6X20
Código: 15623 Fábrica: MINEIRO Unidade: PT/120 F1 F4

UN: R\$ 0,07 AV: R\$ 8,46 15: R\$ 8,63
30: R\$ 8,81 45: R\$ 9,98 60: R\$ 9,16



ETIQUETA ESC DEC JOLIE 6X20
Código: 23312 Fábrica: MINEIRO Unidade: PT/120 F1 F4

UN: R\$ 0,07 AV: R\$ 8,46 15: R\$ 8,63
30: R\$ 8,81 45: R\$ 9,98 60: R\$ 9,16

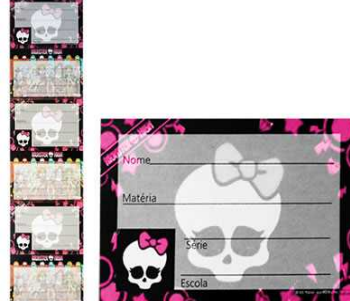

ETIQUETA ESC DEC MONSTER HIGH 6X20
Código: 18816 Fábrica: MINEIRO Unidade: PT/120 F1 F4

UN: R\$ 0,07 AV: R\$ 8,46 15: R\$ 8,63
30: R\$ 8,81 45: R\$ 9,98 60: R\$ 9,16



ETIQUETA ESC DEC MORANGUINHO 6X20
Código: 9475 Fábrica: MINEIRO Unidade: PT/120 F1 F4

UN: R\$ 0,07 AV: R\$ 8,46 15: R\$ 8,63
30: R\$ 8,81 45: R\$ 9,98 60: R\$ 9,16



ETIQUETA ESC DEC PATATI PATATA 6X20
Código: 23322 Fábrica: MINEIRO Unidade: PT/120 F1 F4

UN: R\$ 0,07 AV: R\$ 8,46 15: R\$ 8,63
30: R\$ 8,81 45: R\$ 9,98 60: R\$ 9,16



ETIQUETA ESC DEC PICA PAU 6X20
Código: 23308 Fábrica: MINEIRO Unidade: PT/120 F1 F4

UN: R\$ 0,07 AV: R\$ 8,46 15: R\$ 8,63
30: R\$ 8,81 45: R\$ 9,98 60: R\$ 9,16



ETIQUETA ESC DEC PUCCA 6X20
Código: 9476 Fábrica: MINEIRO Unidade: PT/120 F1 F4

UN: R\$ 0,07 AV: R\$ 8,46 15: R\$ 8,63
30: R\$ 8,81 45: R\$ 9,98 60: R\$ 9,16

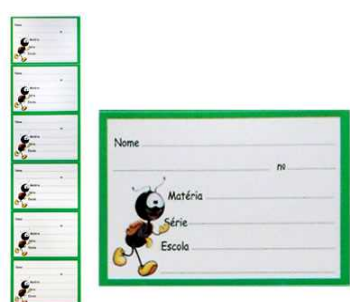

ETIQUETA ESC DEC SMILINGUIDO 6X20
Código: 9468 Fábrica: MINEIRO Unidade: PT/120 F1 F4

UN: R\$ 0,06 AV: R\$ 6,89 15: R\$ 7,03
30: R\$ 7,17 45: R\$ 7,32 60: R\$ 7,46

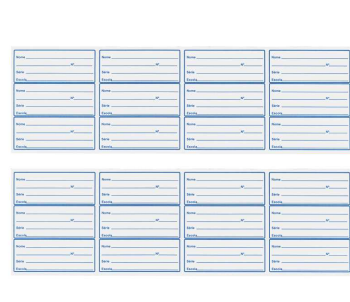

ETIQUETA ESC SIMPLES 12X10
Código: 26789 Fábrica: MIN Unidade: PT/120 F1 F4

UN: R\$ 2,00 AV: R\$ 19,96 15: R\$ 20,37
30: R\$ 20,78 45: R\$ 21,20 60: R\$ 21,62



ETIQUETA ETIQUETADORA BRANCO 10X500

Código: Fábrika: Unidade:
49563 ALIANCA RL/10
F1 F4

UN: R\$ 1,53 AV: R\$ 15,33 15: R\$ 15,64
30: R\$ 15,96 45: R\$ 16,28 60: R\$ 16,60



ETIQUETA ETIQUETADORA BRANCO 3551 10X300

Código: Fábrika: Unidade:
36331 WINMAX RL/10
F1 F4

UN: R\$ 2,30 AV: R\$ 22,95 15: R\$ 23,43
30: R\$ 23,90 45: R\$ 24,38 60: R\$ 24,87



ETIQUETA ETIQUETADORA BRANCO 3552 10X500

Código: Fábrika: Unidade:
16058 WINMAX RL/10
F1 F4

UN: R\$ 2,63 AV: R\$ 26,26 15: R\$ 26,81
30: R\$ 27,34 45: R\$ 27,89 60: R\$ 28,45



ETIQUETA ETIQUETADORA BRANCO 3553 10X700

Código: Fábrika: Unidade:
49626 WINMAX RL/10
F1 F4

UN: R\$ 3,06 AV: R\$ 30,62 15: R\$ 31,26
30: R\$ 31,88 45: R\$ 32,52 60: R\$ 33,17



ETIQUETA ETIQUETADORA BRANCO 554 10X1000

Código: Fábrika: Unidade:
49625 WINMAX RL/10
F1 F4

UN: R\$ 34,93 AV: R\$ 34,93 15: R\$ 35,66
30: R\$ 36,38 45: R\$ 37,10 60: R\$ 37,84



ETIQUETA ETIQUETADORA 10328 10X1000

Código: Fábrika: Unidade:
22743 LETRON RL/1
F1 F4

UN: R\$ 0,04 AV: R\$ 8,98 15: R\$ 9,16
30: R\$ 9,35 45: R\$ 9,53 60: R\$ 9,72



ETIQUETA OVAL P/CONVITE OURO 133 200X1

Código: Fábrika: Unidade:
16047 KARINA RL/200
F1 F4

UN: R\$ 0,04 AV: R\$ 8,98 15: R\$ 9,16
30: R\$ 9,35 45: R\$ 9,53 60: R\$ 9,72



ETIQUETA OVAL P/CONVITE PRATA 134 200X1

Código: Fábrika: Unidade:
16048 KARINA RL/200
F1 F4

UN: R\$ 0,67 AV: R\$ 6,74 15: R\$ 6,88
30: R\$ 7,02 45: R\$ 7,16 60: R\$ 7,30



ETIQUETA PRECO N 1 22X15MM C/REF10X66UN

Código: Fábrika: Unidade:
37775 CARVALHO RL/10
F1 F4

UN: R\$ 0,67 AV: R\$ 6,74 15: R\$ 6,88
30: R\$ 7,02 45: R\$ 7,16 60: R\$ 7,30



ETIQUETA PRECO N 2 22X15MM 10X80UN

Código: Fábrika: Unidade:
5865 FERREIRA RL/10
F1 F4

UN: R\$ 0,67 AV: R\$ 6,74 15: R\$ 6,88
30: R\$ 7,02 45: R\$ 7,16 60: R\$ 7,30



ETIQUETA PRECO N 3 10X20MM 10X100UN

Código: Fábrika: Unidade:
8355 CARVALHO RL/10
F1 F4

UN: R\$ 0,67 AV: R\$ 6,74 15: R\$ 6,88
30: R\$ 7,02 45: R\$ 7,16 60: R\$ 7,30



ETIQUETA PRECO N 3 19X10MM 10X120UN

Código: Fábrika: Unidade:
22738 FERREIRA RL/10
F1 F4

UN: R\$ 0,68 AV: R\$ 6,78 15: R\$ 6,92
30: R\$ 7,06 45: R\$ 7,20 60: R\$ 7,34



ETIQUETA PRECO N 4 22X12MM 10X100UN

Código: Fábrika: Unidade:
10294 FERREIRA RL/10
F1 F4

UN: R\$ 0,68 AV: R\$ 6,78 15: R\$ 6,92
30: R\$ 7,06 45: R\$ 7,20 60: R\$ 7,34



ETIQUETA PRECO N 5 19X40MM 10X30UN

Código: Fábrika: Unidade:
8358 FERREIRA RL/10
F1 F4

UN: R\$ 1,69 AV: R\$ 6,74 15: R\$ 6,88
30: R\$ 7,02 45: R\$ 7,16 60: R\$ 7,30



ETIQUETA PRECO N 6 50X30MM 4X40UN

Código: Fábrika: Unidade:
22737 FERREIRA RL/4
F1 F4

UN: R\$ 0,22 AV: R\$ 6,74 15: R\$ 6,88
30: R\$ 7,02 45: R\$ 7,16 60: R\$ 7,30



ETIQUETA PRECO N 7 76X40MM 3X30UN

Código: Fábrika: Unidade:
50097 FERREIRA PT/30
F1 F4

UN: R\$ 0,67 AV: R\$ 6,74 15: R\$ 6,88
30: R\$ 7,02 45: R\$ 7,16 60: R\$ 7,30



ETIQUETA PRECO N 8 19X30MM 10X40UN
Código: Fábrika: Unidade:
8357 FERREIRA RL/10
F1 F4

UN: R\$ 0,67 AV: R\$ 6,74 15: R\$ 6,88
30: R\$ 7,02 45: R\$ 7,16 60: R\$ 7,30



ETIQUETA PRECO N 9 29X15MM 8X80UN
Código: Fábrika: Unidade:
37684 FERREIRA RL/10
F1 F4

UN: R\$ 1,69 AV: R\$ 6,74 15: R\$ 6,88
30: R\$ 7,02 45: R\$ 7,16 60: R\$ 7,30

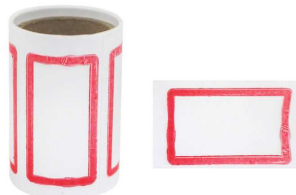

ETIQUETA PRECO N 11 43X25MM 4X40UN
Código: Fábrika: Unidade:
37778 CARVALHO RL/4
F1 F4

UN: R\$ 10,48 AV: R\$ 20,96 15: R\$ 21,39
30: R\$ 21,82 45: R\$ 22,26 60: R\$ 22,70



ETIQUETA PRECO N 15 60X40MM 2X250UN
Código: Fábrika: Unidade:
37686 FERREIRA RL/2
F1 F4

UN: R\$ 4,62 AV: R\$ 18,47 15: R\$ 18,86
30: R\$ 19,23 45: R\$ 19,62 60: R\$ 20,01



ETIQUETA PRECO 30MMX5MTS 2124 4X312UN
Código: Fábrika: Unidade:
37422 ADERE RL/4
F1 F4

UN: R\$ 0,01 AV: R\$ 3,08 15: R\$ 3,14
30: R\$ 3,20 45: R\$ 3,27 60: R\$ 3,33

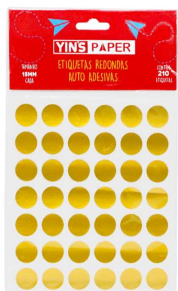

ETIQUETA RED AUTO ADESIV 15MM OURO 210X1
Código: Fábrika: Unidade:
46940 YIN'S PAPER PT/210
F1 F4

UN: R\$ 0,01 AV: R\$ 2,59 15: R\$ 2,64
30: R\$ 2,69 45: R\$ 2,75 60: R\$ 2,80



ETIQUETA RED AUTO ADESIV 15MM SORT 210X1
Código: Fábrika: Unidade:
42813 YIN'S PAPER PT/210
F1 F4

UN: R\$ 0,03 AV: R\$ 8,98 15: R\$ 9,16
30: R\$ 9,35 45: R\$ 9,53 60: R\$ 9,72

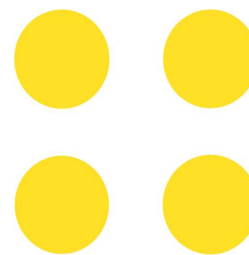

ETIQUETA RED P/CONVITE AMARELO 79 300X1
Código: Fábrika: Unidade:
16042 KARINA RL/300
F1 F4

UN: R\$ 0,03 AV: R\$ 8,98 15: R\$ 9,16
30: R\$ 9,35 45: R\$ 9,53 60: R\$ 9,72



ETIQUETA RED P/CONVITE AZUL 77 300X1
Código: Fábrika: Unidade:
16044 KARINA RL/300
F1 F4

UN: R\$ 0,04 AV: R\$ 8,98 15: R\$ 9,16
30: R\$ 9,35 45: R\$ 9,53 60: R\$ 9,72

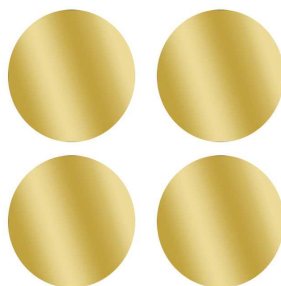

ETIQUETA RED P/CONVITE OURO 27 200X1
Código: Fábrika: Unidade:
35852 KARINA RL/200
F1 F4

UN: R\$ 8,98 AV: R\$ 8,98 15: R\$ 9,16
30: R\$ 9,35 45: R\$ 9,53 60: R\$ 9,72

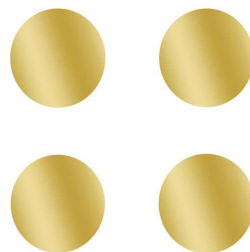

ETIQUETA RED P/CONVITE OURO 96 300X1
Código: Fábrika: Unidade:
6727 KARINA RL/1
F1 F4

UN: R\$ 0,03 AV: R\$ 8,98 15: R\$ 9,16
30: R\$ 9,35 45: R\$ 9,53 60: R\$ 9,72

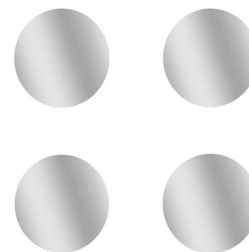

ETIQUETA RED P/CONVITE PRATA 101 300X1
Código: Fábrika: Unidade:
6728 KARINA RL/300
F1 F4

UN: R\$ 0,04 AV: R\$ 8,98 15: R\$ 9,16
30: R\$ 9,35 45: R\$ 9,53 60: R\$ 9,72

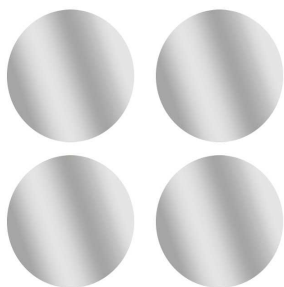

ETIQUETA RED P/CONVITE PRATA 153 200X1
Código: Fábrika: Unidade:
47148 KARINA RL/200
F1 F4

UN: R\$ 0,03 AV: R\$ 8,98 15: R\$ 9,16
30: R\$ 9,35 45: R\$ 9,53 60: R\$ 9,72

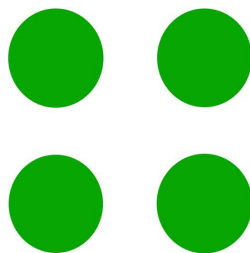

ETIQUETA RED P/CONVITE VERDE 78 300X1
Código: Fábrika: Unidade:
16040 KARINA RL/300
F1 F4

UN: R\$ 0,03 AV: R\$ 8,98 15: R\$ 9,16
30: R\$ 9,35 45: R\$ 9,53 60: R\$ 9,72

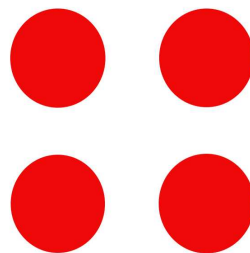

ETIQUETA RED P/CONVITE VERMELHO 76 300X1
Código: Fábrika: Unidade:
16041 KARINA RL/300
F1 F4

UN: R\$ 2,06 AV: R\$ 24,74 15: R\$ 25,26
30: R\$ 25,76 45: R\$ 26,28 60: R\$ 26,80



EXTRATOR GRAMPO METAL CROM 109 12X1
Código: Fábrika: Unidade:
26146 MASTERPRINT DZ/12
F1 F4

UN: R\$ 2,34 AV: R\$ 2,34 15: R\$ 2,38
30: R\$ 2,43 45: R\$ 2,48 60: R\$ 2,53



EXTRATOR GRAMPO METAL GALVANIZ 93050 UN
Código: Fábrica: Unidade:
46519 JOCAROFFICE UN/1
F1 F4

UN: R\$ 3,49 AV: R\$ 3,49 15: R\$ 3,57
30: R\$ 3,64 45: R\$ 3,71 60: R\$ 3,79



EXTRATOR GRAMPO PIRANHA
Código: Fábrica: Unidade:
41715 WIN PAPER UN/1
F1 F4

UN: R\$ 4,05 AV: R\$ 4,05 15: R\$ 4,14
30: R\$ 4,22 45: R\$ 4,31 60: R\$ 4,39



EXTRATOR GRAMPO PIRANHA 24/6 26/6 7138
Código: Fábrica: Unidade:
42812 YIN'S PAPER UN/1
F1 F4

UN: R\$ 1,89 AV: R\$ 22,72 15: R\$ 23,20
30: R\$ 23,66 45: R\$ 24,13 60: R\$ 24,62



EXTRATOR GRAMPO ZINCADO 176 12X1
Código: Fábrica: Unidade:
10459 CARBRINK DZ/12
F1 F4

UN: R\$ 99,83 AV: R\$ 99,83 15: R\$ 101,91
30: R\$ 103,95 45: R\$ 106,03 60: R\$ 108,15



FELTRO EST 140CMX2,5MX200G COMPOSE MAGAL
Código: Fábrica: Unidade:
41987 SANTA FE RL/1
F1 F4

UN: R\$ 39,93 AV: R\$ 99,83 15: R\$ 101,91
30: R\$ 103,95 45: R\$ 106,03 60: R\$ 108,15

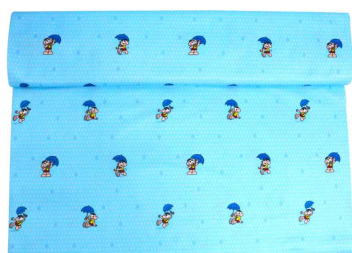

FELTRO EST 140CMX2,5MX200GR CASCAO CHUVA
Código: Fábrica: Unidade:
41992 SANTA FE RL/2,5
F1 F4

UN: R\$ 39,93 AV: R\$ 99,83 15: R\$ 101,91
30: R\$ 103,95 45: R\$ 106,03 60: R\$ 108,15

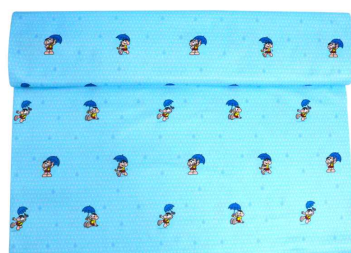

FELTRO EST 140CMX2,5MX200GR CASCAO GUARD
Código: Fábrica: Unidade:
41993 SANTA FE RL/2,5
F1 F4

UN: R\$ 39,93 AV: R\$ 99,83 15: R\$ 101,91
30: R\$ 103,95 45: R\$ 106,03 60: R\$ 108,15



FELTRO EST 140CMX2,5MX200GR CHIC/ ROSINH
Código: Fábrica: Unidade:
42007 SANTA FE RL/2,5
F1 F4

UN: R\$ 39,93 AV: R\$ 99,83 15: R\$ 101,91
30: R\$ 103,95 45: R\$ 106,03 60: R\$ 108,15



FELTRO EST 140CMX2,5MX200GR CHICO B GOIA
Código: Fábrica: Unidade:
41989 SANTA FE RL/2,5
F1 F4

UN: R\$ 39,93 AV: R\$ 99,83 15: R\$ 101,91
30: R\$ 103,95 45: R\$ 106,03 60: R\$ 108,15



FELTRO EST 140CMX2,5MX200GR MAGALI
Código: Fábrica: Unidade:
41986 SANTA FE RL/2,5
F1 F4

UN: R\$ 39,93 AV: R\$ 99,83 15: R\$ 101,91
30: R\$ 103,95 45: R\$ 106,03 60: R\$ 108,15

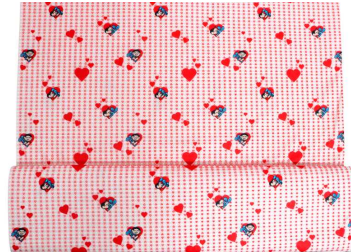

FELTRO EST 140CMX2,5MX200GR MONICA CORAC
Código: Fábrica: Unidade:
41990 SANTA FE RL/2,5
F1 F4

UN: R\$ 39,93 AV: R\$ 99,83 15: R\$ 101,91
30: R\$ 103,95 45: R\$ 106,03 60: R\$ 108,15



FELTRO EST 140CMX2,5MX200GR MONICA SANSA
Código: Fábrica: Unidade:
41997 SANTA FE RL/2,5
F1 F4

UN: R\$ 39,93 AV: R\$ 99,83 15: R\$ 101,91
30: R\$ 103,95 45: R\$ 106,03 60: R\$ 108,15



FELTRO EST 140CMX2,5MX200GR QUADRINHOS
Código: Fábrica: Unidade:
41991 SANTA FE RL/2,5
F1 F4

UN: R\$ 39,93 AV: R\$ 99,83 15: R\$ 101,91
30: R\$ 103,95 45: R\$ 106,03 60: R\$ 108,15



FELTRO EST 140CMX2,5MX200GR SANSAO
Código: Fábrica: Unidade:
41995 SANTA FE RL/2,5
F1 F4

UN: R\$ 197,68 AV: R\$ 197,68 15: R\$ 201,80
30: R\$ 205,84 45: R\$ 209,95 60: R\$ 214,15

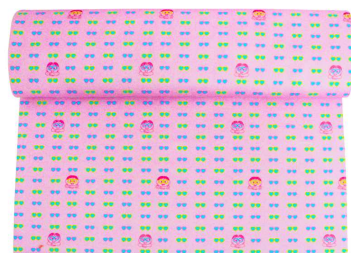

FELTRO EST 140CMX4 CORES 10 T MONICA
Código: Fábrica: Unidade:
41988 SANTA FE RL/1
F1 F4

UN: R\$ 199,67 AV: R\$ 199,67 15: R\$ 203,83
30: R\$ 207,91 45: R\$ 212,06 60: R\$ 216,31

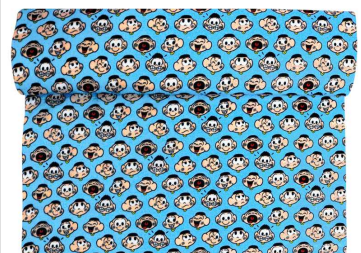

FELTRO EST 140CMX5MX200GR CASCAO
Código: Fábrica: Unidade:
41996 SANTA FE RL/1
F1 F4

UN: R\$ 199,67 AV: R\$ 199,67 15: R\$ 203,83
30: R\$ 207,91 45: R\$ 212,06 60: R\$ 216,31



FELTRO EST 140CMX5MX200GR MAGALI LISTRAS

Código: 41994 Fábrica: SANTA FE Unidade: RL/1 F1 F4

UN: R\$ 269,56 AV: R\$ 269,56 15: R\$ 275,17
30: R\$ 280,68 45: R\$ 286,29 60: R\$ 292,02



FELTRO LISO 140CMX10MX200GR AMARELO CITR

Código: 42006 Fábrica: SANTA FE Unidade: RL/1 F1 F4

UN: R\$ 269,56 AV: R\$ 269,56 15: R\$ 275,17
30: R\$ 280,68 45: R\$ 286,29 60: R\$ 292,02



FELTRO LISO 140CMX10MX200GR AZUL CLARO

Código: 41998 Fábrica: SANTA FE Unidade: RL/1 F1 F4

UN: R\$ 269,56 AV: R\$ 269,56 15: R\$ 275,17
30: R\$ 280,68 45: R\$ 286,29 60: R\$ 292,02

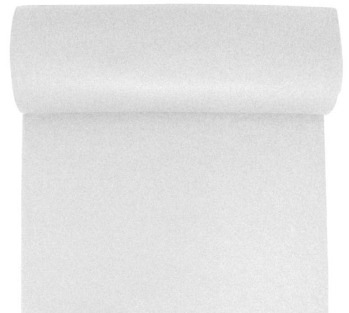

FELTRO LISO 140CMX10MX200GR BRANCO

Código: 42002 Fábrica: SANTA FE Unidade: RL/1 F1 F4

UN: R\$ 269,56 AV: R\$ 269,56 15: R\$ 275,17
30: R\$ 280,68 45: R\$ 286,29 60: R\$ 292,02



FELTRO LISO 140CMX10MX200GR LARANJA

Código: 42000 Fábrica: SANTA FE Unidade: RL/1 F1 F4

UN: R\$ 269,56 AV: R\$ 269,56 15: R\$ 275,17
30: R\$ 280,68 45: R\$ 286,29 60: R\$ 292,02



FELTRO LISO 140CMX10MX200GR MARROM

Código: 42001 Fábrica: SANTA FE Unidade: RL/1 F1 F4

UN: R\$ 269,56 AV: R\$ 269,56 15: R\$ 275,17
30: R\$ 280,68 45: R\$ 286,29 60: R\$ 292,02



FELTRO LISO 140CMX10MX200GR NUDE

Código: 42003 Fábrica: SANTA FE Unidade: RL/1 F1 F4

UN: R\$ 269,56 AV: R\$ 269,56 15: R\$ 275,17
30: R\$ 280,68 45: R\$ 286,29 60: R\$ 292,02



FELTRO LISO 140CMX10MX200GR ROSA NASCENT

Código: 42004 Fábrica: SANTA FE Unidade: RL/1 F1 F4

UN: R\$ 269,56 AV: R\$ 269,56 15: R\$ 275,17
30: R\$ 280,68 45: R\$ 286,29 60: R\$ 292,02



FELTRO LISO 140CMX10MX200GR VERDE BILHAR

Código: 47836 Fábrica: SANTA FE Unidade: RL/1 F1 F4

UN: R\$ 0,07 AV: R\$ 7,39 15: R\$ 7,54
30: R\$ 7,69 45: R\$ 7,85 60: R\$ 8,00



FICHA CONTAS CORRENTES 5X8 6127-5 100X1

Código: 28593 Fábrica: SAO DOMINGOS Unidade: CE/100 F1 F4

UN: R\$ 0,07 AV: R\$ 6,98 15: R\$ 7,12
30: R\$ 7,27 45: R\$ 7,41 60: R\$ 7,56

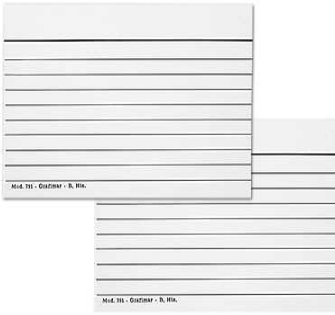

FICHA PAUTADA 3"X5" 100X1

Código: 17973 Fábrica: PARKKE Unidade: PT/100 F1 F4

UN: R\$ 0,12 AV: R\$ 11,63 15: R\$ 11,87
30: R\$ 12,11 45: R\$ 12,35 60: R\$ 12,60



FICHA PAUTADA 4"X6" 100X1

Código: 17974 Fábrica: PARRKE Unidade: PT/100 F1 F4

UN: R\$ 0,18 AV: R\$ 17,72 15: R\$ 18,09
30: R\$ 18,45 45: R\$ 18,82 60: R\$ 19,20



FICHA PAUTADA 5"X8" 100X1

Código: 17975 Fábrica: PARKKE Unidade: PT/100 F1 F4

UN: R\$ 0,20 AV: R\$ 19,96 15: R\$ 20,37
30: R\$ 20,78 45: R\$ 21,20 60: R\$ 21,62



FICHA PAUTADA 6"X9" 100X1

Código: 14426 Fábrica: GRIFFE Unidade: PT/100 F1 F4

UN: R\$ 19,96 AV: R\$ 19,96 15: R\$ 20,37
30: R\$ 20,78 45: R\$ 21,20 60: R\$ 21,62



FICHARIO COMPLETO MICKEY/MINNIE

Código: 13395 Fábrica: TILIBRA Unidade: UN/1 F1 F4

UN: R\$ 149,75 AV: R\$ 149,75 15: R\$ 152,87
30: R\$ 155,93 45: R\$ 159,05 60: R\$ 162,23



FICHARIO P/FICHAS 4"X6" C/INDICE 922

Código: 31474 Fábrica: ACRIMET Unidade: UN/1 F1 F4

UN: R\$ 249,59 AV: R\$ 249,59 15: R\$ 254,79
30: R\$ 259,89 45: R\$ 265,08 60: R\$ 270,39



FICHARIO P/FICHAS 6''X9'' C/ÍNDICE M74
Código: Fábrika: Unidade:
43534 MENNO UN/1
F1 F4

UN: R\$ 19,96 AV: R\$ 19,96 15: R\$ 20,37
30: R\$ 20,78 45: R\$ 21,20 60: R\$ 21,62



FICHARIO TRANSPARENTE
Código: Fábrika: Unidade:
12566 ACP UN/1
F1 F4

UN: R\$ 19,96 AV: R\$ 19,96 15: R\$ 20,37
30: R\$ 20,78 45: R\$ 21,20 60: R\$ 21,62



FICHARIO UNIVERS OLYMPIC-SCRAPBOOK 316/A
Código: Fábrika: Unidade:
3756 ACP UN/1
F1 F4

UN: R\$ 19,96 AV: R\$ 19,96 15: R\$ 20,37
30: R\$ 20,78 45: R\$ 21,20 60: R\$ 21,62

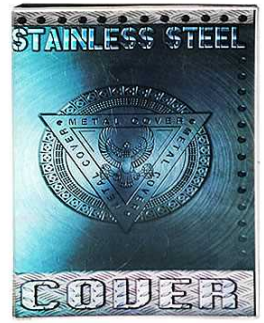

FICHARIO UNIVERS RUSTY STE TEXTURE 316 D
Código: Fábrika: Unidade:
10071 ACP UN/1
F1 F4

UN: R\$ 19,96 AV: R\$ 19,96 15: R\$ 20,37
30: R\$ 20,78 45: R\$ 21,20 60: R\$ 21,62

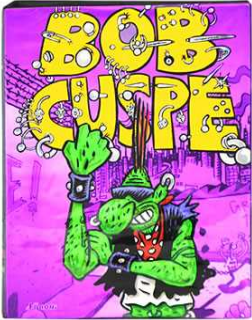

FICHARIO UNIVERSITARIO ANGELI 4089 SKRO
Código: Fábrika: Unidade:
19338 FORONI UN/1
F1 F4

UN: R\$ 19,96 AV: R\$ 19,96 15: R\$ 20,37
30: R\$ 20,78 45: R\$ 21,20 60: R\$ 21,62

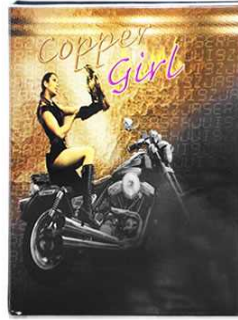

FICHARIO UNIVERSITARIO GIRL 316C
Código: Fábrika: Unidade:
19335 ACP UN/1
F1 F4

UN: R\$ 19,96 AV: R\$ 19,96 15: R\$ 20,37
30: R\$ 20,78 45: R\$ 21,20 60: R\$ 21,62



FICHARIO UNIVERSITARIO JEANS FASHION316B
Código: Fábrika: Unidade:
19334 ACP UN/1
F1 F4

UN: R\$ 29,94 AV: R\$ 29,94 15: R\$ 30,57
30: R\$ 31,18 45: R\$ 31,80 60: R\$ 32,44



FICHARIO UNIVERSITARIO 4 ARGOL PRETO 316
Código: Fábrika: Unidade:
19337 ACP UN/1
F1 F4

UN: R\$ 24,15 AV: R\$ 24,15 15: R\$ 24,65
30: R\$ 25,15 45: R\$ 25,65 60: R\$ 26,16



FICHARIO 2 ARGOLAS
Código: Fábrika: Unidade:
45965 ACP UN/1
F1 F4

UN: R\$ 19,96 AV: R\$ 19,96 15: R\$ 20,37
30: R\$ 20,78 45: R\$ 21,20 60: R\$ 21,62



FICHARIO 4 ARGOLAS
Código: Fábrika: Unidade:
6424 LOMY UN/1
F1 F4

UN: R\$ 5,24 AV: R\$ 5,24 15: R\$ 5,35
30: R\$ 5,46 45: R\$ 5,57 60: R\$ 5,68

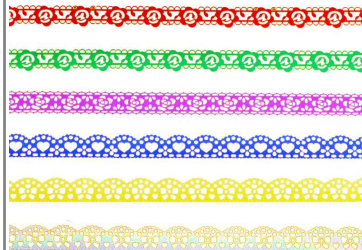

FITA ADES DECORATIVA 1,8CMX100MM 20135
Código: Fábrika: Unidade:
45944 WIN PAPER RL/1
F1 F4

UN: R\$ 6,49 AV: R\$ 6,49 15: R\$ 6,62
30: R\$ 6,76 45: R\$ 6,89 60: R\$ 7,03



FITA ADES MINI DEC BRILHANTE C/SUP 9X1
Código: Fábrika: Unidade:
34793 AGUIA BRANCA CR/1
F1 F4

UN: R\$ 1,46 AV: R\$ 7,28 15: R\$ 7,43
30: R\$ 7,58 45: R\$ 7,73 60: R\$ 7,88



FITA ADES PEQ DECORAD 15MMX2,6MTS 5X1
Código: Fábrika: Unidade:
42803 INTERPOTENTE PT/5
F1 F4

UN: R\$ 2,00 AV: R\$ 11,97 15: R\$ 12,22
30: R\$ 12,46 45: R\$ 12,71 60: R\$ 12,97



FITA ADES WASHI 15MMX3M GOLD 234 6X1
Código: Fábrika: Unidade:
40276 LYKE CR/6
F1 F4

UN: R\$ 1,10 AV: R\$ 10,97 15: R\$ 11,20
30: R\$ 11,43 45: R\$ 11,65 60: R\$ 11,89



FITA ADES 12MMX10 MTS AZUL 10X1
Código: Fábrika: Unidade:
6202 FITPEL/ADELB PT/10
F1 F4

UN: R\$ 1,10 AV: R\$ 10,97 15: R\$ 11,20
30: R\$ 11,43 45: R\$ 11,65 60: R\$ 11,89



FITA ADES 12MMX10 MTS BRANCO 10X1
Código: Fábrika: Unidade:
6204 FIT-PEL PT/10
F1 F4

UN: R\$ 1,10 AV: R\$ 10,97 15: R\$ 11,20
30: R\$ 11,43 45: R\$ 11,65 60: R\$ 11,89



FITA ADES 12MMX10MTS LARANJA 10X1
Código: 15564 Fábrica: FIT-PEL Unidade: PT/10 F1 F4

UN: R\$ 1,10 AV: R\$ 10,97 15: R\$ 11,20
30: R\$ 11,43 45: R\$ 11,65 60: R\$ 11,89



FITA ADES 12MMX10MTS LILAS 10X1
Código: 35944 Fábrica: FIT-PEL Unidade: PT/10 F1 F4

UN: R\$ 1,10 AV: R\$ 10,97 15: R\$ 11,20
30: R\$ 11,43 45: R\$ 11,65 60: R\$ 11,89



FITA ADES 12MMX10MTS PRATA 10X1
Código: 6544 Fábrica: FIT-PEL Unidade: PT/10 F1 F4

UN: R\$ 1,05 AV: R\$ 10,47 15: R\$ 10,69
30: R\$ 10,91 45: R\$ 11,12 60: R\$ 11,35



FITA ADES 12MMX10MTS ROSA 10X1
Código: 15565 Fábrica: FITPEL/ADELB Unidade: PT/10 F1 F4

UN: R\$ 1,16 AV: R\$ 83,20 15: R\$ 84,93
30: R\$ 86,63 45: R\$ 88,36 60: R\$ 90,13



FITA ADES 12MMX10MTS SORT POTE 72X1
Código: 46830 Fábrica: BRW Unidade: CJ/72 F1 F4

UN: R\$ 0,75 AV: R\$ 7,48 15: R\$ 7,63
30: R\$ 7,79 45: R\$ 7,94 60: R\$ 8,10



FITA ADES 12MMX10MTS TRANSPARENT 10X1
Código: 356 Fábrica: FIT-PEL Unidade: PT/10 F1 F4

UN: R\$ 1,10 AV: R\$ 10,97 15: R\$ 11,20
30: R\$ 11,43 45: R\$ 11,65 60: R\$ 11,89



FITA ADES 12MMX10MTS VERDE 10X1
Código: 6203 Fábrica: FIT-PEL Unidade: PT/10 F1 F4

UN: R\$ 1,10 AV: R\$ 10,97 15: R\$ 11,20
30: R\$ 11,43 45: R\$ 11,65 60: R\$ 11,89



FITA ADES 12MMX10MTS VERMELHO 10X1
Código: 358 Fábrica: FITPEL/ADELB Unidade: PT/10 F1 F4

UN: R\$ 2,49 AV: R\$ 9,97 15: R\$ 10,18
30: R\$ 10,39 45: R\$ 10,59 60: R\$ 10,81



FITA ADES 12MMX18MTS METALI SORT 12X1
Código: 34679 Fábrica: HAI BRASIL Unidade: PT/4 F1 F4

UN: R\$ 0,89 AV: R\$ 8,94 15: R\$ 8,94
30: R\$ 8,94 45: R\$ 8,94 60: R\$ 8,94



FITA ADES 12MMX20MTS TRANSPARENT 10X1
Código: 2984 Fábrica: FIT-PEL Unidade: PT/10 F1 F4

UN: R\$ 1,40 AV: R\$ 13,97 15: R\$ 14,26
30: R\$ 14,54 45: R\$ 14,83 60: R\$ 15,13



FITA ADES 12MMX30MTS TRANSP 7495 10X1
Código: 5827 Fábrica: YINS/KORETCH Unidade: PT/10 F1 F4

UN: R\$ 2,00 AV: R\$ 19,96 15: R\$ 20,37
30: R\$ 20,78 45: R\$ 21,20 60: R\$ 21,62



FITA ADES 12MMX33MTS AMARELO FLU 10X1
Código: 31539 Fábrica: FIT-PEL Unidade: PT/10 F1 F4

UN: R\$ 2,00 AV: R\$ 19,96 15: R\$ 20,37
30: R\$ 20,78 45: R\$ 21,20 60: R\$ 21,62



FITA ADES 12MMX33MTS AMARELO 10X1
Código: 31537 Fábrica: FIT-PEL Unidade: PT/10 F1 F4

UN: R\$ 2,00 AV: R\$ 19,96 15: R\$ 20,37
30: R\$ 20,78 45: R\$ 21,20 60: R\$ 21,62



FITA ADES 12MMX33MTS AZUL 10X1
Código: 43710 Fábrica: FIT-PEL Unidade: PT/10 F1 F4

UN: R\$ 2,00 AV: R\$ 19,96 15: R\$ 20,37
30: R\$ 20,78 45: R\$ 21,20 60: R\$ 21,62



FITA ADES 12MMX33MTS BRANCO 10X1
Código: 31543 Fábrica: FIT-PEL Unidade: PT/10 F1 F4

UN: R\$ 2,69 AV: R\$ 2,69 15: R\$ 2,69
30: R\$ 2,69 45: R\$ 2,69 60: R\$ 2,69



FITA ADES 12MMX33MTS INVISI C/SUP PTO
Código: 33630 Fábrica: KORES Unidade: UN/1 F1 F4

UN: R\$ 2,00 AV: R\$ 19,96 15: R\$ 20,37
30: R\$ 20,78 45: R\$ 21,20 60: R\$ 21,62



FITA ADES 12MMX33MTS LILAS 10X1

Código: 31536 Fábrica: FIT-PEL Unidade: PT/10 F1 F4

UN: R\$ 2,00 AV: R\$ 19,96 15: R\$ 20,37
30: R\$ 20,78 45: R\$ 21,20 60: R\$ 21,62



FITA ADES 12MMX33MTS PRETO 10X1

Código: 31542 Fábrica: FIT-PEL Unidade: PT/10 F1 F4

UN: R\$ 2,00 AV: R\$ 19,96 15: R\$ 20,37
30: R\$ 20,78 45: R\$ 21,20 60: R\$ 21,62



FITA ADES 12MMX33MTS ROSA FLUOR 10X1

Código: 31544 Fábrica: FIT-PEL Unidade: PT/10 F1 F4

UN: R\$ 2,99 AV: R\$ 2,99 15: R\$ 3,05
30: R\$ 3,11 45: R\$ 3,17 60: R\$ 3,23



FITA ADES 12MMX33MTS TRANSP C/SUP VERMEL

Código: 33255 Fábrica: KORES Unidade: UN/1 F1 F4

UN: R\$ 2,00 AV: R\$ 19,96 15: R\$ 20,37
30: R\$ 20,78 45: R\$ 21,20 60: R\$ 21,62



FITA ADES 12MMX33MTS VERDE FLUOR 10X1

Código: 31541 Fábrica: FIT-PEL Unidade: PT/10 F1 F4

UN: R\$ 2,00 AV: R\$ 19,96 15: R\$ 20,37
30: R\$ 20,78 45: R\$ 21,20 60: R\$ 21,62



FITA ADES 12MMX33MTS VERDE 10X1

Código: 31540 Fábrica: FIT-PEL Unidade: PT/10 F1 F4

UN: R\$ 2,00 AV: R\$ 19,97 15: R\$ 20,38
30: R\$ 20,79 45: R\$ 21,21 60: R\$ 21,63



FITA ADES 12MMX33MTS VERMELHO 10X1

Código: 43711 Fábrica: FIT-PEL Unidade: PT/10 F1 F4

UN: R\$ 1,49 AV: R\$ 1,49 15: R\$ 1,52
30: R\$ 1,55 45: R\$ 1,58 60: R\$ 1,61



FITA ADES 12MMX40MTS TRANSPARENTE UN

Código: 33914 Fábrica: KORES Unidade: UN/1 F1 F4

UN: R\$ 1,49 AV: R\$ 14,94 15: R\$ 14,94
30: R\$ 14,94 45: R\$ 14,94 60: R\$ 14,94



FITA ADES 12MMX40MTS TRANSPARENTE 10X1

Código: 19321 Fábrica: KORETECH Unidade: PT/10 F1 F4

UN: R\$ 2,20 AV: R\$ 21,95 15: R\$ 22,41
30: R\$ 22,86 45: R\$ 23,32 60: R\$ 23,78



FITA ADES 12MMX65MTS TRANSPARENTE 10X1

Código: 32699 Fábrica: KORETECH Unidade: PT/10 F1 F4

UN: R\$ 2,33 AV: R\$ 13,97 15: R\$ 14,26
30: R\$ 14,54 45: R\$ 14,83 60: R\$ 15,13



FITA ADES 15MMX33MTS C/GLITER 2011 6X1

Código: 44808 Fábrica: WIN PAPER Unidade: CX/6 F1 F4

UN: R\$ 2,42 AV: R\$ 16,96 15: R\$ 17,32
30: R\$ 17,66 45: R\$ 18,02 60: R\$ 18,38



FITA ADES 18MMX50MTS TRANSP 43 7X1

Código: 49895 Fábrica: ALLTAPE Unidade: PT/7 F1 F4

UN: R\$ 6,24 AV: R\$ 6,24 15: R\$ 6,37
30: R\$ 6,50 45: R\$ 6,63 60: R\$ 6,76



FITA ADES 19MMX33MTS INVISIVEL 20018

Código: 48387 Fábrica: WIN PAPER Unidade: CR/1 F1 F4

UN: R\$ 3,19 AV: R\$ 15,96 15: R\$ 16,30
30: R\$ 16,62 45: R\$ 16,96 60: R\$ 17,29



FITA ADES 24MMX50MTS TRANSP 44 5X1

Código: 49893 Fábrica: ALLTAPE Unidade: PT/5 F1 F4

UN: R\$ 149,75 AV: R\$ 149,75 15: R\$ 152,87
30: R\$ 155,93 45: R\$ 159,05 60: R\$ 162,23



FITA ADES 45MMX1200MTS TRANSPARENTE

Código: 42204 Fábrica: HAI BRASIL Unidade: UN/1 F1 F4

UN: R\$ 22,95 AV: R\$ 22,95 15: R\$ 23,43
30: R\$ 23,90 45: R\$ 24,38 60: R\$ 24,87



FITA ADES 45MMX150MTS TRANSPARENTE

Código: 42203 Fábrica: HAI BRASIL Unidade: UN/1 F1 F4

UN: R\$ 30,94 AV: R\$ 30,94 15: R\$ 31,59
30: R\$ 32,22 45: R\$ 32,86 60: R\$ 33,52



FITA ADES 45MMX200MTS TRANSPARENTE
Código: 42202 Fábrica: HAI BRASIL Unidade: UN/1
F1 F4

UN: R\$ 2,99 AV: R\$ 14,95 15: R\$ 14,95
30: R\$ 14,95 45: R\$ 14,95 60: R\$ 14,95



FITA ADES 45MMX30MTS MARROM 5X1
Código: 43332 Fábrica: KORETECH Unidade: PT/5
F1 F4

UN: R\$ 2,99 AV: R\$ 14,95 15: R\$ 14,95
30: R\$ 14,95 45: R\$ 14,95 60: R\$ 14,95



FITA ADES 45MMX30MTS TRANSPARENTE 5X1
Código: 43331 Fábrica: KORETECH Unidade: PT/5
F1 F4

UN: R\$ 34,93 AV: R\$ 34,93 15: R\$ 35,66
30: R\$ 36,38 45: R\$ 37,10 60: R\$ 37,84



FITA ADES 45MMX300MTS TRANSPARENTE
Código: 38431 Fábrica: HAI BRASIL Unidade: UN/1
F1 F4

UN: R\$ 6,65 AV: R\$ 39,93 15: R\$ 40,76
30: R\$ 41,57 45: R\$ 42,40 60: R\$ 43,25



FITA ADES 45MMX35MTS COR SORT 468 6X1
Código: 27729 Fábrica: HAI BRASIL Unidade: PT/6
F1 F4

UN: R\$ 7,59 AV: R\$ 37,93 15: R\$ 38,72
30: R\$ 39,49 45: R\$ 40,28 60: R\$ 41,09



FITA ADES 45MMX40MTS AMARELO 5X1
Código: 43347 Fábrica: KORETECH Unidade: PT/5
F1 F4

UN: R\$ 7,59 AV: R\$ 37,93 15: R\$ 38,72
30: R\$ 39,49 45: R\$ 40,28 60: R\$ 41,09



FITA ADES 45MMX40MTS AZUL 5X1
Código: 43344 Fábrica: KORETECH Unidade: PT/5
F1 F4

UN: R\$ 7,59 AV: R\$ 37,93 15: R\$ 38,72
30: R\$ 39,49 45: R\$ 40,28 60: R\$ 41,09



FITA ADES 45MMX40MTS BRANCA 5X1
Código: 43342 Fábrica: KORETECH Unidade: PT/5
F1 F4

UN: R\$ 5,19 AV: R\$ 25,95 15: R\$ 26,49
30: R\$ 27,02 45: R\$ 27,56 60: R\$ 28,11



FITA ADES 45MMX40MTS MARRON 5X1
Código: 43349 Fábrica: KORETECH Unidade: PT/5
F1 F4

UN: R\$ 7,59 AV: R\$ 37,93 15: R\$ 38,72
30: R\$ 39,49 45: R\$ 40,28 60: R\$ 41,09



FITA ADES 45MMX40MTS PRETA 5X1
Código: 43343 Fábrica: KORETECH Unidade: PT/5
F1 F4

UN: R\$ 4,99 AV: R\$ 19,96 15: R\$ 19,96
30: R\$ 19,96 45: R\$ 19,96 60: R\$ 19,96



FITA ADES 45MMX40MTS TRANSP 710 4X1
Código: 42206 Fábrica: ADERE Unidade: PT/4
F1 F4

UN: R\$ 4,59 AV: R\$ 22,95 15: R\$ 22,95
30: R\$ 22,95 45: R\$ 22,95 60: R\$ 22,95



FITA ADES 45MMX40MTS TRANSPARENTE 5X1
Código: 43348 Fábrica: KORETECH Unidade: PT/5
F1 F4

UN: R\$ 7,59 AV: R\$ 37,93 15: R\$ 38,72
30: R\$ 39,49 45: R\$ 40,28 60: R\$ 41,09

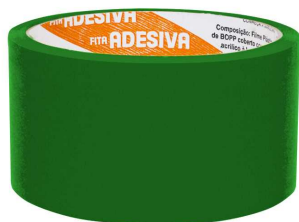

FITA ADES 45MMX40MTS VERDE 5X1
Código: 43345 Fábrica: KORETECH Unidade: PT/5
F1 F4

UN: R\$ 7,59 AV: R\$ 37,93 15: R\$ 38,72
30: R\$ 39,49 45: R\$ 40,28 60: R\$ 41,09



FITA ADES 45MMX40MTS VERMELHO 5X1
Código: 43346 Fábrica: KORETECH Unidade: PT/5
F1 F4

UN: R\$ 4,99 AV: R\$ 24,95 15: R\$ 25,47
30: R\$ 25,98 45: R\$ 26,50 60: R\$ 27,03



FITA ADES 45MMX45MTS MARRON 5X1
Código: 4161 Fábrica: FIT-PEL/KORE Unidade: PT/5
F1 F4

UN: R\$ 5,28 AV: R\$ 26,41 15: R\$ 26,96
30: R\$ 27,50 45: R\$ 28,05 60: R\$ 28,61



FITA ADES 45MMX45MTS MARRON 5X1
Código: 40211 Fábrica: TIGHT TAPE Unidade: PT/5
F1 F4

UN: R\$ 5,98 AV: R\$ 5,98 15: R\$ 6,11
30: R\$ 6,23 45: R\$ 6,35 60: R\$ 6,48



FITA ADES 45MMX45MTS TRANSPARENTE UN
Código: Fábrika: Unidade:
42434 FIT PEL UN/1
F1 F4

UN: R\$ 11,98 AV: R\$ 59,89 15: R\$ 61,14
30: R\$ 62,36 45: R\$ 63,61 60: R\$ 64,88

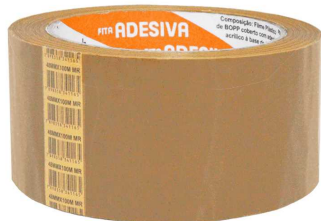

FITA ADES 48MMX100MTS MARROM 5X1
Código: Fábrika: Unidade:
43337 KORETECH PT/5
F1 F4

UN: R\$ 23,95 AV: R\$ 23,95 15: R\$ 24,45
30: R\$ 24,94 45: R\$ 25,44 60: R\$ 25,95



FITA ADES 48MMX30M DEMARC SOLO AMA/PT 80
Código: Fábrika: Unidade:
44320 ALLTAPE RL/1
F1 F4

UN: R\$ 23,95 AV: R\$ 23,95 15: R\$ 24,45
30: R\$ 24,94 45: R\$ 25,44 60: R\$ 25,95



FITA ADES 48MMX30M DEMARC SOLO AMAREL 71
Código: Fábrika: Unidade:
44318 ALLTAPE RL/1
F1 F4

UN: R\$ 23,95 AV: R\$ 23,95 15: R\$ 24,45
30: R\$ 24,94 45: R\$ 25,44 60: R\$ 25,95



FITA ADES 48MMX30M DEMARC SOLO AZUL 83
Código: Fábrika: Unidade:
44315 ALLTAPE RL/1
F1 F4

UN: R\$ 23,95 AV: R\$ 23,95 15: R\$ 24,45
30: R\$ 24,94 45: R\$ 25,44 60: R\$ 25,95



FITA ADES 48MMX30M DEMARC SOLO BRANCA 81
Código: Fábrika: Unidade:
44316 ALLTAPE RL/1
F1 F4

UN: R\$ 23,95 AV: R\$ 23,95 15: R\$ 24,45
30: R\$ 24,94 45: R\$ 25,44 60: R\$ 25,95



FITA ADES 48MMX30M DEMARC SOLO VERDE 82
Código: Fábrika: Unidade:
44317 ALLTAPE RL/1
F1 F4

UN: R\$ 23,95 AV: R\$ 23,95 15: R\$ 24,45
30: R\$ 24,94 45: R\$ 25,44 60: R\$ 25,95



FITA ADES 48MMX30M DEMARC SOLO VERM 72
Código: Fábrika: Unidade:
44319 ALLTAPE RL/1
F1 F4

UN: R\$ 6,99 AV: R\$ 34,93 15: R\$ 35,66
30: R\$ 36,38 45: R\$ 37,10 60: R\$ 37,84

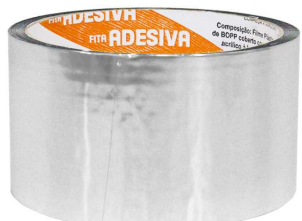

FITA ADES 48MMX40MTS METALIZADA 5X1
Código: Fábrika: Unidade:
43334 KORETECH PT/5
F1 F4

UN: R\$ 5,74 AV: R\$ 22,96 15: R\$ 23,44
30: R\$ 23,91 45: R\$ 24,39 60: R\$ 24,88



FITA ADES 48MMX40MTS TRANSPARENTE 4X1
Código: Fábrika: Unidade:
31612 ADELBRAS PT/4
F1 F4

UN: R\$ 6,19 AV: R\$ 30,94 15: R\$ 31,59
30: R\$ 32,22 45: R\$ 32,86 60: R\$ 33,52



FITA ADES 48MMX45MTS MARROM 5X1
Código: Fábrika: Unidade:
43336 KORETECH PT/5
F1 F4

UN: R\$ 6,19 AV: R\$ 30,94 15: R\$ 31,59
30: R\$ 32,22 45: R\$ 32,86 60: R\$ 33,52



FITA ADES 48MMX45MTS TRANSPARENTE 5X1
Código: Fábrika: Unidade:
43335 KORETECH PT/5
F1 F4

UN: R\$ 19,96 AV: R\$ 19,96 15: R\$ 20,37
30: R\$ 20,78 45: R\$ 21,20 60: R\$ 21,62



FITA ADES 48MMX5MTS PRATA UN
Código: Fábrika: Unidade:
49397 TEK BOND UN/1
F1 F4

UN: R\$ 6,24 AV: R\$ 24,95 15: R\$ 25,47
30: R\$ 25,98 45: R\$ 26,50 60: R\$ 27,03



FITA ADES 48MMX50MTS TRANSP 4X1
Código: Fábrika: Unidade:
44314 ALLTAPE PT/4
F1 F4

UN: R\$ 7,25 AV: R\$ 7,25 15: R\$ 7,40
30: R\$ 7,55 45: R\$ 7,70 60: R\$ 7,85



FITA CORRETIVA 5MMX10MTS CTL 242201
Código: Fábrika: Unidade:
44108 FUTURO CR/1
F1 F4

UN: R\$ 6,59 AV: R\$ 6,59 15: R\$ 6,73
30: R\$ 6,86 45: R\$ 7,00 60: R\$ 7,14



FITA CORRETIVA 5MMX10MTS 91416
Código: Fábrika: Unidade:
50648 JOCAROFFICE CR/1
F1 F4

UN: R\$ 11,43 AV: R\$ 11,43 15: R\$ 11,67
30: R\$ 11,90 45: R\$ 12,14 60: R\$ 12,38



FITA CORRETIVA 5MMX12MTS PRIME 1003
Código: Fábrica: Unidade:
44986 BRW CR/1
F1 F4

UN: R\$ 5,12 AV: R\$ 5,12 15: R\$ 5,23
30: R\$ 5,33 45: R\$ 5,44 60: R\$ 5,55



FITA CORRETIVA 5MMX12MTS 437
Código: Fábrica: Unidade:
46545 MASTERPRINT UN/1
F1 F4

UN: R\$ 5,99 AV: R\$ 5,99 15: R\$ 6,12
30: R\$ 6,24 45: R\$ 6,36 60: R\$ 6,49



FITA CORRETIVA 5MMX6MTS CTL 1002
Código: Fábrica: Unidade:
34108 BRW CR/1
F1 F4

UN: R\$ 4,13 AV: R\$ 4,13 15: R\$ 4,22
30: R\$ 4,30 45: R\$ 4,39 60: R\$ 4,48



FITA CORRETIVA 5MMX6MTS 436
Código: Fábrica: Unidade:
40786 MASTERPRINT CR/1
F1 F4

UN: R\$ 5,39 AV: R\$ 26,93 15: R\$ 27,49
30: R\$ 28,04 45: R\$ 28,60 60: R\$ 29,17



FITA CREPE 18MMX40MTS USO GERAL 5X1
Código: Fábrica: Unidade:
48113 JUSSARA PT/5
F1 F4

UN: R\$ 6,74 AV: R\$ 33,70 15: R\$ 34,40
30: R\$ 35,09 45: R\$ 35,79 60: R\$ 36,50



FITA CREPE 18MMX50MTS USO GERAL 5X1
Código: Fábrica: Unidade:
48114 JUSSARA PT/5
F1 F4

UN: R\$ 6,59 AV: R\$ 32,94 15: R\$ 33,62
30: R\$ 34,30 45: R\$ 34,98 60: R\$ 35,68



FITA CREPE 18MMX50MTS USO GERAL 5X1
Código: Fábrica: Unidade:
48649 TEK BOND PT/5
F1 F4

UN: R\$ 5,24 AV: R\$ 41,92 15: R\$ 42,80
30: R\$ 43,65 45: R\$ 44,53 60: R\$ 45,42



FITA CREPE 18MMX50MTS USO GERAL 81 8X1
Código: Fábrica: Unidade:
49891 ALLTAPE PT/8
F1 F4

UN: R\$ 7,39 AV: R\$ 36,93 15: R\$ 37,70
30: R\$ 38,45 45: R\$ 39,22 60: R\$ 40,01



FITA CREPE 24MMX50MTS USO GERAL 5X1
Código: Fábrica: Unidade:
48650 TEK BOND PT/5
F1 F4

UN: R\$ 16,96 AV: R\$ 16,96 15: R\$ 17,32
30: R\$ 17,66 45: R\$ 18,02 60: R\$ 18,38



FITA CREPE 48MMX50MTS USO GERAL 1X1
Código: Fábrica: Unidade:
48651 TEK BOND UN/1
F1 F4

UN: R\$ 15,31 AV: R\$ 45,92 15: R\$ 46,87
30: R\$ 47,81 45: R\$ 48,77 60: R\$ 49,74



FITA CREPE 48MMX50MTS USO GERAL 83 3X1
Código: Fábrica: Unidade:
44313 ALLTAPE PT/3
F1 F4

UN: R\$ 13,97 AV: R\$ 13,97 15: R\$ 14,26
30: R\$ 14,54 45: R\$ 14,83 60: R\$ 15,13

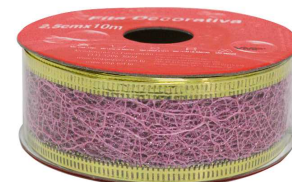

FITA DEC 25MMX10MTS ROSA BRILHO
Código: Fábrica: Unidade:
43387 VMP RL/1
F1 F4

UN: R\$ 14,97 AV: R\$ 14,97 15: R\$ 15,28
30: R\$ 15,58 45: R\$ 15,90 60: R\$ 16,21



FITA DEC 38MMX10MTS AZUL ESTAMP BOLINHAS
Código: Fábrica: Unidade:
43385 VMP RL/1
F1 F4

UN: R\$ 16,96 AV: R\$ 16,96 15: R\$ 17,32
30: R\$ 17,66 45: R\$ 18,02 60: R\$ 18,38



FITA DEC 38MMX10MTS AZUL ESTAMP PRATA
Código: Fábrica: Unidade:
43382 VMP RL/1
F1 F4

UN: R\$ 15,96 AV: R\$ 15,96 15: R\$ 16,30
30: R\$ 16,62 45: R\$ 16,96 60: R\$ 17,29



FITA DEC 38MMX10MTS BRANCO C/ GLITER
Código: Fábrica: Unidade:
43383 VMP RL/1
F1 F4

UN: R\$ 23,95 AV: R\$ 23,95 15: R\$ 24,45
30: R\$ 24,94 45: R\$ 25,44 60: R\$ 25,95



FITA DEC 38MMX10MTS ESTAMP NATAL
Código: Fábrica: Unidade:
43381 VMP RL/1
F1 F4

UN: R\$ 16,96 AV: R\$ 16,96 15: R\$ 17,32
30: R\$ 17,66 45: R\$ 18,02 60: R\$ 18,38



FITA DEC 38MMX10MTS LILAS ESTAMP OURO
Código: 43380 Fábrica: VMP Unidade: RL/1
F1 F4

UN: R\$ 15,96 AV: R\$ 15,96 15: R\$ 16,30
30: R\$ 16,62 45: R\$ 16,96 60: R\$ 17,29



FITA DEC 38MMX10MTS OURO ESTAMP
Código: 43378 Fábrica: VMP Unidade: RL/1
F1 F4

UN: R\$ 23,46 AV: R\$ 23,46 15: R\$ 23,95
30: R\$ 24,43 45: R\$ 24,92 60: R\$ 25,42



FITA DEC 63MMX10MTS BRANCO C/ GLITER
Código: 43388 Fábrica: VMP Unidade: RL/1
F1 F4

UN: R\$ 23,46 AV: R\$ 23,46 15: R\$ 23,95
30: R\$ 24,43 45: R\$ 24,92 60: R\$ 25,42



FITA DEC 63MMX10MTS OURO ESTAMP
Código: 43377 Fábrica: VMP Unidade: RL/1
F1 F4

UN: R\$ 10,97 AV: R\$ 10,97 15: R\$ 11,20
30: R\$ 11,43 45: R\$ 11,65 60: R\$ 11,89



FITA DECORATIVA 15MMX50MTS 01 BRANCO
Código: 31522 Fábrica: NIZURI Unidade: RL/1
F1 F4

UN: R\$ 10,97 AV: R\$ 10,97 15: R\$ 11,20
30: R\$ 11,43 45: R\$ 11,65 60: R\$ 11,89



FITA DECORATIVA 15MMX50MTS 11 DOURADO
Código: 31524 Fábrica: NIZURI Unidade: RL/1
F1 F4

UN: R\$ 10,97 AV: R\$ 10,97 15: R\$ 11,20
30: R\$ 11,43 45: R\$ 11,65 60: R\$ 11,89



FITA DECORATIVA 15MMX50MTS 12 ROSA PINK
Código: 31526 Fábrica: NIZURI Unidade: RL/1
F1 F4

UN: R\$ 10,97 AV: R\$ 10,97 15: R\$ 11,20
30: R\$ 11,43 45: R\$ 11,65 60: R\$ 11,89



FITA DECORATIVA 15MMX50MTS 15 LILAS
Código: 32982 Fábrica: NIZURI Unidade: RL/1
F1 F4

UN: R\$ 10,97 AV: R\$ 10,97 15: R\$ 11,20
30: R\$ 11,43 45: R\$ 11,65 60: R\$ 11,89



FITA DECORATIVA 15MMX50MTS 19 PRETO
Código: 31528 Fábrica: NIZURI Unidade: RL/1
F1 F4

UN: R\$ 10,97 AV: R\$ 10,97 15: R\$ 11,20
30: R\$ 11,43 45: R\$ 11,65 60: R\$ 11,89



FITA DECORATIVA 15MMX50MTS 20 VERDE LIMA
Código: 32981 Fábrica: NIZURI Unidade: RL/1
F1 F4

UN: R\$ 10,97 AV: R\$ 10,97 15: R\$ 11,20
30: R\$ 11,43 45: R\$ 11,65 60: R\$ 11,89



FITA DECORATIVA 15MMX50MTS 22 ROSA
Código: 31529 Fábrica: NIZURI Unidade: RL/1
F1 F4

UN: R\$ 12,97 AV: R\$ 12,97 15: R\$ 13,24
30: R\$ 13,50 45: R\$ 13,77 60: R\$ 14,05



FITA DECORATIVA 21MMX50MTS 01 BRANCO
Código: 32984 Fábrica: NIZURI Unidade: RL/1
F1 F4

UN: R\$ 18,96 AV: R\$ 18,96 15: R\$ 19,35
30: R\$ 19,74 45: R\$ 20,14 60: R\$ 20,54



FITA DECORATIVA 30MMX50MTS 01 BRANCO
Código: 47175 Fábrica: NIZURI/RAIO Unidade: RL/1
F1 F4

UN: R\$ 18,96 AV: R\$ 18,96 15: R\$ 19,35
30: R\$ 19,74 45: R\$ 20,14 60: R\$ 20,54



FITA DECORATIVA 30MMX50MTS 11 DOURADO
Código: 47180 Fábrica: NIZURI/RAIO Unidade: RL/1
F1 F4

UN: R\$ 18,96 AV: R\$ 18,96 15: R\$ 19,35
30: R\$ 19,74 45: R\$ 20,14 60: R\$ 20,54



FITA DECORATIVA 30MMX50MTS 12 PINK
Código: 47181 Fábrica: NIZURI/RAIO Unidade: RL/1
F1 F4

UN: R\$ 18,96 AV: R\$ 18,96 15: R\$ 19,35
30: R\$ 19,74 45: R\$ 20,14 60: R\$ 20,54



FITA DECORATIVA 30MMX50MTS 17 LILAS
Código: 47182 Fábrica: NIZURI/RAIO Unidade: RL/1
F1 F4

UN: R\$ 18,96 AV: R\$ 18,96 15: R\$ 19,35
30: R\$ 19,74 45: R\$ 20,14 60: R\$ 20,54



FITA DECORATIVA 32MMX50MTS 07 VERDE MILI
Código: Fábrica: Unidade:
47183 NIZURI RL/1
F1 F4

UN: R\$ 18,96 AV: R\$ 18,96 15: R\$ 19,35
30: R\$ 19,74 45: R\$ 20,14 60: R\$ 20,54



FITA DECORATIVA 32MMX50MTS 10 PRATA
Código: Fábrica: Unidade:
47178 NIZURI RL/1
F1 F4

UN: R\$ 18,96 AV: R\$ 18,96 15: R\$ 19,35
30: R\$ 19,74 45: R\$ 20,14 60: R\$ 20,54



FITA DECORATIVA 32MMX50MTS 19 PRETO
Código: Fábrica: Unidade:
47177 NIZURI RL/1
F1 F4

UN: R\$ 19,96 AV: R\$ 19,96 15: R\$ 20,37
30: R\$ 20,78 45: R\$ 21,20 60: R\$ 21,62



FITA DUPLA FACE 5MMX20MT SOLAPA 520
Código: Fábrica: Unidade:
47421 HAI BRASIL UN/1
F1 F4

UN: R\$ 89,85 AV: R\$ 89,85 15: R\$ 91,72
30: R\$ 93,55 45: R\$ 95,42 60: R\$ 97,33



FITA DUPLA FACE ACR INT 19MMX20MTS
Código: Fábrica: Unidade:
50753 TEK BOND UN/1
F1 F4

UN: R\$ 5,09 AV: R\$ 5,09 15: R\$ 5,20
30: R\$ 5,30 45: R\$ 5,41 60: R\$ 5,52



FITA DUPLA FACE ESPUMA 18MMX2M CTL D2
Código: Fábrica: Unidade:
38224 HAI BRASIL CR/1
F1 F4

UN: R\$ 6,48 AV: R\$ 6,48 15: R\$ 6,61
30: R\$ 6,75 45: R\$ 6,88 60: R\$ 7,02



FITA DUPLA FACE ESPUMA 18MMX5M CTL 53007
Código: Fábrica: Unidade:
50127 ALFACELL CR/1
F1 F4

UN: R\$ 10,97 AV: R\$ 10,97 15: R\$ 11,20
30: R\$ 11,43 45: R\$ 11,65 60: R\$ 11,89



FITA DUPLA FACE EXTRA FORTE VERD 24MMX2M
Código: Fábrica: Unidade:
47935 YIN'S PAPER RL/1
F1 F4

UN: R\$ 4,99 AV: R\$ 49,86 15: R\$ 50,90
30: R\$ 51,92 45: R\$ 52,96 60: R\$ 54,01



FITA DUPLA FACE 12MMX30MTS 581 10X1
Código: Fábrica: Unidade:
49889 ALLTAPE PT/10
F1 F4

UN: R\$ 13,97 AV: R\$ 13,97 15: R\$ 14,26
30: R\$ 14,54 45: R\$ 14,83 60: R\$ 15,13



FITA DUPLA FACE 18MMX2MTS SILICONE CTL
Código: Fábrica: Unidade:
45539 WINMAX UN/1
F1 F4

UN: R\$ 7,49 AV: R\$ 44,92 15: R\$ 45,85
30: R\$ 46,77 45: R\$ 47,71 60: R\$ 48,66



FITA DUPLA FACE 18MMX30MTS 581 6X1
Código: Fábrica: Unidade:
50306 ALLTAPE PT/6
F1 F4

UN: R\$ 6,25 AV: R\$ 6,25 15: R\$ 6,38
30: R\$ 6,51 45: R\$ 6,64 60: R\$ 6,77



FITA MAQUINA ESCRIVER OLIVETTI 13X8MM
Código: Fábrica: Unidade:
45123 MASTERPRINT UN/1
F1 F4

UN: R\$ 8,98 AV: R\$ 89,85 15: R\$ 91,72
30: R\$ 93,55 45: R\$ 95,42 60: R\$ 97,33



FITA METALOIDE 15MMX50MTS HOLOGRAFI 10X1
Código: Fábrica: Unidade:
36610 BRW RL/10
F1 F4

UN: R\$ 8,98 AV: R\$ 89,85 15: R\$ 91,72
30: R\$ 93,55 45: R\$ 95,42 60: R\$ 97,33



FITA METALOIDE 15MMX50MTS VERDE 6X1
Código: Fábrica: Unidade:
35349 BRW RL/10
F1 F4

UN: R\$ 17,86 AV: R\$ 17,86 15: R\$ 18,23
30: R\$ 18,60 45: R\$ 18,97 60: R\$ 19,35



FITA NYLON P/IMPRESSORA MATRICIAL LX350
Código: Fábrica: Unidade:
44332 MASTERPRINT UN/1
F1 F4

UN: R\$ 6,98 AV: R\$ 6,98 15: R\$ 7,12
30: R\$ 7,27 45: R\$ 7,41 60: R\$ 7,56



FITA P/CALCULADORA SHARP PRETA/VERMELHO
Código: Fábrica: Unidade:
47221 MASTERPRINT UN/1
F1 F4

UN: R\$ 29,94 AV: R\$ 29,94 15: R\$ 30,57
30: R\$ 31,18 45: R\$ 31,80 60: R\$ 32,44



FITA P/IMPRESSORA EPSON FX2190 13MMX14MT
Código: Fábrica: Unidade:
41956 MASTERPRINT UN/1
F1 F4

UN: R\$ 11,88 AV: R\$ 11,88 15: R\$ 12,13
30: R\$ 12,37 45: R\$ 12,62 60: R\$ 12,87



FITA P/IMPRESSORA EPSON MX80 MATRICIAL
Código: Fábrica: Unidade:
14350 MASTERPRINT UN/1
F1 F4

UN: R\$ 2,89 AV: R\$ 28,94 15: R\$ 29,55
30: R\$ 30,14 45: R\$ 30,74 60: R\$ 31,36



FITILHO DECORAT 5MMX50MTS AMARELO 10X1
Código: Fábrica: Unidade:
18286 SAO VITOR PT/10
F1 F4

UN: R\$ 2,89 AV: R\$ 28,94 15: R\$ 29,55
30: R\$ 30,14 45: R\$ 30,74 60: R\$ 31,36



FITILHO DECORAT 5MMX50MTS AZUL BB 10X1
Código: Fábrica: Unidade:
34561 SAO VITOR PT/10
F1 F4

UN: R\$ 2,89 AV: R\$ 28,94 15: R\$ 29,55
30: R\$ 30,14 45: R\$ 30,74 60: R\$ 31,36

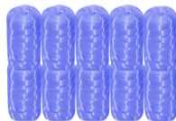

FITILHO DECORAT 5MMX50MTS AZUL 10X1
Código: Fábrica: Unidade:
18284 SAO VITOR PT/10
F1 F4

UN: R\$ 2,89 AV: R\$ 28,94 15: R\$ 29,55
30: R\$ 30,14 45: R\$ 30,74 60: R\$ 31,36



FITILHO DECORAT 5MMX50MTS BRANCO 10X1
Código: Fábrica: Unidade:
18279 SAO VITOR PT/10
F1 F4

UN: R\$ 2,89 AV: R\$ 28,94 15: R\$ 29,55
30: R\$ 30,14 45: R\$ 30,74 60: R\$ 31,36



FITILHO DECORAT 5MMX50MTS CHAMPAGNE 10X1
Código: Fábrica: Unidade:
41922 SAO VITOR PT/10
F1 F4

UN: R\$ 2,89 AV: R\$ 28,94 15: R\$ 29,55
30: R\$ 30,14 45: R\$ 30,74 60: R\$ 31,36



FITILHO DECORAT 5MMX50MTS DOURADO 10X1
Código: Fábrica: Unidade:
18278 SAO VITOR PT/10
F1 F4

UN: R\$ 2,89 AV: R\$ 28,94 15: R\$ 29,55
30: R\$ 30,14 45: R\$ 30,74 60: R\$ 31,36



FITILHO DECORAT 5MMX50MTS GEMA 10X1
Código: Fábrica: Unidade:
41877 SAO VITOR PT/10
F1 F4

UN: R\$ 2,89 AV: R\$ 28,94 15: R\$ 29,55
30: R\$ 30,14 45: R\$ 30,74 60: R\$ 31,36



FITILHO DECORAT 5MMX50MTS GOIABA 10X1
Código: Fábrica: Unidade:
41924 SAO VITOR PT/10
F1 F4

UN: R\$ 2,89 AV: R\$ 28,94 15: R\$ 29,55
30: R\$ 30,14 45: R\$ 30,74 60: R\$ 31,36



FITILHO DECORAT 5MMX50MTS LARANJA 10X1
Código: Fábrica: Unidade:
18303 SAO VITOR PT/10
F1 F4

UN: R\$ 2,89 AV: R\$ 28,94 15: R\$ 29,55
30: R\$ 30,14 45: R\$ 30,74 60: R\$ 31,36



FITILHO DECORAT 5MMX50MTS LILAS 10X1
Código: Fábrica: Unidade:
18276 SAO VITOR PT/10
F1 F4

UN: R\$ 2,89 AV: R\$ 28,94 15: R\$ 29,55
30: R\$ 30,14 45: R\$ 30,74 60: R\$ 31,36



FITILHO DECORAT 5MMX50MTS MARROM 10X1
Código: Fábrica: Unidade:
19783 SAO VITOR PT/10
F1 F4

UN: R\$ 2,89 AV: R\$ 28,94 15: R\$ 29,55
30: R\$ 30,14 45: R\$ 30,74 60: R\$ 31,36



FITILHO DECORAT 5MMX50MTS PRETO 10X1
Código: Fábrica: Unidade:
18282 SAO VITOR PT/10
F1 F4

UN: R\$ 2,89 AV: R\$ 28,94 15: R\$ 29,55
30: R\$ 30,14 45: R\$ 30,74 60: R\$ 31,36



FITILHO DECORAT 5MMX50MTS ROSA PINK 10X1
Código: Fábrica: Unidade:
18277 SAO VITOR PT/10
F1 F4

UN: R\$ 2,89 AV: R\$ 28,94 15: R\$ 29,55
30: R\$ 30,14 45: R\$ 30,74 60: R\$ 31,36



FITILHO DECORAT 5MMX50MTS ROSA 10X1
Código: Fábrica: Unidade:
18304 SAO VITOR PT/10
F1 F4

UN: R\$ 2,89 AV: R\$ 28,94 15: R\$ 29,55
30: R\$ 30,14 45: R\$ 30,74 60: R\$ 31,36



FITILHO DECORAT 5MMX50MTS ROXO 10X1
Código: 41921 Fábrica: SAO VITOR Unidade: PT/10 F1 F4

UN: R\$ 2,50 AV: R\$ 24,95 15: R\$ 25,47
30: R\$ 25,98 45: R\$ 26,50 60: R\$ 27,03



FITILHO DECORAT 5MMX50MTS RUBRO 10X1
Código: 41913 Fábrica: SAO VITOR Unidade: PT/10 F1 F4

UN: R\$ 2,50 AV: R\$ 24,99 15: R\$ 24,99
30: R\$ 24,99 45: R\$ 24,99 60: R\$ 24,99



FITILHO DECORAT 5MMX50MTS SORTIDO 10X1
Código: 18305 Fábrica: SAO VITOR Unidade: PT/10 F1 F4

UN: R\$ 2,89 AV: R\$ 28,94 15: R\$ 29,55
30: R\$ 30,14 45: R\$ 30,74 60: R\$ 31,36



FITILHO DECORAT 5MMX50MTS VERDE LM 10X1
Código: 41911 Fábrica: SAO VITOR Unidade: PT/10 F1 F4

UN: R\$ 2,89 AV: R\$ 28,94 15: R\$ 29,55
30: R\$ 30,14 45: R\$ 30,74 60: R\$ 31,36



FITILHO DECORAT 5MMX50MTS VERDE MIL 10X1
Código: 18287 Fábrica: SAO VITOR Unidade: PT/10 F1 F4

UN: R\$ 2,89 AV: R\$ 28,94 15: R\$ 29,55
30: R\$ 30,14 45: R\$ 30,74 60: R\$ 31,36



FITILHO DECORAT 5MMX50MTS VERDE OLI 10X1
Código: 18288 Fábrica: SAO VITOR Unidade: PT/10 F1 F4

UN: R\$ 2,89 AV: R\$ 28,94 15: R\$ 29,55
30: R\$ 30,14 45: R\$ 30,74 60: R\$ 31,36



FITILHO DECORAT 5MMX50MTS VERDE 10X1
Código: 18274 Fábrica: SAO VITOR Unidade: PT/10 F1 F4

UN: R\$ 2,89 AV: R\$ 28,94 15: R\$ 29,55
30: R\$ 30,14 45: R\$ 30,74 60: R\$ 31,36



FITILHO DECORAT 5MMX50MTS VERMELHO 10X1
Código: 18281 Fábrica: SAO VITOR Unidade: PT/10 F1 F4

UN: R\$ 2,89 AV: R\$ 28,94 15: R\$ 29,55
30: R\$ 30,14 45: R\$ 30,74 60: R\$ 31,36



FITILHO DECORAT 5MMX50MTS VINHO 10X1
Código: 41923 Fábrica: SAO VITOR Unidade: PT/10 F1 F4

UN: R\$ 9,48 AV: R\$ 9,48 15: R\$ 9,68
30: R\$ 9,88 45: R\$ 10,07 60: R\$ 10,28



FORMA PLAST GELO 12 CUBOS FDO SILIC 0215
Código: 40316 Fábrica: WINCY Unidade: UN/1 F1 F4

UN: R\$ 0,60 AV: R\$ 5,98 15: R\$ 6,11
30: R\$ 6,23 45: R\$ 6,35 60: R\$ 6,48



FOSFORO DE SEGURANCA 10X40
Código: 49698 Fábrica: SABIA Unidade: PT/10 F1 F4

UN: R\$ 0,11 AV: R\$ 10,97 15: R\$ 11,20
30: R\$ 11,43 45: R\$ 11,65 60: R\$ 11,89

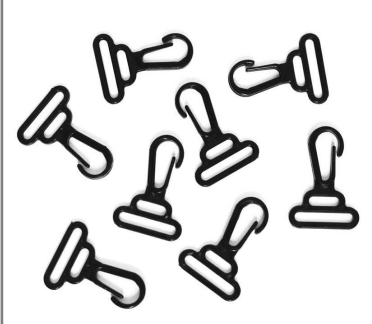

GANCHO PLAST P/CARTAO PRETO 100X1
Código: 47735 Fábrica: ITALY'S Unidade: PT/100 F1 F4

UN: R\$ 2,08 AV: R\$ 24,95 15: R\$ 25,47
30: R\$ 25,98 45: R\$ 26,50 60: R\$ 27,03



GIZ CERA 6 CORES 24 GRS FINO 1018 12X1
Código: 42618 Fábrica: SERELEPE Unidade: PT/12 F1 F4

UN: R\$ 21,63 AV: R\$ 64,89 15: R\$ 66,24
30: R\$ 67,56 45: R\$ 68,91 60: R\$ 70,29



GIZ CERA 6 CORES 185 GRS MEU 1º GIZ 3X1
Código: 42135 Fábrica: ACRILEX Unidade: PT/3 F1 F4

UN: R\$ 5,82 AV: R\$ 69,88 15: R\$ 71,33
30: R\$ 72,76 45: R\$ 74,22 60: R\$ 75,70



GIZ CERA 6 CORES 56 GRS BIG 12X1
Código: 42133 Fábrica: ACRILEX Unidade: PT/12 F1 F4

UN: R\$ 4,09 AV: R\$ 4,09 15: R\$ 4,18
30: R\$ 4,26 45: R\$ 4,35 60: R\$ 4,43



GIZ CERA 12 CORES
Código: 34442 Fábrica: SERELEPE Unidade: UN/1 F1 F4

UN: R\$ 4,16 AV: R\$ 49,91 15: R\$ 50,95
30: R\$ 51,97 45: R\$ 53,01 60: R\$ 54,07



GIZ CERA 12 CORES 48 GRS FINO 1019 12X1
Código: Fábrika: Unidade:
42619 SERELEPE PT/12
F1 F4

UN: R\$ 5,41 AV: R\$ 64,89 15: R\$ 66,24
30: R\$ 67,56 45: R\$ 68,91 60: R\$ 70,29



GIZ CERA 12 CORES 48 GRS 12X1
Código: Fábrika: Unidade:
42137 ACRILEX PT/12
F1 F4

UN: R\$ 7,98 AV: R\$ 7,98 15: R\$ 8,14
30: R\$ 8,31 45: R\$ 8,47 60: R\$ 8,64



GIZ CERA 12 CORES GROSSO GDE 062203
Código: Fábrika: Unidade:
44072 FUTURO CX/1
F1 F4

UN: R\$ 6,75 AV: R\$ 6,75 15: R\$ 6,89
30: R\$ 7,03 45: R\$ 7,17 60: R\$ 7,31



GIZ CERA 12 CORES 118 GRS BIG 4462 UN
Código: Fábrika: Unidade:
46349 LEO&LEO UN/1
F1 F4

UN: R\$ 49,91 AV: R\$ 49,91 15: R\$ 50,95
30: R\$ 51,97 45: R\$ 53,01 60: R\$ 54,07



GIZ CERA 12 CORES 370 GRS JUMBO UN
Código: Fábrika: Unidade:
47437 ACRILEX UN/1
F1 F4

UN: R\$ 41,60 AV: R\$ 124,80 15: R\$ 127,40
30: R\$ 129,95 45: R\$ 132,55 60: R\$ 135,20



GIZ CERA 12 CORES 370 GRS MEU 1º GIZ 3X1
Código: Fábrika: Unidade:
42136 ACRILEX PT/3
F1 F4

UN: R\$ 29,94 AV: R\$ 29,94 15: R\$ 30,57
30: R\$ 31,18 45: R\$ 31,80 60: R\$ 32,44



GIZ CERA 12 CORES 510 GRS BIG 752612
Código: Fábrika: Unidade:
49267 COLORARE CX/1
F1 F4

UN: R\$ 9,15 AV: R\$ 109,81 15: R\$ 112,10
30: R\$ 114,34 45: R\$ 116,63 60: R\$ 118,96



GIZ CERA 12 CORES 95 GRS BIG TRIANG 12X1
Código: Fábrika: Unidade:
42139 ACRILEX PT/12
F1 F4

UN: R\$ 0,14 AV: R\$ 6,98 15: R\$ 7,12
30: R\$ 7,27 45: R\$ 7,41 60: R\$ 7,56



GIZ ESCOLAR BRANCO ANTIALÉRGICO 50X1
Código: Fábrika: Unidade:
24040 DELTA/ZIGGIZ CX/50
F1 F4

UN: R\$ 0,11 AV: R\$ 6,98 15: R\$ 7,12
30: R\$ 7,27 45: R\$ 7,41 60: R\$ 7,56



GIZ ESCOLAR BRANCO ANTIALÉRGICO 64X1
Código: Fábrika: Unidade:
7312 DELTA2 CX/64
F1 F4

UN: R\$ 0,22 AV: R\$ 10,97 15: R\$ 11,20
30: R\$ 11,43 45: R\$ 11,65 60: R\$ 11,89



GIZ ESCOLAR COLORIDO ANTIALÉRGICO 50X1
Código: Fábrika: Unidade:
24041 DELTA CX/50
F1 F4

UN: R\$ 0,12 AV: R\$ 7,98 15: R\$ 8,14
30: R\$ 8,31 45: R\$ 8,47 60: R\$ 8,64



GIZ ESCOLAR COLORIDO 64X1
Código: Fábrika: Unidade:
7395 DELTA CX/64
F1 F4

UN: R\$ 19,96 AV: R\$ 19,96 15: R\$ 20,37
30: R\$ 20,78 45: R\$ 21,20 60: R\$ 21,62



GIZ PASTEL OLEO 12 CORES
Código: Fábrika: Unidade:
46341 CIS UN/1
F1 F4

UN: R\$ 39,93 AV: R\$ 39,93 15: R\$ 40,76
30: R\$ 41,57 45: R\$ 42,40 60: R\$ 43,25



GIZ PASTEL OLEO 24 CORES
Código: Fábrika: Unidade:
47779 CIS UN/1
F1 F4

UN: R\$ 59,89 AV: R\$ 59,89 15: R\$ 61,14
30: R\$ 62,36 45: R\$ 63,61 60: R\$ 64,88



GIZ PASTEL OLEO 36 CORES
Código: Fábrika: Unidade:
47780 CIS UN/1
F1 F4

UN: R\$ 74,87 AV: R\$ 74,87 15: R\$ 76,43
30: R\$ 77,96 45: R\$ 79,52 60: R\$ 81,11



GIZ P/TACO SINUCA BILHAR 144X1
Código: Fábrika: Unidade:
50275 7BELO CX/1
F1 F4

UN: R\$ 12,83 AV: R\$ 12,83 15: R\$ 13,10
30: R\$ 13,36 45: R\$ 13,63 60: R\$ 13,90



GIZÃO CERA 6 CORES 230 GRS 1 INFAN 4318
Código: Fábrica: Unidade:
47392 LEO&LEO CX/1
F1 F4

UN: R\$ 0,75 AV: R\$ 8,98 15: R\$ 9,16
30: R\$ 9,35 45: R\$ 9,53 60: R\$ 9,72



GLITER 3 GRS AZUL CLARO 12X1
Código: Fábrica: Unidade:
45060 CITY BRILHO CX/12
F1 F4

UN: R\$ 0,75 AV: R\$ 8,98 15: R\$ 9,16
30: R\$ 9,35 45: R\$ 9,53 60: R\$ 9,72



GLITER 3 GRS AZUL 12X1
Código: Fábrica: Unidade:
7465 CITY BRILHO CX/12
F1 F4

UN: R\$ 0,75 AV: R\$ 8,98 15: R\$ 9,16
30: R\$ 9,35 45: R\$ 9,53 60: R\$ 9,72



GLITER 3 GRS BRANCO PEROLADO 12X1
Código: Fábrica: Unidade:
7468 CITY BRILHO CX/12
F1 F4

UN: R\$ 0,75 AV: R\$ 8,98 15: R\$ 9,16
30: R\$ 9,35 45: R\$ 9,53 60: R\$ 9,72



GLITER 3 GRS DOURADO 12X1
Código: Fábrica: Unidade:
7463 CITY BRILHO CX/12
F1 F4

UN: R\$ 0,75 AV: R\$ 8,98 15: R\$ 9,16
30: R\$ 9,35 45: R\$ 9,53 60: R\$ 9,72



GLITER 3 GRS LARANJA 12X1
Código: Fábrica: Unidade:
26418 CITY BRILHO CX/12
F1 F4

UN: R\$ 0,75 AV: R\$ 8,98 15: R\$ 9,16
30: R\$ 9,35 45: R\$ 9,53 60: R\$ 9,72



GLITER 3 GRS LILAS 12X1
Código: Fábrica: Unidade:
15677 CITY BRILHO CX/12
F1 F4

UN: R\$ 0,75 AV: R\$ 8,98 15: R\$ 9,16
30: R\$ 9,35 45: R\$ 9,53 60: R\$ 9,72



GLITER 3 GRS PINK 12X1
Código: Fábrica: Unidade:
15675 CITY BRILHO CX/12
F1 F4

UN: R\$ 0,75 AV: R\$ 8,98 15: R\$ 9,16
30: R\$ 9,35 45: R\$ 9,53 60: R\$ 9,72



GLITER 3 GRS PRATA 12X1
Código: Fábrica: Unidade:
7464 CITY BRILHO CX/12
F1 F4

UN: R\$ 0,75 AV: R\$ 8,98 15: R\$ 9,16
30: R\$ 9,35 45: R\$ 9,53 60: R\$ 9,72



GLITER 3 GRS PRETO 12X1
Código: Fábrica: Unidade:
12770 CITY BRILHO CX/12
F1 F4

UN: R\$ 0,75 AV: R\$ 8,98 15: R\$ 9,16
30: R\$ 9,35 45: R\$ 9,53 60: R\$ 9,72



GLITER 3 GRS ROSA 12X1
Código: Fábrica: Unidade:
7467 CITY BRILHO CX/12
F1 F4

UN: R\$ 0,75 AV: R\$ 8,98 15: R\$ 9,16
30: R\$ 9,35 45: R\$ 9,53 60: R\$ 9,72



GLITER 3 GRS ROXO 12X1
Código: Fábrica: Unidade:
15676 CITY BRILHO CX/12
F1 F4

UN: R\$ 0,75 AV: R\$ 8,98 15: R\$ 9,16
30: R\$ 9,35 45: R\$ 9,53 60: R\$ 9,72



GLITER 3 GRS SORTIDO 12X1
Código: Fábrica: Unidade:
47723 CITY BRILHO CX/12
F1 F4

UN: R\$ 0,75 AV: R\$ 8,98 15: R\$ 9,16
30: R\$ 9,35 45: R\$ 9,53 60: R\$ 9,72



GLITER 3 GRS VERDE 12X1
Código: Fábrica: Unidade:
7466 CITY BRILHO CX/12
F1 F4

UN: R\$ 0,75 AV: R\$ 8,98 15: R\$ 9,16
30: R\$ 9,35 45: R\$ 9,53 60: R\$ 9,72



GLITER 3 GRS VERMELHO 12X1
Código: Fábrica: Unidade:
26 CITY BRILHO CX/12
F1 F4

UN: R\$ 9,97 AV: R\$ 9,97 15: R\$ 10,18
30: R\$ 10,39 45: R\$ 10,59 60: R\$ 10,81



GLITER 100 GRS AZUL
Código: Fábrica: Unidade:
15534 CITY BRILHO PT/1
F1 F4

UN: R\$ 9,97 AV: R\$ 9,97 15: R\$ 10,18
30: R\$ 10,39 45: R\$ 10,59 60: R\$ 10,81



GLITER 100 GRS LILAS
Código: 9805 Fábrica: CITY BRILHO Unidade: PT/1 F1 F4

UN: R\$ 9,97 AV: R\$ 9,97 15: R\$ 10,18
30: R\$ 10,39 45: R\$ 10,59 60: R\$ 10,81



GLITER 100 GRS PEROLADO
Código: 26345 Fábrica: CITY BRILHO Unidade: PT/1 F1 F4

UN: R\$ 9,97 AV: R\$ 9,97 15: R\$ 10,18
30: R\$ 10,39 45: R\$ 10,59 60: R\$ 10,81



GLITER 100 GRS PINK
Código: 15533 Fábrica: CITY BRILHO Unidade: PT/1 F1 F4

UN: R\$ 9,97 AV: R\$ 9,97 15: R\$ 10,18
30: R\$ 10,39 45: R\$ 10,59 60: R\$ 10,81



GLITER 100 GRS PRATA
Código: 15531 Fábrica: CITY BRILHO Unidade: PT/1 F1 F4

UN: R\$ 9,97 AV: R\$ 9,97 15: R\$ 10,18
30: R\$ 10,39 45: R\$ 10,59 60: R\$ 10,81



GLITER 100 GRS VERMELHO
Código: 15532 Fábrica: CITY BRILHO Unidade: PT/1 F1 F4

UN: R\$ 42,92 AV: R\$ 42,92 15: R\$ 43,82
30: R\$ 44,69 45: R\$ 45,59 60: R\$ 46,50



GLITER 500 GRS AZUL
Código: 42453 Fábrica: CITY BRILHO Unidade: PT/1 F1 F4

UN: R\$ 42,92 AV: R\$ 42,92 15: R\$ 43,82
30: R\$ 44,69 45: R\$ 45,59 60: R\$ 46,50



GLITER 500 GRS AZUL CLARO
Código: 50012 Fábrica: CITY BRILHO Unidade: PT/1 F1 F4

UN: R\$ 42,92 AV: R\$ 42,92 15: R\$ 43,82
30: R\$ 44,69 45: R\$ 45,59 60: R\$ 46,50



GLITER 500 GRS BRONZE
Código: 50010 Fábrica: CITY BRILHO Unidade: PT/1 F1 F4

UN: R\$ 42,92 AV: R\$ 42,92 15: R\$ 43,82
30: R\$ 44,69 45: R\$ 45,59 60: R\$ 46,50



GLITER 500 GRS CHUMBO
Código: 50015 Fábrica: CITY BRILHO Unidade: PT/1 F1 F4

UN: R\$ 42,92 AV: R\$ 42,92 15: R\$ 43,82
30: R\$ 44,69 45: R\$ 45,59 60: R\$ 46,50



GLITER 500 GRS LARANJA
Código: 50014 Fábrica: CITY BRILHO Unidade: PT/1 F1 F4

UN: R\$ 42,92 AV: R\$ 42,92 15: R\$ 43,82
30: R\$ 44,69 45: R\$ 45,59 60: R\$ 46,50



GLITER 500 GRS LILAS
Código: 44168 Fábrica: CITY BRILHO Unidade: PT/1 F1 F4

UN: R\$ 42,92 AV: R\$ 42,92 15: R\$ 43,82
30: R\$ 44,69 45: R\$ 45,59 60: R\$ 46,50



GLITER 500 GRS MARRON
Código: 50011 Fábrica: CITY BRILHO Unidade: PT/1 F1 F4

UN: R\$ 42,92 AV: R\$ 42,92 15: R\$ 43,82
30: R\$ 44,69 45: R\$ 45,59 60: R\$ 46,50



GLITER 500 GRS OURO/AMARELO
Código: 41879 Fábrica: CITY BRILHO Unidade: PT/1 F1 F4

UN: R\$ 42,92 AV: R\$ 42,92 15: R\$ 43,82
30: R\$ 44,69 45: R\$ 45,59 60: R\$ 46,50



GLITER 500 GRS PEROLADO
Código: 41881 Fábrica: CITY BRILHO Unidade: PT/1 F1 F4

UN: R\$ 42,92 AV: R\$ 42,92 15: R\$ 43,82
30: R\$ 44,69 45: R\$ 45,59 60: R\$ 46,50



GLITER 500 GRS PINK
Código: 50009 Fábrica: CITY BRILHO Unidade: PT/1 F1 F4

UN: R\$ 42,92 AV: R\$ 42,92 15: R\$ 43,82
30: R\$ 44,69 45: R\$ 45,59 60: R\$ 46,50



GLITER 500 GRS PRATA
Código: 41880 Fábrica: CITY BRILHO Unidade: PT/1 F1 F4

UN: R\$ 42,92 AV: R\$ 42,92 15: R\$ 43,82
30: R\$ 44,69 45: R\$ 45,59 60: R\$ 46,50



GLITER 500 GRS PRETO
Código: 44167 Fábrica: CITY BRILHO Unidade: PT/1 F1 F4

UN: R\$ 42,92 AV: R\$ 42,92 15: R\$ 43,82
30: R\$ 44,69 45: R\$ 45,59 60: R\$ 46,50



GLITER 500 GRS ROSA
Código: 44133 Fábrica: CITY BRILHO Unidade: PT/1 F1 F4

UN: R\$ 42,92 AV: R\$ 42,92 15: R\$ 43,82
30: R\$ 44,69 45: R\$ 45,59 60: R\$ 46,50



GLITER 500 GRS ROXO
Código: 50008 Fábrica: CITY BRILHO Unidade: PT/1 F1 F4

UN: R\$ 42,92 AV: R\$ 42,92 15: R\$ 43,82
30: R\$ 44,69 45: R\$ 45,59 60: R\$ 46,50



GLITER 500 GRS VERDE
Código: 42454 Fábrica: CITY BRILHO Unidade: PT/1 F1 F4

UN: R\$ 42,92 AV: R\$ 42,92 15: R\$ 43,82
30: R\$ 44,69 45: R\$ 45,59 60: R\$ 46,50



GLITER 500 GRS VERDE CLARO
Código: 50013 Fábrica: CITY BRILHO Unidade: PT/1 F1 F4

UN: R\$ 42,92 AV: R\$ 42,92 15: R\$ 43,82
30: R\$ 44,69 45: R\$ 45,59 60: R\$ 46,50



GLITER 500 GRS VERMELHO
Código: 44169 Fábrica: CITY BRILHO Unidade: PT/1 F1 F4

UN: R\$ 14,88 AV: R\$ 74,38 15: R\$ 75,93
30: R\$ 77,45 45: R\$ 79,00 60: R\$ 80,58



GOLA HIGIENICA BRANCA 6,6CM 5X100
Código: 48138 Fábrica: SEKICH Unidade: PT/5 F1 F4

UN: R\$ 1,25 AV: R\$ 29,95 15: R\$ 30,58
30: R\$ 31,19 45: R\$ 31,81 60: R\$ 32,45



GRAFITE 0.5MM EST 20 MINAS BETTY B 24X1
Código: 38556 Fábrica: TRIS Unidade: CX/24 F1 F4

UN: R\$ 0,62 AV: R\$ 14,97 15: R\$ 15,28
30: R\$ 15,58 45: R\$ 15,90 60: R\$ 16,21



GRAFITE 0.5MM HB COLOR EST 12 MINA 24X1
Código: 47994 Fábrica: MECHANICAL Unidade: CX/24 F1 F4

UN: R\$ 0,83 AV: R\$ 9,97 15: R\$ 10,18
30: R\$ 10,39 45: R\$ 10,59 60: R\$ 10,81



GRAFITE 0.5MM HB EST 12 MINAS 12X1
Código: 43811 Fábrica: WIN PAPER Unidade: PT/12 F1 F4

UN: R\$ 0,83 AV: R\$ 9,97 15: R\$ 10,18
30: R\$ 10,39 45: R\$ 10,59 60: R\$ 10,81



GRAFITE 0.5MM HB EST 12 MINAS 12X1
Código: 6772 Fábrica: LEO&LEO Unidade: CX/12 F1 F4

UN: R\$ 0,83 AV: R\$ 9,97 15: R\$ 10,18
30: R\$ 10,39 45: R\$ 10,59 60: R\$ 10,81



GRAFITE 0.5MM HB EST 12 MINAS 12X1
Código: 19716 Fábrica: CONCEPT Unidade: DZ/12 F1 F4

UN: R\$ 0,91 AV: R\$ 10,97 15: R\$ 11,20
30: R\$ 11,43 45: R\$ 11,65 60: R\$ 11,89



GRAFITE 0.5MM HB EST 12 MINAS 12X1
Código: 7157 Fábrica: STYLO Unidade: PT/12 F1 F4

UN: R\$ 0,83 AV: R\$ 9,97 15: R\$ 10,18
30: R\$ 10,39 45: R\$ 10,59 60: R\$ 10,81



GRAFITE 0.5MM HB EST 12 MINAS 12X1
Código: 18932 Fábrica: GOLLER Unidade: DZ/12 F1 F4

UN: R\$ 0,50 AV: R\$ 11,97 15: R\$ 12,22
30: R\$ 12,46 45: R\$ 12,71 60: R\$ 12,97



GRAFITE 0.5MM HB EST 12 MINAS 24X1
Código: 19561 Fábrica: CLASSE Unidade: CX/24 F1 F4

UN: R\$ 0,50 AV: R\$ 11,97 15: R\$ 12,22
30: R\$ 12,46 45: R\$ 12,71 60: R\$ 12,97



GRAFITE 0.5MM HB EST 20 MINAS 24X1
Código: 47996 Fábrica: HANSA Unidade: CX/24 F1 F4

UN: R\$ 1,00 AV: R\$ 11,97 15: R\$ 12,22
30: R\$ 12,46 45: R\$ 12,71 60: R\$ 12,97



GRAFITE 0.5MM HB EST 24 MINAS 12X1
Código: Fábrica: Unidade:
47995 CLASSE CX/12
F1 F4

UN: R\$ 0,50 AV: R\$ 11,97 15: R\$ 12,22
30: R\$ 12,46 45: R\$ 12,71 60: R\$ 12,97



GRAFITE 0.5MM HB EST 30 MINAS 24X1
Código: Fábrica: Unidade:
19560 CLASSE CX/24
F1 F4

UN: R\$ 0,83 AV: R\$ 9,97 15: R\$ 10,18
30: R\$ 10,39 45: R\$ 10,59 60: R\$ 10,81



GRAFITE 0.5MM 2B EST 12 MINAS 12X1
Código: Fábrica: Unidade:
7160 ADECK CX/12
F1 F4

UN: R\$ 0,27 AV: R\$ 6,49 15: R\$ 6,62
30: R\$ 6,76 45: R\$ 6,89 60: R\$ 7,03



GRAFITE 0.5MM 2B EST 12 MINAS 24X1
Código: Fábrica: Unidade:
13072 CLASSE CX/24
F1 F4

UN: R\$ 1,00 AV: R\$ 11,97 15: R\$ 12,22
30: R\$ 12,46 45: R\$ 12,71 60: R\$ 12,97



GRAFITE 0.5MM 2B EST 24 MINAS 12X1
Código: Fábrica: Unidade:
22178 CLASSE CX/12
F1 F4

UN: R\$ 0,75 AV: R\$ 8,98 15: R\$ 9,16
30: R\$ 9,35 45: R\$ 9,53 60: R\$ 9,72



GRAFITE 0.7MM HB EST 12 MINAS 12X1
Código: Fábrica: Unidade:
2537 LEO&LEO PT/12
F1 F4

UN: R\$ 1,00 AV: R\$ 11,97 15: R\$ 12,22
30: R\$ 12,46 45: R\$ 12,71 60: R\$ 12,97



GRAFITE 0.9MM HB EST 12 MINAS 12X1
Código: Fábrica: Unidade:
46791 UFFIZI CX/12
F1 F4

UN: R\$ 1,00 AV: R\$ 11,97 15: R\$ 12,22
30: R\$ 12,46 45: R\$ 12,71 60: R\$ 12,97



GRAFITE 0.9MM HB EST 12 MINAS 12X1
Código: Fábrica: Unidade:
18699 GOLLER PT/12
F1 F4

UN: R\$ 1,00 AV: R\$ 11,97 15: R\$ 12,22
30: R\$ 12,46 45: R\$ 12,71 60: R\$ 12,97



GRAFITE 0.9MM HB EST 12 MINAS 12X1
Código: Fábrica: Unidade:
47997 LEO&LEO PT/12
F1 F4

UN: R\$ 21,32 AV: R\$ 21,32 15: R\$ 21,76
30: R\$ 22,20 45: R\$ 22,64 60: R\$ 23,09



GRAMPEADOR ALICATE METAL 25F 2153
Código: Fábrica: Unidade:
48849 FIRST UN/1
F1 F4

UN: R\$ 24,95 AV: R\$ 24,95 15: R\$ 25,47
30: R\$ 25,98 45: R\$ 26,50 60: R\$ 27,03



GRAMPEADOR ALICATE METAL 15F+2000GRAM 10
Código: Fábrica: Unidade:
47889 SOON UN/1
F1 F4

UN: R\$ 40,92 AV: R\$ 40,92 15: R\$ 41,78
30: R\$ 42,61 45: R\$ 43,46 60: R\$ 44,33



GRAMPEADOR ALICATE METAL 17CM 26/6 45F
Código: Fábrica: Unidade:
50679 WINPAPER UN/1
F1 F4

UN: R\$ 25,36 AV: R\$ 25,36 15: R\$ 25,89
30: R\$ 26,41 45: R\$ 26,93 60: R\$ 27,47



GRAMPEADOR ALICATE METAL 24/6 20FLS 131
Código: Fábrica: Unidade:
43395 YIZHIWANG UN/1
F1 F4

UN: R\$ 24,95 AV: R\$ 24,95 15: R\$ 25,47
30: R\$ 25,98 45: R\$ 26,50 60: R\$ 27,03



GRAMPEADOR ALICATE METAL 25FLS 93048
Código: Fábrica: Unidade:
39906 JOCAROFFICE UN/1
F1 F4

UN: R\$ 18,96 AV: R\$ 18,96 15: R\$ 19,35
30: R\$ 19,74 45: R\$ 20,14 60: R\$ 20,54



GRAMPEADOR ALICATE METAL 26/6 20FLS 6014
Código: Fábrica: Unidade:
50680 WINPAPER UN/1
F1 F4

UN: R\$ 22,56 AV: R\$ 22,56 15: R\$ 23,03
30: R\$ 23,49 45: R\$ 23,96 60: R\$ 24,44



GRAMPEADOR ALICATE METAL 26/6 25FLS 5227
Código: Fábrica: Unidade:
50208 BAZZE UN/1
F1 F4

UN: R\$ 35,56 AV: R\$ 35,56 15: R\$ 36,30
30: R\$ 37,03 45: R\$ 37,77 60: R\$ 38,53



GRAMPEADOR ALICATE METAL 26/6 25FLS 887
Código: Fábrica: Unidade:
39780 MASTERPRINT UN/1
F1 F4

UN: R\$ 49,91 AV: R\$ 49,91 15: R\$ 50,95
30: R\$ 51,97 45: R\$ 53,01 60: R\$ 54,07



GRAMPEADOR ALICATE METAL 45F 24/26/6 158
Código: Fábrica: Unidade:
47924 YIN'S PAPER UN/1
F1 F4

UN: R\$ 135,77 AV: R\$ 135,77 15: R\$ 138,60
30: R\$ 141,37 45: R\$ 144,20 60: R\$ 147,08



GRAMPEADOR METAL EXTRA G 30CM 100FL 1069
Código: Fábrica: Unidade:
41762 GRAMP LINE UN/1
F1 F4

UN: R\$ 74,87 AV: R\$ 74,87 15: R\$ 76,43
30: R\$ 77,96 45: R\$ 79,52 60: R\$ 81,11



GRAMPEADOR METAL EXTRA GDE 100FLS 29CM
Código: Fábrica: Unidade:
41736 MASTERPRINT UN/1
F1 F4

UN: R\$ 9,47 AV: R\$ 9,47 15: R\$ 9,67
30: R\$ 9,87 45: R\$ 10,06 60: R\$ 10,26



GRAMPEADOR METAL MINI C/EXTRAT 16FLS 305
Código: Fábrica: Unidade:
39785 MASTERPRINT UN/1
F1 F4

UN: R\$ 49,91 AV: R\$ 49,91 15: R\$ 50,95
30: R\$ 51,97 45: R\$ 53,01 60: R\$ 54,07



GRAMPEADOR METAL PISTOL 106/6/8 14CM 600
Código: Fábrica: Unidade:
43195 BRW UN/1
F1 F4

UN: R\$ 33,94 AV: R\$ 33,94 15: R\$ 34,64
30: R\$ 35,34 45: R\$ 36,04 60: R\$ 36,76



GRAMPEADOR METAL PISTOL 13/4-8 15CM 6017
Código: Fábrica: Unidade:
50678 WIN PAPER UN/1
F1 F4

UN: R\$ 108,38 AV: R\$ 108,38 15: R\$ 110,63
30: R\$ 112,85 45: R\$ 115,10 60: R\$ 117,41



GRAMPEADOR METAL PROFIS 240FL BM2144
Código: Fábrica: Unidade:
48848 FIRST UN/1
F1 F4

UN: R\$ 46,91 AV: R\$ 46,91 15: R\$ 47,89
30: R\$ 48,85 45: R\$ 49,83 60: R\$ 50,82



GRAMPEADOR METAL 19,5CM 25FLS 400
Código: Fábrica: Unidade:
43394 MASTERPRINT UN/1
F1 F4

UN: R\$ 41,38 AV: R\$ 41,38 15: R\$ 42,25
30: R\$ 43,09 45: R\$ 43,95 60: R\$ 44,83



GRAMPEADOR METAL 20CM 30FLS 93016
Código: Fábrica: Unidade:
45229 JOCAROFFICE UN/1
F1 F4

UN: R\$ 39,93 AV: R\$ 39,93 15: R\$ 40,76
30: R\$ 41,57 45: R\$ 42,40 60: R\$ 43,25



GRAMPEADOR METAL 50FL 613031
Código: Fábrica: Unidade:
48811 BAZZE PT/1
F1 F4

UN: R\$ 41,92 AV: R\$ 41,92 15: R\$ 42,80
30: R\$ 43,65 45: R\$ 44,53 60: R\$ 45,42



GRAMPEADOR PISTOLA TAPECEIRO 15CM 98931
Código: Fábrica: Unidade:
46426 KAZ UN/1
F1 F4

UN: R\$ 34,46 AV: R\$ 34,46 15: R\$ 35,18
30: R\$ 35,89 45: R\$ 36,60 60: R\$ 37,34



GRAMPEADOR PISTOLA 23/4 13/4 24/6 15CM
Código: Fábrica: Unidade:
50331 FIRST UN/1
F1 F4

UN: R\$ 39,93 AV: R\$ 39,93 15: R\$ 40,76
30: R\$ 41,57 45: R\$ 42,40 60: R\$ 43,25



GRAMPEADOR PROF METAL 13/4-6-8 45FL 6028
Código: Fábrica: Unidade:
50681 WINPAPER UN/1
F1 F4

UN: R\$ 69,88 AV: R\$ 69,88 15: R\$ 71,33
30: R\$ 72,76 45: R\$ 74,22 60: R\$ 75,70



GRAMPEADOR PROF METAL 23/6-8 100FL 6015
Código: Fábrica: Unidade:
50685 WINPAPER UN/1
F1 F4

UN: R\$ 67,79 AV: R\$ 67,79 15: R\$ 69,20
30: R\$ 70,59 45: R\$ 72,00 60: R\$ 73,44



GRAMPEADOR TAPECEIRO 106/6 108/6 16CM 51
Código: Fábrica: Unidade:
50330 FIRST UN/1
F1 F4

UN: R\$ 69,88 AV: R\$ 69,88 15: R\$ 71,33
30: R\$ 72,76 45: R\$ 74,22 60: R\$ 75,70



GRAMPEADOR 106 METAL PROF TAPECARIA 16CM
Código: Fábrika: Unidade:
46382 FUTURO UN/1
F1 F4

UN: R\$ 166,72 AV: R\$ 166,72 15: R\$ 170,20
30: R\$ 173,60 45: R\$ 177,07 60: R\$ 180,61



GRAMPEADOR 23/06 A 23/24 METAL 30CM 240F
Código: Fábrika: Unidade:
46429 KAZ UN/1
F1 F4

UN: R\$ 174,42 AV: R\$ 174,42 15: R\$ 178,05
30: R\$ 181,62 45: R\$ 185,25 60: R\$ 188,95



GRAMPEADOR 23/24 METAL 29CM 240FL 262214
Código: Fábrika: Unidade:
46333 FUTURO UN/1
F1 F4

UN: R\$ 69,88 AV: R\$ 69,88 15: R\$ 71,33
30: R\$ 72,76 45: R\$ 74,22 60: R\$ 75,70



GRAMPEADOR 23/6 23/13 METAL 28,5CM 100FL
Código: Fábrika: Unidade:
44497 DOTAD UN/1
F1 F4

UN: R\$ 197,67 AV: R\$ 197,67 15: R\$ 201,79
30: R\$ 205,83 45: R\$ 209,94 60: R\$ 214,14



GRAMPEADOR 23/6/20/24 METAL 28CM 240FLS
Código: Fábrika: Unidade:
42582 BRW UN/1
F1 F4

UN: R\$ 187,69 AV: R\$ 187,69 15: R\$ 191,60
30: R\$ 195,43 45: R\$ 199,34 60: R\$ 203,33



GRAMPEADOR 23/6/8/10/ METAL 29CM 200FLS
Código: Fábrika: Unidade:
44238 MAXPRINT UN/1
F1 F4

UN: R\$ 89,85 AV: R\$ 89,85 15: R\$ 91,72
30: R\$ 93,55 45: R\$ 95,42 60: R\$ 97,33



GRAMPEADOR 24/6 METAL 27CM 100FL
Código: Fábrika: Unidade:
48435 BAZZE PT/1
F1 F4

UN: R\$ 38,15 AV: R\$ 38,15 15: R\$ 38,94
30: R\$ 39,72 45: R\$ 40,52 60: R\$ 41,33



GRAMPEADOR 24/6 24/8 26/8 METAL 19CM 40F
Código: Fábrika: Unidade:
48355 JOCAROFFICE UN/1
F1 F4

UN: R\$ 17,06 AV: R\$ 17,06 15: R\$ 17,42
30: R\$ 17,77 45: R\$ 18,12 60: R\$ 18,48



GRAMPEADOR 24/6 26/6 METAL MED 15FL V300
Código: Fábrika: Unidade:
39924 VMP UN/1
F1 F4

UN: R\$ 19,96 AV: R\$ 19,96 15: R\$ 20,37
30: R\$ 20,78 45: R\$ 21,20 60: R\$ 21,62



GRAMPEADOR 24/6 26/6 METAL MED 2000
Código: Fábrika: Unidade:
18706 BRW UN/1
F1 F4

UN: R\$ 19,47 AV: R\$ 19,47 15: R\$ 19,87
30: R\$ 20,27 45: R\$ 20,68 60: R\$ 21,09



GRAMPEADOR 24/6 26/6 METAL MED 301
Código: Fábrika: Unidade:
39782 MASTERPRINT UN/1
F1 F4

UN: R\$ 12,36 AV: R\$ 12,36 15: R\$ 12,62
30: R\$ 12,87 45: R\$ 13,13 60: R\$ 13,39



GRAMPEADOR 24/6 26/6 METAL PEQ 20FLS 300
Código: Fábrika: Unidade:
39781 MASTERPRINT UN/1
F1 F4

UN: R\$ 17,96 AV: R\$ 17,96 15: R\$ 18,34
30: R\$ 18,70 45: R\$ 19,08 60: R\$ 19,46



GRAMPEADOR 24/6 26/6 METAL 10CM 25FL
Código: Fábrika: Unidade:
50028 BAZZE UN/1
F1 F4

UN: R\$ 34,93 AV: R\$ 34,93 15: R\$ 35,66
30: R\$ 36,38 45: R\$ 37,10 60: R\$ 37,84



GRAMPEADOR 24/6 26/6 METAL 16CM 40FL
Código: Fábrika: Unidade:
48321 BAZZE UN/1
F1 F4

UN: R\$ 39,93 AV: R\$ 39,93 15: R\$ 40,76
30: R\$ 41,57 45: R\$ 42,40 60: R\$ 43,25



GRAMPEADOR 24/6 26/6 METAL 20CM 30FLS
Código: Fábrika: Unidade:
46381 FUTURO UN/1
F1 F4

UN: R\$ 13,73 AV: R\$ 13,73 15: R\$ 14,01
30: R\$ 14,29 45: R\$ 14,58 60: R\$ 14,87



GRAMPEADOR 24/6 26/6 METAL 20FLS 1000
Código: Fábrika: Unidade:
41084 BRW UN/1
F1 F4

UN: R\$ 42,92 AV: R\$ 42,92 15: R\$ 43,82
30: R\$ 44,69 45: R\$ 45,59 60: R\$ 46,50



GRAMPEADOR 24/6 26/6 METAL 30 FLS GDE
Código: Fábrica: Unidade:
42457 GATTE UN/1
F1 F4

UN: R\$ 29,99 AV: R\$ 29,99 15: R\$ 29,99
30: R\$ 29,99 45: R\$ 29,99 60: R\$ 29,99



GRAMPEADOR 24/6 26/6 METAL 50F 16CM 2137
Código: Fábrica: Unidade:
48842 FIRST UN/1
F1 F4

UN: R\$ 29,94 AV: R\$ 29,94 15: R\$ 30,57
30: R\$ 31,18 45: R\$ 31,80 60: R\$ 32,44



GRAMPEADOR 24/6 26/6 METAL 15CM 20F 2001
Código: Fábrica: Unidade:
44994 BRW UN/1
F1 F4

UN: R\$ 49,91 AV: R\$ 49,91 15: R\$ 50,95
30: R\$ 51,97 45: R\$ 53,01 60: R\$ 54,07



GRAMPEADOR 24/6 26/6 METAL 20CM 30F 1110
Código: Fábrica: Unidade:
43854 LIKE UN/1
F1 F4

UN: R\$ 44,92 AV: R\$ 44,92 15: R\$ 45,85
30: R\$ 46,77 45: R\$ 47,71 60: R\$ 48,66



GRAMPEADOR 24/6 26/6 METAL 20CM 30F 3001
Código: Fábrica: Unidade:
43194 BRW UN/1
F1 F4

UN: R\$ 25,95 AV: R\$ 25,95 15: R\$ 26,49
30: R\$ 27,02 45: R\$ 27,56 60: R\$ 28,11



GRAMPEADOR 24/6 26/6 METAL 20CM 30F 6012
Código: Fábrica: Unidade:
50682 WINPAPER UN/1
F1 F4

UN: R\$ 43,92 AV: R\$ 43,92 15: R\$ 44,83
30: R\$ 45,73 45: R\$ 46,65 60: R\$ 47,58



GRAMPEADOR 24/6 26/6 METAL 16CM 50FL
Código: Fábrica: Unidade:
46428 KAZ UN/1
F1 F4

UN: R\$ 65,88 AV: R\$ 65,88 15: R\$ 67,26
30: R\$ 68,60 45: R\$ 69,97 60: R\$ 71,37



GRAMPEADOR 24/6 26/6 METAL 50FL 3002
Código: Fábrica: Unidade:
43187 BRW UN/1
F1 F4

UN: R\$ 41,92 AV: R\$ 41,92 15: R\$ 42,80
30: R\$ 43,65 45: R\$ 44,53 60: R\$ 45,42



GRAMPEADOR 26/6 METAL 20CM 40FL 7317
Código: Fábrica: Unidade:
46427 KAZ UN/1
F1 F4

UN: R\$ 8,98 AV: R\$ 8,98 15: R\$ 9,16
30: R\$ 9,35 45: R\$ 9,53 60: R\$ 9,72



GRAMPO GRAMPEADOR COBREADO 26/6 5000X1
Código: Fábrica: Unidade:
24962 JOCAROFFICE CX/1
F1 F4

UN: R\$ 9,53 AV: R\$ 9,53 15: R\$ 9,73
30: R\$ 9,93 45: R\$ 10,13 60: R\$ 10,33



GRAMPO GRAMPEADOR COBREADO 26/6 5000X1
Código: Fábrica: Unidade:
46518 LVC CX/1
F1 F4

UN: R\$ 6,98 AV: R\$ 6,98 15: R\$ 7,12
30: R\$ 7,27 45: R\$ 7,41 60: R\$ 7,56



GRAMPO GRAMPEADOR COBREADO 26/6 5000X1
Código: Fábrica: Unidade:
48322 BAZZE CX/1
F1 F4

UN: R\$ 5,67 AV: R\$ 5,67 15: R\$ 5,79
30: R\$ 5,90 45: R\$ 6,02 60: R\$ 6,14



GRAMPO GRAMPEADOR GALV 26/6 5000X1
Código: Fábrica: Unidade:
19708 CIS CX/1
F1 F4

UN: R\$ 0,01 AV: R\$ 9,68 15: R\$ 9,89
30: R\$ 10,08 45: R\$ 10,29 60: R\$ 10,49



GRAMPO GRAMPEADOR GALV 9/12 1000X1
Código: Fábrica: Unidade:
44191 BACCHI CX/1000
F1 F4

UN: R\$ 14,23 AV: R\$ 14,23 15: R\$ 14,52
30: R\$ 14,81 45: R\$ 15,11 60: R\$ 15,41

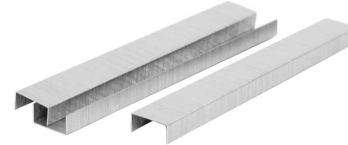

GRAMPO GRAMPEADOR GALV 160/6 1124 3500X1
Código: Fábrica: Unidade:
49134 JOCAROFFICE CX/1
F1 F4

UN: R\$ 4,53 AV: R\$ 4,53 15: R\$ 4,63
30: R\$ 4,72 45: R\$ 4,81 60: R\$ 4,91

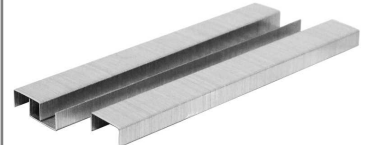

GRAMPO GRAMPEADOR GALV 26/6 5000 5000X1
Código: Fábrica: Unidade:
49154 BRW CX/1
F1 F4

UN: R\$ 5,58 AV: R\$ 5,58 15: R\$ 5,70
30: R\$ 5,81 45: R\$ 5,93 60: R\$ 6,05

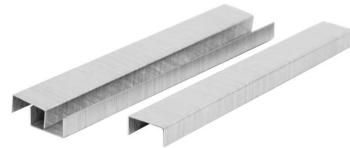

GRAMPO GRAMPEADOR GALV 26/6 93010 5000X1
Código: Fábrika: Unidade:
48351 JOCAROFFICE CX/1
F1 F4

UN: R\$ 0,01 AV: R\$ 5,60 15: R\$ 5,72
30: R\$ 5,83 45: R\$ 5,95 60: R\$ 6,07

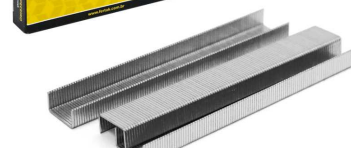

GRAMPO GRAMPEADOR GALV 6MM TAPECE 1000X1
Código: Fábrika: Unidade:
48061 FERTAK CX/1000
F1 F4

UN: R\$ 0,01 AV: R\$ 5,46 15: R\$ 5,58
30: R\$ 5,69 45: R\$ 5,80 60: R\$ 5,92



GRAMPO GRAMPEADOR GALV 8MM TAPECE 1000X1
Código: Fábrika: Unidade:
48062 FERTAK CX/1000
F1 F4

UN: R\$ 26,95 AV: R\$ 26,95 15: R\$ 27,51
30: R\$ 28,06 45: R\$ 28,62 60: R\$ 29,19



GRAMPO GRAMPEADOR GALVAN 23/10 5000X1
Código: Fábrika: Unidade:
42150 BRW CX/1
F1 F4

UN: R\$ 31,94 AV: R\$ 31,94 15: R\$ 32,60
30: R\$ 33,26 45: R\$ 33,92 60: R\$ 34,60



GRAMPO GRAMPEADOR GALVAN 23/13 5000X1
Código: Fábrika: Unidade:
41759 BRW CX/1
F1 F4

UN: R\$ 9,28 AV: R\$ 9,28 15: R\$ 9,47
30: R\$ 9,66 45: R\$ 9,85 60: R\$ 10,05



GRAMPO GRAMPEADOR GALVAN 23/17 1000X1
Código: Fábrika: Unidade:
44987 BRW CX/1
F1 F4

UN: R\$ 35,31 AV: R\$ 35,31 15: R\$ 36,05
30: R\$ 36,77 45: R\$ 37,51 60: R\$ 38,26



GRAMPO GRAMPEADOR GALVAN 23/20 1000X1
Código: Fábrika: Unidade:
44988 BRW CX/1
F1 F4

UN: R\$ 0,03 AV: R\$ 25,36 15: R\$ 25,89
30: R\$ 26,41 45: R\$ 26,93 60: R\$ 27,47



GRAMPO GRAMPEADOR GALVAN 23/20 1000X1
Código: Fábrika: Unidade:
44190 BACCHI CX/1000
F1 F4

UN: R\$ 23,61 AV: R\$ 23,61 15: R\$ 24,10
30: R\$ 24,59 45: R\$ 25,08 60: R\$ 25,58



GRAMPO GRAMPEADOR GALVAN 23/6 5000X1
Código: Fábrika: Unidade:
44989 BRW CX/1
F1 F4

UN: R\$ 0,01 AV: R\$ 30,94 15: R\$ 31,59
30: R\$ 32,22 45: R\$ 32,86 60: R\$ 33,52



GRAMPO GRAMPEADOR GALVAN 23/8 5000X1
Código: Fábrika: Unidade:
43247 BACCHI CX/5000
F1 F4

UN: R\$ 0,01 AV: R\$ 5,69 15: R\$ 5,81
30: R\$ 5,93 45: R\$ 6,04 60: R\$ 6,17



GRAMPO GRAMPEADOR GALVAN 24/6 1000X1
Código: Fábrika: Unidade:
44192 BACCHI CX/1000
F1 F4

UN: R\$ 2,00 AV: R\$ 2,00 15: R\$ 2,04
30: R\$ 2,08 45: R\$ 2,12 60: R\$ 2,16



GRAMPO GRAMPEADOR GALVAN 26/6 1000X1
Código: Fábrika: Unidade:
47388 JOCAROFFICE CX/1
F1 F4

UN: R\$ 1,65 AV: R\$ 1,65 15: R\$ 1,68
30: R\$ 1,72 45: R\$ 1,75 60: R\$ 1,78

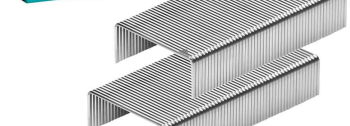

GRAMPO GRAMPEADOR GALVAN 26/6 1000X1
Código: Fábrika: Unidade:
50033 BAZZE CX/1
F1 F4

UN: R\$ 4,98 AV: R\$ 4,98 15: R\$ 5,09
30: R\$ 5,19 45: R\$ 5,29 60: R\$ 5,40

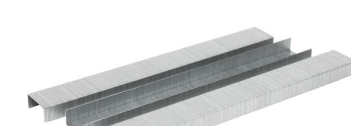

GRAMPO GRAMPEADOR GALVAN 26/6 5000X1
Código: Fábrika: Unidade:
18293 MASTER/NINES CX/1
F1 F4

UN: R\$ 10,63 AV: R\$ 10,63 15: R\$ 10,85
30: R\$ 11,07 45: R\$ 11,29 60: R\$ 11,52

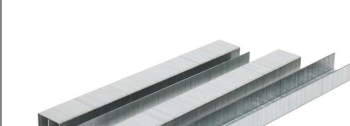

GRAMPO GRAMPEADOR GALVAN 26/8 5000X1
Código: Fábrika: Unidade:
44990 BRW CX/1
F1 F4

UN: R\$ 17,30 AV: R\$ 17,30 15: R\$ 17,66
30: R\$ 18,02 45: R\$ 18,38 60: R\$ 18,74



GRAMPO GRAMPEADOR GALVAN 106/6 3500X1
Código: Fábrika: Unidade:
43190 BRW CX/1
F1 F4

UN: R\$ 19,96 AV: R\$ 19,96 15: R\$ 20,37
30: R\$ 20,78 45: R\$ 21,20 60: R\$ 21,62

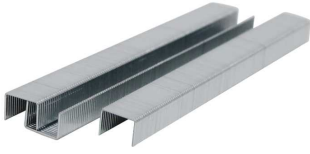

GRAMPO GRAMPEADOR GALVAN 106/8 2500X1
Código: Fábrika: Unidade:
46835 WIN PAPER CX/1
F1 F4

UN: R\$ 17,59 AV: R\$ 17,59 15: R\$ 17,96
30: R\$ 18,32 45: R\$ 18,68 60: R\$ 19,06



GRAMPO GRAMPEADOR GALVAN 106/8 3000X1
Código: Fábrika: Unidade:
43192 BRW CX/1
F1 F4

UN: R\$ 5,99 AV: R\$ 5,99 15: R\$ 5,99
30: R\$ 5,99 45: R\$ 5,99 60: R\$ 5,99

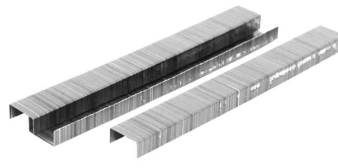

GRAMPO GRAMPEADOR GALVAN 26/6 5000X1
Código: Fábrika: Unidade:
46517 LVC CX/1
F1 F4

AV: R\$ 5,98 15: R\$ 6,11
30: R\$ 6,23 45: R\$ 6,35 60: R\$ 6,48



GRAMPO GRAMPEADOR GALVAN 26/6 5000X1
Código: Fábrika: Unidade:
49961 BAZZE CX/5000
F1 F4

UN: R\$ 6,98 AV: R\$ 6,98 15: R\$ 7,12
30: R\$ 7,27 45: R\$ 7,41 60: R\$ 7,56

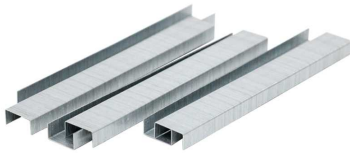

GRAMPO GRAMPEADOR GALVAN 26/6 5000X1
Código: Fábrika: Unidade:
45391 NOX CX/1
F1 F4

UN: R\$ 0,47 AV: R\$ 5,59 15: R\$ 5,71
30: R\$ 5,82 45: R\$ 5,94 60: R\$ 6,06

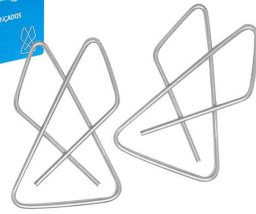

GRAMPO TRANCADO GALVAN 1 METAL 12X1
Código: Fábrika: Unidade:
44184 BACCHI CX/12
F1 F4

UN: R\$ 0,21 AV: R\$ 10,63 15: R\$ 10,85
30: R\$ 11,07 45: R\$ 11,29 60: R\$ 11,52

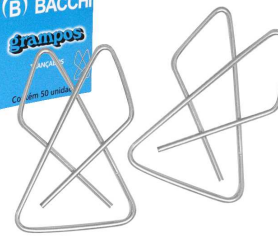

GRAMPO TRANCADO GALVAN 2 METAL 50X1
Código: Fábrika: Unidade:
44185 BACCHI CX/50
F1 F4

UN: R\$ 0,30 AV: R\$ 14,97 15: R\$ 15,28
30: R\$ 15,58 45: R\$ 15,90 60: R\$ 16,21



GRAMPO TRILHO GALVAN 80MM P/PASTA 50X1
Código: Fábrika: Unidade:
11063 JOCAROFFICE CX/50
F1 F4

UN: R\$ 0,22 AV: R\$ 10,99 15: R\$ 10,99
30: R\$ 10,99 45: R\$ 10,99 60: R\$ 10,99



GRAMPO TRILHO PLAST 20CM P/PASTA PT 50X1
Código: Fábrika: Unidade:
44446 POLYCART PT/50
F1 F4

UN: R\$ 0,34 AV: R\$ 16,96 15: R\$ 17,32
30: R\$ 17,66 45: R\$ 18,02 60: R\$ 18,38



GRAMPO TRILHO PLAST 20CM P/PASTA 50X1
Código: Fábrika: Unidade:
42020 WALEU PT/50
F1 F4

UN: R\$ 0,43 AV: R\$ 21,51 15: R\$ 21,95
30: R\$ 22,39 45: R\$ 22,84 60: R\$ 23,30

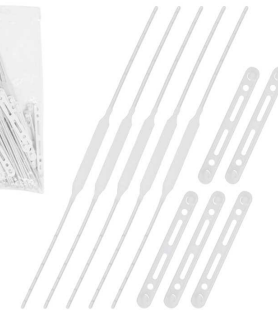

GRAMPO TRILHO PLAST 30CM BC P/PASTA 50X1
Código: Fábrika: Unidade:
47243 FIX PAPER PT/50
F1 F4

UN: R\$ 1,87 AV: R\$ 3,74 15: R\$ 3,82
30: R\$ 3,90 45: R\$ 3,98 60: R\$ 4,06



GRIP P/LAPIS OU CANETA CANDY 8583 2X1
Código: Fábrika: Unidade:
48143 YIN'S PAPER CR/2
F1 F4

UN: R\$ 0,15 AV: R\$ 2,99 15: R\$ 3,05
30: R\$ 3,11 45: R\$ 3,17 60: R\$ 3,23



GUARDANAPO PAPEL 33CM P/DECOUP 1304 20X1
Código: Fábrika: Unidade:
44741 ROCIE PT/20
F1 F4

UN: R\$ 0,83 AV: R\$ 16,67 15: R\$ 17,02
30: R\$ 17,36 45: R\$ 17,71 60: R\$ 18,06



GUARDANAPO PAPEL 33X33CM P/DECOUP 20X1
Código: Fábrika: Unidade:
50079 BOMPACK PT/20
F1 F4

UN: R\$ 147,75 AV: R\$ 147,75 15: R\$ 150,83
30: R\$ 153,85 45: R\$ 156,93 60: R\$ 160,06



GUILHOTINA PAPEL A4/A5 10 FLS 7891
Código: Fábrika: Unidade:
46922 YIN'S PAPER UN/1
F1 F4

UN: R\$ 299,51 AV: R\$ 299,51 15: R\$ 305,75
30: R\$ 311,86 45: R\$ 318,10 60: R\$ 324,46



GUILHOTINA PAPEL 10FLS GPM200 BEGE
Código: Fábrika: Unidade:
44285 MENNO UN/1
F1 F4

UN: R\$ 289,53 AV: R\$ 289,53 15: R\$ 295,56
30: R\$ 301,47 45: R\$ 307,50 60: R\$ 313,65



GUILHOTINA REFILADORA PAPEL 10FLS
Código: Fábrika: Unidade:
46387 KAZ UN/1
F1 F4

UN: R\$ 1,00 AV: R\$ 21,95 15: R\$ 22,41
30: R\$ 22,86 45: R\$ 23,32 60: R\$ 23,78

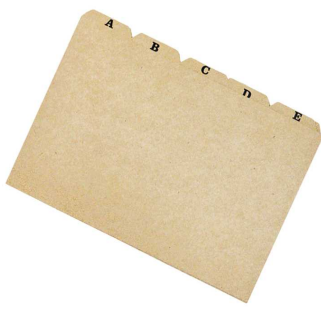

INDICE PAPEL CARTOLINA 3X5 A/Z 3039
Código: Fábrika: Unidade:
44286 MENNO PT/22
F1 F4

UN: R\$ 1,14 AV: R\$ 25,16 15: R\$ 25,68
30: R\$ 26,20 45: R\$ 26,72 60: R\$ 27,26

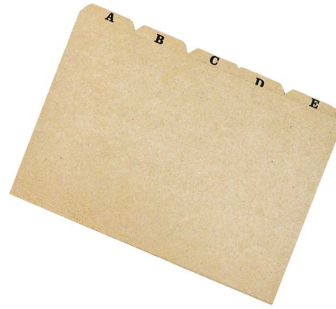

INDICE PAPEL CARTOLINA 4X6 A/Z 3072
Código: Fábrika: Unidade:
44287 MENNO PT/22
F1 F4

UN: R\$ 1,29 AV: R\$ 28,45 15: R\$ 29,05
30: R\$ 29,63 45: R\$ 30,22 60: R\$ 30,83

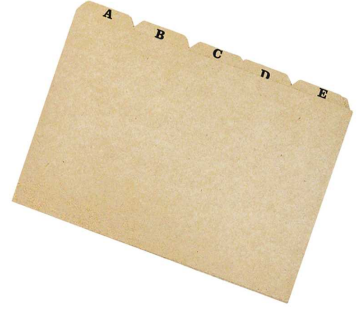

INDICE PAPEL CARTOLINA 5X8 A/Z 3074
Código: Fábrika: Unidade:
44288 MENNO PT/22
F1 F4

UN: R\$ 24,95 AV: R\$ 24,95 15: R\$ 25,47
30: R\$ 25,98 45: R\$ 26,50 60: R\$ 27,03



INDICE TELEFONICO CD PHONE 64 FLS 1236
Código: Fábrika: Unidade:
14634 TILIBRA UN/1
F1 F4

UN: R\$ 2,00 AV: R\$ 2,00 15: R\$ 2,04
30: R\$ 2,08 45: R\$ 2,12 60: R\$ 2,16



INDICE TELEFONICO MED ACRILICO
Código: Fábrika: Unidade:
2541 IMPORTADO UN/1
F1 F4

UN: R\$ 11,80 AV: R\$ 11,80 15: R\$ 12,05
30: R\$ 12,29 45: R\$ 12,53 60: R\$ 12,78



KIT DESENHO MALETA PINTURA 24 PCS 23728
Código: Fábrika: Unidade:
49148 IMPBRINK CJ/1
F1 F4

UN: R\$ 16,62 AV: R\$ 16,62 15: R\$ 16,97
30: R\$ 17,31 45: R\$ 17,66 60: R\$ 18,01



KIT DESENHO MALETA PINTURA 42 PCS 23729
Código: Fábrika: Unidade:
49149 IMPBRINK CJ/1
F1 F4

UN: R\$ 10,07 AV: R\$ 10,07 15: R\$ 10,28
30: R\$ 10,49 45: R\$ 10,70 60: R\$ 10,91



KIT DESENHO MALETA PINTURA 42 PCS 23730
Código: Fábrika: Unidade:
49150 IMPBRINK CJ/1
F1 F4

UN: R\$ 32,22 AV: R\$ 32,22 15: R\$ 32,89
30: R\$ 33,55 45: R\$ 34,22 60: R\$ 34,90



KIT DESENHO MALETA PINTURA 68 PCS 23731
Código: Fábrika: Unidade:
49151 IMPBRINK CJ/1
F1 F4

UN: R\$ 39,41 AV: R\$ 39,41 15: R\$ 40,23
30: R\$ 41,03 45: R\$ 41,85 60: R\$ 42,69



KIT DESENHO MALETA PINTURA 86 PCS 23732
Código: Fábrika: Unidade:
49152 IMPBRINK CJ/1
F1 F4

UN: R\$ 5,98 AV: R\$ 5,98 15: R\$ 6,11
30: R\$ 6,23 45: R\$ 6,35 60: R\$ 6,48



KIT ESCOLAR 1.º GRAU 4 PCS 10130001
Código: Fábrika: Unidade:
24887 WALEU PT/1
F1 F4

UN: R\$ 6,98 AV: R\$ 6,98 15: R\$ 7,12
30: R\$ 7,27 45: R\$ 7,41 60: R\$ 7,56

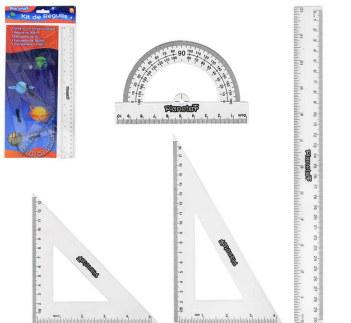

KIT ESCOLAR 1.º GRAU 4 PCS 2918
Código: Fábrika: Unidade:
40787 PLANETA PT/1
F1 F4

UN: R\$ 7,28 AV: R\$ 7,28 15: R\$ 7,43
30: R\$ 7,58 45: R\$ 7,73 60: R\$ 7,88

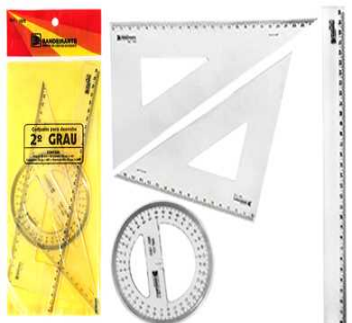

KIT ESCOLAR 2.º GRAU 4 PCS 10130002
Código: Fábrika: Unidade:
22765 WALEU PT/1
F1 F4

UN: R\$ 8,28 AV: R\$ 8,28 15: R\$ 8,45
30: R\$ 8,62 45: R\$ 8,79 60: R\$ 8,97



KIT ESCRITORIO (APON/TES/BORR/GRAM) 8861
Código: Fábrika: Unidade:
44751 WIN PAPER UN/1
F1 F4

UN: R\$ 7,98 AV: R\$ 7,98 15: R\$ 8,14
30: R\$ 8,31 45: R\$ 8,47 60: R\$ 8,64



KIT NORMOGRAFO CRISTAL 19MM 14006
Código: Fábrika: Unidade:
44059 MAXCRIL PT/1
F1 F4

UN: R\$ 0,10 AV: R\$ 1,05 15: R\$ 1,07
30: R\$ 1,09 45: R\$ 1,11 60: R\$ 1,14



LACO FACIL 12MMX21CM COLOR 12A 10X1
Código: Fábrica: Unidade:
35988 PULLFLOWER PT/10
F1 F4

UN: R\$ 0,17 AV: R\$ 1,72 15: R\$ 1,75
30: R\$ 1,79 45: R\$ 1,82 60: R\$ 1,86



LACO FACIL 12MMX24CM COLOR 64 10X1
Código: Fábrica: Unidade:
45956 WINMAX PT/10
F1 F4

UN: R\$ 0,13 AV: R\$ 1,33 15: R\$ 1,36
30: R\$ 1,38 45: R\$ 1,41 60: R\$ 1,44



LACO FACIL 15MMX27CM COLOR 15A 10X1
Código: Fábrica: Unidade:
35989 PULLFLOWER PT/10
F1 F4

UN: R\$ 0,36 AV: R\$ 3,64 15: R\$ 3,72
30: R\$ 3,79 45: R\$ 3,87 60: R\$ 3,95



LACO FACIL 18MMX34CM COLOR 65 10X1
Código: Fábrica: Unidade:
45957 WINMAX PT/10
F1 F4

UN: R\$ 0,40 AV: R\$ 3,98 15: R\$ 4,07
30: R\$ 4,15 45: R\$ 4,23 60: R\$ 4,32



LAMINA P/ESTILETE 09MM ESTREITO 10X1
Código: Fábrica: Unidade:
41608 BRW CR/10
F1 F4

UN: R\$ 0,20 AV: R\$ 19,96 15: R\$ 20,37
30: R\$ 20,78 45: R\$ 21,20 60: R\$ 21,62



LAMINA P/ESTILETE 09MM ESTREITO 10X10
Código: Fábrica: Unidade:
45125 MASTERPRINT CX/100
F1 F4

UN: R\$ 3,79 AV: R\$ 37,93 15: R\$ 38,72
30: R\$ 39,49 45: R\$ 40,28 60: R\$ 41,09



LAMINA P/ESTILETE 18MM LARGO 10X10
Código: Fábrica: Unidade:
45126 MASTERPINT CX/10
F1 F4

UN: R\$ 0,57 AV: R\$ 5,74 15: R\$ 5,86
30: R\$ 5,98 45: R\$ 6,10 60: R\$ 6,22



LAMINA P/ESTILETE 18MM LARGO 1801 10X1
Código: Fábrica: Unidade:
22804 BRW/MASTER CR/10
F1 F4

UN: R\$ 30,94 AV: R\$ 30,94 15: R\$ 31,59
30: R\$ 32,22 45: R\$ 32,86 60: R\$ 33,52



LANCHEIRA BATTLE LA4658
Código: Fábrica: Unidade:
48989 PONTO VERDE UN/1
F1 F4

UN: R\$ 31,94 AV: R\$ 31,94 15: R\$ 32,60
30: R\$ 33,26 45: R\$ 33,92 60: R\$ 34,60



LANCHEIRA BRANCA DE NEVE LA4628
Código: Fábrica: Unidade:
49031 PONTO VERDE UN/1
F1 F4

UN: R\$ 39,93 AV: R\$ 39,93 15: R\$ 40,76
30: R\$ 41,57 45: R\$ 42,40 60: R\$ 43,25



LANCHEIRA FEM AMANDA&FRIENDS RELEVLA2190
Código: Fábrica: Unidade:
29618 SBC UN/1
F1 F4

UN: R\$ 20,96 AV: R\$ 20,96 15: R\$ 21,40
30: R\$ 21,82 45: R\$ 22,26 60: R\$ 22,71



LANCHEIRA FEM ANGOLITA E PINTINHOS LA253
Código: Fábrica: Unidade:
28927 SBC UN/1
F1 F4

UN: R\$ 19,97 AV: R\$ 19,97 15: R\$ 20,38
30: R\$ 20,79 45: R\$ 21,21 60: R\$ 21,63



LANCHEIRA FEM BEAUTY FREAKY LA225
Código: Fábrica: Unidade:
28925 SBC UN/1
F1 F4

UN: R\$ 34,93 AV: R\$ 34,93 15: R\$ 35,66
30: R\$ 36,38 45: R\$ 37,10 60: R\$ 37,84



LANCHEIRA FEM BELLA LA3539
Código: Fábrica: Unidade:
34241 SBC UN/1
F1 F4

UN: R\$ 34,93 AV: R\$ 34,93 15: R\$ 35,66
30: R\$ 36,38 45: R\$ 37,10 60: R\$ 37,84



LANCHEIRA FEM CALIFORNIA GIRL LA2948
Código: Fábrica: Unidade:
32143 SBC UN/1
F1 F4

UN: R\$ 39,93 AV: R\$ 39,93 15: R\$ 40,76
30: R\$ 41,57 45: R\$ 42,40 60: R\$ 43,25



LANCHEIRA FEM CALIFORNIA GIRL REL 3026
Código: Fábrica: Unidade:
32144 SBC UN/1
F1 F4

UN: R\$ 39,93 AV: R\$ 39,93 15: R\$ 40,76
30: R\$ 41,57 45: R\$ 42,40 60: R\$ 43,25



LANCHEIRA FEM CALIFORNIA GIRL REL 3150
Código: Fábrica: Unidade:
32329 SBC UN/1
F1 F4

UN: R\$ 19,97 AV: R\$ 19,97 15: R\$ 20,38
30: R\$ 20,79 45: R\$ 21,21 60: R\$ 21,63



LANCHEIRA FEM CRYSTAL PRINCESS REL LA2634
Código: Fábrica: Unidade:
31325 SBC UN/1
F1 F4

UN: R\$ 39,93 AV: R\$ 39,93 15: R\$ 40,76
30: R\$ 41,57 45: R\$ 42,40 60: R\$ 43,25



LANCHEIRA FEM DOLL LA3922
Código: Fábrica: Unidade:
36218 SBC UN/1
F1 F4

UN: R\$ 34,93 AV: R\$ 34,93 15: R\$ 35,66
30: R\$ 36,38 45: R\$ 37,10 60: R\$ 37,84



LANCHEIRA FEM EMOJI LA3254
Código: Fábrica: Unidade:
32303 SBC UN/1
F1 F4

UN: R\$ 39,93 AV: R\$ 39,93 15: R\$ 40,76
30: R\$ 41,57 45: R\$ 42,40 60: R\$ 43,25



LANCHEIRA FEM LITTLE PRINCESS LA3644
Código: Fábrica: Unidade:
34245 SBC UN/1
F1 F4

UN: R\$ 39,93 AV: R\$ 39,93 15: R\$ 40,76
30: R\$ 41,57 45: R\$ 42,40 60: R\$ 43,25



LANCHEIRA FEM LOVE FASHION LA3517
Código: Fábrica: Unidade:
34246 SBC UN/1
F1 F4

UN: R\$ 24,96 AV: R\$ 24,96 15: R\$ 25,48
30: R\$ 25,99 45: R\$ 26,51 60: R\$ 27,04



LANCHEIRA FEM MAGICAL FAIRIES LA165
Código: Fábrica: Unidade:
27856 SBC UN/1
F1 F4

UN: R\$ 34,93 AV: R\$ 34,93 15: R\$ 35,66
30: R\$ 36,38 45: R\$ 37,10 60: R\$ 37,84



LANCHEIRA FEM MAGICAL 2920
Código: Fábrica: Unidade:
32333 SBC UN/1
F1 F4

UN: R\$ 24,96 AV: R\$ 24,96 15: R\$ 25,48
30: R\$ 25,99 45: R\$ 26,51 60: R\$ 27,04



LANCHEIRA FEM MELODY LA985
Código: Fábrica: Unidade:
26658 SBC UN/1
F1 F4

UN: R\$ 34,93 AV: R\$ 34,93 15: R\$ 35,66
30: R\$ 36,38 45: R\$ 37,10 60: R\$ 37,84



LANCHEIRA FEM MY PRINCESS LA183
Código: Fábrica: Unidade:
27798 SBC UN/1
F1 F4

UN: R\$ 33,45 AV: R\$ 33,45 15: R\$ 34,14
30: R\$ 34,83 45: R\$ 35,52 60: R\$ 36,23



LANCHEIRA FEM PEQUENA PRINCESA REL 3038
Código: Fábrica: Unidade:
32332 SBC UN/1
F1 F4

UN: R\$ 39,93 AV: R\$ 39,93 15: R\$ 40,76
30: R\$ 41,57 45: R\$ 42,40 60: R\$ 43,25



LANCHEIRA FEM PEQUENA PRINCESA REL 3144
Código: Fábrica: Unidade:
32330 SBC UN/1
F1 F4

UN: R\$ 39,93 AV: R\$ 39,93 15: R\$ 40,76
30: R\$ 41,57 45: R\$ 42,40 60: R\$ 43,25



LANCHEIRA FEM PET PRINCESS LA 3088
Código: Fábrica: Unidade:
32148 SBC UN/1
F1 F4

UN: R\$ 34,93 AV: R\$ 34,93 15: R\$ 35,66
30: R\$ 36,38 45: R\$ 37,10 60: R\$ 37,84



LANCHEIRA FEM PET PRINCESSS 2934
Código: Fábrica: Unidade:
32331 SBC UN/1
F1 F4

UN: R\$ 34,93 AV: R\$ 34,93 15: R\$ 35,66
30: R\$ 36,38 45: R\$ 37,10 60: R\$ 37,84



LANCHEIRA FEM PIGGY LA2004
Código: Fábrica: Unidade:
29631 SBC UN/1
F1 F4

UN: R\$ 39,93 AV: R\$ 39,93 15: R\$ 40,76
30: R\$ 41,57 45: R\$ 42,40 60: R\$ 43,25



LANCHEIRA FEM PIGGY RELEVÔ LA2402
Código: Fábrica: Unidade:
29700 SBC UN/1
F1 F4

UN: R\$ 24,96 AV: R\$ 24,96 15: R\$ 25,48
30: R\$ 25,99 45: R\$ 26,51 60: R\$ 27,04



LANCHEIRA FEM PINK BALLERINA LA269
Código: Fábrica: Unidade:
27969 SBC UN/1
F1 F4

UN: R\$ 39,93 AV: R\$ 39,93 15: R\$ 40,76
30: R\$ 41,57 45: R\$ 42,40 60: R\$ 43,25



LANCHEIRA FEM PRINCESS ON ICE LA3006
Código: Fábrica: Unidade:
32211 SBC UN/1
F1 F4

UN: R\$ 39,93 AV: R\$ 39,93 15: R\$ 40,76
30: R\$ 41,57 45: R\$ 42,40 60: R\$ 43,25



LANCHEIRA FEM PRINCESS ON ICE LA3106
Código: Fábrica: Unidade:
32105 SBC UN/1
F1 F4

UN: R\$ 39,93 AV: R\$ 39,93 15: R\$ 40,76
30: R\$ 41,57 45: R\$ 42,40 60: R\$ 43,25



LANCHEIRA FEM PRINCESS ON ICE REL LA3044
Código: Fábrica: Unidade:
32106 SBC UN/1
F1 F4

UN: R\$ 39,93 AV: R\$ 39,93 15: R\$ 40,76
30: R\$ 41,57 45: R\$ 42,40 60: R\$ 43,25



LANCHEIRA FEM PRINCESS REL LA3032
Código: Fábrica: Unidade:
32104 SBC UN/1
F1 F4

UN: R\$ 39,93 AV: R\$ 39,93 15: R\$ 40,76
30: R\$ 41,57 45: R\$ 42,40 60: R\$ 43,25



LANCHEIRA FEM PRINCESS REL LA3074
Código: Fábrica: Unidade:
32146 SBC UN/1
F1 F4

UN: R\$ 14,98 AV: R\$ 14,98 15: R\$ 15,29
30: R\$ 15,59 45: R\$ 15,91 60: R\$ 16,22



LANCHEIRA FEM RAPUNZEL LA189
Código: Fábrica: Unidade:
27873 VOZZ UN/1
F1 F4

UN: R\$ 34,93 AV: R\$ 34,93 15: R\$ 35,66
30: R\$ 36,38 45: R\$ 37,10 60: R\$ 37,84



LANCHEIRA FEM REBEL PRINCESS LA2940
Código: Fábrica: Unidade:
32151 SBC UN/1
F1 F4

UN: R\$ 34,93 AV: R\$ 34,93 15: R\$ 35,66
30: R\$ 36,38 45: R\$ 37,10 60: R\$ 37,84



LANCHEIRA FEM SOPHIA REL LA2628
Código: Fábrica: Unidade:
31310 SBC UN/1
F1 F4

UN: R\$ 39,93 AV: R\$ 39,93 15: R\$ 40,76
30: R\$ 41,57 45: R\$ 42,40 60: R\$ 43,25



LANCHEIRA FEM STAR SHOW LA3884
Código: Fábrica: Unidade:
35969 SBC UN/1
F1 F4

UN: R\$ 34,93 AV: R\$ 34,93 15: R\$ 35,66
30: R\$ 36,38 45: R\$ 37,10 60: R\$ 37,84



LANCHEIRA FEM SUPER CATHIE LA3551
Código: Fábrica: Unidade:
38053 SBC UN/1
F1 F4

UN: R\$ 39,93 AV: R\$ 39,93 15: R\$ 40,76
30: R\$ 41,57 45: R\$ 42,40 60: R\$ 43,25



LANCHEIRA FEM UNILOVERS LA3722
Código: Fábrica: Unidade:
34248 SBC UN/1
F1 F4

UN: R\$ 35,69 AV: R\$ 35,69 15: R\$ 36,44
30: R\$ 37,17 45: R\$ 37,91 60: R\$ 38,67



LANCHEIRA FEM VALENTINA LA3168
Código: Fábrica: Unidade:
31783 SBC UN/1
F1 F4

UN: R\$ 34,93 AV: R\$ 34,93 15: R\$ 35,66
30: R\$ 36,38 45: R\$ 37,10 60: R\$ 37,84



LANCHEIRA FEM WORDER GIRL LA3904
Código: Fábrica: Unidade:
35970 SBC UN/1
F1 F4

UN: R\$ 29,94 AV: R\$ 29,94 15: R\$ 30,57
30: R\$ 31,18 45: R\$ 31,80 60: R\$ 32,44



LANCHEIRA FEM WORLD OF PRINCESS LA277
Código: Fábrica: Unidade:
28939 SBC UN/1
F1 F4

UN: R\$ 34,93 AV: R\$ 34,93 15: R\$ 35,66
30: R\$ 36,38 45: R\$ 37,10 60: R\$ 37,84



LANCHEIRA INF LINHA BABY GATINHA LA715
Código: Fábrica: Unidade:
49183 PONTO VERDE UN/1
F1 F4

UN: R\$ 45,63 AV: R\$ 45,63 15: R\$ 46,58
30: R\$ 47,51 45: R\$ 48,46 60: R\$ 49,43



LANCHEIRA INF MASC GUARDIAN NIGHT LA4178
Código: Fábrica: Unidade:
44405 PONTO VERDE UN/1
F1 F4

UN: R\$ 45,63 AV: R\$ 45,63 15: R\$ 46,58
30: R\$ 47,51 45: R\$ 48,46 60: R\$ 49,43



LANCHEIRA INF MASC SPEED WEB LA4142
Código: Fábrica: Unidade:
44404 PONTO VERDE UN/1
F1 F4

UN: R\$ 41,92 AV: R\$ 41,92 15: R\$ 42,80
30: R\$ 43,65 45: R\$ 44,53 60: R\$ 45,42



LANCHEIRA JUVENIL FEM VKG LA4288
Código: Fábrica: Unidade:
48960 PONTO VERDE UN/1
F1 F4

UN: R\$ 34,93 AV: R\$ 34,93 15: R\$ 35,66
30: R\$ 36,38 45: R\$ 37,10 60: R\$ 37,84



LANCHEIRA JUVENIL FEM VKG LA4294
Código: Fábrica: Unidade:
48961 PONTO VERDE UN/1
F1 F4

UN: R\$ 41,92 AV: R\$ 41,92 15: R\$ 42,80
30: R\$ 43,65 45: R\$ 44,53 60: R\$ 45,42



LANCHEIRA JUVENIL FEM VKG LA4298
Código: Fábrica: Unidade:
49181 PONTO VERDE UN/1
F1 F4

UN: R\$ 30,94 AV: R\$ 30,94 15: R\$ 31,59
30: R\$ 32,22 45: R\$ 32,86 60: R\$ 33,52



LANCHEIRA KARS KIDS LA4668
Código: Fábrica: Unidade:
48990 PONTO VERDE UN/1
F1 F4

UN: R\$ 34,93 AV: R\$ 34,93 15: R\$ 35,66
30: R\$ 36,38 45: R\$ 37,10 60: R\$ 37,84



LANCHEIRA MASC AIR JUMP LA3746
Código: Fábrica: Unidade:
38052 SBC UN/1
F1 F4

UN: R\$ 29,55 AV: R\$ 29,55 15: R\$ 30,17
30: R\$ 30,77 45: R\$ 31,39 60: R\$ 32,01



LANCHEIRA MASC BLOCK GAME LA3628
Código: Fábrica: Unidade:
34242 SBC UN/1
F1 F4

UN: R\$ 39,93 AV: R\$ 39,93 15: R\$ 40,76
30: R\$ 41,57 45: R\$ 42,40 60: R\$ 43,25



LANCHEIRA MASC BROKEBONES LA3020
Código: Fábrica: Unidade:
32142 SBC UN/1
F1 F4

UN: R\$ 39,93 AV: R\$ 39,93 15: R\$ 40,76
30: R\$ 41,57 45: R\$ 42,40 60: R\$ 43,25



LANCHEIRA MASC BROKEBONES REL LA3050
Código: Fábrica: Unidade:
32316 SBC UN/1
F1 F4

UN: R\$ 39,93 AV: R\$ 39,93 15: R\$ 40,76
30: R\$ 41,57 45: R\$ 42,40 60: R\$ 43,25



LANCHEIRA MASC BROKEBONES REL LA3124
Código: Fábrica: Unidade:
32101 SBC UN/1
F1 F4

UN: R\$ 39,93 AV: R\$ 39,93 15: R\$ 40,76
30: R\$ 41,57 45: R\$ 42,40 60: R\$ 43,25



LANCHEIRA MASC BROKEBONES REL LA3162
Código: Fábrica: Unidade:
32102 SBC UN/1
F1 F4

UN: R\$ 34,93 AV: R\$ 34,93 15: R\$ 35,66
30: R\$ 36,38 45: R\$ 37,10 60: R\$ 37,84



LANCHEIRA MASC BROKEBONES RELEVÔ LA2174
Código: Fábrica: Unidade:
29511 SBC UN/1
F1 F4

UN: R\$ 34,93 AV: R\$ 34,93 15: R\$ 35,66
30: R\$ 36,38 45: R\$ 37,10 60: R\$ 37,84



LANCHEIRA MASC DINOSSAURO LA4034
Código: Fábrica: Unidade:
36102 SBC UN/1
F1 F4

UN: R\$ 39,93 AV: R\$ 39,93 15: R\$ 40,76
30: R\$ 41,57 45: R\$ 42,40 60: R\$ 43,25



LANCHEIRA MASC GALERA RADICAL LA3576
Código: Fábrica: Unidade:
34373 SBC UN/1
F1 F4

UN: R\$ 34,93 AV: R\$ 34,93 15: R\$ 35,66
30: R\$ 36,38 45: R\$ 37,10 60: R\$ 37,84



LANCHEIRA MASC HEROES VOZZ LA3056
Código: Fábrica: Unidade:
31833 SBC UN/1
F1 F4

UN: R\$ 34,93 AV: R\$ 34,93 15: R\$ 35,66
30: R\$ 36,38 45: R\$ 37,10 60: R\$ 37,84



LANCHEIRA MASC HEROES VOZZ LA2956

Código: Fábrica: Unidade:
38047 SBC UN/1
F1 F4

UN: R\$ 16,47 AV: R\$ 16,47 15: R\$ 16,82
30: R\$ 17,15 45: R\$ 17,50 60: R\$ 17,85



LANCHEIRA MASC HEROES VOZZ REL LA2658

Código: Fábrica: Unidade:
31303 SBC UN/1
F1 F4

UN: R\$ 39,93 AV: R\$ 39,93 15: R\$ 40,76
30: R\$ 41,57 45: R\$ 42,40 60: R\$ 43,25



LANCHEIRA MASC HEROES VOZZ REL LA3112

Código: Fábrica: Unidade:
32103 SBC UN/1
F1 F4

UN: R\$ 30,94 AV: R\$ 30,94 15: R\$ 31,59
30: R\$ 32,22 45: R\$ 32,86 60: R\$ 33,52



LANCHEIRA MASC HOOZ LA3637

Código: Fábrica: Unidade:
34244 SBC UN/1
F1 F4

UN: R\$ 29,94 AV: R\$ 29,94 15: R\$ 30,57
30: R\$ 31,18 45: R\$ 31,80 60: R\$ 32,44



LANCHEIRA MASC PIGGY BOY LA2052

Código: Fábrica: Unidade:
29521 SBC UN/1
F1 F4

UN: R\$ 34,93 AV: R\$ 34,93 15: R\$ 35,66
30: R\$ 36,38 45: R\$ 37,10 60: R\$ 37,84



LANCHEIRA MASC PIGGY BOY RELEVO LA2434

Código: Fábrica: Unidade:
29609 SBC UN/1
F1 F4

UN: R\$ 34,93 AV: R\$ 34,93 15: R\$ 35,66
30: R\$ 36,38 45: R\$ 37,10 60: R\$ 37,84



LANCHEIRA MASC REINO LEAO LA4015

Código: Fábrica: Unidade:
35968 SBC UN/1
F1 F4

UN: R\$ 39,93 AV: R\$ 39,93 15: R\$ 40,76
30: R\$ 41,57 45: R\$ 42,40 60: R\$ 43,25



LANCHEIRA MASC ROBOT POWER LA3658

Código: Fábrica: Unidade:
34247 SBC UN/1
F1 F4

UN: R\$ 29,94 AV: R\$ 29,94 15: R\$ 30,57
30: R\$ 31,18 45: R\$ 31,80 60: R\$ 32,44



LANCHEIRA MASC SPEED BOY LA 2964

Código: Fábrica: Unidade:
32152 SBC UN/1
F1 F4

UN: R\$ 34,93 AV: R\$ 34,93 15: R\$ 35,66
30: R\$ 36,38 45: R\$ 37,10 60: R\$ 37,84



LANCHEIRA MASC SPEED BOY LA2154

Código: Fábrica: Unidade:
29610 SBC UN/1
F1 F4

UN: R\$ 34,93 AV: R\$ 34,93 15: R\$ 35,66
30: R\$ 36,38 45: R\$ 37,10 60: R\$ 37,84



LANCHEIRA MASC SPEED BOY LA3613

Código: Fábrica: Unidade:
38048 SBC UN/1
F1 F4

UN: R\$ 39,93 AV: R\$ 39,93 15: R\$ 40,76
30: R\$ 41,57 45: R\$ 42,40 60: R\$ 43,25



LANCHEIRA MASC SPEED BOY REL LA3156

Código: Fábrica: Unidade:
32315 SBC UN/1
F1 F4

UN: R\$ 30,94 AV: R\$ 30,94 15: R\$ 31,59
30: R\$ 32,22 45: R\$ 32,86 60: R\$ 33,52



LANCHEIRA PRINCESA LA4638

Código: Fábrica: Unidade:
48991 PONTO VERDE UN/1
F1 F4

UN: R\$ 31,94 AV: R\$ 31,94 15: R\$ 32,60
30: R\$ 33,26 45: R\$ 33,92 60: R\$ 34,60



LANCHEIRA SEREIA LA4618

Código: Fábrica: Unidade:
49032 PONTO VERDE UN/1
F1 F4

UN: R\$ 10,48 AV: R\$ 10,48 15: R\$ 10,70
30: R\$ 10,92 45: R\$ 11,13 60: R\$ 11,36



LANCHEIRA TERM FEM PROMOCAO

Código: Fábrica: Unidade:
21180 YINS/YANGZI UN/1
F4

UN: R\$ 39,93 AV: R\$ 39,93 15: R\$ 40,76
30: R\$ 41,57 45: R\$ 42,40 60: R\$ 43,25



LANCHEIRA TERM JUVENIL FEM VIKING LA4256

Código: Fábrica: Unidade:
49182 PONTO VERDE UN/1
F1 F4

UN: R\$ 32,59 AV: R\$ 32,59 15: R\$ 33,27
30: R\$ 33,93 45: R\$ 34,61 60: R\$ 35,30



LANCHEIRA TERM JUVENIL FEM VKG LA4266
Código: Fábrica: Unidade:
49221 PONTO VERDE UN/1
F1 F4

UN: R\$ 29,94 AV: R\$ 29,94 15: R\$ 30,57
30: R\$ 31,18 45: R\$ 31,80 60: R\$ 32,44



LANCHEIRA UNISSEX FRIENDS AVENTURE LA153
Código: Fábrica: Unidade:
29018 SBC UN/1
F1 F4

UN: R\$ 24,96 AV: R\$ 24,96 15: R\$ 25,48
30: R\$ 25,99 45: R\$ 26,51 60: R\$ 27,04



LANCHEIRA UNISSEX TURMA DO RISO LA111
Código: Fábrica: Unidade:
28923 SBC UN/1
F1 F4

UN: R\$ 0,99 AV: R\$ 11,86 15: R\$ 12,11
30: R\$ 12,35 45: R\$ 12,60 60: R\$ 12,85



LANTEJOULA 2 GRS AZUL12X1
Código: Fábrica: Unidade:
9808 CITY BRILHO DZ/12
F1 F4

UN: R\$ 0,99 AV: R\$ 11,86 15: R\$ 12,11
30: R\$ 12,35 45: R\$ 12,60 60: R\$ 12,85



LANTEJOULA 2 GRS BRANCO 12X1
Código: Fábrica: Unidade:
9806 CITY BRILHO DZ/12
F1 F4

UN: R\$ 0,99 AV: R\$ 11,86 15: R\$ 12,11
30: R\$ 12,35 45: R\$ 12,60 60: R\$ 12,85



LANTEJOULA 2 GRS DOURADO 12X1
Código: Fábrica: Unidade:
9807 CITY BRILHO DZ/12
F1 F4

UN: R\$ 0,99 AV: R\$ 11,86 15: R\$ 12,11
30: R\$ 12,35 45: R\$ 12,60 60: R\$ 12,85



LANTEJOULA 2 GRS PRATA 12X1
Código: Fábrica: Unidade:
15072 CITY BRILHO DZ/12
F1 F4

UN: R\$ 0,99 AV: R\$ 11,86 15: R\$ 12,11
30: R\$ 12,35 45: R\$ 12,60 60: R\$ 12,85



LANTEJOULA 2 GRS PRETA 12X1
Código: Fábrica: Unidade:
15073 CITY BRILHO DZ/12
F1 F4

UN: R\$ 0,99 AV: R\$ 11,86 15: R\$ 12,11
30: R\$ 12,35 45: R\$ 12,60 60: R\$ 12,85



LANTEJOULA 2 GRS ROSA 12X1
Código: Fábrica: Unidade:
15074 CITY BRILHO DZ/12
F1 F4

UN: R\$ 0,99 AV: R\$ 11,86 15: R\$ 12,11
30: R\$ 12,35 45: R\$ 12,60 60: R\$ 12,85



LANTEJOULA 2 GRS VERDE 12X1
Código: Fábrica: Unidade:
9809 CITY BRILHO DZ/12
F1 F4

UN: R\$ 0,99 AV: R\$ 11,86 15: R\$ 12,11
30: R\$ 12,35 45: R\$ 12,60 60: R\$ 12,85



LANTEJOULA 2 GRS VERMELHA 12X1
Código: Fábrica: Unidade:
9810 CITY BRILHO DZ/12
F1 F4

UN: R\$ 9,65 AV: R\$ 28,94 15: R\$ 29,55
30: R\$ 30,14 45: R\$ 30,74 60: R\$ 31,36



LAPIS COR RED 24 CORES 3X1
Código: Fábrica: Unidade:
7365 INJEX PEN PT/3
F1 F4

UN: R\$ 4,82 AV: R\$ 28,94 15: R\$ 29,55
30: R\$ 30,14 45: R\$ 30,74 60: R\$ 31,36



LAPIS COR SUPERACAO 12 CORES RED 6X1
Código: Fábrica: Unidade:
44030 INJEX PEN PT/6
F1 F4

UN: R\$ 22,95 AV: R\$ 22,95 15: R\$ 23,43
30: R\$ 23,90 45: R\$ 24,38 60: R\$ 24,87



LAPIS COR 10 CORES METALICO SOFT COLOR
Código: Fábrica: Unidade:
49502 TRIS UN/1
F1 F4

UN: R\$ 17,86 AV: R\$ 17,86 15: R\$ 18,23
30: R\$ 18,60 45: R\$ 18,97 60: R\$ 19,35



LAPIS COR 12 CORES AQUAREL C/PINCEL9652
Código: Fábrica: Unidade:
48429 ACRILEX UN/1
F1 F4

UN: R\$ 11,57 AV: R\$ 11,57 15: R\$ 11,81
30: R\$ 12,05 45: R\$ 12,29 60: R\$ 12,54



LAPIS COR 12 CORES AQUARELAV SEXT C/APON
Código: Fábrica: Unidade:
46931 YIN'S PAPER UN/1
F1 F4

UN: R\$ 8,02 AV: R\$ 32,10 15: R\$ 32,77
30: R\$ 33,42 45: R\$ 34,09 60: R\$ 34,77



LAPIS COR 12 CORES C/APONT/BORR/2LAP 4X1
Código: Fábrika: Unidade:
27954 LEO&LEO PT/4
F1 F4

UN: R\$ 15,08 AV: R\$ 90,51 15: R\$ 92,39
30: R\$ 94,24 45: R\$ 96,12 60: R\$ 98,05



LAPIS COR 12 CORES HEXAG MEGA SOFT 6X1
Código: Fábrika: Unidade:
48812 TRIS PT/6
F1 F4

UN: R\$ 96,35 AV: R\$ 96,35 15: R\$ 98,35
30: R\$ 100,32 45: R\$ 102,33 60: R\$ 104,37



LAPIS COR 12 CORES JUMBO C/APONTADOR 3X1
Código: Fábrika: Unidade:
43754 TRIS UN/1
F1 F4

UN: R\$ 10,93 AV: R\$ 65,59 15: R\$ 66,96
30: R\$ 68,30 45: R\$ 69,67 60: R\$ 71,06



LAPIS COR 12 CORES JUMBO C/APONTADOR 6X1
Código: Fábrika: Unidade:
50329 FIRST PT/6
F1 F4

UN: R\$ 4,99 AV: R\$ 29,94 15: R\$ 30,57
30: R\$ 31,18 45: R\$ 31,80 60: R\$ 32,44



LAPIS COR 12 CORES MAD RED ECO 4692 6X1
Código: Fábrika: Unidade:
50618 LEO&LEO PT/6
F1 F4

UN: R\$ 4,99 AV: R\$ 29,94 15: R\$ 30,57
30: R\$ 31,18 45: R\$ 31,80 60: R\$ 32,44



LAPIS COR 12 CORES MAD SEXT ECO 4220 6X1
Código: Fábrika: Unidade:
50617 LEO&LEO PT/6
F1 F4

UN: R\$ 12,29 AV: R\$ 73,73 15: R\$ 75,27
30: R\$ 76,77 45: R\$ 78,31 60: R\$ 79,87



LAPIS COR 12 CORES MAD SEXTAV 4130 6X1
Código: Fábrika: Unidade:
48356 LEO&LEO PT/6
F1 F4

UN: R\$ 4,99 AV: R\$ 29,94 15: R\$ 29,94
30: R\$ 29,94 45: R\$ 29,94 60: R\$ 29,94



LAPIS COR 12 CORES MADEIRA 120636 6X1
Código: Fábrika: Unidade:
42034 SERELEPE PT/6
F1 F4

UN: R\$ 5,04 AV: R\$ 30,23 15: R\$ 30,86
30: R\$ 31,48 45: R\$ 32,11 60: R\$ 32,75



LAPIS COR 12 CORES RED PIRILAMPO REC 6X1
Código: Fábrika: Unidade:
47461 ECOLE PT/6
F1 F4

UN: R\$ 7,69 AV: R\$ 7,69 15: R\$ 7,85
30: R\$ 8,00 45: R\$ 8,16 60: R\$ 8,33



LAPIS COR 12 CORES SEXT MAD FSC UN
Código: Fábrika: Unidade:
49271 COLORARE UN/1
F1 F4

UN: R\$ 10,31 AV: R\$ 10,31 15: R\$ 10,53
30: R\$ 10,74 45: R\$ 10,95 60: R\$ 11,17



LAPIS COR 12 CORES SEXT MADEIRA 0012
Código: Fábrika: Unidade:
49153 BRW UN/1
F1 F4

UN: R\$ 4,08 AV: R\$ 48,91 15: R\$ 49,93
30: R\$ 50,93 45: R\$ 51,95 60: R\$ 52,99



LAPIS COR 12 CORES SEXTAV WAVE REC 12X1
Código: Fábrika: Unidade:
48330 BAZZE PT/12
F1 F4

UN: R\$ 4,49 AV: R\$ 26,95 15: R\$ 27,51
30: R\$ 28,06 45: R\$ 28,62 60: R\$ 29,19

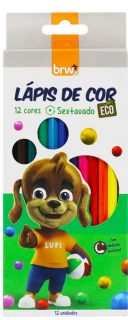

LAPIS COR 12 CORES SEXTAV ECO 1204 6X1
Código: Fábrika: Unidade:
25503 BRW PT/6
F1 F4

UN: R\$ 11,33 AV: R\$ 11,33 15: R\$ 11,57
30: R\$ 11,80 45: R\$ 12,04 60: R\$ 12,28



LAPIS COR 12 CORES SUPER MINA 3MM 9692
Código: Fábrika: Unidade:
48432 ACRILEX UN/1
F1 F4

UN: R\$ 13,25 AV: R\$ 13,25 15: R\$ 13,52
30: R\$ 13,80 45: R\$ 14,07 60: R\$ 14,35



LAPIS COR 12 CORES TRIANG BIG C/APON 4194
Código: Fábrika: Unidade:
42591 LEO&LEO UN/1
F1 F4

UN: R\$ 14,39 AV: R\$ 86,33 15: R\$ 88,13
30: R\$ 89,89 45: R\$ 91,69 60: R\$ 93,52



LAPIS COR 12 CORES TRIANG AQUARELAV 6X1
Código: Fábrika: Unidade:
46847 ONDA PT/6
F1 F4

UN: R\$ 23,29 AV: R\$ 139,77 15: R\$ 142,68
30: R\$ 145,53 45: R\$ 148,44 60: R\$ 151,41



LAPIS COR 12 CORES TRIANG BIG 1206 6X1

Código: Fábrika: Unidade:
44293 BRW PT/6
F1 F4

UN: R\$ 9,98 AV: R\$ 59,87 15: R\$ 61,12
30: R\$ 62,34 45: R\$ 63,59 60: R\$ 64,86



LAPIS COR 12 CORES TRIANG MEGA SOFT 6X1

Código: Fábrika: Unidade:
48329 TRIS PT/6
F1 F4

UN: R\$ 4,98 AV: R\$ 4,98 15: R\$ 5,09
30: R\$ 5,19 45: R\$ 5,29 60: R\$ 5,40



LAPIS COR 12 CORES UN

Código: Fábrika: Unidade:
38508 SERELEPE UN/1
F1 F4

UN: R\$ 3,98 AV: R\$ 3,98 15: R\$ 4,07
30: R\$ 4,15 45: R\$ 4,23 60: R\$ 4,32



LAPIS COR 12 CORES UN

Código: Fábrika: Unidade:
42826 INJEX UN/1
F1 F4

UN: R\$ 2,90 AV: R\$ 2,90 15: R\$ 2,96
30: R\$ 3,01 45: R\$ 3,08 60: R\$ 3,14



LAPIS COR 1/2 12 CORES WK 09235 UN

Código: Fábrika: Unidade:
38509 KLUB UN/1
F1 F4

UN: R\$ 1,49 AV: R\$ 17,88 15: R\$ 17,88
30: R\$ 17,88 45: R\$ 17,88 60: R\$ 17,88



LAPIS COR 1/2 12 CORES WK 09235 12X1

Código: Fábrika: Unidade:
4257 KLUB CX/12
F1 F4

UN: R\$ 32,94 AV: R\$ 32,94 15: R\$ 33,62
30: R\$ 34,30 45: R\$ 34,98 60: R\$ 35,68



LAPIS COR 24 CORES AQUAREL C/PINCEL 9654

Código: Fábrika: Unidade:
48431 ACRILEX UN/1
F1 F4

UN: R\$ 15,48 AV: R\$ 15,48 15: R\$ 15,80
30: R\$ 16,11 45: R\$ 16,44 60: R\$ 16,76



LAPIS COR 24 CORES RED WOW 4678

Código: Fábrika: Unidade:
46348 LEO&LEO UN/1
F1 F4

UN: R\$ 14,97 AV: R\$ 14,97 15: R\$ 15,28
30: R\$ 15,58 45: R\$ 15,90 60: R\$ 16,21



LAPIS COR 24 CORES SEXT MAD FSC UN

Código: Fábrika: Unidade:
49272 COLORARE PT/1
F1 F4

UN: R\$ 22,95 AV: R\$ 22,95 15: R\$ 23,43
30: R\$ 23,90 45: R\$ 24,38 60: R\$ 24,87



LAPIS COR 24 CORES SUPER MINA 3MM 9694

Código: Fábrika: Unidade:
41605 ACRILEX UN/1
F1 F4

UN: R\$ 8,67 AV: R\$ 52,03 15: R\$ 53,11
30: R\$ 54,17 45: R\$ 55,26 60: R\$ 56,36



LAPIS COR 24 CORES UN

Código: Fábrika: Unidade:
19811 INJEX PT/6
F1 F4

UN: R\$ 19,96 AV: R\$ 19,96 15: R\$ 20,37
30: R\$ 20,78 45: R\$ 21,20 60: R\$ 21,62



LAPIS COR 36 CORES SEXTAV FLEX 4482

Código: Fábrika: Unidade:
46343 LEO&LEO UN/1
F1 F4

UN: R\$ 19,96 AV: R\$ 59,89 15: R\$ 61,14
30: R\$ 62,36 45: R\$ 63,61 60: R\$ 64,88



LAPIS COR 36 CORES SEXTAVADO 3X1

Código: Fábrika: Unidade:
41844 ONDA PT/3
F1 F4

UN: R\$ 35,93 AV: R\$ 35,93 15: R\$ 36,68
30: R\$ 37,41 45: R\$ 38,16 60: R\$ 38,93



LAPIS COR 36 CORES SUPER MINA 3MM 9626

Código: Fábrika: Unidade:
48430 ACRILEX UN/1
F1 F4

UN: R\$ 24,76 AV: R\$ 24,76 15: R\$ 25,28
30: R\$ 25,78 45: R\$ 26,30 60: R\$ 26,82



LAPIS COR 48 CORES SEXTAV 72105

Código: Fábrika: Unidade:
46344 LEO&LEO UN/1
F1 F4

UN: R\$ 1,25 AV: R\$ 14,97 15: R\$ 15,28
30: R\$ 15,58 45: R\$ 15,90 60: R\$ 16,21



LAPIS (GIZ) CERA ESTACA AMARELO 100G 12X1

Código: Fábrika: Unidade:
28917 FABERCASTELL DZ/12
F1 F4

UN: R\$ 1,25 AV: R\$ 14,97 15: R\$ 15,28
30: R\$ 15,58 45: R\$ 15,90 60: R\$ 16,21



LAPIS (GIZ) CERA ESTACA VERDE CL 10012X1
Código: 28918 Fábrica: FABER CASTEL Unidade: DZ/12 F1 F4

UN: R\$ 1,25 AV: R\$ 14,97 15: R\$ 15,28
30: R\$ 15,58 45: R\$ 15,90 60: R\$ 16,21



LAPIS (GIZ) CERA ESTACA VERDE 100G 12X1
Código: 3828 Fábrica: FABER/ACRILE Unidade: DZ/12 F1 F4

UN: R\$ 2,83 AV: R\$ 33,94 15: R\$ 34,64
30: R\$ 35,34 45: R\$ 36,04 60: R\$ 36,76



LAPIS HB BLACK PEPS JUMBO C/BORR 12X1
Código: 44294 Fábrica: MAPED Unidade: CX/12 F1 F4

UN: R\$ 8,17 AV: R\$ 98,07 15: R\$ 100,12
30: R\$ 102,12 45: R\$ 104,16 60: R\$ 106,24



LAPIS HB INFINITO COLOR AZUL 13084 12X1
Código: 48554 Fábrica: NEWPEN Unidade: CX/12 F1 F4

UN: R\$ 8,17 AV: R\$ 98,07 15: R\$ 100,12
30: R\$ 102,12 45: R\$ 104,16 60: R\$ 106,24



LAPIS HB INFINITO COLOR ROSA 13085 12X1
Código: 48555 Fábrica: NEWPEN Unidade: CX/12 F1 F4

UN: R\$ 1,29 AV: R\$ 7,74 15: R\$ 7,90
30: R\$ 8,06 45: R\$ 8,22 60: R\$ 8,38



LAPIS MARCENEIRO/CARPINTEIRO 19460 6X1
Código: 46587 Fábrica: ALIANCA Unidade: PT/6 F1 F4

UN: R\$ 102,83 AV: R\$ 102,83 15: R\$ 104,97
30: R\$ 107,07 45: R\$ 109,21 60: R\$ 111,39



LAPIS PRETO C/BORRACHA HB N2 JUMBO 36X1
Código: 41925 Fábrica: TRIS Unidade: CX/1 F1 F4

UN: R\$ 0,75 AV: R\$ 53,66 15: R\$ 54,78
30: R\$ 55,88 45: R\$ 57,00 60: R\$ 58,14



LAPIS PRETO HB C/BOR RED DEC 907721 72X1
Código: 49949 Fábrica: BAZZE WAVE Unidade: PT/72 F1 F4

UN: R\$ 0,76 AV: R\$ 54,90 15: R\$ 56,05
30: R\$ 57,17 45: R\$ 58,31 60: R\$ 59,48



LAPIS PRETO HB C/BORR PANDA 72191 72X1
Código: 44245 Fábrica: LEO&LEO Unidade: CX/72 F1 F4

UN: R\$ 0,67 AV: R\$ 47,91 15: R\$ 48,91
30: R\$ 49,89 45: R\$ 50,89 60: R\$ 51,91



LAPIS PRETO HB C/BORR RED FUNDO MAR 72X1
Código: 46330 Fábrica: LEO&LEO Unidade: PT/72 F1 F4

UN: R\$ 1,25 AV: R\$ 59,99 15: R\$ 59,99
30: R\$ 59,99 45: R\$ 59,99 60: R\$ 59,99



LAPIS PRETO HB N.2 OFFICE PREMIUM 48X1
Código: 46279 Fábrica: MOLIN Unidade: CX/48 F1 F4

UN: R\$ 1,46 AV: R\$ 69,88 15: R\$ 71,33
30: R\$ 72,76 45: R\$ 74,22 60: R\$ 75,70



LAPIS PRETO HB N.2 OFFICE STRIPES 48X1
Código: 46280 Fábrica: MOLIN Unidade: CX/48 F1 F4

UN: R\$ 1,62 AV: R\$ 77,87 15: R\$ 79,49
30: R\$ 81,08 45: R\$ 82,70 60: R\$ 84,35



LAPIS PRETO HB N.2 PINK AND BLUE 48X1
Código: 46281 Fábrica: MOLIN Unidade: CX/48 F1 F4

UN: R\$ 0,75 AV: R\$ 107,71 15: R\$ 109,95
30: R\$ 112,15 45: R\$ 114,39 60: R\$ 116,68



LAPIS PRETO HB N.2 SEXT C/DIPPING 144X1
Código: 48425 Fábrica: ACRILEX Unidade: CX/144 F1 F4

UN: R\$ 0,83 AV: R\$ 59,89 15: R\$ 61,14
30: R\$ 62,36 45: R\$ 63,61 60: R\$ 64,88



LAPIS PRETO HB RED C/BORR TABUADA 72X1
Código: 41701 Fábrica: LEO&LEO Unidade: CX/72 F1 F4

UN: R\$ 0,77 AV: R\$ 55,19 15: R\$ 56,34
30: R\$ 57,47 45: R\$ 58,62 60: R\$ 59,79



LAPIS PRETO HB RED DEC 901767 72X1
Código: 49947 Fábrica: BAZZE WAVE Unidade: PT/72 F1 F4

UN: R\$ 0,72 AV: R\$ 51,91 15: R\$ 52,99
30: R\$ 54,05 45: R\$ 55,13 60: R\$ 56,23



LAPIS PRETO HB RED EMOTION 901743 72X1
Código: Fábrika: Unidade:
49948 BAZZE PT/72
F1 F4

UN: R\$ 0,69 AV: R\$ 49,91 15: R\$ 50,95
30: R\$ 51,97 45: R\$ 53,01 60: R\$ 54,07



LAPIS PRETO HB RED TABUADA 611914 72X1
Código: Fábrika: Unidade:
49950 BAZZE PT/72
F1 F4

UN: R\$ 0,42 AV: R\$ 29,99 15: R\$ 29,99
30: R\$ 29,99 45: R\$ 29,99 60: R\$ 29,99



LAPIS PRETO HB SEXTAV VERDE 4389 72X1
Código: Fábrika: Unidade:
46345 LEO%LEO PT/72
F1 F4

UN: R\$ 0,46 AV: R\$ 5,48 15: R\$ 5,60
30: R\$ 5,71 45: R\$ 5,82 60: R\$ 5,94



LAPIS PRETO HB SEXTAVADO 7834 12X1
Código: Fábrika: Unidade:
47936 YIN'S PAPER CX/12
F1 F4

UN: R\$ 0,37 AV: R\$ 26,29 15: R\$ 26,84
30: R\$ 27,37 45: R\$ 27,92 60: R\$ 28,48



LAPIS PRETO HB SEXTAVADO 902894 72X1
Código: Fábrika: Unidade:
49493 BAZZE PT/72
F1 F4

UN: R\$ 0,97 AV: R\$ 34,93 15: R\$ 35,66
30: R\$ 36,38 45: R\$ 37,10 60: R\$ 37,84



LAPIS PRETO HB TRIANG BIG 4197 36X1
Código: Fábrika: Unidade:
46332 LEO&LEO PT/36
F1 F4

UN: R\$ 0,41 AV: R\$ 58,90 15: R\$ 60,12
30: R\$ 61,33 45: R\$ 62,55 60: R\$ 63,80



LAPIS PRETO N.2 SEXTAVADO RESINA 144X1
Código: Fábrika: Unidade:
47219 MASTERPRINT CX/144
F1 F4

UN: R\$ 1,00 AV: R\$ 11,95 15: R\$ 12,20
30: R\$ 12,44 45: R\$ 12,69 60: R\$ 12,95



LAPIS PRETO 2B TECNICO MADEIRA 5546 12X1
Código: Fábrika: Unidade:
44246 LEO&LEO DZ/12
F1 F4

UN: R\$ 1,00 AV: R\$ 11,95 15: R\$ 12,20
30: R\$ 12,44 45: R\$ 12,69 60: R\$ 12,95



LAPIS PRETO 8B TECNICO MADEIR 72155 12X1
Código: Fábrika: Unidade:
44249 LEO&LEO DZ/12
F1 F4

UN: R\$ 0,21 AV: R\$ 29,99 15: R\$ 29,99
30: R\$ 29,99 45: R\$ 29,99 60: R\$ 29,99



LAPIS PRETO 8202 12X12
Código: Fábrika: Unidade:
20518 YINS CX/144
F1 F4

UN: R\$ 0,36 AV: R\$ 51,28 15: R\$ 52,35
30: R\$ 53,39 45: R\$ 54,46 60: R\$ 55,55



LAPIS RESINA HB RED GRAF 144X1 BM2024
Código: Fábrika: Unidade:
48843 FIRST CX/144
F1 F4

UN: R\$ 4,47 AV: R\$ 107,33 15: R\$ 109,56
30: R\$ 111,76 45: R\$ 113,99 60: R\$ 116,27



LAPISEIRA 0.5MM HIT 4CORES 102208 24X1
Código: Fábrika: Unidade:
43809 FUTURO PT/24
F1 F4

UN: R\$ 2,33 AV: R\$ 55,90 15: R\$ 57,07
30: R\$ 58,21 45: R\$ 59,37 60: R\$ 60,56



LAPISEIRA 0.5MM POP C/BORRACH 98078 24X1
Código: Fábrika: Unidade:
50646 LEO&LEO PT/24
F1 F4

UN: R\$ 7,15 AV: R\$ 85,85 15: R\$ 87,64
30: R\$ 89,39 45: R\$ 91,18 60: R\$ 93,01



LAPISEIRA 0.5MM TECNICA C/BORRACH 12X1
Código: Fábrika: Unidade:
44996 BRW CX/12
F1 F4

UN: R\$ 5,40 AV: R\$ 64,86 15: R\$ 66,21
30: R\$ 67,53 45: R\$ 68,88 60: R\$ 70,26



LAPISEIRA 0.5MM TECNICA TRIAN 98027 12X1
Código: Fábrika: Unidade:
29751 JOCAR OFFICE DZ/12
F1 F4

UN: R\$ 1,95 AV: R\$ 23,41 15: R\$ 23,90
30: R\$ 24,38 45: R\$ 24,87 60: R\$ 25,36



LAPISEIRA 0.7MM C/BORRACHA 1101 12X1
Código: Fábrika: Unidade:
51060 MASTERPRINT CX/12
F1 F4

UN: R\$ 2,33 AV: R\$ 55,90 15: R\$ 57,07
30: R\$ 58,21 45: R\$ 59,37 60: R\$ 60,56



LAPISEIRA 0.7MM POP C/BORRACH 98079 24X1
Código: Fábrika: Unidade:
46369 LEO&LEO PT/24
F1 F4

UN: R\$ 4,16 AV: R\$ 99,83 15: R\$ 101,91
30: R\$ 103,95 45: R\$ 106,03 60: R\$ 108,15



LAPISEIRA 0.7MM SHAKE 4137 24X1
Código: Fábrika: Unidade:
41212 LEO&LEO CX/24
F1 F4

UN: R\$ 2,00 AV: R\$ 47,91 15: R\$ 48,91
30: R\$ 49,89 45: R\$ 50,89 60: R\$ 51,91



LAPISEIRA 2.0MM COLOR C/APONTADOR 24X1
Código: Fábrika: Unidade:
44646 LEO&LEO CX/24
F1 F4

UN: R\$ 3,20 AV: R\$ 76,87 15: R\$ 78,47
30: R\$ 80,04 45: R\$ 81,64 60: R\$ 83,27



LAPISEIRA 2.0MM 4 COR PASTEL 2024 24X1
Código: Fábrika: Unidade:
42581 BRW CX/24
F1 F4

UN: R\$ 0,02 AV: R\$ 10,58 15: R\$ 10,80
30: R\$ 11,02 45: R\$ 11,24 60: R\$ 11,46



LEMBRANCINHAS ANIVERSARIO 12X50X1
Código: Fábrika: Unidade:
11265 KID-ART PT/600
F1 F4

UN: R\$ 94,75 AV: R\$ 94,75 15: R\$ 96,72
30: R\$ 98,66 45: R\$ 100,63 60: R\$ 102,64



LIMPA QUADRO 1 L
Código: Fábrika: Unidade:
48094 STOP CLEAN UN/1
F1 F4

UN: R\$ 16,96 AV: R\$ 16,96 15: R\$ 17,32
30: R\$ 17,66 45: R\$ 18,02 60: R\$ 18,38



LIMPADOR INST 60ML P/TELA MONITOR
Código: Fábrika: Unidade:
42806 CARBRINK UN/1
F1 F4

UN: R\$ 17,77 AV: R\$ 17,77 15: R\$ 18,14
30: R\$ 18,50 45: R\$ 18,87 60: R\$ 19,25



LIQUIDO DE LIMPEZA P/QUADRO BRANCO 110ML
Código: Fábrika: Unidade:
45629 CRTIARTE UN/1
F1 F4

UN: R\$ 0,70 AV: R\$ 6,98 15: R\$ 7,12
30: R\$ 7,27 45: R\$ 7,41 60: R\$ 7,56



LIVRAO C/QUEBRA CABECA PRINCESAS
Código: Fábrika: Unidade:
30913 TODOLIVRO PT/10
F1 F4

UN: R\$ 36,69 AV: R\$ 36,69 15: R\$ 37,46
30: R\$ 38,20 45: R\$ 38,97 60: R\$ 39,75



LIVRO C/FANTOCHE ANIMAIS DA FAZENDA
Código: Fábrika: Unidade:
48504 TODOLIVRO UN/1
F1 F4

UN: R\$ 36,69 AV: R\$ 36,69 15: R\$ 37,46
30: R\$ 38,20 45: R\$ 38,97 60: R\$ 39,75



LIVRO C/FANTOCHE ANIMAIS DA SELVA
Código: Fábrika: Unidade:
48511 TODOLIVRO UN/1
F1 F4

UN: R\$ 36,69 AV: R\$ 36,69 15: R\$ 37,46
30: R\$ 38,20 45: R\$ 38,97 60: R\$ 39,75



LIVRO C/FANTOCHE ANIMAIS DE ESTIMACAO
Código: Fábrika: Unidade:
48512 TODOLIVRO UN/1
F1 F4

UN: R\$ 36,69 AV: R\$ 36,69 15: R\$ 37,46
30: R\$ 38,20 45: R\$ 38,97 60: R\$ 39,75



LIVRO C/FANTOCHE ARCA DE NOE
Código: Fábrika: Unidade:
48513 TODOLIVRO UN/1
F1 F4

UN: R\$ 36,69 AV: R\$ 36,69 15: R\$ 37,46
30: R\$ 38,20 45: R\$ 38,97 60: R\$ 39,75



LIVRO C/FANTOCHE CHAPEUZINHO VERMELHO
Código: Fábrika: Unidade:
48514 TODOLIVRO UN/1
F1 F4

UN: R\$ 36,69 AV: R\$ 36,69 15: R\$ 37,46
30: R\$ 38,20 45: R\$ 38,97 60: R\$ 39,75



LIVRO C/FANTOCHE CINDERELA
Código: Fábrika: Unidade:
48515 TODOLIVRO UN/1
F1 F4

UN: R\$ 36,69 AV: R\$ 36,69 15: R\$ 37,46
30: R\$ 38,20 45: R\$ 38,97 60: R\$ 39,75



LIVRO C/FANTOCHE DINOSSAUROS
Código: Fábrika: Unidade:
48517 TODOLIVRO UN/1
F1 F4

UN: R\$ 36,69 AV: R\$ 36,69 15: R\$ 37,46
30: R\$ 38,20 45: R\$ 38,97 60: R\$ 39,75



LIVRO C/FANTOCHE OS TRES PORQUINHOS
Código: Fábrika: Unidade:
48516 TODOLIVRO UN/1
F1 F4

UN: R\$ 16,96 AV: R\$ 16,96 15: R\$ 17,32
30: R\$ 17,66 45: R\$ 18,02 60: R\$ 18,38



LIVRO COMO EU ME SINTO QDO ESTOU C/CIU ME
Código: Fábrika: Unidade:
48456 TODOLIVRO UN/1
F1 F4

UN: R\$ 9,97 AV: R\$ 9,97 15: R\$ 10,18
30: R\$ 10,39 45: R\$ 10,59 60: R\$ 10,81

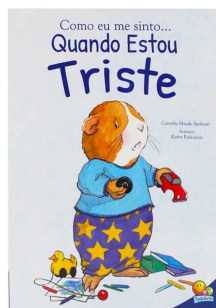

LIVRO COMO EU ME SINTO QDO ESTOU TRISTE
Código: Fábrika: Unidade:
48457 TODOLIVRO UN/1
F1 F4

UN: R\$ 9,97 AV: R\$ 9,97 15: R\$ 10,18
30: R\$ 10,39 45: R\$ 10,59 60: R\$ 10,81

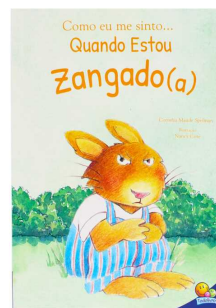

LIVRO COMO EU ME SINTO QDO ESTOU ZANGADO
Código: Fábrika: Unidade:
48458 TODOLIVRO UN/1
F1 F4

UN: R\$ 9,97 AV: R\$ 9,97 15: R\$ 10,18
30: R\$ 10,39 45: R\$ 10,59 60: R\$ 10,81



LIVRO COMO EU ME SINTO QDO ME IMPORTO C/
Código: Fábrika: Unidade:
48459 TODOLIVRO UN/1
F1 F4

UN: R\$ 9,97 AV: R\$ 9,97 15: R\$ 10,18
30: R\$ 10,39 45: R\$ 10,59 60: R\$ 10,81



LIVRO COMO EU ME SINTO QDO ME SINTO BEM
Código: Fábrika: Unidade:
48460 TODOLIVRO UN/1
F1 F4

UN: R\$ 9,97 AV: R\$ 9,97 15: R\$ 10,18
30: R\$ 10,39 45: R\$ 10,59 60: R\$ 10,81



LIVRO COMO EU ME SINTO QDO SINTO SUA FAL
Código: Fábrika: Unidade:
48461 TODOLIVRO UN/1
F1 F4

UN: R\$ 9,97 AV: R\$ 9,97 15: R\$ 10,18
30: R\$ 10,39 45: R\$ 10,59 60: R\$ 10,81

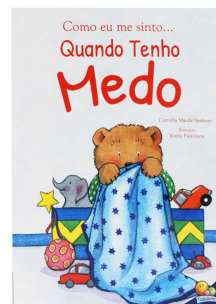

LIVRO COMO EU ME SINTO QDO TENHO MEDO
Código: Fábrika: Unidade:
48462 TODOLIVRO UN/1
F1 F4

UN: R\$ 29,94 AV: R\$ 29,94 15: R\$ 30,57
30: R\$ 31,18 45: R\$ 31,80 60: R\$ 32,44



LIVRO CUTE & COMFY CANETINHA P DUPLA 914
Código: Fábrika: Unidade:
49873 IBC UN/1
F1 F4

UN: R\$ 23,95 AV: R\$ 23,95 15: R\$ 24,45
30: R\$ 24,94 45: R\$ 25,44 60: R\$ 25,95

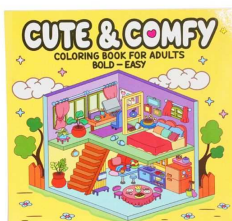

LIVRO CUTE & COMFY COLORING BOOK AD 1600
Código: Fábrika: Unidade:
49708 IBC UN/1
F1 F4

UN: R\$ 27,95 AV: R\$ 27,95 15: R\$ 28,53
30: R\$ 29,10 45: R\$ 29,68 60: R\$ 30,27



LIVRO CUTE & COMFY DES SIMPLES LAPIS COR
Código: Fábrika: Unidade:
49718 IBC UN/1
F1 F4

UN: R\$ 14,97 AV: R\$ 14,97 15: R\$ 15,28
30: R\$ 15,58 45: R\$ 15,90 60: R\$ 16,21



LIVRO CUTE & COMFY FRIENDS COLORING 2096
Código: Fábrika: Unidade:
49711 IBC UN/1
F1 F4

UN: R\$ 27,95 AV: R\$ 27,95 15: R\$ 28,53
30: R\$ 29,10 45: R\$ 29,68 60: R\$ 30,27



LIVRO CUTE & COMFY MENINAS C/LAPIS COR
Código: Fábrika: Unidade:
49715 IBC UN/1
F1 F4

UN: R\$ 14,97 AV: R\$ 14,97 15: R\$ 15,28
30: R\$ 15,58 45: R\$ 15,90 60: R\$ 16,21

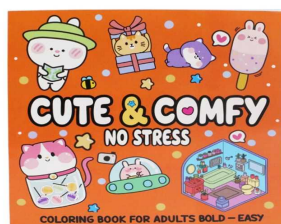

LIVRO CUTE & COMFY NO STRESS COLORING 72
Código: Fábrika: Unidade:
49710 IBC UN/1
F1 F4

UN: R\$ 27,95 AV: R\$ 27,95 15: R\$ 28,53
30: R\$ 29,10 45: R\$ 29,68 60: R\$ 30,27



LIVRO CUTE & COMFY RELAXAR C/LAPIS COR
Código: Fábrika: Unidade:
49717 IBC UN/1
F1 F4

UN: R\$ 27,95 AV: R\$ 27,95 15: R\$ 28,53
30: R\$ 29,10 45: R\$ 29,68 60: R\$ 30,27



LIVRO CUTE & COMFY SEM ESTRESS LAPIS COR
Código: Fábrika: Unidade:
49716 IBC UN/1
F1 F4

UN: R\$ 19,96 AV: R\$ 19,96 15: R\$ 20,37
30: R\$ 20,78 45: R\$ 21,20 60: R\$ 21,62



LIVRO DE BANHO A FAZENDA SOM DOS ANIMAIS
Código: 46637 Fábrica: CIRANDACULT Unidade: UN/1
F1 F4

UN: R\$ 19,96 AV: R\$ 19,96 15: R\$ 20,37
30: R\$ 20,78 45: R\$ 21,20 60: R\$ 21,62



LIVRO DE BANHO ANIMAIS CRIACOES DEUS
Código: 46636 Fábrica: CIRANDACULT Unidade: UN/1
F1 F4

UN: R\$ 19,96 AV: R\$ 19,96 15: R\$ 20,37
30: R\$ 20,78 45: R\$ 21,20 60: R\$ 21,62



LIVRO DE BANHO ANIMAIS DA SELVA
Código: 46635 Fábrica: CIRANDACULT Unidade: UN/1
F1 F4

UN: R\$ 19,96 AV: R\$ 19,96 15: R\$ 20,37
30: R\$ 20,78 45: R\$ 21,20 60: R\$ 21,62



LIVRO DE BANHO FISHER PRICE ELEFANTE
Código: 46639 Fábrica: CIRANDACULT Unidade: UN/1
F1 F4

UN: R\$ 19,96 AV: R\$ 19,96 15: R\$ 20,37
30: R\$ 20,78 45: R\$ 21,20 60: R\$ 21,62



LIVRO DE BANHO FISHER PRICE GIRAFA
Código: 46638 Fábrica: CIRANDACULT Unidade: UN/1
F1 F4

UN: R\$ 19,96 AV: R\$ 19,96 15: R\$ 20,37
30: R\$ 20,78 45: R\$ 21,20 60: R\$ 21,62



LIVRO DE BANHO NUMEROS
Código: 46641 Fábrica: CIRANDACULT Unidade: UN/1
F1 F4

UN: R\$ 19,96 AV: R\$ 19,96 15: R\$ 20,37
30: R\$ 20,78 45: R\$ 21,20 60: R\$ 21,62

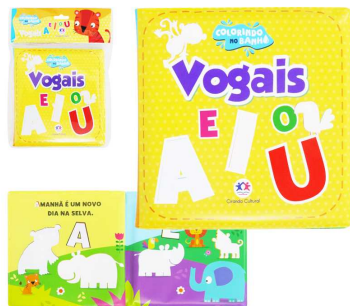

LIVRO DE BANHO VOGAIS
Código: 46640 Fábrica: CIRANDACULT Unidade: UN/1
F1 F4

UN: R\$ 3,06 AV: R\$ 30,57 15: R\$ 31,21
30: R\$ 31,83 45: R\$ 32,47 60: R\$ 33,12



LIVRO ECOG CLASSICOS INESQUECIVEIS 10X1
Código: 48463 Fábrica: TODOLIVRO Unidade: PT/10
F1 F4

UN: R\$ 3,06 AV: R\$ 30,57 15: R\$ 31,21
30: R\$ 31,83 45: R\$ 32,47 60: R\$ 33,12



LIVRO ECOG COLORINDO HIST CLASSICAS 10X1
Código: 48464 Fábrica: TODOLIVRO Unidade: PT/10
F1 F4

UN: R\$ 3,06 AV: R\$ 30,57 15: R\$ 31,21
30: R\$ 31,83 45: R\$ 32,47 60: R\$ 33,12



LIVRO ECOG COLORINDO HIST DA BIBLIA 10X1
Código: 48465 Fábrica: TODOLIVRO Unidade: UN/1
F1 F4

UN: R\$ 3,06 AV: R\$ 30,57 15: R\$ 31,21
30: R\$ 31,83 45: R\$ 32,47 60: R\$ 33,12



LIVRO ECOG FESTA DAS CORES 10X1
Código: 48466 Fábrica: TODOLIVRO Unidade: PT/10
F1 F4

UN: R\$ 3,82 AV: R\$ 30,57 15: R\$ 31,21
30: R\$ 31,83 45: R\$ 32,47 60: R\$ 33,12



LIVRO ECOG HIST BIBLICAS FAVORITAS 8X1
Código: 48467 Fábrica: TODOLIVRO Unidade: PT/8
F1 F4

UN: R\$ 1,40 AV: R\$ 13,97 15: R\$ 14,26
30: R\$ 14,54 45: R\$ 14,83 60: R\$ 15,13



LIVRO ECOM AVENTURA SERES DO MAR 10X1
Código: 48468 Fábrica: TODOLIVRO Unidade: PT/10
F1 F4

UN: R\$ 1,40 AV: R\$ 13,97 15: R\$ 14,26
30: R\$ 14,54 45: R\$ 14,83 60: R\$ 15,13



LIVRO ECOM BRINCANDO C/AS CORES 10X1
Código: 48469 Fábrica: TODOLIVRO Unidade: PT/10
F1 F4

UN: R\$ 1,40 AV: R\$ 13,97 15: R\$ 14,26
30: R\$ 14,54 45: R\$ 14,83 60: R\$ 15,13



LIVRO ECOM BRINCANDO DE COLORIR 10X1
Código: 48470 Fábrica: TODOLIVRO Unidade: PT/10
F1 F4

UN: R\$ 1,40 AV: R\$ 13,97 15: R\$ 14,26
30: R\$ 14,54 45: R\$ 14,83 60: R\$ 15,13



LIVRO ECOM CLASSICOS ADORAVEIS III 10X1
Código: 48471 Fábrica: TODOLIVRO Unidade: PT/10
F1 F4

UN: R\$ 1,40 AV: R\$ 13,97 15: R\$ 14,26
30: R\$ 14,54 45: R\$ 14,83 60: R\$ 15,13



LIVRO ECOM CLASSICOS DA BIBLIA 10X1
Código: 48472 Fábrica: TODOLIVRO Unidade: PT/10 F1 F4

UN: R\$ 1,40 AV: R\$ 13,97 15: R\$ 14,26
30: R\$ 14,54 45: R\$ 14,83 60: R\$ 15,13



LIVRO ECOM COLORIR BRINCAR ANIMAIS 10X1
Código: 48473 Fábrica: TODOLIVRO Unidade: PT/10 F1 F4

UN: R\$ 1,40 AV: R\$ 13,97 15: R\$ 14,26
30: R\$ 14,54 45: R\$ 14,83 60: R\$ 15,13



LIVRO ECOM DINOSSAUROS OS GIGANTES 10X1
Código: 48474 Fábrica: TODOLIVRO Unidade: PT/10 F1 F4

UN: R\$ 1,40 AV: R\$ 13,97 15: R\$ 14,26
30: R\$ 14,54 45: R\$ 14,83 60: R\$ 15,13



LIVRO ECOM FESTA DAS CORES 10X1
Código: 48475 Fábrica: TODOLIVRO Unidade: PT/10 F1 F4

UN: R\$ 1,40 AV: R\$ 13,97 15: R\$ 14,26
30: R\$ 14,54 45: R\$ 14,83 60: R\$ 15,13



LIVRO ECOM FOLCLORE CONTOS E CANTOS 10X1
Código: 48478 Fábrica: TODOLIVRO Unidade: PT/10 F1 F4

UN: R\$ 1,40 AV: R\$ 13,97 15: R\$ 14,26
30: R\$ 14,54 45: R\$ 14,83 60: R\$ 15,13



LIVRO ECOM HISTORIAS ENCANTADAS 10X1
Código: 48479 Fábrica: TODOLIVRO Unidade: PT/10 F1 F4

UN: R\$ 1,40 AV: R\$ 13,97 15: R\$ 14,26
30: R\$ 14,54 45: R\$ 14,83 60: R\$ 15,13



LIVRO ECOM MUNDO ENCANTADO PRINCESAS 10X1
Código: 48476 Fábrica: TODOLIVRO Unidade: PT/10 F1 F4

UN: R\$ 1,40 AV: R\$ 13,97 15: R\$ 14,26
30: R\$ 14,54 45: R\$ 14,83 60: R\$ 15,13



LIVRO ECOM UM MUNDO DE AVENTURAS 10X1
Código: 48477 Fábrica: TODOLIVRO Unidade: PT/10 F1 F4

UN: R\$ 24,95 AV: R\$ 24,95 15: R\$ 25,47
30: R\$ 25,98 45: R\$ 26,50 60: R\$ 27,03



LIVRO ESCOLINHA C/BLOCO A4 CRIATIVO
Código: 48480 Fábrica: TODOLIVRO Unidade: UN/1 F1 F4

UN: R\$ 4,98 AV: R\$ 4,98 15: R\$ 5,09
30: R\$ 5,19 45: R\$ 5,29 60: R\$ 5,40



LIVRO ESCOLINHA TABUADA COMPLETA
Código: 48481 Fábrica: TODOLIVRO Unidade: UN/1 F1 F4

UN: R\$ 2,49 AV: R\$ 2,49 15: R\$ 2,54
30: R\$ 2,59 45: R\$ 2,64 60: R\$ 2,69



LIVRO GIBI CLASSIC A BELA ADORMECIDA
Código: 48489 Fábrica: TODOLIVRO Unidade: UN/1 F1 F4

UN: R\$ 2,49 AV: R\$ 2,49 15: R\$ 2,54
30: R\$ 2,59 45: R\$ 2,64 60: R\$ 2,69



LIVRO GIBI CLASSIC A BELA E A FERA
Código: 48485 Fábrica: TODOLIVRO Unidade: UN/1 F1 F4

UN: R\$ 2,49 AV: R\$ 2,49 15: R\$ 2,54
30: R\$ 2,59 45: R\$ 2,64 60: R\$ 2,69

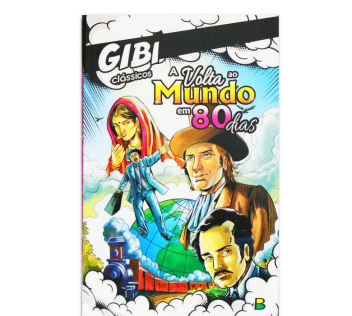

LIVRO GIBI CLASSIC A VOLTA AO MUNDO 80 D
Código: 48496 Fábrica: TODOLIVRO Unidade: UN/1 F1 F4

UN: R\$ 2,49 AV: R\$ 2,49 15: R\$ 2,54
30: R\$ 2,59 45: R\$ 2,64 60: R\$ 2,69



LIVRO GIBI CLASSIC ALICE PARAISO MARAVIL
Código: 48488 Fábrica: TODOLIVRO Unidade: UN/1 F1 F4

UN: R\$ 2,49 AV: R\$ 2,49 15: R\$ 2,54
30: R\$ 2,59 45: R\$ 2,64 60: R\$ 2,69



LIVRO GIBI CLASSIC BRANCA DE NEVE 7 ANOS
Código: 48490 Fábrica: TODOLIVRO Unidade: UN/1 F1 F4

UN: R\$ 2,49 AV: R\$ 2,49 15: R\$ 2,54
30: R\$ 2,59 45: R\$ 2,64 60: R\$ 2,69



LIVRO GIBI CLASSIC DA SELVA
Código: 48492 Fábrica: TODOLIVRO Unidade: UN/1 F1 F4

UN: R\$ 2,49 AV: R\$ 2,49 15: R\$ 2,54
30: R\$ 2,59 45: R\$ 2,64 60: R\$ 2,69



LIVRO GIBI CLASSIC O GATO DE BOTAS
Código: Fábrica: Unidade:
48491 TODOLIVRO UN/1
F1 F4

UN: R\$ 2,49 AV: R\$ 2,49 15: R\$ 2,54
30: R\$ 2,59 45: R\$ 2,64 60: R\$ 2,69

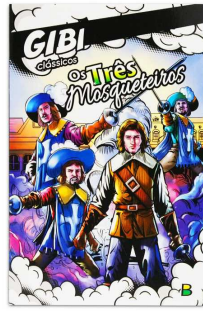

LIVRO GIBI CLASSIC OS TRES MOSQUETEIROS
Código: Fábrica: Unidade:
48494 TODOLIVRO UN/1
F1 F4

UN: R\$ 2,49 AV: R\$ 2,49 15: R\$ 2,54
30: R\$ 2,59 45: R\$ 2,64 60: R\$ 2,69



LIVRO GIBI CLASSIC OS TRES PORQUINHOS
Código: Fábrica: Unidade:
48495 TODOLIVRO UN/1
F1 F4

UN: R\$ 2,49 AV: R\$ 2,49 15: R\$ 2,54
30: R\$ 2,59 45: R\$ 2,64 60: R\$ 2,69



LIVRO GIBI CLASSIC PETER PAN
Código: Fábrica: Unidade:
48493 TODOLIVRO UN/1
F1 F4

UN: R\$ 1,25 AV: R\$ 9,97 15: R\$ 10,18
30: R\$ 10,39 45: R\$ 10,59 60: R\$ 10,81



LIVRO HIST/ATIV/COLOR PEPPA PIG 8X1
Código: Fábrica: Unidade:
46634 CIRANDACULT PT/8
F1 F4

UN: R\$ 1,25 AV: R\$ 9,97 15: R\$ 10,18
30: R\$ 10,39 45: R\$ 10,59 60: R\$ 10,81



LIVRO HIST/ATIV/COLORIR HIST BIBLICA 8X1
Código: Fábrica: Unidade:
38108 CIRANDACULT PT/8
F1 F4

UN: R\$ 1,25 AV: R\$ 9,97 15: R\$ 10,18
30: R\$ 10,39 45: R\$ 10,59 60: R\$ 10,81



LIVRO HIST/ATIV/COLORIR TURMA MONICA 8X1
Código: Fábrica: Unidade:
46633 CIRANDACULT PT/8
F1 F4

UN: R\$ 1,25 AV: R\$ 9,97 15: R\$ 10,18
30: R\$ 10,39 45: R\$ 10,59 60: R\$ 10,81



LIVRO HIST/ATIV/COLORIR TURMA MONICA 8X1
Código: Fábrica: Unidade:
46628 CIRANDACULT PT/8
F1 F4

UN: R\$ 17,96 AV: R\$ 17,96 15: R\$ 18,34
30: R\$ 18,70 45: R\$ 19,08 60: R\$ 19,46



LIVRO PAW PATROL NEON COLORIND C/CANETA
Código: Fábrica: Unidade:
49714 IBC UN/1
F1 F4

UN: R\$ 39,93 AV: R\$ 39,93 15: R\$ 40,76
30: R\$ 41,57 45: R\$ 42,40 60: R\$ 43,25



LIVRO PLAY QUEBRA CAB 18PCS FAZENDA
Código: Fábrica: Unidade:
48498 TODOLIVRO UN/1
F1 F4

UN: R\$ 39,93 AV: R\$ 39,93 15: R\$ 40,76
30: R\$ 41,57 45: R\$ 42,40 60: R\$ 43,25



LIVRO PLAY QUEBRA CAB 18PCS MAMAE FILHO
Código: Fábrica: Unidade:
48500 TODOLIVRO UN/1
F1 F4

UN: R\$ 39,93 AV: R\$ 39,93 15: R\$ 40,76
30: R\$ 41,57 45: R\$ 42,40 60: R\$ 43,25



LIVRO PLAY QUEBRA CAB 18PCS OPOSTOS
Código: Fábrica: Unidade:
48501 TODOLIVRO UN/1
F1 F4

UN: R\$ 39,93 AV: R\$ 39,93 15: R\$ 40,76
30: R\$ 41,57 45: R\$ 42,40 60: R\$ 43,25



LIVRO PLAY QUEBRA CAB 35PCS ALFABETO
Código: Fábrica: Unidade:
48497 TODOLIVRO UN/1
F1 F4

UN: R\$ 39,93 AV: R\$ 39,93 15: R\$ 40,76
30: R\$ 41,57 45: R\$ 42,40 60: R\$ 43,25



LIVRO PLAY QUEBRA CAB 35PCS CORPO HUMANO
Código: Fábrica: Unidade:
48499 TODOLIVRO UN/1
F1 F4

UN: R\$ 39,93 AV: R\$ 39,93 15: R\$ 40,76
30: R\$ 41,57 45: R\$ 42,40 60: R\$ 43,25



LIVRO PLAY QUEBRA CAB 36PCS EMOCOES
Código: Fábrica: Unidade:
48502 TODOLIVRO UN/1
F1 F4

UN: R\$ 39,93 AV: R\$ 39,93 15: R\$ 40,76
30: R\$ 41,57 45: R\$ 42,40 60: R\$ 43,25



LIVRO PLAY QUEBRA CAB 60PCS SILABAS
Código: Fábrica: Unidade:
48503 TODOLIVRO UN/1
F1 F4

UN: R\$ 23,95 AV: R\$ 23,95 15: R\$ 24,45
30: R\$ 24,94 45: R\$ 25,44 60: R\$ 25,95



LIVRO PONTO 50 FLS 2 ASSINATURAS GDE UN
Código: Fábrika: Unidade:
48872 GRIFFE UN/1
F1 F4

UN: R\$ 25,95 AV: R\$ 25,95 15: R\$ 26,49
30: R\$ 27,02 45: R\$ 27,56 60: R\$ 28,11

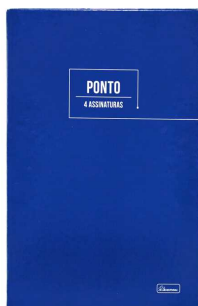

LIVRO PONTO 50 FLS 4 ASSINATURAS NUM UN
Código: Fábrika: Unidade:
48344 PAGINABRASIL UN/1
F1 F4

UN: R\$ 16,67 AV: R\$ 16,67 15: R\$ 17,02
30: R\$ 17,36 45: R\$ 17,71 60: R\$ 18,06



LIVRO POP-UPS BARBIE UMA AVENTURA MAGICA
Código: Fábrika: Unidade:
38092 CIRANDACULT UN/1
F1 F4

UN: R\$ 16,67 AV: R\$ 16,67 15: R\$ 17,02
30: R\$ 17,36 45: R\$ 17,71 60: R\$ 18,06



LIVRO POP-UPS TURMA DA MONICA
Código: Fábrika: Unidade:
38093 CIRANDACULT UN/1
F1 F4

UN: R\$ 13,97 AV: R\$ 13,97 15: R\$ 14,26
30: R\$ 14,54 45: R\$ 14,83 60: R\$ 15,13

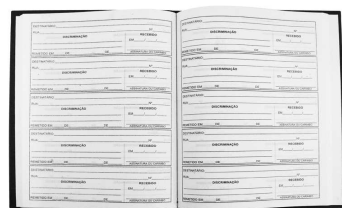

LIVRO PROTOCOLO CORRESP CD 100FL UN
Código: Fábrika: Unidade:
42786 GRIFFE UN/1
F1 F4

UN: R\$ 16,87 AV: R\$ 84,36 15: R\$ 86,12
30: R\$ 87,84 45: R\$ 89,60 60: R\$ 91,39

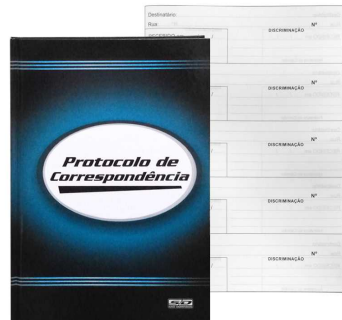

LIVRO PROTOCOLO CORRESP CD 104 FL 5X1
Código: Fábrika: Unidade:
36820 SAO DOMINGOS PT/5
F1 F4

UN: R\$ 16,87 AV: R\$ 84,36 15: R\$ 86,12
30: R\$ 87,84 45: R\$ 89,60 60: R\$ 91,39



LIVRO PROTOCOLO CORRESP 1/4 CD 100F 5X1
Código: Fábrika: Unidade:
42384 PAGINA BRASI PT/5
F1 F4

UN: R\$ 16,96 AV: R\$ 16,96 15: R\$ 17,32
30: R\$ 17,66 45: R\$ 18,02 60: R\$ 18,38



LIVRO SONIC HORA ALEGRIA C/LAPIS COR 084
Código: Fábrika: Unidade:
49713 IBC UN/1
F1 F4

UN: R\$ 15,96 AV: R\$ 15,96 15: R\$ 16,30
30: R\$ 16,62 45: R\$ 16,96 60: R\$ 17,29



MALETA POLIONDA 4 CM AZUL PASTEL
Código: Fábrika: Unidade:
9793 ALAPLAST UN/1
F1 F4

UN: R\$ 15,96 AV: R\$ 15,96 15: R\$ 16,30
30: R\$ 16,62 45: R\$ 16,96 60: R\$ 17,29



MALETA POLIONDA 4 CM PRETO
Código: Fábrika: Unidade:
44330 ALAPLAST UN/1
F1 F4

UN: R\$ 15,96 AV: R\$ 15,96 15: R\$ 16,30
30: R\$ 16,62 45: R\$ 16,96 60: R\$ 17,29



MALETA POLIONDA 4 CM ROSA PASTEL
Código: Fábrika: Unidade:
9867 ALAPLAST UN/1
F1 F4

UN: R\$ 15,96 AV: R\$ 15,96 15: R\$ 16,30
30: R\$ 16,62 45: R\$ 16,96 60: R\$ 17,29



MALETA POLIONDA 4 CM VERDE PASTEL
Código: Fábrika: Unidade:
9791 ALAPLAST UN/1
F1 F4

UN: R\$ 23,95 AV: R\$ 23,95 15: R\$ 24,45
30: R\$ 24,94 45: R\$ 25,44 60: R\$ 25,95



MALETA PP OFICIO C/ALCA MARIO 2281
Código: Fábrika: Unidade:
41274 DAC UN/1
F1 F4

UN: R\$ 27,95 AV: R\$ 27,95 15: R\$ 28,53
30: R\$ 29,10 45: R\$ 29,68 60: R\$ 30,27



MALETA PP OFICIO C/ALCA BATMAN 2826
Código: Fábrika: Unidade:
41271 DAC UN/1
F1 F4

UN: R\$ 23,95 AV: R\$ 23,95 15: R\$ 24,45
30: R\$ 24,94 45: R\$ 25,44 60: R\$ 25,95



MALETA PP OFICIO C/ALCA CARROS 2545
Código: Fábrika: Unidade:
41272 DAC UN/1
F1 F4

UN: R\$ 23,95 AV: R\$ 23,95 15: R\$ 24,45
30: R\$ 24,94 45: R\$ 25,44 60: R\$ 25,95



MALETA PP OFICIO C/ALCA MIRACULOUS CAT
Código: Fábrika: Unidade:
41277 DAC UN/1
F1 F4

UN: R\$ 23,95 AV: R\$ 23,95 15: R\$ 24,45
30: R\$ 24,94 45: R\$ 25,44 60: R\$ 25,95



MALETA PP OFICIO C/ALCA MIRACULOUS 2607
Código: Fábrica: Unidade:
41276 DAC UN/1
F1 F4

UN: R\$ 23,95 AV: R\$ 23,95 15: R\$ 24,45
30: R\$ 24,94 45: R\$ 25,44 60: R\$ 25,95



MALETA PP OFICIO C/ALCA PAW PATROL FEM
Código: Fábrica: Unidade:
41278 DAC UN/1
F1 F4

UN: R\$ 44,92 AV: R\$ 44,92 15: R\$ 45,85
30: R\$ 46,77 45: R\$ 47,71 60: R\$ 48,66



MAQUINA ETIQUETADORA 8 DIG MX5500
Código: Fábrica: Unidade:
17620 HAI BRASIL UN/1
F1 F4

UN: R\$ 58,51 AV: R\$ 58,51 15: R\$ 59,73
30: R\$ 60,92 45: R\$ 62,14 60: R\$ 63,38



MAQUINA ETIQUETADORA 8 DIG MX5500 6505
Código: Fábrica: Unidade:
45943 WIN PAPER UN/1
F1 F4

UN: R\$ 43,18 AV: R\$ 43,18 15: R\$ 44,08
30: R\$ 44,96 45: R\$ 45,86 60: R\$ 46,78



MAQUINA ETIQUETADORA 8 DIG 10326
Código: Fábrica: Unidade:
48723 LETRON UN/1
F1 F4

UN: R\$ 798,71 AV: R\$ 798,71 15: R\$ 815,35
30: R\$ 831,66 45: R\$ 848,29 60: R\$ 865,26



MAQUINA PLASTIFICADORA BIVOLT OFICIO 280
Código: Fábrica: Unidade:
17077 MAROGER UN/1
F1 F4

UN: R\$ 1,08 AV: R\$ 12,97 15: R\$ 13,24
30: R\$ 13,50 45: R\$ 13,77 60: R\$ 14,05



MARCA TEXTO DASHLIGHT AMARELO 2201 12X1
Código: Fábrica: Unidade:
47850 BRW DZ/12
F1 F4

UN: R\$ 1,08 AV: R\$ 12,97 15: R\$ 13,24
30: R\$ 13,50 45: R\$ 13,77 60: R\$ 14,05



MARCA TEXTO DASHLIGHT LARANJA 2204 12X1
Código: Fábrica: Unidade:
47853 BRW DZ/12
F1 F4

UN: R\$ 1,08 AV: R\$ 12,97 15: R\$ 13,24
30: R\$ 13,50 45: R\$ 13,77 60: R\$ 14,05



MARCA TEXTO DASHLIGHT ROSA 2202 12X1
Código: Fábrica: Unidade:
47851 BRW DZ/12
F1 F4

UN: R\$ 1,08 AV: R\$ 12,97 15: R\$ 13,24
30: R\$ 13,50 45: R\$ 13,77 60: R\$ 14,05



MARCA TEXTO DASHLIGHT VERDE 2203 12X1
Código: Fábrica: Unidade:
47852 BRW DZ/12
F1 F4

UN: R\$ 1,33 AV: R\$ 7,98 15: R\$ 8,14
30: R\$ 8,31 45: R\$ 8,47 60: R\$ 8,64



MARCA TEXTO FLUOR AMARELO 6X1
Código: Fábrica: Unidade:
44271 M COMERCIO CT/6
F1 F4

UN: R\$ 1,49 AV: R\$ 17,85 15: R\$ 18,22
30: R\$ 18,59 45: R\$ 18,96 60: R\$ 19,34



MARCA TEXTO FLUOR AMARELO 612 12X1
Código: Fábrica: Unidade:
41734 MASTERPRINT DZ/12
F1 F4

UN: R\$ 1,05 AV: R\$ 12,57 15: R\$ 12,83
30: R\$ 13,09 45: R\$ 13,35 60: R\$ 13,62



MARCA TEXTO FLUOR AMARELO 617947 12X1
Código: Fábrica: Unidade:
48315 BAZZE DZ/12
F1 F4

UN: R\$ 1,12 AV: R\$ 26,95 15: R\$ 27,51
30: R\$ 28,06 45: R\$ 28,62 60: R\$ 29,19



MARCA TEXTO FLUOR AMAR/VERDE/LARANJ 24X1
Código: Fábrica: Unidade:
48317 BAZZE CX/24
F1 F4

UN: R\$ 1,49 AV: R\$ 17,85 15: R\$ 18,22
30: R\$ 18,59 45: R\$ 18,96 60: R\$ 19,34



MARCA TEXTO FLUOR AZUL 612 12X1
Código: Fábrica: Unidade:
42887 MASTERPRINT DZ/12
F1 F4

UN: R\$ 2,85 AV: R\$ 2,85 15: R\$ 2,90
30: R\$ 2,96 45: R\$ 3,02 60: R\$ 3,08



MARCA TEXTO FLUOR GEL AMARELO UN
Código: Fábrica: Unidade:
35733 MASTERPRINT CR/1
F1 F4

UN: R\$ 3,49 AV: R\$ 20,96 15: R\$ 21,39
30: R\$ 21,82 45: R\$ 22,26 60: R\$ 22,70



MARCA TEXTO FLUOR GEL AMARELO 613 6X1
Código: Fábrika: Unidade:
42585 MASTERPRINT CX/6
F1 F4

UN: R\$ 4,82 AV: R\$ 57,79 15: R\$ 58,99
30: R\$ 60,17 45: R\$ 61,37 60: R\$ 62,60



MARCA TEXTO FLUOR GEL AMARELO 9001 12X1
Código: Fábrika: Unidade:
20361 BRW DZ/12
F1 F4

UN: R\$ 3,49 AV: R\$ 20,96 15: R\$ 21,39
30: R\$ 21,82 45: R\$ 22,26 60: R\$ 22,70



MARCA TEXTO FLUOR GEL LARANJA 613 6X1
Código: Fábrika: Unidade:
48906 MASTERPRINT CX/6
F1 F4

UN: R\$ 4,82 AV: R\$ 57,79 15: R\$ 58,99
30: R\$ 60,17 45: R\$ 61,37 60: R\$ 62,60



MARCA TEXTO FLUOR GEL LARANJA 9004 12X1
Código: Fábrika: Unidade:
50667 BRW DZ/12
F1 F4

UN: R\$ 3,49 AV: R\$ 20,96 15: R\$ 21,39
30: R\$ 21,82 45: R\$ 22,26 60: R\$ 22,70



MARCA TEXTO FLUOR GEL ROSA 613 6X1
Código: Fábrika: Unidade:
48905 MASTERPRINT CX/6
F1 F4

UN: R\$ 4,82 AV: R\$ 57,79 15: R\$ 58,99
30: R\$ 60,17 45: R\$ 61,37 60: R\$ 62,60



MARCA TEXTO FLUOR GEL ROSA 9002 12X1
Código: Fábrika: Unidade:
50668 BRW DZ/12
F1 F4

UN: R\$ 1,49 AV: R\$ 17,85 15: R\$ 18,22
30: R\$ 18,59 45: R\$ 18,96 60: R\$ 19,34



MARCA TEXTO FLUOR LARANJA 612 12X1
Código: Fábrika: Unidade:
42886 MASTERPRINT DZ/12
F1 F4

UN: R\$ 1,05 AV: R\$ 12,57 15: R\$ 12,83
30: R\$ 13,09 45: R\$ 13,35 60: R\$ 13,62



MARCA TEXTO FLUOR LARANJA 900074 12X1
Código: Fábrika: Unidade:
48316 BAZZE DZ/12
F1 F4

UN: R\$ 1,49 AV: R\$ 17,85 15: R\$ 18,22
30: R\$ 18,59 45: R\$ 18,96 60: R\$ 19,34



MARCA TEXTO FLUOR ROSA 612 12X1
Código: Fábrika: Unidade:
42889 MASTERPRINT DZ/12
F1 F4

UN: R\$ 1,05 AV: R\$ 12,57 15: R\$ 12,83
30: R\$ 13,09 45: R\$ 13,35 60: R\$ 13,62



MARCA TEXTO FLUOR ROSA 904645 12X1
Código: Fábrika: Unidade:
48444 BAZZE DZ/12
F1 F4

UN: R\$ 1,49 AV: R\$ 17,85 15: R\$ 18,22
30: R\$ 18,59 45: R\$ 18,96 60: R\$ 19,34



MARCA TEXTO FLUOR VERDE 2003 12X1
Código: Fábrika: Unidade:
41085 BRW DZ/12
F1 F4

UN: R\$ 1,49 AV: R\$ 17,85 15: R\$ 18,22
30: R\$ 18,59 45: R\$ 18,96 60: R\$ 19,34



MARCA TEXTO FLUOR VERDE 612 12X1
Código: Fábrika: Unidade:
42885 MASTERPRINT DZ/12
F1 F4

UN: R\$ 1,05 AV: R\$ 12,57 15: R\$ 12,83
30: R\$ 13,09 45: R\$ 13,35 60: R\$ 13,62



MARCA TEXTO FLUOR VERDE 617961 12X1
Código: Fábrika: Unidade:
48810 BAZZE DZ/12
F1 F4

UN: R\$ 1,49 AV: R\$ 17,85 15: R\$ 18,22
30: R\$ 18,59 45: R\$ 18,96 60: R\$ 19,34



MARCA TEXTO FLUOR VERMELHO 2007 12X1
Código: Fábrika: Unidade:
19731 BRW DZ/12
F1 F4

UN: R\$ 1,49 AV: R\$ 17,85 15: R\$ 18,22
30: R\$ 18,59 45: R\$ 18,96 60: R\$ 19,34



MARCA TEXTO FLUOR VERMELHO 612 12X1
Código: Fábrika: Unidade:
42888 MASTERPRINT DZ/12
F1 F4

UN: R\$ 2,33 AV: R\$ 13,97 15: R\$ 14,26
30: R\$ 14,54 45: R\$ 14,83 60: R\$ 15,13



MARCA TEXTO METALICO SORT 612 6X1
Código: Fábrika: Unidade:
50007 MASTERPRINT CX/6
F1 F4

UN: R\$ 0,95 AV: R\$ 11,36 15: R\$ 11,60
30: R\$ 11,83 45: R\$ 12,07 60: R\$ 12,31



MARCA TEXTO NEON SLIM AMARELO 614 12X1
Código: Fábrica: Unidade:
51053 MASTERPRINT DZ/12
F1 F4

UN: R\$ 1,89 AV: R\$ 11,36 15: R\$ 11,60
30: R\$ 11,83 45: R\$ 12,07 60: R\$ 12,31



MARCA TEXTO NEON SLIM AZUL 614 12X1
Código: Fábrica: Unidade:
51055 MASTERPRINT PT/6
F1 F4

UN: R\$ 0,95 AV: R\$ 11,36 15: R\$ 11,60
30: R\$ 11,83 45: R\$ 12,07 60: R\$ 12,31



MARCA TEXTO NEON SLIM LARANJA 614 12X1
Código: Fábrica: Unidade:
51057 MASTERPRINT DZ/12
F1 F4

UN: R\$ 0,95 AV: R\$ 11,36 15: R\$ 11,60
30: R\$ 11,83 45: R\$ 12,07 60: R\$ 12,31



MARCA TEXTO NEON SLIM ROSA 614 12X1
Código: Fábrica: Unidade:
51056 MASTERPRINT DZ/12
F1 F4

UN: R\$ 1,29 AV: R\$ 7,74 15: R\$ 7,90
30: R\$ 8,06 45: R\$ 8,22 60: R\$ 8,38



MARCA TEXTO NEON SLIM SORT 610 6X1
Código: Fábrica: Unidade:
51051 MASTERPRINT PT/6
F1 F4

UN: R\$ 0,95 AV: R\$ 11,36 15: R\$ 11,60
30: R\$ 11,83 45: R\$ 12,07 60: R\$ 12,31



MARCA TEXTO NEON SLIM VERDE 614 12X1
Código: Fábrica: Unidade:
51054 MASTERPRINT DZ/12
F1 F4

UN: R\$ 1,61 AV: R\$ 9,64 15: R\$ 9,85
30: R\$ 10,04 45: R\$ 10,24 60: R\$ 10,45



MARCA TEXTO PASTEL AMARELO 612 6X1
Código: Fábrica: Unidade:
47215 MASTERPRINT CX/6
F1 F4

UN: R\$ 1,61 AV: R\$ 9,64 15: R\$ 9,85
30: R\$ 10,04 45: R\$ 10,24 60: R\$ 10,45



MARCA TEXTO PASTEL AZUL 612 6X1
Código: Fábrica: Unidade:
47216 MASTERPRINT CX/6
F1 F4

UN: R\$ 1,61 AV: R\$ 9,64 15: R\$ 9,85
30: R\$ 10,04 45: R\$ 10,24 60: R\$ 10,45



MARCA TEXTO PASTEL ROSE 612 6X1
Código: Fábrica: Unidade:
47217 MASTERPRINT CX/6
F1 F4

UN: R\$ 1,29 AV: R\$ 7,74 15: R\$ 7,90
30: R\$ 8,06 45: R\$ 8,22 60: R\$ 8,38



MARCA TEXTO PASTEL SLIM SORT 611 6X1
Código: Fábrica: Unidade:
51052 MASTERPRINT PT/6
F1 F4

UN: R\$ 1,61 AV: R\$ 9,64 15: R\$ 9,85
30: R\$ 10,04 45: R\$ 10,24 60: R\$ 10,45



MARCA TEXTO PASTEL VERDE 612 6X1
Código: Fábrica: Unidade:
47218 MASTERPRINT CX/6
F1 F4

UN: R\$ 4,98 AV: R\$ 4,98 15: R\$ 5,09
30: R\$ 5,19 45: R\$ 5,29 60: R\$ 5,40



MARCADOR DETECTA DH FALSO 4915014
Código: Fábrica: Unidade:
46775 ONDA CT/1
F1 F4

UN: R\$ 2,29 AV: R\$ 2,29 15: R\$ 2,33
30: R\$ 2,38 45: R\$ 2,43 60: R\$ 2,48



MASSA MODELAR 6 CORES 65 GRS 216
Código: Fábrica: Unidade:
33833 MAGIX UN/1
F1 F4

UN: R\$ 4,74 AV: R\$ 4,74 15: R\$ 4,84
30: R\$ 4,94 45: R\$ 5,04 60: R\$ 5,14



MASSA MODELAR 6 CORES 60 GRS PLASTI UN
Código: Fábrica: Unidade:
45018 ACRILEX UN/1
F1 F4

UN: R\$ 5,79 AV: R\$ 5,79 15: R\$ 5,91
30: R\$ 6,03 45: R\$ 6,15 60: R\$ 6,27



MASSA MODELAR 6 CORES 90 GRS PLASTI UN
Código: Fábrica: Unidade:
45017 ACRILEX UN/1
F1 F4

UN: R\$ 3,54 AV: R\$ 3,54 15: R\$ 3,62
30: R\$ 3,69 45: R\$ 3,76 60: R\$ 3,84



MASSA MODELAR 6 CORES 90 GRS SOFT UN
Código: Fábrica: Unidade:
36061 ACRILEX UN/1
F1 F4

UN: R\$ 76,87 AV: R\$ 76,87 15: R\$ 78,47
30: R\$ 80,04 45: R\$ 81,64 60: R\$ 83,27



MASSA MODELAR BALDE C/36UN 2,100KG
Código: Fábrika: Unidade:
47394 APLICOR UN/1
F1 F4

UN: R\$ 15,96 AV: R\$ 15,96 15: R\$ 16,30
30: R\$ 16,62 45: R\$ 16,96 60: R\$ 17,29



MASSA MODELAR POTE 500 GRS AMARELO 241
Código: Fábrika: Unidade:
50997 MAGIX UN/1
F1 F4

UN: R\$ 15,96 AV: R\$ 15,96 15: R\$ 16,30
30: R\$ 16,62 45: R\$ 16,96 60: R\$ 17,29



MASSA MODELAR POTE 500 GRS AZUL 248
Código: Fábrika: Unidade:
50999 MAGIX UN/1
F1 F4

UN: R\$ 15,96 AV: R\$ 15,96 15: R\$ 16,30
30: R\$ 16,62 45: R\$ 16,96 60: R\$ 17,29



MASSA MODELAR POTE 500 GRS BRANCO 247
Código: Fábrika: Unidade:
50996 MAGIX UN/1
F1 F4

UN: R\$ 15,96 AV: R\$ 15,96 15: R\$ 16,30
30: R\$ 16,62 45: R\$ 16,96 60: R\$ 17,29



MASSA MODELAR POTE 500 GRS ROSA 245
Código: Fábrika: Unidade:
51001 MAGIX UN/1
F1 F4

UN: R\$ 15,96 AV: R\$ 15,96 15: R\$ 16,30
30: R\$ 16,62 45: R\$ 16,96 60: R\$ 17,29



MASSA MODELAR POTE 500 GRS VERDE CLA 243
Código: Fábrika: Unidade:
50998 MAGIX UN/1
F1 F4

UN: R\$ 4,78 AV: R\$ 4,78 15: R\$ 4,88
30: R\$ 4,98 45: R\$ 5,08 60: R\$ 5,18



MASSA MODELAR 12 CORES 130 GRS 215
Código: Fábrika: Unidade:
41010 MAGIX UN/1
F1 F4

UN: R\$ 9,97 AV: R\$ 9,97 15: R\$ 10,18
30: R\$ 10,39 45: R\$ 10,59 60: R\$ 10,81



MASSA MODELAR 12 CORES 180 GRS PLASTI UN
Código: Fábrika: Unidade:
45016 ACRILEX UN/1
F1 F4

UN: R\$ 4,75 AV: R\$ 4,75 15: R\$ 4,75
30: R\$ 4,75 45: R\$ 4,75 60: R\$ 4,75



MASSA MODELAR 12 CORES 180 GRS 210
Código: Fábrika: Unidade:
36062 MAGIX UN/1
F1 F4

UN: R\$ 299,51 AV: R\$ 299,51 15: R\$ 305,75
30: R\$ 311,86 45: R\$ 318,10 60: R\$ 324,46



MOCHILA CARR MH (CAPRICH) MC3446
Código: Fábrika: Unidade:
34324 WOOKEY UN/1
F1 F4

UN: R\$ 299,51 AV: R\$ 299,51 15: R\$ 305,75
30: R\$ 311,86 45: R\$ 318,10 60: R\$ 324,46



MOCHILA CARR MH (CAPRICH) MC3448
Código: Fábrika: Unidade:
34288 WOOKEY UN/1
F1 F4

UN: R\$ 249,59 AV: R\$ 249,59 15: R\$ 254,79
30: R\$ 259,89 45: R\$ 265,08 60: R\$ 270,39



MOCHILA CARR MH (CAPRICH) 3765
Código: Fábrika: Unidade:
34250 VOZZ UN/1
F1 F4

UN: R\$ 259,57 AV: R\$ 259,57 15: R\$ 264,98
30: R\$ 270,28 45: R\$ 275,69 60: R\$ 281,20



MOCHILA CARR MH (CAPRICH) 3766
Código: Fábrika: Unidade:
34310 VOZZ UN/1
F1 F4

UN: R\$ 149,75 AV: R\$ 149,75 15: R\$ 152,87
30: R\$ 155,93 45: R\$ 159,05 60: R\$ 162,23



MOCHILA CARR SUPER HOT MC3437
Código: Fábrika: Unidade:
34252 VOZZ UN/1
F1 F4

UN: R\$ 119,80 AV: R\$ 119,80 15: R\$ 122,29
30: R\$ 124,74 45: R\$ 127,23 60: R\$ 129,78



MOCHILA CARR WOOKEY MC3406
Código: Fábrika: Unidade:
34287 WOOKEY UN/1
F1 F4

UN: R\$ 279,54 AV: R\$ 279,54 15: R\$ 285,37
30: R\$ 291,07 45: R\$ 296,89 60: R\$ 302,83



MOCHILA CARR WOOKEY MC3442
Código: Fábrika: Unidade:
34325 WOOKEY UN/1
F1 F4

UN: R\$ 149,75 AV: R\$ 149,75 15: R\$ 152,87
30: R\$ 155,93 45: R\$ 159,05 60: R\$ 162,23



MOCHILA CARR WOOKEY MC3465

Código: Fábrica: Unidade:
34292 WOOKEY UN/1
F1 F4

UN: R\$ 249,59 AV: R\$ 249,59 15: R\$ 254,79
30: R\$ 259,89 45: R\$ 265,08 60: R\$ 270,39



MOCHILA CARR WOOKEY MC3690

Código: Fábrica: Unidade:
34293 WOOKEY UN/1
F1 F4

UN: R\$ 249,59 AV: R\$ 249,59 15: R\$ 254,79
30: R\$ 259,89 45: R\$ 265,08 60: R\$ 270,39



MOCHILA CARR WOOKEY MC3691

Código: Fábrica: Unidade:
34294 WOOKEY UN/1
F1 F4

UN: R\$ 149,75 AV: R\$ 149,75 15: R\$ 152,87
30: R\$ 155,93 45: R\$ 159,05 60: R\$ 162,23



MOCHILA CARR WOOKEY MC3713

Código: Fábrica: Unidade:
34298 WOOKEY UN/1
F1 F4

UN: R\$ 149,75 AV: R\$ 149,75 15: R\$ 152,87
30: R\$ 155,93 45: R\$ 159,05 60: R\$ 162,23



MOCHILA CARR WOOKEY MC3714

Código: Fábrica: Unidade:
34299 WOOKEY UN/1
F1 F4

UN: R\$ 94,85 AV: R\$ 94,85 15: R\$ 96,82
30: R\$ 98,76 45: R\$ 100,74 60: R\$ 102,75



MOCHILA CARR WOOKEY 3458

Código: Fábrica: Unidade:
34289 WOOKEY UN/1
F1 F4

UN: R\$ 179,70 AV: R\$ 179,70 15: R\$ 183,45
30: R\$ 187,11 45: R\$ 190,86 60: R\$ 194,67



MOCHILA C/CARR WOOKEY MC3693

Código: Fábrica: Unidade:
38060 WOOKEY UN/1
F1 F4

UN: R\$ 30,94 AV: R\$ 30,94 15: R\$ 31,59
30: R\$ 32,22 45: R\$ 32,86 60: R\$ 33,52



MOCHILA CONVOY CASUAL POLIESTER C070000

Código: Fábrica: Unidade:
23649 CONVOY UN/1
F1 F4

UN: R\$ 49,91 AV: R\$ 49,91 15: R\$ 50,95
30: R\$ 51,97 45: R\$ 53,01 60: R\$ 54,07



MOCHILA CONVOY CASUAL POLIESTER YS29068

Código: Fábrica: Unidade:
34099 YIN'S UN/1
F1 F4

UN: R\$ 44,99 AV: R\$ 44,99 15: R\$ 44,99
30: R\$ 44,99 45: R\$ 44,99 60: R\$ 44,99



MOCHILA CONVOY CASUAL POLIESTER YS29071

Código: Fábrica: Unidade:
34046 YIN'S UN/1
F1 F4

UN: R\$ 49,91 AV: R\$ 49,91 15: R\$ 50,95
30: R\$ 51,97 45: R\$ 53,01 60: R\$ 54,07



MOCHILA CONVOY CASUAL POLIESTER YS29073

Código: Fábrica: Unidade:
34100 YIN'S UN/1
F1 F4

UN: R\$ 49,91 AV: R\$ 49,91 15: R\$ 50,95
30: R\$ 51,97 45: R\$ 53,01 60: R\$ 54,07



MOCHILA CONVOY CASUAL POLIESTER YS29082

Código: Fábrica: Unidade:
35874 YIN'S UN/1
F1 F4

UN: R\$ 49,91 AV: R\$ 49,91 15: R\$ 50,95
30: R\$ 51,97 45: R\$ 53,01 60: R\$ 54,07



MOCHILA CONVOY JUVENIL FLORES YS29272

Código: Fábrica: Unidade:
42940 YINS UN/1
F1 F4

UN: R\$ 139,77 AV: R\$ 139,77 15: R\$ 142,68
30: R\$ 145,53 45: R\$ 148,44 60: R\$ 151,41



MOCHILA ESPORTIVA BARCELONA B01 9150

Código: Fábrica: Unidade:
39839 XERYUS UN/1
F1 F4

UN: R\$ 139,77 AV: R\$ 139,77 15: R\$ 142,68
30: R\$ 145,53 45: R\$ 148,44 60: R\$ 151,41



MOCHILA ESPORTIVA BARCELONA B06 9155

Código: Fábrica: Unidade:
39840 XERYUS UN/1
F1 F4

UN: R\$ 149,75 AV: R\$ 149,75 15: R\$ 152,87
30: R\$ 155,93 45: R\$ 159,05 60: R\$ 162,23



MOCHILA ESPORTIVA BARCELONA B07 9156

Código: Fábrica: Unidade:
39841 XERYUS UN/1
F1 F4

UN: R\$ 139,77 AV: R\$ 139,77 15: R\$ 142,68
30: R\$ 145,53 45: R\$ 148,44 60: R\$ 151,41



MOCHILA ESPORTIVA BARCELONA TEEN B1 9157

Código: Fábrica: Unidade:
39842 XERYUS UN/1
F1 F4

UN: R\$ 199,67 AV: R\$ 199,67 15: R\$ 203,83
30: R\$ 207,91 45: R\$ 212,06 60: R\$ 216,31



MOCHILA ESPORTIVA CORINTHIANS B01 9890

Código: Fábrica: Unidade:
39838 XERYUS UN/1
F1 F4

UN: R\$ 199,67 AV: R\$ 199,67 15: R\$ 203,83
30: R\$ 207,91 45: R\$ 212,06 60: R\$ 216,31



MOCHILA ESPORTIVA CORINTHIANS I01 9893

Código: Fábrica: Unidade:
39837 XERYUS UN/1
F1 F4

UN: R\$ 209,65 AV: R\$ 209,65 15: R\$ 214,02
30: R\$ 218,30 45: R\$ 222,67 60: R\$ 227,12



MOCHILA ESPORTIVA FLAMENGO B03 9904

Código: Fábrica: Unidade:
39836 XERYUS UN/1
F1 F4

UN: R\$ 89,85 AV: R\$ 89,85 15: R\$ 91,72
30: R\$ 93,55 45: R\$ 95,42 60: R\$ 97,33



MOCHILA FEM NICOBOCO NB49

Código: Fábrica: Unidade:
29291 NICOBOCO UN/1
F1 F4

UN: R\$ 41,93 AV: R\$ 41,93 15: R\$ 42,81
30: R\$ 43,66 45: R\$ 44,54 60: R\$ 45,43



MOCHILA INF BATTLE M M4651

Código: Fábrica: Unidade:
49021 PONTO VERDE UN/1
F1 F4

UN: R\$ 40,83 AV: R\$ 40,83 15: R\$ 41,69
30: R\$ 42,52 45: R\$ 43,37 60: R\$ 44,24



MOCHILA INF BATTLE PRE M4650

Código: Fábrica: Unidade:
49020 PONTO VERDE UN/1
F1 F4

UN: R\$ 52,91 AV: R\$ 52,91 15: R\$ 54,01
30: R\$ 55,09 45: R\$ 56,19 60: R\$ 57,31



MOCHILA INF BRANCA DE NEVE PRE M4620

Código: Fábrica: Unidade:
49042 PONTO VERDE UN/1
F1 F4

UN: R\$ 59,89 AV: R\$ 59,89 15: R\$ 61,14
30: R\$ 62,36 45: R\$ 63,61 60: R\$ 64,88



MOCHILA INF CALIFORNIA GIRLS REL M 3023

Código: Fábrica: Unidade:
32249 SBC UN/1
F1 F4

UN: R\$ 54,90 AV: R\$ 54,90 15: R\$ 56,05
30: R\$ 57,17 45: R\$ 58,31 60: R\$ 59,48



MOCHILA INF CALIFORNIA GIRLS REL P 2943

Código: Fábrica: Unidade:
32256 SBC UN/1
F1 F4

UN: R\$ 59,89 AV: R\$ 59,89 15: R\$ 61,14
30: R\$ 62,36 45: R\$ 63,61 60: R\$ 64,88



MOCHILA INF CALIFORNIA GIRLS REL P 3022

Código: Fábrica: Unidade:
32251 SBC UN/1
F1 F4

UN: R\$ 64,89 AV: R\$ 64,89 15: R\$ 66,24
30: R\$ 67,56 45: R\$ 68,91 60: R\$ 70,29



MOCHILA INF CALIFORNIA GIRLS REL P 3193

Código: Fábrica: Unidade:
32252 SBC UN/1
F1 F4

UN: R\$ 132,78 AV: R\$ 132,78 15: R\$ 135,54
30: R\$ 138,25 45: R\$ 141,02 60: R\$ 143,84



MOCHILA INF CARR BATTLE KIT 3PC MCK4656

Código: Fábrica: Unidade:
48996 PONTO VERDE UN/1
F1 F4

UN: R\$ 83,86 AV: R\$ 83,86 15: R\$ 85,60
30: R\$ 87,31 45: R\$ 89,06 60: R\$ 90,84



MOCHILA INF CARR BATTLE MC4654

Código: Fábrica: Unidade:
48994 PONTO VERDE UN/1
F1 F4

UN: R\$ 82,86 AV: R\$ 82,86 15: R\$ 84,58
30: R\$ 86,28 45: R\$ 88,00 60: R\$ 89,76



MOCHILA INF CARR BATTLE PRE MC4653

Código: Fábrica: Unidade:
48993 PONTO VERDE UN/1
F1 F4

UN: R\$ 132,78 AV: R\$ 132,78 15: R\$ 135,54
30: R\$ 138,25 45: R\$ 141,02 60: R\$ 143,84



MOCHILA INF CARR BEE FRIENDES KIT K4802

Código: Fábrica: Unidade:
49079 PONTO VERDE UN/1
F1 F4

UN: R\$ 139,77 AV: R\$ 139,77 15: R\$ 142,68
30: R\$ 145,53 45: R\$ 148,44 60: R\$ 151,41



MOCHILA INF CARR BELIEVE G MCK4741
Código: Fábrica: Unidade:
49033 PONTO VERDE UN/1
F1 F4

UN: R\$ 289,53 AV: R\$ 289,53 15: R\$ 295,56
30: R\$ 301,47 45: R\$ 307,50 60: R\$ 313,65



MOCHILA INF CARR BELLA KIT 3PC MCK3717
Código: Fábrica: Unidade:
34256 SBC UN/1
F1 F4

UN: R\$ 89,85 AV: R\$ 89,85 15: R\$ 91,72
30: R\$ 93,55 45: R\$ 95,42 60: R\$ 97,33



MOCHILA INF CARR BRANCA DE NEVE P MC4624
Código: Fábrica: Unidade:
49038 PONTO VERDE UN/1
F1 F4

UN: R\$ 99,83 AV: R\$ 99,83 15: R\$ 101,91
30: R\$ 103,95 45: R\$ 106,03 60: R\$ 108,15



MOCHILA INF CARR CRYSTAL PRINCE G 2633
Código: Fábrica: Unidade:
31341 SBC UN/1
F1 F4

UN: R\$ 209,65 AV: R\$ 209,65 15: R\$ 214,02
30: R\$ 218,30 45: R\$ 222,67 60: R\$ 227,12



MOCHILA INF CARR EVA ARANHA 3D KIT 4893
Código: Fábrica: Unidade:
49034 PONTO VERDE UN/1
F1 F4

UN: R\$ 209,65 AV: R\$ 209,65 15: R\$ 214,02
30: R\$ 218,30 45: R\$ 222,67 60: R\$ 227,12



MOCHILA INF CARR EVA PRINCESS 3D KIT 5039
Código: Fábrica: Unidade:
49035 PONTO VERDE UN/1
F1 F4

UN: R\$ 207,17 AV: R\$ 207,17 15: R\$ 211,48
30: R\$ 215,71 45: R\$ 220,03 60: R\$ 224,43



MOCHILA INF CARR FUNNY KIT 3PC MCK4334
Código: Fábrica: Unidade:
44024 PONTO VERDE UN/1
F1 F4

UN: R\$ 132,78 AV: R\$ 132,78 15: R\$ 135,54
30: R\$ 138,25 45: R\$ 141,02 60: R\$ 143,84



MOCHILA INF CARR GAME WORLD KIT 3PC 4831
Código: Fábrica: Unidade:
49081 PONTO VERDE UN/1
F1 F4

UN: R\$ 95,84 AV: R\$ 95,84 15: R\$ 97,83
30: R\$ 99,79 45: R\$ 101,79 60: R\$ 103,82



MOCHILA INF CARR GAMER BOY P MC4729
Código: Fábrica: Unidade:
49187 PONTO VERDE UN/1
F1 F4

UN: R\$ 249,59 AV: R\$ 249,59 15: R\$ 254,79
30: R\$ 259,89 45: R\$ 265,08 60: R\$ 270,39



MOCHILA INF CARR GUARDIAN KIT 3PC MK4180
Código: Fábrica: Unidade:
44394 PONTO VERDE UN/1
F1 F4

UN: R\$ 119,99 AV: R\$ 119,99 15: R\$ 119,99
30: R\$ 119,99 45: R\$ 119,99 60: R\$ 119,99



MOCHILA INF CARR KARS KID KIT 3PC K4666
Código: Fábrica: Unidade:
50517 PONTO VERDE UN/1
F1 F4

UN: R\$ 139,77 AV: R\$ 139,77 15: R\$ 142,68
30: R\$ 145,53 45: R\$ 148,44 60: R\$ 151,41



MOCHILA INF CARR KARS KIDS KIT 3PC K4667
Código: Fábrica: Unidade:
48997 PONTO VERDE UN/1
F1 F4

UN: R\$ 129,78 AV: R\$ 129,78 15: R\$ 132,49
30: R\$ 135,14 45: R\$ 137,84 60: R\$ 140,60



MOCHILA INF CARR KARS KIDS M4660
Código: Fábrica: Unidade:
32175 PONTO VERDE UN/1
F1 F4

UN: R\$ 84,85 AV: R\$ 84,85 15: R\$ 86,62
30: R\$ 88,35 45: R\$ 90,12 60: R\$ 91,92



MOCHILA INF CARR KARS KIDS PRE MC4663
Código: Fábrica: Unidade:
49184 PONTO VERDE UN/1
F1 F4

UN: R\$ 94,84 AV: R\$ 94,84 15: R\$ 96,81
30: R\$ 98,75 45: R\$ 100,73 60: R\$ 102,74



MOCHILA INF CARR LINHA BABY POA MC4720
Código: Fábrica: Unidade:
49186 PONTO VERDE UN/1
F1 F4

UN: R\$ 152,75 AV: R\$ 152,75 15: R\$ 155,93
30: R\$ 159,05 45: R\$ 162,23 60: R\$ 165,47



MOCHILA INF CARR LINHA BABY SPIDE MC4726
Código: Fábrica: Unidade:
46704 PONTO VERDE UN/1
F1 F4

UN: R\$ 82,86 AV: R\$ 82,86 15: R\$ 84,58
30: R\$ 86,28 45: R\$ 88,00 60: R\$ 89,76



MOCHILA INF CARR NINJA MC4685

Código: Fábrica: Unidade:
48999 PONTO VERDE UN/1
F1 F4

UN: R\$ 69,88 AV: R\$ 69,88 15: R\$ 71,33
30: R\$ 72,76 45: R\$ 74,22 60: R\$ 75,70



MOCHILA INF CARR PEQ

Código: Fábrica: Unidade:
15520 HAI BRASIL UN/1
F1 F4

UN: R\$ 89,85 AV: R\$ 89,85 15: R\$ 91,72
30: R\$ 93,55 45: R\$ 95,42 60: R\$ 97,33



MOCHILA INF CARR PIGGY G 2003

Código: Fábrica: Unidade:
29629 SBC UN/1
F1 F4

UN: R\$ 129,78 AV: R\$ 129,78 15: R\$ 132,49
30: R\$ 135,14 45: R\$ 137,84 60: R\$ 140,60



MOCHILA INF CARR PRINCE ON ICE R G3105

Código: Fábrica: Unidade:
32171 SBC UN/1
F1 F4

UN: R\$ 129,78 AV: R\$ 129,78 15: R\$ 132,49
30: R\$ 135,14 45: R\$ 137,84 60: R\$ 140,60



MOCHILA INF CARR PRINCES ON ICE G 3069

Código: Fábrica: Unidade:
32188 SBC UN/1
F1 F4

UN: R\$ 109,81 AV: R\$ 109,81 15: R\$ 112,10
30: R\$ 114,34 45: R\$ 116,63 60: R\$ 118,96



MOCHILA INF CARR PRINCES ON ICE M 3004

Código: Fábrica: Unidade:
31844 SBC UN/1
F1 F4

UN: R\$ 109,81 AV: R\$ 109,81 15: R\$ 112,10
30: R\$ 114,34 45: R\$ 116,63 60: R\$ 118,96



MOCHILA INF CARR PRINCES ON ICE M 3042

Código: Fábrica: Unidade:
31842 SBC UN/1
F1 F4

UN: R\$ 129,78 AV: R\$ 129,78 15: R\$ 132,49
30: R\$ 135,14 45: R\$ 137,84 60: R\$ 140,60



MOCHILA INF CARR PRINCES ON ICE M 3104

Código: Fábrica: Unidade:
31843 SBC UN/1
F1 F4

UN: R\$ 119,80 AV: R\$ 119,80 15: R\$ 122,29
30: R\$ 124,74 45: R\$ 127,23 60: R\$ 129,78



MOCHILA INF CARR PRINCES ON ICE P 3003

Código: Fábrica: Unidade:
32187 SBC UN/1
F1 F4

UN: R\$ 132,78 AV: R\$ 132,78 15: R\$ 135,54
30: R\$ 138,25 45: R\$ 141,02 60: R\$ 143,84



MOCHILA INF CARR PRINCESA KIT 3PC K4636

Código: Fábrica: Unidade:
49000 PONTO VERDE UN/1
F1 F4

UN: R\$ 142,76 AV: R\$ 142,76 15: R\$ 145,74
30: R\$ 148,65 45: R\$ 151,62 60: R\$ 154,66



MOCHILA INF CARR PRINCESA KIT 3PC K4637

Código: Fábrica: Unidade:
49002 PONTO VERDE UN/1
F1 F4

UN: R\$ 82,86 AV: R\$ 82,86 15: R\$ 84,58
30: R\$ 86,28 45: R\$ 88,00 60: R\$ 89,76



MOCHILA INF CARR PRINCESA M MC4634

Código: Fábrica: Unidade:
49001 PONTO VERDE UN/1
F1 F4

UN: R\$ 87,85 AV: R\$ 87,85 15: R\$ 89,68
30: R\$ 91,47 45: R\$ 93,30 60: R\$ 95,17



MOCHILA INF CARR PRINCESA M MC4635

Código: Fábrica: Unidade:
49188 PONTO VERDE UN/1
F1 F4

UN: R\$ 89,85 AV: R\$ 89,85 15: R\$ 91,72
30: R\$ 93,55 45: R\$ 95,42 60: R\$ 97,33



MOCHILA INF CARR PRINCESA PRE MC4633

Código: Fábrica: Unidade:
49039 PONTO VERDE UN/1
F1 F4

UN: R\$ 99,83 AV: R\$ 99,83 15: R\$ 101,91
30: R\$ 103,95 45: R\$ 106,03 60: R\$ 108,15



MOCHILA INF CARR PRINCESS P 2904

Código: Fábrica: Unidade:
32186 SBC UN/1
F1 F4

UN: R\$ 99,83 AV: R\$ 99,83 15: R\$ 101,91
30: R\$ 103,95 45: R\$ 106,03 60: R\$ 108,15



MOCHILA INF CARR PRINCESS PRE 2903

Código: Fábrica: Unidade:
32325 SBC UN/1
F1 F4

UN: R\$ 129,78 AV: R\$ 129,78 15: R\$ 132,49
30: R\$ 135,14 45: R\$ 137,84 60: R\$ 140,60



MOCHILA INF CARR PRINCESS R M 3092
Código: Fábrica: Unidade:
32184 SBC UN/1
F1 F4

UN: R\$ 99,83 AV: R\$ 99,83 15: R\$ 101,91
30: R\$ 103,95 45: R\$ 106,03 60: R\$ 108,15



MOCHILA INF CARR PRINCESS REL G 2905
Código: Fábrica: Unidade:
32182 SBC UN/1
F1 F4

UN: R\$ 139,77 AV: R\$ 139,77 15: R\$ 142,68
30: R\$ 145,53 45: R\$ 148,44 60: R\$ 151,41



MOCHILA INF CARR PRINCESS REL G 3073
Código: Fábrica: Unidade:
32183 SBC UN/1
F1 F4

UN: R\$ 119,80 AV: R\$ 119,80 15: R\$ 122,29
30: R\$ 124,74 45: R\$ 127,23 60: R\$ 129,78



MOCHILA INF CARR PRINCESS REL M 3030
Código: Fábrica: Unidade:
32215 SBC UN/1
F1 F4

UN: R\$ 99,83 AV: R\$ 99,83 15: R\$ 101,91
30: R\$ 103,95 45: R\$ 106,03 60: R\$ 108,15



MOCHILA INF CARR REBEL PRINCES R M2938
Código: Fábrica: Unidade:
32192 SBC UN/1
F1 F4

UN: R\$ 109,81 AV: R\$ 109,81 15: R\$ 112,10
30: R\$ 114,34 45: R\$ 116,63 60: R\$ 118,96



MOCHILA INF CARR REBEL PRINCESS M 2939
Código: Fábrica: Unidade:
32193 SBC UN/1
F1 F4

UN: R\$ 139,77 AV: R\$ 139,77 15: R\$ 142,68
30: R\$ 145,53 45: R\$ 148,44 60: R\$ 151,41



MOCHILA INF CARR SEREIA KIT 3PC MCK4616
Código: Fábrica: Unidade:
49036 PONTO VERDE UN/1
F1 F4

UN: R\$ 158,74 AV: R\$ 158,74 15: R\$ 162,04
30: R\$ 165,28 45: R\$ 168,59 60: R\$ 171,96



MOCHILA INF CARR SPACE BOARD+LANCHE 4702
Código: Fábrica: Unidade:
46703 PONTO VERDE UN/1
F1 F4

UN: R\$ 139,77 AV: R\$ 139,77 15: R\$ 142,68
30: R\$ 145,53 45: R\$ 148,44 60: R\$ 151,41



MOCHILA INF CARR SPACE KIT 3PC MCK4705
Código: Fábrica: Unidade:
50518 PONTO VERDE UN/1
F1 F4

UN: R\$ 119,80 AV: R\$ 119,80 15: R\$ 122,29
30: R\$ 124,74 45: R\$ 127,23 60: R\$ 129,78



MOCHILA INF CARR SPEED BOY M 3010
Código: Fábrica: Unidade:
32197 SBC UN/1
F1 F4

UN: R\$ 99,83 AV: R\$ 99,83 15: R\$ 101,91
30: R\$ 103,95 45: R\$ 106,03 60: R\$ 108,15



MOCHILA INF CARR SPEED BOY PRE 2961
Código: Fábrica: Unidade:
32196 SBC UN/1
F1 F4

UN: R\$ 129,78 AV: R\$ 129,78 15: R\$ 132,49
30: R\$ 135,14 45: R\$ 137,84 60: R\$ 140,60



MOCHILA INF CARR SPEED BOY REL G 3081
Código: Fábrica: Unidade:
32109 SBC UN/1
F1 F4

UN: R\$ 129,78 AV: R\$ 129,78 15: R\$ 132,49
30: R\$ 135,14 45: R\$ 137,84 60: R\$ 140,60



MOCHILA INF CARR SPEED BOY REL G3011
Código: Fábrica: Unidade:
32200 SBC UN/1
F1 F4

UN: R\$ 119,99 AV: R\$ 119,99 15: R\$ 119,99
30: R\$ 119,99 45: R\$ 119,99 60: R\$ 119,99



MOCHILA INF CARR SPEED WEB KIT 3PC K4646
Código: Fábrica: Unidade:
49003 PONTO VERDE UN/1
F1 F4

UN: R\$ 142,76 AV: R\$ 142,76 15: R\$ 145,74
30: R\$ 148,65 45: R\$ 151,62 60: R\$ 154,66



MOCHILA INF CARR SPEED WEB KIT 3PC K4647
Código: Fábrica: Unidade:
49004 PONTO VERDE UN/1
F1 F4

UN: R\$ 209,65 AV: R\$ 209,65 15: R\$ 214,02
30: R\$ 218,30 45: R\$ 222,67 60: R\$ 227,12



MOCHILA INF CARR SPEED WEB KIT 3PC M4144
Código: Fábrica: Unidade:
44393 PONTO VERDE UN/1
F1 F4

UN: R\$ 99,83 AV: R\$ 99,83 15: R\$ 101,91
30: R\$ 103,95 45: R\$ 106,03 60: R\$ 108,15



MOCHILA INF CARR SPEED WEB M MC4140
Código: 49190 Fábrica: PONTO VERDE Unidade: UN/1
F1 F4

UN: R\$ 84,85 AV: R\$ 84,85 15: R\$ 86,62
30: R\$ 88,35 45: R\$ 90,12 60: R\$ 91,92



MOCHILA INF CARR SPEED WEB MC4645
Código: 49006 Fábrica: PONTO VERDE Unidade: UN/1
F1 F4

UN: R\$ 84,85 AV: R\$ 84,85 15: R\$ 86,62
30: R\$ 88,35 45: R\$ 90,12 60: R\$ 91,92



MOCHILA INF CARR SPEED WEB PRE MC4644
Código: 49189 Fábrica: PONTO VERDE Unidade: UN/1
F1 F4

UN: R\$ 81,86 AV: R\$ 81,86 15: R\$ 83,56
30: R\$ 85,24 45: R\$ 86,94 60: R\$ 88,68



MOCHILA INF CARR SPEED WEB PRE 4643
Código: 49005 Fábrica: PONTO VERDE Unidade: UN/1
F1 F4

UN: R\$ 119,80 AV: R\$ 119,80 15: R\$ 122,29
30: R\$ 124,74 45: R\$ 127,23 60: R\$ 129,78



MOCHILA INF CARR STAR SHOW M 3882
Código: 36040 Fábrica: SBC Unidade: UN/1
F1 F4

UN: R\$ 89,85 AV: R\$ 89,85 15: R\$ 91,72
30: R\$ 93,55 45: R\$ 95,42 60: R\$ 97,33



MOCHILA INF CARR SUPER SHIELD P MC3591
Código: 38045 Fábrica: VOZZ Unidade: UN/1
F1 F4

UN: R\$ 69,88 AV: R\$ 69,88 15: R\$ 71,33
30: R\$ 72,76 45: R\$ 74,22 60: R\$ 75,70



MOCHILA INF CARR SUPER SQUARE 22454
Código: 44749 Fábrica: WINTH Unidade: UN/1
F1 F4

UN: R\$ 119,80 AV: R\$ 119,80 15: R\$ 122,29
30: R\$ 124,74 45: R\$ 127,23 60: R\$ 129,78



MOCHILA INF CARR UNILOVERS G MC3721
Código: 38041 Fábrica: SBC Unidade: UN/1
F1 F4

UN: R\$ 289,53 AV: R\$ 289,53 15: R\$ 295,56
30: R\$ 301,47 45: R\$ 307,50 60: R\$ 313,65



MOCHILA INF CARR UNILOVERS KIT 3PC 3682
Código: 34282 Fábrica: SBC Unidade: UN/1
F1 F4

UN: R\$ 109,81 AV: R\$ 109,81 15: R\$ 112,10
30: R\$ 114,34 45: R\$ 116,63 60: R\$ 118,96



MOCHILA INF CARR UNILOVERS P 3494
Código: 34280 Fábrica: SBC Unidade: UN/1
F1 F4

UN: R\$ 99,83 AV: R\$ 99,83 15: R\$ 101,91
30: R\$ 103,95 45: R\$ 106,03 60: R\$ 108,15



MOCHILA INF CARR VALENTINA M 3167
Código: 32202 Fábrica: SBC Unidade: UN/1
F1 F4

UN: R\$ 99,83 AV: R\$ 99,83 15: R\$ 101,91
30: R\$ 103,95 45: R\$ 106,03 60: R\$ 108,15



MOCHILA INF CARR VALENTINA P 3166
Código: 31845 Fábrica: SBC Unidade: UN/1
F1 F4

UN: R\$ 289,53 AV: R\$ 289,53 15: R\$ 295,56
30: R\$ 301,47 45: R\$ 307,50 60: R\$ 313,65



MOCHILA INF CARR WONDER GIR KIT 3PC 3170
Código: 32214 Fábrica: VOZZ Unidade: UN/1
F1 F4

UN: R\$ 289,53 AV: R\$ 289,53 15: R\$ 295,56
30: R\$ 301,47 45: R\$ 307,50 60: R\$ 313,65



MOCHILA INF CARR WONDER GIRL KIT 3PC 3683
Código: 34283 Fábrica: SBC Unidade: UN/1
F1 F4

UN: R\$ 109,81 AV: R\$ 109,81 15: R\$ 112,10
30: R\$ 114,34 45: R\$ 116,63 60: R\$ 118,96



MOCHILA INF CARR X-FORCE REL M 2983
Código: 32204 Fábrica: SBC Unidade: UN/1
F1 F4

UN: R\$ 132,78 AV: R\$ 132,78 15: R\$ 135,54
30: R\$ 138,25 45: R\$ 141,02 60: R\$ 143,84



MOCHILA INF CARR 3 PRINCESA KIT 3PC 4824
Código: 49078 Fábrica: PONTO VERDE Unidade: UN/1
F1 F4

UN: R\$ 132,78 AV: R\$ 132,78 15: R\$ 135,54
30: R\$ 138,25 45: R\$ 141,02 60: R\$ 143,84



MOCHILA INF CARR 3 PRINCESA KIT 3PC 4825
Código: Fábrica: Unidade:
49077 PONTO VERDE UN/1
F1 F4

UN: R\$ 119,80 AV: R\$ 119,80 15: R\$ 122,29
30: R\$ 124,74 45: R\$ 127,23 60: R\$ 129,78



MOCHILA INF C/CARR AIR JUMPER R G MC3745
Código: Fábrica: Unidade:
38037 SBC UN/1
F1 F4

UN: R\$ 129,78 AV: R\$ 129,78 15: R\$ 132,49
30: R\$ 135,14 45: R\$ 137,84 60: R\$ 140,60



MOCHILA INF C/CARR AMANDA REL G 2189
Código: Fábrica: Unidade:
29627 SBC UN/1
F1 F4

UN: R\$ 63,90 AV: R\$ 63,90 15: R\$ 65,23
30: R\$ 66,53 45: R\$ 67,86 60: R\$ 69,22



MOCHILA INF C/CARR BEAUTY FREAKY 194
Código: Fábrica: Unidade:
27800 SBC UN/1
F1 F4

UN: R\$ 119,80 AV: R\$ 119,80 15: R\$ 122,29
30: R\$ 124,74 45: R\$ 127,23 60: R\$ 129,78



MOCHILA INF C/CARR BEST FRIEND G MC3668
Código: Fábrica: Unidade:
38058 SBC UN/1
F1 F4

UN: R\$ 109,81 AV: R\$ 109,81 15: R\$ 112,10
30: R\$ 114,34 45: R\$ 116,63 60: R\$ 118,96



MOCHILA INF C/CARR BLOCK GAME P 3626
Código: Fábrica: Unidade:
34258 SBC UN/1
F1 F4

UN: R\$ 109,81 AV: R\$ 109,81 15: R\$ 112,10
30: R\$ 114,34 45: R\$ 116,63 60: R\$ 118,96



MOCHILA INF C/CARR BROKEBONES R PRE 3017
Código: Fábrica: Unidade:
32157 SBC UN/1
F1 F4

UN: R\$ 129,78 AV: R\$ 129,78 15: R\$ 132,49
30: R\$ 135,14 45: R\$ 137,84 60: R\$ 140,60



MOCHILA INF C/CARR BROKEBONES REL P 3122
Código: Fábrica: Unidade:
32107 SBC UN/1
F1 F4

UN: R\$ 99,83 AV: R\$ 99,83 15: R\$ 101,91
30: R\$ 103,95 45: R\$ 106,03 60: R\$ 108,15



MOCHILA INF C/CARR CALIFORNIA GIRL 2947
Código: Fábrica: Unidade:
32164 SBC UN/1
F1 F4

UN: R\$ 129,78 AV: R\$ 129,78 15: R\$ 132,49
30: R\$ 135,14 45: R\$ 137,84 60: R\$ 140,60



MOCHILA INF C/CARR CALIFORNIA GIRL G3025
Código: Fábrica: Unidade:
32161 SBC UN/1
F1 F4

UN: R\$ 129,78 AV: R\$ 129,78 15: R\$ 132,49
30: R\$ 135,14 45: R\$ 137,84 60: R\$ 140,60



MOCHILA INF C/CARR CALIFORNIA GIRL G3196
Código: Fábrica: Unidade:
32162 SBC UN/1
F1 F4

UN: R\$ 99,83 AV: R\$ 99,83 15: R\$ 101,91
30: R\$ 103,95 45: R\$ 106,03 60: R\$ 108,15



MOCHILA INF C/CARR CALIFORNIA GIRL M2946
Código: Fábrica: Unidade:
32160 SBC UN/1
F1 F4

UN: R\$ 109,81 AV: R\$ 109,81 15: R\$ 112,10
30: R\$ 114,34 45: R\$ 116,63 60: R\$ 118,96



MOCHILA INF C/CARR CALIFORNIA GIRL M3024
Código: Fábrica: Unidade:
32165 SBC UN/1
F1 F4

UN: R\$ 119,80 AV: R\$ 119,80 15: R\$ 122,29
30: R\$ 124,74 45: R\$ 127,23 60: R\$ 129,78



MOCHILA INF C/CARR CALIFORNIA GIRL M3195
Código: Fábrica: Unidade:
32163 SBC UN/1
F1 F4

UN: R\$ 119,80 AV: R\$ 119,80 15: R\$ 122,29
30: R\$ 124,74 45: R\$ 127,23 60: R\$ 129,78



MOCHILA INF C/CARR DOLL M MC3919
Código: Fábrica: Unidade:
36214 SBC UN/1
F1 F4

UN: R\$ 109,81 AV: R\$ 109,81 15: R\$ 112,10
30: R\$ 114,34 45: R\$ 116,63 60: R\$ 118,96



MOCHILA INF C/CARR HOOZ P 3634
Código: Fábrica: Unidade:
34271 SBC UN/1
F1 F4

UN: R\$ 139,77 AV: R\$ 139,77 15: R\$ 142,68
30: R\$ 145,53 45: R\$ 148,44 60: R\$ 151,41



MOCHILA INF C/CARR LITTLE PRINCESS P3641
Código: Fábrica: Unidade:
34274 SBC UN/1
F1 F4

UN: R\$ 109,81 AV: R\$ 109,81 15: R\$ 112,10
30: R\$ 114,34 45: R\$ 116,63 60: R\$ 118,96



MOCHILA INF C/CARR LOVE FASHION P 3514
Código: Fábrica: Unidade:
34276 SBC UN/1
F1 F4

UN: R\$ 99,83 AV: R\$ 99,83 15: R\$ 101,91
30: R\$ 103,95 45: R\$ 106,03 60: R\$ 108,15



MOCHILA INF C/CARR MAGICAL P MC2918
Código: Fábrica: Unidade:
32176 SBC UN/1
F1 F4

UN: R\$ 99,83 AV: R\$ 99,83 15: R\$ 101,91
30: R\$ 103,95 45: R\$ 106,03 60: R\$ 108,15



MOCHILA INF C/CARR MY PRINCES P MC3522
Código: Fábrica: Unidade:
40059 VOZZ UN/1
F1 F4

UN: R\$ 99,83 AV: R\$ 99,83 15: R\$ 101,91
30: R\$ 103,95 45: R\$ 106,03 60: R\$ 108,15



MOCHILA INF C/CARR MY PRINCESS P MC3543
Código: Fábrica: Unidade:
40055 SBC UN/1
F1 F4

UN: R\$ 119,80 AV: R\$ 119,80 15: R\$ 122,29
30: R\$ 124,74 45: R\$ 127,23 60: R\$ 129,78



MOCHILA INF C/CARR PEQUENA PRINCE R G3143
Código: Fábrica: Unidade:
32154 SBC UN/1
F1 F4

UN: R\$ 99,83 AV: R\$ 99,83 15: R\$ 101,91
30: R\$ 103,95 45: R\$ 106,03 60: R\$ 108,15



MOCHILA INF C/CARR PEQUENA PRINCE M 2913
Código: Fábrica: Unidade:
32338 SBC UN/1
F1 F4

UN: R\$ 99,83 AV: R\$ 99,83 15: R\$ 101,91
30: R\$ 103,95 45: R\$ 106,03 60: R\$ 108,15



MOCHILA INF C/CARR PEQUENA PRINCE P 2912
Código: Fábrica: Unidade:
32326 SBC UN/1
F1 F4

UN: R\$ 109,81 AV: R\$ 109,81 15: R\$ 112,10
30: R\$ 114,34 45: R\$ 116,63 60: R\$ 118,96



MOCHILA INF C/CARR PEQUENA PRINCE P 3036
Código: Fábrica: Unidade:
32305 SBC UN/1
F1 F4

UN: R\$ 109,81 AV: R\$ 109,81 15: R\$ 112,10
30: R\$ 114,34 45: R\$ 116,63 60: R\$ 118,96



MOCHILA INF C/CARR PEQUENA PRINCE P 3142
Código: Fábrica: Unidade:
31836 SBC UN/1
F1 F4

UN: R\$ 109,81 AV: R\$ 109,81 15: R\$ 112,10
30: R\$ 114,34 45: R\$ 116,63 60: R\$ 118,96



MOCHILA INF C/CARR PEQUENA PRINCESA 3523
Código: Fábrica: Unidade:
34255 SBC UN/1
F1 F4

UN: R\$ 129,78 AV: R\$ 129,78 15: R\$ 132,49
30: R\$ 135,14 45: R\$ 137,84 60: R\$ 140,60



MOCHILA INF C/CARR PET PRINCE R P 3086
Código: Fábrica: Unidade:
32181 SBC UN/1
F1 F4

UN: R\$ 99,83 AV: R\$ 99,83 15: R\$ 101,91
30: R\$ 103,95 45: R\$ 106,03 60: R\$ 108,15



MOCHILA INF C/CARR PET PRINCESS P 2932
Código: Fábrica: Unidade:
32168 SBC UN/1
F1 F4

UN: R\$ 99,83 AV: R\$ 99,83 15: R\$ 101,91
30: R\$ 103,95 45: R\$ 106,03 60: R\$ 108,15



MOCHILA INF C/CARR PET PRINCESS M MC2933
Código: Fábrica: Unidade:
32169 SBC UN/1
F1 F4

UN: R\$ 129,78 AV: R\$ 129,78 15: R\$ 132,49
30: R\$ 135,14 45: R\$ 137,84 60: R\$ 140,60



MOCHILA INF C/CARR PET PRINCESS R M 3087
Código: Fábrica: Unidade:
32178 SBC UN/1
F1 F4

UN: R\$ 89,85 AV: R\$ 89,85 15: R\$ 91,72
30: R\$ 93,55 45: R\$ 95,42 60: R\$ 97,33



MOCHILA INF C/CARR PIGGY BOY G 2051
Código: Fábrica: Unidade:
29686 SBC UN/1
F1 F4

UN: R\$ 109,81 AV: R\$ 109,81 15: R\$ 112,10
30: R\$ 114,34 45: R\$ 116,63 60: R\$ 118,96



MOCHILA INF C/CARR PIGGY BOY M 2432

Código: Fábrica: Unidade:
29654 SBC UN/1
F1 F4

UN: R\$ 89,85 AV: R\$ 89,85 15: R\$ 91,72
30: R\$ 93,55 45: R\$ 95,42 60: R\$ 97,33



MOCHILA INF C/CARR PIGGY BOY P 2050

Código: Fábrica: Unidade:
29685 SBC UN/1
F1 F4

UN: R\$ 64,89 AV: R\$ 64,89 15: R\$ 66,24
30: R\$ 67,56 45: R\$ 68,91 60: R\$ 70,29



MOCHILA INF CRYSTAL PRINCESS REL M 2720

Código: Fábrica: Unidade:
30552 SBC UN/1
F1 F4

UN: R\$ 64,89 AV: R\$ 64,89 15: R\$ 66,24
30: R\$ 67,56 45: R\$ 68,91 60: R\$ 70,29



MOCHILA INF CRYSTAL PRINCESS REL M 2768

Código: Fábrica: Unidade:
31312 SBC UN/1
F1 F4

UN: R\$ 47,91 AV: R\$ 47,91 15: R\$ 48,91
30: R\$ 49,89 45: R\$ 50,89 60: R\$ 51,91



MOCHILA INF DOLL P 3915

Código: Fábrica: Unidade:
36038 SBC UN/1
F1 F4

UN: R\$ 59,89 AV: R\$ 59,89 15: R\$ 61,14
30: R\$ 62,36 45: R\$ 63,61 60: R\$ 64,88



MOCHILA INF DOLL PRE 3914

Código: Fábrica: Unidade:
35975 SBC UN/1
F1 F4

UN: R\$ 45,92 AV: R\$ 45,92 15: R\$ 46,87
30: R\$ 47,81 45: R\$ 48,77 60: R\$ 49,74



MOCHILA INF FEM BEE FRIENDS PRE M4800

Código: Fábrica: Unidade:
49087 PONTO VERDE UN/1
F1 F4

UN: R\$ 47,91 AV: R\$ 47,91 15: R\$ 48,91
30: R\$ 49,89 45: R\$ 50,89 60: R\$ 51,91



MOCHILA INF FEM BEE FRINDES G M4801

Código: Fábrica: Unidade:
49088 PONTO VERDE UN/1
F1 F4

UN: R\$ 59,89 AV: R\$ 59,89 15: R\$ 61,14
30: R\$ 62,36 45: R\$ 63,61 60: R\$ 64,88



MOCHILA INF FEM BRANCA DE NEVE G M4622

Código: Fábrica: Unidade:
49044 PONTO VERDE UN/1
F1 F4

UN: R\$ 54,90 AV: R\$ 54,90 15: R\$ 56,05
30: R\$ 57,17 45: R\$ 58,31 60: R\$ 59,48



MOCHILA INF FEM BRANCA DE NEVE M M4621

Código: Fábrica: Unidade:
49043 PONTO VERDE UN/1
F1 F4

UN: R\$ 132,78 AV: R\$ 132,78 15: R\$ 135,54
30: R\$ 138,25 45: R\$ 141,02 60: R\$ 143,84



MOCHILA INF FEM CARR SEREIA KIT 3PC 4808

Código: Fábrica: Unidade:
49082 PONTO VERDE UN/1
F1 F4

UN: R\$ 79,86 AV: R\$ 79,86 15: R\$ 81,53
30: R\$ 83,16 45: R\$ 84,82 60: R\$ 86,52



MOCHILA INF FEM EVA HIHIHI 3D G M4924

Código: Fábrica: Unidade:
49050 PONTO VERDE UN/1
F1 F4

UN: R\$ 79,86 AV: R\$ 79,86 15: R\$ 81,53
30: R\$ 83,16 45: R\$ 84,82 60: R\$ 86,52



MOCHILA INF FEM EVA PRINCESS 3D G M5038

Código: Fábrica: Unidade:
49049 PONTO VERDE UN/1
F1 F4

UN: R\$ 74,87 AV: R\$ 74,87 15: R\$ 76,43
30: R\$ 77,96 45: R\$ 79,52 60: R\$ 81,11



MOCHILA INF FEM EVA 3D G M4920

Código: Fábrica: Unidade:
49053 PONTO VERDE UN/1
F1 F4

UN: R\$ 49,91 AV: R\$ 49,91 15: R\$ 50,95
30: R\$ 51,97 45: R\$ 53,01 60: R\$ 54,07



MOCHILA INF FEM FREAKY G M4812

Código: Fábrica: Unidade:
49091 PONTO VERDE UN/1
F1 F4

UN: R\$ 86,85 AV: R\$ 86,85 15: R\$ 88,66
30: R\$ 90,43 45: R\$ 92,24 60: R\$ 94,09



MOCHILA INF FEM M4324

Código: Fábrica: Unidade:
44057 PONTO VERDE UN/1
F1 F4

UN: R\$ 47,91 AV: R\$ 47,91 15: R\$ 48,91
30: R\$ 49,89 45: R\$ 50,89 60: R\$ 51,91



MOCHILA INF FEM RAYBOW G M4959

Código: 49095 Fábrica: PONTO VERDE Unidade: UN/1 F1 F4

UN: R\$ 47,91 AV: R\$ 47,91 15: R\$ 48,91
30: R\$ 49,89 45: R\$ 50,89 60: R\$ 51,91



MOCHILA INF FEM SEREIA G M4807

Código: 49097 Fábrica: PONTO VERDE Unidade: UN/1 F1 F4

UN: R\$ 49,91 AV: R\$ 49,91 15: R\$ 50,95
30: R\$ 51,97 45: R\$ 53,01 60: R\$ 54,07



MOCHILA INF FEM SEREIA PRE M4610

Código: 49061 Fábrica: PONTO VERDE Unidade: UN/1 F1 F4

UN: R\$ 44,92 AV: R\$ 44,92 15: R\$ 45,85
30: R\$ 46,77 45: R\$ 47,71 60: R\$ 48,66



MOCHILA INF FEM SEREIA PRE M4806

Código: 49096 Fábrica: PONTO VERDE Unidade: UN/1 F1 F4

UN: R\$ 49,91 AV: R\$ 49,91 15: R\$ 50,95
30: R\$ 51,97 45: R\$ 53,01 60: R\$ 54,07



MOCHILA INF FEM TWICE PRE M4118

Código: 49193 Fábrica: PONTO VERDE Unidade: UN/1 F1 F4

UN: R\$ 47,91 AV: R\$ 47,91 15: R\$ 48,91
30: R\$ 49,89 45: R\$ 50,89 60: R\$ 51,91



MOCHILA INF FEM 3 PRINCESAS M4823

Código: 49083 Fábrica: PONTO VERDE Unidade: UN/1 F1 F4

UN: R\$ 45,92 AV: R\$ 45,92 15: R\$ 46,87
30: R\$ 47,81 45: R\$ 48,77 60: R\$ 49,74



MOCHILA INF FEM 3 PRINCESAS PRE M4822

Código: 49084 Fábrica: PONTO VERDE Unidade: UN/1 F1 F4

UN: R\$ 49,91 AV: R\$ 49,91 15: R\$ 50,95
30: R\$ 51,97 45: R\$ 53,01 60: R\$ 54,07



MOCHILA INF GALAXY GIRL G M3554

Código: 38042 Fábrica: VOZZ Unidade: UN/1 F1 F4

UN: R\$ 46,91 AV: R\$ 46,91 15: R\$ 47,89
30: R\$ 48,85 45: R\$ 49,83 60: R\$ 50,82



MOCHILA INF KIDS PLAY G M4817

Código: 49094 Fábrica: PONTO VERDE Unidade: UN/1 F1 F4

UN: R\$ 59,89 AV: R\$ 59,89 15: R\$ 61,14
30: R\$ 62,36 45: R\$ 63,61 60: R\$ 64,88



MOCHILA INF LINHA BABY GATINHA M M4713

Código: 49192 Fábrica: PONTO VERDE Unidade: UN/1 F1 F4

UN: R\$ 94,84 AV: R\$ 94,84 15: R\$ 96,81
30: R\$ 98,75 45: R\$ 100,73 60: R\$ 102,74



MOCHILA INF LINHA BABY NARUT M4722

Código: 46707 Fábrica: PONTO VERDE Unidade: UN/1 F1 F4

UN: R\$ 79,86 AV: R\$ 79,86 15: R\$ 81,53
30: R\$ 83,16 45: R\$ 84,82 60: R\$ 86,52



MOCHILA INF LINHA BABY PRINCESS M4716

Código: 46705 Fábrica: PONTO VERDE Unidade: UN/1 F1 F4

UN: R\$ 50,91 AV: R\$ 50,91 15: R\$ 51,97
30: R\$ 53,01 45: R\$ 54,07 60: R\$ 55,15



MOCHILA INF LINHA BABY SETINADO POA 4719

Código: 49055 Fábrica: PONTO VERDE Unidade: UN/1 F1 F4

UN: R\$ 70,88 AV: R\$ 70,88 15: R\$ 72,35
30: R\$ 73,80 45: R\$ 75,28 60: R\$ 76,78



MOCHILA INF LINHA BABY SPEED WEB M4725

Código: 46706 Fábrica: PONTO VERDE Unidade: UN/1 F1 F4

UN: R\$ 42,92 AV: R\$ 42,92 15: R\$ 43,82
30: R\$ 44,69 45: R\$ 45,59 60: R\$ 46,50



MOCHILA INF LO SURPRISES REL BRILHO P 1226

Código: 35825 Fábrica: BRASILIMPORT Unidade: UN/1 F1 F4

UN: R\$ 45,92 AV: R\$ 45,92 15: R\$ 46,87
30: R\$ 47,81 45: R\$ 48,77 60: R\$ 49,74



MOCHILA INF MASC BATTLE PRE M4844

Código: 49086 Fábrica: PONTO VERDE Unidade: UN/1 F1 F4

UN: R\$ 47,91 AV: R\$ 47,91 15: R\$ 48,91
30: R\$ 49,89 45: R\$ 50,89 60: R\$ 51,91



MOCHILA INF MASC BLOOK GAME G M4850
Código: Fábrica: Unidade:
49089 PONTO VERDE UN/1
F1 F4

UN: R\$ 139,77 AV: R\$ 139,77 15: R\$ 142,68
30: R\$ 145,53 45: R\$ 148,44 60: R\$ 151,41



MOCHILA INF MASC CARR SPACE KIT 3PC 4865
Código: Fábrica: Unidade:
49037 PONTO VERDE UN/1
F1 F4

UN: R\$ 89,85 AV: R\$ 89,85 15: R\$ 91,72
30: R\$ 93,55 45: R\$ 95,42 60: R\$ 97,33



MOCHILA INF MASC EVA ARANHA 3D G M4892
Código: Fábrica: Unidade:
49045 PONTO VERDE UN/1
F1 F4

UN: R\$ 79,86 AV: R\$ 79,86 15: R\$ 81,53
30: R\$ 83,16 45: R\$ 84,82 60: R\$ 86,52



MOCHILA INF MASC EVA ARANHA 3D G M4916
Código: Fábrica: Unidade:
49048 PONTO VERDE UN/1
F1 F4

UN: R\$ 82,86 AV: R\$ 82,86 15: R\$ 84,58
30: R\$ 86,28 45: R\$ 88,00 60: R\$ 89,76



MOCHILA INF MASC EVA ESTRELA 3D G M4900
Código: Fábrica: Unidade:
49046 PONTO VERDE UN/1
F1 F4

UN: R\$ 75,87 AV: R\$ 75,87 15: R\$ 77,45
30: R\$ 79,00 45: R\$ 80,58 60: R\$ 82,19



MOCHILA INF MASC EVA KARS KIDS 3D M4514
Código: Fábrica: Unidade:
49215 PONTO VERDE UN/1
F1 F4

UN: R\$ 82,86 AV: R\$ 82,86 15: R\$ 84,58
30: R\$ 86,28 45: R\$ 88,00 60: R\$ 89,76



MOCHILA INF MASC EVA MORCEGO 3D G M4896
Código: Fábrica: Unidade:
49047 PONTO VERDE UN/1
F1 F4

UN: R\$ 74,87 AV: R\$ 74,87 15: R\$ 76,43
30: R\$ 77,96 45: R\$ 79,52 60: R\$ 81,11



MOCHILA INF MASC EVA SUPER RACE 3D M4908
Código: Fábrica: Unidade:
49054 PONTO VERDE UN/1
F1 F4

UN: R\$ 74,87 AV: R\$ 74,87 15: R\$ 76,43
30: R\$ 77,96 45: R\$ 79,52 60: R\$ 81,11



MOCHILA INF MASC EVA 3D M4904
Código: Fábrica: Unidade:
49052 PONTO VERDE UN/1
F1 F4

UN: R\$ 49,91 AV: R\$ 49,91 15: R\$ 50,95
30: R\$ 51,97 45: R\$ 53,01 60: R\$ 54,07



MOCHILA INF MASC GAME WORLD M4829
Código: Fábrica: Unidade:
49092 PONTO VERDE UN/1
F1 F4

UN: R\$ 59,89 AV: R\$ 59,89 15: R\$ 61,14
30: R\$ 62,36 45: R\$ 63,61 60: R\$ 64,88



MOCHILA INF MASC GUARDIAN NIGHT PRE 4172
Código: Fábrica: Unidade:
44395 PONTO VERDE UN/1
F1 F4

UN: R\$ 47,91 AV: R\$ 47,91 15: R\$ 48,91
30: R\$ 49,89 45: R\$ 50,89 60: R\$ 51,91



MOCHILA INF MASC JUNGLE HUNTERS G M4834
Código: Fábrica: Unidade:
49090 PONTO VERDE UN/1
F1 F4

UN: R\$ 50,91 AV: R\$ 50,91 15: R\$ 51,97
30: R\$ 53,01 45: R\$ 54,07 60: R\$ 55,15



MOCHILA INF MASC SPACE G M4864
Código: Fábrica: Unidade:
49062 PONTO VERDE UN/1
F1 F4

UN: R\$ 49,91 AV: R\$ 49,91 15: R\$ 50,95
30: R\$ 51,97 45: R\$ 53,01 60: R\$ 54,07



MOCHILA INF MASC STATION DOG M4839
Código: Fábrica: Unidade:
49098 PONTO VERDE UN/1
F1 F4

UN: R\$ 43,86 AV: R\$ 43,86 15: R\$ 44,77
30: R\$ 45,67 45: R\$ 46,58 60: R\$ 47,51



MOCHILA INF NINJA G M4682
Código: Fábrica: Unidade:
49022 PONTO VERDE UN/1
F1 F4

UN: R\$ 69,88 AV: R\$ 69,88 15: R\$ 71,33
30: R\$ 72,76 45: R\$ 74,22 60: R\$ 75,70



MOCHILA INF PET PRINCESS REL P 3084
Código: Fábrica: Unidade:
32242 SBC UN/1
F1 F4

UN: R\$ 65,89 AV: R\$ 65,89 15: R\$ 67,27
30: R\$ 68,61 45: R\$ 69,98 60: R\$ 71,38



MOCHILA INF PIGGY G 2399

Código: 29523 Fábrica: SBC Unidade: UN/1 F1 F4

UN: R\$ 66,04 AV: R\$ 66,04 15: R\$ 67,42
30: R\$ 68,77 45: R\$ 70,14 60: R\$ 71,55



MOCHILA INF PIGGY BOY RELEVO G 2431

Código: 29608 Fábrica: SBC Unidade: UN/1 F1 F4

UN: R\$ 49,91 AV: R\$ 49,91 15: R\$ 50,95
30: R\$ 51,97 45: R\$ 53,01 60: R\$ 54,07



MOCHILA INF PIGGY G 2001

Código: 29622 Fábrica: SBC Unidade: UN/1 F1 F4

UN: R\$ 39,44 AV: R\$ 39,44 15: R\$ 40,26
30: R\$ 41,06 45: R\$ 41,88 60: R\$ 42,72



MOCHILA INF PIGGY P 2000

Código: 29667 Fábrica: VOZZ Unidade: UN/1 F1 F4

UN: R\$ 63,90 AV: R\$ 63,90 15: R\$ 65,23
30: R\$ 66,53 45: R\$ 67,86 60: R\$ 69,22



MOCHILA INF PIGGY RELEVO P 2398

Código: 29606 Fábrica: SBC Unidade: UN/1 F1 F4

UN: R\$ 50,91 AV: R\$ 50,91 15: R\$ 51,97
30: R\$ 53,01 45: R\$ 54,07 60: R\$ 55,15



MOCHILA INF PRINCESA G M4632

Código: 49057 Fábrica: PONTO VERDE Unidade: UN/1 F1 F4

UN: R\$ 59,89 AV: R\$ 59,89 15: R\$ 61,14
30: R\$ 62,36 45: R\$ 63,61 60: R\$ 64,88



MOCHILA INF PRINCESS G 2666

Código: 31344 Fábrica: SBC Unidade: UN/1 F1 F4

UN: R\$ 69,88 AV: R\$ 69,88 15: R\$ 71,33
30: R\$ 72,76 45: R\$ 74,22 60: R\$ 75,70



MOCHILA INF PRINCESS ON ICE REL M 3103

Código: 31859 Fábrica: SBC Unidade: UN/1 F1 F4

UN: R\$ 59,89 AV: R\$ 59,89 15: R\$ 61,14
30: R\$ 62,36 45: R\$ 63,61 60: R\$ 64,88



MOCHILA INF PRINCESS ON ICE P 2509

Código: 30735 Fábrica: SBC Unidade: UN/1 F1 F4

UN: R\$ 64,89 AV: R\$ 64,89 15: R\$ 66,24
30: R\$ 67,56 45: R\$ 68,91 60: R\$ 70,29



MOCHILA INF PRINCESS ON ICE P 2594

Código: 30761 Fábrica: SBC Unidade: UN/1 F1 F4

UN: R\$ 69,88 AV: R\$ 69,88 15: R\$ 71,33
30: R\$ 72,76 45: R\$ 74,22 60: R\$ 75,70



MOCHILA INF PRINCESS ON ICE P 3001

Código: 31860 Fábrica: SBC Unidade: UN/1 F1 F4

UN: R\$ 69,88 AV: R\$ 69,88 15: R\$ 71,33
30: R\$ 72,76 45: R\$ 74,22 60: R\$ 75,70



MOCHILA INF PRINCESS ON ICE P 3102

Código: 31857 Fábrica: SBC Unidade: UN/1 F1 F4

UN: R\$ 64,89 AV: R\$ 64,89 15: R\$ 66,24
30: R\$ 67,56 45: R\$ 68,91 60: R\$ 70,29



MOCHILA INF PRINCESS ON ICE REL G 2674

Código: 30740 Fábrica: SBC Unidade: UN/1 F1 F4

UN: R\$ 69,88 AV: R\$ 69,88 15: R\$ 71,33
30: R\$ 72,76 45: R\$ 74,22 60: R\$ 75,70



MOCHILA INF PRINCESS ON ICE REL M 2763

Código: 31313 Fábrica: SBC Unidade: UN/1 F1 F4

UN: R\$ 69,88 AV: R\$ 69,88 15: R\$ 71,33
30: R\$ 72,76 45: R\$ 74,22 60: R\$ 75,70



MOCHILA INF PRINCESS ON ICE REL M 3068

Código: 32244 Fábrica: SBC Unidade: UN/1 F1 F4

UN: R\$ 54,90 AV: R\$ 54,90 15: R\$ 56,05
30: R\$ 57,17 45: R\$ 58,31 60: R\$ 59,48



MOCHILA INF PRINCESS P 2901

Código: 32240 Fábrica: SBC Unidade: UN/1 F1 F4

UN: R\$ 42,92 AV: R\$ 42,92 15: R\$ 43,82
30: R\$ 44,69 45: R\$ 45,59 60: R\$ 46,50



MOCHILA INF PRINCESS REL BRILHO P 1226

Código: Fábrika: Unidade:
35823 BRASILIMPORT UN/1
F1 F4

UN: R\$ 63,90 AV: R\$ 63,90 15: R\$ 65,23
30: R\$ 66,53 45: R\$ 67,86 60: R\$ 69,22



MOCHILA INF PRINCESS REL G 3072

Código: Fábrika: Unidade:
32254 SBC UN/1
F1 F4

UN: R\$ 69,88 AV: R\$ 69,88 15: R\$ 71,33
30: R\$ 72,76 45: R\$ 74,22 60: R\$ 75,70



MOCHILA INF PRINCESS REL M 3029

Código: Fábrika: Unidade:
31924 SBC UN/1
F1 F4

UN: R\$ 69,88 AV: R\$ 69,88 15: R\$ 71,33
30: R\$ 72,76 45: R\$ 74,22 60: R\$ 75,70



MOCHILA INF PRINCESS REL M 3091

Código: Fábrika: Unidade:
32255 SBC UN/1
F1 F4

UN: R\$ 64,89 AV: R\$ 64,89 15: R\$ 66,24
30: R\$ 67,56 45: R\$ 68,91 60: R\$ 70,29



MOCHILA INF PRINCESS REL P 3028

Código: Fábrika: Unidade:
31923 SBC UN/1
F1 F4

UN: R\$ 59,89 AV: R\$ 59,89 15: R\$ 61,14
30: R\$ 62,36 45: R\$ 63,61 60: R\$ 64,88



MOCHILA INF REBEL PRINCES REL G 2670

Código: Fábrika: Unidade:
31315 SBC UN/1
F1 F4

UN: R\$ 50,91 AV: R\$ 50,91 15: R\$ 51,97
30: R\$ 53,01 45: R\$ 54,07 60: R\$ 55,15



MOCHILA INF SEREIA G M4612

Código: Fábrika: Unidade:
49059 PONTO VERDE UN/1
F1 F4

UN: R\$ 49,91 AV: R\$ 49,91 15: R\$ 50,95
30: R\$ 51,97 45: R\$ 53,01 60: R\$ 54,07



MOCHILA INF SEREIA P M4611

Código: Fábrika: Unidade:
49060 PONTO VERDE UN/1
F1 F4

UN: R\$ 42,92 AV: R\$ 42,92 15: R\$ 43,82
30: R\$ 44,69 45: R\$ 45,59 60: R\$ 46,50



MOCHILA INF SOFI REL BRILHO P 1226

Código: Fábrika: Unidade:
35826 BRASILIMPORT UN/1
F1 F4

UN: R\$ 69,88 AV: R\$ 69,88 15: R\$ 71,33
30: R\$ 72,76 45: R\$ 74,22 60: R\$ 75,70



MOCHILA INF SOPHIA REL P 2624

Código: Fábrika: Unidade:
30748 SBC UN/1
F1 F4

UN: R\$ 49,91 AV: R\$ 49,91 15: R\$ 50,95
30: R\$ 51,97 45: R\$ 53,01 60: R\$ 54,07



MOCHILA INF SPEED BOY 2 M3598

Código: Fábrika: Unidade:
38055 SBC UN/1
F1 F4

UN: R\$ 62,00 AV: R\$ 62,00 15: R\$ 63,29
30: R\$ 64,56 45: R\$ 65,85 60: R\$ 67,17



MOCHILA INF SPEED WEB G M4642

Código: Fábrika: Unidade:
49025 PONTO VERDE UN/1
F1 F4

UN: R\$ 45,92 AV: R\$ 45,92 15: R\$ 46,87
30: R\$ 47,81 45: R\$ 48,77 60: R\$ 49,74



MOCHILA INF SPEED WEB P M4641

Código: Fábrika: Unidade:
49023 PONTO VERDE UN/1
F1 F4

UN: R\$ 42,92 AV: R\$ 42,92 15: R\$ 43,82
30: R\$ 44,69 45: R\$ 45,59 60: R\$ 46,50



MOCHILA INF SPEED WEB PRE M4640

Código: Fábrika: Unidade:
49024 PONTO VERDE UN/1
F1 F4

UN: R\$ 59,89 AV: R\$ 59,89 15: R\$ 61,14
30: R\$ 62,36 45: R\$ 63,61 60: R\$ 64,88



MOCHILA INF STAR SHOW M 3879

Código: Fábrika: Unidade:
36099 SBC UN/1
F1 F4

UN: R\$ 54,90 AV: R\$ 54,90 15: R\$ 56,05
30: R\$ 57,17 45: R\$ 58,31 60: R\$ 59,48



MOCHILA INF STAR SHOW P M3878

Código: Fábrika: Unidade:
36100 SBC UN/1
F1 F4

UN: R\$ 54,90 AV: R\$ 54,90 15: R\$ 56,05
30: R\$ 57,17 45: R\$ 58,31 60: R\$ 59,48



MOCHILA INF STAR SHOW PP 3877

Código: Fábrica: Unidade:
36035 SBC UN/1
F1 F4

UN: R\$ 49,91 AV: R\$ 49,91 15: R\$ 50,95
30: R\$ 51,97 45: R\$ 53,01 60: R\$ 54,07



MOCHILA INF SUPER CATHIE P M3547

Código: Fábrica: Unidade:
38011 VOZZ UN/1
F1 F4

UN: R\$ 54,90 AV: R\$ 54,90 15: R\$ 56,05
30: R\$ 57,17 45: R\$ 58,31 60: R\$ 59,48



MOCHILA INF UNILOVERS M M3719

Código: Fábrica: Unidade:
38050 VOZZ UN/1
F1 F4

UN: R\$ 54,90 AV: R\$ 54,90 15: R\$ 56,05
30: R\$ 57,17 45: R\$ 58,31 60: R\$ 59,48



MOCHILA INF UNILOVERS P M3718

Código: Fábrica: Unidade:
34174 SBC UN/1
F1 F4

UN: R\$ 59,89 AV: R\$ 59,89 15: R\$ 61,14
30: R\$ 62,36 45: R\$ 63,61 60: R\$ 64,88



MOCHILA JEANS EST 3 DIV DETAL CORCOVA 326

Código: Fábrica: Unidade:
31679 LITA UN/1
F1 F4

UN: R\$ 54,90 AV: R\$ 54,90 15: R\$ 56,05
30: R\$ 57,17 45: R\$ 58,31 60: R\$ 59,48



MOCHILA JEANS ESTAMPADO FORRO DUPLO 320

Código: Fábrica: Unidade:
28776 LITA UN/1
F1 F4

UN: R\$ 31,94 AV: R\$ 31,94 15: R\$ 32,60
30: R\$ 33,26 45: R\$ 33,92 60: R\$ 34,60



MOCHILA JEANS S/LAVAR AZUL 321

Código: Fábrica: Unidade:
14628 LITA UN/1
F1 F4

UN: R\$ 29,94 AV: R\$ 29,94 15: R\$ 30,57
30: R\$ 31,18 45: R\$ 31,80 60: R\$ 32,44



MOCHILA JEANS S/LAVAR PRETA 332

Código: Fábrica: Unidade:
48455 LITA UN/1
F1 F4

UN: R\$ 249,59 AV: R\$ 249,59 15: R\$ 254,79
30: R\$ 259,89 45: R\$ 265,08 60: R\$ 270,39



MOCHILA JUV CARR KIT 3PCS MCK 3962

Código: Fábrica: Unidade:
41432 SBC CJ/1
F1 F4

UN: R\$ 119,80 AV: R\$ 119,80 15: R\$ 122,29
30: R\$ 124,74 45: R\$ 127,23 60: R\$ 129,78



MOCHILA JUV C/CARR FEM VIKING MC3983

Código: Fábrica: Unidade:
41426 SBC UN/1
F1 F4

UN: R\$ 111,81 AV: R\$ 111,81 15: R\$ 114,14
30: R\$ 116,42 45: R\$ 118,75 60: R\$ 121,13



MOCHILA JUV FEM POLIESTER MORMAII 0116

Código: Fábrica: Unidade:
44032 MORMAII UN/1
F1 F4

UN: R\$ 111,81 AV: R\$ 111,81 15: R\$ 114,14
30: R\$ 116,42 45: R\$ 118,75 60: R\$ 121,13



MOCHILA JUV FEM POLIESTER MORMAII 0119

Código: Fábrica: Unidade:
44033 MORMAII UN/1
F1 F4

UN: R\$ 111,81 AV: R\$ 111,81 15: R\$ 114,14
30: R\$ 116,42 45: R\$ 118,75 60: R\$ 121,13



MOCHILA JUV FEM POLIESTER MORMAII 0121

Código: Fábrica: Unidade:
44034 MORMAII UN/1
F1 F4

UN: R\$ 111,81 AV: R\$ 111,81 15: R\$ 114,14
30: R\$ 116,42 45: R\$ 118,75 60: R\$ 121,13



MOCHILA JUV FEM POLIESTER MORMAII 0122

Código: Fábrica: Unidade:
44036 MORMAII UN/1
F1 F4

UN: R\$ 69,88 AV: R\$ 69,88 15: R\$ 71,33
30: R\$ 72,76 45: R\$ 74,22 60: R\$ 75,70



MOCHILA JUV FLAMINGO M M4057

Código: Fábrica: Unidade:
41430 VOZZ UN/1
F1 F4

UN: R\$ 111,81 AV: R\$ 111,81 15: R\$ 114,14
30: R\$ 116,42 45: R\$ 118,75 60: R\$ 121,13



MOCHILA JUV POLIESTER MORMAII 0111

Código: Fábrica: Unidade:
44037 MORMAII UN/1
F1 F4

UN: R\$ 111,81 AV: R\$ 111,81 15: R\$ 114,14
30: R\$ 116,42 45: R\$ 118,75 60: R\$ 121,13



MOCHILA JUV POLIESTER MORMAII 0113
Código: Fábrica: Unidade:
44039 MORMAII UN/1
F1 F4

UN: R\$ 111,81 AV: R\$ 111,81 15: R\$ 114,14
30: R\$ 116,42 45: R\$ 118,75 60: R\$ 121,13



MOCHILA JUV POLIESTER MORMAII 0115
Código: Fábrica: Unidade:
44035 MORMAII UN/1
F1 F4

UN: R\$ 119,80 AV: R\$ 119,80 15: R\$ 122,29
30: R\$ 124,74 45: R\$ 127,23 60: R\$ 129,78



MOCHILA JUV POLIESTER MORMAII 0120
Código: Fábrica: Unidade:
44038 MORMAII UN/1
F1 F4

UN: R\$ 47,91 AV: R\$ 47,91 15: R\$ 48,91
30: R\$ 49,89 45: R\$ 50,89 60: R\$ 51,91



MOCHILA JUVENIL BASIC 21734
Código: Fábrica: Unidade:
43222 WINTH UN/1
F1 F4

UN: R\$ 47,91 AV: R\$ 47,91 15: R\$ 48,91
30: R\$ 49,89 45: R\$ 50,89 60: R\$ 51,91



MOCHILA JUVENIL CASUAL POLIESTER 32084
Código: Fábrica: Unidade:
44071 WINTH UN/1
F1 F4

UN: R\$ 47,91 AV: R\$ 47,91 15: R\$ 48,91
30: R\$ 49,89 45: R\$ 50,89 60: R\$ 51,91



MOCHILA JUVENIL CASUAL 32142
Código: Fábrica: Unidade:
43600 WINTH UN/1
F1 F4

UN: R\$ 79,86 AV: R\$ 79,86 15: R\$ 81,53
30: R\$ 83,16 45: R\$ 84,82 60: R\$ 86,52



MOCHILA JUVENIL COST HOT PINK 0800404
Código: Fábrica: Unidade:
35620 GOSUPER UN/1
F1 F4

UN: R\$ 139,77 AV: R\$ 139,77 15: R\$ 142,68
30: R\$ 145,53 45: R\$ 148,44 60: R\$ 151,41



MOCHILA JUVENIL FEM ESTAMPA 30063
Código: Fábrica: Unidade:
45938 WINTH TEEN UN/1
F1 F4

UN: R\$ 87,85 AV: R\$ 87,85 15: R\$ 89,68
30: R\$ 91,47 45: R\$ 93,30 60: R\$ 95,17



MOCHILA JUVENIL FEM FS BORBOLETAS 30511
Código: Fábrica: Unidade:
45939 WINTH UN/1
F1 F4

UN: R\$ 87,85 AV: R\$ 87,85 15: R\$ 89,68
30: R\$ 91,47 45: R\$ 93,30 60: R\$ 95,17



MOCHILA JUVENIL FEM FS FLAMINGOS 30461
Código: Fábrica: Unidade:
45940 WINTH UN/1
F1 F4

UN: R\$ 102,83 AV: R\$ 102,83 15: R\$ 104,97
30: R\$ 107,07 45: R\$ 109,21 60: R\$ 111,39



MOCHILA JUVENIL FEM LOVEKING M4736
Código: Fábrica: Unidade:
48982 PONTO VERDE UN/1
F1 F4

UN: R\$ 102,83 AV: R\$ 102,83 15: R\$ 104,97
30: R\$ 107,07 45: R\$ 109,21 60: R\$ 111,39



MOCHILA JUVENIL FEM LOVEKING M4737
Código: Fábrica: Unidade:
48967 PONTO VERDE UN/1
F1 F4

UN: R\$ 94,84 AV: R\$ 94,84 15: R\$ 96,81
30: R\$ 98,75 45: R\$ 100,73 60: R\$ 102,74



MOCHILA JUVENIL FEM LOVEKING M5033
Código: Fábrica: Unidade:
48975 PONTO VERDE UN/1
F1 F4

UN: R\$ 94,84 AV: R\$ 94,84 15: R\$ 96,81
30: R\$ 98,75 45: R\$ 100,73 60: R\$ 102,74



MOCHILA JUVENIL FEM LOVEKING M5034
Código: Fábrica: Unidade:
48972 PONTO VERDE UN/1
F1 F4

UN: R\$ 94,84 AV: R\$ 94,84 15: R\$ 96,81
30: R\$ 98,75 45: R\$ 100,73 60: R\$ 102,74



MOCHILA JUVENIL FEM LOVEKING M5035
Código: Fábrica: Unidade:
48978 PONTO VERDE UN/1
F1 F4

UN: R\$ 96,83 AV: R\$ 96,83 15: R\$ 98,85
30: R\$ 100,83 45: R\$ 102,85 60: R\$ 104,90



MOCHILA JUVENIL FEM LOVEKING M5036
Código: Fábrica: Unidade:
48970 PONTO VERDE UN/1
F1 F4

UN: R\$ 69,88 AV: R\$ 69,88 15: R\$ 71,33
30: R\$ 72,76 45: R\$ 74,22 60: R\$ 75,70



MOCHILA JUVENIL FEM MH3300

Código: 32348 Fábrica: SBC Unidade: UN/1 F1 F4

UN: R\$ 69,88 AV: R\$ 69,88 15: R\$ 71,33
30: R\$ 72,76 45: R\$ 74,22 60: R\$ 75,70



MOCHILA JUVENIL FEM MH3303

Código: 32110 Fábrica: SBC Unidade: UN/1 F1 F4

UN: R\$ 64,89 AV: R\$ 64,89 15: R\$ 66,24
30: R\$ 67,56 45: R\$ 68,91 60: R\$ 70,29



MOCHILA JUVENIL FEM POLIESTER GARDE 2331

Código: 44049 Fábrica: RABISK Unidade: UN/1 F1 F4

UN: R\$ 64,89 AV: R\$ 64,89 15: R\$ 66,24
30: R\$ 67,56 45: R\$ 68,91 60: R\$ 70,29



MOCHILA JUVENIL FEM POLIESTER STARS 2332

Código: 44050 Fábrica: RABISK Unidade: UN/1 F1 F4

UN: R\$ 104,82 AV: R\$ 104,82 15: R\$ 107,01
30: R\$ 109,15 45: R\$ 111,33 60: R\$ 113,56



MOCHILA JUVENIL FEM SBC MH MH3768

Código: 36033 Fábrica: SBC Unidade: UN/1 F1 F4

UN: R\$ 139,77 AV: R\$ 139,77 15: R\$ 142,68
30: R\$ 145,53 45: R\$ 148,44 60: R\$ 151,41



MOCHILA JUVENIL FEM SBC MH MH3971

Código: 36044 Fábrica: SBC Unidade: UN/1 F1 F4

UN: R\$ 99,83 AV: R\$ 99,83 15: R\$ 101,91
30: R\$ 103,95 45: R\$ 106,03 60: R\$ 108,15



MOCHILA JUVENIL FEM SBC MH M3767

Código: 36094 Fábrica: SBC Unidade: UN/1 F1 F4

UN: R\$ 102,83 AV: R\$ 102,83 15: R\$ 104,97
30: R\$ 107,07 45: R\$ 109,21 60: R\$ 111,39



MOCHILA JUVENIL FEM SBC MH M3769

Código: 36058 Fábrica: SBC Unidade: UN/1 F1 F4

UN: R\$ 99,84 AV: R\$ 99,84 15: R\$ 101,92
30: R\$ 103,96 45: R\$ 106,04 60: R\$ 108,16



MOCHILA JUVENIL FEM SBC MH3171

Código: 32320 Fábrica: SBC Unidade: UN/1 F1 F4

UN: R\$ 109,82 AV: R\$ 109,82 15: R\$ 112,11
30: R\$ 114,35 45: R\$ 116,64 60: R\$ 118,97



MOCHILA JUVENIL FEM SBC VKG M3987

Código: 36220 Fábrica: SBC Unidade: UN/1 F1 F4

UN: R\$ 94,84 AV: R\$ 94,84 15: R\$ 96,81
30: R\$ 98,75 45: R\$ 100,73 60: R\$ 102,74



MOCHILA JUVENIL FEM TOP MODEL TM25

Código: 48974 Fábrica: PONTO VERDE Unidade: UN/1 F1 F4

UN: R\$ 94,84 AV: R\$ 94,84 15: R\$ 96,81
30: R\$ 98,75 45: R\$ 100,73 60: R\$ 102,74



MOCHILA JUVENIL FEM TOP MODEL TM26

Código: 48979 Fábrica: PONTO VERDE Unidade: UN/1 F1 F4

UN: R\$ 59,89 AV: R\$ 59,89 15: R\$ 61,14
30: R\$ 62,36 45: R\$ 63,61 60: R\$ 64,88



MOCHILA JUVENIL FEM UNI LOVER EMOJ M3774

Código: 34304 Fábrica: SBC Unidade: UN/1 F1 F4

UN: R\$ 102,83 AV: R\$ 102,83 15: R\$ 104,97
30: R\$ 107,07 45: R\$ 109,21 60: R\$ 111,39



MOCHILA JUVENIL FEM VKG M4263

Código: 48963 Fábrica: PONTO VERDE Unidade: UN/1 F1 F4

UN: R\$ 94,84 AV: R\$ 94,84 15: R\$ 96,81
30: R\$ 98,75 45: R\$ 100,73 60: R\$ 102,74



MOCHILA JUVENIL FEM VKG M4286

Código: 48971 Fábrica: PONTO VERDE Unidade: UN/1 F1 F4

UN: R\$ 139,77 AV: R\$ 139,77 15: R\$ 142,68
30: R\$ 145,53 45: R\$ 148,44 60: R\$ 151,41



MOCHILA JUVENIL FEM VKG M4302

Código: 44396 Fábrica: PONTO VERDE Unidade: UN/1 F1 F4

UN: R\$ 109,81 AV: R\$ 109,81 15: R\$ 112,10
30: R\$ 114,34 45: R\$ 116,63 60: R\$ 118,96



MOCHILA JUVENIL FEM VKG M4305

Código: Fábrika: Unidade:
44398 PONTO VERDE UN/1
F1 F4

UN: R\$ 104,82 AV: R\$ 104,82 15: R\$ 107,01
30: R\$ 109,15 45: R\$ 111,33 60: R\$ 113,56



MOCHILA JUVENIL FEM VKG M4356

Código: Fábrika: Unidade:
48981 PONTO VERDE UN/1
F1 F4

UN: R\$ 84,85 AV: R\$ 84,85 15: R\$ 86,62
30: R\$ 88,35 45: R\$ 90,12 60: R\$ 91,92



MOCHILA JUVENIL FEM WOOKEY 3687

Código: Fábrika: Unidade:
34206 WOOKEY UN/1
F1 F4

UN: R\$ 47,91 AV: R\$ 47,91 15: R\$ 48,91
30: R\$ 49,89 45: R\$ 50,89 60: R\$ 51,91



MOCHILA JUVENIL FEM 31824

Código: Fábrika: Unidade:
43594 WINTH UN/1
F1 F4

UN: R\$ 47,91 AV: R\$ 47,91 15: R\$ 48,91
30: R\$ 49,89 45: R\$ 50,89 60: R\$ 51,91



MOCHILA JUVENIL FEM 31834

Código: Fábrika: Unidade:
43593 WINTH UN/1
F1 F4

UN: R\$ 47,91 AV: R\$ 47,91 15: R\$ 48,91
30: R\$ 49,89 45: R\$ 50,89 60: R\$ 51,91



MOCHILA JUVENIL FEM 31844

Código: Fábrika: Unidade:
43595 WINTH UN/1
F1 F4

UN: R\$ 47,91 AV: R\$ 47,91 15: R\$ 48,91
30: R\$ 49,89 45: R\$ 50,89 60: R\$ 51,91



MOCHILA JUVENIL FEM 31924

Código: Fábrika: Unidade:
43229 WINTH UN/1
F1 F4

UN: R\$ 47,91 AV: R\$ 47,91 15: R\$ 48,91
30: R\$ 49,89 45: R\$ 50,89 60: R\$ 51,91



MOCHILA JUVENIL FEM 31994

Código: Fábrika: Unidade:
43228 WINTH UN/1
F1 F4

UN: R\$ 47,91 AV: R\$ 47,91 15: R\$ 48,91
30: R\$ 49,89 45: R\$ 50,89 60: R\$ 51,91



MOCHILA JUVENIL FEM 32014

Código: Fábrika: Unidade:
43225 WINTH UN/1
F1 F4

UN: R\$ 47,91 AV: R\$ 47,91 15: R\$ 48,91
30: R\$ 49,89 45: R\$ 50,89 60: R\$ 51,91



MOCHILA JUVENIL FEM 32024

Código: Fábrika: Unidade:
43226 WINTH UN/1
F1 F4

UN: R\$ 47,91 AV: R\$ 47,91 15: R\$ 48,91
30: R\$ 49,89 45: R\$ 50,89 60: R\$ 51,91



MOCHILA JUVENIL FEM 32034

Código: Fábrika: Unidade:
43227 WINTH UN/1
F1 F4

UN: R\$ 47,91 AV: R\$ 47,91 15: R\$ 48,91
30: R\$ 49,89 45: R\$ 50,89 60: R\$ 51,91



MOCHILA JUVENIL FEM 32054

Código: Fábrika: Unidade:
43596 WINTH UN/1
F1 F4

UN: R\$ 104,82 AV: R\$ 104,82 15: R\$ 107,01
30: R\$ 109,15 45: R\$ 111,33 60: R\$ 113,56



MOCHILA JUVENIL HI PANDA 4327

Código: Fábrika: Unidade:
44397 PONTO VERDE UN/1
F1 F4

UN: R\$ 71,87 AV: R\$ 71,87 15: R\$ 73,37
30: R\$ 74,84 45: R\$ 76,34 60: R\$ 77,86



MOCHILA JUVENIL JAKARTA M5000

Código: Fábrika: Unidade:
49012 PONTO VERDE UN/1
F1 F4

UN: R\$ 71,87 AV: R\$ 71,87 15: R\$ 73,37
30: R\$ 74,84 45: R\$ 76,34 60: R\$ 77,86



MOCHILA JUVENIL JAKARTA M5006

Código: Fábrika: Unidade:
49017 PONTO VERDE UN/1
F1 F4

UN: R\$ 81,86 AV: R\$ 81,86 15: R\$ 83,56
30: R\$ 85,24 45: R\$ 86,94 60: R\$ 88,68



MOCHILA JUVENIL JAKARTA M5008

Código: Fábrika: Unidade:
49018 PONTO VERDE UN/1
F1 F4

UN: R\$ 34,93 AV: R\$ 34,93 15: R\$ 35,66
30: R\$ 36,38 45: R\$ 37,10 60: R\$ 37,84



MOCHILA JUVENIL MASC FULL COLOR 21834

Código: Fábrica: Unidade:
45937 WINTH UN/1
F1 F4

UN: R\$ 139,77 AV: R\$ 139,77 15: R\$ 142,68
30: R\$ 145,53 45: R\$ 148,44 60: R\$ 151,41

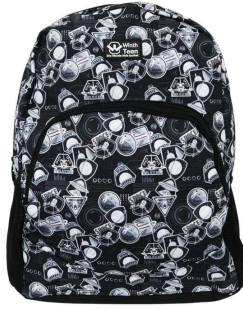

MOCHILA JUVENIL MASC PATCHES 20023

Código: Fábrica: Unidade:
45936 WINTH TEEN UN/1
F1 F4

UN: R\$ 47,91 AV: R\$ 47,91 15: R\$ 48,91
30: R\$ 49,89 45: R\$ 50,89 60: R\$ 51,91



MOCHILA JUVENIL MASC POLIESTER 21774

Código: Fábrica: Unidade:
44070 WINTH UN/1
F1 F4

UN: R\$ 47,91 AV: R\$ 47,91 15: R\$ 48,91
30: R\$ 49,89 45: R\$ 50,89 60: R\$ 51,91



MOCHILA JUVENIL MASC 21534

Código: Fábrica: Unidade:
43597 WINTH UN/1
F1 F4

UN: R\$ 47,91 AV: R\$ 47,91 15: R\$ 48,91
30: R\$ 49,89 45: R\$ 50,89 60: R\$ 51,91



MOCHILA JUVENIL MASC 21584

Código: Fábrica: Unidade:
43598 WINTH UN/1
F1 F4

UN: R\$ 47,91 AV: R\$ 47,91 15: R\$ 48,91
30: R\$ 49,89 45: R\$ 50,89 60: R\$ 51,91



MOCHILA JUVENIL MASC 21594

Código: Fábrica: Unidade:
43599 WINTH UN/1
F1 F4

UN: R\$ 47,91 AV: R\$ 47,91 15: R\$ 48,91
30: R\$ 49,89 45: R\$ 50,89 60: R\$ 51,91



MOCHILA JUVENIL MASC 21724

Código: Fábrica: Unidade:
43223 WINTH UN/1
F1 F4

UN: R\$ 47,91 AV: R\$ 47,91 15: R\$ 48,91
30: R\$ 49,89 45: R\$ 50,89 60: R\$ 51,91



MOCHILA JUVENIL MASC 21744

Código: Fábrica: Unidade:
43224 WINTH UN/1
F1 F4

UN: R\$ 89,85 AV: R\$ 89,85 15: R\$ 91,72
30: R\$ 93,55 45: R\$ 95,42 60: R\$ 97,33



MOCHILA JUVENIL MH M3445

Código: Fábrica: Unidade:
34195 SBC UN/1
F1 F4

UN: R\$ 112,81 AV: R\$ 112,81 15: R\$ 115,16
30: R\$ 117,46 45: R\$ 119,81 60: R\$ 122,21



MOCHILA JUVENIL POLIESTER FEM WILSON 531

Código: Fábrica: Unidade:
43668 WILSON UN/1
F1 F4

UN: R\$ 99,83 AV: R\$ 99,83 15: R\$ 101,91
30: R\$ 103,95 45: R\$ 106,03 60: R\$ 108,15



MOCHILA JUVENIL POLIESTER MORMAII 110/21

Código: Fábrica: Unidade:
45404 MORMAII UN/1
F1 F4

UN: R\$ 93,00 AV: R\$ 93,00 15: R\$ 94,94
30: R\$ 96,84 45: R\$ 98,77 60: R\$ 100,75



MOCHILA JUVENIL POLIESTER MORMAII 124

Código: Fábrica: Unidade:
45405 MORMAII UN/1
F1 F4

UN: R\$ 99,83 AV: R\$ 99,83 15: R\$ 101,91
30: R\$ 103,95 45: R\$ 106,03 60: R\$ 108,15



MOCHILA JUVENIL POLIESTER MORMAII 209

Código: Fábrica: Unidade:
45403 MORMAII UN/1
F1 F4

UN: R\$ 99,83 AV: R\$ 99,83 15: R\$ 101,91
30: R\$ 103,95 45: R\$ 106,03 60: R\$ 108,15



MOCHILA JUVENIL POLIESTER MORMAII 210

Código: Fábrica: Unidade:
46793 MORMAII UN/1
F1 F4

UN: R\$ 99,83 AV: R\$ 99,83 15: R\$ 101,91
30: R\$ 103,95 45: R\$ 106,03 60: R\$ 108,15



MOCHILA JUVENIL POLIESTER MORMAII 211

Código: Fábrica: Unidade:
45408 MORMAII UN/1
F1 F4

UN: R\$ 99,83 AV: R\$ 99,83 15: R\$ 101,91
30: R\$ 103,95 45: R\$ 106,03 60: R\$ 108,15



MOCHILA JUVENIL POLIESTER MORMAII 213

Código: Fábrica: Unidade:
45406 MORMAII UN/1
F1 F4

UN: R\$ 99,83 AV: R\$ 99,83 15: R\$ 101,91
30: R\$ 103,95 45: R\$ 106,03 60: R\$ 108,15



MOCHILA JUVENIL POLIESTER MORMAII 214

Código: Fábrica: Unidade:
45409 MORMAII UN/1
F1 F4

UN: R\$ 99,83 AV: R\$ 99,83 15: R\$ 101,91
30: R\$ 103,95 45: R\$ 106,03 60: R\$ 108,15



MOCHILA JUVENIL POLIESTER MORMAII 215

Código: Fábrica: Unidade:
45407 MORMAII UN/1
F1 F4

UN: R\$ 104,82 AV: R\$ 104,82 15: R\$ 107,01
30: R\$ 109,15 45: R\$ 111,33 60: R\$ 113,56



MOCHILA JUVENIL POLIESTER WILSON 514

Código: Fábrica: Unidade:
43688 WILSON UN/1
F1 F4

UN: R\$ 104,82 AV: R\$ 104,82 15: R\$ 107,01
30: R\$ 109,15 45: R\$ 111,33 60: R\$ 113,56



MOCHILA JUVENIL POLIESTER WILSON 515

Código: Fábrica: Unidade:
43687 WILSON UN/1
F1 F4

UN: R\$ 104,82 AV: R\$ 104,82 15: R\$ 107,01
30: R\$ 109,15 45: R\$ 111,33 60: R\$ 113,56



MOCHILA JUVENIL POLIESTER WILSON 520

Código: Fábrica: Unidade:
43692 WILSON UN/1
F1 F4

UN: R\$ 89,85 AV: R\$ 89,85 15: R\$ 91,72
30: R\$ 93,55 45: R\$ 95,42 60: R\$ 97,33



MOCHILA JUVENIL POLIESTER WILSON 521

Código: Fábrica: Unidade:
43673 WILSON UN/1
F1 F4

UN: R\$ 104,82 AV: R\$ 104,82 15: R\$ 107,01
30: R\$ 109,15 45: R\$ 111,33 60: R\$ 113,56



MOCHILA JUVENIL POLIESTER WILSON 524

Código: Fábrica: Unidade:
43691 WILSON UN/1
F1 F4

UN: R\$ 112,81 AV: R\$ 112,81 15: R\$ 115,16
30: R\$ 117,46 45: R\$ 119,81 60: R\$ 122,21



MOCHILA JUVENIL POLIESTER WILSON 529

Código: Fábrica: Unidade:
43686 WILSON UN/1
F1 F4

UN: R\$ 99,83 AV: R\$ 99,83 15: R\$ 101,91
30: R\$ 103,95 45: R\$ 106,03 60: R\$ 108,15



MOCHILA JUVENIL POLIESTER WILSON 530

Código: Fábrica: Unidade:
43678 WILSON UN/1
F1 F4

UN: R\$ 112,81 AV: R\$ 112,81 15: R\$ 115,16
30: R\$ 117,46 45: R\$ 119,81 60: R\$ 122,21



MOCHILA JUVENIL POLIESTER WILSON 533

Código: Fábrica: Unidade:
43675 WILSON UN/1
F1 F4

UN: R\$ 112,81 AV: R\$ 112,81 15: R\$ 115,16
30: R\$ 117,46 45: R\$ 119,81 60: R\$ 122,21



MOCHILA JUVENIL POLIESTER WILSON 536

Código: Fábrica: Unidade:
43676 WILSON UN/1
F1 F4

UN: R\$ 112,81 AV: R\$ 112,81 15: R\$ 115,16
30: R\$ 117,46 45: R\$ 119,81 60: R\$ 122,21



MOCHILA JUVENIL POLIESTER WILSON 537

Código: Fábrica: Unidade:
43674 WILSON UN/1
F1 F4

UN: R\$ 112,81 AV: R\$ 112,81 15: R\$ 115,16
30: R\$ 117,46 45: R\$ 119,81 60: R\$ 122,21



MOCHILA JUVENIL POLIESTER WILSON 544

Código: Fábrica: Unidade:
43684 WILSON UN/1
F1 F4

UN: R\$ 112,81 AV: R\$ 112,81 15: R\$ 115,16
30: R\$ 117,46 45: R\$ 119,81 60: R\$ 122,21



MOCHILA JUVENIL POLIESTER WILSON 545

Código: Fábrica: Unidade:
43670 WILSON UN/1
F1 F4

UN: R\$ 112,81 AV: R\$ 112,81 15: R\$ 115,16
30: R\$ 117,46 45: R\$ 119,81 60: R\$ 122,21



MOCHILA JUVENIL POLIESTER WILSON 546

Código: Fábrica: Unidade:
43704 WILSON UN/1
F1 F4

UN: R\$ 112,81 AV: R\$ 112,81 15: R\$ 115,16
30: R\$ 117,46 45: R\$ 119,81 60: R\$ 122,21



MOCHILA JUVENIL POLIESTER WILSON 548

Código: Fábrica: Unidade:
43690 WILSON UN/1
F1 F4

UN: R\$ 112,81 AV: R\$ 112,81 15: R\$ 115,16
30: R\$ 117,46 45: R\$ 119,81 60: R\$ 122,21

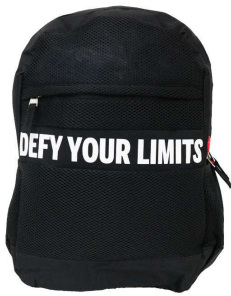

MOCHILA JUVENIL POLIESTER WILSON 550
Código: 43677 Fábrica: WILSON Unidade: UN/1
F1 F4

UN: R\$ 112,81 AV: R\$ 112,81 15: R\$ 115,16
30: R\$ 117,46 45: R\$ 119,81 60: R\$ 122,21



MOCHILA JUVENIL POLIESTER WILSON 554
Código: 43705 Fábrica: WILSON Unidade: UN/1
F1 F4

UN: R\$ 112,81 AV: R\$ 112,81 15: R\$ 115,16
30: R\$ 117,46 45: R\$ 119,81 60: R\$ 122,21



MOCHILA JUVENIL POLIESTER WILSON 558
Código: 43671 Fábrica: WILSON Unidade: UN/1
F1 F4

UN: R\$ 112,81 AV: R\$ 112,81 15: R\$ 115,16
30: R\$ 117,46 45: R\$ 119,81 60: R\$ 122,21



MOCHILA JUVENIL POLIESTER WILSON 560
Código: 43681 Fábrica: WILSON Unidade: UN/1
F1 F4

UN: R\$ 112,81 AV: R\$ 112,81 15: R\$ 115,16
30: R\$ 117,46 45: R\$ 119,81 60: R\$ 122,21



MOCHILA JUVENIL POLIESTER WILSON 563
Código: 43669 Fábrica: WILSON Unidade: UN/1
F1 F4

UN: R\$ 112,81 AV: R\$ 112,81 15: R\$ 115,16
30: R\$ 117,46 45: R\$ 119,81 60: R\$ 122,21



MOCHILA JUVENIL POLIESTER WILSON 619
Código: 43672 Fábrica: WILSON Unidade: UN/1
F1 F4

UN: R\$ 64,89 AV: R\$ 64,89 15: R\$ 66,24
30: R\$ 67,56 45: R\$ 68,91 60: R\$ 70,29



MOCHILA JUVENIL POLIESTER 2333
Código: 44041 Fábrica: RABISK Unidade: UN/1
F1 F4

UN: R\$ 64,89 AV: R\$ 64,89 15: R\$ 66,24
30: R\$ 67,56 45: R\$ 68,91 60: R\$ 70,29



MOCHILA JUVENIL POLIESTER 2334
Código: 44040 Fábrica: RABISK Unidade: UN/1
F1 F4

UN: R\$ 39,99 AV: R\$ 39,99 15: R\$ 39,99
30: R\$ 39,99 45: R\$ 39,99 60: R\$ 39,99



MOCHILA JUVENIL POLIESTER 46310
Código: 43783 Fábrica: ADV Unidade: UN/1
F1 F4

UN: R\$ 89,85 AV: R\$ 89,85 15: R\$ 91,72
30: R\$ 93,55 45: R\$ 95,42 60: R\$ 97,33



MOCHILA JUVENIL PRETA 6201
Código: 19416 Fábrica: FUSECO Unidade: UN/1
F1 F4

UN: R\$ 89,85 AV: R\$ 89,85 15: R\$ 91,72
30: R\$ 93,55 45: R\$ 95,42 60: R\$ 97,33



MOCHILA JUVENIL PRETA 6202
Código: 19417 Fábrica: FUSECO Unidade: UN/1
F1 F4

UN: R\$ 89,85 AV: R\$ 89,85 15: R\$ 91,72
30: R\$ 93,55 45: R\$ 95,42 60: R\$ 97,33



MOCHILA JUVENIL PRETA 6204
Código: 19419 Fábrica: FUSECO Unidade: UN/1
F1 F4

UN: R\$ 89,85 AV: R\$ 89,85 15: R\$ 91,72
30: R\$ 93,55 45: R\$ 95,42 60: R\$ 97,33



MOCHILA JUVENIL PRETA 6205
Código: 19420 Fábrica: FUSECO Unidade: UN/1
F1 F4

UN: R\$ 89,85 AV: R\$ 89,85 15: R\$ 91,72
30: R\$ 93,55 45: R\$ 95,42 60: R\$ 97,33



MOCHILA JUVENIL PRETA 6206
Código: 19421 Fábrica: FUSECO Unidade: UN/1
F1 F4

UN: R\$ 89,85 AV: R\$ 89,85 15: R\$ 91,72
30: R\$ 93,55 45: R\$ 95,42 60: R\$ 97,33



MOCHILA JUVENIL PRETA 6207
Código: 19422 Fábrica: FUSECO Unidade: UN/1
F1 F4

UN: R\$ 89,85 AV: R\$ 89,85 15: R\$ 91,72
30: R\$ 93,55 45: R\$ 95,42 60: R\$ 97,33



MOCHILA JUVENIL PRETA 6208
Código: 19423 Fábrica: FUSECO Unidade: UN/1
F1 F4

UN: R\$ 89,85 AV: R\$ 89,85 15: R\$ 91,72
30: R\$ 93,55 45: R\$ 95,42 60: R\$ 97,33



MOCHILA JUVENIL PRETA 7801

Código: Fábrika: Unidade:
19424 FUSECO UN/1
F1 F4

UN: R\$ 89,85 AV: R\$ 89,85 15: R\$ 91,72
30: R\$ 93,55 45: R\$ 95,42 60: R\$ 97,33



MOCHILA JUVENIL PRETA 7803

Código: Fábrika: Unidade:
19425 FUSECO UN/1
F1 F4

UN: R\$ 89,85 AV: R\$ 89,85 15: R\$ 91,72
30: R\$ 93,55 45: R\$ 95,42 60: R\$ 97,33



MOCHILA JUVENIL PRETA 7808

Código: Fábrika: Unidade:
19426 FUSECO UN/1
F1 F4

UN: R\$ 79,86 AV: R\$ 79,86 15: R\$ 81,53
30: R\$ 83,16 45: R\$ 84,82 60: R\$ 86,52



MOCHILA JUVENIL SBC VKG M4061

Código: Fábrika: Unidade:
38044 SBC UN/1
F1 F4

UN: R\$ 39,93 AV: R\$ 39,93 15: R\$ 40,76
30: R\$ 41,57 45: R\$ 42,40 60: R\$ 43,25



MOCHILA JUVENIL UNI LOVERS M3469

Código: Fábrika: Unidade:
32936 SBC UN/1
F1 F4

UN: R\$ 79,86 AV: R\$ 79,86 15: R\$ 81,53
30: R\$ 83,16 45: R\$ 84,82 60: R\$ 86,52



MOCHILA JUVENIL WOOKEY M3443

Código: Fábrika: Unidade:
38054 WOOKEY UN/1
F1 F4

UN: R\$ 89,85 AV: R\$ 89,85 15: R\$ 91,72
30: R\$ 93,55 45: R\$ 95,42 60: R\$ 97,33



MOCHILA JUVENIL WOOKEY M3447

Código: Fábrika: Unidade:
34196 WOOKEY UN/1
F1 F4

UN: R\$ 99,83 AV: R\$ 99,83 15: R\$ 101,91
30: R\$ 103,95 45: R\$ 106,03 60: R\$ 108,15



MOCHILA JUVENIL WOOKEY M3686

Código: Fábrika: Unidade:
34205 WOOKEY UN/1
F1 F4

UN: R\$ 79,86 AV: R\$ 79,86 15: R\$ 81,53
30: R\$ 83,16 45: R\$ 84,82 60: R\$ 86,52



MOCHILA JUVENIL WOOKEY M3688

Código: Fábrika: Unidade:
34207 WOOKEY UN/1
F1 F4

UN: R\$ 79,99 AV: R\$ 79,99 15: R\$ 79,99
30: R\$ 79,99 45: R\$ 79,99 60: R\$ 79,99



MOCHILA JUVENIL WOOKEY M3965

Código: Fábrika: Unidade:
44055 PONTO VERDE UN/1
F1 F4

UN: R\$ 69,99 AV: R\$ 69,99 15: R\$ 69,99
30: R\$ 69,99 45: R\$ 69,99 60: R\$ 69,99



MOCHILA JUVENIL WOOKEY M3967

Código: Fábrika: Unidade:
46470 WOOKEY UN/1
F1 F4

UN: R\$ 69,88 AV: R\$ 69,88 15: R\$ 71,33
30: R\$ 72,76 45: R\$ 74,22 60: R\$ 75,70



MOCHILA JUVENIL WOOKEY M4058

Código: Fábrika: Unidade:
38043 WOOKEY UN/1
F1 F4

UN: R\$ 89,85 AV: R\$ 89,85 15: R\$ 91,72
30: R\$ 93,55 45: R\$ 95,42 60: R\$ 97,33



MOCHILA JUVENIL WOOKEY 3441

Código: Fábrika: Unidade:
34194 WOOKEY UN/1
F1 F4

UN: R\$ 84,85 AV: R\$ 84,85 15: R\$ 86,62
30: R\$ 88,35 45: R\$ 90,12 60: R\$ 91,92



MOCHILA JUVENIL WOOKEY 3460

Código: Fábrika: Unidade:
34201 WOOKEY UN/1
F1 F4

UN: R\$ 84,85 AV: R\$ 84,85 15: R\$ 86,62
30: R\$ 88,35 45: R\$ 90,12 60: R\$ 91,92



MOCHILA JUVENIL WOOKEY 3461

Código: Fábrika: Unidade:
34203 WOOKEY UN/1
F1 F4

UN: R\$ 84,85 AV: R\$ 84,85 15: R\$ 86,62
30: R\$ 88,35 45: R\$ 90,12 60: R\$ 91,92



MOCHILA JUVENIL WOOKEY 3462

Código: Fábrika: Unidade:
34202 WOOKEY UN/1
F1 F4

UN: R\$ 84,85 AV: R\$ 84,85 15: R\$ 86,62
30: R\$ 88,35 45: R\$ 90,12 60: R\$ 91,92



MOCHILA JUVENIL WOOKEY 3463

Código: Fábrika: Unidade:
34204 WOOKEY UN/1
F1 F4

UN: R\$ 94,84 AV: R\$ 94,84 15: R\$ 96,81
30: R\$ 98,75 45: R\$ 100,73 60: R\$ 102,74



MOCHILA LAP TOP AZX CB ACO PRETA 1476

Código: Fábrika: Unidade:
46734 ROCIE UN/1
F1 F4

UN: R\$ 92,84 AV: R\$ 92,84 15: R\$ 94,78
30: R\$ 96,67 45: R\$ 98,60 60: R\$ 100,58



MOCHILA LAP TOP AZX CB ACO PRETA 1478

Código: Fábrika: Unidade:
46146 ROCIE UN/1
F1 F4

UN: R\$ 79,17 AV: R\$ 79,17 15: R\$ 80,82
30: R\$ 82,44 45: R\$ 84,09 60: R\$ 85,77



MOCHILA LAP TOP AZX PRETA 1520

Código: Fábrika: Unidade:
46145 ROCIE UN/1
F1 F4

UN: R\$ 69,99 AV: R\$ 69,99 15: R\$ 69,99
30: R\$ 69,99 45: R\$ 69,99 60: R\$ 69,99



MOCHILA LONA WOOKEY CB ACO W2021

Código: Fábrika: Unidade:
29360 WOOKEY UN/1
F1 F4

UN: R\$ 39,93 AV: R\$ 39,93 15: R\$ 40,76
30: R\$ 41,57 45: R\$ 42,40 60: R\$ 43,25



MOCHILA LOVELY GIRL TM18 LG-1880

Código: Fábrika: Unidade:
35768 SPEXPRESS UN/1
F1 F4

UN: R\$ 199,67 AV: R\$ 199,67 15: R\$ 203,83
30: R\$ 207,91 45: R\$ 212,06 60: R\$ 216,31



MOCHILA NOTEBOOK BLOONFIELD BF13

Código: Fábrika: Unidade:
26951 BLOONFIELD UN/1
F1 F4

UN: R\$ 169,72 AV: R\$ 169,72 15: R\$ 173,25
30: R\$ 176,72 45: R\$ 180,25 60: R\$ 183,86



MOCHILA NOTEBOOK BLOONFIELD BF50

Código: Fábrika: Unidade:
30538 BLOONFIELD UN/1
F1 F4

UN: R\$ 99,83 AV: R\$ 99,83 15: R\$ 101,91
30: R\$ 103,95 45: R\$ 106,03 60: R\$ 108,15



MOCHILA NOTEBOOK BLOONFIELD CB ACO BF42

Código: Fábrika: Unidade:
29298 BLOONFIELD UN/1
F1 F4

UN: R\$ 92,84 AV: R\$ 92,84 15: R\$ 94,78
30: R\$ 96,67 45: R\$ 98,60 60: R\$ 100,58



MOCHILA NOTEBOOK BLOONFIELD CB ACO BF43

Código: Fábrika: Unidade:
29611 BLOONFIELD UN/1
F1 F4

UN: R\$ 99,83 AV: R\$ 99,83 15: R\$ 101,91
30: R\$ 103,95 45: R\$ 106,03 60: R\$ 108,15



MOCHILA NOTEBOOK BLOONFIELD CB ACO BF44

Código: Fábrika: Unidade:
29614 BLOONFIELD UN/1
F1 F4

UN: R\$ 91,77 AV: R\$ 91,77 15: R\$ 93,68
30: R\$ 95,56 45: R\$ 97,47 60: R\$ 99,42



MOCHILA NOTEBOOK BLOONFIELD CB ACO BF45

Código: Fábrika: Unidade:
29613 BLOONFIELD UN/1
F1 F4

UN: R\$ 109,81 AV: R\$ 109,81 15: R\$ 112,10
30: R\$ 114,34 45: R\$ 116,63 60: R\$ 118,96



MOCHILA NOTEBOOK BLOONFIELD CB ACO BF57

Código: Fábrika: Unidade:
49196 PONTO VERDE UN/1
F1 F4

UN: R\$ 109,81 AV: R\$ 109,81 15: R\$ 112,10
30: R\$ 114,34 45: R\$ 116,63 60: R\$ 118,96



MOCHILA NOTEBOOK BLOONFIELD CB ACO BF58

Código: Fábrika: Unidade:
49197 PONTO VERDE UN/1
F1 F4

UN: R\$ 99,83 AV: R\$ 99,83 15: R\$ 101,91
30: R\$ 103,95 45: R\$ 106,03 60: R\$ 108,15



MOCHILA NOTEBOOK BLOONFIELD CB ACO M4500

Código: Fábrika: Unidade:
46458 BLOONFIELD UN/1
F1 F4

UN: R\$ 121,33 AV: R\$ 121,33 15: R\$ 123,85
30: R\$ 126,33 45: R\$ 128,86 60: R\$ 131,43



MOCHILA NOTEBOOK BLOONFIELD CB ACO M4501

Código: Fábrika: Unidade:
44053 BLOONFIELD UN/1
F1 F4

UN: R\$ 99,83 AV: R\$ 99,83 15: R\$ 101,91
30: R\$ 103,95 45: R\$ 106,03 60: R\$ 108,15



MOCHILA NOTEBOOK BLOONFIELD CB ACO M4502
Código: 44054 Fábrica: BLOONFIELD Unidade: UN/1 F1 F4

UN: R\$ 107,22 AV: R\$ 107,22 15: R\$ 109,45
30: R\$ 111,64 45: R\$ 113,87 60: R\$ 116,15



MOCHILA NOTEBOOK BLOONFIELD CB ACO M4505
Código: 46455 Fábrica: BLOONFIELD Unidade: UN/1 F1 F4

UN: R\$ 99,83 AV: R\$ 99,83 15: R\$ 101,91
30: R\$ 103,95 45: R\$ 106,03 60: R\$ 108,15



MOCHILA NOTEBOOK BLOONFIELD CB ACO M4506
Código: 46456 Fábrica: BLOONFIELD Unidade: UN/1 F1 F4

UN: R\$ 99,83 AV: R\$ 99,83 15: R\$ 101,91
30: R\$ 103,95 45: R\$ 106,03 60: R\$ 108,15



MOCHILA NOTEBOOK BLOONFIELD CB ACO M4507
Código: 46457 Fábrica: BLOONFIELD Unidade: UN/1 F1 F4

UN: R\$ 92,84 AV: R\$ 92,84 15: R\$ 94,78
30: R\$ 96,67 45: R\$ 98,60 60: R\$ 100,58



MOCHILA NOTEBOOK BLOONFIELD CB ACO M5019
Código: 48986 Fábrica: PONTO VERDE Unidade: UN/1 F1 F4

UN: R\$ 91,84 AV: R\$ 91,84 15: R\$ 93,76
30: R\$ 95,63 45: R\$ 97,54 60: R\$ 99,49



MOCHILA NOTEBOOK BLOONFIELD CB ACO M5022
Código: 49069 Fábrica: BLOONFIELD Unidade: UN/1 F1 F4

UN: R\$ 91,84 AV: R\$ 91,84 15: R\$ 93,76
30: R\$ 95,63 45: R\$ 97,54 60: R\$ 99,49



MOCHILA NOTEBOOK BLOONFIELD CB ACO M5023
Código: 49068 Fábrica: BLOONFIELD Unidade: UN/1 F1 F4

UN: R\$ 89,85 AV: R\$ 89,85 15: R\$ 91,72
30: R\$ 93,55 45: R\$ 95,42 60: R\$ 97,33



MOCHILA NOTEBOOK CB ACO 188-83
Código: 45592 Fábrica: KIMTINO Unidade: UN/1 F1 F4

UN: R\$ 89,85 AV: R\$ 89,85 15: R\$ 91,72
30: R\$ 93,55 45: R\$ 95,42 60: R\$ 97,33



MOCHILA NOTEBOOK CB ACO 188-85
Código: 45591 Fábrica: KIMTINO Unidade: UN/1 F1 F4

UN: R\$ 89,85 AV: R\$ 89,85 15: R\$ 91,72
30: R\$ 93,55 45: R\$ 95,42 60: R\$ 97,33



MOCHILA NOTEBOOK CB ACO 188-86
Código: 45610 Fábrica: KIMTINO Unidade: UN/1 F1 F4

UN: R\$ 249,59 AV: R\$ 249,59 15: R\$ 254,79
30: R\$ 259,89 45: R\$ 265,08 60: R\$ 270,39



MOCHILA NOTEBOOK C/CARR BLOONFIELD BF09
Código: 31805 Fábrica: BLOONFIELD Unidade: UN/1 F1 F4

UN: R\$ 249,59 AV: R\$ 249,59 15: R\$ 254,79
30: R\$ 259,89 45: R\$ 265,08 60: R\$ 270,39



MOCHILA NOTEBOOK C/CARR BLOONFIELD BF15
Código: 31806 Fábrica: BLOONFIELD Unidade: UN/1 F1 F4

UN: R\$ 239,61 AV: R\$ 239,61 15: R\$ 244,60
30: R\$ 249,49 45: R\$ 254,48 60: R\$ 259,57



MOCHILA NOTEBOOK C/CARR BLOONFIELD BF16
Código: 32347 Fábrica: BLOONFIELD Unidade: UN/1 F1 F4

UN: R\$ 199,67 AV: R\$ 199,67 15: R\$ 203,83
30: R\$ 207,91 45: R\$ 212,06 60: R\$ 216,31



MOCHILA NOTEBOOK C/CARR BLOONFIELD BF70
Código: 33968 Fábrica: BLOONFIELD Unidade: UN/1 F1 F4

UN: R\$ 184,69 AV: R\$ 184,69 15: R\$ 188,54
30: R\$ 192,31 45: R\$ 196,16 60: R\$ 200,08



MOCHILA NOTEBOOK C/CARR FEM MC4297
Código: 49194 Fábrica: PONTO VERDE Unidade: UN/1 F1 F4

UN: R\$ 184,69 AV: R\$ 184,69 15: R\$ 188,54
30: R\$ 192,31 45: R\$ 196,16 60: R\$ 200,08



MOCHILA NOTEBOOK C/CARR FEM VKG MC4290
Código: 49195 Fábrica: PONTO VERDE Unidade: UN/1 F1 F4

UN: R\$ 249,59 AV: R\$ 249,59 15: R\$ 254,79
30: R\$ 259,89 45: R\$ 265,08 60: R\$ 270,39



MOCHILA NOTEBOOK C/CARR MH BFC75/74

Código: 34312 Fábrica: BLOONFIELD Unidade: UN/1 F1 F4

UN: R\$ 209,66 AV: R\$ 209,66 15: R\$ 214,03
30: R\$ 218,31 45: R\$ 222,68 60: R\$ 227,13



MOCHILA NOTEBOOK C/CARRINHO TM10

Código: 31736 Fábrica: VOZZ Unidade: UN/1 F1 F4

UN: R\$ 249,59 AV: R\$ 249,59 15: R\$ 254,79
30: R\$ 259,89 45: R\$ 265,08 60: R\$ 270,39



MOCHILA NOTEBOOK C/CARRINHO TM11

Código: 31737 Fábrica: VOZZ Unidade: UN/1 F1 F4

UN: R\$ 249,59 AV: R\$ 249,59 15: R\$ 254,79
30: R\$ 259,89 45: R\$ 265,08 60: R\$ 270,39



MOCHILA NOTEBOOK C/CARRINHO TM13

Código: 31739 Fábrica: VOZZ Unidade: UN/1 F1 F4

UN: R\$ 249,59 AV: R\$ 249,59 15: R\$ 254,79
30: R\$ 259,89 45: R\$ 265,08 60: R\$ 270,39



MOCHILA NOTEBOOK C/CARRINHO TM14

Código: 31740 Fábrica: VOZZ Unidade: UN/1 F1 F4

UN: R\$ 249,59 AV: R\$ 249,59 15: R\$ 254,79
30: R\$ 259,89 45: R\$ 265,08 60: R\$ 270,39



MOCHILA NOTEBOOK C/CARRINHO TM15

Código: 31741 Fábrica: VOZZ Unidade: UN/1 F1 F4

UN: R\$ 229,62 AV: R\$ 229,62 15: R\$ 234,41
30: R\$ 239,09 45: R\$ 243,88 60: R\$ 248,75



MOCHILA NOTEBOOK C/CARRINHO TM34

Código: 34309 Fábrica: VOZZ Unidade: UN/1 F1 F4

UN: R\$ 102,83 AV: R\$ 102,83 15: R\$ 104,97
30: R\$ 107,07 45: R\$ 109,21 60: R\$ 111,39



MOCHILA NOTEBOOK INTERLAKEN CB ACO M5002

Código: 49007 Fábrica: PONTO VERDE Unidade: UN/1 F1 F4

UN: R\$ 102,83 AV: R\$ 102,83 15: R\$ 104,97
30: R\$ 107,07 45: R\$ 109,21 60: R\$ 111,39



MOCHILA NOTEBOOK INTERLAKEN CB ACO M5003

Código: 49019 Fábrica: PONTO VERDE Unidade: UN/1 F1 F4

UN: R\$ 102,83 AV: R\$ 102,83 15: R\$ 104,97
30: R\$ 107,07 45: R\$ 109,21 60: R\$ 111,39



MOCHILA NOTEBOOK INTERLAKEN CB ACO M5004

Código: 49009 Fábrica: PONTO VERDE Unidade: UN/1 F1 F4

UN: R\$ 129,99 AV: R\$ 129,99 15: R\$ 129,99
30: R\$ 129,99 45: R\$ 129,99 60: R\$ 129,99



MOCHILA NOTEBOOK WOOKIEE GG W59

Código: 46460 Fábrica: WOOKIEE Unidade: UN/1 F1 F4

UN: R\$ 89,85 AV: R\$ 89,85 15: R\$ 91,72
30: R\$ 93,55 45: R\$ 95,42 60: R\$ 97,33



MOCHILA PAW PATROL M M8492

Código: 37879 Fábrica: XERYUS Unidade: UN/1 F1 F4

UN: R\$ 109,81 AV: R\$ 109,81 15: R\$ 112,10
30: R\$ 114,34 45: R\$ 116,63 60: R\$ 118,96



MOCHILA POLIESTER WILSON 65010031

Código: 37839 Fábrica: WILSON Unidade: UN/1 F1 F4

UN: R\$ 89,85 AV: R\$ 89,85 15: R\$ 91,72
30: R\$ 93,55 45: R\$ 95,42 60: R\$ 97,33



MOCHILA POLIESTER WILSON 65010195

Código: 37836 Fábrica: WILSON Unidade: UN/1 F1 F4

UN: R\$ 89,85 AV: R\$ 89,85 15: R\$ 91,72
30: R\$ 93,55 45: R\$ 95,42 60: R\$ 97,33



MOCHILA POLIESTER WILSON 65010197

Código: 37835 Fábrica: WILSON Unidade: UN/1 F1 F4

UN: R\$ 89,85 AV: R\$ 89,85 15: R\$ 91,72
30: R\$ 93,55 45: R\$ 95,42 60: R\$ 97,33



MOCHILA POLIESTER WILSON 65010207

Código: 37837 Fábrica: WILSON Unidade: UN/1 F1 F4

UN: R\$ 89,85 AV: R\$ 89,85 15: R\$ 91,72
30: R\$ 93,55 45: R\$ 95,42 60: R\$ 97,33



MOCHILA POLIESTER WILSON 65010208

Código: Fábrika: Unidade:
37838 WILSON UN/1
F1 F4

UN: R\$ 27,95 AV: R\$ 27,95 15: R\$ 28,53
30: R\$ 29,10 45: R\$ 29,68 60: R\$ 30,27



MOCHILA SACO 01 BARCELONA 8317

Código: Fábrika: Unidade:
39843 XERYUS UN/1
F1 F4

UN: R\$ 26,95 AV: R\$ 26,95 15: R\$ 27,51
30: R\$ 28,06 45: R\$ 28,62 60: R\$ 29,19



MOCHILA SACO 02 BARCELONA 8318

Código: Fábrika: Unidade:
39844 XERYUS UN/1
F1 F4

UN: R\$ 39,93 AV: R\$ 39,93 15: R\$ 40,76
30: R\$ 41,57 45: R\$ 42,40 60: R\$ 43,25



MOCHILA TM17 LS-1718

Código: Fábrika: Unidade:
35778 SPEXPRESS UN/1
F1 F4

UN: R\$ 79,87 AV: R\$ 79,87 15: R\$ 81,54
30: R\$ 83,17 45: R\$ 84,83 60: R\$ 86,53



MOUSE GAMER X7

Código: Fábrika: Unidade:
36296 INOVA UN/1
F4

UN: R\$ 11,97 AV: R\$ 11,97 15: R\$ 12,22
30: R\$ 12,46 45: R\$ 12,71 60: R\$ 12,97



MOUSE OPTICO SCROLL USB 74300

Código: Fábrika: Unidade:
26801 LETRON UN/1
F1 F4

UN: R\$ 8,54 AV: R\$ 8,54 15: R\$ 8,71
30: R\$ 8,89 45: R\$ 9,07 60: R\$ 9,25



MOUSE PAD C/IMPRESSAO 210X210MM

Código: Fábrika: Unidade:
42741 DELLO UN/1
F1 F4

UN: R\$ 24,95 AV: R\$ 24,95 15: R\$ 25,47
30: R\$ 25,98 45: R\$ 26,50 60: R\$ 27,03



MOUSE PAD ERGONOMICO C/APOIO P/PUNHO

Código: Fábrika: Unidade:
42831 MBTECH UN/1
F1 F4

UN: R\$ 49,91 AV: R\$ 49,91 15: R\$ 50,95
30: R\$ 51,97 45: R\$ 53,01 60: R\$ 54,07

30 cm
80 cm



MOUSE PAD P/JOGOS 800X300X3MM 308

Código: Fábrika: Unidade:
41306 INOVA UN/1
F1 F4

UN: R\$ 7,98 AV: R\$ 7,98 15: R\$ 8,14
30: R\$ 8,31 45: R\$ 8,47 60: R\$ 8,64



MOUSE PAD PRETO 6553 210X210MM

Código: Fábrika: Unidade:
41807 DELLO UN/1
F1 F4

UN: R\$ 7,76 AV: R\$ 7,76 15: R\$ 7,92
30: R\$ 8,08 45: R\$ 8,24 60: R\$ 8,40



MOUSE PAD SLIM 20X18CM 74412

Código: Fábrika: Unidade:
46346 LETRON PT/1
F1 F4

UN: R\$ 31,94 AV: R\$ 31,94 15: R\$ 32,60
30: R\$ 33,26 45: R\$ 33,92 60: R\$ 34,60



MOUSE S/FIO 8608/8541/8580

Código: Fábrika: Unidade:
27125 INOVA UN/1
F1 F4

UN: R\$ 15,77 AV: R\$ 78,87 15: R\$ 80,52
30: R\$ 82,13 45: R\$ 83,77 60: R\$ 85,45

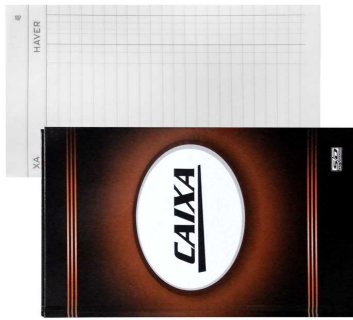

MOVIMENTO CAIXA 1/4 CD 100 F 154X216 5X1

Código: Fábrika: Unidade:
3381 SAO DOMINGOS PT/5
F1 F4

UN: R\$ 0,95 AV: R\$ 9,47 15: R\$ 9,67
30: R\$ 9,87 45: R\$ 10,06 60: R\$ 10,26

13cm

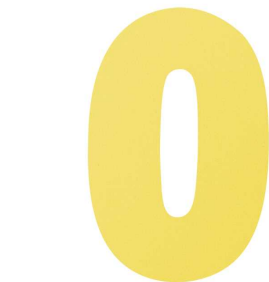

NUMEROS EVA 13CM 0 AMARELO 10X1

Código: Fábrika: Unidade:
38866 BRASILPAPERS PT/10
F1 F4

UN: R\$ 0,95 AV: R\$ 9,47 15: R\$ 9,67
30: R\$ 9,87 45: R\$ 10,06 60: R\$ 10,26

13cm

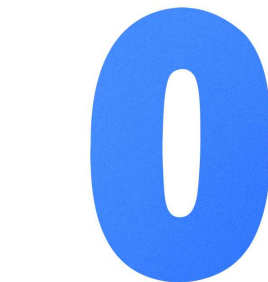

NUMEROS EVA 13CM 0 AZUL 10X1

Código: Fábrika: Unidade:
39054 BRASILPAPERS PT/10
F1 F4

UN: R\$ 0,95 AV: R\$ 9,47 15: R\$ 9,67
30: R\$ 9,87 45: R\$ 10,06 60: R\$ 10,26

13cm

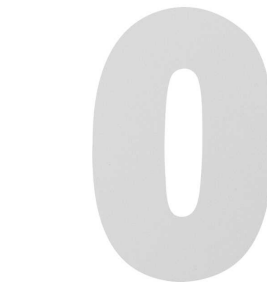

NUMEROS EVA 13CM 0 BRANCO 10X1

Código: Fábrika: Unidade:
38856 BRASILPAPERS PT/10
F1 F4

UN: R\$ 0,95 AV: R\$ 9,47 15: R\$ 9,67
30: R\$ 9,87 45: R\$ 10,06 60: R\$ 10,26
13 cm

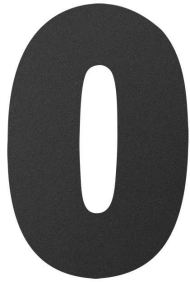

NUMEROS EVA 13CM 0 PRETO 10X1

Código: 39093 Fábrica: BRASILPAPERS Unidade: PT/10 F1 F4

UN: R\$ 0,95 AV: R\$ 9,47 15: R\$ 9,67
30: R\$ 9,87 45: R\$ 10,06 60: R\$ 10,26
13 cm

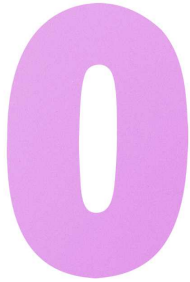

NUMEROS EVA 13CM 0 ROSA 10X1

Código: 39063 Fábrica: BRASILPAPERS Unidade: PT/10 F1 F4

UN: R\$ 0,95 AV: R\$ 9,47 15: R\$ 9,67
30: R\$ 9,87 45: R\$ 10,06 60: R\$ 10,26
13 cm

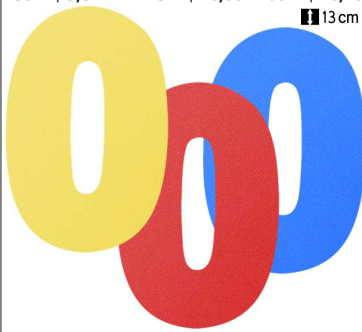

NUMEROS EVA 13CM 0 SORTIDO 10X1

Código: 39103 Fábrica: BRASILPAPERS Unidade: PT/10 F1 F4

UN: R\$ 0,95 AV: R\$ 9,47 15: R\$ 9,67
30: R\$ 9,87 45: R\$ 10,06 60: R\$ 10,26
13 cm



NUMEROS EVA 13CM 0 VERDE 10X1

Código: 39081 Fábrica: BRASILPAPERS Unidade: PT/10 F1 F4

UN: R\$ 0,95 AV: R\$ 9,47 15: R\$ 9,67
30: R\$ 9,87 45: R\$ 10,06 60: R\$ 10,26
13 cm

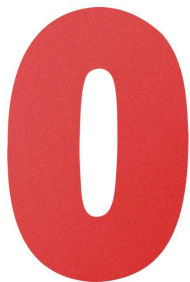

NUMEROS EVA 13CM 0 VERMELHO 10X1

Código: 39073 Fábrica: BRASILPAPERS Unidade: PT/10 F1 F4

UN: R\$ 0,95 AV: R\$ 9,47 15: R\$ 9,67
30: R\$ 9,87 45: R\$ 10,06 60: R\$ 10,26
13 cm



NUMEROS EVA 13CM 1 AMARELO 10X1

Código: 38857 Fábrica: BRASILPAPERS Unidade: PT/10 F1 F4

UN: R\$ 0,95 AV: R\$ 9,47 15: R\$ 9,67
30: R\$ 9,87 45: R\$ 10,06 60: R\$ 10,26
13 cm



NUMEROS EVA 13CM 1 AZUL 10X1

Código: 38868 Fábrica: BRASILPAPERS Unidade: PT/10 F1 F4

UN: R\$ 0,95 AV: R\$ 9,47 15: R\$ 9,67
30: R\$ 9,87 45: R\$ 10,06 60: R\$ 10,26
13 cm



NUMEROS EVA 13CM 1 BRANCO 10X1

Código: 38848 Fábrica: BRASILPAPERS Unidade: PT/10 F1 F4

UN: R\$ 0,95 AV: R\$ 9,47 15: R\$ 9,67
30: R\$ 9,87 45: R\$ 10,06 60: R\$ 10,26
13 cm

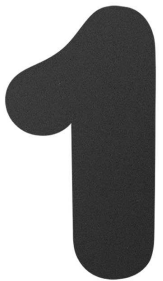

NUMEROS EVA 13CM 1 PRETO 10X1

Código: 39084 Fábrica: BRASILPAPERS Unidade: PT/10 F1 F4

UN: R\$ 0,95 AV: R\$ 9,47 15: R\$ 9,67
30: R\$ 9,87 45: R\$ 10,06 60: R\$ 10,26
13 cm



NUMEROS EVA 13CM 1 ROSA 10X1

Código: 38867 Fábrica: BRASILPAPERS Unidade: PT/10 F1 F4

UN: R\$ 0,95 AV: R\$ 9,47 15: R\$ 9,67
30: R\$ 9,87 45: R\$ 10,06 60: R\$ 10,26
13 cm



NUMEROS EVA 13CM 1 SORTIDO 10X1

Código: 39094 Fábrica: BRASILPAPERS Unidade: PT/10 F1 F4

UN: R\$ 0,95 AV: R\$ 9,47 15: R\$ 9,67
30: R\$ 9,87 45: R\$ 10,06 60: R\$ 10,26
13 cm



NUMEROS EVA 13CM 1 VERDE 10X1

Código: 39074 Fábrica: BRASILPAPERS Unidade: PT/10 F1 F4

UN: R\$ 0,95 AV: R\$ 9,47 15: R\$ 9,67
30: R\$ 9,87 45: R\$ 10,06 60: R\$ 10,26
13 cm

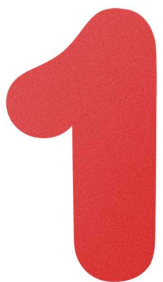

NUMEROS EVA 13CM 1 VERMELHO 10X1

Código: 39064 Fábrica: BRASILPAPERS Unidade: PT/10 F1 F4

UN: R\$ 0,95 AV: R\$ 9,47 15: R\$ 9,67
30: R\$ 9,87 45: R\$ 10,06 60: R\$ 10,26
13 cm



NUMEROS EVA 13CM 2 AMARELO 10X1

Código: 38858 Fábrica: BRASILPAPERS Unidade: PT/10 F1 F4

UN: R\$ 0,95 AV: R\$ 9,47 15: R\$ 9,67
30: R\$ 9,87 45: R\$ 10,06 60: R\$ 10,26
13 cm



NUMEROS EVA 13CM 2 AZUL 10X1

Código: 38869 Fábrica: BRASILPAPERS Unidade: PT/10 F1 F4

UN: R\$ 0,95 AV: R\$ 9,47 15: R\$ 9,67
30: R\$ 9,87 45: R\$ 10,06 60: R\$ 10,26
13 cm



NUMEROS EVA 13CM 2 BRANCO 10X1

Código: 38849 Fábrica: BRASILPAPERS Unidade: PT/10 F1 F4

UN: R\$ 0,95 AV: R\$ 9,47 15: R\$ 9,67
30: R\$ 9,87 45: R\$ 10,06 60: R\$ 10,26
13 cm



NUMEROS EVA 13CM 2 PRETO 10X1

Código: 39085 Fábrica: BRASILPAPERS Unidade: PT/10 F1 F4

UN: R\$ 0,95 AV: R\$ 9,47 15: R\$ 9,67
30: R\$ 9,87 45: R\$ 10,06 60: R\$ 10,26
13 cm



NUMEROS EVA 13CM 2 ROSA 10X1

Código: 39055 Fábrica: BRASILPAPERS Unidade: PT/10 F1 F4

UN: R\$ 0,95 AV: R\$ 9,47 15: R\$ 9,67
30: R\$ 9,87 45: R\$ 10,06 60: R\$ 10,26
13 cm

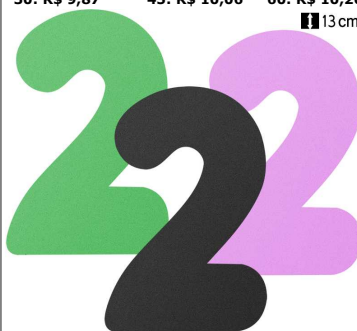

NUMEROS EVA 13CM 2 SORTIDO 10X1

Código: 39096 Fábrica: BRASILPAPERS Unidade: PT/10 F1 F4

UN: R\$ 0,95 AV: R\$ 9,47 15: R\$ 9,67
30: R\$ 9,87 45: R\$ 10,06 60: R\$ 10,26
13 cm



NUMEROS EVA 13CM 2 VERDE 10X1

Código: 39075 Fábrica: BRASILPAPERS Unidade: PT/10 F1 F4

UN: R\$ 0,95 AV: R\$ 9,47 15: R\$ 9,67
30: R\$ 9,87 45: R\$ 10,06 60: R\$ 10,26
13 cm



NUMEROS EVA 13CM 2 VERMELHO 10X1

Código: 39065 Fábrica: BRASILPAPERS Unidade: PT/10 F1 F4

UN: R\$ 0,95 AV: R\$ 9,47 15: R\$ 9,67
30: R\$ 9,87 45: R\$ 10,06 60: R\$ 10,26
13 cm



NUMEROS EVA 13CM 3 AMARELO 10X1

Código: 38859 Fábrica: BRASILPAPERS Unidade: PT/10 F1 F4

UN: R\$ 0,95 AV: R\$ 9,47 15: R\$ 9,67
30: R\$ 9,87 45: R\$ 10,06 60: R\$ 10,26
13 cm



NUMEROS EVA 13CM 3 AZUL 10X1

Código: 38870 Fábrica: BRASILPAPERS Unidade: PT/10 F1 F4

UN: R\$ 0,95 AV: R\$ 9,47 15: R\$ 9,67
30: R\$ 9,87 45: R\$ 10,06 60: R\$ 10,26
13 cm



NUMEROS EVA 13CM 3 BRANCO 10X1

Código: 38850 Fábrica: BRASILPAPERS Unidade: PT/10 F1 F4

UN: R\$ 0,95 AV: R\$ 9,47 15: R\$ 9,67
30: R\$ 9,87 45: R\$ 10,06 60: R\$ 10,26
13 cm



NUMEROS EVA 13CM 3 PRETO 10X1

Código: 39086 Fábrica: BRASILPAPERS Unidade: PT/10 F1 F4

UN: R\$ 0,95 AV: R\$ 9,47 15: R\$ 9,67
30: R\$ 9,87 45: R\$ 10,06 60: R\$ 10,26
13 cm



NUMEROS EVA 13CM 3 ROSA 10X1

Código: 39056 Fábrica: BRASILPAPERS Unidade: PT/10 F1 F4

UN: R\$ 0,95 AV: R\$ 9,47 15: R\$ 9,67
30: R\$ 9,87 45: R\$ 10,06 60: R\$ 10,26
13 cm

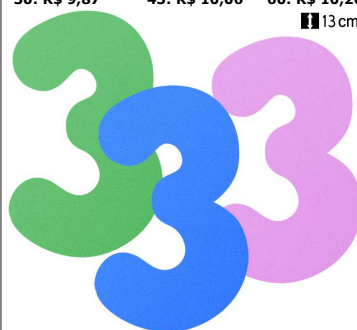

NUMEROS EVA 13CM 3 SORTIDO 10X1

Código: 39097 Fábrica: BRASILPAPERS Unidade: PT/10 F1 F4

UN: R\$ 0,95 AV: R\$ 9,47 15: R\$ 9,67
30: R\$ 9,87 45: R\$ 10,06 60: R\$ 10,26
13 cm



NUMEROS EVA 13CM 3 VERDE 10X1

Código: 39076 Fábrica: BRASILPAPERS Unidade: PT/10 F1 F4

UN: R\$ 0,95 AV: R\$ 9,47 15: R\$ 9,67
30: R\$ 9,87 45: R\$ 10,06 60: R\$ 10,26
13 cm



NUMEROS EVA 13CM 3 VERMELHO 10X1

Código: 39066 Fábrica: BRASILPAPERS Unidade: PT/10 F1 F4

UN: R\$ 0,95 AV: R\$ 9,47 15: R\$ 9,67
30: R\$ 9,87 45: R\$ 10,06 60: R\$ 10,26
13 cm



NUMEROS EVA 13CM 4 AMARELO 10X1

Código: 38860 Fábrica: BRASILPAPERS Unidade: PT/10 F1 F4

UN: R\$ 0,95 AV: R\$ 9,47 15: R\$ 9,67
30: R\$ 9,87 45: R\$ 10,06 60: R\$ 10,26
13 cm



NUMEROS EVA 13CM 4 AZUL 10X1

Código: 38871 Fábrica: BRASILPAPERS Unidade: PT/10 F1 F4

UN: R\$ 0,95 AV: R\$ 9,47 15: R\$ 9,67
30: R\$ 9,87 45: R\$ 10,06 60: R\$ 10,26
13 cm



NUMEROS EVA 13CM 4 BRANCO 10X1

Código: 38851 Fábrica: BRASILPAPERS Unidade: PT/10 F1 F4

UN: R\$ 0,95 AV: R\$ 9,47 15: R\$ 9,67
30: R\$ 9,87 45: R\$ 10,06 60: R\$ 10,26
13 cm



NUMEROS EVA 13CM 4 PRETO 10X1

Código: 39087 Fábrica: BRASILPAPERS Unidade: PT/10 F1 F4

UN: R\$ 0,95 AV: R\$ 9,47 15: R\$ 9,67
30: R\$ 9,87 45: R\$ 10,06 60: R\$ 10,26
13 cm

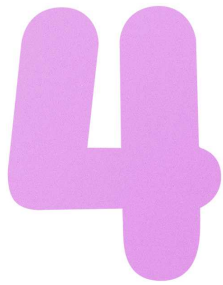

NUMEROS EVA 13CM 4 ROSA 10X1

Código: 39057 Fábrica: BRASILPAPERS Unidade: PT/10 F1 F4

UN: R\$ 0,95 AV: R\$ 9,47 15: R\$ 9,67
30: R\$ 9,87 45: R\$ 10,06 60: R\$ 10,26
13 cm

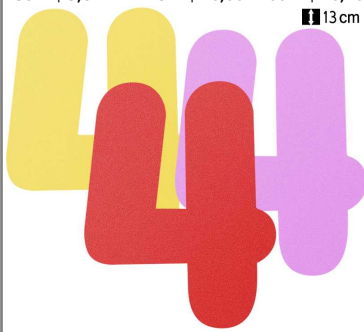

NUMEROS EVA 13CM 4 SORTIDO 10X1

Código: 39095 Fábrica: BRASILPAPERS Unidade: PT/10 F1 F4

UN: R\$ 0,95 AV: R\$ 9,47 15: R\$ 9,67
30: R\$ 9,87 45: R\$ 10,06 60: R\$ 10,26
13 cm

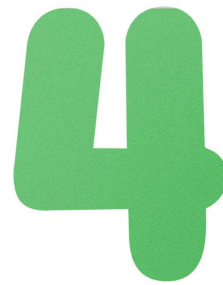

NUMEROS EVA 13CM 4 VERDE 10X1

Código: 39077 Fábrica: BRASILPAPERS Unidade: PT/10 F1 F4

UN: R\$ 0,95 AV: R\$ 9,47 15: R\$ 9,67
30: R\$ 9,87 45: R\$ 10,06 60: R\$ 10,26
13 cm

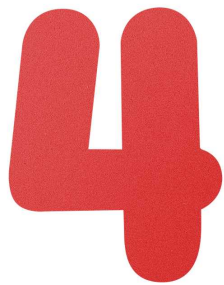

NUMEROS EVA 13CM 4 VERMELHO 10X1

Código: 39067 Fábrica: BRASILPAPERS Unidade: PT/10 F1 F4

UN: R\$ 0,95 AV: R\$ 9,47 15: R\$ 9,67
30: R\$ 9,87 45: R\$ 10,06 60: R\$ 10,26
13 cm



NUMEROS EVA 13CM 5 AMARELO 10X1

Código: 38861 Fábrica: BRASILPAPERS Unidade: PT/10 F1 F4

UN: R\$ 0,95 AV: R\$ 9,47 15: R\$ 9,67
30: R\$ 9,87 45: R\$ 10,06 60: R\$ 10,26
13 cm



NUMEROS EVA 13CM 5 AZUL 10X1

Código: 38872 Fábrica: BRASILPAPERS Unidade: PT/10 F1 F4

UN: R\$ 0,95 AV: R\$ 9,47 15: R\$ 9,67
30: R\$ 9,87 45: R\$ 10,06 60: R\$ 10,26
13 cm



NUMEROS EVA 13CM 5 BRANCO 10X1

Código: 38877 Fábrica: BRASILPAPERS Unidade: PT/10 F1 F4

UN: R\$ 0,95 AV: R\$ 9,47 15: R\$ 9,67
30: R\$ 9,87 45: R\$ 10,06 60: R\$ 10,26
13 cm



NUMEROS EVA 13CM 5 PRETO 10X1

Código: 39088 Fábrica: BRASILPAPERS Unidade: PT/10 F1 F4

UN: R\$ 0,95 AV: R\$ 9,47 15: R\$ 9,67
30: R\$ 9,87 45: R\$ 10,06 60: R\$ 10,26
13 cm



NUMEROS EVA 13CM 5 ROSA 10X1

Código: 39058 Fábrica: BRASILPAPERS Unidade: PT/10 F1 F4

UN: R\$ 0,95 AV: R\$ 9,47 15: R\$ 9,67
30: R\$ 9,87 45: R\$ 10,06 60: R\$ 10,26
13 cm



NUMEROS EVA 13CM 5 SORTIDO 10X1

Código: 39098 Fábrica: BRASILPAPERS Unidade: PT/10 F1 F4

UN: R\$ 0,95 AV: R\$ 9,47 15: R\$ 9,67
30: R\$ 9,87 45: R\$ 10,06 60: R\$ 10,26
13 cm



NUMEROS EVA 13CM 5 VERDE 10X1

Código: 39078 Fábrica: BRASILPAPERS Unidade: PT/10 F1 F4

UN: R\$ 0,95 AV: R\$ 9,47 15: R\$ 9,67
30: R\$ 9,87 45: R\$ 10,06 60: R\$ 10,26
13 cm



NUMEROS EVA 13CM 5 VERMELHO 10X1

Código: 39068 Fábrica: BRASILPAPERS Unidade: PT/10 F1 F4

UN: R\$ 0,95 AV: R\$ 9,47 15: R\$ 9,67
30: R\$ 9,87 45: R\$ 10,06 60: R\$ 10,26
13 cm



NUMEROS EVA 13CM 6 AMARELO 10X1

Código: 38862 Fábrica: BRASILPAPERS Unidade: PT/10 F1 F4

UN: R\$ 0,95 AV: R\$ 9,47 15: R\$ 9,67
30: R\$ 9,87 45: R\$ 10,06 60: R\$ 10,26
13 cm



NUMEROS EVA 13CM 6 AZUL 10X1

Código: 38873 Fábrica: BRASILPAPERS Unidade: PT/10 F1 F4

UN: R\$ 0,95 AV: R\$ 9,47 15: R\$ 9,67
30: R\$ 9,87 45: R\$ 10,06 60: R\$ 10,26
13 cm



NUMEROS EVA 13CM 6 BRANCO 10X1

Código: 38852 Fábrica: BRASILPAPERS Unidade: PT/10 F1 F4

UN: R\$ 0,95 AV: R\$ 9,47 15: R\$ 9,67
30: R\$ 9,87 45: R\$ 10,06 60: R\$ 10,26
13 cm



NUMEROS EVA 13CM 6 PRETO 10X1

Código: 39089 Fábrica: BRASILPAPERS Unidade: PT/10 F1 F4

UN: R\$ 0,95 AV: R\$ 9,47 15: R\$ 9,67
30: R\$ 9,87 45: R\$ 10,06 60: R\$ 10,26
13 cm



NUMEROS EVA 13CM 6 ROSA 10X1

Código: 39059 Fábrica: BRASILPAPERS Unidade: PT/10 F1 F4

UN: R\$ 0,95 AV: R\$ 9,47 15: R\$ 9,67
30: R\$ 9,87 45: R\$ 10,06 60: R\$ 10,26
13 cm



NUMEROS EVA 13CM 6 SORTIDO 10X1

Código: 39099 Fábrica: BRASILPAPERS Unidade: PT/10 F1 F4

UN: R\$ 0,95 AV: R\$ 9,47 15: R\$ 9,67
30: R\$ 9,87 45: R\$ 10,06 60: R\$ 10,26
13 cm



NUMEROS EVA 13CM 6 VERDE 10X1

Código: 39079 Fábrica: BRASILPAPERS Unidade: PT/10 F1 F4

UN: R\$ 0,95 AV: R\$ 9,47 15: R\$ 9,67
30: R\$ 9,87 45: R\$ 10,06 60: R\$ 10,26
13 cm



NUMEROS EVA 13CM 6 VERMELHO 10X1

Código: 39069 Fábrica: BRASILPAPERS Unidade: PT/10 F1 F4

UN: R\$ 0,95 AV: R\$ 9,47 15: R\$ 9,67
30: R\$ 9,87 45: R\$ 10,06 60: R\$ 10,26
13 cm



NUMEROS EVA 13CM 7 AMARELO 10X1

Código: 38863 Fábrica: BRASILPAPERS Unidade: PT/10 F1 F4

UN: R\$ 0,95 AV: R\$ 9,47 15: R\$ 9,67
30: R\$ 9,87 45: R\$ 10,06 60: R\$ 10,26
13 cm



NUMEROS EVA 13CM 7 AZUL 10X1

Código: 38874 Fábrica: BRASILPAPERS Unidade: PT/10 F1 F4

UN: R\$ 0,95 AV: R\$ 9,47 15: R\$ 9,67
30: R\$ 9,87 45: R\$ 10,06 60: R\$ 10,26
13 cm



NUMEROS EVA 13CM 7 BRANCO 10X1

Código: 38853 Fábrica: BRASILPAPERS Unidade: PT/10 F1 F4

UN: R\$ 0,95 AV: R\$ 9,47 15: R\$ 9,67
30: R\$ 9,87 45: R\$ 10,06 60: R\$ 10,26
13 cm



NUMEROS EVA 13CM 7 PRETO 10X1

Código: 39090 Fábrica: BRASILPAPERS Unidade: PT/10 F1 F4

UN: R\$ 0,95 AV: R\$ 9,47 15: R\$ 9,67
30: R\$ 9,87 45: R\$ 10,06 60: R\$ 10,26
13 cm



NUMEROS EVA 13CM 7 ROSA 10X1

Código: 39060 Fábrica: BRASILPAPERS Unidade: PT/10 F1 F4

UN: R\$ 0,95 AV: R\$ 9,47 15: R\$ 9,67
30: R\$ 9,87 45: R\$ 10,06 60: R\$ 10,26
13 cm



NUMEROS EVA 13CM 7 SORTIDO 10X1

Código: 39100 Fábrica: BRASILPAPERS Unidade: PT/10 F1 F4

UN: R\$ 0,95 AV: R\$ 9,47 15: R\$ 9,67
30: R\$ 9,87 45: R\$ 10,06 60: R\$ 10,26
13 cm



NUMEROS EVA 13CM 7 VERDE 10X1

Código: 39080 Fábrica: BRASILPAPERS Unidade: PT/10 F1 F4

UN: R\$ 0,95 AV: R\$ 9,47 15: R\$ 9,67
30: R\$ 9,87 45: R\$ 10,06 60: R\$ 10,26
13 cm



NUMEROS EVA 13CM 7 VERMELHO 10X1

Código: 39070 Fábrica: BRASILPAPERS Unidade: PT/10 F1 F4

UN: R\$ 0,95 AV: R\$ 9,47 15: R\$ 9,67
30: R\$ 9,87 45: R\$ 10,06 60: R\$ 10,26
13 cm



NUMEROS EVA 13CM 8 AMARELO 10X1

Código: 38864 Fábrica: BRASILPAPERS Unidade: PT/10 F1 F4

UN: R\$ 0,95 AV: R\$ 9,47 15: R\$ 9,67
30: R\$ 9,87 45: R\$ 10,06 60: R\$ 10,26
13 cm



NUMEROS EVA 13CM 8 AZUL 10X1

Código: 38875 Fábrica: BRASILPAPERS Unidade: PT/10 F1 F4

UN: R\$ 0,95 AV: R\$ 9,47 15: R\$ 9,67
30: R\$ 9,87 45: R\$ 10,06 60: R\$ 10,26
13 cm



NUMEROS EVA 13CM 8 BRANCO 10X1

Código: 38854 Fábrica: BRASILPAPERS Unidade: PT/10 F1 F4

UN: R\$ 0,95 AV: R\$ 9,47 15: R\$ 9,67
30: R\$ 9,87 45: R\$ 10,06 60: R\$ 10,26
13 cm



NUMEROS EVA 13CM 8 PRETO 10X1

Código: 39091 Fábrica: BRASPAPERS Unidade: PT/10 F1 F4

UN: R\$ 0,95 AV: R\$ 9,47 15: R\$ 9,67
30: R\$ 9,87 45: R\$ 10,06 60: R\$ 10,26
13 cm



NUMEROS EVA 13CM 8 ROSA 10X1

Código: 39061 Fábrica: BRASPAPERS Unidade: PT/10 F1 F4

UN: R\$ 0,95 AV: R\$ 9,47 15: R\$ 9,67
30: R\$ 9,87 45: R\$ 10,06 60: R\$ 10,26
13 cm

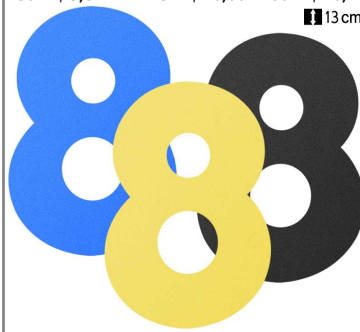

NUMEROS EVA 13CM 8 SORTIDO 10X1

Código: 39101 Fábrica: BRASPAPERS Unidade: PT/10 F1 F4

UN: R\$ 0,95 AV: R\$ 9,47 15: R\$ 9,67
30: R\$ 9,87 45: R\$ 10,06 60: R\$ 10,26
13 cm



NUMEROS EVA 13CM 8 VERDE 10X1

Código: 39082 Fábrica: BRASPAPERS Unidade: PT/10 F1 F4

UN: R\$ 0,95 AV: R\$ 9,47 15: R\$ 9,67
30: R\$ 9,87 45: R\$ 10,06 60: R\$ 10,26
13 cm



NUMEROS EVA 13CM 8 VERMELHO 10X1

Código: 39071 Fábrica: BRASPAPERS Unidade: PT/10 F1 F4

UN: R\$ 0,95 AV: R\$ 9,47 15: R\$ 9,67
30: R\$ 9,87 45: R\$ 10,06 60: R\$ 10,26
13 cm



NUMEROS EVA 13CM 9 AMARELO 10X1

Código: 38865 Fábrica: BRASPAPERS Unidade: PT/10 F1 F4

UN: R\$ 0,95 AV: R\$ 9,47 15: R\$ 9,67
30: R\$ 9,87 45: R\$ 10,06 60: R\$ 10,26
13 cm



NUMEROS EVA 13CM 9 AZUL 10X1

Código: 38876 Fábrica: BRASPAPERS Unidade: PT/10 F1 F4

UN: R\$ 0,95 AV: R\$ 9,47 15: R\$ 9,67
30: R\$ 9,87 45: R\$ 10,06 60: R\$ 10,26
13 cm



NUMEROS EVA 13CM 9 BRANCO 10X1

Código: 38855 Fábrica: BRASPAPERS Unidade: PT/10 F1 F4

UN: R\$ 0,95 AV: R\$ 9,47 15: R\$ 9,67
30: R\$ 9,87 45: R\$ 10,06 60: R\$ 10,26
13 cm



NUMEROS EVA 13CM 9 PRETO 10X1

Código: 39092 Fábrica: BRASPAPERS Unidade: PT/10 F1 F4

UN: R\$ 0,95 AV: R\$ 9,47 15: R\$ 9,67
30: R\$ 9,87 45: R\$ 10,06 60: R\$ 10,26
13 cm



NUMEROS EVA 13CM 9 ROSA 10X1

Código: 39062 Fábrica: BRASPAPERS Unidade: PT/10 F1 F4

UN: R\$ 0,95 AV: R\$ 9,47 15: R\$ 9,67
30: R\$ 9,87 45: R\$ 10,06 60: R\$ 10,26
13 cm

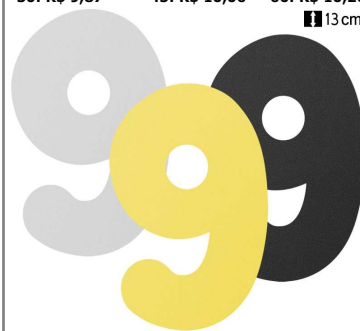

NUMEROS EVA 13CM 9 SORTIDO 10X1

Código: 39102 Fábrica: BRASPAPERS Unidade: PT/10 F1 F4

UN: R\$ 0,95 AV: R\$ 9,47 15: R\$ 9,67
30: R\$ 9,87 45: R\$ 10,06 60: R\$ 10,26
13 cm



NUMEROS EVA 13CM 9 VERDE 10X1

Código: 39083 Fábrica: BRASPAPERS Unidade: PT/10 F1 F4

UN: R\$ 0,95 AV: R\$ 9,47 15: R\$ 9,67
30: R\$ 9,87 45: R\$ 10,06 60: R\$ 10,26
13 cm



NUMEROS EVA 13CM 9 VERMELHO 10X1

Código: 39072 Fábrica: BRASPAPERS Unidade: PT/10 F1 F4

UN: R\$ 29,94 AV: R\$ 29,94 15: R\$ 30,57
30: R\$ 31,18 45: R\$ 31,80 60: R\$ 32,44



ORGANIZADOR DIAGONAL BLACK PIANO SELADO

Código: 47594 Fábrica: MAXCRIL Unidade: UN/1 F1 F4

UN: R\$ 29,94 AV: R\$ 29,94 15: R\$ 30,57
30: R\$ 31,18 45: R\$ 31,80 60: R\$ 32,44



ORGANIZADOR DIAGONAL CINZA SELADO

Código: 47593 Fábrica: MAXCRIL Unidade: UN/1 F1 F4

UN: R\$ 29,94 AV: R\$ 29,94 15: R\$ 30,57
30: R\$ 31,18 45: R\$ 31,80 60: R\$ 32,44



ORGANIZADOR DIAGONAL CRISTAL SELADO

Código: 47173 Fábrica: MAXCRIL Unidade: UN/1 F1 F4

UN: R\$ 94,84 AV: R\$ 94,84 15: R\$ 96,81
30: R\$ 98,75 45: R\$ 100,73 60: R\$ 102,74



ORGANIZADOR ESCRITORIO CRISTAL 869CR
Código: 40806 Fábrica: ACRIMET Unidade: CX/1 F1 F4

UN: R\$ 28,94 AV: R\$ 28,94 15: R\$ 29,55
30: R\$ 30,14 45: R\$ 30,74 60: R\$ 31,36



ORGANIZADOR MESA ACR PTO PORTA FITA 681
Código: 43220 Fábrica: ACRINIL Unidade: UN/1 F1 F4

UN: R\$ 36,93 AV: R\$ 36,93 15: R\$ 37,70
30: R\$ 38,45 45: R\$ 39,22 60: R\$ 40,01



ORGANIZADOR MESA ARAMADO 3COMP QUAD 5122
Código: 44985 Fábrica: BRW Unidade: UN/1 F1 F4

UN: R\$ 12,23 AV: R\$ 12,23 15: R\$ 12,49
30: R\$ 12,73 45: R\$ 12,99 60: R\$ 13,25



ORGANIZADOR OBJETO MOD 8,5X8,5CM CRISTAL
Código: 44682 Fábrica: MAXCRIL Unidade: UN/1 F1 F4

UN: R\$ 0,89 AV: R\$ 22,24 15: R\$ 22,71
30: R\$ 23,16 45: R\$ 23,63 60: R\$ 24,10



PALITO DENTE EMB IND 25X80
Código: 49697 Fábrica: ESTILO Unidade: PT/25 F1 F4

UN: R\$ 0,01 AV: R\$ 28,94 15: R\$ 29,55
30: R\$ 30,14 45: R\$ 30,74 60: R\$ 31,36



PALITO DENTE EMB INDIVIDUAL 2000X1
Código: 48618 Fábrica: BOMPACK Unidade: CX/2000 F1 F4

UN: R\$ 0,08 AV: R\$ 8,48 15: R\$ 8,65
30: R\$ 8,83 45: R\$ 9,00 60: R\$ 9,18



PALITO P/PICOLE COLORIDO AMARELO 100X1
Código: 39169 Fábrica: COPLAMIX Unidade: PT/100 F1 F4

UN: R\$ 0,08 AV: R\$ 8,48 15: R\$ 8,65
30: R\$ 8,83 45: R\$ 9,00 60: R\$ 9,18



PALITO P/PICOLE COLORIDO AZUL 100X1
Código: 39168 Fábrica: COPLAMIX Unidade: PT/100 F1 F4

UN: R\$ 0,08 AV: R\$ 8,48 15: R\$ 8,65
30: R\$ 8,83 45: R\$ 9,00 60: R\$ 9,18



PALITO P/PICOLE COLORIDO VERDE 100X1
Código: 39170 Fábrica: COPLAMIX Unidade: PT/100 F1 F4

UN: R\$ 0,08 AV: R\$ 8,48 15: R\$ 8,65
30: R\$ 8,83 45: R\$ 9,00 60: R\$ 9,18



PALITO P/PICOLE COLORIDO VERMELHO 100X1
Código: 39171 Fábrica: COPLAMIX Unidade: PT/100 F1 F4

UN: R\$ 0,04 AV: R\$ 3,98 15: R\$ 4,07
30: R\$ 4,15 45: R\$ 4,23 60: R\$ 4,32



PALITO P/PICOLE QUAD 51070 100X1
Código: 27864 Fábrica: THEOTO Unidade: PT/100 F1 F4

UN: R\$ 332,47 AV: R\$ 332,47 15: R\$ 339,39
30: R\$ 346,18 45: R\$ 353,11 60: R\$ 360,17



PALITO P/PICOLE QUAD 51070 10000X1
Código: 41176 Fábrica: THEOTO Unidade: CX/1 F1 F4

UN: R\$ 0,06 AV: R\$ 5,62 15: R\$ 5,74
30: R\$ 5,85 45: R\$ 5,97 60: R\$ 6,09



PALITO P/PICOLE QUADR 100X1
Código: 49695 Fábrica: ESTILO Unidade: PT/100 F1 F4

UN: R\$ 0,11 AV: R\$ 10,97 15: R\$ 11,20
30: R\$ 11,43 45: R\$ 11,65 60: R\$ 11,89



PALITO P/PICOLE RED COLORIDO SORT 100X1
Código: 30261 Fábrica: THEOTO Unidade: PT/100 F1 F4

UN: R\$ 423,28 AV: R\$ 423,28 15: R\$ 432,10
30: R\$ 440,74 45: R\$ 449,56 60: R\$ 458,55



PALITO P/PICOLE RED 10000X1
Código: 49696 Fábrica: ESTILO Unidade: CX/1 F1 F4

UN: R\$ 0,06 AV: R\$ 5,98 15: R\$ 6,11
30: R\$ 6,23 45: R\$ 6,35 60: R\$ 6,48



PALITO P/PICOLE RED 51021 100X1
Código: 41144 Fábrica: THEOTO Unidade: PT/100 F1 F4

UN: R\$ 499,10 AV: R\$ 499,10 15: R\$ 509,50
30: R\$ 519,69 45: R\$ 530,08 60: R\$ 540,68



PALITO P/PICOLE RED 51021 10000X1

Código: Fábrica: Unidade:
41177 THEOTO CX/1
F1 F4

UN: R\$ 0,05 AV: R\$ 49,91 15: R\$ 50,95
30: R\$ 51,97 45: R\$ 53,01 60: R\$ 54,07



PALITO P/PICOLE 1000X1

Código: Fábrica: Unidade:
20231 PINHEIRO PT/1000
F1 F4

UN: R\$ 0,07 AV: R\$ 6,98 15: R\$ 7,12
30: R\$ 7,27 45: R\$ 7,41 60: R\$ 7,56



PALITO P/SORVETE 100X1

Código: Fábrica: Unidade:
42269 ESTILO PT/100
F1 F4

UN: R\$ 0,11 AV: R\$ 10,63 15: R\$ 10,85
30: R\$ 11,07 45: R\$ 11,29 60: R\$ 11,52



PALITO RED ABAIXADOR LINGUA 100X1

Código: Fábrica: Unidade:
47881 THEOTO PT/100
F1 F4

UN: R\$ 0,20 AV: R\$ 9,88 15: R\$ 10,09
30: R\$ 10,29 45: R\$ 10,50 60: R\$ 10,71



PANFLETO ALUGA-SE 50X1

Código: Fábrica: Unidade:
11440 QDAL PT/50
F1 F4

UN: R\$ 0,20 AV: R\$ 9,88 15: R\$ 10,09
30: R\$ 10,29 45: R\$ 10,50 60: R\$ 10,71



PANFLETO EXTINTOR DE INCENDIO 50X1

Código: Fábrica: Unidade:
33344 QDAL PT/50
F4

UN: R\$ 0,20 AV: R\$ 9,88 15: R\$ 10,09
30: R\$ 10,29 45: R\$ 10,50 60: R\$ 10,71



PANFLETO NAO VENDEMOS FIADO 50X1

Código: Fábrica: Unidade:
31063 QDAL PT/50
F4

UN: R\$ 0,20 AV: R\$ 9,88 15: R\$ 10,09
30: R\$ 10,29 45: R\$ 10,50 60: R\$ 10,71



PANFLETO USO OGRIGATORIO DE MASCARA 50X1

Código: Fábrica: Unidade:
38996 QDAL PT/50
F4

UN: R\$ 0,20 AV: R\$ 9,88 15: R\$ 10,09
30: R\$ 10,29 45: R\$ 10,50 60: R\$ 10,71



PANFLETO VENDE-SE 50X1

Código: Fábrica: Unidade:
11439 QDAL PT/50
F1 F4

UN: R\$ 3,39 AV: R\$ 33,94 15: R\$ 34,64
30: R\$ 35,34 45: R\$ 36,04 60: R\$ 36,76

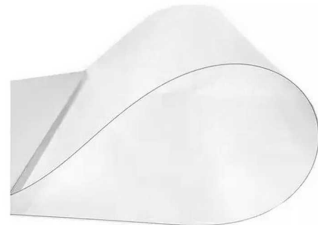

PAPEL ACETATO A3 TRANSP 10UN

Código: Fábrica: Unidade:
50169 MP PT/10
F1 F4

UN: R\$ 0,12 AV: R\$ 11,97 15: R\$ 12,22
30: R\$ 12,46 45: R\$ 12,71 60: R\$ 12,97

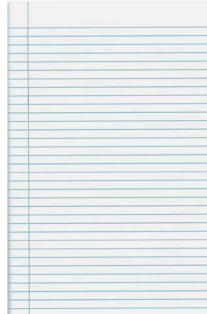

PAPEL ALMACO C/ PAUTA 100X1

Código: Fábrica: Unidade:
36680 MAXIMA PT/100
F1 F4

UN: R\$ 0,10 AV: R\$ 41,93 15: R\$ 42,81
30: R\$ 43,66 45: R\$ 44,54 60: R\$ 45,43



PAPEL ALMACO C/ PAUTA 400X1

Código: Fábrica: Unidade:
6427 MAXIMA/PGBRA PT/400
F1 F4

UN: R\$ 0,12 AV: R\$ 11,97 15: R\$ 12,22
30: R\$ 12,46 45: R\$ 12,71 60: R\$ 12,97



PAPEL ALMACO S/ PAUTA 100X1

Código: Fábrica: Unidade:
20378 MAXIMA PT/100
F1 F4

UN: R\$ 0,10 AV: R\$ 41,93 15: R\$ 42,81
30: R\$ 43,66 45: R\$ 44,54 60: R\$ 45,43



PAPEL ALMACO S/ PAUTA 400X1

Código: Fábrica: Unidade:
36679 MAXIMA/PGBRA PT/400
F1 F4

UN: R\$ 0,36 AV: R\$ 17,96 15: R\$ 18,34
30: R\$ 18,70 45: R\$ 19,08 60: R\$ 19,46



PAPEL ANTILOPE A4 180GR BRANCO 50X1

Código: Fábrica: Unidade:
45587 BRATA/OFFPAP PT/50
F1 F4

UN: R\$ 1,00 AV: R\$ 49,91 15: R\$ 50,95
30: R\$ 51,97 45: R\$ 53,01 60: R\$ 54,07

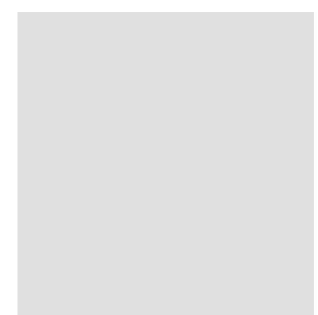

PAPEL A3 60 KG 180 GRS BRANCO 50X1

Código: Fábrica: Unidade:
37046 MINASPEL PT/50
F1 F4

UN: R\$ 0,16 AV: R\$ 15,96 15: R\$ 16,30
30: R\$ 16,62 45: R\$ 16,96 60: R\$ 17,29

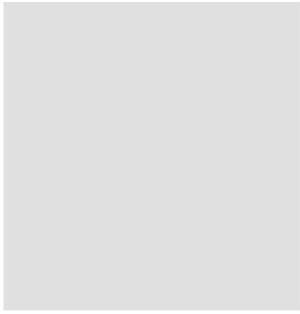

PAPEL A3 75GRS BRANCO 100X1

Código: 37074 Fábrica: MILPEL/MINAS Unidade: PT/100 F1 F4

UN: R\$ 79,86 AV: R\$ 79,86 15: R\$ 81,53
30: R\$ 83,16 45: R\$ 84,82 60: R\$ 86,52

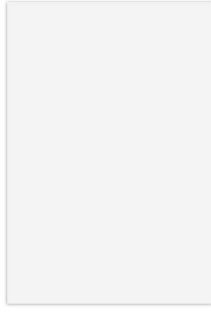

PAPEL A3 75GRS BRANCO 500X1

Código: 46994 Fábrica: MILPEL Unidade: PT/1 F1 F4

UN: R\$ 9,47 AV: R\$ 9,47 15: R\$ 9,67
30: R\$ 9,87 45: R\$ 10,06 60: R\$ 10,26

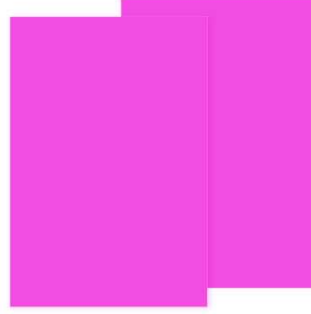

PAPEL A4 70GR CREME 210X297MM 100X1

Código: 42918 Fábrica: NEEDS Unidade: PT/1 F1 F4

UN: R\$ 9,47 AV: R\$ 9,47 15: R\$ 9,67
30: R\$ 9,87 45: R\$ 10,06 60: R\$ 10,26

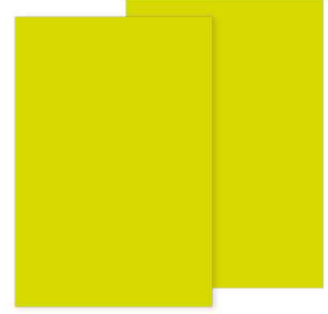

PAPEL A4 75GR AMARELO 210X297MM 100X1

Código: 9506 Fábrica: MILPEL Unidade: PT/1 F1 F4

UN: R\$ 9,47 AV: R\$ 9,47 15: R\$ 9,67
30: R\$ 9,87 45: R\$ 10,06 60: R\$ 10,26

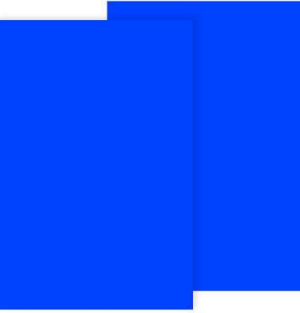

PAPEL A4 75GR AZUL 210X297MM 100X1

Código: 9505 Fábrica: MILPEL Unidade: PT/1 F1 F4

UN: R\$ 0,09 AV: R\$ 9,47 15: R\$ 9,67
30: R\$ 9,87 45: R\$ 10,06 60: R\$ 10,26

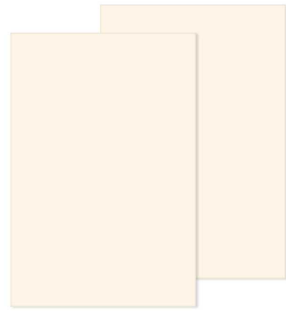

PAPEL A4 75GR CREME 210X297MM 100X1

Código: 46409 Fábrica: MINASPEL Unidade: PT/100 F1 F4

UN: R\$ 0,09 AV: R\$ 9,47 15: R\$ 9,67
30: R\$ 9,87 45: R\$ 10,06 60: R\$ 10,26



PAPEL A4 75GR LARANJA 210X297MM 100X1

Código: 46262 Fábrica: MINASPEL Unidade: PT/100 F1 F4

UN: R\$ 9,47 AV: R\$ 9,47 15: R\$ 9,67
30: R\$ 9,87 45: R\$ 10,06 60: R\$ 10,26

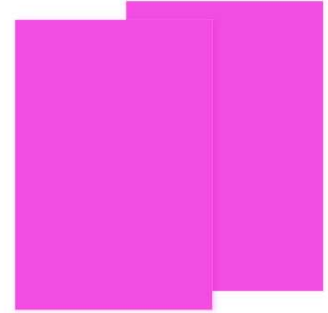

PAPEL A4 75GR ROSA 210X297MM 100X1

Código: 9507 Fábrica: MILPEL Unidade: PT/1 F1 F4

UN: R\$ 9,47 AV: R\$ 9,47 15: R\$ 9,67
30: R\$ 9,87 45: R\$ 10,06 60: R\$ 10,26

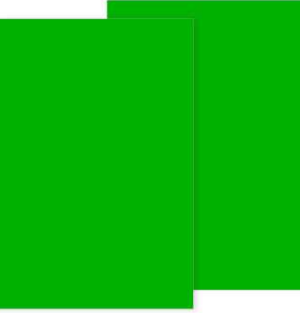

PAPEL A4 75GR VERDE 210X297MM 100X1

Código: 9508 Fábrica: MILPEL Unidade: PT/1 F1 F4

UN: R\$ 0,07 AV: R\$ 33,97 15: R\$ 33,97
30: R\$ 33,97 45: R\$ 33,97 60: R\$ 33,97



PAPEL A4 BCO 210X297MM 500 FLS

Código: 22253 Fábrica: PAPEX Unidade: PT/500 F1 F4

UN: R\$ 0,31 AV: R\$ 14,97 15: R\$ 15,28
30: R\$ 15,58 45: R\$ 15,90 60: R\$ 16,21

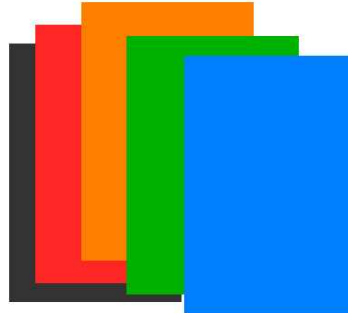

PAPEL A4 CREATIVE PAPER 48X1

Código: 7335 Fábrica: MINASPEL Unidade: PT/48 F1 F4

UN: R\$ 0,15 AV: R\$ 5,98 15: R\$ 6,11
30: R\$ 6,23 45: R\$ 6,35 60: R\$ 6,48



PAPEL A4 CRIATIVO COLOR 40X1

Código: 47716 Fábrica: REIPEL Unidade: PT/40 F1 F4

UN: R\$ 0,25 AV: R\$ 12,47 15: R\$ 12,73
30: R\$ 12,98 45: R\$ 13,24 60: R\$ 13,51



PAPEL A4 120GR 40KG BRANCO 484 50X1

Código: 34269 Fábrica: AGAPE Unidade: PT/50 F1 F4

UN: R\$ 0,38 AV: R\$ 18,96 15: R\$ 19,35
30: R\$ 19,74 45: R\$ 20,14 60: R\$ 20,54



PAPEL A4 160GR COUCHE SEMI BRILHO 50X1

Código: 45992 Fábrica: MASTERPRINT Unidade: PT/50 F1 F4

UN: R\$ 0,50 AV: R\$ 24,95 15: R\$ 25,47
30: R\$ 25,98 45: R\$ 26,50 60: R\$ 27,03



PAPEL A4 180GR MADEIRA BRANCO 50X1

Código: 45588 Fábrica: OFF PAPER Unidade: PT/50 F1 F4

UN: R\$ 0,54 AV: R\$ 26,95 15: R\$ 27,51
30: R\$ 28,06 45: R\$ 28,62 60: R\$ 29,19



PAPEL A4 180GR MADEIRA PALHA 50X1

Código: 45887 Fábrica: OFF PAPER Unidade: PT/50 F1 F4

UN: R\$ 0,36 AV: R\$ 17,96 15: R\$ 18,34
30: R\$ 18,70 45: R\$ 19,08 60: R\$ 19,46



PAPEL A4 180GR PERSICO BRANCO 50X1
Código: Fábrica: Unidade:
46046 USAPEL PT/50
F1 F4

UN: R\$ 0,34 AV: R\$ 16,96 15: R\$ 17,32
30: R\$ 17,66 45: R\$ 18,02 60: R\$ 18,38



PAPEL A4 180GR 60KG BRANCO 486 50X1
Código: Fábrica: Unidade:
30962 MINAS/MILPEL PT/50
F1 F4

UN: R\$ 0,19 AV: R\$ 18,96 15: R\$ 19,35
30: R\$ 19,74 45: R\$ 20,14 60: R\$ 20,54



PAPEL A4 200GR COUCHE FOSCO 100X1
Código: Fábrica: Unidade:
49064 MASTERPRINT PT/100
F1 F4

UN: R\$ 0,47 AV: R\$ 23,61 15: R\$ 24,10
30: R\$ 24,59 45: R\$ 25,08 60: R\$ 25,58



PAPEL A4 200GR COUCHE IMP LASER 96 50X1
Código: Fábrica: Unidade:
51061 MASTERPRINT PT/50
F1 F4

UN: R\$ 10,48 AV: R\$ 10,48 15: R\$ 10,70
30: R\$ 10,92 45: R\$ 11,13 60: R\$ 11,36



PAPEL A4 75GR 8 CORES 210X297MM 45X1
Código: Fábrica: Unidade:
49278 MASTERPRINT PT/1
F1 F4

UN: R\$ 1,30 AV: R\$ 32,49 15: R\$ 33,16
30: R\$ 33,83 45: R\$ 34,50 60: R\$ 35,19



PAPEL CAMURCA AMARELO 40X60CM 25X1
Código: Fábrica: Unidade:
6332 ART FLOC PT/25
F1 F4

UN: R\$ 1,30 AV: R\$ 32,49 15: R\$ 33,16
30: R\$ 33,83 45: R\$ 34,50 60: R\$ 35,19



PAPEL CAMURCA AZUL CELESTE 40X60CM 25X1
Código: Fábrica: Unidade:
24958 ART FLOC PT/25
F1 F4

UN: R\$ 1,30 AV: R\$ 32,49 15: R\$ 33,16
30: R\$ 33,83 45: R\$ 34,50 60: R\$ 35,19



PAPEL CAMURCA AZUL CLARO 40X60CM 25X1
Código: Fábrica: Unidade:
6327 ART FLOC PT/25
F1 F4

UN: R\$ 1,30 AV: R\$ 32,49 15: R\$ 33,16
30: R\$ 33,83 45: R\$ 34,50 60: R\$ 35,19



PAPEL CAMURCA AZUL MARINHO 40X60CM 25X1
Código: Fábrica: Unidade:
6345 ART FLOC PT/25
F1 F4

UN: R\$ 1,30 AV: R\$ 32,49 15: R\$ 33,16
30: R\$ 33,83 45: R\$ 34,50 60: R\$ 35,19



PAPEL CAMURCA AZUL ROYAL 40X60CM 25X1
Código: Fábrica: Unidade:
6331 ART FLOC PT/25
F1 F4

UN: R\$ 1,30 AV: R\$ 32,49 15: R\$ 33,16
30: R\$ 33,83 45: R\$ 34,50 60: R\$ 35,19



PAPEL CAMURCA AZUL TURQUESA 40X60CM 25X1
Código: Fábrica: Unidade:
19804 ART FLOC PT/25
F1 F4

UN: R\$ 1,30 AV: R\$ 32,49 15: R\$ 33,16
30: R\$ 33,83 45: R\$ 34,50 60: R\$ 35,19

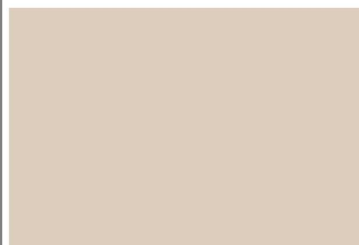

PAPEL CAMURCA BEGE 40X60CM 25X1
Código: Fábrica: Unidade:
35865 ART FLOC PT/25
F1 F4

UN: R\$ 1,30 AV: R\$ 32,49 15: R\$ 33,16
30: R\$ 33,83 45: R\$ 34,50 60: R\$ 35,19



PAPEL CAMURCA BRANCO 40X60CM 25X1
Código: Fábrica: Unidade:
4052 ART FLOC PT/25
F1 F4

UN: R\$ 1,30 AV: R\$ 32,49 15: R\$ 33,16
30: R\$ 33,83 45: R\$ 34,50 60: R\$ 35,19



PAPEL CAMURCA CINZA 40X60CM 25X1
Código: Fábrica: Unidade:
26221 ART FLOC PT/25
F1 F4

UN: R\$ 1,30 AV: R\$ 32,49 15: R\$ 33,16
30: R\$ 33,83 45: R\$ 34,50 60: R\$ 35,19



PAPEL CAMURCA GRAFITE 40X60CM 25X1
Código: Fábrica: Unidade:
16444 ART FLOC PT/25
F1 F4

UN: R\$ 1,30 AV: R\$ 32,49 15: R\$ 33,16
30: R\$ 33,83 45: R\$ 34,50 60: R\$ 35,19



PAPEL CAMURCA LARANJA 40X60CM 25X1
Código: Fábrica: Unidade:
15594 ART FLOC PT/25
F1 F4

UN: R\$ 1,30 AV: R\$ 32,49 15: R\$ 33,16
30: R\$ 33,83 45: R\$ 34,50 60: R\$ 35,19



PAPEL CAMURCA LILAS 40X60 25X1

Código: 35863 Fábrica: ART FLOC Unidade: PT/25 F1 F4

UN: R\$ 1,30 AV: R\$ 32,49 15: R\$ 33,16
30: R\$ 33,83 45: R\$ 34,50 60: R\$ 35,19



PAPEL CAMURCA MARROM 40X60CM 25X1

Código: 16445 Fábrica: ART FLOC Unidade: PT/25 F1 F4

UN: R\$ 1,30 AV: R\$ 32,49 15: R\$ 33,16
30: R\$ 33,83 45: R\$ 34,50 60: R\$ 35,19



PAPEL CAMURCA PINK 40X60CM 25X1

Código: 16446 Fábrica: ART FLOC Unidade: PT/25 F1 F4

UN: R\$ 1,30 AV: R\$ 32,49 15: R\$ 33,16
30: R\$ 33,83 45: R\$ 34,50 60: R\$ 35,19

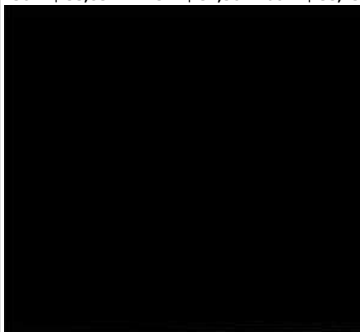

PAPEL CAMURCA PRETO 40X60CM 25X1

Código: 6333 Fábrica: ART FLOC Unidade: PT/25 F1 F4

UN: R\$ 1,30 AV: R\$ 32,49 15: R\$ 33,16
30: R\$ 33,83 45: R\$ 34,50 60: R\$ 35,19



PAPEL CAMURCA ROSA 40X60CM 25X1

Código: 15596 Fábrica: ART FLOC Unidade: PT/25 F1 F4

UN: R\$ 1,30 AV: R\$ 32,49 15: R\$ 33,16
30: R\$ 33,83 45: R\$ 34,50 60: R\$ 35,19

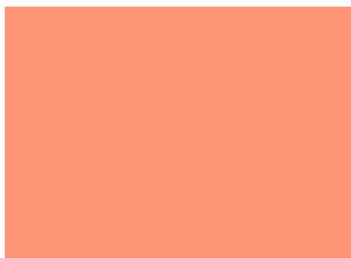

PAPEL CAMURCA SALMAO 40X60CM 25X1

Código: 6334 Fábrica: ART FLOC Unidade: PT/25 F1 F4

UN: R\$ 1,30 AV: R\$ 32,49 15: R\$ 33,16
30: R\$ 33,83 45: R\$ 34,50 60: R\$ 35,19



PAPEL CAMURCA VERDE BANDEIR 40X60CM 25X1

Código: 6326 Fábrica: ART FLOC Unidade: PT/25 F1 F4

UN: R\$ 1,30 AV: R\$ 32,49 15: R\$ 33,16
30: R\$ 33,83 45: R\$ 34,50 60: R\$ 35,19



PAPEL CAMURCA VERDE MUSGO 40X60CM 25X1

Código: 16447 Fábrica: ART FLOC Unidade: PT/25 F1 F4

UN: R\$ 1,30 AV: R\$ 32,49 15: R\$ 33,16
30: R\$ 33,83 45: R\$ 34,50 60: R\$ 35,19



PAPEL CAMURCA VERMELHO 40X60CM 25X1

Código: 6329 Fábrica: ART FLOC Unidade: PT/25 F1 F4

UN: R\$ 1,30 AV: R\$ 32,49 15: R\$ 33,16
30: R\$ 33,83 45: R\$ 34,50 60: R\$ 35,19



PAPEL CAMURCA VINHO 40X60CM 25X1

Código: 26224 Fábrica: ART FLOC Unidade: PT/25 F1 F4

UN: R\$ 1,30 AV: R\$ 32,49 15: R\$ 33,16
30: R\$ 33,83 45: R\$ 34,50 60: R\$ 35,19



PAPEL CAMURCA VIOLETA 40X60CM 25X1

Código: 35864 Fábrica: ART FLOC Unidade: PT/25 F1 F4

UN: R\$ 0,47 AV: R\$ 23,46 15: R\$ 23,95
30: R\$ 24,43 45: R\$ 24,92 60: R\$ 25,42

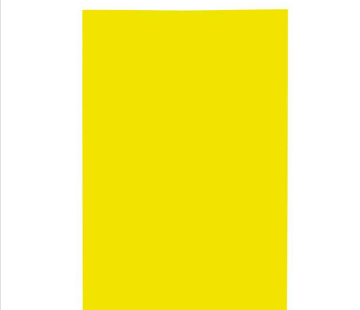

PAPEL CARTAO A4 AMARELO 50X1

Código: 48884 Fábrica: BRASILPAPERS Unidade: PT/50 F1 F4

UN: R\$ 0,47 AV: R\$ 23,46 15: R\$ 23,95
30: R\$ 24,43 45: R\$ 24,92 60: R\$ 25,42

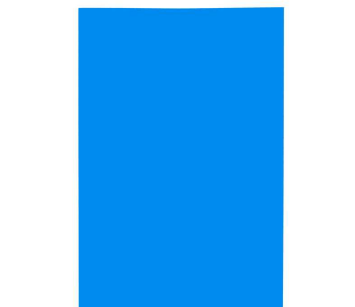

PAPEL CARTAO A4 AZUL 50X1

Código: 48885 Fábrica: BRASILPAPERS Unidade: PT/50 F1 F4

UN: R\$ 0,47 AV: R\$ 23,46 15: R\$ 23,95
30: R\$ 24,43 45: R\$ 24,92 60: R\$ 25,42

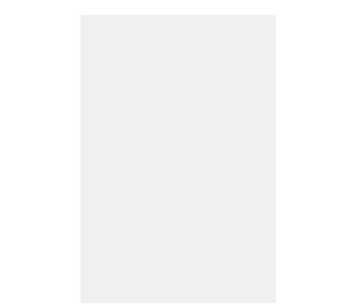

PAPEL CARTAO A4 BRANCO 50X1

Código: 50782 Fábrica: MINASPEL Unidade: PT/50 F1 F4

UN: R\$ 0,47 AV: R\$ 23,46 15: R\$ 23,95
30: R\$ 24,43 45: R\$ 24,92 60: R\$ 25,42



PAPEL CARTAO A4 LARANJA 50X1

Código: 48888 Fábrica: BRASILPAPERS Unidade: PT/50 F1 F4

UN: R\$ 0,47 AV: R\$ 23,46 15: R\$ 23,95
30: R\$ 24,43 45: R\$ 24,92 60: R\$ 25,42

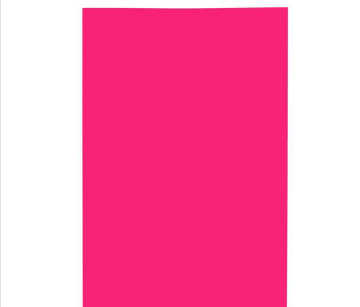

PAPEL CARTAO A4 PINK 50X1

Código: 48889 Fábrica: BRASILPAPERS Unidade: PT/50 F1 F4

UN: R\$ 0,47 AV: R\$ 23,46 15: R\$ 23,95
30: R\$ 24,43 45: R\$ 24,92 60: R\$ 25,42

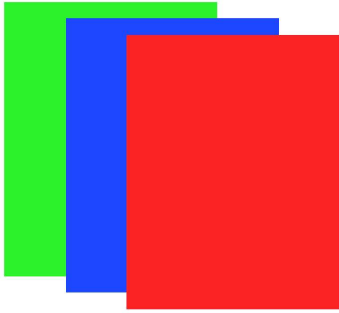

PAPEL CARTAO A4 SORT 50X1

Código: 30104 Fábrica: MINASPEL Unidade: PT/50 F1 F4

UN: R\$ 0,47 AV: R\$ 23,46 15: R\$ 23,95
30: R\$ 24,43 45: R\$ 24,92 60: R\$ 25,42



PAPEL CARTAO A4 VERDE 50X1

Código: 48887 Fábrica: BRASILPAPERS Unidade: PT/50 F1 F4

UN: R\$ 0,47 AV: R\$ 23,46 15: R\$ 23,95
30: R\$ 24,43 45: R\$ 24,92 60: R\$ 25,42



PAPEL CARTAO A4 VERMELHO 50X1

Código: 48886 Fábrica: BRASILPAPERS Unidade: PT/50 F1 F4

UN: R\$ 2,28 AV: R\$ 45,69 15: R\$ 46,64
30: R\$ 47,57 45: R\$ 48,52 60: R\$ 49,49



PAPEL CARTAO BRILHO 45X65CM AMARELO 20X1

Código: 26364 Fábrica: MINASPEL/MIL Unidade: PT/20 F1 F4

UN: R\$ 2,28 AV: R\$ 45,69 15: R\$ 46,64
30: R\$ 47,57 45: R\$ 48,52 60: R\$ 49,49



PAPEL CARTAO BRILHO 45X65CM AZUL BB 20X1

Código: 45219 Fábrica: MINASPEL Unidade: PT/20 F1 F4

UN: R\$ 2,28 AV: R\$ 45,69 15: R\$ 46,64
30: R\$ 47,57 45: R\$ 48,52 60: R\$ 49,49



PAPEL CARTAO BRILHO 45X65CM AZUL CL 20X1

Código: 26363 Fábrica: MINASPEL Unidade: PT/20 F1 F4

UN: R\$ 2,28 AV: R\$ 45,69 15: R\$ 46,64
30: R\$ 47,57 45: R\$ 48,52 60: R\$ 49,49



PAPEL CARTAO BRILHO 45X65CM AZUL ES 20X1

Código: 26365 Fábrica: MINASPEL Unidade: PT/20 F1 F4

UN: R\$ 2,28 AV: R\$ 45,69 15: R\$ 46,64
30: R\$ 47,57 45: R\$ 48,52 60: R\$ 49,49



PAPEL CARTAO BRILHO 45X65CM AZUL RO 20X1

Código: 33428 Fábrica: MINASPEL Unidade: PT/20 F1 F4

UN: R\$ 2,28 AV: R\$ 45,69 15: R\$ 46,64
30: R\$ 47,57 45: R\$ 48,52 60: R\$ 49,49

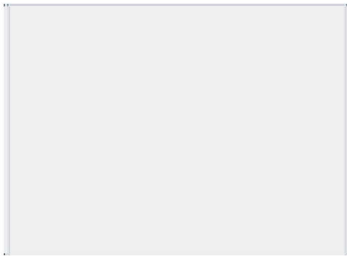

PAPEL CARTAO BRILHO 45X65CM BRANCO 20X1

Código: 26366 Fábrica: MINASPEL Unidade: PT/20 F1 F4

UN: R\$ 2,28 AV: R\$ 45,69 15: R\$ 46,64
30: R\$ 47,57 45: R\$ 48,52 60: R\$ 49,49



PAPEL CARTAO BRILHO 45X65CM LARANJA 20X1

Código: 26367 Fábrica: MINASPEL Unidade: PT/20 F1 F4

UN: R\$ 2,25 AV: R\$ 44,92 15: R\$ 45,85
30: R\$ 46,77 45: R\$ 47,71 60: R\$ 48,66



PAPEL CARTAO BRILHO 45X65CM PRATA 20X1

Código: 29043 Fábrica: LB PAPER Unidade: PT/20 F1 F4

UN: R\$ 2,28 AV: R\$ 45,69 15: R\$ 46,64
30: R\$ 47,57 45: R\$ 48,52 60: R\$ 49,49

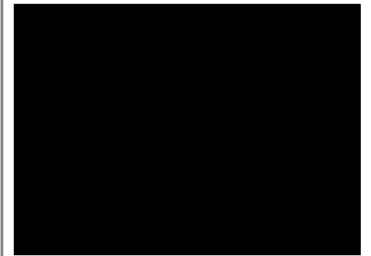

PAPEL CARTAO BRILHO 45X65CM PRETO 20X1

Código: 26368 Fábrica: MINASPEL Unidade: PT/20 F1 F4

UN: R\$ 2,28 AV: R\$ 45,69 15: R\$ 46,64
30: R\$ 47,57 45: R\$ 48,52 60: R\$ 49,49



PAPEL CARTAO BRILHO 45X65CM ROSA 20X1

Código: 26369 Fábrica: MINASPEL Unidade: PT/20 F1 F4

UN: R\$ 1,45 AV: R\$ 28,94 15: R\$ 29,55
30: R\$ 30,14 45: R\$ 30,74 60: R\$ 31,36



PAPEL CARTAO BRILHO 45X65CM SORTIDO 20X1

Código: 29042 Fábrica: LB PAPER Unidade: PT/20 F1 F4

UN: R\$ 2,28 AV: R\$ 45,69 15: R\$ 46,64
30: R\$ 47,57 45: R\$ 48,52 60: R\$ 49,49



PAPEL CARTAO BRILHO 45X65CM VERDE B 20X1

Código: 26370 Fábrica: MINASPEL Unidade: PT/20 F1 F4

UN: R\$ 2,28 AV: R\$ 45,69 15: R\$ 46,64
30: R\$ 47,57 45: R\$ 48,52 60: R\$ 49,49



PAPEL CARTAO BRILHO 45X65CM VERDE C 20X1

Código: 26371 Fábrica: MINASPEL Unidade: PT/20 F1 F4

UN: R\$ 2,28 AV: R\$ 45,69 15: R\$ 46,64
30: R\$ 47,57 45: R\$ 48,52 60: R\$ 49,49



PAPEL CARTAO BRILHO 45X65CM VERMELH 20X1
Código: Fábrica: Unidade:
26362 MINASPEL PT/20
F1 F4

UN: R\$ 1,45 AV: R\$ 28,94 15: R\$ 29,55
30: R\$ 30,14 45: R\$ 30,74 60: R\$ 31,36



PAPEL CARTAO FOSCO 45X65CM AMARELO 20X1
Código: Fábrica: Unidade:
4051 MINASPEL PT/20
F1 F4

UN: R\$ 1,45 AV: R\$ 28,94 15: R\$ 29,55
30: R\$ 30,14 45: R\$ 30,74 60: R\$ 31,36



PAPEL CARTAO FOSCO 45X65CM AZUL CLA 20X1
Código: Fábrica: Unidade:
8092 MINASPEL PT/20
F1 F4

UN: R\$ 1,45 AV: R\$ 28,94 15: R\$ 29,55
30: R\$ 30,14 45: R\$ 30,74 60: R\$ 31,36



PAPEL CARTAO FOSCO 45X65CM AZUL ESC 20X1
Código: Fábrica: Unidade:
11242 MINASPEL PT/20
F1 F4

UN: R\$ 1,45 AV: R\$ 28,94 15: R\$ 29,55
30: R\$ 30,14 45: R\$ 30,74 60: R\$ 31,36



PAPEL CARTAO FOSCO 45X65CM AZUL ROY 20X1
Código: Fábrica: Unidade:
33176 MINASPEL PT/20
F1 F4

UN: R\$ 1,45 AV: R\$ 28,94 15: R\$ 29,55
30: R\$ 30,14 45: R\$ 30,74 60: R\$ 31,36

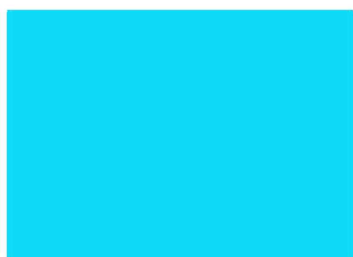

PAPEL CARTAO FOSCO 45X65CM AZUL 20X1
Código: Fábrica: Unidade:
47095 MINASPEL PT/20
F1 F4

UN: R\$ 1,45 AV: R\$ 28,94 15: R\$ 29,55
30: R\$ 30,14 45: R\$ 30,74 60: R\$ 31,36

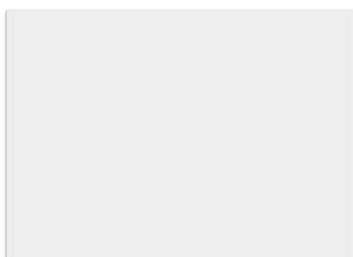

PAPEL CARTAO FOSCO 45X65CM BRANCO 20X1
Código: Fábrica: Unidade:
8094 MINASPEL PT/20
F1 F4

UN: R\$ 1,45 AV: R\$ 28,94 15: R\$ 29,55
30: R\$ 30,14 45: R\$ 30,74 60: R\$ 31,36

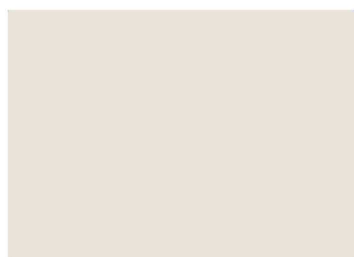

PAPEL CARTAO FOSCO 45X65CM CREME 20X1
Código: Fábrica: Unidade:
48261 MINASPEL PT/20
F1 F4

UN: R\$ 1,45 AV: R\$ 28,94 15: R\$ 29,55
30: R\$ 30,14 45: R\$ 30,74 60: R\$ 31,36



PAPEL CARTAO FOSCO 45X65CM LARANJA 20X1
Código: Fábrica: Unidade:
10180 MINASPEL PT/20
F1 F4

UN: R\$ 1,45 AV: R\$ 28,94 15: R\$ 29,55
30: R\$ 30,14 45: R\$ 30,74 60: R\$ 31,36



PAPEL CARTAO FOSCO 45X65CM LILAS 20X1
Código: Fábrica: Unidade:
36704 MINASPEL PT/20
F1 F4

UN: R\$ 1,45 AV: R\$ 28,94 15: R\$ 29,55
30: R\$ 30,14 45: R\$ 30,74 60: R\$ 31,36



PAPEL CARTAO FOSCO 45X65CM MARROM 20X1
Código: Fábrica: Unidade:
50672 MINASPEL PT/20
F1 F4

UN: R\$ 1,45 AV: R\$ 28,94 15: R\$ 29,55
30: R\$ 30,14 45: R\$ 30,74 60: R\$ 31,36

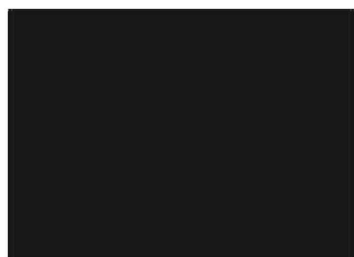

PAPEL CARTAO FOSCO 45X65CM PRETO 20X1
Código: Fábrica: Unidade:
8097 MINASPEL PT/20
F1 F4

UN: R\$ 1,45 AV: R\$ 28,94 15: R\$ 29,55
30: R\$ 30,14 45: R\$ 30,74 60: R\$ 31,36



PAPEL CARTAO FOSCO 45X65CM ROSA PIN 20X1
Código: Fábrica: Unidade:
33352 MINASPEL PT/20
F1 F4

UN: R\$ 1,45 AV: R\$ 28,94 15: R\$ 29,55
30: R\$ 30,14 45: R\$ 30,74 60: R\$ 31,36



PAPEL CARTAO FOSCO 45X65CM ROSA 20X1
Código: Fábrica: Unidade:
8096 MINASPEL PT/20
F1 F4

UN: R\$ 1,45 AV: R\$ 28,94 15: R\$ 29,55
30: R\$ 30,14 45: R\$ 30,74 60: R\$ 31,36



PAPEL CARTAO FOSCO 45X65CM ROXO 20X1
Código: Fábrica: Unidade:
42346 MINASPEL PT/20
F1 F4

UN: R\$ 1,45 AV: R\$ 28,94 15: R\$ 29,55
30: R\$ 30,14 45: R\$ 30,74 60: R\$ 31,36



PAPEL CARTAO FOSCO 45X65CM VERDE BD 20X1
Código: Fábrica: Unidade:
8093 MINASPEL PT/20
F1 F4

UN: R\$ 1,45 AV: R\$ 28,94 15: R\$ 29,55
30: R\$ 30,14 45: R\$ 30,74 60: R\$ 31,36



PAPEL CARTAO FOSCO 45X65CM VERDE CL 20X1
Código: Fábrika: Unidade:
19268 MINASPEL PT/20
F1 F4

UN: R\$ 1,45 AV: R\$ 28,94 15: R\$ 29,55
30: R\$ 30,14 45: R\$ 30,74 60: R\$ 31,36



PAPEL CARTAO FOSCO 45X65CM VERDE LI 20X1
Código: Fábrika: Unidade:
47246 MINASPEL PT/20
F1 F4

UN: R\$ 1,45 AV: R\$ 28,94 15: R\$ 29,55
30: R\$ 30,14 45: R\$ 30,74 60: R\$ 31,36



PAPEL CARTAO FOSCO 45X65CM VERMELHO 20X1
Código: Fábrika: Unidade:
8095 MINASPEL PT/20
F1 F4

UN: R\$ 0,20 AV: R\$ 19,96 15: R\$ 20,37
30: R\$ 20,78 45: R\$ 21,20 60: R\$ 21,62

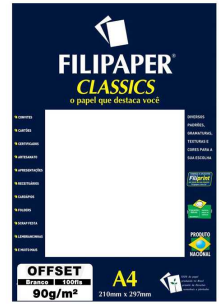

PAPEL CASCA OVO A4 90GR BRANCO 100X1
Código: Fábrika: Unidade:
51022 FILIPAPER PT/100
F1 F4

UN: R\$ 0,20 AV: R\$ 19,96 15: R\$ 20,37
30: R\$ 20,78 45: R\$ 21,20 60: R\$ 21,62



PAPEL CASCA OVO A4 90GR MARFIM 100X1
Código: Fábrika: Unidade:
51021 FILIPAPER PT/100
F1 F4

UN: R\$ 0,40 AV: R\$ 19,96 15: R\$ 20,37
30: R\$ 20,78 45: R\$ 21,20 60: R\$ 21,62



PAPEL CASCA OVO A4 180GR BRANCO 50X1
Código: Fábrika: Unidade:
48936 MASTERPRINT PT/50
F1 F4

UN: R\$ 1,36 AV: R\$ 67,79 15: R\$ 69,20
30: R\$ 70,59 45: R\$ 72,00 60: R\$ 73,44



PAPEL CELOFANE 60X90CM AMARELO 50X1
Código: Fábrika: Unidade:
9921 COPLAMIX PT/50
F1 F4

UN: R\$ 1,36 AV: R\$ 67,79 15: R\$ 69,20
30: R\$ 70,59 45: R\$ 72,00 60: R\$ 73,44



PAPEL CELOFANE 60X90CM AZUL 50X1
Código: Fábrika: Unidade:
4049 COPLAMIX PT/50
F1 F4

UN: R\$ 1,10 AV: R\$ 54,90 15: R\$ 56,05
30: R\$ 57,17 45: R\$ 58,31 60: R\$ 59,48



PAPEL CELOFANE 60X90CM INCOLOR 50X1
Código: Fábrika: Unidade:
2568 COPLAMIX PT/50
F1 F4

UN: R\$ 1,36 AV: R\$ 67,88 15: R\$ 69,30
30: R\$ 70,68 45: R\$ 72,09 60: R\$ 73,54



PAPEL CELOFANE 60X90CM VERMELHO 50X1
Código: Fábrika: Unidade:
9920 COPLAMIX PT/50
F1 F4

UN: R\$ 1,36 AV: R\$ 67,88 15: R\$ 69,30
30: R\$ 70,68 45: R\$ 72,09 60: R\$ 73,54



PAPEL CELOFANE 69X89CM PRETO 50X1
Código: Fábrika: Unidade:
28648 EMBALE PT/50
F1 F4

UN: R\$ 1,36 AV: R\$ 67,79 15: R\$ 69,20
30: R\$ 70,59 45: R\$ 72,00 60: R\$ 73,44



PAPEL CELOFANE 69X89CM MARROM 50X1
Código: Fábrika: Unidade:
28650 EMBALE PT/50
F1 F4

UN: R\$ 1,36 AV: R\$ 67,88 15: R\$ 69,30
30: R\$ 70,68 45: R\$ 72,09 60: R\$ 73,54



PAPEL CELOFANE 69X89CM ROXO 50X1
Código: Fábrika: Unidade:
28647 EMBALE PT/50
F1 F4

UN: R\$ 1,40 AV: R\$ 69,88 15: R\$ 71,33
30: R\$ 72,76 45: R\$ 74,22 60: R\$ 75,70



PAPEL CELOFANE 70X90CM AMARELO 50X1
Código: Fábrika: Unidade:
49680 GALA PT/50
F1 F4

UN: R\$ 1,40 AV: R\$ 69,88 15: R\$ 71,33
30: R\$ 72,76 45: R\$ 74,22 60: R\$ 75,70



PAPEL CELOFANE 70X90CM AZUL 50X1
Código: Fábrika: Unidade:
49679 GALA PT/50
F1 F4

UN: R\$ 1,10 AV: R\$ 54,90 15: R\$ 56,05
30: R\$ 57,17 45: R\$ 58,31 60: R\$ 59,48



PAPEL CELOFANE 70X90CM INCOLOR 50X1
Código: Fábrika: Unidade:
49678 GALA PT/50
F1 F4

UN: R\$ 1,40 AV: R\$ 69,88 15: R\$ 71,33
30: R\$ 72,76 45: R\$ 74,22 60: R\$ 75,70



PAPEL CELOFANE 70X90CM VERDE BAND 50X1
Código: 9922 Fábrica: GALA Unidade: PT/50 F1 F4

UN: R\$ 1,40 AV: R\$ 69,88 15: R\$ 71,33
30: R\$ 72,76 45: R\$ 74,22 60: R\$ 75,70



PAPEL CELOFANE 70X90CM VERMELHO 50X1
Código: 49681 Fábrica: GALA Unidade: PT/50 F1 F4

UN: R\$ 0,30 AV: R\$ 14,97 15: R\$ 15,28
30: R\$ 15,58 45: R\$ 15,90 60: R\$ 16,21



PAPEL COLORSET A4 AMARELO 50X1
Código: 15071 Fábrica: AGAPE/MINASP Unidade: PT/50 F1 F4

UN: R\$ 0,30 AV: R\$ 14,97 15: R\$ 15,28
30: R\$ 15,58 45: R\$ 15,90 60: R\$ 16,21



PAPEL COLORSET A4 AZUL CLARO 50X1
Código: 49390 Fábrica: AGAPE Unidade: PT/50 F1 F4

UN: R\$ 0,30 AV: R\$ 14,97 15: R\$ 15,28
30: R\$ 15,58 45: R\$ 15,90 60: R\$ 16,21



PAPEL COLORSET A4 AZUL ESCURO 50X1
Código: 30794 Fábrica: AGAPE Unidade: PT/50 F1 F4

UN: R\$ 0,30 AV: R\$ 14,97 15: R\$ 15,28
30: R\$ 15,58 45: R\$ 15,90 60: R\$ 16,21



PAPEL COLORSET A4 BRANCO 50X1
Código: 30923 Fábrica: AGAPE Unidade: PT/50 F1 F4

UN: R\$ 0,30 AV: R\$ 14,97 15: R\$ 15,28
30: R\$ 15,58 45: R\$ 15,90 60: R\$ 16,21



PAPEL COLORSET A4 LARANJA 50X1
Código: 44488 Fábrica: AGAPE Unidade: PT/50 F1 F4

UN: R\$ 0,30 AV: R\$ 14,97 15: R\$ 15,28
30: R\$ 15,58 45: R\$ 15,90 60: R\$ 16,21

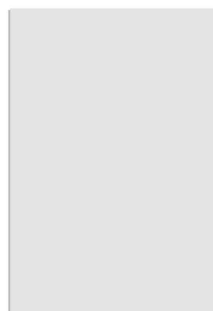

PAPEL COLORSET A4 LILAS 50X1
Código: 48087 Fábrica: AGAPE Unidade: PT/50 F1 F4

UN: R\$ 14,97 AV: R\$ 14,97 15: R\$ 15,28
30: R\$ 15,58 45: R\$ 15,90 60: R\$ 16,21



PAPEL COLORSET A4 MARRON 50X1
Código: 35574 Fábrica: AGAPE Unidade: PT/1 F1 F4

UN: R\$ 0,54 AV: R\$ 12,97 15: R\$ 13,24
30: R\$ 13,50 45: R\$ 13,77 60: R\$ 14,05

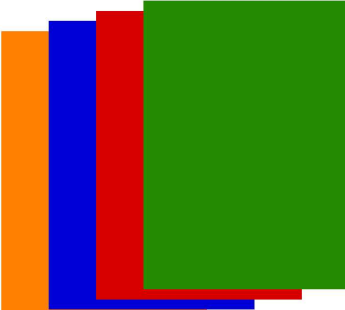

PAPEL COLORSET A4 MULTICOR 24X1
Código: 34264 Fábrica: ASSETE Unidade: PT/24 F1 F4

UN: R\$ 14,97 AV: R\$ 14,97 15: R\$ 15,28
30: R\$ 15,58 45: R\$ 15,90 60: R\$ 16,21

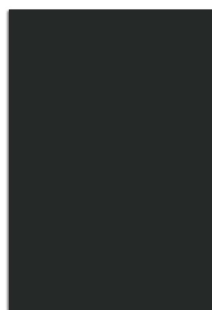

PAPEL COLORSET A4 PRETO 50X1
Código: 35575 Fábrica: AGAPE/MINASP Unidade: PT/1 F1 F4

UN: R\$ 0,30 AV: R\$ 14,98 15: R\$ 15,29
30: R\$ 15,59 45: R\$ 15,90 60: R\$ 16,22



PAPEL COLORSET A4 ROSA PINK 50X1
Código: 49391 Fábrica: AGAPE Unidade: PT/50 F1 F4

UN: R\$ 0,30 AV: R\$ 14,97 15: R\$ 15,28
30: R\$ 15,58 45: R\$ 15,90 60: R\$ 16,21



PAPEL COLORSET A4 ROSA 50X1
Código: 35896 Fábrica: AGAPE Unidade: PT/50 F1 F4

UN: R\$ 0,30 AV: R\$ 14,97 15: R\$ 15,28
30: R\$ 15,58 45: R\$ 15,90 60: R\$ 16,21



PAPEL COLORSET A4 ROXO 50X1
Código: 49392 Fábrica: AGAPE Unidade: PT/50 F1 F4

UN: R\$ 0,30 AV: R\$ 14,97 15: R\$ 15,28
30: R\$ 15,58 45: R\$ 15,90 60: R\$ 16,21

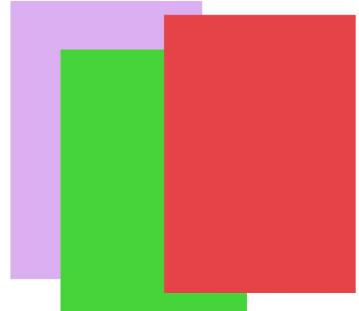

PAPEL COLORSET A4 SORT 50X1
Código: 35897 Fábrica: AGAPE/BRASIL Unidade: PT/50 F1 F4

UN: R\$ 0,30 AV: R\$ 14,97 15: R\$ 15,28
30: R\$ 15,58 45: R\$ 15,90 60: R\$ 16,21



PAPEL COLORSET A4 VERDE BAND 50X1
Código: 30793 Fábrica: AGAPE Unidade: PT/50 F1 F4

UN: R\$ 0,30 AV: R\$ 14,97 15: R\$ 15,28
30: R\$ 15,58 45: R\$ 15,90 60: R\$ 16,21

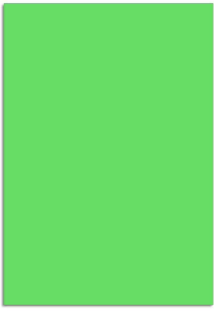

PAPEL COLORSET A4 VERDE CLA 50X1
Código: 34592 Fábrica: MINASPEL Unidade: PT/50 F1 F4

UN: R\$ 0,30 AV: R\$ 14,97 15: R\$ 15,28
30: R\$ 15,58 45: R\$ 15,90 60: R\$ 16,21

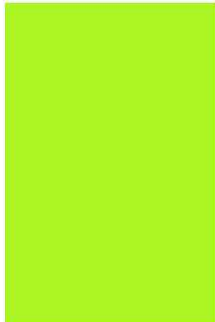

PAPEL COLORSET A4 VERDE LIMAO 50X1
Código: 33079 Fábrica: AGAPE Unidade: PT/50 F1 F4

UN: R\$ 0,30 AV: R\$ 14,97 15: R\$ 15,28
30: R\$ 15,58 45: R\$ 15,90 60: R\$ 16,21



PAPEL COLORSET A4 VERMELHO 50X1
Código: 30795 Fábrica: AGAPE Unidade: PT/50 F1 F4

UN: R\$ 0,95 AV: R\$ 0,95 15: R\$ 0,97
30: R\$ 0,99 45: R\$ 1,01 60: R\$ 1,03



PAPEL COLORSET UN
Código: 42274 Fábrica: MINASPEL Unidade: UN/1 F1 F4

UN: R\$ 1,25 AV: R\$ 24,95 15: R\$ 25,47
30: R\$ 25,98 45: R\$ 26,50 60: R\$ 27,03



PAPEL COLORSET 45X65CM AZUL ROYAL 20X1
Código: 30575 Fábrica: MINASPEL Unidade: PT/20 F1 F4

UN: R\$ 1,25 AV: R\$ 24,95 15: R\$ 25,47
30: R\$ 25,98 45: R\$ 26,50 60: R\$ 27,03



PAPEL COLORSET 45X65CM CAMELMO 20X1
Código: 46989 Fábrica: MINASPEL Unidade: PT/20 F1 F4

UN: R\$ 1,25 AV: R\$ 24,95 15: R\$ 25,47
30: R\$ 25,98 45: R\$ 26,50 60: R\$ 27,03



PAPEL COLORSET 45X65CM OCRE 20X1
Código: 46988 Fábrica: MINASPEL Unidade: PT/20 F1 F4

UN: R\$ 1,25 AV: R\$ 24,95 15: R\$ 25,47
30: R\$ 25,98 45: R\$ 26,50 60: R\$ 27,03



PAPEL COLORSET 45X65CM ROSA FLUOR 20X1
Código: 33177 Fábrica: MINASPEL Unidade: PT/20 F1 F4

UN: R\$ 1,25 AV: R\$ 24,95 15: R\$ 25,47
30: R\$ 25,98 45: R\$ 26,50 60: R\$ 27,03



PAPEL COLORSET 45X65CM ROXO 20X1
Código: 21635 Fábrica: MINASPEL/MIL Unidade: PT/20 F1 F4

UN: R\$ 1,25 AV: R\$ 24,95 15: R\$ 25,47
30: R\$ 25,98 45: R\$ 26,50 60: R\$ 27,03



PAPEL COLORSET 45X65CM SALMAO 20X1
Código: 46990 Fábrica: MINASPEL Unidade: PT/20 F1 F4

UN: R\$ 1,25 AV: R\$ 24,95 15: R\$ 25,47
30: R\$ 25,98 45: R\$ 26,50 60: R\$ 27,03

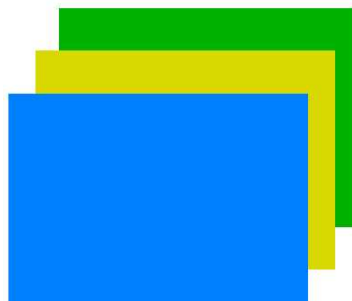

PAPEL COLORSET 45X65CM SORTIDO 20X1
Código: 28718 Fábrica: LB PAPER Unidade: PT/20 F1 F4

UN: R\$ 1,25 AV: R\$ 24,95 15: R\$ 25,47
30: R\$ 25,98 45: R\$ 26,50 60: R\$ 27,03

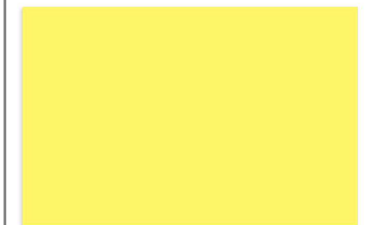

PAPEL COLORSET 45X66CM AMARELO 20X1
Código: 10114 Fábrica: REIPEL/MINAS Unidade: PT/20 F1 F4

UN: R\$ 1,25 AV: R\$ 24,95 15: R\$ 25,47
30: R\$ 25,98 45: R\$ 26,50 60: R\$ 27,03

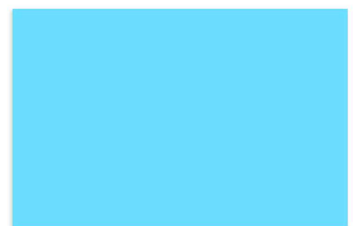

PAPEL COLORSET 45X66CM AZUL CLARO 20X1
Código: 19792 Fábrica: REIPEL/MINAS Unidade: PT/20 F1 F4

UN: R\$ 1,25 AV: R\$ 24,95 15: R\$ 25,47
30: R\$ 25,98 45: R\$ 26,50 60: R\$ 27,03

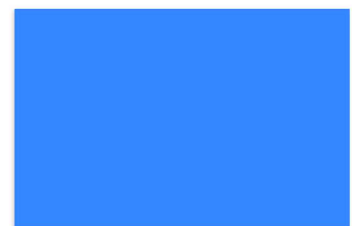

PAPEL COLORSET 45X66CM AZUL ESCURO 20X1
Código: 10113 Fábrica: REIPEL/MINAS Unidade: PT/20 F1 F4

UN: R\$ 1,25 AV: R\$ 24,95 15: R\$ 25,47
30: R\$ 25,98 45: R\$ 26,50 60: R\$ 27,03

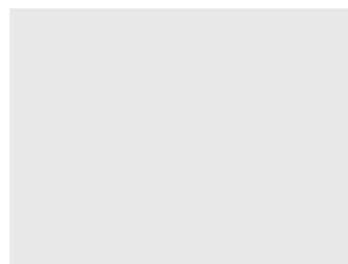

PAPEL COLORSET 45X66CM BRANCO 20X1
Código: 10116 Fábrica: REIPEL/MINAS Unidade: PT/20 F1 F4

UN: R\$ 1,25 AV: R\$ 24,95 15: R\$ 25,47
30: R\$ 25,98 45: R\$ 26,50 60: R\$ 27,03



PAPEL COLORSET 45X66CM CHAMPAGNE 20X1
Código: 47721 Fábrica: REIPEL Unidade: PT/20 F1 F4

UN: R\$ 1,25 AV: R\$ 24,95 15: R\$ 25,47
30: R\$ 25,98 45: R\$ 26,50 60: R\$ 27,03



PAPEL COLORSET 45X66CM LARANJA 20X1
Código: 10112 Fábrica: REIPEL/MINAS Unidade: PT/20 F1 F4

UN: R\$ 1,25 AV: R\$ 24,95 15: R\$ 25,47
30: R\$ 25,98 45: R\$ 26,50 60: R\$ 27,03

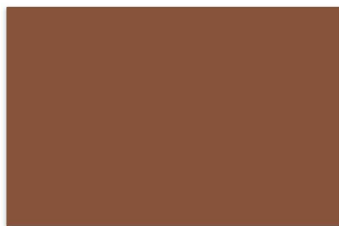

PAPEL COLORSET 45X66CM MARROM 20X1
Código: 10111 Fábrica: REIPEL/MINAS Unidade: PT/20 F1 F4

UN: R\$ 1,25 AV: R\$ 24,95 15: R\$ 25,47
30: R\$ 25,98 45: R\$ 26,50 60: R\$ 27,03

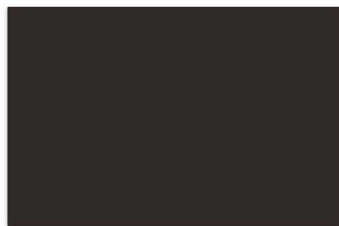

PAPEL COLORSET 45X66CM PRETO 20X1
Código: 15112 Fábrica: REIPEL/MINAS Unidade: PT/20 F1 F4

UN: R\$ 1,25 AV: R\$ 24,95 15: R\$ 25,47
30: R\$ 25,98 45: R\$ 26,50 60: R\$ 27,03



PAPEL COLORSET 45X66CM ROSA PINK 20X1
Código: 29833 Fábrica: REIPEL/MINAS Unidade: PT/20 F1 F4

UN: R\$ 1,25 AV: R\$ 24,95 15: R\$ 25,47
30: R\$ 25,98 45: R\$ 26,50 60: R\$ 27,03



PAPEL COLORSET 45X66CM ROSA 20X1
Código: 15113 Fábrica: REIPEL/MINAS Unidade: PT/20 F1 F4

UN: R\$ 1,25 AV: R\$ 24,95 15: R\$ 25,47
30: R\$ 25,98 45: R\$ 26,50 60: R\$ 27,03



PAPEL COLORSET 45X66CM VERDE BAND 20X1
Código: 4260 Fábrica: REIPEL/MINAS Unidade: PT/20 F1 F4

UN: R\$ 1,25 AV: R\$ 24,95 15: R\$ 25,47
30: R\$ 25,98 45: R\$ 26,50 60: R\$ 27,03



PAPEL COLORSET 45X66CM VERDE CLARO 20X1
Código: 19549 Fábrica: REIPEL/MINAS Unidade: PT/20 F1 F4

UN: R\$ 1,25 AV: R\$ 24,95 15: R\$ 25,47
30: R\$ 25,98 45: R\$ 26,50 60: R\$ 27,03



PAPEL COLORSET 45X66CM VERMELHO 20X1
Código: 10115 Fábrica: REIPEL/MINAS Unidade: PT/20 F1 F4

UN: R\$ 1,25 AV: R\$ 24,95 15: R\$ 25,47
30: R\$ 25,98 45: R\$ 26,50 60: R\$ 27,03



PAPEL COLORSET 45X66CM VIOLETA 20X1
Código: 47722 Fábrica: REIPEL Unidade: PT/20 F1 F4

UN: R\$ 2,42 AV: R\$ 48,42 15: R\$ 49,43
30: R\$ 50,42 45: R\$ 51,43 60: R\$ 52,46



PAPEL COLORSET 48X66CM ESTRELA VERM 20X1
Código: 48371 Fábrica: VMP Unidade: PT/20 F1 F4

UN: R\$ 2,42 AV: R\$ 48,42 15: R\$ 49,43
30: R\$ 50,42 45: R\$ 51,43 60: R\$ 52,46

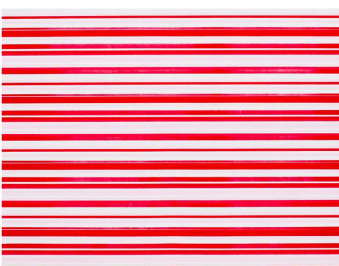

PAPEL COLORSET 48X66CM LISTRAD VERM 20X1
Código: 48376 Fábrica: VMP Unidade: PT/20 F1 F4

UN: R\$ 2,42 AV: R\$ 48,42 15: R\$ 49,43
30: R\$ 50,42 45: R\$ 51,43 60: R\$ 52,46

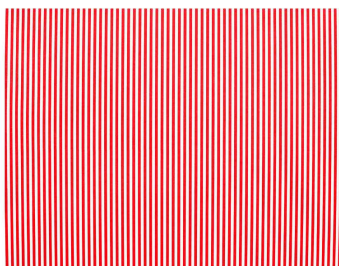

PAPEL COLORSET 48X66CM LISTRAS VERM 20X1
Código: 48375 Fábrica: VMP Unidade: PT/20 F1 F4

UN: R\$ 2,42 AV: R\$ 48,42 15: R\$ 49,43
30: R\$ 50,42 45: R\$ 51,43 60: R\$ 52,46

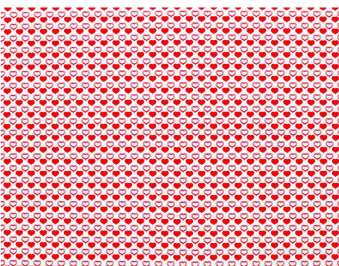

PAPEL COLORSET 48X66CM 2 CORACOES 20X1
Código: 48372 Fábrica: VMP Unidade: PT/20 F1 F4

UN: R\$ 1,25 AV: R\$ 24,95 15: R\$ 25,47
30: R\$ 25,98 45: R\$ 26,50 60: R\$ 27,03



PAPEL COLORSET 45X66CM LILAS 20X1
Código: 16640 Fábrica: REIPEL/MINAS Unidade: PT/20 F1 F4

UN: R\$ 59,89 AV: R\$ 59,89 15: R\$ 61,14
30: R\$ 62,36 45: R\$ 63,61 60: R\$ 64,88



PAPEL CONTACT 45CMX10M ADES MADEIRA CINZ
Código: 48312 Fábrica: BRW Unidade: RL/1 F1 F4

UN: R\$ 7,49 AV: R\$ 74,87 15: R\$ 76,43
30: R\$ 77,96 45: R\$ 79,52 60: R\$ 81,11



PAPEL CONTACT 45CMX10MT ADESIVO BRANCO
Código: 48358 Fábrica: LEOTACK Unidade: RL/10 F1 F4

UN: R\$ 7,49 AV: R\$ 74,87 15: R\$ 76,43
30: R\$ 77,96 45: R\$ 79,52 60: R\$ 81,11



PAPEL CONTACT 45CMX10MT ADESIVO PRETO
Código: Fábrika: Unidade:
48359 LEOTACK RL/10
F1 F4

UN: R\$ 69,88 AV: R\$ 69,88 15: R\$ 71,33
30: R\$ 72,76 45: R\$ 74,22 60: R\$ 75,70



PAPEL CONTACT 45CMX10MT ADESIVO PRETO 17
Código: Fábrika: Unidade:
46147 WIN PAPER RL/1
F1 F4

UN: R\$ 69,88 AV: R\$ 69,88 15: R\$ 71,33
30: R\$ 72,76 45: R\$ 74,22 60: R\$ 75,70

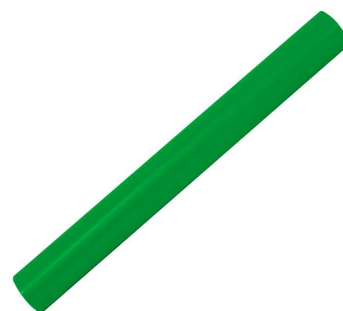

PAPEL CONTACT 45CMX10MT ADESIVO VERDE 10
Código: Fábrika: Unidade:
45949 WIN PAPER RL/1
F1 F4

UN: R\$ 69,88 AV: R\$ 69,88 15: R\$ 71,33
30: R\$ 72,76 45: R\$ 74,22 60: R\$ 75,70



PAPEL CONTACT 45CMX10MT ADESIVO VERMEL 9
Código: Fábrika: Unidade:
45950 WIN PAPER RL/1
F1 F4

UN: R\$ 89,85 AV: R\$ 89,85 15: R\$ 91,72
30: R\$ 93,55 45: R\$ 95,42 60: R\$ 97,33

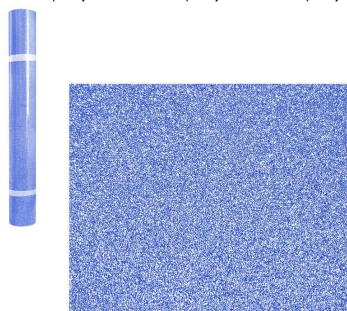

PAPEL CONTACT 45CMX10MT GLITER AZUL 1703
Código: Fábrika: Unidade:
42656 DAC RL/1
F1 F4

UN: R\$ 89,85 AV: R\$ 89,85 15: R\$ 91,72
30: R\$ 93,55 45: R\$ 95,42 60: R\$ 97,33



PAPEL CONTACT 45CMX10MT GLITER PRAT 1703
Código: Fábrika: Unidade:
37948 DAC RL/1
F1 F4

UN: R\$ 89,85 AV: R\$ 89,85 15: R\$ 91,72
30: R\$ 93,55 45: R\$ 95,42 60: R\$ 97,33



PAPEL CONTACT 45CMX10MT GLITER PRET 1703
Código: Fábrika: Unidade:
42658 DAC RL/1
F1 F4

UN: R\$ 89,85 AV: R\$ 89,85 15: R\$ 91,72
30: R\$ 93,55 45: R\$ 95,42 60: R\$ 97,33



PAPEL CONTACT 45CMX10MT GLITER ROSA 1703
Código: Fábrika: Unidade:
38030 DAC RL/1
F1 F4

UN: R\$ 89,85 AV: R\$ 89,85 15: R\$ 91,72
30: R\$ 93,55 45: R\$ 95,42 60: R\$ 97,33



PAPEL CONTACT 45CMX10MT GLITER VERM 1703
Código: Fábrika: Unidade:
42657 DAC RL/1
F1 F4

UN: R\$ 96,35 AV: R\$ 96,35 15: R\$ 98,35
30: R\$ 100,32 45: R\$ 102,33 60: R\$ 104,37



PAPEL CONTACT 45CMX10MT HOL ESTRELA 7435
Código: Fábrika: Unidade:
46410 KAZ RL/1
F1 F4

UN: R\$ 69,88 AV: R\$ 69,88 15: R\$ 71,33
30: R\$ 72,76 45: R\$ 74,22 60: R\$ 75,70



PAPEL CONTACT 45CMX10MT IMBUIA 911
Código: Fábrika: Unidade:
46411 KAZ RL/1
F1 F4

UN: R\$ 74,87 AV: R\$ 74,87 15: R\$ 76,43
30: R\$ 77,96 45: R\$ 79,52 60: R\$ 81,11



PAPEL CONTACT 45CMX10MT MADEIRA TABACO
Código: Fábrika: Unidade:
32790 VMP RL/1
F1 F4

UN: R\$ 89,85 AV: R\$ 89,85 15: R\$ 91,72
30: R\$ 93,55 45: R\$ 95,42 60: R\$ 97,33

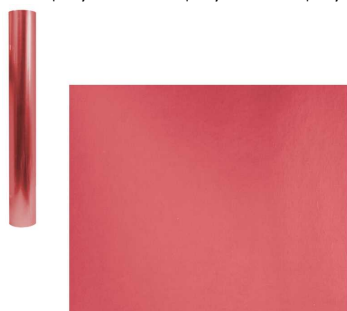

PAPEL CONTACT 45CMX10MT METAL ROSA 1751
Código: Fábrika: Unidade:
37944 DAC RL/1
F1 F4

UN: R\$ 69,88 AV: R\$ 69,88 15: R\$ 71,33
30: R\$ 72,76 45: R\$ 74,22 60: R\$ 75,70

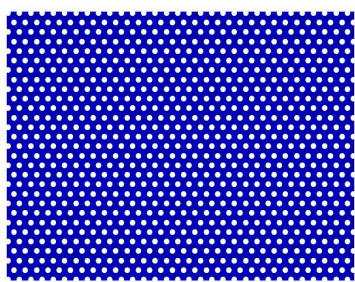

PAPEL CONTACT 45CMX10MT POA AZUL
Código: Fábrika: Unidade:
34388 VMP RL/1
F1 F4

UN: R\$ 69,88 AV: R\$ 69,88 15: R\$ 71,33
30: R\$ 72,76 45: R\$ 74,22 60: R\$ 75,70



PAPEL CONTACT 45CMX10MT PVC AZUL 1702
Código: Fábrika: Unidade:
37937 DAC RL/1
F1 F4

UN: R\$ 69,88 AV: R\$ 69,88 15: R\$ 71,33
30: R\$ 72,76 45: R\$ 74,22 60: R\$ 75,70

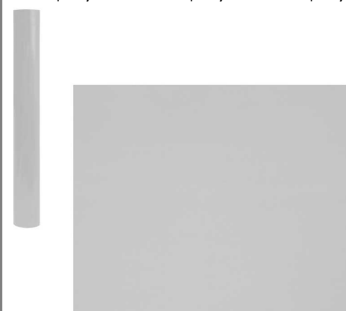

PAPEL CONTACT 45CMX10MT PVC BRANCO 1702
Código: Fábrika: Unidade:
37939 DAC RL/1
F1 F4

UN: R\$ 69,88 AV: R\$ 69,88 15: R\$ 71,33
30: R\$ 72,76 45: R\$ 74,22 60: R\$ 75,70



PAPEL CONTACT 45CMX10MT PVC PRETO 1702
Código: Fábrika: Unidade:
37942 DAC RL/1
F1 F4

UN: R\$ 69,88 AV: R\$ 69,88 15: R\$ 71,33
30: R\$ 72,76 45: R\$ 74,22 60: R\$ 75,70

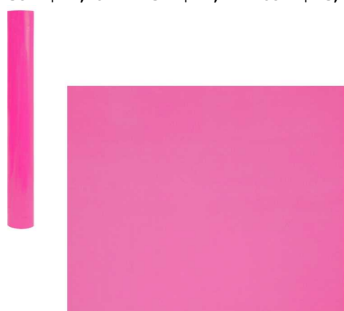

PAPEL CONTACT 45CMX10MT PVC ROSA 1702
Código: Fábrika: Unidade:
37941 DAC RL/1
F1 F4

UN: R\$ 40,60 AV: R\$ 40,60 15: R\$ 41,45
30: R\$ 42,28 45: R\$ 43,13 60: R\$ 43,99



PAPEL CONTACT 45CMX10MT PVC TRANSP
Código: Fábrika: Unidade:
50376 BAZZE RL/1
F1 F4

UN: R\$ 76,87 AV: R\$ 76,87 15: R\$ 78,47
30: R\$ 80,04 45: R\$ 81,64 60: R\$ 83,27

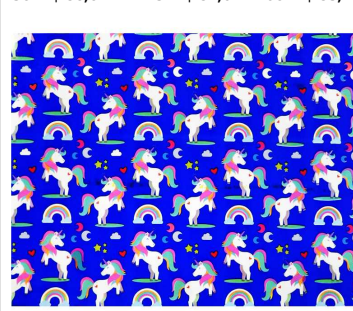

PAPEL CONTACT 45CMX10MT UNICORNIO
Código: Fábrika: Unidade:
34389 VMP RL/1
F1 F4

UN: R\$ 23,96 AV: R\$ 23,96 15: R\$ 24,46
30: R\$ 24,95 45: R\$ 25,45 60: R\$ 25,96

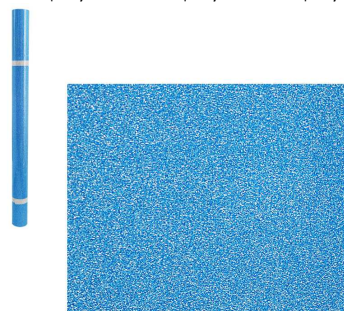

PAPEL CONTACT 45CMX2MT GLITER AZUL 1711
Código: Fábrika: Unidade:
37950 DAC RL/1
F1 F4

UN: R\$ 23,96 AV: R\$ 23,96 15: R\$ 24,46
30: R\$ 24,95 45: R\$ 25,45 60: R\$ 25,96



PAPEL CONTACT 45CMX2MT GLITER PRAT 1711
Código: Fábrika: Unidade:
37954 DAC RL/1
F1 F4

UN: R\$ 23,96 AV: R\$ 23,96 15: R\$ 24,46
30: R\$ 24,95 45: R\$ 25,45 60: R\$ 25,96



PAPEL CONTACT 45CMX2MT GLITER PRETO 1711
Código: Fábrika: Unidade:
37953 DAC RL/1
F1 F4

UN: R\$ 23,96 AV: R\$ 23,96 15: R\$ 24,46
30: R\$ 24,95 45: R\$ 25,45 60: R\$ 25,96

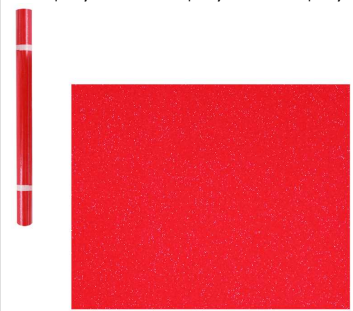

PAPEL CONTACT 45CMX2MT GLITER VERME 1711
Código: Fábrika: Unidade:
37955 DAC RL/1
F1 F4

UN: R\$ 21,07 AV: R\$ 21,07 15: R\$ 21,51
30: R\$ 21,94 45: R\$ 22,37 60: R\$ 22,82

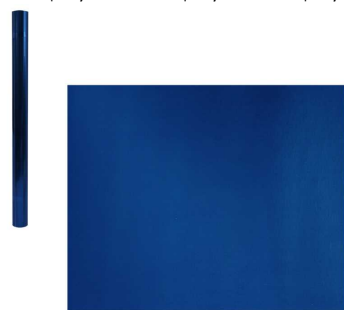

PAPEL CONTACT 45CMX2MT METAL AZUL 1750
Código: Fábrika: Unidade:
37963 DAC RL/1
F1 F4

UN: R\$ 21,07 AV: R\$ 21,07 15: R\$ 21,51
30: R\$ 21,94 45: R\$ 22,37 60: R\$ 22,82

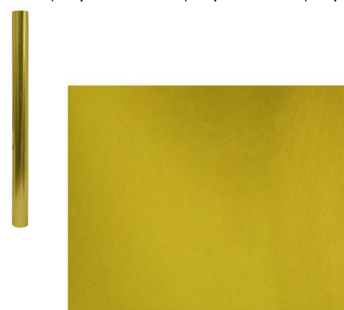

PAPEL CONTACT 45CMX2MT METAL DOURAD 1750
Código: Fábrika: Unidade:
37961 DAC RL/1
F1 F4

UN: R\$ 21,07 AV: R\$ 21,07 15: R\$ 21,51
30: R\$ 21,94 45: R\$ 22,37 60: R\$ 22,82

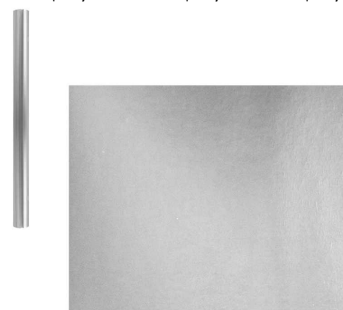

PAPEL CONTACT 45CMX2MT METAL PRATA 1750
Código: Fábrika: Unidade:
37962 DAC RL/1
F1 F4

UN: R\$ 21,07 AV: R\$ 21,07 15: R\$ 21,51
30: R\$ 21,94 45: R\$ 22,37 60: R\$ 22,82

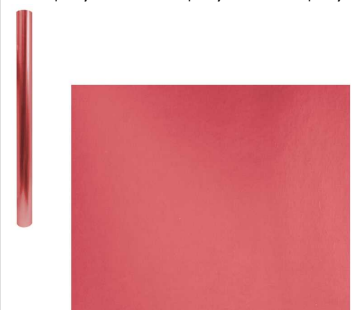

PAPEL CONTACT 45CMX2MT METAL ROSA 1750
Código: Fábrika: Unidade:
37958 DAC RL/1
F1 F4

UN: R\$ 21,07 AV: R\$ 21,07 15: R\$ 21,51
30: R\$ 21,94 45: R\$ 22,37 60: R\$ 22,82



PAPEL CONTACT 45CMX2MT METAL ROXO 1750
Código: Fábrika: Unidade:
37959 DAC RL/1
F1 F4

UN: R\$ 16,52 AV: R\$ 16,52 15: R\$ 16,87
30: R\$ 17,21 45: R\$ 17,55 60: R\$ 17,90



PAPEL CONTACT 45CMX2MT PVC AMARELO 1708
Código: Fábrika: Unidade:
37966 DAC RL/1
F1 F4

UN: R\$ 16,52 AV: R\$ 16,52 15: R\$ 16,87
30: R\$ 17,21 45: R\$ 17,55 60: R\$ 17,90



PAPEL CONTACT 45CMX2MT PVC AZUL 1708
Código: Fábrika: Unidade:
37964 DAC RL/1
F1 F4

UN: R\$ 16,52 AV: R\$ 16,52 15: R\$ 16,87
30: R\$ 17,21 45: R\$ 17,55 60: R\$ 17,90



PAPEL CONTACT 45CMX2MT PVC ROSA 1708
Código: Fábrika: Unidade:
37969 DAC RL/1
F1 F4

UN: R\$ 3,59 AV: R\$ 89,85 15: R\$ 91,72
30: R\$ 93,55 45: R\$ 95,42 60: R\$ 97,33



PAPEL CONTACT 45CMX25MT ADESIVO TRANSP
Código: Fábrika: Unidade:
3065 DAC/POLIFIX RL/25
F1 F4

UN: R\$ 3,89 AV: R\$ 97,26 15: R\$ 99,29
30: R\$ 101,28 45: R\$ 103,30 60: R\$ 105,37



PAPEL CONTACT 45CMX25MT ADESIVO TRANSP
Código: Fábrika: Unidade:
46375 LEOTACK RL/25
F1 F4

UN: R\$ 129,78 AV: R\$ 129,78 15: R\$ 132,49
30: R\$ 135,14 45: R\$ 137,84 60: R\$ 140,60



PAPEL CONTACT 45CMX25MT CRISTAL 80MIC 80
Código: Fábrika: Unidade:
46412 KAZ RL/1
F1 F4

UN: R\$ 25,95 AV: R\$ 25,95 15: R\$ 26,49
30: R\$ 27,02 45: R\$ 27,56 60: R\$ 28,11



PAPEL CONTACT 45CMX5M DEC AUTOADESIV 001
Código: Fábrika: Unidade:
49371 RIOHOME RL/1
F1 F4

UN: R\$ 25,86 AV: R\$ 25,86 15: R\$ 26,40
30: R\$ 26,93 45: R\$ 27,46 60: R\$ 28,01



PAPEL CONTACT 45CMX5M DEC AUTOADESIV 002
Código: Fábrika: Unidade:
49370 RIOHOME RL/1
F1 F4

UN: R\$ 25,95 AV: R\$ 25,95 15: R\$ 26,49
30: R\$ 27,02 45: R\$ 27,56 60: R\$ 28,11



PAPEL CONTACT 45CMX5M DEC AUTOADESIV 003
Código: Fábrika: Unidade:
49374 RIOHOME RL/1
F1 F4

UN: R\$ 25,95 AV: R\$ 25,95 15: R\$ 26,49
30: R\$ 27,02 45: R\$ 27,56 60: R\$ 28,11



PAPEL CONTACT 45CMX5M DEC AUTOADESIV 004
Código: Fábrika: Unidade:
49373 RIOHOME RL/1
F1 F4

UN: R\$ 25,95 AV: R\$ 25,95 15: R\$ 26,49
30: R\$ 27,02 45: R\$ 27,56 60: R\$ 28,11



PAPEL CONTACT 45CMX5M DEC AUTOADESIV 007
Código: Fábrika: Unidade:
49369 RIOHOME RL/1
F1 F4

UN: R\$ 25,95 AV: R\$ 25,95 15: R\$ 26,49
30: R\$ 27,02 45: R\$ 27,56 60: R\$ 28,11

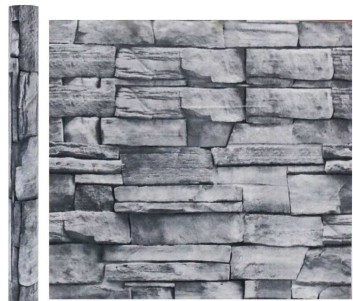

PAPEL CONTACT 45CMX5M DEC AUTOADESIV 011
Código: Fábrika: Unidade:
49372 RIOHOME RL/1
F1 F4

UN: R\$ 25,95 AV: R\$ 25,95 15: R\$ 26,49
30: R\$ 27,02 45: R\$ 27,56 60: R\$ 28,11

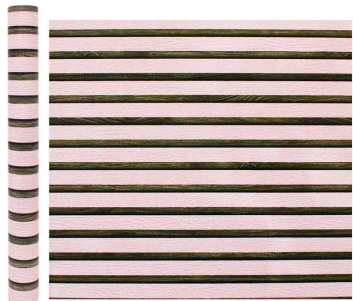

PAPEL CONTACT 45CMX5M DEC AUTOADESIV 014
Código: Fábrika: Unidade:
49367 RIOHOME RL/1
F1 F4

UN: R\$ 25,95 AV: R\$ 25,95 15: R\$ 26,49
30: R\$ 27,02 45: R\$ 27,56 60: R\$ 28,11

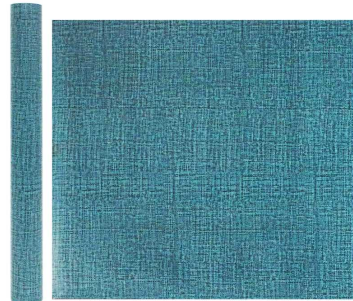

PAPEL CONTACT 45CMX5M DEC AUTOADESIV 015
Código: Fábrika: Unidade:
49368 RIOHOME RL/1
F1 F4

UN: R\$ 32,75 AV: R\$ 32,75 15: R\$ 33,43
30: R\$ 34,10 45: R\$ 34,78 60: R\$ 35,48

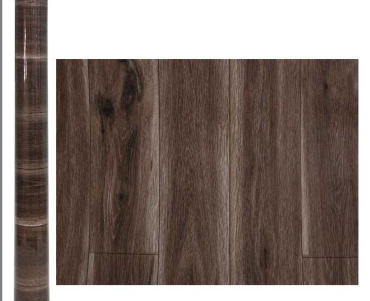

PAPEL CONTACT 45CMX5MT 50062
Código: Fábrika: Unidade:
38541 ROCIE RL/1
F1 F4

UN: R\$ 0,51 AV: R\$ 25,33 15: R\$ 25,86
30: R\$ 26,37 45: R\$ 26,90 60: R\$ 27,44



PAPEL COUCHE A4 180GR BRILHO 50X1
Código: Fábrika: Unidade:
41369 USAPEL PT/50
F1 F4

UN: R\$ 0,75 AV: R\$ 37,44 15: R\$ 38,22
30: R\$ 38,98 45: R\$ 39,76 60: R\$ 40,56



PAPEL COUCHE A4 180GR GRANITTO NT 50X1
Código: Fábrika: Unidade:
41371 USAPEL PT/50
F1 F4

UN: R\$ 0,51 AV: R\$ 25,33 15: R\$ 25,86
30: R\$ 26,37 45: R\$ 26,90 60: R\$ 27,44



PAPEL COUCHE A4 180GR MATTE BRANCO 50X1
Código: Fábrika: Unidade:
41370 USAPEL PT/50
F1 F4

UN: R\$ 0,51 AV: R\$ 25,33 15: R\$ 25,86
30: R\$ 26,37 45: R\$ 26,90 60: R\$ 27,44

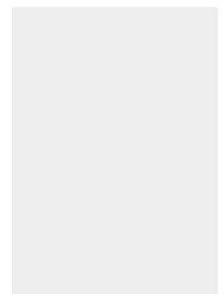

PAPEL COUCHE BRILHO A4 90GR 50X1
Código: Fábrika: Unidade:
34267 ASSETE PT/50
F1 F4

UN: R\$ 0,46 AV: R\$ 22,95 15: R\$ 23,43
30: R\$ 23,90 45: R\$ 24,38 60: R\$ 24,87

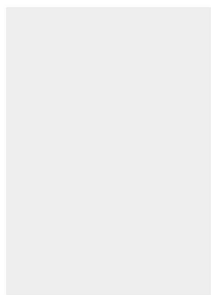

PAPEL COUCHE BRILHO A4 170GR 513 50X1

Código: Fábrika: Unidade:
34266 MASTERPINT PT/50
F1 F4

UN: R\$ 4,39 AV: R\$ 43,92 15: R\$ 44,83
30: R\$ 45,73 45: R\$ 46,65 60: R\$ 47,58



PAPEL CREPOM DEC CARROS PRETO 10X1

Código: Fábrika: Unidade:
49597 VMP PT/10
F1 F4

UN: R\$ 4,39 AV: R\$ 43,92 15: R\$ 44,83
30: R\$ 45,73 45: R\$ 46,65 60: R\$ 47,58



PAPEL CREPOM DEC FROZEN ROXO 10X1

Código: Fábrika: Unidade:
49600 VMP PT/10
F1 F4

UN: R\$ 4,39 AV: R\$ 43,92 15: R\$ 44,83
30: R\$ 45,73 45: R\$ 46,65 60: R\$ 47,58



PAPEL CREPOM DEC MARIE 10X1

Código: Fábrika: Unidade:
49602 VMP PT/10
F1 F4

UN: R\$ 4,39 AV: R\$ 43,92 15: R\$ 44,83
30: R\$ 45,73 45: R\$ 46,65 60: R\$ 47,58



PAPEL CREPOM DEC MICKEY BRANCO 10X1

Código: Fábrika: Unidade:
49596 VMP PT/10
F1 F4

UN: R\$ 4,39 AV: R\$ 43,92 15: R\$ 44,83
30: R\$ 45,73 45: R\$ 46,65 60: R\$ 47,58



PAPEL CREPOM DEC MICKEY PRETO 10X1

Código: Fábrika: Unidade:
49594 VMP PT/10
F1 F4

UN: R\$ 4,39 AV: R\$ 43,92 15: R\$ 44,83
30: R\$ 45,73 45: R\$ 46,65 60: R\$ 47,58



PAPEL CREPOM DEC MINNIE VERMELHO 10X1

Código: Fábrika: Unidade:
49601 VMP PT/10
F1 F4

UN: R\$ 4,39 AV: R\$ 43,92 15: R\$ 44,83
30: R\$ 45,73 45: R\$ 46,65 60: R\$ 47,58



PAPEL CREPOM DEC TOY STORY AZUL 10X1

Código: Fábrika: Unidade:
49592 VMP PT/10
F1 F4

UN: R\$ 4,39 AV: R\$ 43,92 15: R\$ 44,83
30: R\$ 45,73 45: R\$ 46,65 60: R\$ 47,58



PAPEL CREPOM DEC TOY STORY CINZA 10X1

Código: Fábrika: Unidade:
49593 VMP PT/10
F1 F4

UN: R\$ 3,49 AV: R\$ 34,93 15: R\$ 35,66
30: R\$ 36,38 45: R\$ 37,10 60: R\$ 37,84



PAPEL CREPOM FANT ESTRELINHAS OURO 10X1

Código: Fábrika: Unidade:
49603 VMP PT/10
F1 F4

UN: R\$ 3,49 AV: R\$ 34,93 15: R\$ 35,66
30: R\$ 36,38 45: R\$ 37,10 60: R\$ 37,84



PAPEL CREPOM FANT ESTRELINHAS PRATA 10X1

Código: Fábrika: Unidade:
49605 VMP PT/10
F1 F4

UN: R\$ 3,49 AV: R\$ 34,93 15: R\$ 35,66
30: R\$ 36,38 45: R\$ 37,10 60: R\$ 37,84



PAPEL CREPOM FANT LISTRAS PRATA 10X1

Código: Fábrika: Unidade:
49604 VMP PT/10
F1 F4

UN: R\$ 3,49 AV: R\$ 34,93 15: R\$ 35,66
30: R\$ 36,38 45: R\$ 37,10 60: R\$ 37,84



PAPEL CREPOM FANT LISTRAS ROSA 10X1

Código: Fábrika: Unidade:
49606 VMP PT/10
F1 F4

UN: R\$ 4,79 AV: R\$ 47,91 15: R\$ 48,91
30: R\$ 49,89 45: R\$ 50,89 60: R\$ 51,91

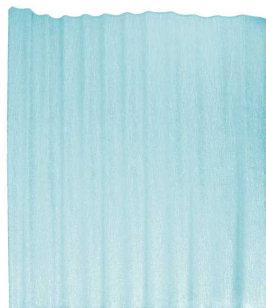

PAPEL CREPOM METAL 48CMX1M AZUL CLA 10X1

Código: Fábrika: Unidade:
50273 REIPEL PT/10
F1 F4

UN: R\$ 4,79 AV: R\$ 47,91 15: R\$ 48,91
30: R\$ 49,89 45: R\$ 50,89 60: R\$ 51,91



PAPEL CREPOM METAL 48CMX1M VERDE CL 10X1

Código: Fábrika: Unidade:
50274 REIPEL PT/10
F1 F4

UN: R\$ 6,49 AV: R\$ 64,89 15: R\$ 66,24
30: R\$ 67,56 45: R\$ 68,91 60: R\$ 70,29



PAPEL CREPOM PARAFINADO OURO 10X1

Código: Fábrika: Unidade:
47707 REIPEL PT/10
F1 F4

UN: R\$ 6,49 AV: R\$ 64,89 15: R\$ 66,24
30: R\$ 67,56 45: R\$ 68,91 60: R\$ 70,29



PAPEL CREPOM PARAFINADO PRATA 10X1

Código: Fábrica: Unidade:
47708 REIPEL PT/10
F1 F4

UN: R\$ 1,46 AV: R\$ 14,57 15: R\$ 14,87
30: R\$ 15,17 45: R\$ 15,47 60: R\$ 15,78



PAPEL CREPOM 48CMX2M AMARELO CANARI 10X1

Código: Fábrica: Unidade:
18854 REPEL/ARTFLO PT/10
F1 F4

UN: R\$ 1,46 AV: R\$ 14,57 15: R\$ 14,87
30: R\$ 15,17 45: R\$ 15,47 60: R\$ 15,78



PAPEL CREPOM 48CMX2M AMARELO OURO 10X1

Código: Fábrica: Unidade:
18861 ART FLOC PT/10
F1 F4

UN: R\$ 1,46 AV: R\$ 14,57 15: R\$ 14,87
30: R\$ 15,17 45: R\$ 15,47 60: R\$ 15,78



PAPEL CREPOM 48CMX2M AMARELO SOL 10X1

Código: Fábrica: Unidade:
6953 ART FLOC PT/10
F1 F4

UN: R\$ 1,46 AV: R\$ 14,57 15: R\$ 14,87
30: R\$ 15,17 45: R\$ 15,47 60: R\$ 15,78

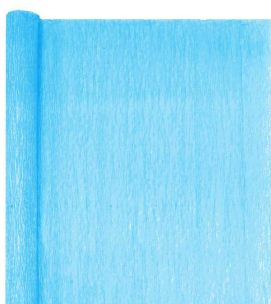

PAPEL CREPOM 48CMX2M AZUL CLARO 10X1

Código: Fábrica: Unidade:
18858 ARTFLOC/NOVA PT/10
F1 F4

UN: R\$ 1,46 AV: R\$ 14,57 15: R\$ 14,87
30: R\$ 15,17 45: R\$ 15,47 60: R\$ 15,78



PAPEL CREPOM 48CMX2M AZUL ESCURO 10X1

Código: Fábrica: Unidade:
18857 NOVAPRINT PT/10
F1 F4

UN: R\$ 1,46 AV: R\$ 14,57 15: R\$ 14,87
30: R\$ 15,17 45: R\$ 15,47 60: R\$ 15,78

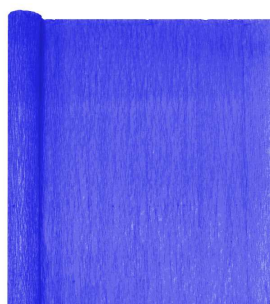

PAPEL CREPOM 48CMX2M AZUL MARINHO 10X1

Código: Fábrica: Unidade:
33198 ART FLOC PT/10
F1 F4

UN: R\$ 1,46 AV: R\$ 14,57 15: R\$ 14,87
30: R\$ 15,17 45: R\$ 15,47 60: R\$ 15,78

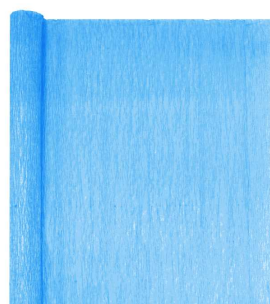

PAPEL CREPOM 48CMX2M AZUL PISCINA 10X1

Código: Fábrica: Unidade:
18855 ART FLOC PT/10
F1 F4

UN: R\$ 1,46 AV: R\$ 14,57 15: R\$ 14,87
30: R\$ 15,17 45: R\$ 15,47 60: R\$ 15,78

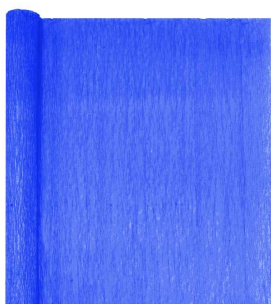

PAPEL CREPOM 48CMX2M AZUL ROYAL 10X1

Código: Fábrica: Unidade:
18856 ARTFLOC/REIP PT/10
F1 F4

UN: R\$ 1,46 AV: R\$ 14,57 15: R\$ 14,87
30: R\$ 15,17 45: R\$ 15,47 60: R\$ 15,78

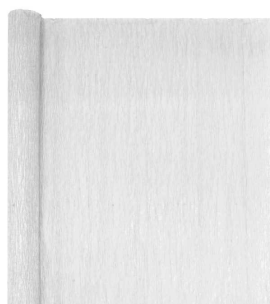

PAPEL CREPOM 48CMX2M BRANCO 10X1

Código: Fábrica: Unidade:
18865 REIPEL/ARTFL PT/10
F1 F4

UN: R\$ 1,46 AV: R\$ 14,57 15: R\$ 14,87
30: R\$ 15,17 45: R\$ 15,47 60: R\$ 15,78



PAPEL CREPOM 48CMX2M CHAMPAGNE 10X1

Código: Fábrica: Unidade:
46887 ART FLOC PT/10
F1 F4

UN: R\$ 1,46 AV: R\$ 14,57 15: R\$ 14,87
30: R\$ 15,17 45: R\$ 15,47 60: R\$ 15,78



PAPEL CREPOM 48CMX2M CHAMPAGNE 10X1

Código: Fábrica: Unidade:
17902 ART FLOC PT/10
F1 F4

UN: R\$ 1,46 AV: R\$ 14,57 15: R\$ 14,87
30: R\$ 15,17 45: R\$ 15,47 60: R\$ 15,78

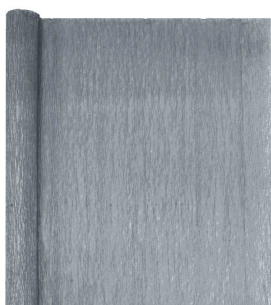

PAPEL CREPOM 48CMX2M CINZA 10X1

Código: Fábrica: Unidade:
15611 ART FLOC PT/10
F1 F4

UN: R\$ 1,45 AV: R\$ 14,52 15: R\$ 14,82
30: R\$ 15,12 45: R\$ 15,42 60: R\$ 15,73

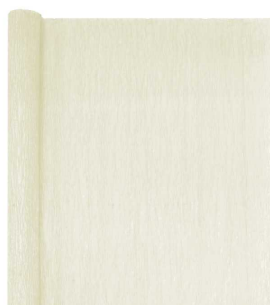

PAPEL CREPOM 48CMX2M GELO ACINZENTA 10X1

Código: Fábrica: Unidade:
6951 VMP PT/10
F1 F4

UN: R\$ 1,46 AV: R\$ 14,57 15: R\$ 14,87
30: R\$ 15,17 45: R\$ 15,47 60: R\$ 15,78



PAPEL CREPOM 48CMX2M LARANJA 10X1

Código: Fábrica: Unidade:
18862 ARTFLOC/NOVA PT/10
F1 F4

UN: R\$ 1,46 AV: R\$ 14,57 15: R\$ 14,87
30: R\$ 15,17 45: R\$ 15,47 60: R\$ 15,78

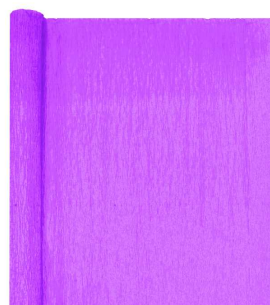

PAPEL CREPOM 48CMX2M LILAS 10X1

Código: Fábrica: Unidade:
18869 REIPEL/ARTFL PT/10
F1 F4

UN: R\$ 1,46 AV: R\$ 14,57 15: R\$ 14,87
30: R\$ 15,17 45: R\$ 15,47 60: R\$ 15,78

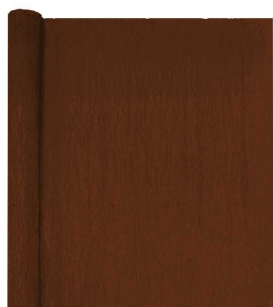

PAPEL CREPOM 48CMX2M MARRON 10X1
Código: 18608 Fábrica: ARTFLOC/NOVA Unidade: PT/10 F1 F4

UN: R\$ 1,46 AV: R\$ 14,57 15: R\$ 14,87
30: R\$ 15,17 45: R\$ 15,47 60: R\$ 15,78

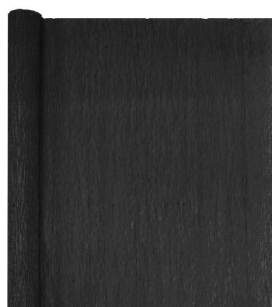

PAPEL CREPOM 48CMX2M PRETO 10X1
Código: 18864 Fábrica: ARTFLOC/NOVA Unidade: PT/10 F1 F4

UN: R\$ 1,46 AV: R\$ 14,57 15: R\$ 14,87
30: R\$ 15,17 45: R\$ 15,47 60: R\$ 15,78



PAPEL CREPOM 48CMX2M ROSA CLARO 10X1
Código: 18851 Fábrica: ARTFLOC%NOVA Unidade: PT/10 F1 F4

UN: R\$ 1,46 AV: R\$ 14,57 15: R\$ 14,87
30: R\$ 15,17 45: R\$ 15,47 60: R\$ 15,78

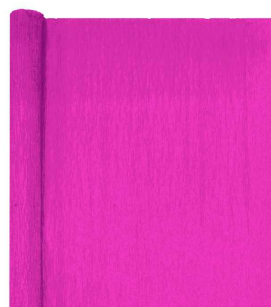

PAPEL CREPOM 48CMX2M ROSA PINK 10X1
Código: 18850 Fábrica: REIPEL/ARTFL Unidade: PT/10 F1 F4

UN: R\$ 1,46 AV: R\$ 14,57 15: R\$ 14,87
30: R\$ 15,17 45: R\$ 15,47 60: R\$ 15,78



PAPEL CREPOM 48CMX2M ROSA 10X1
Código: 18852 Fábrica: ART FLOC Unidade: PT/10 F1 F4

UN: R\$ 1,46 AV: R\$ 14,57 15: R\$ 14,87
30: R\$ 15,17 45: R\$ 15,47 60: R\$ 15,78



PAPEL CREPOM 48CMX2M ROXO 10X1
Código: 15612 Fábrica: ARTFLOC/NOVA Unidade: PT/10 F1 F4

UN: R\$ 1,46 AV: R\$ 14,57 15: R\$ 14,87
30: R\$ 15,17 45: R\$ 15,47 60: R\$ 15,78

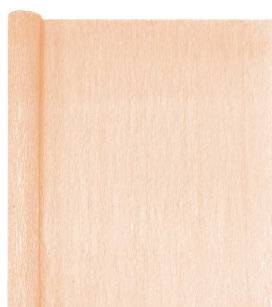

PAPEL CREPOM 48CMX2M SALMAO CLARO 10X1
Código: 42595 Fábrica: ART FLOC Unidade: PT/10 F1 F4

UN: R\$ 1,46 AV: R\$ 14,57 15: R\$ 14,87
30: R\$ 15,17 45: R\$ 15,47 60: R\$ 15,78



PAPEL CREPOM 48CMX2M SALMAO 10X1
Código: 18853 Fábrica: ART FLOC Unidade: PT/10 F1 F4

UN: R\$ 1,46 AV: R\$ 58,40 15: R\$ 59,61
30: R\$ 60,81 45: R\$ 62,02 60: R\$ 63,26



PAPEL CREPOM 48CMX2M SORT 40X1
Código: 41888 Fábrica: ART FLOC Unidade: PT/40 F1 F4

UN: R\$ 1,46 AV: R\$ 14,57 15: R\$ 14,87
30: R\$ 15,17 45: R\$ 15,47 60: R\$ 15,78



PAPEL CREPOM 48CMX2M SORTIDO 10X1
Código: 42140 Fábrica: ART FLOC Unidade: PT/10 F1 F4

UN: R\$ 1,46 AV: R\$ 14,57 15: R\$ 14,87
30: R\$ 15,17 45: R\$ 15,47 60: R\$ 15,78

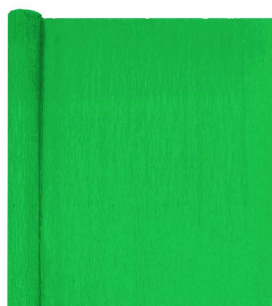

PAPEL CREPOM 48CMX2M VERDE BANDEIRA 10X1
Código: 18868 Fábrica: REIPEL/ARTFL Unidade: PT/10 F1 F4

UN: R\$ 1,46 AV: R\$ 14,57 15: R\$ 14,87
30: R\$ 15,17 45: R\$ 15,47 60: R\$ 15,78

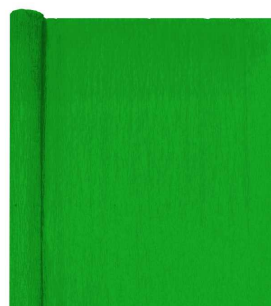

PAPEL CREPOM 48CMX2M VERDE FOLHA 10X1
Código: 18867 Fábrica: ARTFLOC/NOVA Unidade: PT/10 F1 F4

UN: R\$ 1,46 AV: R\$ 14,57 15: R\$ 14,87
30: R\$ 15,17 45: R\$ 15,47 60: R\$ 15,78



PAPEL CREPOM 48CMX2M VERDE FOSCO 10X1
Código: 42597 Fábrica: ART FLOC Unidade: PT/10 F1 F4

UN: R\$ 1,46 AV: R\$ 14,57 15: R\$ 14,87
30: R\$ 15,17 45: R\$ 15,47 60: R\$ 15,78

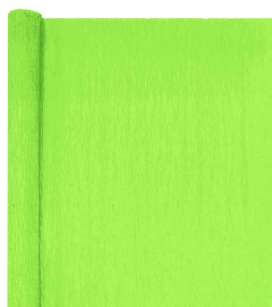

PAPEL CREPOM 48CMX2M VERDE LIMA 10X1
Código: 6954 Fábrica: ART FLOC Unidade: PT/10 F1 F4

UN: R\$ 1,46 AV: R\$ 14,57 15: R\$ 14,87
30: R\$ 15,17 45: R\$ 15,47 60: R\$ 15,78

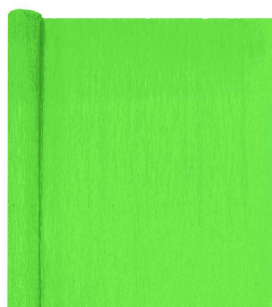

PAPEL CREPOM 48CMX2M VERDE LIMAO 10X1
Código: 18866 Fábrica: ART FLOC Unidade: PT/10 F1 F4

UN: R\$ 1,46 AV: R\$ 14,57 15: R\$ 14,87
30: R\$ 15,17 45: R\$ 15,47 60: R\$ 15,78

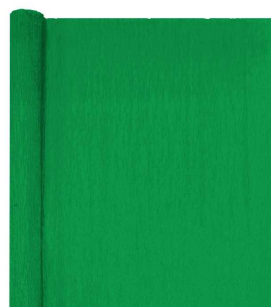

PAPEL CREPOM 48CMX2M VERDE MUSGO 10X1
Código: 6960 Fábrica: ART FLOC Unidade: PT/10 F1 F4

UN: R\$ 1,46 AV: R\$ 14,57 15: R\$ 14,87
30: R\$ 15,17 45: R\$ 15,47 60: R\$ 15,78

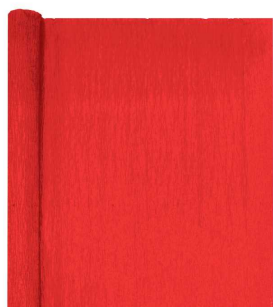

PAPEL CREPOM 48CMX2M VERMELHO 10X1
Código: 18863 Fábrica: REIPE/ARTFLO Unidade: PT/10 F1 F4

UN: R\$ 1,46 AV: R\$ 14,57 15: R\$ 14,87
30: R\$ 15,17 45: R\$ 15,47 60: R\$ 15,78



PAPEL CREPOM 48CMX2M VINHO 10X1
Código: 6947 Fábrica: ART FLOC Unidade: PT/10 F1 F4

UN: R\$ 1,46 AV: R\$ 14,57 15: R\$ 14,87
30: R\$ 15,17 45: R\$ 15,47 60: R\$ 15,78



PAPEL CREPOM 48CMX2M VIOLETA 10X1
Código: 18859 Fábrica: ART FLOC Unidade: PT/10 F1 F4

UN: R\$ 0,70 AV: R\$ 69,88 15: R\$ 71,33
30: R\$ 72,76 45: R\$ 74,22 60: R\$ 75,70

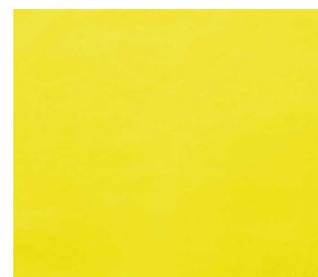

PAPEL FANTAS/DOBR 50X60CM AMARELO 100X1
Código: 15114 Fábrica: VMP/MILPEL Unidade: CE/100 F1 F4

UN: R\$ 0,70 AV: R\$ 69,88 15: R\$ 71,33
30: R\$ 72,76 45: R\$ 74,22 60: R\$ 75,70

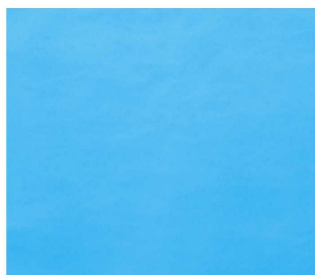

PAPEL FANTAS/DOBR 50X60CM AZUL CLA 100X1
Código: 10107 Fábrica: VMP/MILPEL Unidade: CE/100 F1 F4

UN: R\$ 0,70 AV: R\$ 69,88 15: R\$ 71,33
30: R\$ 72,76 45: R\$ 74,22 60: R\$ 75,70

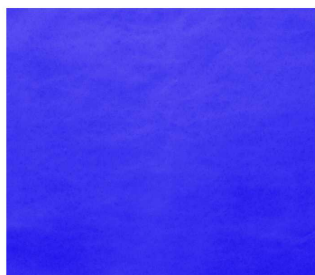

PAPEL FANTAS/DOBR 50X60CM AZUL ESC 100X1
Código: 46914 Fábrica: VMP Unidade: CE/100 F1 F4

UN: R\$ 0,70 AV: R\$ 69,88 15: R\$ 71,33
30: R\$ 72,76 45: R\$ 74,22 60: R\$ 75,70



PAPEL FANTAS/DOBR 50X60CM BRANCO 100X1
Código: 16639 Fábrica: VMP/MILP Unidade: CE/100 F1 F4

UN: R\$ 0,70 AV: R\$ 69,88 15: R\$ 71,33
30: R\$ 72,76 45: R\$ 74,22 60: R\$ 75,70

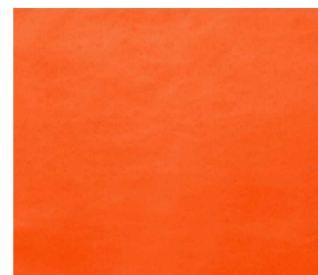

PAPEL FANTAS/DOBR 50X60CM LARANJA 100X1
Código: 10108 Fábrica: VMP/MILPEL Unidade: CE/100 F1 F4

UN: R\$ 0,70 AV: R\$ 69,88 15: R\$ 71,33
30: R\$ 72,76 45: R\$ 74,22 60: R\$ 75,70

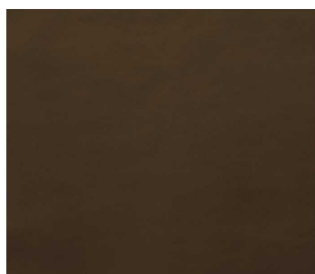

PAPEL FANTAS/DOBR 50X60CM MARRM 100X1
Código: 40755 Fábrica: VMP/MILPEL Unidade: CE/100 F1 F4

UN: R\$ 0,70 AV: R\$ 69,88 15: R\$ 71,33
30: R\$ 72,76 45: R\$ 74,22 60: R\$ 75,70

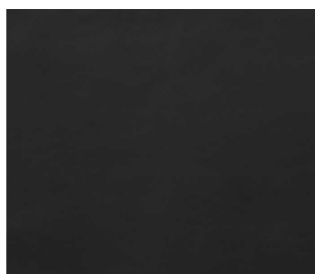

PAPEL FANTAS/DOBR 50X60CM PRETO 100X1
Código: 17058 Fábrica: VMP Unidade: CE/100 F1 F4

UN: R\$ 0,70 AV: R\$ 69,88 15: R\$ 71,33
30: R\$ 72,76 45: R\$ 74,22 60: R\$ 75,70



PAPEL FANTAS/DOBR 50X60CM ROSA PIN 100X1
Código: 10109 Fábrica: VMP/MILPEL Unidade: CE/100 F1 F4

UN: R\$ 0,70 AV: R\$ 69,88 15: R\$ 71,33
30: R\$ 72,76 45: R\$ 74,22 60: R\$ 75,70



PAPEL FANTAS/DOBR 50X60CM VERDE BD100X1
Código: 15269 Fábrica: VMP/MILPEL Unidade: CE/100 F1 F4

UN: R\$ 0,70 AV: R\$ 69,88 15: R\$ 71,33
30: R\$ 72,76 45: R\$ 74,22 60: R\$ 75,70

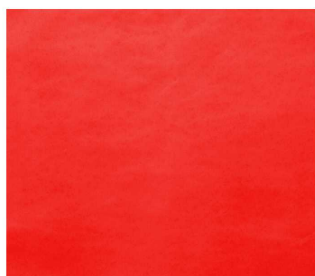

PAPEL FANTAS/DOBR 50X60CM VERMELHO 100X1
Código: 44193 Fábrica: VMP/MILPEL Unidade: CE/100 F1 F4

UN: R\$ 69,88 AV: R\$ 69,88 15: R\$ 71,33
30: R\$ 72,76 45: R\$ 74,22 60: R\$ 75,70



PAPEL FANTASIA 48X60CM 100X1 SORTIDO
Código: 6658 Fábrica: MILPEL Unidade: CE/1 F1 F4

UN: R\$ 1,60 AV: R\$ 31,94 15: R\$ 32,60
30: R\$ 33,26 45: R\$ 33,92 60: R\$ 34,60



PAPEL FOTO A3 130GRS ADESIVO 20X1
Código: 45265 Fábrica: MASTERPRINT Unidade: PT/20 F1 F4

UN: R\$ 1,40 AV: R\$ 27,95 15: R\$ 28,53
30: R\$ 29,10 45: R\$ 29,68 60: R\$ 30,27



PAPEL FOTO A3 135GRS ADESIVO 10X1
Código: 48908 Fábrica: MASTERPRINT Unidade: PT/20 F1 F4

UN: R\$ 0,95 AV: R\$ 18,96 15: R\$ 19,35
30: R\$ 19,74 45: R\$ 20,14 60: R\$ 20,54



PAPEL FOTO A3 180GR 20X1
Código: 29748 Fábrica: MASTERPRINT Unidade: PT/20 F1 F4

UN: R\$ 1,32 AV: R\$ 26,41 15: R\$ 26,96
30: R\$ 27,50 45: R\$ 28,05 60: R\$ 28,61



PAPEL FOTO A3 180GRS DUPLA FACE 20X1
Código: 46068 Fábrica: MASTERPRINT Unidade: PT/20 F1 F4

UN: R\$ 0,27 AV: R\$ 27,35 15: R\$ 27,92
30: R\$ 28,47 45: R\$ 29,04 60: R\$ 29,62



PAPEL FOTO A4 90GR MATTE FOSCO 100X1
Código: 45154 Fábrica: MASTERPRINT Unidade: PT/100 F1 F4

UN: R\$ 0,75 AV: R\$ 14,97 15: R\$ 15,28
30: R\$ 15,58 45: R\$ 15,90 60: R\$ 16,21



PAPEL FOTO A4 115GR ADESIVO 20X1
Código: 45111 Fábrica: MASTERPRINT Unidade: PT/20 F1 F4

UN: R\$ 0,38 AV: R\$ 7,58 15: R\$ 7,74
30: R\$ 7,89 45: R\$ 8,05 60: R\$ 8,21



PAPEL FOTO A4 115GR 20X1
Código: 45266 Fábrica: MASTERPRINT Unidade: PT/20 F1 F4

UN: R\$ 0,39 AV: R\$ 19,33 15: R\$ 19,73
30: R\$ 20,13 45: R\$ 20,53 60: R\$ 20,94



PAPEL FOTO A4 115GR 50X1
Código: 45110 Fábrica: MASTERPRINT Unidade: PT/50 F1 F4

UN: R\$ 0,75 AV: R\$ 14,97 15: R\$ 15,28
30: R\$ 15,58 45: R\$ 15,90 60: R\$ 16,21



PAPEL FOTO A4 130GR ADESIVO 20X1
Código: 29747 Fábrica: MASTERPRINT Unidade: PT/20 F1 F4

UN: R\$ 0,72 AV: R\$ 35,93 15: R\$ 36,68
30: R\$ 37,41 45: R\$ 38,16 60: R\$ 38,93



PAPEL FOTO A4 130GR ADESIVO 50X1
Código: 38238 Fábrica: MASTERPRINT Unidade: PT/50 F1 F4

UN: R\$ 0,36 AV: R\$ 17,96 15: R\$ 18,34
30: R\$ 18,70 45: R\$ 19,08 60: R\$ 19,46



PAPEL FOTO A4 135GR 50X1
Código: 45112 Fábrica: MASTERPRINT Unidade: PT/50 F1 F4

UN: R\$ 0,39 AV: R\$ 19,62 15: R\$ 20,03
30: R\$ 20,43 45: R\$ 20,84 60: R\$ 21,25



PAPEL FOTO A4 150GR 50X1
Código: 42234 Fábrica: MASTERPRINT Unidade: PT/50 F1 F4

UN: R\$ 0,63 AV: R\$ 31,50 15: R\$ 32,16
30: R\$ 32,80 45: R\$ 33,45 60: R\$ 34,12



PAPEL FOTO A4 180GR BRILHOSO 50X1
Código: 48347 Fábrica: YIN'S PAPER Unidade: PT/50 F1 F4

UN: R\$ 0,42 AV: R\$ 20,96 15: R\$ 21,39
30: R\$ 21,82 45: R\$ 22,26 60: R\$ 22,70



PAPEL FOTO A4 180GR 50X1
Código: 37956 Fábrica: MASTERPRINT Unidade: PT/50 F1 F4

UN: R\$ 0,24 AV: R\$ 4,88 15: R\$ 4,98
30: R\$ 5,08 45: R\$ 5,19 60: R\$ 5,29



PAPEL FOTO 10X15CM 265GRS GLOSSY 20X1
Código: 50006 Fábrica: MASTERPRINT Unidade: PT/20 F1 F4

UN: R\$ 34,93 AV: R\$ 34,93 15: R\$ 35,66
30: R\$ 36,38 45: R\$ 37,10 60: R\$ 37,84



PAPEL HIGIENICO 10CMX30M FOLHA DUPL 16X1
Código: 48510 Fábrica: NOBRE Unidade: PT/1 F1 F4

UN: R\$ 0,20 AV: R\$ 4,98 15: R\$ 5,09
30: R\$ 5,19 45: R\$ 5,29 60: R\$ 5,40



PAPEL KRAFT A4 240 GRS FILIPAPER 25X1
Código: 34263 Fábrica: FILIPAPER Unidade: PT/25 F1 F4

UN: R\$ 0,30 AV: R\$ 14,97 15: R\$ 15,28
30: R\$ 15,58 45: R\$ 15,90 60: R\$ 16,21



PAPEL KRAFT A4 180GR ARTESANATO 50X1
Código: 45113 Fábrica: MASTERPRINT Unidade: PT/50 F1 F4

UN: R\$ 0,88 AV: R\$ 219,64 15: R\$ 224,21
30: R\$ 228,70 45: R\$ 233,27 60: R\$ 237,94

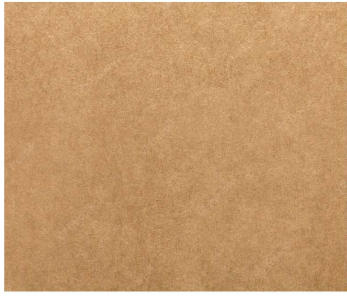

PAPEL KRAFT BIGNARD 80GX660MMX96CM 250X1
Código: Fábrica: Unidade:
41855 MGPAPEL PT/250
F1 F4

UN: R\$ 269,56 AV: R\$ 269,56 15: R\$ 275,17
30: R\$ 280,68 45: R\$ 286,29 60: R\$ 292,02



PAPEL KRAFT BOB 80GRS 120CM 150MTS
Código: Fábrica: Unidade:
41850 MGPAPEL RL/1
F1 F4

UN: R\$ 99,83 AV: R\$ 99,83 15: R\$ 101,91
30: R\$ 103,95 45: R\$ 106,03 60: R\$ 108,15



PAPEL KRAFT BOB 80GRS 40CM 140MTS 4,5KG
Código: Fábrica: Unidade:
45743 JUSSARA RL/1
F1 F4

UN: R\$ 103,33 AV: R\$ 103,33 15: R\$ 105,49
30: R\$ 107,60 45: R\$ 109,75 60: R\$ 111,94



PAPEL KRAFT BOB 100GRS 100CM 100MTS
Código: Fábrica: Unidade:
44621 RITZ RL/1
F1 F4

UN: R\$ 121,79 AV: R\$ 121,79 15: R\$ 124,33
30: R\$ 126,82 45: R\$ 129,36 60: R\$ 131,94



PAPEL KRAFT NAT BOB 60GRS 60CM 140MTS
Código: Fábrica: Unidade:
47720 REIPEL RL/1
F1 F4

UN: R\$ 1,19 AV: R\$ 47,42 15: R\$ 48,41
30: R\$ 49,38 45: R\$ 50,37 60: R\$ 51,38



PAPEL LAMINADO AZUL 49X59CM 40X1
Código: Fábrica: Unidade:
6902 EMBALE PT/40
F1 F4

UN: R\$ 1,07 AV: R\$ 10,68 15: R\$ 10,91
30: R\$ 11,12 45: R\$ 11,35 60: R\$ 11,57



PAPEL LAMINADO A4 250GR AZUL 10X1
Código: Fábrica: Unidade:
48909 MASTERPRINT PT/10
F1 F4

UN: R\$ 1,07 AV: R\$ 10,68 15: R\$ 10,91
30: R\$ 11,12 45: R\$ 11,35 60: R\$ 11,57



PAPEL LAMINADO A4 250GR COBRE 10X1
Código: Fábrica: Unidade:
48910 MASTERPRINT PT/10
F1 F4

UN: R\$ 1,07 AV: R\$ 10,68 15: R\$ 10,91
30: R\$ 11,12 45: R\$ 11,35 60: R\$ 11,57



PAPEL LAMINADO A4 250GR PRATA 10X1
Código: Fábrica: Unidade:
48912 MASTERPRINT PT/10
F1 F4

UN: R\$ 1,07 AV: R\$ 10,68 15: R\$ 10,91
30: R\$ 11,12 45: R\$ 11,35 60: R\$ 11,57



PAPEL LAMINADO A4 250GR ROSA 10X1
Código: Fábrica: Unidade:
48915 MASTERPRINT PT/10
F1 F4

UN: R\$ 1,07 AV: R\$ 10,68 15: R\$ 10,91
30: R\$ 11,12 45: R\$ 11,35 60: R\$ 11,57



PAPEL LAMINADO A4 250GR ROSE GOLD 10X1
Código: Fábrica: Unidade:
48914 MASTERPRINT PT/10
F1 F4

UN: R\$ 1,07 AV: R\$ 10,68 15: R\$ 10,91
30: R\$ 11,12 45: R\$ 11,35 60: R\$ 11,57



PAPEL LAMINADO A4 250GR VERDE 10X1
Código: Fábrica: Unidade:
48911 MASTERPRINT PT/10
F1 F4

UN: R\$ 1,07 AV: R\$ 10,68 15: R\$ 10,91
30: R\$ 11,12 45: R\$ 11,35 60: R\$ 11,57



PAPEL LAMINADO A4 250GR VERMELHO 10X1
Código: Fábrica: Unidade:
48913 MASTERPRINT PT/10
F1 F4

UN: R\$ 1,19 AV: R\$ 47,42 15: R\$ 48,41
30: R\$ 49,38 45: R\$ 50,37 60: R\$ 51,38



PAPEL LAMINADO DOURADO 49X59CM 40X1
Código: Fábrica: Unidade:
18195 EMBALE PT/40
F1 F4

UN: R\$ 1,00 AV: R\$ 39,93 15: R\$ 40,76
30: R\$ 41,57 45: R\$ 42,40 60: R\$ 43,25



PAPEL LAMINADO PRATA 49X59CM 40X1
Código: Fábrica: Unidade:
6151 EMBALE PT/40
F1 F4

UN: R\$ 1,19 AV: R\$ 47,42 15: R\$ 48,41
30: R\$ 49,38 45: R\$ 50,37 60: R\$ 51,38



PAPEL LAMINADO PRETO 48X58CM 40X1
Código: Fábrica: Unidade:
21501 EMBALE PT/40
F1 F4

UN: R\$ 1,19 AV: R\$ 47,42 15: R\$ 48,41
30: R\$ 49,38 45: R\$ 50,37 60: R\$ 51,38



PAPEL LAMINADO ROSA PINK 49X59CM 40X1
Código: Fábrica: Unidade:
19601 EMBALE PT/40
F1 F4

UN: R\$ 1,19 AV: R\$ 47,42 15: R\$ 48,41
30: R\$ 49,38 45: R\$ 50,37 60: R\$ 51,38

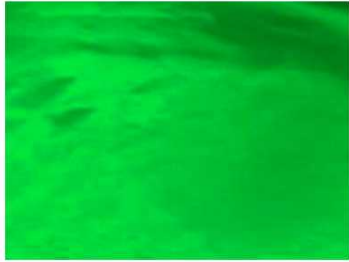

PAPEL LAMINADO VERDE 49X59CM 40X1
Código: Fábrica: Unidade:
12203 EMBALE PT/40
F1 F4

UN: R\$ 1,19 AV: R\$ 47,42 15: R\$ 48,41
30: R\$ 49,38 45: R\$ 50,37 60: R\$ 51,38



PAPEL LAMINADO VERMELHO 49X59CM 40X1
Código: Fábrica: Unidade:
12202 EMBALE PT/40
F1 F4

UN: R\$ 0,36 AV: R\$ 17,96 15: R\$ 18,34
30: R\$ 18,70 45: R\$ 19,08 60: R\$ 19,46



PAPEL LINHO A4 180GR BRANCO 50X1
Código: Fábrica: Unidade:
41361 USUAL PT/50
F1 F4

UN: R\$ 0,38 AV: R\$ 18,96 15: R\$ 19,35
30: R\$ 19,74 45: R\$ 20,14 60: R\$ 20,54



PAPEL LINHO A4 180GR CREME 50X1
Código: Fábrica: Unidade:
45788 USAPEL PT/50
F1 F4

UN: R\$ 0,38 AV: R\$ 18,96 15: R\$ 19,35
30: R\$ 19,74 45: R\$ 20,14 60: R\$ 20,54



PAPEL LINHO A4 180GR PALHA 50X1
Código: Fábrica: Unidade:
41362 USAPEL PT/50
F1 F4

UN: R\$ 0,13 AV: R\$ 6,49 15: R\$ 6,62
30: R\$ 6,76 45: R\$ 6,89 60: R\$ 7,03



PAPEL LUMINI A4 75GR SORT 50X1
Código: Fábrica: Unidade:
35898 AGAPE PT/50
F1 F4

UN: R\$ 0,28 AV: R\$ 14,13 15: R\$ 14,42
30: R\$ 14,71 45: R\$ 15,00 60: R\$ 15,30

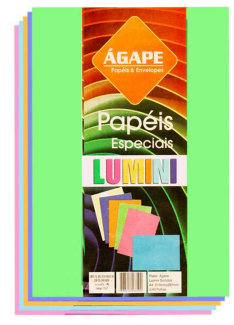

PAPEL LUMINI A4 80GR SORT 40X1
Código: Fábrica: Unidade:
47258 MINAPEL PT/50
F1 F4

UN: R\$ 23,51 AV: R\$ 23,51 15: R\$ 24,00
30: R\$ 24,48 45: R\$ 24,97 60: R\$ 25,47



PAPEL MACHE 100 GRS S/COR
Código: Fábrica: Unidade:
41983 ACRILEX PT/1
F1 F4

UN: R\$ 76,88 AV: R\$ 76,88 15: R\$ 78,48
30: R\$ 80,05 45: R\$ 81,65 60: R\$ 83,28



PAPEL MANILHA STRONG BOB 25CM 250 MTS
Código: Fábrica: Unidade:
43625 STRONG RL/1
F1 F4

UN: R\$ 129,78 AV: R\$ 129,78 15: R\$ 132,49
30: R\$ 135,14 45: R\$ 137,84 60: R\$ 140,60



PAPEL MANILHA STRONG BOB 40CM 250 MTS
Código: Fábrica: Unidade:
43626 STRONG RL/1
F1 F4

UN: R\$ 205,67 AV: R\$ 205,67 15: R\$ 209,96
30: R\$ 214,15 45: R\$ 218,44 60: R\$ 222,81



PAPEL MANILHA STRONG BOB 60CM 250 MTS
Código: Fábrica: Unidade:
43627 STRONG RL/1
F1 F4

UN: R\$ 4,99 AV: R\$ 49,91 15: R\$ 50,95
30: R\$ 51,97 45: R\$ 53,01 60: R\$ 54,07

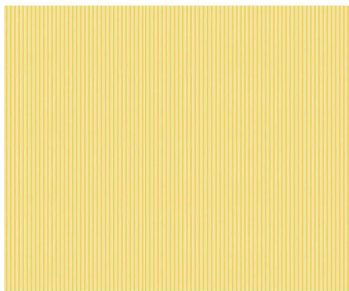

PAPEL MICROONDULADO AMARELO 48X80CM 10X1
Código: Fábrica: Unidade:
3277 REIPEL/VMP PT/10
F1 F4

UN: R\$ 4,99 AV: R\$ 49,91 15: R\$ 50,95
30: R\$ 51,97 45: R\$ 53,01 60: R\$ 54,07

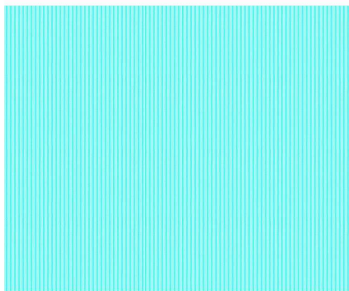

PAPEL MICROONDULADO AZUL CL 48X80CM 10X1
Código: Fábrica: Unidade:
47712 REIPEL PT/10
F1 F4

UN: R\$ 4,99 AV: R\$ 49,91 15: R\$ 50,95
30: R\$ 51,97 45: R\$ 53,01 60: R\$ 54,07

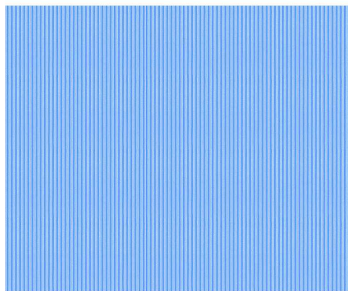

PAPEL MICROONDULADO AZUL ES 48X80CM 10X1
Código: Fábrica: Unidade:
47710 REIPEL PT/10
F1 F4

UN: R\$ 4,99 AV: R\$ 49,91 15: R\$ 50,95
30: R\$ 51,97 45: R\$ 53,01 60: R\$ 54,07

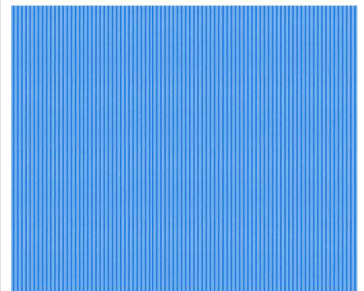

PAPEL MICROONDULADO AZUL 50X80CM 10X1
Código: Fábrica: Unidade:
28181 VMP PT/10
F1 F4

UN: R\$ 4,99 AV: R\$ 49,91 15: R\$ 50,95
30: R\$ 51,97 45: R\$ 53,01 60: R\$ 54,07

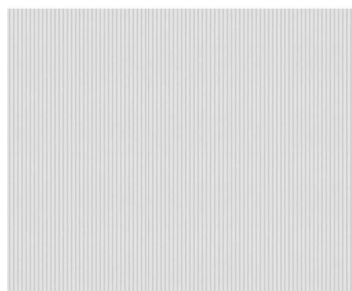

PAPEL MICROONDULADO BRANCO 48X80CM 10X1
Código: 34394 Fábrica: VMP/REIPEL Unidade: PT/10 F1 F4

UN: R\$ 4,99 AV: R\$ 49,91 15: R\$ 50,95
30: R\$ 51,97 45: R\$ 53,01 60: R\$ 54,07



PAPEL MICROONDULADO ESTAMP 50X80CM 10X1
Código: 42383 Fábrica: RST Unidade: PT/10 F1 F4

UN: R\$ 4,99 AV: R\$ 49,91 15: R\$ 50,95
30: R\$ 51,97 45: R\$ 53,01 60: R\$ 54,07

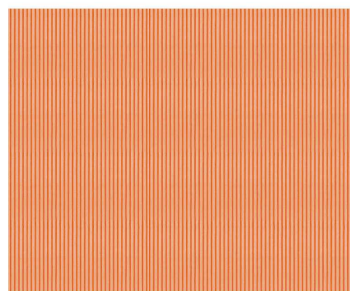

PAPEL MICROONDULADO LARANJA 50X80CM 10X1
Código: 34395 Fábrica: REIPEL/VMP Unidade: PT/10 F1 F4

UN: R\$ 4,99 AV: R\$ 49,91 15: R\$ 50,95
30: R\$ 51,97 45: R\$ 53,01 60: R\$ 54,07

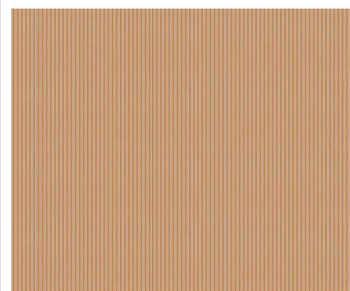

PAPEL MICROONDULADO MARROM 48X80CM 10X1
Código: 47709 Fábrica: REIPEL Unidade: PT/10 F1 F4

UN: R\$ 4,99 AV: R\$ 49,91 15: R\$ 50,95
30: R\$ 51,97 45: R\$ 53,01 60: R\$ 54,07

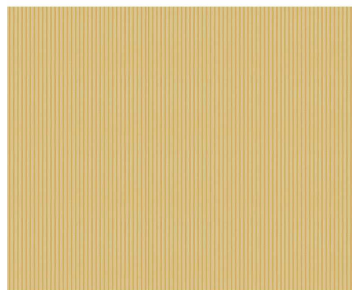

PAPEL MICROONDULADO OURO 48X80CM 10X1
Código: 47714 Fábrica: REIPEL Unidade: PT/10 F1 F4

UN: R\$ 4,99 AV: R\$ 49,91 15: R\$ 50,95
30: R\$ 51,97 45: R\$ 53,01 60: R\$ 54,07

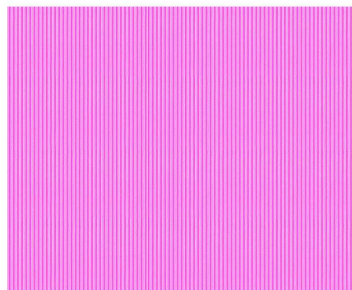

PAPEL MICROONDULADO PINK 48X80CM 10X1
Código: 47711 Fábrica: REIPEL Unidade: PT/10 F1 F4

UN: R\$ 4,99 AV: R\$ 49,91 15: R\$ 50,95
30: R\$ 51,97 45: R\$ 53,01 60: R\$ 54,07

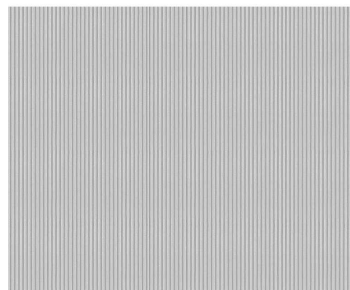

PAPEL MICROONDULADO PRATA 48X80CM 10X1
Código: 47715 Fábrica: REIPEL Unidade: PT/10 F1 F4

UN: R\$ 4,99 AV: R\$ 49,91 15: R\$ 50,95
30: R\$ 51,97 45: R\$ 53,01 60: R\$ 54,07

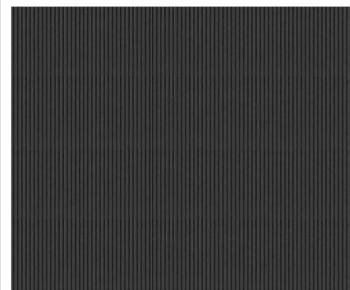

PAPEL MICROONDULADO PRETO 48X80CM 10X1
Código: 34396 Fábrica: REIPEL/VMP Unidade: PT/10 F1 F4

UN: R\$ 4,99 AV: R\$ 49,91 15: R\$ 50,95
30: R\$ 51,97 45: R\$ 53,01 60: R\$ 54,07

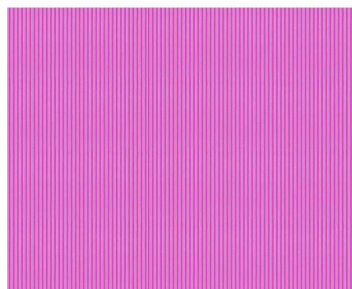

PAPEL MICROONDULADO ROSA 50X80CM 10X1
Código: 4050 Fábrica: REIPEL/VMP Unidade: PT/10 F1 F4

UN: R\$ 4,99 AV: R\$ 49,91 15: R\$ 50,95
30: R\$ 51,97 45: R\$ 53,01 60: R\$ 54,07



PAPEL MICROONDULADO ROXO 50X80CM 10X1
Código: 34397 Fábrica: VMP Unidade: PT/10 F1 F4

UN: R\$ 4,99 AV: R\$ 49,91 15: R\$ 50,95
30: R\$ 51,97 45: R\$ 53,01 60: R\$ 54,07

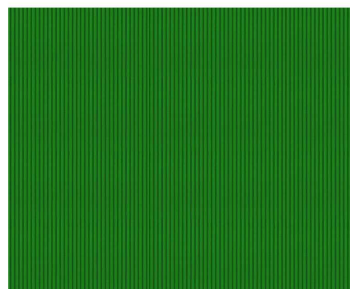

PAPEL MICROONDULADO VERDE B 48X80CM 10X1
Código: 6901 Fábrica: REIPEL/VMP Unidade: PT/10 F1 F4

UN: R\$ 4,99 AV: R\$ 49,91 15: R\$ 50,95
30: R\$ 51,97 45: R\$ 53,01 60: R\$ 54,07

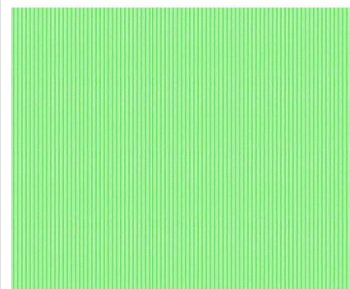

PAPEL MICROONDULADO VERDE C 48X80CM 10X1
Código: 47713 Fábrica: REIPEL Unidade: PT/10 F1 F4

UN: R\$ 4,99 AV: R\$ 49,91 15: R\$ 50,95
30: R\$ 51,97 45: R\$ 53,01 60: R\$ 54,07

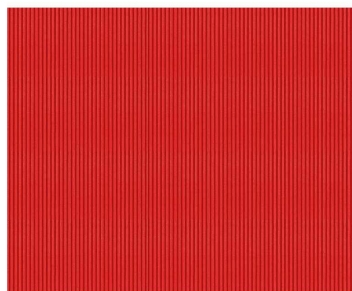

PAPEL MICROONDULADO VERMELH 48X80CM 10X1
Código: 19220 Fábrica: REIPEL/VMP Unidade: PT/10 F1 F4

UN: R\$ 678,81 AV: R\$ 678,81 15: R\$ 692,95
30: R\$ 706,81 45: R\$ 720,95 60: R\$ 735,37



PAPEL NACARADO BOB TRANSP 90CMX100MTS
Código: 45815 Fábrica: CROMUS Unidade: UN/1 F1 F4

UN: R\$ 0,96 AV: R\$ 19,17 15: R\$ 19,57
30: R\$ 19,96 45: R\$ 20,36 60: R\$ 20,77



PAPEL OFF PLUS A4 180GR VERDE 20X1
Código: 45890 Fábrica: OFF PAPER Unidade: PT/20 F1 F4

UN: R\$ 0,96 AV: R\$ 19,17 15: R\$ 19,57
30: R\$ 19,96 45: R\$ 20,36 60: R\$ 20,77



PAPEL OFF PLUS A4 180GR AMARELO 20X1
Código: 45886 Fábrica: OFF PAPER Unidade: PT/20 F1 F4

UN: R\$ 0,96 AV: R\$ 19,17 15: R\$ 19,57
30: R\$ 19,96 45: R\$ 20,36 60: R\$ 20,77



PAPÉL OFF PLUS A4 180GR AZUL 20X1
Código: 45607 Fábrica: OFF PAPER Unidade: PT/20
F1 F4

UN: R\$ 0,96 AV: R\$ 19,17 15: R\$ 19,57
30: R\$ 19,96 45: R\$ 20,36 60: R\$ 20,77



PAPÉL OFF PLUS A4 180GR PRETO 20X1
Código: 45889 Fábrica: OFF PAPER Unidade: PT/20
F1 F4

UN: R\$ 0,96 AV: R\$ 19,17 15: R\$ 19,57
30: R\$ 19,96 45: R\$ 20,36 60: R\$ 20,77



PAPÉL OFF PLUS A4 180GR VERMELHO 20X1
Código: 45888 Fábrica: OFF PAPER Unidade: PT/20
F1 F4

UN: R\$ 0,47 AV: R\$ 9,39 15: R\$ 9,58
30: R\$ 9,77 45: R\$ 9,97 60: R\$ 10,17



PAPÉL OPALINE A4 120GR 40KG AMARELO 20X1
Código: 48919 Fábrica: MASTERPRINT Unidade: PT/20
F1 F4

UN: R\$ 0,47 AV: R\$ 9,39 15: R\$ 9,58
30: R\$ 9,77 45: R\$ 9,97 60: R\$ 10,17



PAPÉL OPALINE A4 120GR 40KG AZUL 20X1
Código: 48930 Fábrica: MASTERPRINT Unidade: PT/20
F1 F4

UN: R\$ 0,30 AV: R\$ 14,97 15: R\$ 15,28
30: R\$ 15,58 45: R\$ 15,90 60: R\$ 16,21



PAPÉL OPALINE A4 120GR 40KG BRANCO 50X1
Código: 45127 Fábrica: MASTERPRINT Unidade: PT/50
F1 F4

UN: R\$ 0,47 AV: R\$ 9,39 15: R\$ 9,58
30: R\$ 9,77 45: R\$ 9,97 60: R\$ 10,17



PAPÉL OPALINE A4 120GR 40KG CINZA 20X1
Código: 48924 Fábrica: MASTERPRINT Unidade: PT/20
F1 F4

UN: R\$ 0,47 AV: R\$ 9,39 15: R\$ 9,58
30: R\$ 9,77 45: R\$ 9,97 60: R\$ 10,17



PAPÉL OPALINE A4 120GR 40KG LARANJA 20X1
Código: 48931 Fábrica: MASTERPRINT Unidade: PT/20
F1 F4

UN: R\$ 0,47 AV: R\$ 9,39 15: R\$ 9,58
30: R\$ 9,77 45: R\$ 9,97 60: R\$ 10,17



PAPÉL OPALINE A4 120GR 40KG OURO 20X1
Código: 48925 Fábrica: MASTERPRINT Unidade: PT/20
F1 F4

UN: R\$ 0,47 AV: R\$ 9,39 15: R\$ 9,58
30: R\$ 9,77 45: R\$ 9,97 60: R\$ 10,17



PAPÉL OPALINE A4 120GR 40KG PRETO 20X1
Código: 48926 Fábrica: MASTERPRINT Unidade: PT/20
F1 F4

UN: R\$ 0,47 AV: R\$ 9,39 15: R\$ 9,58
30: R\$ 9,77 45: R\$ 9,97 60: R\$ 10,17



PAPÉL OPALINE A4 120GR 40KG ROSA 20X1
Código: 48929 Fábrica: MASTERPRINT Unidade: PT/20
F1 F4

UN: R\$ 0,47 AV: R\$ 9,39 15: R\$ 9,58
30: R\$ 9,77 45: R\$ 9,97 60: R\$ 10,17



PAPÉL OPALINE A4 120GR 40KG ROXO 20X1
Código: 48928 Fábrica: MASTERPRINT Unidade: PT/20
F1 F4

UN: R\$ 0,47 AV: R\$ 9,39 15: R\$ 9,58
30: R\$ 9,77 45: R\$ 9,97 60: R\$ 10,17

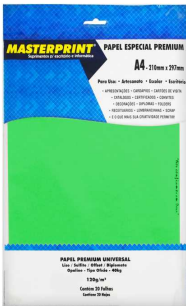

PAPÉL OPALINE A4 120GR 40KG VERDE 20X1
Código: 48932 Fábrica: MASTERPRINT Unidade: PT/20
F1 F4

UN: R\$ 0,47 AV: R\$ 9,39 15: R\$ 9,58
30: R\$ 9,77 45: R\$ 9,97 60: R\$ 10,17



PAPÉL OPALINE A4 120GR 40KG VERM 20X1
Código: 48927 Fábrica: MASTERPRINT Unidade: PT/20
F1 F4

UN: R\$ 0,36 AV: R\$ 17,76 15: R\$ 18,13
30: R\$ 18,49 45: R\$ 18,86 60: R\$ 19,24



PAPÉL OPALINE A4 120GR 40KG 10CORES 50X1
Código: 48918 Fábrica: MASTERPRINT Unidade: PT/50
F1 F4

UN: R\$ 0,43 AV: R\$ 21,65 15: R\$ 22,10
30: R\$ 22,54 45: R\$ 22,99 60: R\$ 23,45



PAPÉL OPALINE A4 180GR 60KG AMARELO 50X1
Código: 45989 Fábrica: MASTERPRINT Unidade: PT/50
F1 F4

UN: R\$ 0,43 AV: R\$ 21,65 15: R\$ 22,10
30: R\$ 22,54 45: R\$ 22,99 60: R\$ 23,45



PAPEL OPALINE A4 180GR 60KG AZUL 50X1
Código: Fábrika: Unidade:
45993 MASTERPRINT PT/50
F1 F4

UN: R\$ 0,40 AV: R\$ 19,96 15: R\$ 20,37
30: R\$ 20,78 45: R\$ 21,20 60: R\$ 21,62



PAPEL OPALINE A4 180GR 60KG BRANCO 50X1
Código: Fábrika: Unidade:
45114 MASTERPRINT PT/50
F1 F4

UN: R\$ 0,92 AV: R\$ 18,47 15: R\$ 18,86
30: R\$ 19,23 45: R\$ 19,62 60: R\$ 20,01



PAPEL OPALINE A4 180GR 60KG PINK NEO20X1
Código: Fábrika: Unidade:
48916 MASTERPRINT PT/20
F1 F4

UN: R\$ 0,37 AV: R\$ 18,47 15: R\$ 18,86
30: R\$ 19,23 45: R\$ 19,62 60: R\$ 20,01



PAPEL OPALINE A4 180GR 60KG PRETO 50X1
Código: Fábrika: Unidade:
49065 MASTERPRINT PT/50
F1 F4

UN: R\$ 0,43 AV: R\$ 21,65 15: R\$ 22,10
30: R\$ 22,54 45: R\$ 22,99 60: R\$ 23,45



PAPEL OPALINE A4 180GR 60KG ROSA 50X1
Código: Fábrika: Unidade:
45990 MASTERPRINT PT/50
F1 F4

UN: R\$ 0,43 AV: R\$ 21,65 15: R\$ 22,10
30: R\$ 22,54 45: R\$ 22,99 60: R\$ 23,45



PAPEL OPALINE A4 180GR 60KG VERDE 50X1
Código: Fábrika: Unidade:
45991 MASTERPRINT PT/50
F1 F4

UN: R\$ 0,47 AV: R\$ 9,39 15: R\$ 9,58
30: R\$ 9,77 45: R\$ 9,97 60: R\$ 10,17



PAPEL OPALINE A4 180GR 60KG 4CORES 20X1
Código: Fábrika: Unidade:
48917 MASTERPRINT PT/20
F1 F4

UN: R\$ 7,99 AV: R\$ 79,86 15: R\$ 81,53
30: R\$ 83,16 45: R\$ 84,82 60: R\$ 86,52



PAPEL PARANA 80X100CM N120 10 FLS
Código: Fábrika: Unidade:
34399 VMP PT/10
F1 F4

UN: R\$ 1,32 AV: R\$ 32,94 15: R\$ 33,62
30: R\$ 34,30 45: R\$ 34,98 60: R\$ 35,68

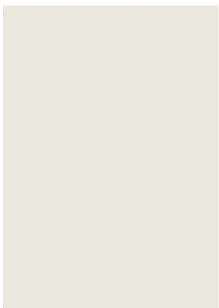

PAPEL PEROLA A4 120GR PRATA 25X1
Código: Fábrika: Unidade:
48263 AGAPE PT/25
F1 F4

UN: R\$ 1,33 AV: R\$ 39,93 15: R\$ 40,76
30: R\$ 41,57 45: R\$ 42,40 60: R\$ 43,25



PAPEL PEROLA A4 180GR AMARELO 30X1
Código: Fábrika: Unidade:
41363 USAPEL PT/30
F1 F4

UN: R\$ 1,32 AV: R\$ 32,94 15: R\$ 33,62
30: R\$ 34,30 45: R\$ 34,98 60: R\$ 35,68

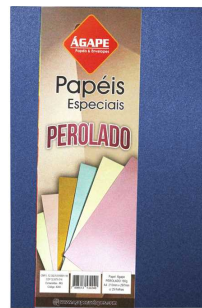

PAPEL PEROLA A4 180GR AZUL 25X1
Código: Fábrika: Unidade:
45642 AGAPE PT/25
F1 F4

UN: R\$ 1,00 AV: R\$ 19,96 15: R\$ 20,37
30: R\$ 20,78 45: R\$ 21,20 60: R\$ 21,62



PAPEL PEROLA A4 180GR BRANCO 20X1
Código: Fábrika: Unidade:
48935 MASTERPRINT PT/20
F1 F4

UN: R\$ 1,32 AV: R\$ 32,94 15: R\$ 33,62
30: R\$ 34,30 45: R\$ 34,98 60: R\$ 35,68



PAPEL PEROLA A4 180GR BRANCO 25X1
Código: Fábrika: Unidade:
45643 AGAPE PT/25
F1 F4

UN: R\$ 1,33 AV: R\$ 39,93 15: R\$ 40,76
30: R\$ 41,57 45: R\$ 42,40 60: R\$ 43,25



PAPEL PEROLA A4 180GR BRANCO 30X1
Código: Fábrika: Unidade:
41365 USAPEL PT/30
F1 F4

UN: R\$ 1,30 AV: R\$ 25,95 15: R\$ 26,49
30: R\$ 27,02 45: R\$ 27,56 60: R\$ 28,11



PAPEL PEROLA A4 180GR CHAMP ROSE 20X1
Código: Fábrika: Unidade:
48921 MASTERPRINT PT/20
F1 F4

UN: R\$ 1,00 AV: R\$ 19,96 15: R\$ 20,37
30: R\$ 20,78 45: R\$ 21,20 60: R\$ 21,62



PAPEL PEROLA A4 180GR DOURADO 20X1
Código: Fábrika: Unidade:
48920 MASTERPRINT PT/20
F1 F4

UN: R\$ 1,00 AV: R\$ 19,96 15: R\$ 20,37
30: R\$ 20,78 45: R\$ 21,20 60: R\$ 21,62



PAPEL PEROLA A4 180GR PRATA 20X1
Código: Fábriça: Unidade:
48923 MASTERPRINT PT/20
F1 F4

UN: R\$ 1,20 AV: R\$ 36,09 15: R\$ 36,84
30: R\$ 37,58 45: R\$ 38,33 60: R\$ 39,10

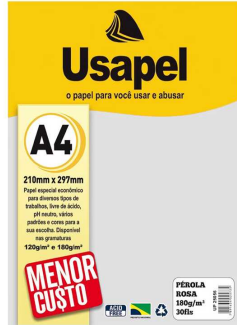

PAPEL PEROLA A4 180GR PRATA 30X1
Código: Fábriça: Unidade:
41364 USAPEL PT/30
F1 F4

UN: R\$ 1,20 AV: R\$ 29,94 15: R\$ 30,57
30: R\$ 31,18 45: R\$ 31,80 60: R\$ 32,44



PAPEL PEROLA A4 180GR ROSA 25X1
Código: Fábriça: Unidade:
45644 AGAPE PT/25
F1 F4

UN: R\$ 1,33 AV: R\$ 39,93 15: R\$ 40,76
30: R\$ 41,57 45: R\$ 42,40 60: R\$ 43,25



PAPEL PEROLA A4 180GR ROSA 30X1
Código: Fábriça: Unidade:
41366 USAPEL PT/30
F1 F4

UN: R\$ 1,30 AV: R\$ 25,95 15: R\$ 26,49
30: R\$ 27,02 45: R\$ 27,56 60: R\$ 28,11



PAPEL PEROLA A4 180GR 4 CORES 20X1
Código: Fábriça: Unidade:
48922 MASTERPRINT PT/20
F1 F4

UN: R\$ 0,37 AV: R\$ 14,97 15: R\$ 15,28
30: R\$ 15,58 45: R\$ 15,90 60: R\$ 16,21



PAPEL PLAST PRESENTE METAL 45X65CM 40X1
Código: Fábriça: Unidade:
32398 HAI BRASIL PT/40
F1 F4

UN: R\$ 0,45 AV: R\$ 8,99 15: R\$ 8,99
30: R\$ 8,99 45: R\$ 8,99 60: R\$ 8,99



PAPEL PRES COUC ANIVERSARIO 50X60CM 20X1
Código: Fábriça: Unidade:
40336 SAO JOAO PT/20
F1 F4

UN: R\$ 79,86 AV: R\$ 79,86 15: R\$ 81,53
30: R\$ 83,16 45: R\$ 84,82 60: R\$ 86,52



PAPEL PRES COUC BOB 40CM AMARELO 100M
Código: Fábriça: Unidade:
49168 SAO JOAO RL/1
F1 F4

UN: R\$ 69,99 AV: R\$ 69,99 15: R\$ 69,99
30: R\$ 69,99 45: R\$ 69,99 60: R\$ 69,99



PAPEL PRES COUC BOB 40CM CAS 100M
Código: Fábriça: Unidade:
46680 SAO JOAO RL/1
F1 F4

UN: R\$ 69,99 AV: R\$ 69,99 15: R\$ 69,99
30: R\$ 69,99 45: R\$ 69,99 60: R\$ 69,99



PAPEL PRES COUC BOB 40CM FEM 100M
Código: Fábriça: Unidade:
34839 SAO JOAO RL/1
F1 F4

UN: R\$ 69,99 AV: R\$ 69,99 15: R\$ 69,99
30: R\$ 69,99 45: R\$ 69,99 60: R\$ 69,99



PAPEL PRES COUC BOB 40CM INF 100M
Código: Fábriça: Unidade:
43743 SAO JOAO RL/1
F1 F4

UN: R\$ 69,99 AV: R\$ 69,99 15: R\$ 69,99
30: R\$ 69,99 45: R\$ 69,99 60: R\$ 69,99



PAPEL PRES COUC BOB 40CM NATAL 100M
Código: Fábriça: Unidade:
49173 SAO JOAO RL/1
F1 F4

UN: R\$ 69,99 AV: R\$ 69,99 15: R\$ 69,99
30: R\$ 69,99 45: R\$ 69,99 60: R\$ 69,99



PAPEL PRES COUC BOB 40CM ROMANT COR 100M
Código: Fábriça: Unidade:
46698 SAO JOAO RL/1
F1 F4

UN: R\$ 69,99 AV: R\$ 69,99 15: R\$ 69,99
30: R\$ 69,99 45: R\$ 69,99 60: R\$ 69,99



PAPEL PRES COUC BOB 40CM 2 TEMAS 100M
Código: Fábriça: Unidade:
49986 SAO JOAO RL/1
F1 F4

UN: R\$ 109,81 AV: R\$ 109,81 15: R\$ 112,10
30: R\$ 114,34 45: R\$ 116,63 60: R\$ 118,96



PAPEL PRES COUC BOB 60CM AMARELO 100M
Código: Fábriça: Unidade:
49169 SAO JOAO RL/1
F1 F4

UN: R\$ 99,99 AV: R\$ 99,99 15: R\$ 99,99
30: R\$ 99,99 45: R\$ 99,99 60: R\$ 99,99



PAPEL PRES COUC BOB 60CM CAS 100M
Código: Fábriça: Unidade:
46760 SAO JOAO RL/1
F1 F4

UN: R\$ 99,99 AV: R\$ 99,99 15: R\$ 99,99
30: R\$ 99,99 45: R\$ 99,99 60: R\$ 99,99



PAPEL PRES COUC BOB 60CM FEM 100M

Código: Fábrika: Unidade:
29095 SAO JOAO RL/1
F1 F4

UN: R\$ 99,99 AV: R\$ 99,99 15: R\$ 99,99
30: R\$ 99,99 45: R\$ 99,99 60: R\$ 99,99



PAPEL PRES COUC BOB 60CM INF 70M

Código: Fábrika: Unidade:
35309 SAO JOAO RL/1
F1 F4

UN: R\$ 109,81 AV: R\$ 109,81 15: R\$ 112,10
30: R\$ 114,34 45: R\$ 116,63 60: R\$ 118,96



PAPEL PRES COUC BOB 60CM INF 100M

Código: Fábrika: Unidade:
46755 SAO JOAO RL/1
F1 F4

UN: R\$ 99,99 AV: R\$ 99,99 15: R\$ 99,99
30: R\$ 99,99 45: R\$ 99,99 60: R\$ 99,99



PAPEL PRES COUC BOB 60CM NATAL 100M

Código: Fábrika: Unidade:
49174 SAO JOAO RL/1
F1 F4

UN: R\$ 99,99 AV: R\$ 99,99 15: R\$ 99,99
30: R\$ 99,99 45: R\$ 99,99 60: R\$ 99,99



PAPEL PRES COUC BOB 60CM 2 TEMAS 100M

Código: Fábrika: Unidade:
49982 SAO JOAO RL/1
F1 F4

UN: R\$ 0,45 AV: R\$ 8,99 15: R\$ 8,99
30: R\$ 8,99 45: R\$ 8,99 60: R\$ 8,99



PAPEL PRES COUC CASUAL 50X60CM 20X1

Código: Fábrika: Unidade:
43115 SAO JOAO PT/20
F1 F4

UN: R\$ 0,45 AV: R\$ 8,99 15: R\$ 8,99
30: R\$ 8,99 45: R\$ 8,99 60: R\$ 8,99

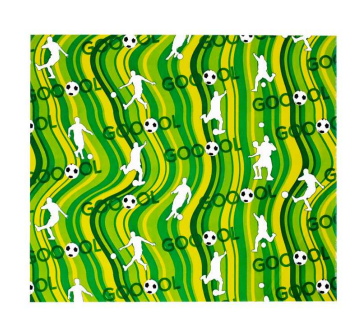

PAPEL PRES COUC COPA GOL 50X60CM 20X1

Código: Fábrika: Unidade:
39577 VMP PT/20
F1 F4

UN: R\$ 0,45 AV: R\$ 8,99 15: R\$ 8,99
30: R\$ 8,99 45: R\$ 8,99 60: R\$ 8,99

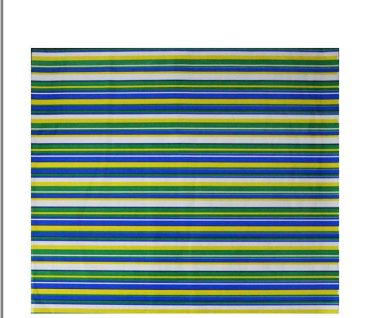

PAPEL PRES COUC COPA LISTR 50X60CM 20X1

Código: Fábrika: Unidade:
39576 VMP PT/20
F1 F4

UN: R\$ 0,45 AV: R\$ 8,99 15: R\$ 8,99
30: R\$ 8,99 45: R\$ 8,99 60: R\$ 8,99



PAPEL PRES COUC COPA R HEXA 50X60CM 20X1

Código: Fábrika: Unidade:
39578 VMP PT/20
F1 F4

UN: R\$ 0,45 AV: R\$ 8,99 15: R\$ 8,99
30: R\$ 8,99 45: R\$ 8,99 60: R\$ 8,99



PAPEL PRES COUC FEMININO 50X60CM 20X1

Código: Fábrika: Unidade:
33065 SAO JOAO PT/20
F1 F4

UN: R\$ 0,45 AV: R\$ 8,99 15: R\$ 8,99
30: R\$ 8,99 45: R\$ 8,99 60: R\$ 8,99



PAPEL PRES COUC INFANTIL 50X60CM 20X1

Código: Fábrika: Unidade:
43135 SAO JOAO PT/20
F1 F4

UN: R\$ 0,45 AV: R\$ 8,99 15: R\$ 8,99
30: R\$ 8,99 45: R\$ 8,99 60: R\$ 8,99



PAPEL PRES COUC NATAL 50X60CM 20X1

Código: Fábrika: Unidade:
43715 SAO JOAO PT/20
F1 F4

UN: R\$ 0,45 AV: R\$ 8,99 15: R\$ 8,99
30: R\$ 8,99 45: R\$ 8,99 60: R\$ 8,99



PAPEL PRES COUC ROMANTICO 50X60CM 20X1

Código: Fábrika: Unidade:
36784 SAO JOAO PT/20
F1 F4

UN: R\$ 0,45 AV: R\$ 8,99 15: R\$ 8,99
30: R\$ 8,99 45: R\$ 8,99 60: R\$ 8,99

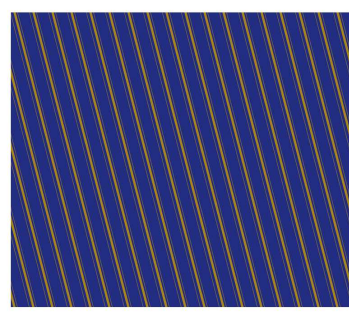

PAPEL PRES COUC 016 CAS AZUL 50X60 20X1

Código: Fábrika: Unidade:
40962 SAO JOAO PT/20
F1 F4

UN: R\$ 0,45 AV: R\$ 8,99 15: R\$ 8,99
30: R\$ 8,99 45: R\$ 8,99 60: R\$ 8,99

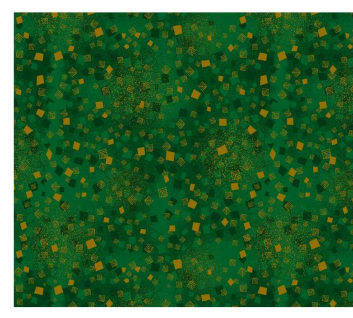

PAPEL PRES COUC 178 CAS VERDE 50X60 20X1

Código: Fábrika: Unidade:
34823 SAO JOAO PT/20
F1 F4

UN: R\$ 0,45 AV: R\$ 8,99 15: R\$ 8,99
30: R\$ 8,99 45: R\$ 8,99 60: R\$ 8,99



PAPEL PRES COUC 349 CAS AZUL 50X60 20X1

Código: Fábrika: Unidade:
15810 SAO JOAO PT/20
F1 F4

UN: R\$ 0,06 AV: R\$ 2,99 15: R\$ 3,05
30: R\$ 3,11 45: R\$ 3,17 60: R\$ 3,23



PAPEL SEDA P/BALA AZUL CLARO 48X1

Código: 39209 Fábrica: PEL PLAST Unidade: PT/48 F1 F4

UN: R\$ 0,06 AV: R\$ 2,99 15: R\$ 3,05
30: R\$ 3,11 45: R\$ 3,17 60: R\$ 3,23



PAPEL SEDA P/BALA AZUL ESC 48X1

Código: 7995 Fábrica: PEL PLAST Unidade: PT/48 F1 F4

UN: R\$ 0,06 AV: R\$ 2,99 15: R\$ 3,05
30: R\$ 3,11 45: R\$ 3,17 60: R\$ 3,23



PAPEL SEDA P/BALA BRANCO 48X1

Código: 8000 Fábrica: PEL PLAST Unidade: PT/48 F1 F4

UN: R\$ 0,06 AV: R\$ 2,99 15: R\$ 3,05
30: R\$ 3,11 45: R\$ 3,17 60: R\$ 3,23



PAPEL SEDA P/BALA LILAS 48X1

Código: 27707 Fábrica: PEL PLAST Unidade: PT/48 F1 F4

UN: R\$ 0,06 AV: R\$ 2,99 15: R\$ 3,05
30: R\$ 3,11 45: R\$ 3,17 60: R\$ 3,23



PAPEL SEDA P/BALA ROSA 48X1

Código: 7997 Fábrica: PEL PLAST Unidade: PT/48 F1 F4

UN: R\$ 0,06 AV: R\$ 2,99 15: R\$ 3,05
30: R\$ 3,11 45: R\$ 3,17 60: R\$ 3,23



PAPEL SEDA P/BALA VERDE LIMA0 48X1

Código: 25623 Fábrica: PEL PLAST Unidade: PT/48 F1 F4

UN: R\$ 0,06 AV: R\$ 2,99 15: R\$ 3,05
30: R\$ 3,11 45: R\$ 3,17 60: R\$ 3,23



PAPEL SEDA P/BALA VERMELHO 48X1

Código: 7998 Fábrica: PEL PLAST Unidade: PT/48 F1 F4

UN: R\$ 0,62 AV: R\$ 24,95 15: R\$ 25,47
30: R\$ 25,98 45: R\$ 26,50 60: R\$ 27,03

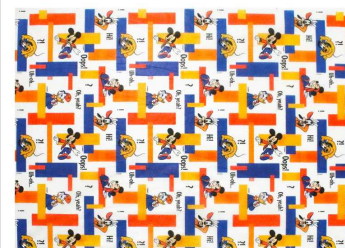

PAPEL SEDA ESTAMPADO MICKEY 40X1

Código: 19367 Fábrica: JARAGUA Unidade: PT/40 F1 F4

UN: R\$ 1,00 AV: R\$ 39,93 15: R\$ 40,76
30: R\$ 41,57 45: R\$ 42,40 60: R\$ 43,25



PAPEL SEDA IMPERM AZUL 48X59CM 40X1

Código: 33153 Fábrica: EMBALE Unidade: PT/40 F1 F4

UN: R\$ 0,87 AV: R\$ 34,93 15: R\$ 35,66
30: R\$ 36,38 45: R\$ 37,10 60: R\$ 37,84

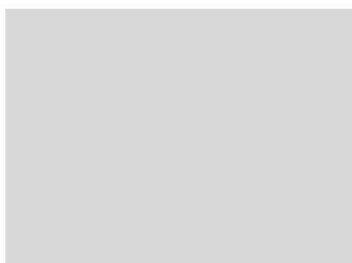

PAPEL SEDA IMPERM BRANCO 48X59CM 40X1

Código: 27160 Fábrica: EMBALE Unidade: PT/40 F1 F4

UN: R\$ 1,00 AV: R\$ 39,93 15: R\$ 40,76
30: R\$ 41,57 45: R\$ 42,40 60: R\$ 43,25



PAPEL SEDA IMPERM PINK 48X59CM 40X1

Código: 33234 Fábrica: EMBALE Unidade: PT/40 F1 F4

UN: R\$ 1,00 AV: R\$ 39,93 15: R\$ 40,76
30: R\$ 41,57 45: R\$ 42,40 60: R\$ 43,25



PAPEL SEDA IMPERM VERDE 48X59CM 40X1

Código: 33154 Fábrica: EMBALE Unidade: PT/40 F1 F4

UN: R\$ 1,00 AV: R\$ 39,93 15: R\$ 40,76
30: R\$ 41,57 45: R\$ 42,40 60: R\$ 43,25



PAPEL SEDA IMPERM VERMELHO 48X59CM 40X1

Código: 32409 Fábrica: EMBALE Unidade: PT/40 F1 F4

UN: R\$ 0,30 AV: R\$ 29,94 15: R\$ 30,57
30: R\$ 31,18 45: R\$ 31,80 60: R\$ 32,44



PAPEL SEDA 48X60CM AMARELO CANARIO 100X1

Código: 15613 Fábrica: ARTFLOC Unidade: PT/100 F1 F4

UN: R\$ 0,30 AV: R\$ 29,94 15: R\$ 30,57
30: R\$ 31,18 45: R\$ 31,80 60: R\$ 32,44



PAPEL SEDA 48X60CM AMARELO OURO 100X1

Código: 46888 Fábrica: ART FLOC Unidade: PT/100 F1 F4

UN: R\$ 0,30 AV: R\$ 29,94 15: R\$ 30,57
30: R\$ 31,18 45: R\$ 31,80 60: R\$ 32,44

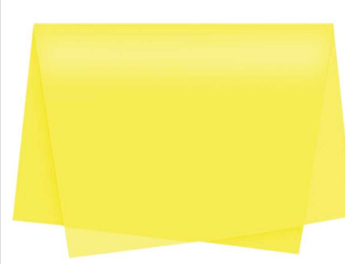

PAPEL SEDA 48X60CM AMARELO 100X1

Código: 44779 Fábrica: ARTFLOC/NOVA Unidade: PT/100 F1 F4

UN: R\$ 0,30 AV: R\$ 29,94 15: R\$ 30,57
30: R\$ 31,18 45: R\$ 31,80 60: R\$ 32,44

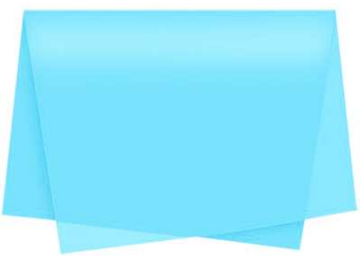

PAPEL SEDA 48X60CM AZUL CLARO 100X1
Código: Fábrica: Unidade:
15622 ARTFLOC PT/100
F1 F4

UN: R\$ 0,30 AV: R\$ 29,94 15: R\$ 30,57
30: R\$ 31,18 45: R\$ 31,80 60: R\$ 32,44



PAPEL SEDA 48X60CM AZUL ESCURO 100X1
Código: Fábrica: Unidade:
44780 ARTFLOC/NOVA PT/100
F1 F4

UN: R\$ 0,30 AV: R\$ 29,94 15: R\$ 30,57
30: R\$ 31,18 45: R\$ 31,80 60: R\$ 32,44



PAPEL SEDA 48X60CM AZUL MARINHO 100X1
Código: Fábrica: Unidade:
15617 ARTFLOC PT/100
F1 F4

UN: R\$ 0,30 AV: R\$ 29,94 15: R\$ 30,57
30: R\$ 31,18 45: R\$ 31,80 60: R\$ 32,44



PAPEL SEDA 48X60CM AZUL PISCINA 100X1
Código: Fábrica: Unidade:
22594 ARTFLOC PT/100
F1 F4

UN: R\$ 0,30 AV: R\$ 29,94 15: R\$ 30,57
30: R\$ 31,18 45: R\$ 31,80 60: R\$ 32,44

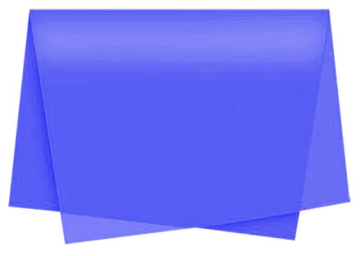

PAPEL SEDA 48X60CM AZUL ROYAL 100X1
Código: Fábrica: Unidade:
19660 ARTFLOC PT/100
F1 F4

UN: R\$ 0,26 AV: R\$ 25,95 15: R\$ 26,49
30: R\$ 27,02 45: R\$ 27,56 60: R\$ 28,11



PAPEL SEDA 48X60CM BRANCO 100X1
Código: Fábrica: Unidade:
1602 ART FLOC PT/100
F1 F4

UN: R\$ 0,30 AV: R\$ 29,94 15: R\$ 30,57
30: R\$ 31,18 45: R\$ 31,80 60: R\$ 32,44

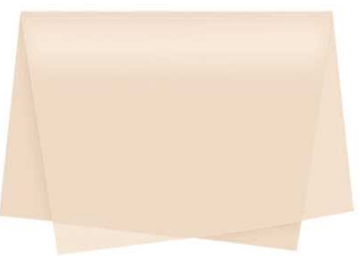

PAPEL SEDA 48X60CM CHAMPAGNE 100X1
Código: Fábrica: Unidade:
20638 ARTFLOC PT/100
F1 F4

UN: R\$ 0,30 AV: R\$ 29,94 15: R\$ 30,57
30: R\$ 31,18 45: R\$ 31,80 60: R\$ 32,44



PAPEL SEDA 48X60CM LARANJA 100X1
Código: Fábrica: Unidade:
15618 ARTFLOC PT/100
F1 F4

UN: R\$ 0,30 AV: R\$ 29,94 15: R\$ 30,57
30: R\$ 31,18 45: R\$ 31,80 60: R\$ 32,44



PAPEL SEDA 48X60CM LILAS 100X1
Código: Fábrica: Unidade:
15616 ARTFLOC/NOVA PT/100
F1 F4

UN: R\$ 0,30 AV: R\$ 29,94 15: R\$ 30,57
30: R\$ 31,18 45: R\$ 31,80 60: R\$ 32,44

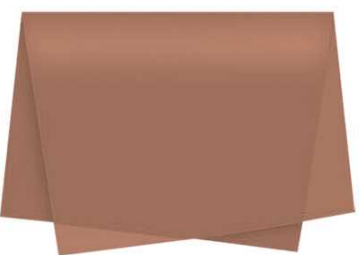

PAPEL SEDA 48X60CM MARRON 100X1
Código: Fábrica: Unidade:
15620 ARTFLOC/NOVA PT/100
F1 F4

UN: R\$ 0,30 AV: R\$ 29,94 15: R\$ 30,57
30: R\$ 31,18 45: R\$ 31,80 60: R\$ 32,44



PAPEL SEDA 48X60CM PRETO 100X1
Código: Fábrica: Unidade:
18406 ARTFLOC PT/100
F1 F4

UN: R\$ 0,30 AV: R\$ 29,94 15: R\$ 30,57
30: R\$ 31,18 45: R\$ 31,80 60: R\$ 32,44



PAPEL SEDA 48X60CM ROSA BEBE 100X1
Código: Fábrica: Unidade:
33870 EMBALE PT/100
F1 F4

UN: R\$ 0,30 AV: R\$ 29,94 15: R\$ 30,57
30: R\$ 31,18 45: R\$ 31,80 60: R\$ 32,44



PAPEL SEDA 48X60CM ROSA CLARO 100X1
Código: Fábrica: Unidade:
38342 ARTFLOC PT/100
F1 F4

UN: R\$ 0,30 AV: R\$ 29,94 15: R\$ 30,57
30: R\$ 31,18 45: R\$ 31,80 60: R\$ 32,44



PAPEL SEDA 48X60CM ROSA PINK 100X1
Código: Fábrica: Unidade:
6299 ARTFLOC PT/100
F1 F4

UN: R\$ 0,30 AV: R\$ 29,94 15: R\$ 30,57
30: R\$ 31,18 45: R\$ 31,80 60: R\$ 32,44



PAPEL SEDA 48X60CM ROSA 100X1
Código: Fábrica: Unidade:
15614 ARTFLOC PT/100
F1 F4

UN: R\$ 0,30 AV: R\$ 29,94 15: R\$ 30,57
30: R\$ 31,18 45: R\$ 31,80 60: R\$ 32,44



PAPEL SEDA 48X60CM ROXO 100X1
Código: Fábrica: Unidade:
8052 ARTFLOC PT/100
F1 F4

UN: R\$ 0,30 AV: R\$ 29,94 15: R\$ 30,57
30: R\$ 31,18 45: R\$ 31,80 60: R\$ 32,44



PAPEL SEDA 48X60CM SALMAO 100X1

Código: 19369 Fábrica: ART FLOC Unidade: PT/100
F1 F4

UN: R\$ 0,30 AV: R\$ 29,94 15: R\$ 30,57
30: R\$ 31,18 45: R\$ 31,80 60: R\$ 32,44



PAPEL SEDA 48X60CM VERDE BANDEIRA 100X1

Código: 15615 Fábrica: ARTFLOC/NOVA Unidade: PT/100
F1 F4

UN: R\$ 0,30 AV: R\$ 29,94 15: R\$ 30,57
30: R\$ 31,18 45: R\$ 31,80 60: R\$ 32,44



PAPEL SEDA 48X60CM VERDE CLARO 100X1

Código: 15621 Fábrica: EMBALE/ARTFL Unidade: PT/100
F1 F4

UN: R\$ 0,30 AV: R\$ 29,94 15: R\$ 30,57
30: R\$ 31,18 45: R\$ 31,80 60: R\$ 32,44



PAPEL SEDA 48X60CM VERDE FOLHA 100X1

Código: 44778 Fábrica: ARTFLOC/NOVA Unidade: PT/100
F1 F4

UN: R\$ 0,30 AV: R\$ 29,94 15: R\$ 30,57
30: R\$ 31,18 45: R\$ 31,80 60: R\$ 32,44



PAPEL SEDA 48X60CM VERDE LIMAO 100X1

Código: 38343 Fábrica: ART FLOC Unidade: PT/100
F1 F4

UN: R\$ 0,30 AV: R\$ 29,94 15: R\$ 30,57
30: R\$ 31,18 45: R\$ 31,80 60: R\$ 32,44



PAPEL SEDA 48X60CM VERMELHO 100X1

Código: 15619 Fábrica: ART FLOC Unidade: PT/100
F1 F4

UN: R\$ 0,30 AV: R\$ 29,94 15: R\$ 30,57
30: R\$ 31,18 45: R\$ 31,80 60: R\$ 32,44



PAPEL SEDA 48X60CM VINHO 100X1

Código: 19656 Fábrica: ARTFLOC Unidade: PT/100
F1 F4

UN: R\$ 0,30 AV: R\$ 29,94 15: R\$ 30,57
30: R\$ 31,18 45: R\$ 31,80 60: R\$ 32,44



PAPEL SEDA 48X60CM VIOLETA 100X1

Código: 38344 Fábrica: ARTFLOC Unidade: PT/100
F1 F4

UN: R\$ 339,45 AV: R\$ 339,45 15: R\$ 346,52
30: R\$ 353,45 45: R\$ 360,52 60: R\$ 367,73



PAPEL SEMI KRAFT BOB 80G 120CMX200MX20KG

Código: 47304 Fábrica: JUSSARA Unidade: RL/1
F1 F4

UN: R\$ 0,80 AV: R\$ 159,73 15: R\$ 163,06
30: R\$ 166,32 45: R\$ 169,65 60: R\$ 173,04

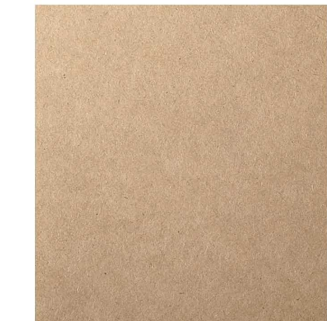

PAPEL SEMI KRAFT 80GRS 66X96CM 400 200X1

Código: 39981 Fábrica: SANTECK Unidade: PT/200
F1 F4

UN: R\$ 0,05 AV: R\$ 22,99 15: R\$ 22,99
30: R\$ 22,99 45: R\$ 22,99 60: R\$ 22,99



PAPEL SULFITE BCO 216X279MM 500 FLS

Código: 50698 Fábrica: CHAMEX Unidade: PT/500
F1 F4

UN: R\$ 0,04 AV: R\$ 3,99 15: R\$ 3,99
30: R\$ 3,99 45: R\$ 3,99 60: R\$ 3,99



PAPEL SULFITE BRANCO 216X279MM 100X1

Código: 7314 Fábrica: CHAMEX Unidade: PT/100
F1 F4

UN: R\$ 5,99 AV: R\$ 29,94 15: R\$ 30,57
30: R\$ 31,18 45: R\$ 31,80 60: R\$ 32,44



PAPEL TRANSFER A4 160GR TECIDO CLA 5X1

Código: 40674 Fábrica: MASTERPRINT Unidade: PT/5
F1 F4

UN: R\$ 10,65 AV: R\$ 53,26 15: R\$ 54,37
30: R\$ 55,46 45: R\$ 56,57 60: R\$ 57,70



PAPEL TRANSFER A4 235GR TECIDO ESC 5X1

Código: 40673 Fábrica: MASTERPRINT Unidade: PT/5
F1 F4

UN: R\$ 1,00 AV: R\$ 49,91 15: R\$ 50,95
30: R\$ 51,97 45: R\$ 53,01 60: R\$ 54,07



PAPEL VEGETAL A4 90/95GRS 50X1

Código: 51023 Fábrica: MARES Unidade: PT/50
F1 F4

UN: R\$ 0,36 AV: R\$ 17,96 15: R\$ 18,34
30: R\$ 18,70 45: R\$ 19,08 60: R\$ 19,46

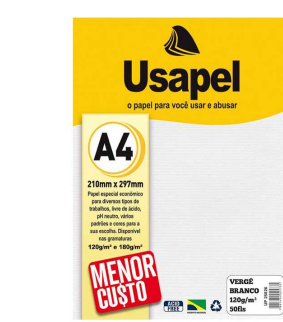

PAPEL VERGE A4 120GR BRANCO 50X1

Código: 48765 Fábrica: USAPPEL Unidade: PT/50
F1 F4

UN: R\$ 0,32 AV: R\$ 15,96 15: R\$ 16,30
30: R\$ 16,62 45: R\$ 16,96 60: R\$ 17,29



PAPEL VERGE A4 120GR BRANCO 50X1
Código: 48934 Fábrica: MASTERPRINT Unidade: PT/50 F1 F4

UN: R\$ 0,33 AV: R\$ 16,66 15: R\$ 17,01
30: R\$ 17,35 45: R\$ 17,70 60: R\$ 18,05



PAPEL VERGE A4 120GR CREME 50X1
Código: 48767 Fábrica: USAPEL Unidade: PT/50 F1 F4

UN: R\$ 0,33 AV: R\$ 16,66 15: R\$ 17,01
30: R\$ 17,35 45: R\$ 17,70 60: R\$ 18,05



PAPEL VERGE A4 120GR MADRE PEROLA 50X1
Código: 48766 Fábrica: USAPEL Unidade: PT/50 F1 F4

UN: R\$ 0,33 AV: R\$ 16,66 15: R\$ 17,01
30: R\$ 17,35 45: R\$ 17,70 60: R\$ 18,05



PAPEL VERGE A4 120GR MARFIM 50X1
Código: 33695 Fábrica: USAPEL Unidade: PT/50 F1 F4

UN: R\$ 0,40 AV: R\$ 19,96 15: R\$ 20,37
30: R\$ 20,78 45: R\$ 21,20 60: R\$ 21,62



PAPEL VERGE A4 180GR AZUL CLARO 50X1
Código: 38559 Fábrica: USAPEL Unidade: PT/50 F1 F4

UN: R\$ 0,40 AV: R\$ 19,96 15: R\$ 20,37
30: R\$ 20,78 45: R\$ 21,20 60: R\$ 21,62



PAPEL VERGE A4 180GR BRANCO 50X1
Código: 4259 Fábrica: USAPEL Unidade: PT/50 F1 F4

UN: R\$ 0,40 AV: R\$ 19,96 15: R\$ 20,37
30: R\$ 20,78 45: R\$ 21,20 60: R\$ 21,62



PAPEL VERGE A4 180GR CINZA 50X1
Código: 43325 Fábrica: USAPEL Unidade: PT/50 F1 F4

UN: R\$ 0,40 AV: R\$ 19,96 15: R\$ 20,37
30: R\$ 20,78 45: R\$ 21,20 60: R\$ 21,62

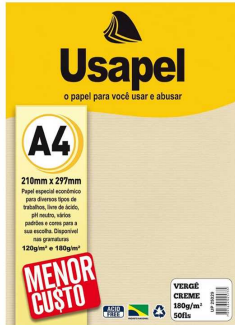

PAPEL VERGE A4 180GR CREME 50X1
Código: 41367 Fábrica: USAPEL Unidade: PT/50 F1 F4

UN: R\$ 0,40 AV: R\$ 19,96 15: R\$ 20,37
30: R\$ 20,78 45: R\$ 21,20 60: R\$ 21,62



PAPEL VERGE A4 180GR MARFIM 50X1
Código: 31684 Fábrica: USAPEL Unidade: PT/50 F1 F4

UN: R\$ 0,40 AV: R\$ 19,96 15: R\$ 20,37
30: R\$ 20,78 45: R\$ 21,20 60: R\$ 21,62

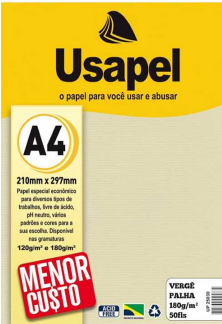

PAPEL VERGE A4 180GR PALHA 50X1
Código: 41368 Fábrica: USAPEL Unidade: PT/50 F1 F4

UN: R\$ 0,40 AV: R\$ 19,96 15: R\$ 20,37
30: R\$ 20,78 45: R\$ 21,20 60: R\$ 21,62

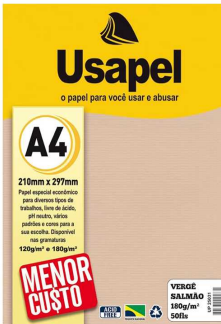

PAPEL VERGE A4 180GR SALMAO 50X1
Código: 31682 Fábrica: USAPEL Unidade: PT/50 F1 F4

UN: R\$ 0,38 AV: R\$ 18,96 15: R\$ 19,35
30: R\$ 19,74 45: R\$ 20,14 60: R\$ 20,54



PAPEL VERGE A4 180GR TEXTU BRANCO 50X1
Código: 45115 Fábrica: MASTERPRINT Unidade: PT/50 F1 F4

UN: R\$ 0,40 AV: R\$ 19,96 15: R\$ 20,37
30: R\$ 20,78 45: R\$ 21,20 60: R\$ 21,62



PAPEL VERGE A4 180GR VERDE 50X1
Código: 31683 Fábrica: USAPEL Unidade: PT/50 F1 F4

UN: R\$ 18,87 AV: R\$ 18,87 15: R\$ 19,26
30: R\$ 19,65 45: R\$ 20,04 60: R\$ 20,44



PAPEL VERGE A4 180GR 20UN
Código: 51026 Fábrica: USAPEL Unidade: PT/1 F1 F4

UN: R\$ 20,96 AV: R\$ 20,96 15: R\$ 21,39
30: R\$ 21,82 45: R\$ 22,26 60: R\$ 22,70



PASTA AZ REG ARQ OF LOMBO ESTR PRETO
Código: 42387 Fábrica: POLYCART Unidade: UN/1 F1 F4

UN: R\$ 20,96 AV: R\$ 20,96 15: R\$ 21,39
30: R\$ 21,82 45: R\$ 22,26 60: R\$ 22,70



PASTA AZ REG ARQ OF LOMBO ESTR TEXTURA
Código: 42606 Fábrica: POLYCART Unidade: UN/1 F1 F4

UN: R\$ 19,96 AV: R\$ 19,96 15: R\$ 20,37
30: R\$ 20,78 45: R\$ 21,20 60: R\$ 21,62



PASTA AZ REG ARQ OF LOMBO LARGO PRETO

Código: 45237 Fábrica: ECONOMIC Unidade: UN/1
F1 F4

UN: R\$ 21,95 AV: R\$ 21,95 15: R\$ 22,41
30: R\$ 22,86 45: R\$ 23,32 60: R\$ 23,78



PASTA AZ REG ARQ OF LOMBO LARGO TEXTURA

Código: 42607 Fábrica: POLYCART Unidade: UN/1
F1 F4

UN: R\$ 20,47 AV: R\$ 20,47 15: R\$ 20,89
30: R\$ 21,31 45: R\$ 21,74 60: R\$ 22,17



PASTA AZ REG ARQ OFIC LOMBO ESTR TIGRADO

Código: 42605 Fábrica: FRAMA Unidade: UN/1
F1 F4

UN: R\$ 22,95 AV: R\$ 22,95 15: R\$ 23,43
30: R\$ 23,90 45: R\$ 24,38 60: R\$ 24,87



PASTA AZ REG ARQ OFIC LOMBO LARGO AZUL

Código: 13241 Fábrica: FRAMA Unidade: UN/1
F1 F4

UN: R\$ 21,95 AV: R\$ 21,95 15: R\$ 22,41
30: R\$ 22,86 45: R\$ 23,32 60: R\$ 23,78



PASTA AZ REG ARQ OFIC LOMBO LARGO GRAFIT

Código: 41680 Fábrica: FRAMA Unidade: UN/1
F1 F4

UN: R\$ 55,90 AV: R\$ 55,90 15: R\$ 57,07
30: R\$ 58,21 45: R\$ 59,37 60: R\$ 60,56

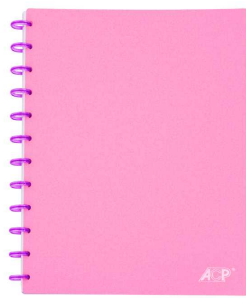

PASTA CANDY A4 C/30 ENVELOPE DESTAC AZUL

Código: 46097 Fábrica: ACP Unidade: UN/1
F1 F4

UN: R\$ 55,90 AV: R\$ 55,90 15: R\$ 57,07
30: R\$ 58,21 45: R\$ 59,37 60: R\$ 60,56

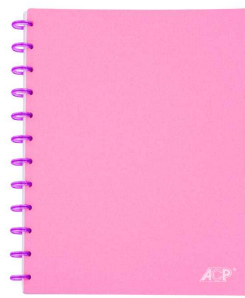

PASTA CANDY A4 C/30 ENVELOPE DESTAC ROSA

Código: 46096 Fábrica: ACP Unidade: UN/1
F1 F4

UN: R\$ 12,34 AV: R\$ 12,34 15: R\$ 12,59
30: R\$ 12,84 45: R\$ 13,10 60: R\$ 13,36



PASTA CATALOGO OFIC 10 PLAST 0,06 123

Código: 909 Fábrica: ACP Unidade: UN/1
F1 F4

UN: R\$ 15,76 AV: R\$ 15,76 15: R\$ 16,09
30: R\$ 16,42 45: R\$ 16,74 60: R\$ 17,08

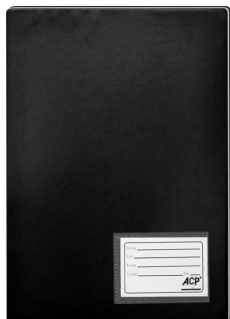

PASTA CATALOGO OFIC 30 PLAST 0,06 123/3

Código: 15378 Fábrica: ACP Unidade: UN/1
F1 F4

UN: R\$ 18,96 AV: R\$ 18,96 15: R\$ 19,35
30: R\$ 19,74 45: R\$ 20,14 60: R\$ 20,54



PASTA CATALOGO OFIC 50 PLAST 0,06 122

Código: 1703 Fábrica: ACP/DAC Unidade: UN/1
F1 F4

UN: R\$ 26,95 AV: R\$ 26,95 15: R\$ 27,51
30: R\$ 28,06 45: R\$ 28,62 60: R\$ 29,19



PASTA CATALOGO OFIC 100 PLAST 0,06 130

Código: 7051 Fábrica: ACP Unidade: UN/1
F1 F4

UN: R\$ 9,97 AV: R\$ 9,97 15: R\$ 10,18
30: R\$ 10,39 45: R\$ 10,59 60: R\$ 10,81



PASTA CATALOGO PP OF 10 PLAST PRETA

Código: 27130 Fábrica: AD Unidade: UN/1
F1 F4

UN: R\$ 7,69 AV: R\$ 76,87 15: R\$ 78,47
30: R\$ 80,04 45: R\$ 81,64 60: R\$ 83,27



PASTA CLASSIFICADORA AZUL 10X1

Código: 11195 Fábrica: TP PASTAS Unidade: PT/10
F1 F4

UN: R\$ 7,69 AV: R\$ 76,87 15: R\$ 78,47
30: R\$ 80,04 45: R\$ 81,64 60: R\$ 83,27

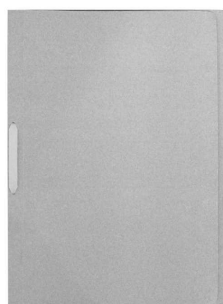

PASTA CLASSIFICADORA CINZA 10X1

Código: 11199 Fábrica: TP PASTAS Unidade: PT/10
F1 F4

UN: R\$ 8,82 AV: R\$ 176,42 15: R\$ 180,09
30: R\$ 183,69 45: R\$ 187,37 60: R\$ 191,12



PASTA CLASSIFICADORA DUPLO PLAST 20X1

Código: 51134 Fábrica: POLYCART Unidade: PT/20
F1 F4

UN: R\$ 7,69 AV: R\$ 76,87 15: R\$ 78,47
30: R\$ 80,04 45: R\$ 81,64 60: R\$ 83,27



PASTA CLASSIFICADORA ROSA 10X1

Código: 47773 Fábrica: TP PASTAS Unidade: PT/10
F1 F4

UN: R\$ 7,98 AV: R\$ 7,98 15: R\$ 8,14
30: R\$ 8,31 45: R\$ 8,47 60: R\$ 8,64



PASTA CLASSIFICADORA VERDE UN

Código: 33506 Fábrica: DELUCAS Unidade: UN/1 F1 F4

UN: R\$ 7,69 AV: R\$ 76,87 15: R\$ 78,47
30: R\$ 80,04 45: R\$ 81,64 60: R\$ 83,27



PASTA CLASSIFICADORA VERDE 10X1

Código: 11196 Fábrica: TT PASTAS Unidade: PT/10 F1 F4

UN: R\$ 6,89 AV: R\$ 68,88 15: R\$ 70,31
30: R\$ 71,72 45: R\$ 73,16 60: R\$ 74,62



PASTA ENVELOPE PP OF VAI VEM CRISTAL 10X1

Código: 41606 Fábrica: DAC/ACP Unidade: PT/10 F1 F4

UN: R\$ 6,89 AV: R\$ 68,88 15: R\$ 70,31
30: R\$ 71,72 45: R\$ 73,16 60: R\$ 74,62



PASTA ENVELOPE PP OF VAI VEM FUME 10X1

Código: 41607 Fábrica: DAC/ACP Unidade: PT/10 F1 F4

UN: R\$ 44,92 AV: R\$ 44,92 15: R\$ 45,85
30: R\$ 46,77 45: R\$ 47,71 60: R\$ 48,66



PASTA LONA EXECUTIVA DETALH MARROM 52203

Código: 33850 Fábrica: HOLLYCLASSIC Unidade: UN/1 F1 F4

UN: R\$ 44,92 AV: R\$ 44,92 15: R\$ 45,85
30: R\$ 46,77 45: R\$ 47,71 60: R\$ 48,66



PASTA LONA EXECUTIVA PRETA 52203

Código: 34038 Fábrica: HOLLYCLASSIC Unidade: UN/1 F1 F4

UN: R\$ 19,96 AV: R\$ 19,96 15: R\$ 20,37
30: R\$ 20,78 45: R\$ 21,20 60: R\$ 21,62



PASTA LONA HELLO KITTY 001

Código: 12815 Fábrica: LOMY Unidade: UN/1 F1 F4

UN: R\$ 29,94 AV: R\$ 29,94 15: R\$ 30,57
30: R\$ 31,18 45: R\$ 31,80 60: R\$ 32,44



PASTA LONA SILKADA

Código: 15242 Fábrica: A2WORKS Unidade: UN/1 F1 F4

UN: R\$ 4,49 AV: R\$ 44,92 15: R\$ 45,85
30: R\$ 46,77 45: R\$ 47,71 60: R\$ 48,66

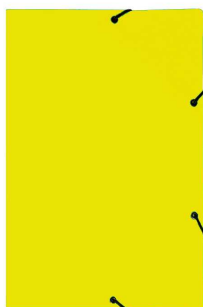

PASTA PAPEL ABA ELAST C/ILHOS AMARE 10X1

Código: 44393 Fábrica: TP PASTAS Unidade: PT/10 F1 F4

UN: R\$ 4,49 AV: R\$ 44,92 15: R\$ 45,85
30: R\$ 46,77 45: R\$ 47,71 60: R\$ 48,66

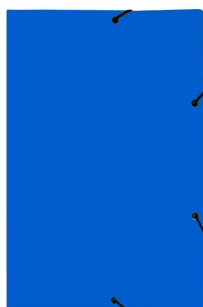

PASTA PAPEL ABA ELAST C/ILHOS AZUL 10X1

Código: 44336 Fábrica: TP PASTAS Unidade: PT/10 F1 F4

UN: R\$ 4,49 AV: R\$ 44,92 15: R\$ 45,85
30: R\$ 46,77 45: R\$ 47,71 60: R\$ 48,66



PASTA PAPEL ABA ELAST C/ILHOS PRETO 10X1

Código: 44337 Fábrica: TP PASTAS Unidade: PT/10 F1 F4

UN: R\$ 4,49 AV: R\$ 44,92 15: R\$ 45,85
30: R\$ 46,77 45: R\$ 47,71 60: R\$ 48,66



PASTA PAPEL ABA ELAST C/ILHOS ROSA 10X1

Código: 45394 Fábrica: TP PASTAS Unidade: PT/10 F1 F4

UN: R\$ 4,49 AV: R\$ 44,92 15: R\$ 45,85
30: R\$ 46,77 45: R\$ 47,71 60: R\$ 48,66

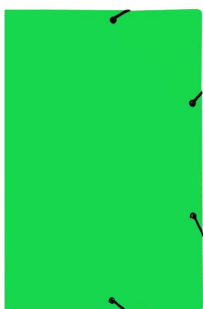

PASTA PAPEL ABA ELAST C/ILHOS VERDE 10X1

Código: 44338 Fábrica: TP PASTAS Unidade: PT/10 F1 F4

UN: R\$ 4,49 AV: R\$ 44,92 15: R\$ 45,85
30: R\$ 46,77 45: R\$ 47,71 60: R\$ 48,66

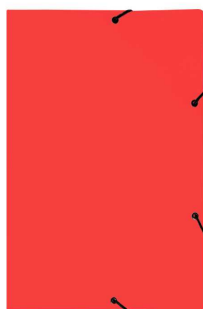

PASTA PAPEL ABA ELAST C/ILHOS VERM 10X1

Código: 44339 Fábrica: TP PASTAS Unidade: PT/10 F1 F4

UN: R\$ 3,68 AV: R\$ 36,82 15: R\$ 37,59
30: R\$ 38,34 45: R\$ 39,11 60: R\$ 39,89

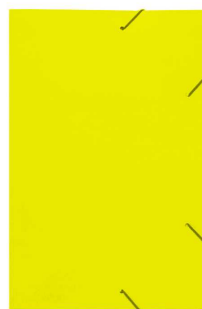

PASTA PAPEL ABA ELAST S/ILHOS AMARE 10X1

Código: 8652 Fábrica: TP PASTAS Unidade: PT/10 F1 F4

UN: R\$ 3,68 AV: R\$ 36,82 15: R\$ 37,59
30: R\$ 38,34 45: R\$ 39,11 60: R\$ 39,89



PASTA PAPEL ABA ELAST S/ILHOS AZUL 10X1

Código: 18084 Fábrica: TP PAST/BRAS Unidade: PT/10 F1 F4

UN: R\$ 3,68 AV: R\$ 36,82 15: R\$ 37,59
30: R\$ 38,34 45: R\$ 39,11 60: R\$ 39,89

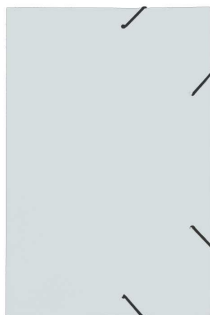

PASTA PAPEL ABA ELAST S/ILHOS BRANC 10X1
Código: 47774 Fábrica: TP PASTAS Unidade: PT/10 F1 F4

UN: R\$ 3,68 AV: R\$ 36,82 15: R\$ 37,59
30: R\$ 38,34 45: R\$ 39,11 60: R\$ 39,89



PASTA PAPEL ABA ELAST S/ILHOS LARAN 10X1
Código: 47775 Fábrica: TP PASTAS Unidade: PT/10 F1 F4

UN: R\$ 3,68 AV: R\$ 36,82 15: R\$ 37,59
30: R\$ 38,34 45: R\$ 39,11 60: R\$ 39,89

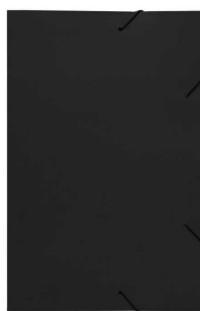

PASTA PAPEL ABA ELAST S/ILHOS PRETO 10X1
Código: 8661 Fábrica: TP PASTAS Unidade: PT/10 F1 F4

UN: R\$ 3,68 AV: R\$ 36,82 15: R\$ 37,59
30: R\$ 38,34 45: R\$ 39,11 60: R\$ 39,89



PASTA PAPEL ABA ELAST S/ILHOS ROSA 10X1
Código: 27877 Fábrica: TP PASTAS Unidade: PT/10 F1 F4

UN: R\$ 3,68 AV: R\$ 36,82 15: R\$ 37,59
30: R\$ 38,34 45: R\$ 39,11 60: R\$ 39,89



PASTA PAPEL ABA ELAST S/ILHOS VERM 10X1
Código: 8650 Fábrica: TP PASTAS Unidade: PT/10 F1 F4

UN: R\$ 3,78 AV: R\$ 3,78 15: R\$ 3,86
30: R\$ 3,94 45: R\$ 4,02 60: R\$ 4,10



PASTA PAPEL ABA ELASTICA
Código: 11201 Fábrica: ACP Unidade: UN/1 F1 F4

UN: R\$ 2,89 AV: R\$ 28,94 15: R\$ 29,55
30: R\$ 30,14 45: R\$ 30,74 60: R\$ 31,36



PASTA PAPEL C/GRAMPO METAL BRANCA 10X1
Código: 44218 Fábrica: TP PASTAS Unidade: PT/10 F1 F4

UN: R\$ 2,89 AV: R\$ 28,94 15: R\$ 29,55
30: R\$ 30,14 45: R\$ 30,74 60: R\$ 31,36



PASTA PAPEL C/GRAMPO METAL 10X1
Código: 45401 Fábrica: TP PASTAS Unidade: PT/10 F1 F4

UN: R\$ 2,89 AV: R\$ 28,94 15: R\$ 29,55
30: R\$ 30,14 45: R\$ 30,74 60: R\$ 31,36



PASTA PAPEL C/GRAMPO PLAST AMARELO 10X1
Código: 11197 Fábrica: TP PASTAS Unidade: PT/10 F1 F4

UN: R\$ 2,89 AV: R\$ 28,94 15: R\$ 29,55
30: R\$ 30,14 45: R\$ 30,74 60: R\$ 31,36



PASTA PAPEL C/GRAMPO PLAST AZUL 10X1
Código: 44216 Fábrica: TP PASTAS Unidade: PT/10 F1 F4

UN: R\$ 2,89 AV: R\$ 28,94 15: R\$ 29,55
30: R\$ 30,14 45: R\$ 30,74 60: R\$ 31,36



PASTA PAPEL C/GRAMPO PLAST BRANCA 10X1
Código: 48047 Fábrica: TP PASTAS Unidade: PT/10 F1 F4

UN: R\$ 2,89 AV: R\$ 28,94 15: R\$ 29,55
30: R\$ 30,14 45: R\$ 30,74 60: R\$ 31,36



PASTA PAPEL C/GRAMPO PLAST LARANJA 10X1
Código: 48048 Fábrica: TP PASTAS Unidade: PT/10 F1 F4

UN: R\$ 2,89 AV: R\$ 28,94 15: R\$ 29,55
30: R\$ 30,14 45: R\$ 30,74 60: R\$ 31,36



PASTA PAPEL C/GRAMPO PLAST LILAS 10X1
Código: 48049 Fábrica: TP PASTAS Unidade: PT/10 F1 F4

UN: R\$ 2,89 AV: R\$ 28,94 15: R\$ 29,55
30: R\$ 30,14 45: R\$ 30,74 60: R\$ 31,36



PASTA PAPEL C/GRAMPO PLAST ROSA 10X1
Código: 48046 Fábrica: TP PASTAS Unidade: PT/10 F1 F4

UN: R\$ 2,89 AV: R\$ 28,94 15: R\$ 29,55
30: R\$ 30,14 45: R\$ 30,74 60: R\$ 31,36



PASTA PAPEL C/GRAMPO PLAST VERDE 10X1
Código: 44215 Fábrica: TP PASTAS Unidade: PT/10 F1 F4

UN: R\$ 2,89 AV: R\$ 28,94 15: R\$ 29,55
30: R\$ 30,14 45: R\$ 30,74 60: R\$ 31,36



PASTA PAPEL C/GRAMPO PLAST VERMELHO 10X1
Código: 11198 Fábrica: TP PAS/BRAS Unidade: PT/10 F1 F4

UN: R\$ 2,89 AV: R\$ 28,94 15: R\$ 29,55
30: R\$ 30,14 45: R\$ 30,74 60: R\$ 31,36



PASTA PAPEL C/GRAMPO PRETA 10X1

Código: Fábrica: Unidade:
43862 TP PASTAS PT/10
F1 F4

UN: R\$ 2,89 AV: R\$ 28,94 15: R\$ 29,55
30: R\$ 30,14 45: R\$ 30,74 60: R\$ 31,36



PASTA PAPEL C/GRAMPO ROSA 10X1

Código: Fábrica: Unidade:
44219 TP PASTAS PT/10
F1 F4

UN: R\$ 2,99 AV: R\$ 59,89 15: R\$ 61,14
30: R\$ 62,36 45: R\$ 63,61 60: R\$ 64,88



PASTA PAPEL C/ORELHA DUPLEX COLOR 20X1

Código: Fábrica: Unidade:
51028 POLYCART PT/20
F1 F4

UN: R\$ 2,00 AV: R\$ 19,96 15: R\$ 20,37
30: R\$ 20,78 45: R\$ 21,20 60: R\$ 21,62

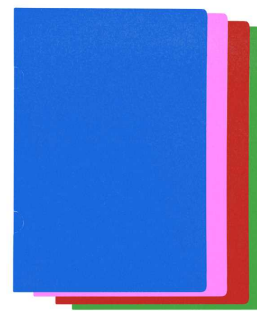

PASTA PAPEL PROCESSO 10X1

Código: Fábrica: Unidade:
45400 DELUCAS PT/10
F1 F4

UN: R\$ 2,59 AV: R\$ 25,95 15: R\$ 26,49
30: R\$ 27,02 45: R\$ 27,56 60: R\$ 28,11



PASTA PAPEL S/GRAMPO AMARELO 10X1

Código: Fábrica: Unidade:
48050 TP PASTAS PT/10
F1 F4

UN: R\$ 2,59 AV: R\$ 25,95 15: R\$ 26,49
30: R\$ 27,02 45: R\$ 27,56 60: R\$ 28,11

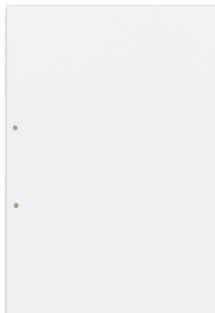

PASTA PAPEL S/GRAMPO BRANCA10X1

Código: Fábrica: Unidade:
48051 TP PASTAS PT/10
F1 F4

UN: R\$ 2,59 AV: R\$ 25,95 15: R\$ 26,49
30: R\$ 27,02 45: R\$ 27,56 60: R\$ 28,11



PASTA PAPEL S/GRAMPO CINZA 10X1

Código: Fábrica: Unidade:
48053 TP PASTAS PT/10
F1 F4

UN: R\$ 2,59 AV: R\$ 25,95 15: R\$ 26,49
30: R\$ 27,02 45: R\$ 27,56 60: R\$ 28,11



PASTA PAPEL S/GRAMPO LARANJA 10X1

Código: Fábrica: Unidade:
48052 TP PASTAS PT/10
F1 F4

UN: R\$ 2,59 AV: R\$ 25,95 15: R\$ 26,49
30: R\$ 27,02 45: R\$ 27,56 60: R\$ 28,11



PASTA PAPEL S/GRAMPO PRETA 10X1

Código: Fábrica: Unidade:
48054 TP PASTAS PT/10
F1 F4

UN: R\$ 2,59 AV: R\$ 25,95 15: R\$ 26,49
30: R\$ 27,02 45: R\$ 27,56 60: R\$ 28,11

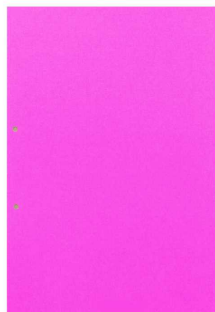

PASTA PAPEL S/GRAMPO ROSA 10X1

Código: Fábrica: Unidade:
48055 TP PASTAS PT/10
F1 F4

UN: R\$ 4,32 AV: R\$ 43,23 15: R\$ 44,13
30: R\$ 45,01 45: R\$ 45,91 60: R\$ 46,83



PASTA PAPEL 250G GRAMPO PLAST AZUL 10X1

Código: Fábrica: Unidade:
49778 TP PASTAS PT/10
F1 F4

UN: R\$ 4,32 AV: R\$ 43,23 15: R\$ 44,13
30: R\$ 45,01 45: R\$ 45,91 60: R\$ 46,83



PASTA PAPEL 250G GRAMPO PLAST VERM 10X1

Código: Fábrica: Unidade:
49777 TP PASTAS PT/10
F1 F4

UN: R\$ 4,47 AV: R\$ 44,73 15: R\$ 45,66
30: R\$ 46,57 45: R\$ 47,50 60: R\$ 48,45

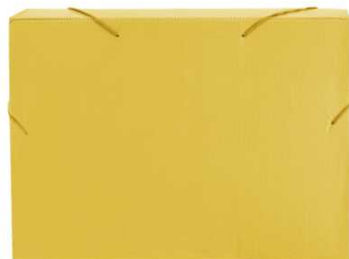

PASTA POLIIONDA OF 2 CM AMARELA 10X1

Código: Fábrica: Unidade:
9868 ALAPLAST PT/10
F1 F4

UN: R\$ 4,47 AV: R\$ 44,73 15: R\$ 45,66
30: R\$ 46,57 45: R\$ 47,50 60: R\$ 48,45



PASTA POLIIONDA OF 2 CM AZUL 10X1

Código: Fábrica: Unidade:
25628 ALAPLAST PT/10
F1 F4

UN: R\$ 4,47 AV: R\$ 44,73 15: R\$ 45,66
30: R\$ 46,57 45: R\$ 47,50 60: R\$ 48,45



PASTA POLIIONDA OF 2 CM CINZA 10X1

Código: Fábrica: Unidade:
43863 ALAPLAST PT/10
F1 F4

UN: R\$ 4,47 AV: R\$ 44,73 15: R\$ 45,66
30: R\$ 46,57 45: R\$ 47,50 60: R\$ 48,45

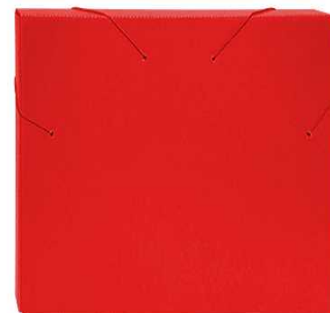

PASTA POLIIONDA OF 2 CM PRETA 10X1

Código: Fábrica: Unidade:
18372 ALAPLAST PT/10
F1 F4

UN: R\$ 4,47 AV: R\$ 44,73 15: R\$ 45,66
30: R\$ 46,57 45: R\$ 47,50 60: R\$ 48,45



PASTA POLIONDA OF 2 CM VERDE 10X1

Código: 25627 Fábrica: ALAPLAST Unidade: PT/10 F1 F4

UN: R\$ 4,47 AV: R\$ 44,73 15: R\$ 45,66
30: R\$ 46,57 45: R\$ 47,50 60: R\$ 48,45



PASTA POLIONDA OF 2 CM VERMELHA 10X1

Código: 42427 Fábrica: ALAPLAST Unidade: PT/10 F1 F4

UN: R\$ 4,80 AV: R\$ 48,02 15: R\$ 49,02
30: R\$ 50,00 45: R\$ 51,00 60: R\$ 52,02



PASTA POLIONDA OF 3,5 CM AMARELA 10X1

Código: 28201 Fábrica: ALAPLAST Unidade: PT/10 F1 F4

UN: R\$ 4,80 AV: R\$ 48,02 15: R\$ 49,02
30: R\$ 50,00 45: R\$ 51,00 60: R\$ 52,02



PASTA POLIONDA OF 3,5 CM AZUL 10X1

Código: 28202 Fábrica: ALAPLAST Unidade: PT/10 F1 F4

UN: R\$ 4,80 AV: R\$ 48,02 15: R\$ 49,02
30: R\$ 50,00 45: R\$ 51,00 60: R\$ 52,02

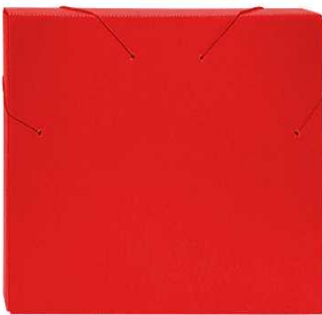

PASTA POLIONDA OF 3,5 CM PRETA 10X1

Código: 28204 Fábrica: ALAPLAST Unidade: PT/10 F1 F4

UN: R\$ 4,80 AV: R\$ 48,02 15: R\$ 49,02
30: R\$ 50,00 45: R\$ 51,00 60: R\$ 52,02

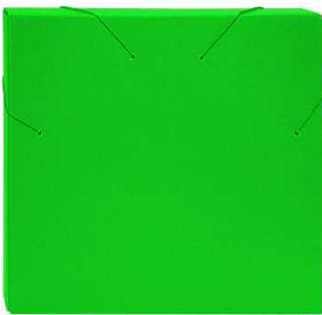

PASTA POLIONDA OF 3,5 CM VERDE 10X1

Código: 28203 Fábrica: ALAPLAST Unidade: PT/10 F1 F4

UN: R\$ 4,80 AV: R\$ 48,02 15: R\$ 49,02
30: R\$ 50,00 45: R\$ 51,00 60: R\$ 52,02



PASTA POLIONDA OF 3,5 CM VERMELHA 10X1

Código: 42428 Fábrica: ALAPLAST Unidade: PT/10 F1 F4

UN: R\$ 6,29 AV: R\$ 62,89 15: R\$ 64,20
30: R\$ 65,48 45: R\$ 66,79 60: R\$ 68,13



PASTA POLIONDA OF 5,5 CM AMARELA 10X1

Código: 43865 Fábrica: ALAPLAST Unidade: PT/10 F1 F4

UN: R\$ 6,29 AV: R\$ 62,89 15: R\$ 64,20
30: R\$ 65,48 45: R\$ 66,79 60: R\$ 68,13



PASTA POLIONDA OF 5,5 CM AZUL 10X1

Código: 43864 Fábrica: ALAPLAST Unidade: PT/10 F1 F4

UN: R\$ 6,29 AV: R\$ 62,89 15: R\$ 64,20
30: R\$ 65,48 45: R\$ 66,79 60: R\$ 68,13

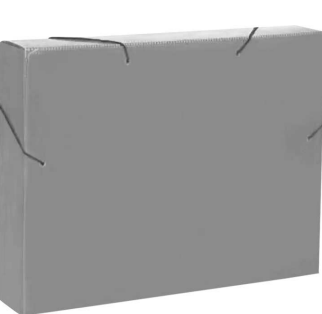

PASTA POLIONDA OF 5,5 CM CINZA 10X1

Código: 43867 Fábrica: ALAPLAST Unidade: PT/10 F1 F4

UN: R\$ 6,29 AV: R\$ 62,89 15: R\$ 64,20
30: R\$ 65,48 45: R\$ 66,79 60: R\$ 68,13



PASTA POLIONDA OF 5,5 CM PRETA 10X1

Código: 43868 Fábrica: ALAPLAST Unidade: PT/10 F1 F4

UN: R\$ 6,29 AV: R\$ 62,89 15: R\$ 64,20
30: R\$ 65,48 45: R\$ 66,79 60: R\$ 68,13



PASTA POLIONDA OF 5,5 CM VERDE 10X1

Código: 43866 Fábrica: ALAPLAST Unidade: PT/10 F1 F4

UN: R\$ 6,29 AV: R\$ 62,89 15: R\$ 64,20
30: R\$ 65,48 45: R\$ 66,79 60: R\$ 68,13



PASTA POLIONDA OF 5,5 CM VERMELHO 10X1

Código: 42429 Fábrica: ALAPLAST Unidade: PT/10 F1 F4

UN: R\$ 2,49 AV: R\$ 24,94 15: R\$ 24,94
30: R\$ 24,94 45: R\$ 24,94 60: R\$ 24,94



PASTA PP OF AMARELO TRANSP 10X1

Código: 9760 Fábrica: ALAPLAST Unidade: PT/10 F1 F4

UN: R\$ 2,49 AV: R\$ 24,94 15: R\$ 24,94
30: R\$ 24,94 45: R\$ 24,94 60: R\$ 24,94

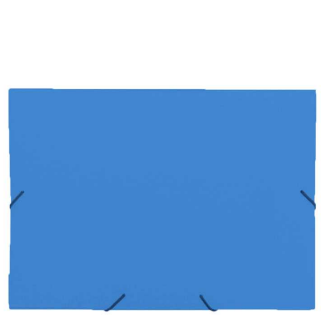

PASTA PP OF AZUL FOSCA 20104A 10X1

Código: 43185 Fábrica: ALAPLAST Unidade: PT/10 F1 F4

UN: R\$ 2,49 AV: R\$ 24,94 15: R\$ 24,94
30: R\$ 24,94 45: R\$ 24,94 60: R\$ 24,94

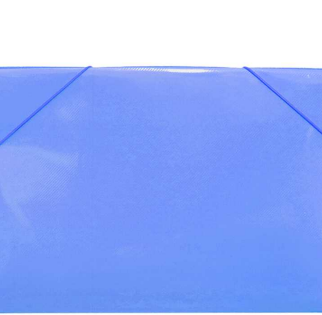

PASTA PP OF AZUL TRANSP 10X1

Código: 46000 Fábrica: ALAPLAST Unidade: PT/10 F1 F4

UN: R\$ 2,49 AV: R\$ 24,94 15: R\$ 24,94
30: R\$ 24,94 45: R\$ 24,94 60: R\$ 24,94

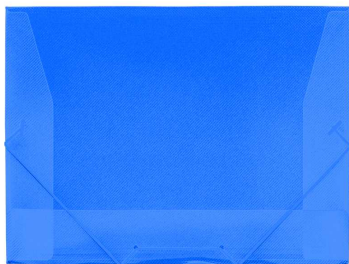

PASTA PP OF AZUL 1021 10X1

Código: 9757 Fábrica: ACP Unidade: PT/10 F1 F4

UN: R\$ 2,49 AV: R\$ 24,94 15: R\$ 24,94
30: R\$ 24,94 45: R\$ 24,94 60: R\$ 24,94



PASTA PP OF CRISTAL TRANSP 10X1

Código: 13089 Fábrica: ALAPLAST Unidade: PT/10 F1 F4

UN: R\$ 2,49 AV: R\$ 24,94 15: R\$ 24,94
30: R\$ 24,94 45: R\$ 24,94 60: R\$ 24,94



PASTA PP OF ELAST AMARELO FOSCA 10X1

Código: 44326 Fábrica: ALAPLAST Unidade: PT/10 F1 F4

UN: R\$ 2,49 AV: R\$ 24,94 15: R\$ 24,94
30: R\$ 24,94 45: R\$ 24,94 60: R\$ 24,94

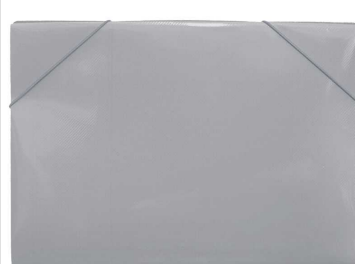

PASTA PP OF FUME TRANSP 10X1

Código: 10031 Fábrica: ALAPLAST Unidade: PT/10 F1 F4

UN: R\$ 2,49 AV: R\$ 24,94 15: R\$ 24,94
30: R\$ 24,94 45: R\$ 24,94 60: R\$ 24,94

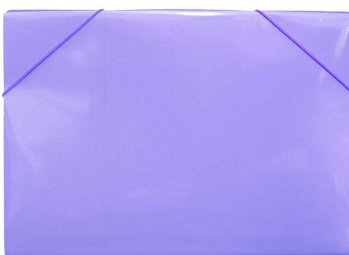

PASTA PP OF LILAS TRANSP 10X1

Código: 38317 Fábrica: ALAPLAST Unidade: PT/10 F1 F4

UN: R\$ 2,49 AV: R\$ 24,94 15: R\$ 24,94
30: R\$ 24,94 45: R\$ 24,94 60: R\$ 24,94

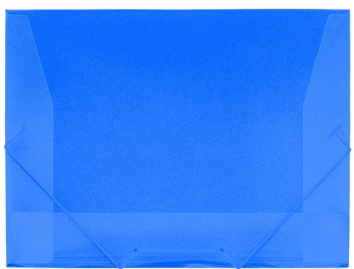

PASTA PP OF LILAS 1021 10X1

Código: 46167 Fábrica: ACP Unidade: PT/10 F1 F4

UN: R\$ 2,49 AV: R\$ 24,94 15: R\$ 24,94
30: R\$ 24,94 45: R\$ 24,94 60: R\$ 24,94



PASTA PP OF ROSA TRANSP 10X1

Código: 41286 Fábrica: ALAPLAST Unidade: PT/10 F1 F4

UN: R\$ 2,49 AV: R\$ 24,94 15: R\$ 24,94
30: R\$ 24,94 45: R\$ 24,94 60: R\$ 24,94

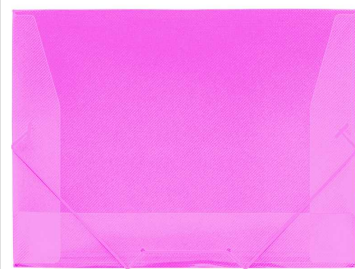

PASTA PP OF ROSA 1021 10X1

Código: 46166 Fábrica: ACP Unidade: PT/10 F1 F4

UN: R\$ 2,49 AV: R\$ 24,94 15: R\$ 24,94
30: R\$ 24,94 45: R\$ 24,94 60: R\$ 24,94



PASTA PP OF VERDE TRANSP 10X1

Código: 46001 Fábrica: ALAPLAST Unidade: PT/10 F1 F4

UN: R\$ 2,49 AV: R\$ 24,94 15: R\$ 24,94
30: R\$ 24,94 45: R\$ 24,94 60: R\$ 24,94



PASTA PP OF VERDE 1021 10X1

Código: 46165 Fábrica: ACP Unidade: PT/10 F1 F4

UN: R\$ 2,49 AV: R\$ 24,94 15: R\$ 24,94
30: R\$ 24,94 45: R\$ 24,94 60: R\$ 24,94



PASTA PP OF VERMELHO TRANSP 10X1

Código: 29784 Fábrica: ALAPLAST Unidade: PT/10 F1 F4

UN: R\$ 2,49 AV: R\$ 24,94 15: R\$ 24,94
30: R\$ 24,94 45: R\$ 24,94 60: R\$ 24,94



PASTA PP OF VERMELHO 1021 10X1

Código: 46169 Fábrica: ACP Unidade: PT/10 F1 F4

UN: R\$ 2,99 AV: R\$ 29,94 15: R\$ 30,57
30: R\$ 31,18 45: R\$ 31,80 60: R\$ 32,44



PASTA PP CANALETA A4 AZUL TRANSP 10X1

Código: 43858 Fábrica: ALAPLAST Unidade: PT/10 F1 F4

UN: R\$ 2,99 AV: R\$ 29,94 15: R\$ 30,57
30: R\$ 31,18 45: R\$ 31,80 60: R\$ 32,44



PASTA PP CANALETA A4 CRISTAL TRANSP 10X1

Código: 46002 Fábrica: ALAPLAST Unidade: PT/10 F1 F4

UN: R\$ 2,99 AV: R\$ 29,94 15: R\$ 30,57
30: R\$ 31,18 45: R\$ 31,80 60: R\$ 32,44



PASTA PP CANALETA A4 CRISTAL TRANSP 10X1

Código: 43857 Fábrica: DAC Unidade: PT/10 F1 F4

UN: R\$ 2,99 AV: R\$ 29,94 15: R\$ 30,57
30: R\$ 31,18 45: R\$ 31,80 60: R\$ 32,44

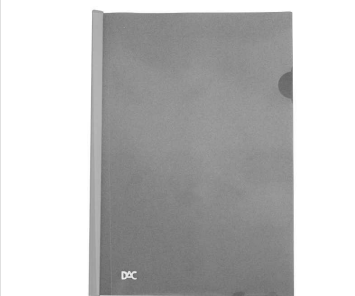

PASTA PP CANALETA A4 FUME TRANSP 10X1

Código: 43860 Fábrica: DAC Unidade: PT/10 F1 F4

UN: R\$ 2,99 AV: R\$ 29,94 15: R\$ 30,57
30: R\$ 31,18 45: R\$ 31,80 60: R\$ 32,44



PASTA PP CANALETA A4 PRETO 10X1

Código: 15373 Fábrica: SUPER LINE Unidade: PT/10 F1 F4

UN: R\$ 2,99 AV: R\$ 29,94 15: R\$ 30,57
30: R\$ 31,18 45: R\$ 31,80 60: R\$ 32,44

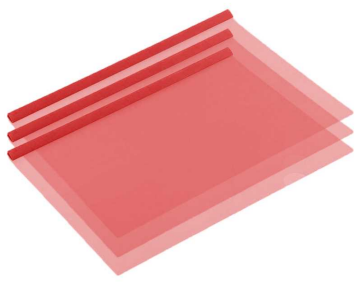

PASTA PP CANALETA A4 VERMELHO TRANS 10X1

Código: 43861 Fábrica: ALAPLAST Unidade: PT/10 F1 F4

UN: R\$ 2,00 AV: R\$ 19,96 15: R\$ 20,37
30: R\$ 20,78 45: R\$ 21,20 60: R\$ 21,62



PASTA PP L A4 AMARELA 042-AM 10X1

Código: 50018 Fábrica: DAC Unidade: PT/10 F1 F4

UN: R\$ 2,00 AV: R\$ 19,96 15: R\$ 20,37
30: R\$ 20,78 45: R\$ 21,20 60: R\$ 21,62



PASTA PP L A4 AZUL 042-AZ 10X1

Código: 50019 Fábrica: DAC Unidade: PT/10 F1 F4

UN: R\$ 1,50 AV: R\$ 14,97 15: R\$ 15,28
30: R\$ 15,58 45: R\$ 15,90 60: R\$ 16,21



PASTA PP L A4 CRISTAL 371 10X1

Código: 24136 Fábrica: LIKE Unidade: PT/10 F1 F4

UN: R\$ 2,00 AV: R\$ 19,96 15: R\$ 20,37
30: R\$ 20,78 45: R\$ 21,20 60: R\$ 21,62



PASTA PP L A4 ROSA 10X1

Código: 50054 Fábrica: DAC Unidade: PT/10 F1 F4

UN: R\$ 2,00 AV: R\$ 19,96 15: R\$ 20,37
30: R\$ 20,78 45: R\$ 21,20 60: R\$ 21,62



PASTA PP L A4 VERDE 042-VD 10X1

Código: 50020 Fábrica: DAC Unidade: PT/10 F1 F4

UN: R\$ 2,20 AV: R\$ 21,95 15: R\$ 22,41
30: R\$ 22,86 45: R\$ 23,32 60: R\$ 23,78

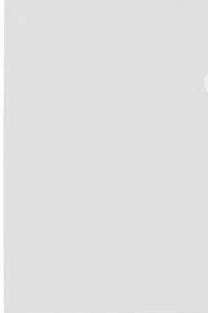

PASTA PP L OF CRISTAL 271/113 10X1

Código: 24135 Fábrica: DELLO/LIKE Unidade: PT/10 F1 F4

UN: R\$ 2,79 AV: R\$ 2,79 15: R\$ 2,84
30: R\$ 2,90 45: R\$ 2,96 60: R\$ 3,02

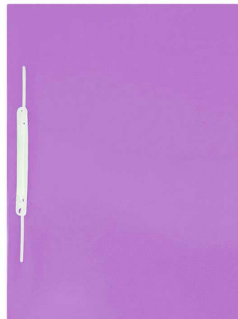

PASTA PP OF GRAMPO PLAST OF

Código: 41617 Fábrica: ALAPLAST Unidade: UN/1 F1 F4

UN: R\$ 2,85 AV: R\$ 28,45 15: R\$ 29,05
30: R\$ 29,63 45: R\$ 30,22 60: R\$ 30,83



PASTA PP OF GRAMPO TRILHO CRISTAL 10X1

Código: 46215 Fábrica: ACP Unidade: PT/10 F1 F4

UN: R\$ 2,99 AV: R\$ 29,94 15: R\$ 30,57
30: R\$ 31,18 45: R\$ 31,80 60: R\$ 32,44



PASTA PP OF GRAMPO TRILHO CRISTAL 10X1

Código: 9772 Fábrica: DAC Unidade: PT/10 F1 F4

UN: R\$ 2,79 AV: R\$ 27,95 15: R\$ 28,53
30: R\$ 29,10 45: R\$ 29,68 60: R\$ 30,27



PASTA PP OF GRAMPO TRILHO FUME TRAN 10X1

Código: 29196 Fábrica: ALAPLAST Unidade: PT/10 F1 F4

UN: R\$ 2,85 AV: R\$ 28,45 15: R\$ 29,05
30: R\$ 29,63 45: R\$ 30,22 60: R\$ 30,83

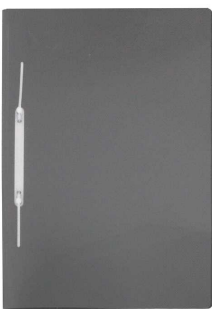

PASTA PP OF GRAMPO TRILHO FUME 10X1

Código: 46216 Fábrica: ACP Unidade: PT/10 F1 F4

UN: R\$ 2,99 AV: R\$ 29,94 15: R\$ 30,57
30: R\$ 31,18 45: R\$ 31,80 60: R\$ 32,44

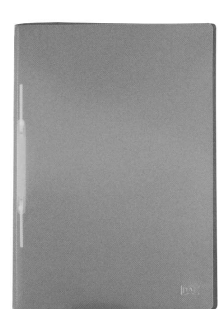

PASTA PP OF GRAMPO TRILHO FUME 10X1

Código: 8932 Fábrica: DAC Unidade: PT/10 F1 F4

UN: R\$ 24,95 AV: R\$ 24,95 15: R\$ 25,47
30: R\$ 25,98 45: R\$ 26,50 60: R\$ 27,03



PASTA PP SANFONA A4 12 DIV AZUL 1027

Código: 34127 Fábrica: ACP Unidade: UN/1 F1 F4

UN: R\$ 24,95 AV: R\$ 24,95 15: R\$ 25,47
30: R\$ 25,98 45: R\$ 26,50 60: R\$ 27,03



PASTA PP SANFONA A4 12 DIV CRISTAL 1027

Código: 15847 Fábrica: ACP Unidade: UN/1 F1 F4

UN: R\$ 24,95 AV: R\$ 24,95 15: R\$ 25,47
30: R\$ 25,98 45: R\$ 26,50 60: R\$ 27,03



PASTA PP SANFONA A4 12 DIV FUME 1027
Código: 8972 Fábrica: ACP Unidade: UN/1 F1 F4

UN: R\$ 24,95 AV: R\$ 24,95 15: R\$ 25,47
30: R\$ 25,98 45: R\$ 26,50 60: R\$ 27,03



PASTA PP SANFONA A4 12 DIV LILAS 1027
Código: 46170 Fábrica: ACP Unidade: UN/1 F1 F4

UN: R\$ 59,89 AV: R\$ 59,89 15: R\$ 61,14
30: R\$ 62,36 45: R\$ 63,61 60: R\$ 64,88



PASTA PP SANFONA A4 31 DIV FUME 1045
Código: 15856 Fábrica: ACP Unidade: UN/1 F1 F4

UN: R\$ 16,47 AV: R\$ 16,47 15: R\$ 16,82
30: R\$ 17,15 45: R\$ 17,50 60: R\$ 17,85



PASTA PP SANFONA CHEQUE 12 DIV CRISTAL
Código: 32383 Fábrica: ACP/POLIBRA Unidade: UN/1 F1 F4

UN: R\$ 36,49 AV: R\$ 36,49 15: R\$ 37,25
30: R\$ 38,00 45: R\$ 38,76 60: R\$ 39,53



PASTA PP SANFONA CHEQUE 31 DIV CRISTAL
Código: 8975 Fábrica: ACP Unidade: UN/1 F1 F4

UN: R\$ 36,49 AV: R\$ 36,49 15: R\$ 37,25
30: R\$ 38,00 45: R\$ 38,76 60: R\$ 39,53



PASTA PP SANFONA CHEQUE 31 DIV FUME
Código: 31610 Fábrica: ACP PLASCONY Unidade: UN/1 F1 F4

UN: R\$ 18,96 AV: R\$ 18,96 15: R\$ 19,35
30: R\$ 19,74 45: R\$ 20,14 60: R\$ 20,54



PASTA PP SANFONA DUPLIC 12 DIV CRISTAL
Código: 34122 Fábrica: ACP Unidade: UN/1 F1 F4

UN: R\$ 18,96 AV: R\$ 18,96 15: R\$ 19,35
30: R\$ 19,74 45: R\$ 20,14 60: R\$ 20,54



PASTA PP SANFONA DUPLIC 12 DIV FUME
Código: 46171 Fábrica: ACP Unidade: UN/1 F1 F4

UN: R\$ 42,43 AV: R\$ 42,43 15: R\$ 43,32
30: R\$ 44,18 45: R\$ 45,07 60: R\$ 45,97



PASTA PP SANFONA DUPLIC 31 DIV CRISTAL
Código: 8973 Fábrica: ACP Unidade: UN/1 F1 F4

UN: R\$ 42,43 AV: R\$ 42,43 15: R\$ 43,32
30: R\$ 44,18 45: R\$ 45,07 60: R\$ 45,97



PASTA PP SANFONA DUPLIC 31 DIV FUME
Código: 14352 Fábrica: ACP Unidade: UN/1 F1 F4

UN: R\$ 31,54 AV: R\$ 31,54 15: R\$ 32,20
30: R\$ 32,84 45: R\$ 33,50 60: R\$ 34,17



PASTA PP SANFONA OF 12 DIV CRISTAL
Código: 32395 Fábrica: ACP Unidade: UN/1 F1 F4

UN: R\$ 37,44 AV: R\$ 149,75 15: R\$ 152,87
30: R\$ 155,93 45: R\$ 159,05 60: R\$ 162,23



PASTA PP SANFONADA A4 12 DIV CRISTAL 6X1
Código: 42013 Fábrica: PLASCONY Unidade: CX/4 F1 F4

UN: R\$ 73,31 AV: R\$ 293,23 15: R\$ 299,34
30: R\$ 305,33 45: R\$ 311,43 60: R\$ 317,66



PASTA PP SANFONADA A4 31 DIV CRISTAL 4X1
Código: 42883 Fábrica: PLASCONY Unidade: CX/4 F1 F4

UN: R\$ 44,93 AV: R\$ 179,70 15: R\$ 183,45
30: R\$ 187,11 45: R\$ 190,86 60: R\$ 194,67



PASTA PP SANFONADA SLIM 31 DIV CRIS 4X1
Código: 42009 Fábrica: PLASCONY Unidade: CX/4 F1 F4

UN: R\$ 44,93 AV: R\$ 179,70 15: R\$ 183,45
30: R\$ 187,11 45: R\$ 190,86 60: R\$ 194,67



PASTA PP SANFONADA SLIM 31 DIV FUME 4X1
Código: 42010 Fábrica: PLASCONY Unidade: CX/4 F1 F4

UN: R\$ 23,79 AV: R\$ 142,76 15: R\$ 145,74
30: R\$ 148,65 45: R\$ 151,62 60: R\$ 154,66



PASTA PP SANFONADA 1/2 OF 12 DIV CRI 6X1
Código: 42012 Fábrica: PLASCONY Unidade: CX/6 F1 F4

UN: R\$ 6,19 AV: R\$ 30,94 15: R\$ 31,59
30: R\$ 32,22 45: R\$ 32,86 60: R\$ 33,52



PASTA PP SUSPENSA TRANSP CRISTAL 155 5X1
Código: 9017 Fábrica: ACP Unidade: PT/5 F1 F4

UN: R\$ 2,19 AV: R\$ 21,94 15: R\$ 21,94
30: R\$ 21,94 45: R\$ 21,94 60: R\$ 21,94



PASTA PP 1/2 OF AZUL OPACA 10X1
Código: 30443 Fábrica: SUPER LINE Unidade: PT/10 F1 F4

UN: R\$ 2,19 AV: R\$ 21,94 15: R\$ 21,94
30: R\$ 21,94 45: R\$ 21,94 60: R\$ 21,94



PASTA PP 1/2 OF CINZA OPACA 10X1
Código: 30441 Fábrica: SUPER LINE Unidade: PT/10 F1 F4

UN: R\$ 2,19 AV: R\$ 21,94 15: R\$ 21,94
30: R\$ 21,94 45: R\$ 21,94 60: R\$ 21,94

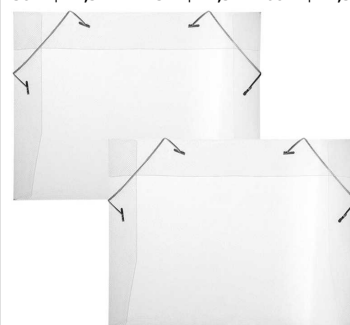

PASTA PP 1/2 OF CRISTAL 10X1
Código: 3066 Fábrica: ALAPLAST Unidade: PT/10 F1 F4

UN: R\$ 2,19 AV: R\$ 21,94 15: R\$ 21,94
30: R\$ 21,94 45: R\$ 21,94 60: R\$ 21,94

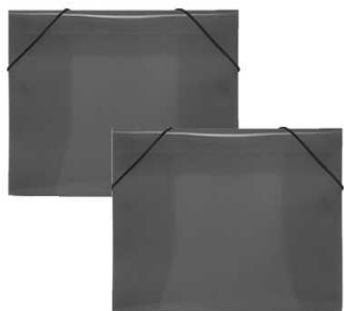

PASTA PP 1/2 OF FUME 10X1
Código: 9755 Fábrica: ALAPLAST Unidade: PT/10 F1 F4

UN: R\$ 2,19 AV: R\$ 21,94 15: R\$ 21,94
30: R\$ 21,94 45: R\$ 21,94 60: R\$ 21,94



PASTA PP 1/2 OF LARANJA OPACA 10X1
Código: 12596 Fábrica: SUPER LINE Unidade: PT/10 F1 F4

UN: R\$ 2,19 AV: R\$ 21,94 15: R\$ 21,94
30: R\$ 21,94 45: R\$ 21,94 60: R\$ 21,94



PASTA PP 1/2 OF PRETO OPACA 10X1
Código: 30442 Fábrica: SUPER LINE Unidade: PT/10 F1 F4

UN: R\$ 2,19 AV: R\$ 21,94 15: R\$ 21,94
30: R\$ 21,94 45: R\$ 21,94 60: R\$ 21,94

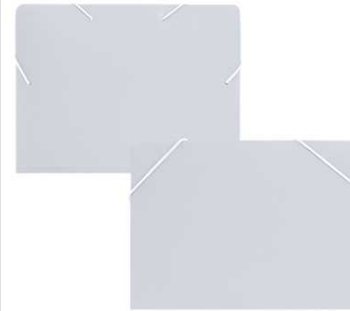

PASTA PP 1/2 OF SORTIDO 10X1
Código: 30446 Fábrica: ALAPLAST Unidade: PT/10 F1 F4

UN: R\$ 2,19 AV: R\$ 21,94 15: R\$ 21,94
30: R\$ 21,94 45: R\$ 21,94 60: R\$ 21,94



PASTA PP 1/2 OF VERDE CIT OPACA 10X1
Código: 30493 Fábrica: SUPER LINE Unidade: PT/10 F1 F4

UN: R\$ 2,19 AV: R\$ 21,94 15: R\$ 21,94
30: R\$ 21,94 45: R\$ 21,94 60: R\$ 21,94



PASTA PP 1/2 OF VERMELHO 10X1
Código: 19480 Fábrica: SUPER LINE Unidade: PT/10 F1 F4

UN: R\$ 2,29 AV: R\$ 22,94 15: R\$ 22,94
30: R\$ 22,94 45: R\$ 22,94 60: R\$ 22,94



PASTA PP 1/2 OF 2 CM AZUL OPACA 10X1
Código: 27749 Fábrica: SUPER LINE Unidade: PT/10 F1 F4

UN: R\$ 2,29 AV: R\$ 22,94 15: R\$ 22,94
30: R\$ 22,94 45: R\$ 22,94 60: R\$ 22,94



PASTA PP 1/2 OF 2 CM LARANJA OPACA 10X1
Código: 27745 Fábrica: SUPER LINE Unidade: PT/10 F1 F4

UN: R\$ 2,29 AV: R\$ 22,94 15: R\$ 22,94
30: R\$ 22,94 45: R\$ 22,94 60: R\$ 22,94



PASTA PP 1/2 OF 2 CM LILAS OPACA 10X1
Código: 27746 Fábrica: SUPER LINE Unidade: PT/10 F1 F4

UN: R\$ 2,29 AV: R\$ 22,94 15: R\$ 22,94
30: R\$ 22,94 45: R\$ 22,94 60: R\$ 22,94



PASTA PP 1/2 OF 2 CM LILAS 10X1
Código: 8936 Fábrica: ALAPLAST Unidade: PT/10 F1 F4

UN: R\$ 2,29 AV: R\$ 22,94 15: R\$ 22,94
30: R\$ 22,94 45: R\$ 22,94 60: R\$ 22,94



PASTA PP 1/2 OF 2 CM ROSA OPACA 10X1
Código: 27748 Fábrica: SUPER LINE Unidade: PT/10 F1 F4

UN: R\$ 2,29 AV: R\$ 22,94 15: R\$ 22,94
30: R\$ 22,94 45: R\$ 22,94 60: R\$ 22,94



PASTA PP 1/2 OF 2 CM ROSA 10X1
Código: 43844 Fábrica: ALAPLAST Unidade: PT/10 F1 F4

UN: R\$ 2,29 AV: R\$ 22,94 15: R\$ 22,94
30: R\$ 22,94 45: R\$ 22,94 60: R\$ 22,94



PASTA PP 1/2 OF 2 CM VERDE OPACA 10X1
Código: 30491 Fábrica: SUPER LINE Unidade: PT/10
F1 F4

UN: R\$ 2,29 AV: R\$ 22,94 15: R\$ 22,94
30: R\$ 22,94 45: R\$ 22,94 60: R\$ 22,94



PASTA PP 1/2 OF 2 CM VERDE 10X1
Código: 43845 Fábrica: ALAPLAST Unidade: PT/10
F1 F4

UN: R\$ 2,29 AV: R\$ 22,94 15: R\$ 22,94
30: R\$ 22,94 45: R\$ 22,94 60: R\$ 22,94



PASTA PP 1/2 OF 2 CM VERMELHO OPACA 10X1
Código: 27753 Fábrica: SUPER LINE Unidade: PT/10
F1 F4

UN: R\$ 4,49 AV: R\$ 44,94 15: R\$ 44,94
30: R\$ 44,94 45: R\$ 44,94 60: R\$ 44,94

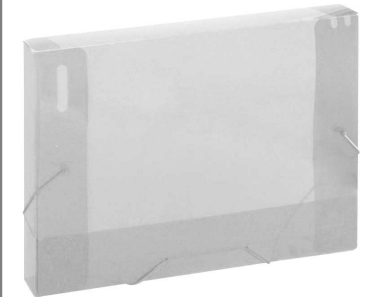

PASTA PP 1,7 CM CRISTAL TRANSP 10X1
Código: 46074 Fábrica: ALAPLAST Unidade: PT/10
F1 F4

UN: R\$ 4,49 AV: R\$ 44,94 15: R\$ 44,94
30: R\$ 44,94 45: R\$ 44,94 60: R\$ 44,94



PASTA PP 1,7 CM FUME TRANSP 10X1
Código: 46075 Fábrica: ALAPLAST Unidade: PT/10
F1 F4

UN: R\$ 4,99 AV: R\$ 49,94 15: R\$ 49,94
30: R\$ 49,94 45: R\$ 49,94 60: R\$ 49,94



PASTA PP 2 CM AMARELA 10X1
Código: 15872 Fábrica: ALAPLAST Unidade: PT/10
F1 F4

UN: R\$ 4,99 AV: R\$ 49,94 15: R\$ 49,94
30: R\$ 49,94 45: R\$ 49,94 60: R\$ 49,94

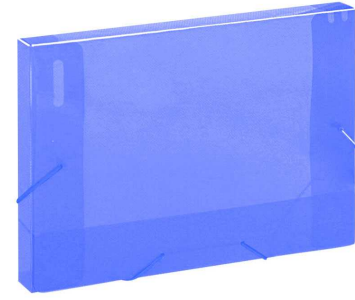

PASTA PP 2 CM AZUL 1022 10X1
Código: 15875 Fábrica: ACP Unidade: PT/10
F1 F4

UN: R\$ 4,99 AV: R\$ 49,94 15: R\$ 49,94
30: R\$ 49,94 45: R\$ 49,94 60: R\$ 49,94



PASTA PP 2 CM CRISTAL 1022 10X1
Código: 9761 Fábrica: ACP Unidade: PT/10
F1 F4

UN: R\$ 4,99 AV: R\$ 49,94 15: R\$ 49,94
30: R\$ 49,94 45: R\$ 49,94 60: R\$ 49,94



PASTA PP 2 CM FUME 1022 10X1
Código: 9763 Fábrica: ACP/ALAPLAST Unidade: PT/10
F1 F4

UN: R\$ 4,99 AV: R\$ 49,94 15: R\$ 49,94
30: R\$ 49,94 45: R\$ 49,94 60: R\$ 49,94



PASTA PP 2 CM LILAS 10X1
Código: 42935 Fábrica: ALAPLAST Unidade: PT/10
F1 F4

UN: R\$ 4,99 AV: R\$ 49,94 15: R\$ 49,94
30: R\$ 49,94 45: R\$ 49,94 60: R\$ 49,94

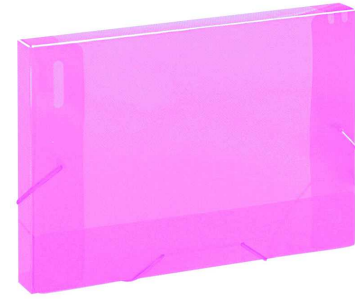

PASTA PP 2 CM ROSA 1022 10X1
Código: 19481 Fábrica: ACP Unidade: PT/10
F1 F4

UN: R\$ 4,99 AV: R\$ 49,94 15: R\$ 49,94
30: R\$ 49,94 45: R\$ 49,94 60: R\$ 49,94

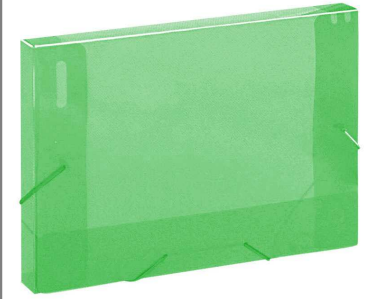

PASTA PP 2 CM VERDE 10X1
Código: 9762 Fábrica: ALAPLAST Unidade: PT/10
F1 F4

UN: R\$ 4,99 AV: R\$ 49,94 15: R\$ 49,94
30: R\$ 49,94 45: R\$ 49,94 60: R\$ 49,94



PASTA PP 2 CM VERMELHA 1022 10X1
Código: 9765 Fábrica: ACP/ALA Unidade: PT/10
F1 F4

UN: R\$ 5,29 AV: R\$ 52,94 15: R\$ 52,94
30: R\$ 52,94 45: R\$ 52,94 60: R\$ 52,94

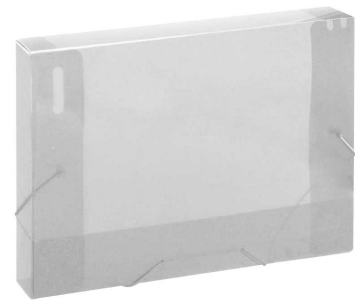

PASTA PP 3 CM CRISTAL TRANSP 10X1
Código: 14355 Fábrica: ALAPLAST Unidade: PT/10
F1 F4

UN: R\$ 5,29 AV: R\$ 52,94 15: R\$ 52,94
30: R\$ 52,94 45: R\$ 52,94 60: R\$ 52,94

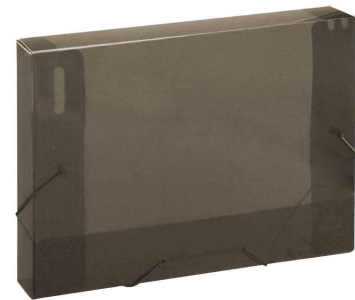

PASTA PP 3 CM FUME TRANSP 10X1
Código: 14356 Fábrica: ALAPLAST Unidade: PT/10
F1 F4

UN: R\$ 5,69 AV: R\$ 56,94 15: R\$ 56,94
30: R\$ 56,94 45: R\$ 56,94 60: R\$ 56,94



PASTA PP 4 CM PRETA 10X1
Código: 15865 Fábrica: ALAPLAST Unidade: PT/10
F1 F4

UN: R\$ 5,69 AV: R\$ 56,94 15: R\$ 56,94
30: R\$ 56,94 45: R\$ 56,94 60: R\$ 56,94



PASTA PP 4 CM AMARELO 10X1

Código: 15863 Fábrica: ALAPLAST Unidade: PT/10 F1 F4

UN: R\$ 5,69 AV: R\$ 56,94 15: R\$ 56,94
30: R\$ 56,94 45: R\$ 56,94 60: R\$ 56,94

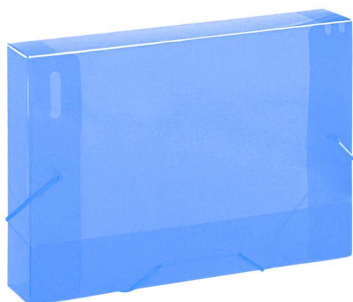

PASTA PP 4 CM AZUL 1024 10X1

Código: 15885 Fábrica: ACP/ALAPLAST Unidade: PT/10 F1 F4

UN: R\$ 5,69 AV: R\$ 56,94 15: R\$ 56,94
30: R\$ 56,94 45: R\$ 56,94 60: R\$ 56,94



PASTA PP 4 CM CRISTAL TRANSP 10X1

Código: 9768 Fábrica: ALAPLAST Unidade: PT/10 F1 F4

UN: R\$ 5,69 AV: R\$ 56,94 15: R\$ 56,94
30: R\$ 56,94 45: R\$ 56,94 60: R\$ 56,94



PASTA PP 4 CM CRISTAL 1024 10X1

Código: 15886 Fábrica: ACP Unidade: PT/10 F1 F4

UN: R\$ 5,87 AV: R\$ 58,66 15: R\$ 59,88
30: R\$ 61,08 45: R\$ 62,30 60: R\$ 63,54



PASTA PP 4 CM FUME TRANSP 10X1

Código: 34124 Fábrica: ALAPLAST Unidade: PT/10 F1 F4

UN: R\$ 5,69 AV: R\$ 56,94 15: R\$ 56,94
30: R\$ 56,94 45: R\$ 56,94 60: R\$ 56,94

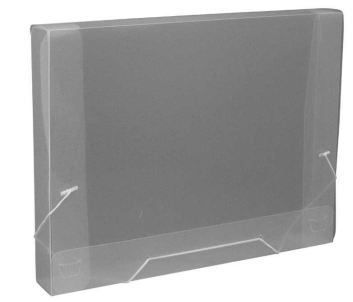

PASTA PP 4 CM FUME 1024 10X1

Código: 15889 Fábrica: ACP Unidade: PT/10 F1 F4

UN: R\$ 5,69 AV: R\$ 56,94 15: R\$ 56,94
30: R\$ 56,94 45: R\$ 56,94 60: R\$ 56,94



PASTA PP 4 CM LARANJA 10X1

Código: 42067 Fábrica: ALAPLAST Unidade: PT/10 F1 F4

UN: R\$ 5,69 AV: R\$ 56,94 15: R\$ 56,94
30: R\$ 56,94 45: R\$ 56,94 60: R\$ 56,94



PASTA PP 4 CM LILAS 10X1

Código: 42039 Fábrica: ALAPLAST Unidade: PT/10 F1 F4

UN: R\$ 5,69 AV: R\$ 56,94 15: R\$ 56,94
30: R\$ 56,94 45: R\$ 56,94 60: R\$ 56,94



PASTA PP 4 CM ROSA 1024 10X1

Código: 41946 Fábrica: ACP Unidade: PT/10 F1 F4

UN: R\$ 5,69 AV: R\$ 56,94 15: R\$ 56,94
30: R\$ 56,94 45: R\$ 56,94 60: R\$ 56,94

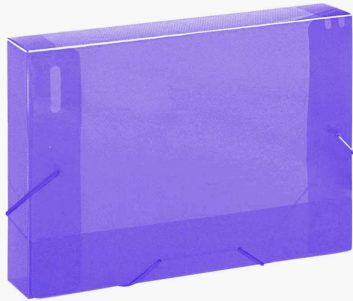

PASTA PP 4 CM ROXO 10X1

Código: 41985 Fábrica: ALAPLAST Unidade: PT/10 F1 F4

UN: R\$ 5,69 AV: R\$ 56,94 15: R\$ 56,94
30: R\$ 56,94 45: R\$ 56,94 60: R\$ 56,94



PASTA PP 4 CM VERDE 10X1

Código: 15867 Fábrica: ALAPLAST Unidade: PT/10 F1 F4

UN: R\$ 5,69 AV: R\$ 56,94 15: R\$ 56,94
30: R\$ 56,94 45: R\$ 56,94 60: R\$ 56,94



PASTA PP 4 CM VERMELHO 1024 10X1

Código: 15868 Fábrica: ACP Unidade: PT/10 F1 F4

UN: R\$ 6,98 AV: R\$ 6,98 15: R\$ 7,12
30: R\$ 7,27 45: R\$ 7,41 60: R\$ 7,56

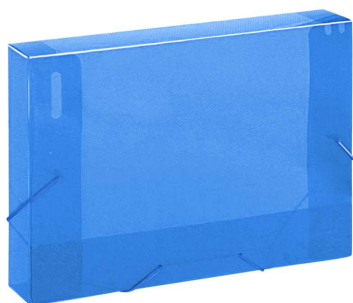

PASTA PP 5,5 CM UN

Código: 14358 Fábrica: VMP Unidade: UN/1 F1 F4

UN: R\$ 6,79 AV: R\$ 67,94 15: R\$ 67,94
30: R\$ 67,94 45: R\$ 67,94 60: R\$ 67,94

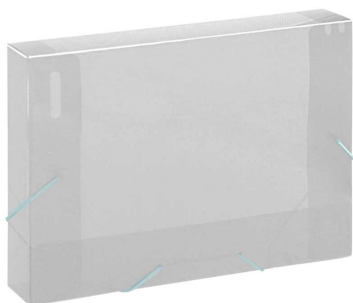

PASTA PP 5,5 CM CRISTAL TRANS 10X1

Código: 34123 Fábrica: ALAPLAST Unidade: PT/10 F1 F4

UN: R\$ 6,79 AV: R\$ 67,94 15: R\$ 67,94
30: R\$ 67,94 45: R\$ 67,94 60: R\$ 67,94



PASTA PP 5,5 CM CRISTAL 1025 10X1

Código: 46205 Fábrica: ACP Unidade: PT/10 F1 F4

UN: R\$ 6,79 AV: R\$ 67,94 15: R\$ 67,94
30: R\$ 67,94 45: R\$ 67,94 60: R\$ 67,94



PASTA PP 5,5 CM FUME TRANSP 10X1

Código: 44331 Fábrica: ALAPLAST Unidade: PT/10 F1 F4

UN: R\$ 6,79 AV: R\$ 67,94 15: R\$ 67,94
30: R\$ 67,94 45: R\$ 67,94 60: R\$ 67,94

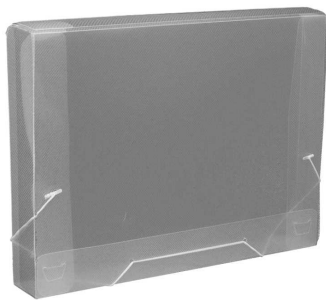

PASTA PP 5,5 CM FUME 1025 10X1

Código: 46206 Fábrica: ACP Unidade: PT/10 F1 F4

UN: R\$ 6,69 AV: R\$ 66,89 15: R\$ 68,29
30: R\$ 69,65 45: R\$ 71,05 60: R\$ 72,47



PASTA PP 6 CM CRISTAL 10X1

Código: 30434 Fábrica: ALAPLAST Unidade: PT/10 F1 F4

UN: R\$ 83,86 AV: R\$ 83,86 15: R\$ 85,60
30: R\$ 87,31 45: R\$ 89,06 60: R\$ 90,84



PASTA SANFONA PAPELÃO OFIC A-Z

Código: 45963 Fábrica: DELUCAS Unidade: UN/1 F1 F4

UN: R\$ 3,00 AV: R\$ 149,75 15: R\$ 152,87
30: R\$ 155,93 45: R\$ 159,05 60: R\$ 162,23



PASTA SUSPensa HT PVC KRAFT KC 50X1

Código: 18085 Fábrica: TP PASTAS Unidade: CX/50 F1 F4

UN: R\$ 3,59 AV: R\$ 179,70 15: R\$ 183,45
30: R\$ 187,11 45: R\$ 190,86 60: R\$ 194,67



PASTA SUSPensa HT PVC MARM CAST MC 50X1

Código: 44636 Fábrica: TP PASTAS Unidade: CX/50 F1 F4

UN: R\$ 5,19 AV: R\$ 259,57 15: R\$ 264,98
30: R\$ 270,28 45: R\$ 275,69 60: R\$ 281,20



PASTA SUSPensa HT PVC MARM PL CAST 50X1

Código: 42854 Fábrica: DELLO/TPPAST Unidade: CX/50 F1 F4

UN: R\$ 3,59 AV: R\$ 89,85 15: R\$ 91,72
30: R\$ 93,55 45: R\$ 95,42 60: R\$ 97,33



PASTA SUSPensa KRAFT NATURAL 25X1

Código: 37444 Fábrica: ACRIMET Unidade: PT/25 F1 F4

UN: R\$ 4,89 AV: R\$ 48,91 15: R\$ 49,93
30: R\$ 50,93 45: R\$ 51,95 60: R\$ 52,99

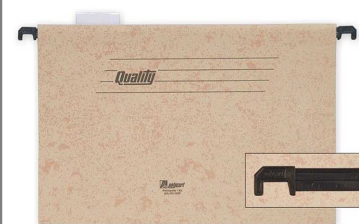

PASTA SUSPensa MARM HT PLAST 10X1

Código: 51133 Fábrica: POLYCART Unidade: PT/10 F1 F4

UN: R\$ 3,59 AV: R\$ 35,93 15: R\$ 36,68
30: R\$ 37,41 45: R\$ 38,16 60: R\$ 38,93



PASTA SUSPensa MARM LISA HT PLAST 10X1

Código: 27075 Fábrica: POLYCART Unidade: PT/10 F1 F4

UN: R\$ 4,61 AV: R\$ 46,13 15: R\$ 47,09
30: R\$ 48,03 45: R\$ 48,99 60: R\$ 49,97



PASTA SUSPensa MARM PLAST HT PLAST 10X1

Código: 51135 Fábrica: POLYCART Unidade: PT/10 F1 F4

UN: R\$ 5,30 AV: R\$ 53,02 15: R\$ 54,12
30: R\$ 55,20 45: R\$ 56,31 60: R\$ 57,43



PASTA SUSPensa MARM PLAST HT PLAST 10X1

Código: 51131 Fábrica: POLYCART Unidade: PT/10 F1 F4

UN: R\$ 3,99 AV: R\$ 39,93 15: R\$ 40,76
30: R\$ 41,57 45: R\$ 42,40 60: R\$ 43,25



PASTA SUSPensa MARM PLAST HT PLAST 10X1

Código: 49996 Fábrica: POLYCART Unidade: PT/10 F1 F4

UN: R\$ 4,99 AV: R\$ 124,79 15: R\$ 127,39
30: R\$ 129,94 45: R\$ 132,54 60: R\$ 135,19



PASTA SUSPensa MARM PLAST HT PVC 25X1

Código: 47804 Fábrica: POLYCART Unidade: PT/25 F1 F4

UN: R\$ 3,31 AV: R\$ 165,72 15: R\$ 169,18
30: R\$ 172,56 45: R\$ 176,01 60: R\$ 179,53



PASTA SUSPensa MARM S KRAF HT PLAST 50X1

Código: 49995 Fábrica: POLYCART Unidade: PT/50 F1 F4

UN: R\$ 4,11 AV: R\$ 205,41 15: R\$ 209,69
30: R\$ 213,88 45: R\$ 218,16 60: R\$ 222,52



PASTA SUSPensa MARM S KRAF HT PLAST 50X1

Código: 51132 Fábrica: POLYCART Unidade: PT/50 F1 F4

UN: R\$ 5,99 AV: R\$ 59,89 15: R\$ 61,14
30: R\$ 62,36 45: R\$ 63,61 60: R\$ 64,88



PASTA SUSPensa MARMORE GRAMPO METAL 10X1

Código: 44447 Fábrica: POLYCART Unidade: PT/10 F1 F4

UN: R\$ 2,80 AV: R\$ 2,80 15: R\$ 2,85
30: R\$ 2,91 45: R\$ 2,97 60: R\$ 3,03



PASTA SUSPensa MARMORIZADA UN

Código: FábriCa: Unidade:
42141 TP UN/1
F1 F4

UN: R\$ 29,94 AV: R\$ 29,94 15: R\$ 30,57
30: R\$ 31,18 45: R\$ 31,80 60: R\$ 32,44



PEN DRIVE 4 GB USB 2.0

Código: FábriCa: Unidade:
20790 MULTILASER UN/1
F1 F4

UN: R\$ 33,94 AV: R\$ 33,94 15: R\$ 34,64
30: R\$ 35,34 45: R\$ 36,04 60: R\$ 36,76



PEN DRIVE 8 GB USB 2.0

Código: FábriCa: Unidade:
25947 INOVA UN/1
F1 F4

UN: R\$ 39,93 AV: R\$ 39,93 15: R\$ 40,76
30: R\$ 41,57 45: R\$ 42,40 60: R\$ 43,25



PEN DRIVE 16 GB USB 2.0

Código: FábriCa: Unidade:
35870 MAKETECH UN/1
F1 F4

UN: R\$ 49,91 AV: R\$ 49,91 15: R\$ 50,95
30: R\$ 51,97 45: R\$ 53,01 60: R\$ 54,07



PEN DRIVE 32 GB USB 2.0

Código: FábriCa: Unidade:
35871 MAKETECH UN/1
F1 F4

UN: R\$ 67,88 AV: R\$ 67,88 15: R\$ 69,30
30: R\$ 70,68 45: R\$ 72,09 60: R\$ 73,54



PEN DRIVE 64 GB USB 2.0 METAL DIAMOND

Código: FábriCa: Unidade:
42432 MULTILASER UN/1
F1 F4

UN: R\$ 169,72 AV: R\$ 169,72 15: R\$ 173,25
30: R\$ 176,72 45: R\$ 180,25 60: R\$ 183,86



PEN DRIVE 128 GB USB 2.0

Código: FábriCa: Unidade:
42430 MULTILASER UN/1
F1 F4

UN: R\$ 0,04 AV: R\$ 3,78 15: R\$ 3,86
30: R\$ 3,94 45: R\$ 4,02 60: R\$ 4,10



PERCEVEJO LATONADO DOURADO 96036 100X1

Código: FábriCa: Unidade:
40974 JOCAROFFICE CX/100
F1 F4

UN: R\$ 0,04 AV: R\$ 3,78 15: R\$ 3,86
30: R\$ 3,94 45: R\$ 4,02 60: R\$ 4,10



PERCEVEJO LATONADO 100X1

Código: FábriCa: Unidade:
13243 BRW CE/100
F1 F4

UN: R\$ 7,98 AV: R\$ 7,98 15: R\$ 8,14
30: R\$ 8,31 45: R\$ 8,47 60: R\$ 8,64



PERFURADOR METAL FURO UNICO 6MM 6FLS 804

Código: FábriCa: Unidade:
39779 MASTERPRINT CR/1
F1 F4

UN: R\$ 27,95 AV: R\$ 27,95 15: R\$ 28,53
30: R\$ 29,10 45: R\$ 29,68 60: R\$ 30,27



PERFURADOR METAL MED 2 FUROS 20FLS 2000

Código: FábriCa: Unidade:
14670 BRW/EASYOFFI UN/1
F1 F4

UN: R\$ 8,98 AV: R\$ 8,98 15: R\$ 9,16
30: R\$ 9,35 45: R\$ 9,53 60: R\$ 9,72



PERFURADOR METAL PQ 2 FUROS 5FLS 808

Código: FábriCa: Unidade:
41950 YING FA UN/1
F1 F4

UN: R\$ 11,97 AV: R\$ 11,97 15: R\$ 12,22
30: R\$ 12,46 45: R\$ 12,71 60: R\$ 12,97



PERFURADOR METAL 2 FUROS 10FLS V082

Código: FábriCa: Unidade:
39925 VMP UN/1
F1 F4

UN: R\$ 13,73 AV: R\$ 13,73 15: R\$ 14,01
30: R\$ 14,29 45: R\$ 14,58 60: R\$ 14,87



PERFURADOR METAL 2 FUROS 10FLS 7131

Código: FábriCa: Unidade:
46942 YIN'S PAPER UN/1
F1 F4

UN: R\$ 293,52 AV: R\$ 293,52 15: R\$ 299,63
30: R\$ 305,63 45: R\$ 311,74 60: R\$ 317,97



PERFURADOR METAL 2 FUROS 100FLS GUIA 91

Código: FábriCa: Unidade:
46921 YIN'S PAPER UN/1
F1 F4

UN: R\$ 24,95 AV: R\$ 24,95 15: R\$ 25,47
30: R\$ 25,98 45: R\$ 26,50 60: R\$ 27,03



PERFURADOR METAL 2 FUROS 20FLS 801

Código: FábriCa: Unidade:
39783 MASTERPRINT UN/1
F1 F4

UN: R\$ 43,13 AV: R\$ 43,13 15: R\$ 44,03
30: R\$ 44,91 45: R\$ 45,81 60: R\$ 46,72



PERFURADOR METAL 2 FUROS 25FLS C/GUIA
Código: Fábrika: Unidade:
46431 KAZ UN/1
F1 F4

UN: R\$ 26,95 AV: R\$ 26,95 15: R\$ 27,51
30: R\$ 28,06 45: R\$ 28,62 60: R\$ 29,19



PERFURADOR METAL 2 FUROS 25FLS GUIA 790
Código: Fábrika: Unidade:
46928 YIN'S PAPER UN/1
F1 F4

UN: R\$ 57,90 AV: R\$ 57,90 15: R\$ 59,10
30: R\$ 60,29 45: R\$ 61,49 60: R\$ 62,72



PERFURADOR METAL 2 FUROS 35FLS C/GUIA
Código: Fábrika: Unidade:
6565 BRW UN/1
F1 F4

UN: R\$ 54,90 AV: R\$ 54,90 15: R\$ 56,05
30: R\$ 57,17 45: R\$ 58,31 60: R\$ 59,48



PERFURADOR METAL 2 FUROS 35FLS 083
Código: Fábrika: Unidade:
42408 VMP UN/1
F1 F4

UN: R\$ 47,91 AV: R\$ 47,91 15: R\$ 48,91
30: R\$ 49,89 45: R\$ 50,89 60: R\$ 51,91



PERFURADOR METAL 2 FUROS 40FLS 802
Código: Fábrika: Unidade:
41957 MASTERPRINT UN/1
F1 F4

UN: R\$ 139,77 AV: R\$ 139,77 15: R\$ 142,68
30: R\$ 145,53 45: R\$ 148,44 60: R\$ 151,41



PERFURADOR METAL 2 FUROS 50 FLS 93022
Código: Fábrika: Unidade:
46368 JOCAROFFICE UN/1
F1 F4

UN: R\$ 132,56 AV: R\$ 132,56 15: R\$ 135,32
30: R\$ 138,03 45: R\$ 140,79 60: R\$ 143,60



PERFURADOR METAL 2 FUROS 60FL GDE C/GUIA
Código: Fábrika: Unidade:
42235 MASTERPRINT UN/1
F1 F4

UN: R\$ 92,84 AV: R\$ 92,84 15: R\$ 94,78
30: R\$ 96,67 45: R\$ 98,60 60: R\$ 100,58



PERFURADOR METAL 2 FUROS 60FLS BM2149
Código: Fábrika: Unidade:
48851 FIRST UN/1
F1 F4

UN: R\$ 181,70 AV: R\$ 181,70 15: R\$ 185,48
30: R\$ 189,19 45: R\$ 192,98 60: R\$ 196,84



PERFURADOR METAL 2 FUROS 70FLS 282205
Código: Fábrika: Unidade:
43019 FUTURO UN/1
F1 F4

UN: R\$ 74,87 AV: R\$ 74,87 15: R\$ 76,43
30: R\$ 77,96 45: R\$ 79,52 60: R\$ 81,11



PERFURADOR PAPEL 2 FUROS 30FLS FUNDIDO
Código: Fábrika: Unidade:
42328 CAVIA UN/1
F1 F4

UN: R\$ 129,78 AV: R\$ 129,78 15: R\$ 132,49
30: R\$ 135,14 45: R\$ 137,84 60: R\$ 140,60



PERFURADOR PAPEL 2 FUROS 60FLS FUNDIDO
Código: Fábrika: Unidade:
42466 CAVIA UN/1
F1 F4

UN: R\$ 329,46 AV: R\$ 329,46 15: R\$ 336,33
30: R\$ 343,05 45: R\$ 349,91 60: R\$ 356,91



PERFURADOR PAPEL 2 FUROS 100FLS FUNDIDO
Código: Fábrika: Unidade:
42318 CAVIA UN/1
F1 F4

UN: R\$ 79,86 AV: R\$ 79,86 15: R\$ 81,53
30: R\$ 83,16 45: R\$ 84,82 60: R\$ 86,52



PERFURADOR PLAST P/EVA EXTRA GIGANTE
Código: Fábrika: Unidade:
48579 RENK UN/1
F1 F4

UN: R\$ 18,96 AV: R\$ 18,96 15: R\$ 19,35
30: R\$ 19,74 45: R\$ 20,14 60: R\$ 20,54



PERFURADOR PLAST P/EVA PEQ FIGURAS SORT
Código: Fábrika: Unidade:
41973 VMP UN/1
F1 F4

UN: R\$ 18,27 AV: R\$ 18,27 15: R\$ 18,65
30: R\$ 19,02 45: R\$ 19,40 60: R\$ 19,79



PERFURADOR PLAST P/EVA 16MM 8438
Código: Fábrika: Unidade:
48139 YIN'S PAPER UN/1
F1 F4



UN: R\$ 29,94 AV: R\$ 29,94 15: R\$ 30,57
30: R\$ 31,18 45: R\$ 31,80 60: R\$ 32,44



PERFURADOR PLAST P/EVA 25MM 8439
Código: Fábrika: Unidade:
46929 YIN'S PAPER UN/1
F1 F4



UN: R\$ 79,86 AV: R\$ 79,86 15: R\$ 81,53
30: R\$ 83,16 45: R\$ 84,82 60: R\$ 86,52



PERFURADOR PLAST P/EVA 38MM 12052
Código: Fábrica: Unidade:
51005 MAKE+ UN/1
F1 F4

UN: R\$ 119,80 AV: R\$ 119,80 15: R\$ 122,29
30: R\$ 124,74 45: R\$ 127,23 60: R\$ 129,78



PERFURADOR PLAST P/EVA 50MM 8440
Código: Fábrica: Unidade:
46930 YIN'S/MAKE UN/1
F1 F4

UN: R\$ 7,98 AV: R\$ 7,98 15: R\$ 8,14
30: R\$ 8,31 45: R\$ 8,47 60: R\$ 8,64

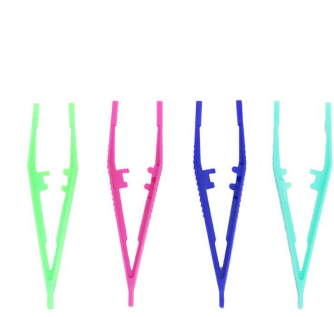

PINCA PLAST COORDENACAO MOTORA 10,5X1X3C
Código: Fábrica: Unidade:
44114 PAPIMUNI UN/1
F1 F4

UN: R\$ 11,65 AV: R\$ 69,88 15: R\$ 71,33
30: R\$ 72,76 45: R\$ 74,22 60: R\$ 75,70



PINCEL ARTIS CHANF LONG AMA 18 C517 6X1
Código: Fábrica: Unidade:
50970 CASTELO PT/6
F1 F4

UN: R\$ 18,97 AV: R\$ 113,82 15: R\$ 116,19
30: R\$ 118,51 45: R\$ 120,88 60: R\$ 123,30



PINCEL ARTIS LEQUE LONG AMA 04 C513 6X1
Código: Fábrica: Unidade:
50971 CASTELO PT/6
F1 F4

UN: R\$ 23,29 AV: R\$ 139,77 15: R\$ 142,68
30: R\$ 145,53 45: R\$ 148,44 60: R\$ 151,41



PINCEL ARTIS LEQUE LONG AMA 06 C513 6X1
Código: Fábrica: Unidade:
50972 CASTELO PT/6
F1 F4

UN: R\$ 4,66 AV: R\$ 55,91 15: R\$ 57,08
30: R\$ 58,22 45: R\$ 59,38 60: R\$ 60,57



PINCEL ARTIS RED LONG AMA 6 87891 12X1
Código: Fábrica: Unidade:
45480 CONDOR PT/12
F1 F4

UN: R\$ 5,32 AV: R\$ 63,90 15: R\$ 65,23
30: R\$ 66,53 45: R\$ 67,86 60: R\$ 69,22



PINCEL ARTIS RED LONG AMA 8 970927 12X1
Código: Fábrica: Unidade:
45481 CONDOR PT/12
F1 F4

UN: R\$ 5,75 AV: R\$ 69,06 15: R\$ 70,50
30: R\$ 71,91 45: R\$ 73,35 60: R\$ 74,81



PINCEL ARTIS RED LONG AMA 10 970928 12X1
Código: Fábrica: Unidade:
45482 CONDOR PT/12
F1 F4

UN: R\$ 6,52 AV: R\$ 78,26 15: R\$ 79,90
30: R\$ 81,49 45: R\$ 83,12 60: R\$ 84,79



PINCEL ARTIS RED LONG AMA 12 970929 12X1
Código: Fábrica: Unidade:
45483 CONDOR PT/12
F1 F4

UN: R\$ 9,73 AV: R\$ 116,81 15: R\$ 119,25
30: R\$ 121,63 45: R\$ 124,06 60: R\$ 126,55



PINCEL ARTIS RED LONG AMA 18 970932 12X1
Código: Fábrica: Unidade:
45484 CONDOR PT/12
F1 F4

UN: R\$ 17,06 AV: R\$ 102,34 15: R\$ 104,47
30: R\$ 106,56 45: R\$ 108,69 60: R\$ 110,86



PINCEL ARTIS RED LONG AMA 24 970935 6X1
Código: Fábrica: Unidade:
51042 CONDOR PT/6
F1 F4

UN: R\$ 14,68 AV: R\$ 176,22 15: R\$ 179,89
30: R\$ 183,49 45: R\$ 187,16 60: R\$ 190,90



PINCEL ARTIST LINGUA GATO 2 88669 12X1
Código: Fábrica: Unidade:
42901 CONDOR PT/12
F1 F4

UN: R\$ 19,97 AV: R\$ 239,61 15: R\$ 244,60
30: R\$ 249,49 45: R\$ 254,48 60: R\$ 259,57



PINCEL ARTIST LINGUA GATO 6 88671 12X1
Código: Fábrica: Unidade:
42900 CONDOR PT/12
F1 F4

UN: R\$ 9,53 AV: R\$ 114,42 15: R\$ 116,80
30: R\$ 119,14 45: R\$ 121,52 60: R\$ 123,95



PINCEL ARTIST P/PINTURA 0 86836 12X1
Código: Fábrica: Unidade:
45449 CONDOR PT/12
F1 F4

UN: R\$ 9,88 AV: R\$ 118,58 15: R\$ 121,05
30: R\$ 123,47 45: R\$ 125,94 60: R\$ 128,46



PINCEL ARTIST P/PINTURA 00 86837 12X1
Código: Fábrica: Unidade:
45450 CONDOR PT/12
F1 F4

UN: R\$ 9,71 AV: R\$ 116,49 15: R\$ 118,92
30: R\$ 121,30 45: R\$ 123,72 60: R\$ 126,20



PINCEL ARTIST P/PINTURA 000 86838 12X1

Código: Fábrica: Unidade:
45451 CONDOR PT/12
F1 F4

UN: R\$ 2,99 AV: R\$ 35,88 15: R\$ 35,88
30: R\$ 35,88 45: R\$ 35,88 60: R\$ 35,88



PINCEL AT BOLD REC QUAD BCO AZU 679 12X1

Código: Fábrica: Unidade:
42965 GOLLER DZ/12
F1 F4

UN: R\$ 2,99 AV: R\$ 35,88 15: R\$ 35,88
30: R\$ 35,88 45: R\$ 35,88 60: R\$ 35,88



PINCEL AT BOLD REC QUAD BCO PT 6080 12X1

Código: Fábrica: Unidade:
42964 GOLLER DZ/12
F1 F4

UN: R\$ 2,50 AV: R\$ 29,94 15: R\$ 30,57
30: R\$ 31,18 45: R\$ 31,80 60: R\$ 32,44



PINCEL AT COMPACTOR AZUL 12X1

Código: Fábrica: Unidade:
2570 COMPACTOR DZ/12
F1 F4

UN: R\$ 2,50 AV: R\$ 29,94 15: R\$ 30,57
30: R\$ 31,18 45: R\$ 31,80 60: R\$ 32,44



PINCEL AT COMPACTOR PRETO 12X1

Código: Fábrica: Unidade:
3275 COMPACTOR DZ/12
F1 F4

UN: R\$ 2,50 AV: R\$ 29,94 15: R\$ 30,57
30: R\$ 31,18 45: R\$ 31,80 60: R\$ 32,44



PINCEL AT COMPACTOR SORTIDO 12X1

Código: Fábrica: Unidade:
3819 COMPACTOR DZ/12
F1 F4

UN: R\$ 2,20 AV: R\$ 52,91 15: R\$ 54,01
30: R\$ 55,09 45: R\$ 56,19 60: R\$ 57,31



PINCEL AT COMPACTOR SORTIDO 24X1

Código: Fábrica: Unidade:
48157 COMPACTOR CR/24
F1 F4

UN: R\$ 2,50 AV: R\$ 29,94 15: R\$ 30,57
30: R\$ 31,18 45: R\$ 31,80 60: R\$ 32,44



PINCEL AT COMPACTOR VERMELHO 12X1

Código: Fábrica: Unidade:
3276 COMPACTOR DZ/12
F1 F4

UN: R\$ 14,97 AV: R\$ 14,97 15: R\$ 15,28
30: R\$ 15,58 45: R\$ 15,90 60: R\$ 16,21



PINCEL AT COMPACTOR 6 CORES SORT

Código: Fábrica: Unidade:
40911 COMPACTOR UN/1
F1 F4

UN: R\$ 1,70 AV: R\$ 16,96 15: R\$ 17,32
30: R\$ 17,66 45: R\$ 18,02 60: R\$ 18,38



PINCEL AT MARC PERM AZUL 2116 10X1

Código: Fábrica: Unidade:
49774 FIRST CX/10
F1 F4

UN: R\$ 3,74 AV: R\$ 44,90 15: R\$ 45,83
30: R\$ 46,75 45: R\$ 47,69 60: R\$ 48,64



PINCEL AT MARC PERM DESTAQ AMARELO 12X1

Código: Fábrica: Unidade:
48161 COMPACTOR CX/12
F1 F4

UN: R\$ 3,74 AV: R\$ 44,90 15: R\$ 45,83
30: R\$ 46,75 45: R\$ 47,69 60: R\$ 48,64



PINCEL AT MARC PERM DESTAQ AZUL 12X1

Código: Fábrica: Unidade:
48158 COMPACTOR CX/12
F1 F4

UN: R\$ 3,74 AV: R\$ 44,90 15: R\$ 45,83
30: R\$ 46,75 45: R\$ 47,69 60: R\$ 48,64



PINCEL AT MARC PERM DESTAQ LARANJA 12X1

Código: Fábrica: Unidade:
48165 COMPACTOR CX/12
F1 F4

UN: R\$ 3,74 AV: R\$ 44,90 15: R\$ 45,83
30: R\$ 46,75 45: R\$ 47,69 60: R\$ 48,64



PINCEL AT MARC PERM DESTAQ MAGE 12X1

Código: Fábrica: Unidade:
48164 COMPACTOR CX/12
F1 F4

UN: R\$ 3,74 AV: R\$ 44,90 15: R\$ 45,83
30: R\$ 46,75 45: R\$ 47,69 60: R\$ 48,64



PINCEL AT MARC PERM DESTAQ MARROM 12X1

Código: Fábrica: Unidade:
48163 COMPACTOR CX/12
F1 F4

UN: R\$ 3,74 AV: R\$ 44,90 15: R\$ 45,83
30: R\$ 46,75 45: R\$ 47,69 60: R\$ 48,64



PINCEL AT MARC PERM DESTAQ ROSA 12X1

Código: Fábrica: Unidade:
48166 COMPACTOR CX/12
F1 F4

UN: R\$ 3,74 AV: R\$ 44,90 15: R\$ 45,83
30: R\$ 46,75 45: R\$ 47,69 60: R\$ 48,64



PINCEL AT MARC PERM DESTAQ VERDE 12X1
Código: 48162 Fábrica: COMPACTOR Unidade: CX/12 F1 F4

UN: R\$ 3,74 AV: R\$ 44,90 15: R\$ 45,83
30: R\$ 46,75 45: R\$ 47,69 60: R\$ 48,64



PINCEL AT MARC PERM DESTAQ VERMEL 12X1
Código: 48160 Fábrica: COMPACTOR Unidade: CX/12 F1 F4

UN: R\$ 1,70 AV: R\$ 16,96 15: R\$ 17,32
30: R\$ 17,66 45: R\$ 18,02 60: R\$ 18,38



PINCEL AT MARC PERM PRETO 2115 10X1
Código: 49776 Fábrica: FIRST Unidade: CX/10 F1 F4

UN: R\$ 4,82 AV: R\$ 57,90 15: R\$ 59,10
30: R\$ 60,29 45: R\$ 61,49 60: R\$ 62,72



PINCEL AT MARC PERM REC AZUL 12X1
Código: 35996 Fábrica: COMPACTOR Unidade: CX/12 F1 F4

UN: R\$ 2,73 AV: R\$ 32,72 15: R\$ 33,40
30: R\$ 34,07 45: R\$ 34,75 60: R\$ 35,44



PINCEL AT MARC PERM REC AZUL 616 12X1
Código: 39788 Fábrica: MASTERPRINT Unidade: DZ/12 F1 F4

UN: R\$ 3,54 AV: R\$ 42,43 15: R\$ 43,32
30: R\$ 44,18 45: R\$ 45,07 60: R\$ 45,97



PINCEL AT MARC PERM REC AZUL 7011 12X1
Código: 40915 Fábrica: BRW Unidade: DZ/12 F1 F4

UN: R\$ 5,16 AV: R\$ 61,89 15: R\$ 63,18
30: R\$ 64,44 45: R\$ 65,73 60: R\$ 67,05



PINCEL AT MARC PERM REC PRETO 12X1
Código: 35997 Fábrica: COMPACTOR Unidade: CX/12 F1 F4

UN: R\$ 4,82 AV: R\$ 57,90 15: R\$ 59,10
30: R\$ 60,29 45: R\$ 61,49 60: R\$ 62,72



PINCEL AT MARC PERM REC VERDE 12X1
Código: 48153 Fábrica: COMPACTOR Unidade: DZ/12 F1 F4

UN: R\$ 2,73 AV: R\$ 32,72 15: R\$ 33,40
30: R\$ 34,07 45: R\$ 34,75 60: R\$ 35,44



PINCEL AT MARC PERM REC VERDE 616 12X1
Código: 42892 Fábrica: MASTERPRINT Unidade: DZ/12 F1 F4

UN: R\$ 2,73 AV: R\$ 32,72 15: R\$ 33,40
30: R\$ 34,07 45: R\$ 34,75 60: R\$ 35,44



PINCEL AT MARC PERM REC VERMEL 616 12X1
Código: 39790 Fábrica: MASTERPRINT Unidade: DZ/12 F1 F4

UN: R\$ 1,95 AV: R\$ 23,41 15: R\$ 23,90
30: R\$ 24,38 45: R\$ 24,87 60: R\$ 25,36



PINCEL AT MARC PERM SLIM AZUL 615 12X1
Código: 51059 Fábrica: MASTERPRINT Unidade: DZ/12 F1 F4

UN: R\$ 1,95 AV: R\$ 23,41 15: R\$ 23,90
30: R\$ 24,38 45: R\$ 24,87 60: R\$ 25,36



PINCEL AT MARC PERM SLIM PRETO 615 12X1
Código: 51058 Fábrica: MASTERPRINT Unidade: DZ/12 F1 F4

UN: R\$ 1,70 AV: R\$ 16,96 15: R\$ 17,32
30: R\$ 17,66 45: R\$ 18,02 60: R\$ 18,38



PINCEL AT MARC PERM VERMELHO 2117 10X1
Código: 49775 Fábrica: FIRST Unidade: CX/10 F1 F4

UN: R\$ 3,49 AV: R\$ 41,93 15: R\$ 42,81
30: R\$ 43,66 45: R\$ 44,54 60: R\$ 45,43



PINCEL AT MARC PERM VERMELHO 616 12X1
Código: 39787 Fábrica: MASTERPRINT Unidade: DZ/12 F1 F4

UN: R\$ 4,24 AV: R\$ 50,92 15: R\$ 51,98
30: R\$ 53,02 45: R\$ 54,08 60: R\$ 55,16



PINCEL AT MARC QUAD BCO AZUL REC 601 12X1
Código: 37651 Fábrica: BRW Unidade: DZ/12 F1 F4

UN: R\$ 17,88 AV: R\$ 17,88 15: R\$ 17,88
30: R\$ 17,88 45: R\$ 17,88 60: R\$ 17,88



PINCEL AT MARC QUAD BCO AZUL BM2112 12X1
Código: 48844 Fábrica: FIRST Unidade: UN/1 F1 F4

UN: R\$ 7,49 AV: R\$ 74,87 15: R\$ 76,43
30: R\$ 77,96 45: R\$ 79,52 60: R\$ 81,11



PINCEL AT MARC QUAD BCO AZUL REC RF 10X1
Código: Fábrica: Unidade:
48181 JOCAROFFICE CX/10
F1 F4

UN: R\$ 4,99 AV: R\$ 59,89 15: R\$ 61,14
30: R\$ 62,36 45: R\$ 63,61 60: R\$ 64,88



PINCEL AT MARC QUAD BCO AZUL REC 12X1
Código: Fábrica: Unidade:
51015 JOCAROFFICE CX/12
F1 F4

UN: R\$ 6,66 AV: R\$ 79,86 15: R\$ 81,53
30: R\$ 83,16 45: R\$ 84,82 60: R\$ 86,52



PINCEL AT MARC QUAD BCO AZUL REC 12X1
Código: Fábrica: Unidade:
40913 COMPACTOR DZ/12
F1 F4

UN: R\$ 3,16 AV: R\$ 37,93 15: R\$ 38,72
30: R\$ 39,49 45: R\$ 40,28 60: R\$ 41,09



PINCEL AT MARC QUAD BCO AZUL 3001 12X1
Código: Fábrica: Unidade:
9909 BRW DZ/12
F1 F4

UN: R\$ 3,16 AV: R\$ 37,93 15: R\$ 38,72
30: R\$ 39,49 45: R\$ 40,28 60: R\$ 41,09



PINCEL AT MARC QUAD BCO AZUL 5981 12X1
Código: Fábrica: Unidade:
40679 GOLLER DZ/12
F1 F4

UN: R\$ 3,33 AV: R\$ 39,99 15: R\$ 39,99
30: R\$ 39,99 45: R\$ 39,99 60: R\$ 39,99



PINCEL AT MARC QUAD BCO AZUL 80003 12X1
Código: Fábrica: Unidade:
48211 EXPO TANK CX/12
F1 F4

UN: R\$ 2,82 AV: R\$ 33,84 15: R\$ 34,54
30: R\$ 35,23 45: R\$ 35,94 60: R\$ 36,65



PINCEL AT MARC QUAD BCO AZUL 96020 12X1
Código: Fábrica: Unidade:
48179 JOCAROFFICE DZ/12
F1 F4

UN: R\$ 3,63 AV: R\$ 14,53 15: R\$ 14,83
30: R\$ 15,13 45: R\$ 15,43 60: R\$ 15,74



PINCEL AT MARC QUAD BCO COLORS 4X1
Código: Fábrica: Unidade:
47391 JOCAROFFICE CJ/4
F1 F4

UN: R\$ 7,49 AV: R\$ 74,87 15: R\$ 76,43
30: R\$ 77,96 45: R\$ 79,52 60: R\$ 81,11



PINCEL AT MARC QUAD BCO PRET REC RF 10X1
Código: Fábrica: Unidade:
48182 JOCAROFFICE CX/10
F1 F4

UN: R\$ 3,16 AV: R\$ 37,93 15: R\$ 38,72
30: R\$ 39,49 45: R\$ 40,28 60: R\$ 41,09



PINCEL AT MARC QUAD BCO PRETO 12X1
Código: Fábrica: Unidade:
9910 BRW DZ/12
F1 F4

UN: R\$ 17,88 AV: R\$ 17,88 15: R\$ 17,88
30: R\$ 17,88 45: R\$ 17,88 60: R\$ 17,88



PINCEL AT MARC QUAD BCO PRETO 2113 12X1
Código: Fábrica: Unidade:
48845 FIRST UN/1
F1 F4

UN: R\$ 3,33 AV: R\$ 39,99 15: R\$ 39,99
30: R\$ 39,99 45: R\$ 39,99 60: R\$ 39,99



PINCEL AT MARC QUAD BCO PRETO 80001 12X1
Código: Fábrica: Unidade:
48212 EXPO TANK CX/12
F1 F4

UN: R\$ 2,82 AV: R\$ 33,84 15: R\$ 34,54
30: R\$ 35,23 45: R\$ 35,94 60: R\$ 36,65



PINCEL AT MARC QUAD BCO PRETO 96019 12X1
Código: Fábrica: Unidade:
48180 JOCAROFFICE DZ/12
F1 F4

UN: R\$ 5,57 AV: R\$ 66,88 15: R\$ 68,28
30: R\$ 69,64 45: R\$ 71,03 60: R\$ 72,46



PINCEL AT MARC QUAD BCO ROSA 12X1
Código: Fábrica: Unidade:
48565 NEWPEN DZ/12
F1 F4

UN: R\$ 3,16 AV: R\$ 37,93 15: R\$ 38,72
30: R\$ 39,49 45: R\$ 40,28 60: R\$ 41,09



PINCEL AT MARC QUAD BCO VERDE 12X1
Código: Fábrica: Unidade:
43800 BRW DZ/12
F1 F4

UN: R\$ 17,88 AV: R\$ 17,88 15: R\$ 17,88
30: R\$ 17,88 45: R\$ 17,88 60: R\$ 17,88



PINCEL AT MARC QUAD BCO VERM BM2114 12X1
Código: Fábrica: Unidade:
48846 FIRST UN/1
F1 F4

UN: R\$ 7,49 AV: R\$ 74,87 15: R\$ 76,43
30: R\$ 77,96 45: R\$ 79,52 60: R\$ 81,11



PINCEL AT MARC QUAD BCO VERM REC10X1
Código: Fábrica: Unidade:
48183 JOCAROFFICE CX/10
F1 F4

UN: R\$ 3,33 AV: R\$ 39,99 15: R\$ 39,99
30: R\$ 39,99 45: R\$ 39,99 60: R\$ 39,99



PINCEL AT MARC QUAD BCO VERM 80002 12X1
Código: Fábrica: Unidade:
48213 EXPO TANK CX/12
F1 F4

UN: R\$ 5,57 AV: R\$ 66,88 15: R\$ 68,28
30: R\$ 69,64 45: R\$ 71,03 60: R\$ 72,46



PINCEL AT MARC QUAD BCO VERMELHO 12X1
Código: Fábrica: Unidade:
48566 NEWPEN DZ/12
F1 F4

UN: R\$ 6,66 AV: R\$ 79,97 15: R\$ 79,97
30: R\$ 79,97 45: R\$ 79,97 60: R\$ 79,97



PINCEL AT QUAD BCO CARTUCH REC AZUL 12X1
Código: Fábrica: Unidade:
45216 BRW DZ/12
F1 F4

UN: R\$ 6,66 AV: R\$ 79,97 15: R\$ 79,97
30: R\$ 79,97 45: R\$ 79,97 60: R\$ 79,97



PINCEL AT QUAD BCO CARTUCH REC VERM 12X1
Código: Fábrica: Unidade:
45218 BRW DZ/12
F1 F4

UN: R\$ 6,66 AV: R\$ 79,97 15: R\$ 79,97
30: R\$ 79,97 45: R\$ 79,97 60: R\$ 79,97



PINCEL AT QUAD BCO CARTUCHO REC PTO 12X1
Código: Fábrica: Unidade:
45217 BRW DZ/12
F1 F4

UN: R\$ 2,83 AV: R\$ 33,94 15: R\$ 34,64
30: R\$ 35,34 45: R\$ 36,04 60: R\$ 36,76



PINCEL AT QUAD BCO REC AZUL 619 12X1
Código: Fábrica: Unidade:
43231 MASTERPRINT DZ/12
F1 F4

UN: R\$ 2,83 AV: R\$ 33,94 15: R\$ 34,64
30: R\$ 35,34 45: R\$ 36,04 60: R\$ 36,76



PINCEL AT QUAD BCO REC PRETO 619 12X1
Código: Fábrica: Unidade:
43233 MASTERPRINT DZ/12
F1 F4

UN: R\$ 2,83 AV: R\$ 33,94 15: R\$ 34,64
30: R\$ 35,34 45: R\$ 36,04 60: R\$ 36,76



PINCEL AT QUAD BCO REC VERDE 619 12X1
Código: Fábrica: Unidade:
42890 MASTERPRINT DZ/12
F1 F4

UN: R\$ 2,83 AV: R\$ 33,94 15: R\$ 34,64
30: R\$ 35,34 45: R\$ 36,04 60: R\$ 36,76



PINCEL AT QUAD BCO REC VERMELHO 619 12X1
Código: Fábrica: Unidade:
43232 MASTERPRINT DZ/12
F1 F4

UN: R\$ 2,00 AV: R\$ 23,96 15: R\$ 24,46
30: R\$ 24,95 45: R\$ 25,45 60: R\$ 25,96



PINCEL ESC CHAT AMAR 0 7164 12X1
Código: Fábrica: Unidade:
33840 GOLLER CR/12
F1 F4

UN: R\$ 2,08 AV: R\$ 24,95 15: R\$ 25,47
30: R\$ 25,98 45: R\$ 26,50 60: R\$ 27,03



PINCEL ESC CHAT AMAR 0 98733 12X1
Código: Fábrica: Unidade:
42895 CONDOR PT/12
F1 F4

UN: R\$ 6,24 AV: R\$ 74,87 15: R\$ 76,43
30: R\$ 77,96 45: R\$ 79,52 60: R\$ 81,11



PINCEL ESC CHAT AMAR 20 98743 12X1
Código: Fábrica: Unidade:
42898 CONDOR PT/12
F1 F4

UN: R\$ 9,48 AV: R\$ 56,90 15: R\$ 58,08
30: R\$ 59,25 45: R\$ 60,43 60: R\$ 61,64



PINCEL ESC CHAT AMAR 22 4169 6X1
Código: Fábrica: Unidade:
33846 LEO&LEO/GOLL CR/6
F1 F4

UN: R\$ 8,98 AV: R\$ 53,90 15: R\$ 55,03
30: R\$ 56,13 45: R\$ 57,25 60: R\$ 58,39



PINCEL ESC CHAT AMAR 24 98745 6X1
Código: Fábrica: Unidade:
42899 CONDOR PT/6
F1 F4

UN: R\$ 1,04 AV: R\$ 12,48 15: R\$ 12,74
30: R\$ 12,99 45: R\$ 13,25 60: R\$ 13,52



PINCEL ESC CHAT CURTO AMAR 0 4263 12X1
Código: Fábrica: Unidade:
48943 LEO&LEO CR/12
F1 F4

UN: R\$ 2,79 AV: R\$ 33,50 15: R\$ 34,19
30: R\$ 34,88 45: R\$ 35,58 60: R\$ 36,29



PINCEL ESC CHAT CURTO AMAR 2 88221 12X1
Código: Fábrica: Unidade:
45470 CONDOR PT/12
F1 F4

UN: R\$ 3,07 AV: R\$ 36,82 15: R\$ 37,59
30: R\$ 38,34 45: R\$ 39,11 60: R\$ 39,89



PINCEL ESC CHAT CURTO AMAR 4 88222 12X1
Código: Fábrica: Unidade:
45471 CONDOR PT/12
F1 F4

UN: R\$ 1,04 AV: R\$ 12,48 15: R\$ 12,74
30: R\$ 12,99 45: R\$ 13,25 60: R\$ 13,52



PINCEL ESC CHAT CURTO AMAR 02 4264 12X1
Código: Fábrica: Unidade:
48944 LEO&LEO CR/12
F1 F4

UN: R\$ 1,19 AV: R\$ 14,28 15: R\$ 14,57
30: R\$ 14,87 45: R\$ 15,16 60: R\$ 15,47



PINCEL ESC CHAT CURTO AMAR 04 4265 12X1
Código: Fábrica: Unidade:
43286 LEO&LEO CR/12
F1 F4

UN: R\$ 1,20 AV: R\$ 14,38 15: R\$ 14,68
30: R\$ 14,97 45: R\$ 15,27 60: R\$ 15,57



PINCEL ESC CHAT CURTO AMAR 06 4266 12X1
Código: Fábrica: Unidade:
43285 LEO&LEO CR/12
F1 F4

UN: R\$ 1,25 AV: R\$ 14,97 15: R\$ 15,28
30: R\$ 15,58 45: R\$ 15,90 60: R\$ 16,21



PINCEL ESC CHAT CURTO AMAR 10 4341 12X1
Código: Fábrica: Unidade:
43287 LEO&LEO CR/12
F1 F4

UN: R\$ 1,50 AV: R\$ 17,96 15: R\$ 18,34
30: R\$ 18,70 45: R\$ 19,08 60: R\$ 19,46



PINCEL ESC CHAT CURTO AMAR 14 4344 12X1
Código: Fábrica: Unidade:
48947 LEO&LEO CR/12
F1 F4

UN: R\$ 5,12 AV: R\$ 61,39 15: R\$ 62,67
30: R\$ 63,92 45: R\$ 65,20 60: R\$ 66,51



PINCEL ESC CHAT CURTO AMAR 14 88227 12X1
Código: Fábrica: Unidade:
45476 CONDOR PT/12
F1 F4

UN: R\$ 1,68 AV: R\$ 20,22 15: R\$ 20,64
30: R\$ 21,05 45: R\$ 21,47 60: R\$ 21,90



PINCEL ESC CHAT CURTO AMAR 16 4267 12X1
Código: Fábrica: Unidade:
49135 LEO&LEO CR/12
F1 F4

UN: R\$ 5,78 AV: R\$ 69,39 15: R\$ 70,83
30: R\$ 72,25 45: R\$ 73,70 60: R\$ 75,17



PINCEL ESC CHAT CURTO AMAR 16 90695 12X1
Código: Fábrica: Unidade:
45477 CONDOR PT/12
F1 F4

UN: R\$ 2,00 AV: R\$ 23,95 15: R\$ 24,45
30: R\$ 24,94 45: R\$ 25,44 60: R\$ 25,95



PINCEL ESC CHAT CURTO AMAR 18 4268 12X1
Código: Fábrica: Unidade:
48948 LEO&LEO CR/12
F1 F4

UN: R\$ 6,60 AV: R\$ 79,17 15: R\$ 80,82
30: R\$ 82,44 45: R\$ 84,09 60: R\$ 85,77



PINCEL ESC CHAT CURTO AMAR 18 90696 12X1
Código: Fábrica: Unidade:
45478 CONDOR PT/12
F1 F4

UN: R\$ 2,33 AV: R\$ 27,95 15: R\$ 28,53
30: R\$ 29,10 45: R\$ 29,68 60: R\$ 30,27



PINCEL ESC CHAT CURTO AMAR 20 4269 12X1
Código: Fábrica: Unidade:
48949 LEO&LEO CR/12
F1 F4

UN: R\$ 2,16 AV: R\$ 25,95 15: R\$ 26,49
30: R\$ 27,02 45: R\$ 27,56 60: R\$ 28,11



PINCEL ESC CHAT LONGO AMAR 2 98734 12X1
Código: Fábrica: Unidade:
42894 CONDOR PT/12
F1 F4

UN: R\$ 1,85 AV: R\$ 22,21 15: R\$ 22,68
30: R\$ 23,13 45: R\$ 23,59 60: R\$ 24,07



PINCEL ESC CHAT LONGO AMAR 02 4211 12X1
Código: Fábrica: Unidade:
41709 LEO&LEO CR/12
F1 F4

UN: R\$ 3,10 AV: R\$ 3,10 15: R\$ 3,16
30: R\$ 3,22 45: R\$ 3,29 60: R\$ 3,35



PINCEL ESC CHAT LONGO AMAR 036 12
Código: Fábrica: Unidade:
37899 LYKE UN/1
F1 F4

UN: R\$ 1,89 AV: R\$ 22,66 15: R\$ 23,14
30: R\$ 23,60 45: R\$ 24,07 60: R\$ 24,55



PINCEL ESC CHAT LONGO AMAR 04 4212 12X1
Código: Fábrica: Unidade:
31820 LEO&LEO CR/12
F1 F4

UN: R\$ 2,06 AV: R\$ 24,66 15: R\$ 25,17
30: R\$ 25,68 45: R\$ 26,19 60: R\$ 26,72



PINCEL ESC CHAT LONGO AMAR 06 4213 12X1
Código: Fábrica: Unidade:
31821 LEO&LEO CR/12
F1 F4

UN: R\$ 2,30 AV: R\$ 27,66 15: R\$ 28,23
30: R\$ 28,80 45: R\$ 29,37 60: R\$ 29,96



PINCEL ESC CHAT LONGO AMAR 08 4214 12X1
Código: Fábrica: Unidade:
42586 LEO&LEO CR/12
F1 F4

UN: R\$ 3,10 AV: R\$ 3,10 15: R\$ 3,16
30: R\$ 3,22 45: R\$ 3,29 60: R\$ 3,35



PINCEL ESC CHAT LONGO AMAR 10
Código: Fábrica: Unidade:
37898 LYKE UN/1
F1 F4

UN: R\$ 2,30 AV: R\$ 27,66 15: R\$ 28,23
30: R\$ 28,80 45: R\$ 29,37 60: R\$ 29,96



PINCEL ESC CHAT LONGO AMAR 10 4215 12X1
Código: Fábrica: Unidade:
42588 LEO&LEO CR/12
F1 F4

UN: R\$ 3,10 AV: R\$ 37,19 15: R\$ 37,97
30: R\$ 38,72 45: R\$ 39,50 60: R\$ 40,29



PINCEL ESC CHAT LONGO AMAR 10 98738 12X1
Código: Fábrica: Unidade:
43364 CONDOR PT/12
F1 F4

UN: R\$ 2,99 AV: R\$ 35,82 15: R\$ 36,57
30: R\$ 37,30 45: R\$ 38,05 60: R\$ 38,81



PINCEL ESC CHAT LONGO AMAR 12 4216 12X1
Código: Fábrica: Unidade:
41710 LEO&LEO CR/12
F1 F4

UN: R\$ 3,46 AV: R\$ 41,53 15: R\$ 42,40
30: R\$ 43,25 45: R\$ 44,11 60: R\$ 44,99



PINCEL ESC CHAT LONGO AMAR 12 98739 12X1
Código: Fábrica: Unidade:
43260 CONDOR PT/12
F1 F4

UN: R\$ 2,41 AV: R\$ 28,94 15: R\$ 29,55
30: R\$ 30,14 45: R\$ 30,74 60: R\$ 31,36



PINCEL ESC CHAT LONGO AMAR 14 4217 12X1
Código: Fábrica: Unidade:
31824 LEO&LEO CR/12
F1 F4

UN: R\$ 4,12 AV: R\$ 49,49 15: R\$ 50,52
30: R\$ 51,53 45: R\$ 52,56 60: R\$ 53,61



PINCEL ESC CHAT LONGO AMAR 14 98740 12X1
Código: Fábrica: Unidade:
43361 CONDOR PT/12
F1 F4

UN: R\$ 3,33 AV: R\$ 19,96 15: R\$ 20,37
30: R\$ 20,78 45: R\$ 21,20 60: R\$ 21,62



PINCEL ESC CHAT LONGO AMAR 16 4171 6X1
Código: Fábrica: Unidade:
42142 LEO&LEO CR/6
F1 F4

UN: R\$ 4,66 AV: R\$ 55,90 15: R\$ 57,07
30: R\$ 58,21 45: R\$ 59,37 60: R\$ 60,56



PINCEL ESC CHAT LONGO AMAR 16 98741 12X1
Código: Fábrica: Unidade:
43362 CONDOR PT/12
F1 F4

UN: R\$ 4,39 AV: R\$ 26,36 15: R\$ 26,91
30: R\$ 27,45 45: R\$ 27,99 60: R\$ 28,55



PINCEL ESC CHAT LONGO AMAR 18 4172 6X1
Código: Fábrica: Unidade:
41707 LEO&LEO CR/6
F1 F4

UN: R\$ 5,08 AV: R\$ 30,45 15: R\$ 31,09
30: R\$ 31,71 45: R\$ 32,34 60: R\$ 32,99



PINCEL ESC CHAT LONGO AMAR 20 4173 6X1
Código: Fábrica: Unidade:
41708 LEO&LEO CR/6
F1 F4

UN: R\$ 7,63 AV: R\$ 45,81 15: R\$ 46,76
30: R\$ 47,70 45: R\$ 48,65 60: R\$ 49,62



PINCEL ESC CHAT LONGO AMAR 24 4170 6X1
Código: Fábrica: Unidade:
33845 LEO&LEO CR/6
F1 F4

UN: R\$ 7,90 AV: R\$ 94,84 15: R\$ 96,81
30: R\$ 98,75 45: R\$ 100,73 60: R\$ 102,74



PINCEL ESC RED AMARELO 16 87896 12X1
Código: Fábrica: Unidade:
42896 CONDOR PT/12
F1 F4

UN: R\$ 10,44 AV: R\$ 125,30 15: R\$ 127,91
30: R\$ 130,47 45: R\$ 133,08 60: R\$ 135,74



PINCEL ESC RED AMARELO 20 87898 12X1
Código: Fábrica: Unidade:
42897 CONDOR PT/12
F1 F4

UN: R\$ 1,16 AV: R\$ 13,97 15: R\$ 14,26
30: R\$ 14,54 45: R\$ 14,83 60: R\$ 15,13



PINCEL ESC RED CURTO AMAR 0 4961 12X1
Código: Fábrica: Unidade:
42713 LEO&LEO CR/12
F1 F4

UN: R\$ 2,65 AV: R\$ 31,85 15: R\$ 32,51
30: R\$ 33,16 45: R\$ 33,83 60: R\$ 34,50



PINCEL ESC RED CURTO AMAR 0 88220 12X1
Código: Fábrica: Unidade:
45469 CONDOR PT/12
F1 F4

UN: R\$ 1,16 AV: R\$ 13,97 15: R\$ 14,26
30: R\$ 14,54 45: R\$ 14,83 60: R\$ 15,13



PINCEL ESC RED CURTO AMAR 00 4960 12X1
Código: Fábrica: Unidade:
20763 LEO&LEO CR/12
F1 F4

UN: R\$ 1,49 AV: R\$ 17,85 15: R\$ 18,22
30: R\$ 18,59 45: R\$ 18,96 60: R\$ 19,34



PINCEL ESC RED CURTO AMAR 02 4962 12X1
Código: Fábrica: Unidade:
23158 LEO&LEO CR/12
F1 F4

UN: R\$ 1,33 AV: R\$ 15,96 15: R\$ 16,30
30: R\$ 16,62 45: R\$ 16,96 60: R\$ 17,29



PINCEL ESC RED CURTO AMAR 04 4963 12X1
Código: Fábrica: Unidade:
42717 LEO&LEO CR/12
F1 F4

UN: R\$ 1,50 AV: R\$ 17,96 15: R\$ 18,34
30: R\$ 18,70 45: R\$ 19,08 60: R\$ 19,46



PINCEL ESC RED CURTO AMAR 06 4964 12X1
Código: Fábrica: Unidade:
41712 LEO&LEO CR/12
F1 F4

UN: R\$ 1,49 AV: R\$ 17,85 15: R\$ 18,22
30: R\$ 18,59 45: R\$ 18,96 60: R\$ 19,34



PINCEL ESC RED CURTO AMAR 08 4966 12X1
Código: Fábrica: Unidade:
24766 LEO&LEO CR/12
F1 F4

UN: R\$ 1,58 AV: R\$ 18,96 15: R\$ 19,35
30: R\$ 19,74 45: R\$ 20,14 60: R\$ 20,54



PINCEL ESC RED CURTO AMAR 10 4967 12X1
Código: Fábrica: Unidade:
48353 LEO&LEO CR/12
F1 F4

UN: R\$ 1,58 AV: R\$ 18,96 15: R\$ 19,35
30: R\$ 19,74 45: R\$ 20,14 60: R\$ 20,54



PINCEL ESC RED CURTO AMAR 12 4968 12X1
Código: Fábrica: Unidade:
48352 LEO&LEO CR/12
F1 F4

UN: R\$ 1,87 AV: R\$ 22,46 15: R\$ 22,93
30: R\$ 23,39 45: R\$ 23,86 60: R\$ 24,34



PINCEL ESC RED CURTO AMAR 16 4270 12X1
Código: Fábrica: Unidade:
48350 LEO&LEO CR/12
F1 F4

UN: R\$ 2,33 AV: R\$ 27,95 15: R\$ 28,53
30: R\$ 29,10 45: R\$ 29,68 60: R\$ 30,27



PINCEL ESC RED CURTO AMAR 18 4271 12X1
Código: Fábrica: Unidade:
46367 LEO&LEO CR/12
F1 F4

UN: R\$ 2,41 AV: R\$ 28,94 15: R\$ 29,55
30: R\$ 30,14 45: R\$ 30,74 60: R\$ 31,36



PINCEL ESC RED CURTO AMAR 20 4272 12X1
Código: Fábrica: Unidade:
42144 LEO&LEO CR/12
F1 F4

UN: R\$ 2,41 AV: R\$ 28,87 15: R\$ 29,48
30: R\$ 30,06 45: R\$ 30,67 60: R\$ 31,28



PINCEL ESC RED CURTO VERM 0 85275 12X1
Código: Fábrica: Unidade:
45452 CONDOR PT/12
F1 F4

UN: R\$ 2,48 AV: R\$ 29,72 15: R\$ 30,34
30: R\$ 30,95 45: R\$ 31,57 60: R\$ 32,20



PINCEL ESC RED CURTO VERM 2 85276 12X1
Código: Fábrica: Unidade:
45453 CONDOR PT/12
F1 F4

UN: R\$ 2,56 AV: R\$ 30,73 15: R\$ 31,37
30: R\$ 32,00 45: R\$ 32,64 60: R\$ 33,29



PINCEL ESC RED CURTO VERM 4 85277 12X1
Código: Fábrica: Unidade:
45454 CONDOR PT/12
F1 F4

UN: R\$ 2,63 AV: R\$ 31,60 15: R\$ 32,26
30: R\$ 32,90 45: R\$ 33,56 60: R\$ 34,23



PINCEL ESC RED CURTO VERM 6 85278 12X1
Código: Fábrica: Unidade:
45455 CONDOR PT/12
F1 F4

UN: R\$ 2,94 AV: R\$ 35,28 15: R\$ 36,02
30: R\$ 36,74 45: R\$ 37,47 60: R\$ 38,22



PINCEL ESC RED CURTO VERM 8 85279 12X1
Código: Fábrica: Unidade:
45456 CONDOR PT/12
F1 F4

UN: R\$ 2,37 AV: R\$ 28,42 15: R\$ 29,02
30: R\$ 29,60 45: R\$ 30,19 60: R\$ 30,79



PINCEL ESC RED CURTO VERM 10 85280 12X1
Código: Fábrica: Unidade:
45457 CONDOR PT/12
F1 F4

UN: R\$ 3,53 AV: R\$ 42,38 15: R\$ 43,27
30: R\$ 44,13 45: R\$ 45,01 60: R\$ 45,91



PINCEL ESC RED CURTO VERM 12 85281 12X1
Código: Fábrica: Unidade:
45458 CONDOR PT/12
F1 F4

UN: R\$ 3,98 AV: R\$ 47,76 15: R\$ 48,76
30: R\$ 49,73 45: R\$ 50,73 60: R\$ 51,74



PINCEL ESC RED CURTO VERM 14 85282 12X1
Código: Fábrica: Unidade:
45459 CONDOR PT/12
F1 F4

UN: R\$ 4,67 AV: R\$ 56,01 15: R\$ 57,18
30: R\$ 58,32 45: R\$ 59,49 60: R\$ 60,68



PINCEL ESC RED CURTO VERM 16 85283 12X1
Código: Fábrica: Unidade:
45460 CONDOR PT/12
F1 F4

UN: R\$ 5,78 AV: R\$ 69,39 15: R\$ 70,83
30: R\$ 72,25 45: R\$ 73,70 60: R\$ 75,17



PINCEL ESC RED CURTO VERM 18 85284 12X1
Código: Fábrica: Unidade:
45461 CONDOR PT/12
F1 F4

UN: R\$ 6,09 AV: R\$ 73,03 15: R\$ 74,55
30: R\$ 76,05 45: R\$ 77,57 60: R\$ 79,12



PINCEL ESC RED CURTO VERM 20 85285 12X1
Código: Fábrica: Unidade:
45462 CONDOR PT/12
F1 F4

UN: R\$ 8,18 AV: R\$ 98,12 15: R\$ 100,17
30: R\$ 102,17 45: R\$ 104,21 60: R\$ 106,30



PINCEL ESC RED CURTO VERM 22 85286 12X1
Código: Fábrica: Unidade:
45463 CONDOR PT/12
F1 F4

UN: R\$ 8,56 AV: R\$ 102,75 15: R\$ 104,89
30: R\$ 106,98 45: R\$ 109,12 60: R\$ 111,31



PINCEL ESC RED CURTO VERM 24 85287 12X1
Código: Fábrica: Unidade:
45464 CONDOR PT/12
F1 F4

UN: R\$ 1,87 AV: R\$ 22,46 15: R\$ 22,93
30: R\$ 23,39 45: R\$ 23,86 60: R\$ 24,34



PINCEL ESC RED LONGO AMAR 14 4969 12X1
Código: Fábrica: Unidade:
41711 LEO&LEO CR/12
F1 F4

UN: R\$ 3,99 AV: R\$ 47,92 15: R\$ 48,92
30: R\$ 49,90 45: R\$ 50,90 60: R\$ 51,92



PINCEL ESC RED MARROM 22 7188 12X1
Código: Fábrica: Unidade:
33838 GOLLER CR/12
F1 F4

UN: R\$ 4,33 AV: R\$ 51,92 15: R\$ 53,00
30: R\$ 54,06 45: R\$ 55,14 60: R\$ 56,24



PINCEL ESC RED MARROM 24 7189 12X1
Código: Fábrica: Unidade:
33839 GOLLER CR/12
F1 F4

UN: R\$ 5,74 AV: R\$ 68,88 15: R\$ 70,31
30: R\$ 71,72 45: R\$ 73,16 60: R\$ 74,62



PINCEL MARC PERM AZUL 3210 12X1
Código: Fábrica: Unidade:
48567 NEWPEN DZ/12
F1 F4

UN: R\$ 5,74 AV: R\$ 68,88 15: R\$ 70,31
30: R\$ 71,72 45: R\$ 73,16 60: R\$ 74,62



PINCEL MARC PERM MARROM 3217 12X1
Código: Fábrica: Unidade:
48571 NEWPEN DZ/12
F1 F4

UN: R\$ 5,74 AV: R\$ 68,88 15: R\$ 70,31
30: R\$ 71,72 45: R\$ 73,16 60: R\$ 74,62



PINCEL MARC PERM PRETO 3211 12X1
Código: Fábrica: Unidade:
48568 NEWPEN DZ/12
F1 F4

UN: R\$ 2,59 AV: R\$ 31,10 15: R\$ 31,75
30: R\$ 32,38 45: R\$ 33,03 60: R\$ 33,69



PINCEL MARC PERM REC AZUL 96070 12X1
Código: Fábrika: Unidade:
48184 JOCAROFFICE DZ/12
F1 F4

UN: R\$ 2,59 AV: R\$ 31,10 15: R\$ 31,75
30: R\$ 32,38 45: R\$ 33,03 60: R\$ 33,69



PINCEL MARC PERM REC PRETO 96071 12X1
Código: Fábrika: Unidade:
48185 JOCAROFFICE DZ/12
F1 F4

UN: R\$ 2,59 AV: R\$ 31,10 15: R\$ 31,75
30: R\$ 32,38 45: R\$ 33,03 60: R\$ 33,69



PINCEL MARC PERM REC VERMELHO 96072 12X1
Código: Fábrika: Unidade:
48186 JOCAROFFICE DZ/12
F1 F4

UN: R\$ 2,46 AV: R\$ 29,48 15: R\$ 30,10
30: R\$ 30,70 45: R\$ 31,31 60: R\$ 31,94



PINCEL MARC PERM TOP VERMELHO 4687 12X1
Código: Fábrika: Unidade:
48195 JOCAROFFICE DZ/12
F1 F4

UN: R\$ 5,74 AV: R\$ 68,88 15: R\$ 70,31
30: R\$ 71,72 45: R\$ 73,16 60: R\$ 74,62



PINCEL MARC PERM VERDE 3213 12X1
Código: Fábrika: Unidade:
48570 NEWPEN DZ/12
F1 F4

UN: R\$ 5,74 AV: R\$ 68,88 15: R\$ 70,31
30: R\$ 71,72 45: R\$ 73,16 60: R\$ 74,62



PINCEL MARC PERM VERMELHO 3212 12X1
Código: Fábrika: Unidade:
48569 NEWPEN DZ/12
F1 F4

UN: R\$ 5,74 AV: R\$ 68,88 15: R\$ 70,31
30: R\$ 71,72 45: R\$ 73,16 60: R\$ 74,62



PINCEL MARC PERM VIOLETA 3218 12X1
Código: Fábrika: Unidade:
48572 NEWPEN DZ/12
F1 F4

UN: R\$ 1,95 AV: R\$ 1,95 15: R\$ 1,99
30: R\$ 2,03 45: R\$ 2,07 60: R\$ 2,11



PINCEL P/PINTURA N00 UN
Código: Fábrika: Unidade:
41943 GOLLER UN/1
F1 F4

UN: R\$ 5,14 AV: R\$ 5,14 15: R\$ 5,25
30: R\$ 5,35 45: R\$ 5,46 60: R\$ 5,57



PINCEL P/PINTURA 1 1/2" 38MM 721
Código: Fábrika: Unidade:
48686 PLANETA UN/1
F1 F4

UN: R\$ 2,71 AV: R\$ 2,71 15: R\$ 2,76
30: R\$ 2,82 45: R\$ 2,87 60: R\$ 2,93



PINCEL P/PINTURA 1/2" 13MM 718
Código: Fábrika: Unidade:
48683 PLANETA UN/1
F1 F4

UN: R\$ 8,64 AV: R\$ 8,64 15: R\$ 8,82
30: R\$ 8,99 45: R\$ 9,17 60: R\$ 9,36



PINCEL P/PINTURA 2 1/2" 63MM 723
Código: Fábrika: Unidade:
48687 PLANETA UN/1
F1 F4

UN: R\$ 3,34 AV: R\$ 3,34 15: R\$ 3,41
30: R\$ 3,48 45: R\$ 3,55 60: R\$ 3,62



PINCEL P/PINTURA 3/4" 19MM 719
Código: Fábrika: Unidade:
48684 PLANETA UN/1
F1 F4

UN: R\$ 119,80 AV: R\$ 119,80 15: R\$ 122,29
30: R\$ 124,74 45: R\$ 127,23 60: R\$ 129,78



PIROGRAFO 5 PONTAS
Código: Fábrika: Unidade:
47339 WESTERN UN/1
F1 F4

UN: R\$ 19,96 AV: R\$ 19,96 15: R\$ 20,37
30: R\$ 20,78 45: R\$ 21,20 60: R\$ 21,62



PISTOLA COLA QUENTE BIV 20W PEQ 1001
Código: Fábrika: Unidade:
23761 HAIBRASI/FUT UN/1
F1 F4

UN: R\$ 49,91 AV: R\$ 49,91 15: R\$ 50,95
30: R\$ 51,97 45: R\$ 53,01 60: R\$ 54,07



PISTOLA COLA QUENTE BIV 10W PQ BOTAO OFF
Código: Fábrika: Unidade:
42458 GATTE UN/1
F1 F4

UN: R\$ 44,92 AV: R\$ 44,92 15: R\$ 45,85
30: R\$ 46,77 45: R\$ 47,71 60: R\$ 48,66



PISTOLA COLA QUENTE BIV 100W G BOTAO OFF
Código: Fábrika: Unidade:
50223 FUTURO UN/1
F1 F4

UN: R\$ 27,22 AV: R\$ 27,22 15: R\$ 27,78
30: R\$ 28,34 45: R\$ 28,91 60: R\$ 29,48



PISTOLA COLA QUENTE BIV 20W P BOTAO OFF

Código: Fábrica: Unidade:
50224 FUTURO UN/1
F1 F4

UN: R\$ 49,31 AV: R\$ 49,31 15: R\$ 50,34
30: R\$ 51,35 45: R\$ 52,37 60: R\$ 53,42



PISTOLA COLA QUENTE BIV 40W GD BOTAO OFF

Código: Fábrica: Unidade:
46430 KAZ UN/1
F1 F4

UN: R\$ 25,95 AV: R\$ 25,95 15: R\$ 26,49
30: R\$ 27,02 45: R\$ 27,56 60: R\$ 28,11



PISTOLA COLA QUENTE BIV 40W GDE 103

Código: Fábrica: Unidade:
18998 WIN/FU/ET/AL UN/1
F1 F4

UN: R\$ 1,30 AV: R\$ 12,96 15: R\$ 13,23
30: R\$ 13,49 45: R\$ 13,76 60: R\$ 14,04

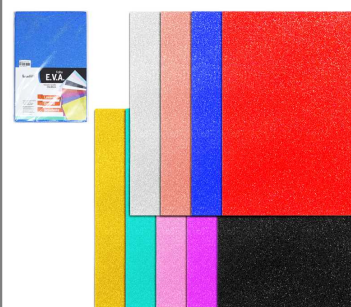

PLACA EVA A4 20X30CM GLITER CORES 10X1

Código: Fábrica: Unidade:
46444 ITERPONTE PT/10
F1 F4

UN: R\$ 2,30 AV: R\$ 22,95 15: R\$ 23,43
30: R\$ 23,90 45: R\$ 24,38 60: R\$ 24,87

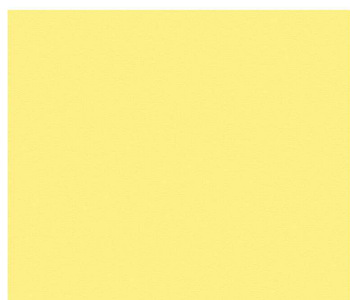

PLACA EVA 39X59CM ECON AMARELO 10X1

Código: Fábrica: Unidade:
48394 IBEL PT/10
F1 F4

UN: R\$ 2,30 AV: R\$ 22,95 15: R\$ 23,43
30: R\$ 23,90 45: R\$ 24,38 60: R\$ 24,87

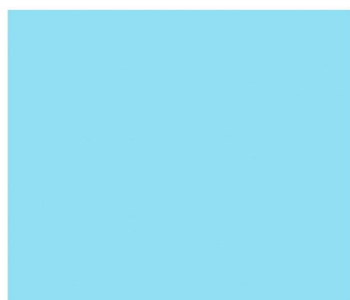

PLACA EVA 39X59CM ECON AZUL BB 10X1

Código: Fábrica: Unidade:
44175 IBEL PT/10
F1 F4

UN: R\$ 2,30 AV: R\$ 22,95 15: R\$ 23,43
30: R\$ 23,90 45: R\$ 24,38 60: R\$ 24,87

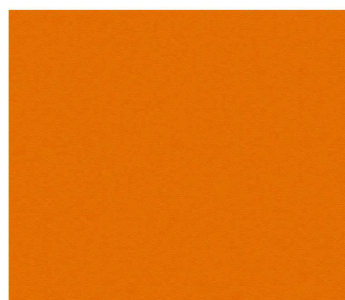

PLACA EVA 39X59CM ECON CENOURA 10X1

Código: Fábrica: Unidade:
44171 IBEL PT/10
F1 F4

UN: R\$ 2,30 AV: R\$ 22,95 15: R\$ 23,43
30: R\$ 23,90 45: R\$ 24,38 60: R\$ 24,87

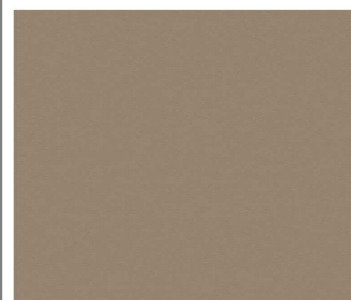

PLACA EVA 39X59CM ECON MARROM 10X1

Código: Fábrica: Unidade:
12579 IBEL PT/10
F1 F4

UN: R\$ 2,30 AV: R\$ 22,95 15: R\$ 23,43
30: R\$ 23,90 45: R\$ 24,38 60: R\$ 24,87

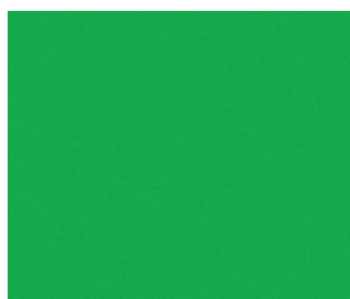

PLACA EVA 39X59CM ECON VERDE GRAMA 10X1

Código: Fábrica: Unidade:
44178 IBEL PT/10
F1 F4

UN: R\$ 1,50 AV: R\$ 14,97 15: R\$ 15,28
30: R\$ 15,58 45: R\$ 15,90 60: R\$ 16,21

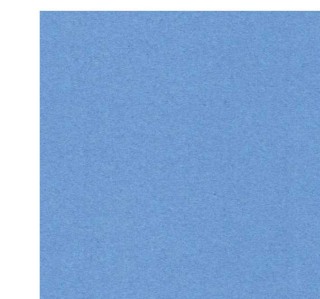

PLACA EVA 40X40CM AZUL BEBE 10X1

Código: Fábrica: Unidade:
39990 DUBFLEX PT/10
F1 F4

UN: R\$ 1,50 AV: R\$ 14,97 15: R\$ 15,28
30: R\$ 15,58 45: R\$ 15,90 60: R\$ 16,21

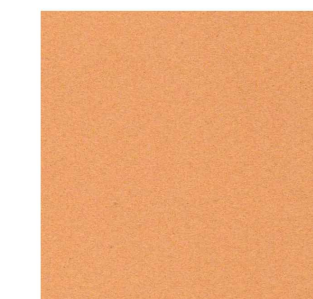

PLACA EVA 40X40CM BEGE 10X1

Código: Fábrica: Unidade:
39991 DUBFLEX PT/10
F1 F4

UN: R\$ 1,50 AV: R\$ 14,97 15: R\$ 15,28
30: R\$ 15,58 45: R\$ 15,90 60: R\$ 16,21

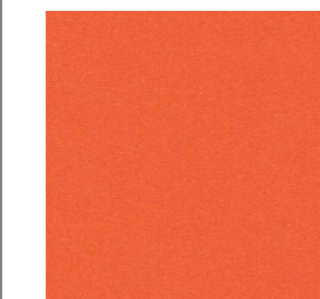

PLACA EVA 40X40CM LARANJA 10X1

Código: Fábrica: Unidade:
39992 DUBFLEX PT/10
F1 F4

UN: R\$ 1,50 AV: R\$ 14,97 15: R\$ 15,28
30: R\$ 15,58 45: R\$ 15,90 60: R\$ 16,21

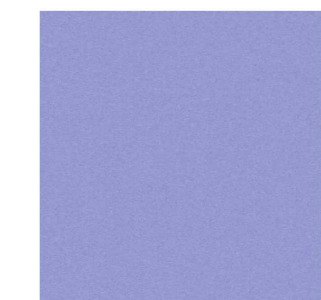

PLACA EVA 40X40CM LILAS 10X1

Código: Fábrica: Unidade:
39993 DUBFLEX PT/10
F1 F4

UN: R\$ 1,50 AV: R\$ 14,97 15: R\$ 15,28
30: R\$ 15,58 45: R\$ 15,90 60: R\$ 16,21

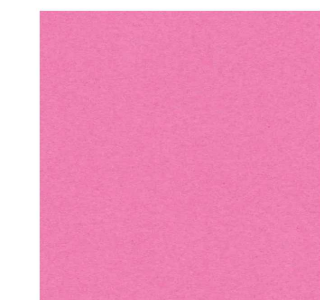

PLACA EVA 40X40CM ROSA PINK 10X1

Código: Fábrica: Unidade:
39996 DUBFLEX PT/10
F1 F4

UN: R\$ 1,50 AV: R\$ 14,97 15: R\$ 15,28
30: R\$ 15,58 45: R\$ 15,90 60: R\$ 16,21

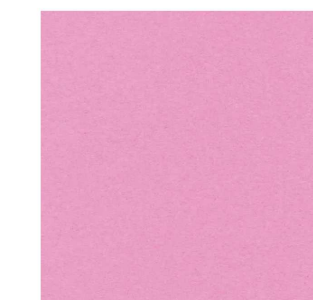

PLACA EVA 40X40CM ROSA 10X1

Código: Fábrica: Unidade:
39995 DUBFLEX PT/10
F1 F4

UN: R\$ 1,50 AV: R\$ 14,97 15: R\$ 15,28
30: R\$ 15,58 45: R\$ 15,90 60: R\$ 16,21

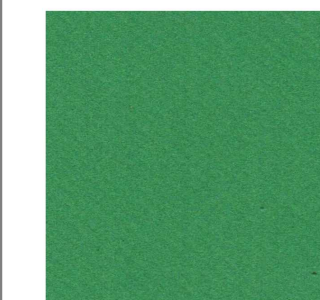

PLACA EVA 40X40CM VERDE BANDEIRA 10X1

Código: Fábrica: Unidade:
39997 DUBFLEX PT/10
F1 F4

UN: R\$ 1,50 AV: R\$ 14,97 15: R\$ 15,28
30: R\$ 15,58 45: R\$ 15,90 60: R\$ 16,21



PLACA EVA 40X40CM VERDE CLARO 10X1

Código: 39998 Fábrica: DUBFLEX Unidade: PT/10 F1 F4

UN: R\$ 1,99 AV: R\$ 19,91 15: R\$ 20,32
30: R\$ 20,73 45: R\$ 21,14 60: R\$ 21,57

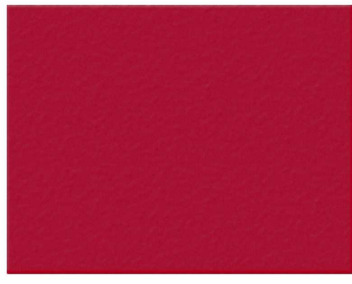

PLACA EVA 40X45CM BORDO 10X1

Código: 44323 Fábrica: RABER Unidade: PT/10 F1 F4

UN: R\$ 1,99 AV: R\$ 19,91 15: R\$ 20,32
30: R\$ 20,73 45: R\$ 21,14 60: R\$ 21,57



PLACA EVA 40X47CM AMARELO ESC 011 10X1

Código: 7113 Fábrica: DUB FLEX Unidade: PT/10 F1 F4

UN: R\$ 1,99 AV: R\$ 19,91 15: R\$ 20,32
30: R\$ 20,73 45: R\$ 21,14 60: R\$ 21,57



PLACA EVA 40X47CM AZUL ROYAL 10X1

Código: 49141 Fábrica: EVAMAX Unidade: PT/10 F1 F4

UN: R\$ 1,99 AV: R\$ 19,91 15: R\$ 20,32
30: R\$ 20,73 45: R\$ 21,14 60: R\$ 21,57



PLACA EVA 40X47CM AZUL ROYAL 10X1

Código: 22359 Fábrica: DUB FLEX Unidade: PT/10 F1 F4

UN: R\$ 1,99 AV: R\$ 19,91 15: R\$ 20,32
30: R\$ 20,73 45: R\$ 21,14 60: R\$ 21,57

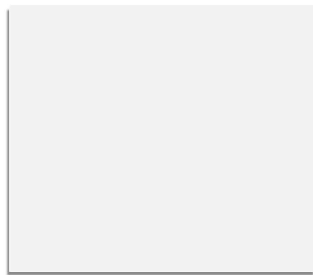

PLACA EVA 40X47CM BRANCO 10X1

Código: 4261 Fábrica: SANTA FE/IBEL Unidade: PT/10 F1 F4

UN: R\$ 1,99 AV: R\$ 19,91 15: R\$ 20,32
30: R\$ 20,73 45: R\$ 21,14 60: R\$ 21,57



PLACA EVA 40X47CM VERDE AGUA 10X1

Código: 18972 Fábrica: MW PLUS/BRW Unidade: PT/10 F1 F4

UN: R\$ 1,99 AV: R\$ 19,91 15: R\$ 20,32
30: R\$ 20,73 45: R\$ 21,14 60: R\$ 21,57



PLACA EVA 40X47CM VERDE CLARO 015 10X1

Código: 18966 Fábrica: IB/W Unidade: PT/10 F1 F4

UN: R\$ 1,99 AV: R\$ 19,91 15: R\$ 20,32
30: R\$ 20,73 45: R\$ 21,14 60: R\$ 21,57



PLACA EVA 40X47CM VERMELHO 10X1

Código: 50854 Fábrica: DUB FLEX Unidade: PT/10 F1 F4

UN: R\$ 1,99 AV: R\$ 19,91 15: R\$ 20,32
30: R\$ 20,73 45: R\$ 21,14 60: R\$ 21,57



PLACA EVA 40X48CM AMARELO 10X1

Código: 39777 Fábrica: SANTA FE Unidade: PT/10 F1 F4

UN: R\$ 6,99 AV: R\$ 34,93 15: R\$ 35,66
30: R\$ 36,38 45: R\$ 37,10 60: R\$ 37,84



PLACA EVA 40X48CM ATOALH AMARELO ESC 5X1

Código: 33717 Fábrica: DUBFLEX Unidade: PT/5 F1 F4

UN: R\$ 6,99 AV: R\$ 34,93 15: R\$ 35,66
30: R\$ 36,38 45: R\$ 37,10 60: R\$ 37,84



PLACA EVA 40X48CM ATOALH AZUL BB 5X1

Código: 33718 Fábrica: DUBFLEX Unidade: PT/5 F1 F4

UN: R\$ 1,99 AV: R\$ 19,91 15: R\$ 20,32
30: R\$ 20,73 45: R\$ 21,14 60: R\$ 21,57

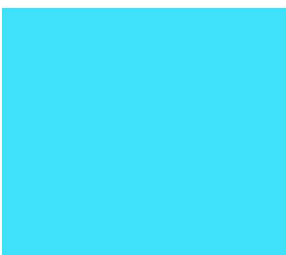

PLACA EVA 40X48CM AZUL CLARO 10X1

Código: 18954 Fábrica: BRW Unidade: PT/10 F1 F4

UN: R\$ 1,99 AV: R\$ 19,91 15: R\$ 20,32
30: R\$ 20,73 45: R\$ 21,14 60: R\$ 21,57

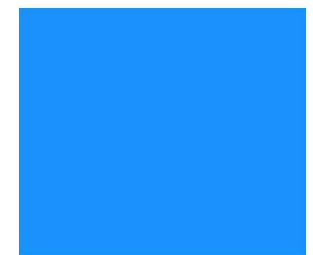

PLACA EVA 40X48CM AZUL ROYAL 10X1

Código: 21650 Fábrica: BRW Unidade: PT/10 F1 F4

UN: R\$ 1,99 AV: R\$ 19,91 15: R\$ 20,32
30: R\$ 20,73 45: R\$ 21,14 60: R\$ 21,57

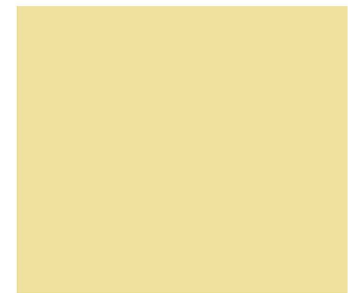

PLACA EVA 40X48CM BEGE 10X1

Código: 18970 Fábrica: BRW Unidade: PT/10 F1 F4

UN: R\$ 4,29 AV: R\$ 42,92 15: R\$ 43,82
30: R\$ 44,69 45: R\$ 45,59 60: R\$ 46,50



PLACA EVA 40X48CM GLITER AZUL CLARO 10X1

Código: 22354 Fábrica: YIN'S/IBEL Unidade: PT/10 F1 F4

UN: R\$ 4,29 AV: R\$ 42,92 15: R\$ 43,82
30: R\$ 44,69 45: R\$ 45,59 60: R\$ 46,50

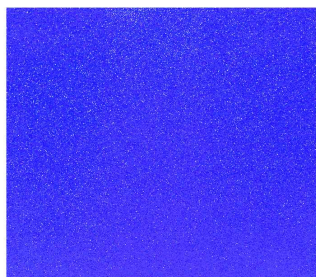

PLACA EVA 40X48CM GLITER AZUL ESC 10X1
Código: 45139 Fábrica: YIN'S PAPER Unidade: PT/10 F1 F4

UN: R\$ 4,29 AV: R\$ 42,92 15: R\$ 43,82
30: R\$ 44,69 45: R\$ 45,59 60: R\$ 46,50

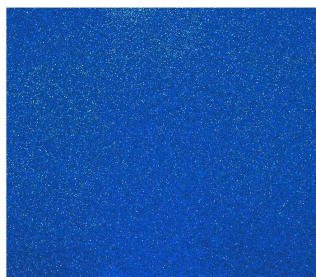

PLACA EVA 40X48CM GLITER AZUL PETRO 10X1
Código: 45428 Fábrica: IBEL Unidade: PT/10 F1 F4

UN: R\$ 4,29 AV: R\$ 42,92 15: R\$ 43,82
30: R\$ 44,69 45: R\$ 45,59 60: R\$ 46,50

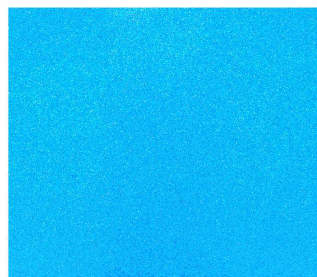

PLACA EVA 40X48CM GLITER AZUL 10X1
Código: 48151 Fábrica: YIN'S PAPER Unidade: PT/10 F1 F4

UN: R\$ 4,29 AV: R\$ 42,92 15: R\$ 43,82
30: R\$ 44,69 45: R\$ 45,59 60: R\$ 46,50

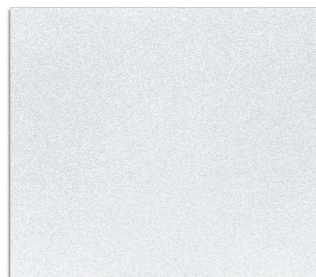

PLACA EVA 40X48CM GLITER BRANCO 10X1
Código: 28908 Fábrica: YIN'S/IBEL Unidade: PT/10 F1 F4

UN: R\$ 4,29 AV: R\$ 42,92 15: R\$ 43,82
30: R\$ 44,69 45: R\$ 45,59 60: R\$ 46,50



PLACA EVA 40X48CM GLITER BRONZE 10X1
Código: 46958 Fábrica: YIN'S PAPER Unidade: PT/10 F1 F4

UN: R\$ 4,29 AV: R\$ 42,92 15: R\$ 43,82
30: R\$ 44,69 45: R\$ 45,59 60: R\$ 46,50



PLACA EVA 40X48CM GLITER ESP AZUL 10X1
Código: 44163 Fábrica: YIN'S/IBEL Unidade: PT/10 F1 F4

UN: R\$ 4,29 AV: R\$ 42,92 15: R\$ 43,82
30: R\$ 44,69 45: R\$ 45,59 60: R\$ 46,50



PLACA EVA 40X48CM GLITER ESP MARROM 10X1
Código: 45430 Fábrica: IBEL Unidade: PT/10 F1 F4

UN: R\$ 4,29 AV: R\$ 42,92 15: R\$ 43,82
30: R\$ 44,69 45: R\$ 45,59 60: R\$ 46,50

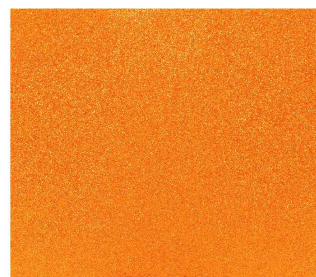

PLACA EVA 40X48CM GLITER LARANJA 10X1
Código: 22355 Fábrica: YIN'S PAPER Unidade: PT/10 F1 F4

UN: R\$ 4,29 AV: R\$ 42,92 15: R\$ 43,82
30: R\$ 44,69 45: R\$ 45,59 60: R\$ 46,50

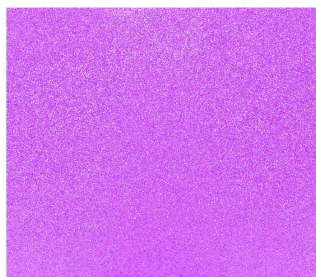

PLACA EVA 40X48CM GLITER LILAS 10X1
Código: 32382 Fábrica: YIN'S PAPER Unidade: PT/10 F1 F4

UN: R\$ 4,29 AV: R\$ 42,92 15: R\$ 43,82
30: R\$ 44,69 45: R\$ 45,59 60: R\$ 46,50

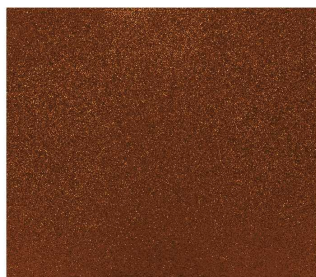

PLACA EVA 40X48CM GLITER MARROM 10X1
Código: 28909 Fábrica: YIN'S PAPER Unidade: PT/10 F1 F4

UN: R\$ 4,42 AV: R\$ 44,21 15: R\$ 45,13
30: R\$ 46,03 45: R\$ 46,95 60: R\$ 47,89

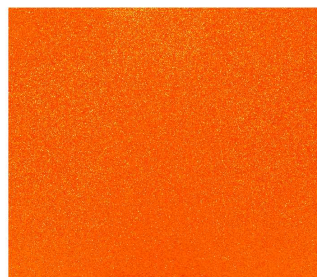

PLACA EVA 40X48CM GLITER NEON LARAN 10X1
Código: 46961 Fábrica: YIN'S PAPER Unidade: PT/10 F1 F4

UN: R\$ 4,29 AV: R\$ 42,92 15: R\$ 43,82
30: R\$ 44,69 45: R\$ 45,59 60: R\$ 46,50

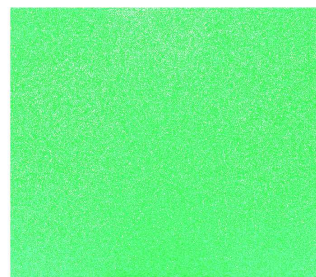

PLACA EVA 40X48CM GLITER NEON VERDE 10X1
Código: 46959 Fábrica: YIN'S PAPER Unidade: PT/10 F1 F4

UN: R\$ 4,29 AV: R\$ 42,92 15: R\$ 43,82
30: R\$ 44,69 45: R\$ 45,59 60: R\$ 46,50



PLACA EVA 40X48CM GLITER OURO 10X1
Código: 46240 Fábrica: IBEL Unidade: PT/10 F1 F4

UN: R\$ 4,59 AV: R\$ 22,95 15: R\$ 23,43
30: R\$ 23,90 45: R\$ 24,38 60: R\$ 24,87



PLACA EVA 40X48CM GLITER OURO 5X1
Código: 50318 Fábrica: SANTA FE Unidade: PT/5 F1 F4

UN: R\$ 4,29 AV: R\$ 42,92 15: R\$ 43,82
30: R\$ 44,69 45: R\$ 45,59 60: R\$ 46,50

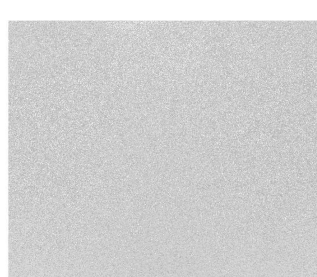

PLACA EVA 40X48CM GLITER PRATA 10X1
Código: 32381 Fábrica: YIN'S/IBEL Unidade: PT/10 F1 F4

UN: R\$ 4,29 AV: R\$ 42,92 15: R\$ 43,82
30: R\$ 44,69 45: R\$ 45,59 60: R\$ 46,50



PLACA EVA 40X48CM GLITER PRETO 10X1
Código: 28913 Fábrica: IBEL Unidade: PT/10 F1 F4

UN: R\$ 4,59 AV: R\$ 22,95 15: R\$ 23,43
30: R\$ 23,90 45: R\$ 24,38 60: R\$ 24,87



PLACA EVA 40X48CM GLITER PRETO 5X1
Código: 50319 Fábrica: SANTA FE Unidade: PT/5 F1 F4

UN: R\$ 4,29 AV: R\$ 42,92 15: R\$ 43,82
30: R\$ 44,69 45: R\$ 45,59 60: R\$ 46,50



PLACA EVA 40X48CM GLITER ROSA CLARO 10X1
Código: 22357 Fábrica: YIN'S PAPER Unidade: PT/10 F1 F4

UN: R\$ 4,29 AV: R\$ 42,92 15: R\$ 43,82
30: R\$ 44,69 45: R\$ 45,59 60: R\$ 46,50



PLACA EVA 40X48CM GLITER ROSA PINK 10X1
Código: 46957 Fábrica: YIN'S PAPER Unidade: PT/10 F1 F4

UN: R\$ 4,29 AV: R\$ 42,92 15: R\$ 43,82
30: R\$ 44,69 45: R\$ 45,59 60: R\$ 46,50

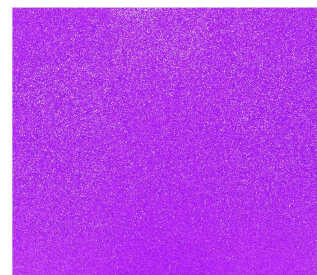

PLACA EVA 40X48CM GLITER ROXO 10X1
Código: 32380 Fábrica: YIN'S PAPER Unidade: PT/10 F1 F4

UN: R\$ 4,29 AV: R\$ 42,92 15: R\$ 43,82
30: R\$ 44,69 45: R\$ 45,59 60: R\$ 46,50

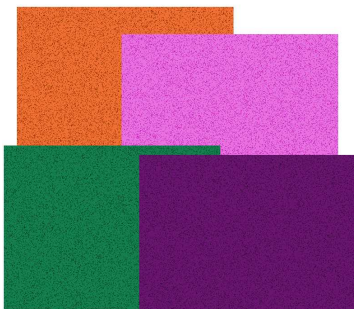

PLACA EVA 40X48CM GLITER SORT 10X1
Código: 35987 Fábrica: MAKE Unidade: PT/10 F1 F4

UN: R\$ 4,29 AV: R\$ 42,92 15: R\$ 43,82
30: R\$ 44,69 45: R\$ 45,59 60: R\$ 46,50

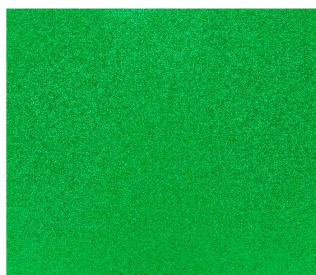

PLACA EVA 40X48CM GLITER VERDE BAND 10X1
Código: 32379 Fábrica: YIN'S/IBEL Unidade: PT/10 F1 F4

UN: R\$ 4,29 AV: R\$ 42,92 15: R\$ 43,82
30: R\$ 44,69 45: R\$ 45,59 60: R\$ 46,50

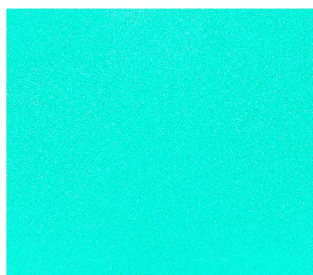

PLACA EVA 40X48CM GLITER VERDE CLAR 10X1
Código: 45138 Fábrica: YIN'S PAPER Unidade: PT/10 F1 F4

UN: R\$ 4,29 AV: R\$ 42,92 15: R\$ 43,82
30: R\$ 44,69 45: R\$ 45,59 60: R\$ 46,50



PLACA EVA 40X48CM GLITER VERMELHO 10X1
Código: 7119 Fábrica: IBEL Unidade: PT/10 F1 F4

UN: R\$ 4,59 AV: R\$ 22,95 15: R\$ 23,43
30: R\$ 23,90 45: R\$ 24,38 60: R\$ 24,87

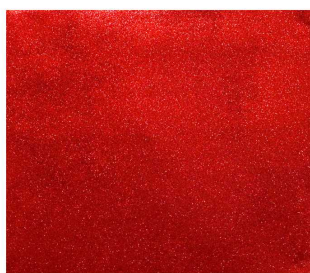

PLACA EVA 40X48CM GLITER VERMELHO 5X1
Código: 49137 Fábrica: SANTA FE Unidade: PT/5 F1 F4

UN: R\$ 4,29 AV: R\$ 42,92 15: R\$ 43,82
30: R\$ 44,69 45: R\$ 45,59 60: R\$ 46,50

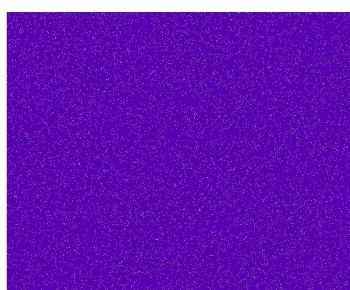

PLACA EVA 40X48CM GLITER VIOLETA 10X1
Código: 37348 Fábrica: DUB FLEX Unidade: PT/10 F1 F4

UN: R\$ 1,99 AV: R\$ 19,91 15: R\$ 20,32
30: R\$ 20,73 45: R\$ 21,14 60: R\$ 21,57

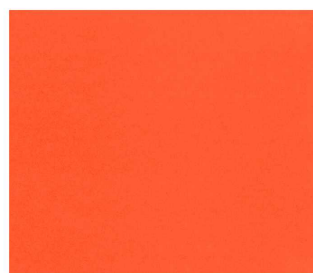

PLACA EVA 40X48CM LARANJA 10X1
Código: 18959 Fábrica: SANTA FE/LEO Unidade: PT/10 F1 F4

UN: R\$ 1,99 AV: R\$ 19,91 15: R\$ 20,32
30: R\$ 20,73 45: R\$ 21,14 60: R\$ 21,57

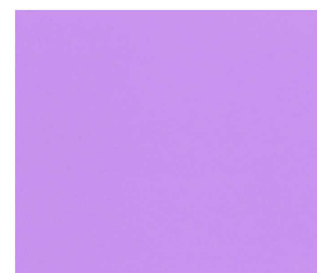

PLACA EVA 40X48CM LILAS 10X1
Código: 18964 Fábrica: SANTA FE Unidade: PT/10 F1 F4

UN: R\$ 6,99 AV: R\$ 69,88 15: R\$ 71,33
30: R\$ 72,76 45: R\$ 74,22 60: R\$ 75,70

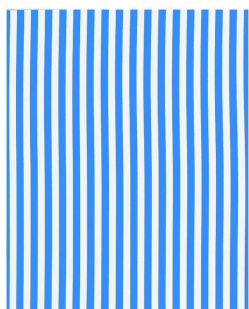

PLACA EVA 40X48CM LISTR AZUL BRANCO 10X1
Código: 48313 Fábrica: BRW Unidade: PT/10 F1 F4

UN: R\$ 6,99 AV: R\$ 69,88 15: R\$ 71,33
30: R\$ 72,76 45: R\$ 74,22 60: R\$ 75,70

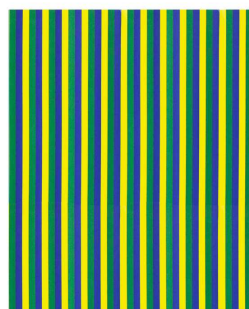

PLACA EVA 40X48CM LISTR BRASIL 10X1
Código: 48314 Fábrica: BRW Unidade: PT/10 F1 F4

UN: R\$ 1,99 AV: R\$ 19,91 15: R\$ 20,32
30: R\$ 20,73 45: R\$ 21,14 60: R\$ 21,57

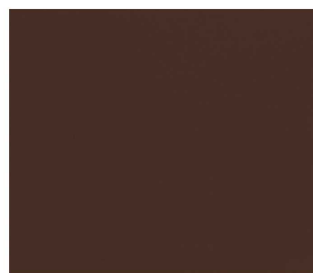

PLACA EVA 40X48CM MARROM 10X1
Código: 18948 Fábrica: SANTA FE Unidade: PT/10 F1 F4

UN: R\$ 1,99 AV: R\$ 19,91 15: R\$ 20,32
30: R\$ 20,73 45: R\$ 21,14 60: R\$ 21,57

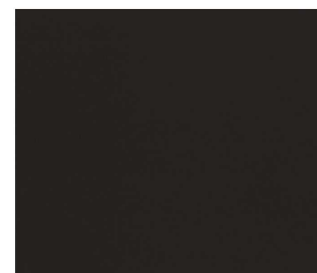

PLACA EVA 40X48CM PRETO 10X1
Código: 48952 Fábrica: SANTAFE/LEOA Unidade: PT/10 F1 F4

UN: R\$ 1,99 AV: R\$ 19,91 15: R\$ 20,32
30: R\$ 20,73 45: R\$ 21,14 60: R\$ 21,57

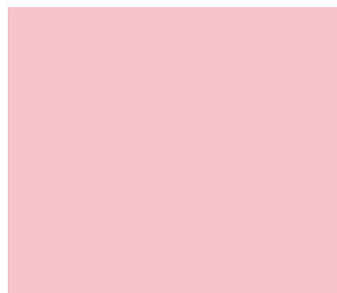

PLACA EVA 40X48CM ROSA CLARO 10X1
Código: 7115 Fábrica: BRW/IBEL Unidade: PT/10 F1 F4

UN: R\$ 1,99 AV: R\$ 19,91 15: R\$ 20,32
30: R\$ 20,73 45: R\$ 21,14 60: R\$ 21,57



PLACA EVA 40X48CM ROSA PINK 10X1
Código: 18961 Fábrica: BRW Unidade: PT/10 F1 F4

UN: R\$ 1,99 AV: R\$ 19,91 15: R\$ 20,32
30: R\$ 20,73 45: R\$ 21,14 60: R\$ 21,57



PLACA EVA 40X48CM ROXO 10X1
Código: 22360 Fábrica: SANTAFE/BRW Unidade: PT/10 F1 F4

UN: R\$ 1,99 AV: R\$ 19,91 15: R\$ 20,32
30: R\$ 20,73 45: R\$ 21,14 60: R\$ 21,57



PLACA EVA 40X48CM SALMAO 10X1
Código: 18957 Fábrica: BRW Unidade: PT/10 F1 F4

UN: R\$ 1,99 AV: R\$ 19,91 15: R\$ 20,32
30: R\$ 20,73 45: R\$ 21,14 60: R\$ 21,57

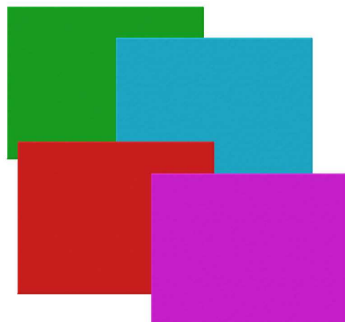

PLACA EVA 40X48CM SORTIDO 10X1
Código: 18973 Fábrica: MAKE Unidade: PT/10 F1 F4

UN: R\$ 1,99 AV: R\$ 19,91 15: R\$ 20,32
30: R\$ 20,73 45: R\$ 21,14 60: R\$ 21,57

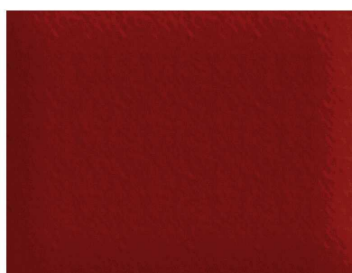

PLACA EVA 40X48CM TERRA 022 10X1
Código: 38016 Fábrica: BRW Unidade: PT/10 F1 F4

UN: R\$ 1,99 AV: R\$ 19,91 15: R\$ 20,32
30: R\$ 20,73 45: R\$ 21,14 60: R\$ 21,57



PLACA EVA 40X48CM VERDE BANDEIRA 10X1
Código: 44164 Fábrica: BRW Unidade: PT/10 F1 F4

UN: R\$ 1,99 AV: R\$ 19,91 15: R\$ 20,32
30: R\$ 20,73 45: R\$ 21,14 60: R\$ 21,57



PLACA EVA 40X48CM VERDE CLARO 10X1
Código: 7117 Fábrica: LEONORA Unidade: PT/10 F1 F4

UN: R\$ 1,99 AV: R\$ 19,91 15: R\$ 20,32
30: R\$ 20,73 45: R\$ 21,14 60: R\$ 21,57



PLACA EVA 40X48CM VERDE FLUORES 017 10X1
Código: 18967 Fábrica: BRW Unidade: PT/10 F1 F4

UN: R\$ 1,99 AV: R\$ 19,91 15: R\$ 20,32
30: R\$ 20,73 45: R\$ 21,14 60: R\$ 21,57

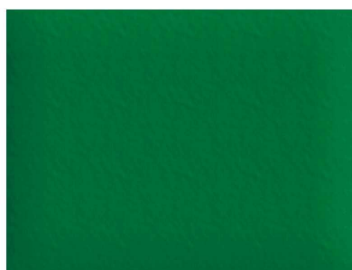

PLACA EVA 40X48CM VERDE FOLHA 016 10X1
Código: 22362 Fábrica: BRW Unidade: PT/10 F1 F4

UN: R\$ 1,99 AV: R\$ 19,91 15: R\$ 20,32
30: R\$ 20,73 45: R\$ 21,14 60: R\$ 21,57

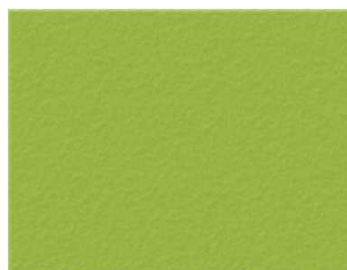

PLACA EVA 40X48CM VERDE MUSGO 019 10X1
Código: 18969 Fábrica: BRW Unidade: PT/10 F1 F4

UN: R\$ 1,99 AV: R\$ 19,91 15: R\$ 20,32
30: R\$ 20,73 45: R\$ 21,14 60: R\$ 21,57



PLACA EVA 40X48CM VERDE PETROLEO 10X1
Código: 48876 Fábrica: IBEL Unidade: PT/10 F1 F4

UN: R\$ 1,99 AV: R\$ 19,91 15: R\$ 20,32
30: R\$ 20,73 45: R\$ 21,14 60: R\$ 21,57

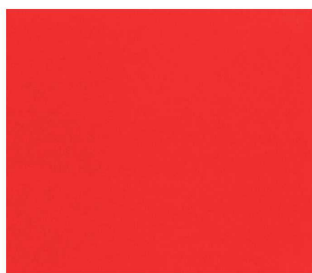

PLACA EVA 40X48CM VERMELHO 10X1
Código: 18962 Fábrica: SANTA FE Unidade: PT/10 F1 F4

UN: R\$ 3,99 AV: R\$ 39,93 15: R\$ 40,76
30: R\$ 41,57 45: R\$ 42,40 60: R\$ 43,25

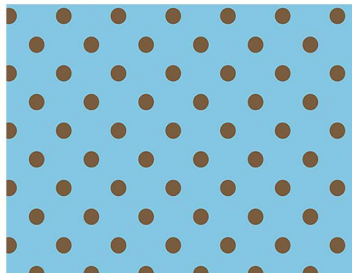

PLACA EVA 40X50CM EST POA AZUL/MARR 10X1
Código: 34139 Fábrica: BRW Unidade: PT/10 F1 F4

UN: R\$ 3,99 AV: R\$ 39,93 15: R\$ 40,76
30: R\$ 41,57 45: R\$ 42,40 60: R\$ 43,25

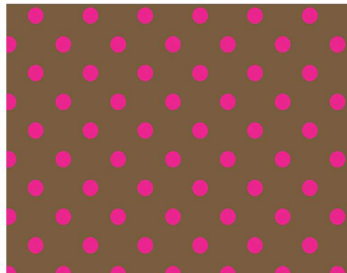

PLACA EVA 40X50CM EST POA MARR/ROSA 10X1
Código: 34136 Fábrica: BRW Unidade: PT/10 F1 F4

UN: R\$ 3,99 AV: R\$ 39,93 15: R\$ 40,76
30: R\$ 41,57 45: R\$ 42,40 60: R\$ 43,25

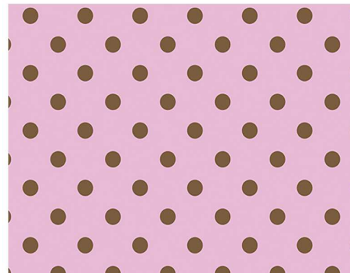

PLACA EVA 40X50CM EST POA ROSA/MARR 10X1
Código: 34135 Fábrica: BRW Unidade: PT/10 F1 F4

UN: R\$ 2,50 AV: R\$ 24,95 15: R\$ 25,47
30: R\$ 25,98 45: R\$ 26,50 60: R\$ 27,03



PLACA EVA 40X60CM AMARELO 10X1

Código: 43707 Fábrica: BRW Unidade: PT/10 F1 F4

UN: R\$ 2,50 AV: R\$ 24,95 15: R\$ 25,47
30: R\$ 25,98 45: R\$ 26,50 60: R\$ 27,03



PLACA EVA 40X60CM AZUL CLARO 4907 10X1

Código: 48721 Fábrica: LEOARTE Unidade: PT/10 F1 F4

UN: R\$ 2,40 AV: R\$ 23,95 15: R\$ 24,45
30: R\$ 24,94 45: R\$ 25,44 60: R\$ 25,95



PLACA EVA 40X60CM AZUL ROYAL 10X1

Código: 49140 Fábrica: EVAMAX Unidade: PT/10 F1 F4

UN: R\$ 2,50 AV: R\$ 24,95 15: R\$ 25,47
30: R\$ 25,98 45: R\$ 26,50 60: R\$ 27,03



PLACA EVA 40X60CM AZUL ROYAL 10X1

Código: 45379 Fábrica: BRW Unidade: PT/10 F1 F4

UN: R\$ 2,50 AV: R\$ 24,95 15: R\$ 25,47
30: R\$ 25,98 45: R\$ 26,50 60: R\$ 27,03

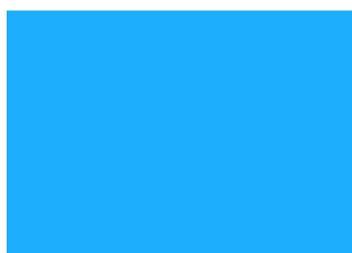

PLACA EVA 40X60CM AZUL 10X1

Código: 43697 Fábrica: BRW Unidade: PT/10 F1 F4

UN: R\$ 2,50 AV: R\$ 24,95 15: R\$ 25,47
30: R\$ 25,98 45: R\$ 26,50 60: R\$ 27,03

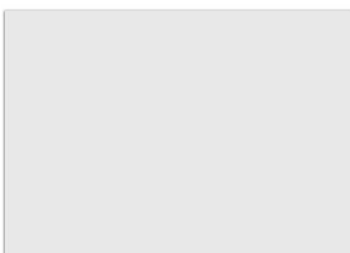

PLACA EVA 40X60CM BRANCO 4906 10X1

Código: 43689 Fábrica: LEOARTE Unidade: PT/10 F1 F4

UN: R\$ 4,99 AV: R\$ 24,95 15: R\$ 25,47
30: R\$ 25,98 45: R\$ 26,50 60: R\$ 27,03



PLACA EVA 40X60CM CIRCULO AZUL 3D 5X1

Código: 38573 Fábrica: MAKE Unidade: PT/5 F4

UN: R\$ 4,99 AV: R\$ 49,91 15: R\$ 50,95
30: R\$ 51,97 45: R\$ 53,01 60: R\$ 54,07



PLACA EVA 40X60CM ESTAMP BOLA 10X1

Código: 43766 Fábrica: WIN PAPER Unidade: PT/10 F1 F4

UN: R\$ 4,99 AV: R\$ 24,95 15: R\$ 25,47
30: R\$ 25,98 45: R\$ 26,50 60: R\$ 27,03



PLACA EVA 40X60CM ESTAMP FLORES ROSA 5X1

Código: 38578 Fábrica: MAKE Unidade: PT/5 F4

UN: R\$ 4,99 AV: R\$ 24,95 15: R\$ 25,47
30: R\$ 25,98 45: R\$ 26,50 60: R\$ 27,03



PLACA EVA 40X60CM ESTAMP FLORES VERM 5X1

Código: 38577 Fábrica: MAKE Unidade: PT/5 F1 F4

UN: R\$ 4,99 AV: R\$ 24,95 15: R\$ 25,47
30: R\$ 25,98 45: R\$ 26,50 60: R\$ 27,03



PLACA EVA 40X60CM ESTAMP FRUTAS 5X1

Código: 38574 Fábrica: MAKE Unidade: PT/5 F1 F4

UN: R\$ 4,99 AV: R\$ 24,95 15: R\$ 25,47
30: R\$ 25,98 45: R\$ 26,50 60: R\$ 27,03



PLACA EVA 40X60CM ESTAMP INF AMARELO 5X1

Código: 38579 Fábrica: MAKE Unidade: PT/5 F4

UN: R\$ 4,99 AV: R\$ 24,95 15: R\$ 25,47
30: R\$ 25,98 45: R\$ 26,50 60: R\$ 27,03



PLACA EVA 40X60CM ESTAMP MESC AZUL 5X1

Código: 38575 Fábrica: MAKE Unidade: PT/5 F1 F4

UN: R\$ 4,99 AV: R\$ 24,95 15: R\$ 25,47
30: R\$ 25,98 45: R\$ 26,50 60: R\$ 27,03



PLACA EVA 40X60CM ESTAMP MESC VERMEL 5X1

Código: 38576 Fábrica: MAKE Unidade: PT/5 F4

UN: R\$ 4,99 AV: R\$ 24,95 15: R\$ 25,47
30: R\$ 25,98 45: R\$ 26,50 60: R\$ 27,03

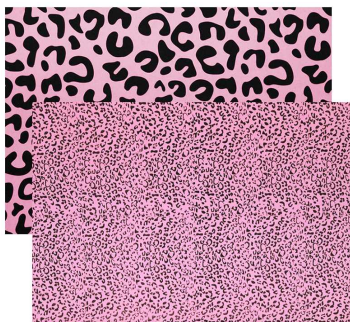

PLACA EVA 40X60CM ESTAMP ONCA ROSA 5X1

Código: 38583 Fábrica: MAKE Unidade: PT/5 F1 F4

UN: R\$ 4,99 AV: R\$ 49,91 15: R\$ 50,95
30: R\$ 51,97 45: R\$ 53,01 60: R\$ 54,07



PLACA EVA 40X60CM ESTAMP ONCA 10X1

Código: 43764 Fábrica: WIN PAPER Unidade: PT/10 F1 F4

UN: R\$ 5,99 AV: R\$ 29,94 15: R\$ 30,57
30: R\$ 31,18 45: R\$ 31,80 60: R\$ 32,44

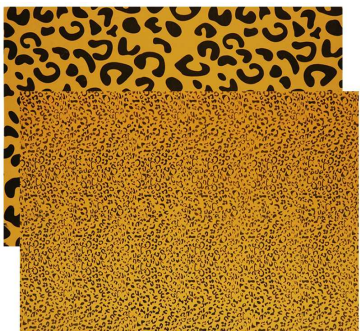

PLACA EVA 40X60CM ESTAMP ONCA 5X1

Código: 38584 Fábrica: MAKE Unidade: PT/5 F4

UN: R\$ 4,99 AV: R\$ 49,91 15: R\$ 50,95
30: R\$ 51,97 45: R\$ 53,01 60: R\$ 54,07

40 cm
60 cm



PLACA EVA 40X60CM ESTAMP POA 10X1

Código: 43769 Fábrica: WIN PAPER Unidade: PT/10 F1 F4

UN: R\$ 4,99 AV: R\$ 24,95 15: R\$ 25,47
30: R\$ 25,98 45: R\$ 26,50 60: R\$ 27,03

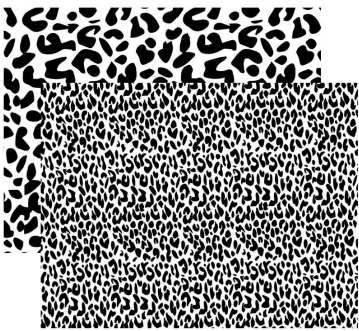

PLACA EVA 40X60CM ESTAMP VAQUINHA 5X1

Código: 38582 Fábrica: MAKE Unidade: PT/5 F4

UN: R\$ 4,99 AV: R\$ 24,95 15: R\$ 25,47
30: R\$ 25,98 45: R\$ 26,50 60: R\$ 27,03

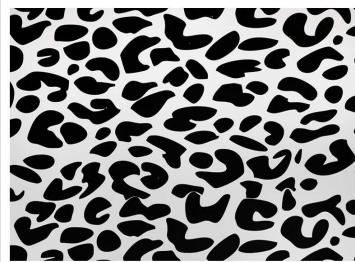

PLACA EVA 40X60CM ESTAMP VAQUINHA 5X1

Código: 38581 Fábrica: MAKE Unidade: PT/5 F4

UN: R\$ 4,99 AV: R\$ 49,91 15: R\$ 50,95
30: R\$ 51,97 45: R\$ 53,01 60: R\$ 54,07

40 cm
60 cm



PLACA EVA 40X60CM ESTAMP ZEBRA 10X1

Código: 43765 Fábrica: WIN PAPER Unidade: PT/10 F1 F4

UN: R\$ 5,99 AV: R\$ 59,89 15: R\$ 61,14
30: R\$ 62,36 45: R\$ 63,61 60: R\$ 64,88

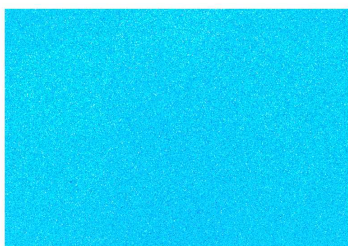

PLACA EVA 40X60CM GLITER AZUL CLARO 10X1

Código: 46239 Fábrica: YIN'S PAPER Unidade: PT/10 F1 F4

UN: R\$ 5,99 AV: R\$ 59,89 15: R\$ 61,14
30: R\$ 62,36 45: R\$ 63,61 60: R\$ 64,88

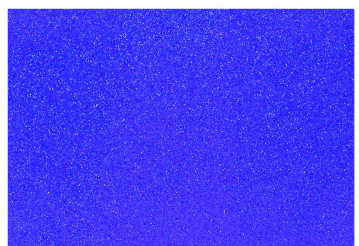

PLACA EVA 40X60CM GLITER AZUL ESCUR 10X1

Código: 46956 Fábrica: YIN'S/IBEL Unidade: PT/10 F1 F4

UN: R\$ 5,99 AV: R\$ 59,89 15: R\$ 61,14
30: R\$ 62,36 45: R\$ 63,61 60: R\$ 64,88



PLACA EVA 40X60CM GLITER AZUL 10X1

Código: 46222 Fábrica: YIN'S/IBEL Unidade: PT/10 F1 F4

UN: R\$ 5,99 AV: R\$ 59,89 15: R\$ 61,14
30: R\$ 62,36 45: R\$ 63,61 60: R\$ 64,88

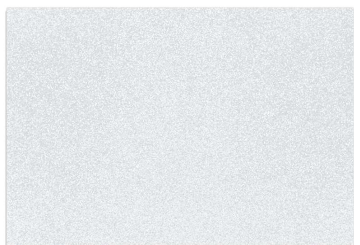

PLACA EVA 40X60CM GLITER BRANCO 10X1

Código: 46221 Fábrica: YIN'S/IBEL Unidade: PT/10 F1 F4

UN: R\$ 5,99 AV: R\$ 59,89 15: R\$ 61,14
30: R\$ 62,36 45: R\$ 63,61 60: R\$ 64,88



PLACA EVA 40X60CM GLITER BRONZE 10X1

Código: 46954 Fábrica: YIN'S PAPER Unidade: PT/10 F1 F4

UN: R\$ 5,99 AV: R\$ 59,89 15: R\$ 61,14
30: R\$ 62,36 45: R\$ 63,61 60: R\$ 64,88



PLACA EVA 40X60CM GLITER ECON AZUL 10X1

Código: 45427 Fábrica: IBEL Unidade: PT/10 F1 F4

UN: R\$ 5,99 AV: R\$ 59,89 15: R\$ 61,14
30: R\$ 62,36 45: R\$ 63,61 60: R\$ 64,88

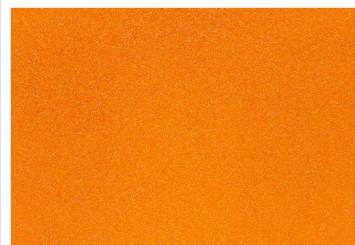

PLACA EVA 40X60CM GLITER ESP COBRE 10X1

Código: 46230 Fábrica: IBEL Unidade: PT/10 F1 F4

UN: R\$ 5,99 AV: R\$ 29,94 15: R\$ 30,57
30: R\$ 31,18 45: R\$ 31,80 60: R\$ 32,44

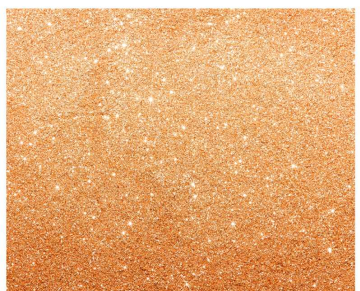

PLACA EVA 40X60CM GLITER LARANJA 5X1

Código: 41839 Fábrica: ONDA Unidade: PT/5 F1 F4

UN: R\$ 5,99 AV: R\$ 59,89 15: R\$ 61,14
30: R\$ 62,36 45: R\$ 63,61 60: R\$ 64,88

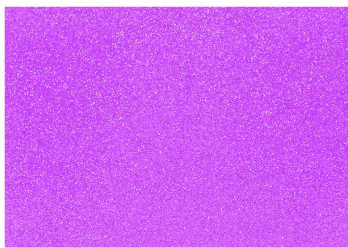

PLACA EVA 40X60CM GLITER LILAS 10X1

Código: 46223 Fábrica: YIN'S/IBEL Unidade: PT/10 F1 F4

UN: R\$ 5,99 AV: R\$ 29,94 15: R\$ 30,57
30: R\$ 31,18 45: R\$ 31,80 60: R\$ 32,44

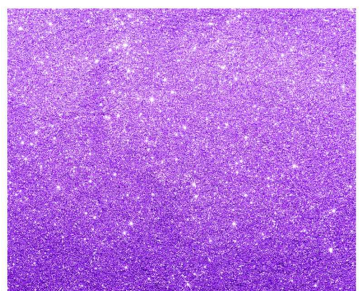

PLACA EVA 40X60CM GLITER LILAS 5X1

Código: 41840 Fábrica: ONDA Unidade: PT/5 F1 F4

UN: R\$ 5,99 AV: R\$ 59,89 15: R\$ 61,14
30: R\$ 62,36 45: R\$ 63,61 60: R\$ 64,88



PLACA EVA 40X60CM GLITER MARROM 10X1

Código: 46232 Fábrica: YIN'S/IBEL Unidade: PT/10 F1 F4

UN: R\$ 5,99 AV: R\$ 29,94 15: R\$ 30,57
30: R\$ 31,18 45: R\$ 31,80 60: R\$ 32,44



PLACA EVA 40X60CM GLITER MARROM 5X1
Código: 41836 Fábrica: ONDA Unidade: PT/5 F1 F4

UN: R\$ 5,99 AV: R\$ 59,89 15: R\$ 61,14
30: R\$ 62,36 45: R\$ 63,61 60: R\$ 64,88

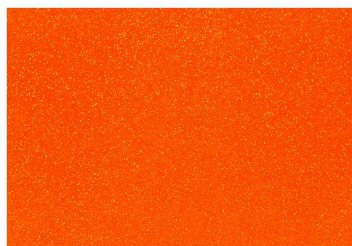

PLACA EVA 40X60CM GLITER NEON LARAN 10X1
Código: 46953 Fábrica: YIN'S PAPER Unidade: PT/10 F1 F4

UN: R\$ 5,99 AV: R\$ 59,89 15: R\$ 61,14
30: R\$ 62,36 45: R\$ 63,61 60: R\$ 64,88



PLACA EVA 40X60CM GLITER NEON ROSA 10X1
Código: 46952 Fábrica: YIN'S PAPER Unidade: PT/10 F1 F4

UN: R\$ 5,99 AV: R\$ 59,89 15: R\$ 61,14
30: R\$ 62,36 45: R\$ 63,61 60: R\$ 64,88



PLACA EVA 40X60CM GLITER NEON VERDE 10X1
Código: 46951 Fábrica: YIN'S PAPER Unidade: PT/10 F1 F4

UN: R\$ 5,99 AV: R\$ 59,89 15: R\$ 61,14
30: R\$ 62,36 45: R\$ 63,61 60: R\$ 64,88

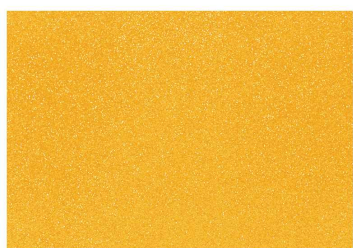

PLACA EVA 40X60CM GLITER OURO 10X1
Código: 46233 Fábrica: YIN'S PAPER Unidade: PT/10 F1 F4

UN: R\$ 5,99 AV: R\$ 59,89 15: R\$ 61,14
30: R\$ 62,36 45: R\$ 63,61 60: R\$ 64,88

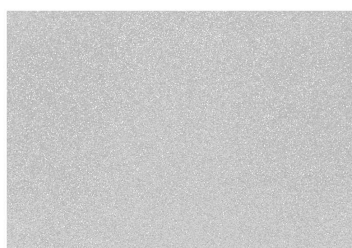

PLACA EVA 40X60CM GLITER PRATA 10X1
Código: 46237 Fábrica: YIN'S PAPER Unidade: PT/10 F1 F4

UN: R\$ 5,99 AV: R\$ 29,94 15: R\$ 30,57
30: R\$ 31,18 45: R\$ 31,80 60: R\$ 32,44



PLACA EVA 40X60CM GLITER PRATA 5X1
Código: 41842 Fábrica: ONDA Unidade: PT/5 F1 F4

UN: R\$ 5,99 AV: R\$ 59,89 15: R\$ 61,14
30: R\$ 62,36 45: R\$ 63,61 60: R\$ 64,88

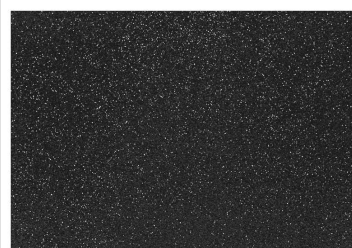

PLACA EVA 40X60CM GLITER PRETO 10X1
Código: 46217 Fábrica: YIN'S/IBEL Unidade: PT/10 F1 F4

UN: R\$ 5,99 AV: R\$ 59,89 15: R\$ 61,14
30: R\$ 62,36 45: R\$ 63,61 60: R\$ 64,88



PLACA EVA 40X60CM GLITER ROSA CLARO 10X1
Código: 46234 Fábrica: YIN'S PAPER Unidade: PT/10 F1 F4

UN: R\$ 5,99 AV: R\$ 29,94 15: R\$ 30,57
30: R\$ 31,18 45: R\$ 31,80 60: R\$ 32,44

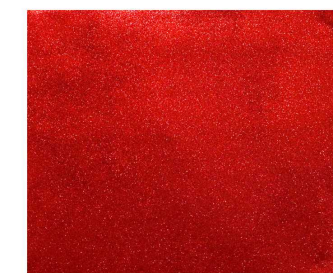

PLACA EVA 40X60CM GLITER ROSA PINK 5X1
Código: 49138 Fábrica: EVAMAX Unidade: PT/5 F1 F4

UN: R\$ 5,99 AV: R\$ 59,89 15: R\$ 61,14
30: R\$ 62,36 45: R\$ 63,61 60: R\$ 64,88



PLACA EVA 40X60CM GLITER ROSA 10X1
Código: 46238 Fábrica: YIN'S PAPER Unidade: PT/10 F1 F4

UN: R\$ 5,99 AV: R\$ 29,94 15: R\$ 30,57
30: R\$ 31,18 45: R\$ 31,80 60: R\$ 32,44

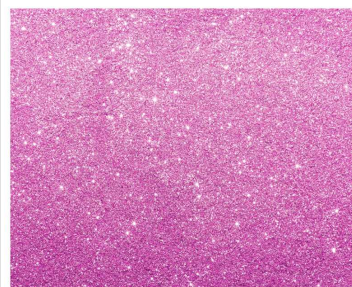

PLACA EVA 40X60CM GLITER ROSA 5X1
Código: 41838 Fábrica: ONDA Unidade: PT/5 F1 F4

UN: R\$ 5,99 AV: R\$ 29,94 15: R\$ 30,57
30: R\$ 31,18 45: R\$ 31,80 60: R\$ 32,44



PLACA EVA 40X60CM GLITER SKIN 5X1
Código: 41843 Fábrica: ONDA Unidade: PT/5 F1 F4

UN: R\$ 5,99 AV: R\$ 59,89 15: R\$ 61,14
30: R\$ 62,36 45: R\$ 63,61 60: R\$ 64,88

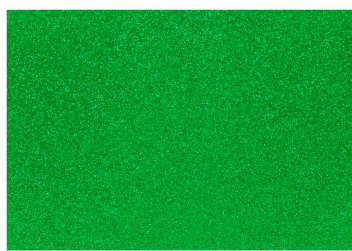

PLACA EVA 40X60CM GLITER VERDE BAND 10X1
Código: 46236 Fábrica: YIN'S PAPER Unidade: PT/10 F1 F4

UN: R\$ 5,99 AV: R\$ 29,94 15: R\$ 30,57
30: R\$ 31,18 45: R\$ 31,80 60: R\$ 32,44



PLACA EVA 40X60CM GLITER VERDE CLARO 5X1
Código: 41841 Fábrica: ONDA Unidade: PT/5 F1 F4

UN: R\$ 5,99 AV: R\$ 59,89 15: R\$ 61,14
30: R\$ 62,36 45: R\$ 63,61 60: R\$ 64,88

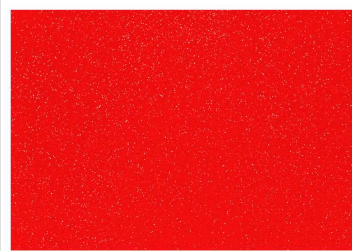

PLACA EVA 40X60CM GLITER VERM 10X1
Código: 46220 Fábrica: YIN'S/IBEL Unidade: PT/10 F1 F4

UN: R\$ 2,50 AV: R\$ 24,95 15: R\$ 25,47
30: R\$ 25,98 45: R\$ 26,50 60: R\$ 27,03



PLACA EVA 40X60CM LARANJA 4903 10X1
Código: Fábrika: Unidade:
22527 LEOARTE PT/10
F1 F4

UN: R\$ 2,50 AV: R\$ 24,95 15: R\$ 25,47
30: R\$ 25,98 45: R\$ 26,50 60: R\$ 27,03



PLACA EVA 40X60CM LILAS 10X1
Código: Fábrika: Unidade:
43698 IBEL PT/10
F1 F4

UN: R\$ 2,50 AV: R\$ 24,95 15: R\$ 25,47
30: R\$ 25,98 45: R\$ 26,50 60: R\$ 27,03



PLACA EVA 40X60CM LILAS 4908 10X1
Código: Fábrika: Unidade:
48366 LEOARTE PT/10
F1 F4

UN: R\$ 2,50 AV: R\$ 24,95 15: R\$ 25,47
30: R\$ 25,98 45: R\$ 26,50 60: R\$ 27,03



PLACA EVA 40X60CM MARROM 4909 10X1
Código: Fábrika: Unidade:
48364 LEOARTE PT/10
F1 F4

UN: R\$ 5,99 AV: R\$ 29,94 15: R\$ 30,57
30: R\$ 31,18 45: R\$ 31,80 60: R\$ 32,44

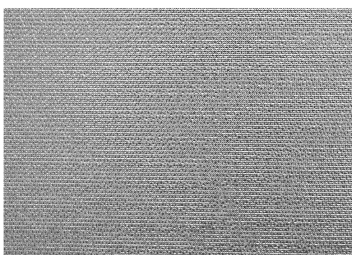

PLACA EVA 40X60CM METALICO PRATA 5X1
Código: Fábrika: Unidade:
38570 MAKE PT/5
F1 F4

UN: R\$ 5,99 AV: R\$ 29,94 15: R\$ 30,57
30: R\$ 31,18 45: R\$ 31,80 60: R\$ 32,44

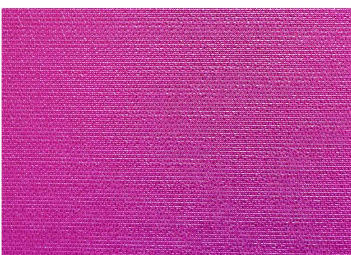

PLACA EVA 40X60CM METALICO ROSA PINK 5X1
Código: Fábrika: Unidade:
38571 MAKE PT/5
F1 F4

UN: R\$ 2,50 AV: R\$ 24,95 15: R\$ 25,47
30: R\$ 25,98 45: R\$ 26,50 60: R\$ 27,03



PLACA EVA 40X60CM PELE 4753 10X1
Código: Fábrika: Unidade:
45383 LEOARTE PT/10
F1 F4

UN: R\$ 2,50 AV: R\$ 24,95 15: R\$ 25,47
30: R\$ 25,98 45: R\$ 26,50 60: R\$ 27,03



PLACA EVA 40X60CM PRETO 4905 10X1
Código: Fábrika: Unidade:
43706 LEOARTE PT/10
F1 F4

UN: R\$ 2,50 AV: R\$ 24,95 15: R\$ 25,47
30: R\$ 25,98 45: R\$ 26,50 60: R\$ 27,03



PLACA EVA 40X60CM ROSA BEBE 4707 10X1
Código: Fábrika: Unidade:
45382 LEOARTE PT/10
F1 F4

UN: R\$ 2,40 AV: R\$ 23,95 15: R\$ 24,45
30: R\$ 24,94 45: R\$ 25,44 60: R\$ 25,95



PLACA EVA 40X60CM ROSA PINK 4930 10X1
Código: Fábrika: Unidade:
45381 LEOARTE PT/10
F1 F4

UN: R\$ 2,50 AV: R\$ 24,95 15: R\$ 25,47
30: R\$ 25,98 45: R\$ 26,50 60: R\$ 27,03



PLACA EVA 40X60CM ROSA 4911 10X1
Código: Fábrika: Unidade:
48363 LEOARTE PT/10
F1 F4

UN: R\$ 2,50 AV: R\$ 24,95 15: R\$ 25,47
30: R\$ 25,98 45: R\$ 26,50 60: R\$ 27,03



PLACA EVA 40X60CM ROXO 4914 10X1
Código: Fábrika: Unidade:
48365 LEOARTE PT/10
F1 F4

UN: R\$ 2,50 AV: R\$ 24,95 15: R\$ 25,47
30: R\$ 25,98 45: R\$ 26,50 60: R\$ 27,03



PLACA EVA 40X60CM VERDE BANDEIRA 10X1
Código: Fábrika: Unidade:
43695 BRW PT/10
F1 F4

UN: R\$ 2,40 AV: R\$ 23,95 15: R\$ 24,45
30: R\$ 24,94 45: R\$ 25,44 60: R\$ 25,95



PLACA EVA 40X60CM VERDE CLARO 10X1
Código: Fábrika: Unidade:
49139 EVAMAX PT/10
F1 F4

UN: R\$ 2,50 AV: R\$ 24,95 15: R\$ 25,47
30: R\$ 25,98 45: R\$ 26,50 60: R\$ 27,03



PLACA EVA 40X60CM VERDE GRAMA 4705 10X1
Código: Fábrika: Unidade:
48361 LEOARTE PT/10
F1 F4

UN: R\$ 2,50 AV: R\$ 24,95 15: R\$ 25,47
30: R\$ 25,98 45: R\$ 26,50 60: R\$ 27,03



PLACA EVA 40X60CM VERDE 4902 10X1
Código: Fábrika: Unidade:
48722 LEOARTE PT/10
F1 F4

UN: R\$ 2,50 AV: R\$ 24,95 15: R\$ 25,47
30: R\$ 25,98 45: R\$ 26,50 60: R\$ 27,03



PLACA EVA 40X60CM VERMELHO FOG 4710 10X1
Código: 48362 Fábrica: LEOARTE Unidade: PT/10 F1 F4

UN: R\$ 2,60 AV: R\$ 129,78 15: R\$ 132,49
30: R\$ 135,14 45: R\$ 137,84 60: R\$ 140,60



PLACA ISOPOR 1000X500X05MM 50X1
Código: 42395 Fábrica: ISOMAX Unidade: PT/50 F1 F4

UN: R\$ 4,29 AV: R\$ 107,33 15: R\$ 109,56
30: R\$ 111,76 45: R\$ 113,99 60: R\$ 116,27

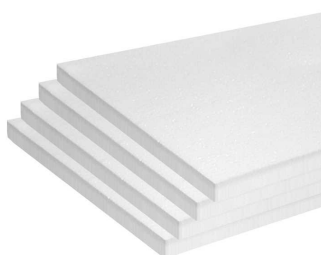

PLACA ISOPOR 1000X500X10MM 25X1
Código: 7111 Fábrica: ISOMAX Unidade: PT/25 F1 F4

UN: R\$ 6,71 AV: R\$ 107,33 15: R\$ 109,56
30: R\$ 111,76 45: R\$ 113,99 60: R\$ 116,27



PLACA ISOPOR 1000X500X15MM 16X1
Código: 29881 Fábrica: ISOMAX Unidade: PT/16 F1 F4

UN: R\$ 8,94 AV: R\$ 107,33 15: R\$ 109,56
30: R\$ 111,76 45: R\$ 113,99 60: R\$ 116,27

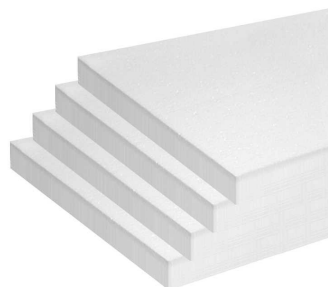

PLACA ISOPOR 1000X500X20MM 12X1
Código: 31928 Fábrica: ISOMAX Unidade: PT/12 F1 F4

UN: R\$ 10,73 AV: R\$ 107,33 15: R\$ 109,56
30: R\$ 111,76 45: R\$ 113,99 60: R\$ 116,27



PLACA ISOPOR 1000X500X25MM 10X1
Código: 12578 Fábrica: ISOMAX Unidade: PT/10 F1 F4

UN: R\$ 13,42 AV: R\$ 107,33 15: R\$ 109,56
30: R\$ 111,76 45: R\$ 113,99 60: R\$ 116,27



PLACA ISOPOR 1000X500X30MM 8X1
Código: 30091 Fábrica: ISOMAX Unidade: PT/8 F1 F4

UN: R\$ 21,47 AV: R\$ 107,33 15: R\$ 109,56
30: R\$ 111,76 45: R\$ 113,99 60: R\$ 116,27



PLACA ISOPOR 1000X500X45MM 5X1
Código: 43776 Fábrica: ISOMAX Unidade: PT/5 F1 F4

UN: R\$ 21,47 AV: R\$ 107,33 15: R\$ 109,56
30: R\$ 111,76 45: R\$ 113,99 60: R\$ 116,27



PLACA ISOPOR 1000X500X50MM 5X1
Código: 41761 Fábrica: ISOMAX Unidade: PT/5 F1 F4

UN: R\$ 107,33 AV: R\$ 107,33 15: R\$ 109,56
30: R\$ 111,76 45: R\$ 113,99 60: R\$ 116,27

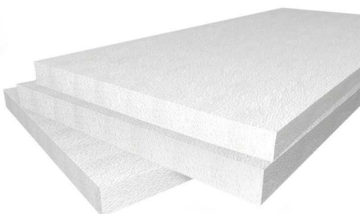

PLACA ISOPOR 1000X500X75MM 3X1
Código: 42345 Fábrica: ISOMAX Unidade: PT/1 F1 F4

UN: R\$ 3,49 AV: R\$ 34,93 15: R\$ 35,66
30: R\$ 36,38 45: R\$ 37,10 60: R\$ 37,84

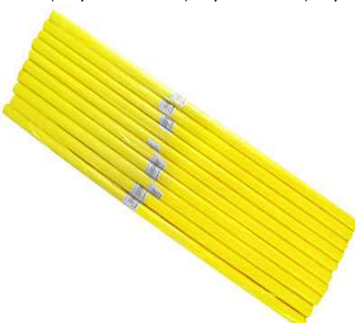

PLASTICO ENCAPAR 2MX45CM AMARELO 10X1
Código: 2533 Fábrica: DDL Unidade: PT/10 F1 F4

UN: R\$ 3,49 AV: R\$ 34,93 15: R\$ 35,66
30: R\$ 36,38 45: R\$ 37,10 60: R\$ 37,84



PLASTICO ENCAPAR 2MX45CM AZUL 10X1
Código: 2532 Fábrica: DDL Unidade: PT/10 F1 F4

UN: R\$ 3,49 AV: R\$ 34,94 15: R\$ 35,67
30: R\$ 36,38 45: R\$ 37,11 60: R\$ 37,85

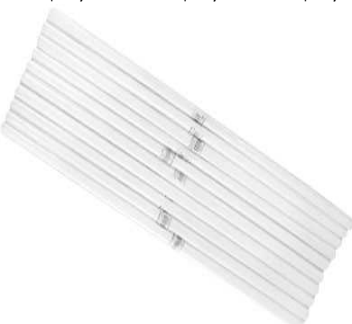

PLASTICO ENCAPAR 2MX45CM BRANCO 10X1
Código: 44377 Fábrica: DDL Unidade: PT/10 F1 F4

UN: R\$ 3,49 AV: R\$ 34,93 15: R\$ 35,66
30: R\$ 36,38 45: R\$ 37,10 60: R\$ 37,84

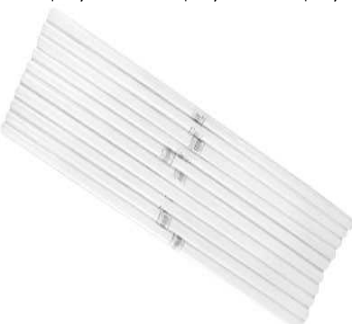

PLASTICO ENCAPAR 2MX45CM INCOLOR 10X1
Código: 14136 Fábrica: DDL Unidade: PT/10 F1 F4

UN: R\$ 3,49 AV: R\$ 34,93 15: R\$ 35,66
30: R\$ 36,38 45: R\$ 37,10 60: R\$ 37,84



PLASTICO ENCAPAR 2MX45CM ROSA 10X1
Código: 44371 Fábrica: DDL Unidade: PT/10 F1 F4

UN: R\$ 3,49 AV: R\$ 34,93 15: R\$ 35,66
30: R\$ 36,38 45: R\$ 37,10 60: R\$ 37,84



PLASTICO ENCAPAR 2MX45CM SORT 10X1
Código: 13136 Fábrica: DDL Unidade: PT/10 F1 F4

UN: R\$ 3,49 AV: R\$ 34,93 15: R\$ 35,66
30: R\$ 36,38 45: R\$ 37,10 60: R\$ 37,84



PLASTICO ENCAPAR 2MX45CM VERDE 10X1

Código: Fábrica: Unidade:
3969 DDL PT/10
F1 F4

UN: R\$ 3,49 AV: R\$ 34,93 15: R\$ 35,66
30: R\$ 36,38 45: R\$ 37,10 60: R\$ 37,84



PLASTICO ENCAPAR 2MX45CM VERMELH 10X1

Código: Fábrica: Unidade:
2534 DDL PT/10
F1 F4

UN: R\$ 1,60 AV: R\$ 39,93 15: R\$ 40,76
30: R\$ 41,57 45: R\$ 42,40 60: R\$ 43,25



PLASTICO ENCAPAR 25MX45CM AZUL CORACAO

Código: Fábrica: Unidade:
3973 FA RL/25
F1 F4

UN: R\$ 1,60 AV: R\$ 39,93 15: R\$ 40,76
30: R\$ 41,57 45: R\$ 42,40 60: R\$ 43,25



PLASTICO ENCAPAR 25MX45CM INF

Código: Fábrica: Unidade:
42833 FA RL/25
F1 F4

UN: R\$ 1,60 AV: R\$ 39,93 15: R\$ 40,76
30: R\$ 41,57 45: R\$ 42,40 60: R\$ 43,25



PLASTICO ENCAPAR 25MX45CM INF FEMININO

Código: Fábrica: Unidade:
42832 FA RL/25
F1 F4

UN: R\$ 1,60 AV: R\$ 39,93 15: R\$ 40,76
30: R\$ 41,57 45: R\$ 42,40 60: R\$ 43,25



PLASTICO ENCAPAR 25MX45CM LISO AZUL

Código: Fábrica: Unidade:
27953 NEW MAGIC RL/25
F1 F4

UN: R\$ 1,60 AV: R\$ 39,93 15: R\$ 40,76
30: R\$ 41,57 45: R\$ 42,40 60: R\$ 43,25



PLASTICO ENCAPAR 25MX45CM TRANSP DEC

Código: Fábrica: Unidade:
42837 FA RL/25
F1 F4

UN: R\$ 2,26 AV: R\$ 56,41 15: R\$ 57,58
30: R\$ 58,74 45: R\$ 59,91 60: R\$ 61,11



PLASTICO ENCAPAR 25MX45CM TRANSP 04

Código: Fábrica: Unidade:
45604 DAC RL/25
F1 F4

UN: R\$ 1,60 AV: R\$ 39,93 15: R\$ 40,76
30: R\$ 41,57 45: R\$ 42,40 60: R\$ 43,25



PLASTICO ENCAPAR 25MX45CM VERMELHO

Código: Fábrica: Unidade:
3966 FA RL/25
F1 F4

UN: R\$ 1,60 AV: R\$ 39,93 15: R\$ 40,76
30: R\$ 41,57 45: R\$ 42,40 60: R\$ 43,25

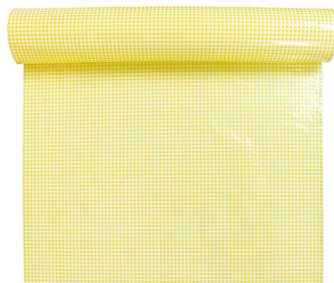

PLASTICO ENCAPAR 25MX45CM XADREZ AMARE

Código: Fábrica: Unidade:
3965 FA RL/25
F1 F4

UN: R\$ 1,60 AV: R\$ 39,93 15: R\$ 40,76
30: R\$ 41,57 45: R\$ 42,40 60: R\$ 43,25

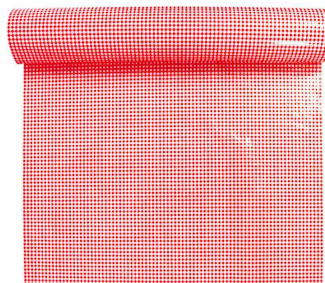

PLASTICO ENCAPAR 25MX45CM XADREZ VERME

Código: Fábrica: Unidade:
42851 FA RL/25
F1 F4

UN: R\$ 61,28 AV: R\$ 61,28 15: R\$ 62,56
30: R\$ 63,81 45: R\$ 65,09 60: R\$ 66,39



PLASTICO ENCAPAR 35X50CM PICOT AMAR 75X1

Código: Fábrica: Unidade:
7229 NEW MAGIC RL/1
F1 F4

UN: R\$ 61,28 AV: R\$ 61,28 15: R\$ 62,56
30: R\$ 63,81 45: R\$ 65,09 60: R\$ 66,39



PLASTICO ENCAPAR 35X50CM PICOT VERD 75X1

Código: Fábrica: Unidade:
7231 APLICOLA RL/1
F1 F4

UN: R\$ 61,28 AV: R\$ 61,28 15: R\$ 62,56
30: R\$ 63,81 45: R\$ 65,09 60: R\$ 66,39



PLASTICO ENCAPAR 35X50CM PICOT VERM 75X1

Código: Fábrica: Unidade:
7230 APLICOLA RL/1
F1 F4

UN: R\$ 61,28 AV: R\$ 61,28 15: R\$ 62,56
30: R\$ 63,81 45: R\$ 65,09 60: R\$ 66,39



PLASTICO ENCAPAR 35X50CMPICOT INCOL 75X1

Código: Fábrica: Unidade:
7233 APLICOLA RL/1
F1 F4

UN: R\$ 0,80 AV: R\$ 39,93 15: R\$ 40,76
30: R\$ 41,57 45: R\$ 42,40 60: R\$ 43,25



PLASTICO ENCAPAR 50MX35CM LISO AMARELO

Código: Fábrica: Unidade:
47445 PLASVIPEL RL/50
F1 F4

UN: R\$ 0,80 AV: R\$ 39,93 15: R\$ 40,76
30: R\$ 41,57 45: R\$ 42,40 60: R\$ 43,25



PLASTICO ENCAPAR 50MX35CM LISO VERMELHO

Código: 47447 Fábrica: PLASVIPEL Unidade: RL/50 F1 F4

UN: R\$ 0,80 AV: R\$ 39,93 15: R\$ 40,76
30: R\$ 41,57 45: R\$ 42,40 60: R\$ 43,25



PLASTICO ENCAPAR 50MX35CM PICOT INF

Código: 48000 Fábrica: PLASVIPEL Unidade: RL/50 F1 F4

UN: R\$ 1,00 AV: R\$ 49,91 15: R\$ 50,95
30: R\$ 51,97 45: R\$ 53,01 60: R\$ 54,07

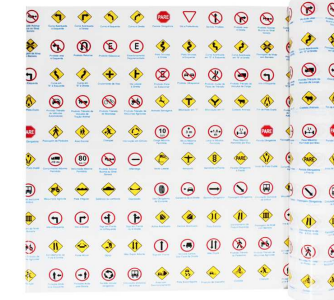

PLASTICO ENCAPAR 50MX45CM EST TRANSITO

Código: 47999 Fábrica: FA Unidade: RL/50 F1 F4

UN: R\$ 1,00 AV: R\$ 49,91 15: R\$ 50,95
30: R\$ 51,97 45: R\$ 53,01 60: R\$ 54,07

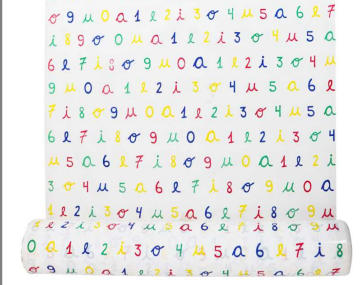

PLASTICO ENCAPAR 50MX45CM ESTAMP ABC

Código: 42849 Fábrica: FA Unidade: RL/50 F1 F4

UN: R\$ 1,00 AV: R\$ 49,91 15: R\$ 50,95
30: R\$ 51,97 45: R\$ 53,01 60: R\$ 54,07



PLASTICO ENCAPAR 50MX45CM ESTAMP NUM/LET

Código: 45626 Fábrica: FA Unidade: RL/50 F1 F4

UN: R\$ 2,00 AV: R\$ 49,91 15: R\$ 50,95
30: R\$ 51,97 45: R\$ 53,01 60: R\$ 54,07



PLASTICO ENCAPAR 50MX45CM INF MASCULIN

Código: 42838 Fábrica: FA Unidade: RL/25 F1 F4

UN: R\$ 1,00 AV: R\$ 49,91 15: R\$ 50,95
30: R\$ 51,97 45: R\$ 53,01 60: R\$ 54,07



PLASTICO ENCAPAR 50MX45CM TRANSP DEC

Código: 42846 Fábrica: FA Unidade: RL/50 F1 F4

UN: R\$ 1,00 AV: R\$ 49,91 15: R\$ 50,95
30: R\$ 51,97 45: R\$ 53,01 60: R\$ 54,07

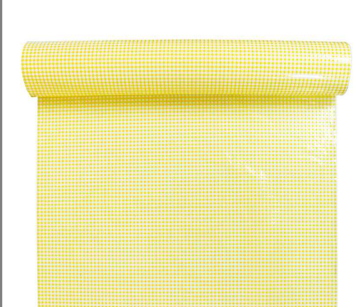

PLASTICO ENCAPAR 50MX45CM XADREZ AMARE

Código: 42850 Fábrica: DAC Unidade: RL/50 F1 F4

UN: R\$ 0,17 AV: R\$ 173,71 15: R\$ 177,33
30: R\$ 180,88 45: R\$ 184,49 60: R\$ 188,18

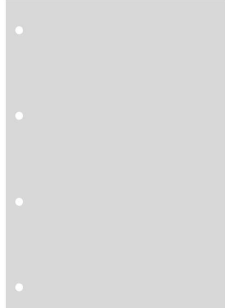

PLASTICO PASTA CATALAGO OF 0,06 4F 1000X1

Código: 42414 Fábrica: ACP Unidade: MI/1000 F1 F4

UN: R\$ 0,19 AV: R\$ 18,96 15: R\$ 19,35
30: R\$ 19,74 45: R\$ 20,14 60: R\$ 20,54



PLASTICO PASTA CATALAGO A4 FINO 4F 100X1

Código: 13177 Fábrica: MAXIPLASTICO Unidade: CE/100 F1 F4

UN: R\$ 0,20 AV: R\$ 19,96 15: R\$ 20,37
30: R\$ 20,78 45: R\$ 21,20 60: R\$ 21,62

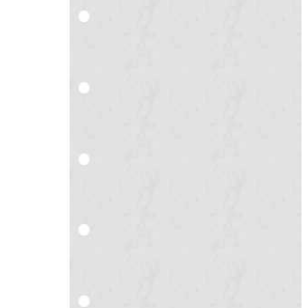

PLASTICO PASTA CATALAGO OF 0,06 4F 100X1

Código: 3603 Fábrica: ACP Unidade: CE/100 F1 F4

UN: R\$ 0,35 AV: R\$ 173,71 15: R\$ 177,33
30: R\$ 180,88 45: R\$ 184,49 60: R\$ 188,18



PLASTICO PASTA CATALAGO OF 0,12 4F 500X1

Código: 42417 Fábrica: ACP Unidade: CX/500 F1 F4

UN: R\$ 0,43 AV: R\$ 173,71 15: R\$ 177,33
30: R\$ 180,88 45: R\$ 184,49 60: R\$ 188,18

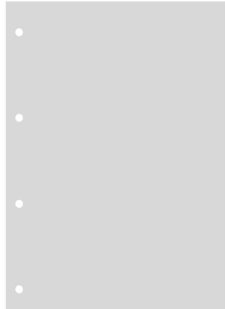

PLASTICO PASTA CATALAGO OF 0,15 4F 400X1

Código: 42416 Fábrica: ACP Unidade: CX/400 F1 F4

UN: R\$ 2,30 AV: R\$ 229,62 15: R\$ 234,41
30: R\$ 239,09 45: R\$ 243,88 60: R\$ 248,75

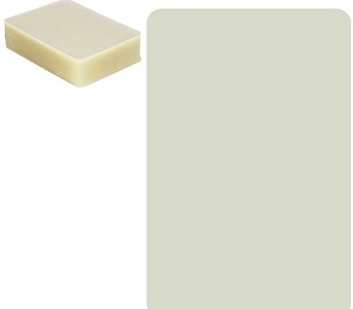

PLASTICO POLASEAL A3 303X426MM 05 100X1

Código: 37809 Fábrica: PIC10 Unidade: CE/100 F1 F4

UN: R\$ 0,90 AV: R\$ 89,85 15: R\$ 91,72
30: R\$ 93,55 45: R\$ 95,42 60: R\$ 97,33



PLASTICO POLASEAL A4 220X307MM 05 100X1

Código: 45267 Fábrica: MASTERPRINT Unidade: CE/100 F1 F4

UN: R\$ 0,13 AV: R\$ 12,97 15: R\$ 13,24
30: R\$ 13,50 45: R\$ 13,77 60: R\$ 14,05



PLASTICO POLASEAL CPF/TI 5 66X99MM 100X1

Código: 27095 Fábrica: MASTER/PLAST Unidade: CE/100 F1 F4

UN: R\$ 0,10 AV: R\$ 9,97 15: R\$ 10,18
30: R\$ 10,39 45: R\$ 10,59 60: R\$ 10,81

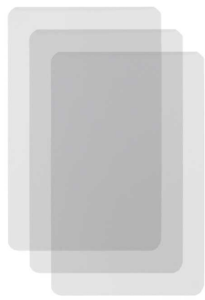

PLASTICO POLASEAL CRACH 05 59X86MM 100X1

Código: Fábrica: Unidade:
45124 MASTERPRINT CE/100
F1 F4

UN: R\$ 0,16 AV: R\$ 15,58 15: R\$ 15,90
30: R\$ 16,22 45: R\$ 16,54 60: R\$ 16,87

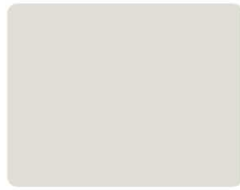

PLASTICO POLASEAL CRACH 5 73X106MM 100X1

Código: Fábrica: Unidade:
27169 LIDER CE/100
F1 F4

UN: R\$ 1,60 AV: R\$ 159,73 15: R\$ 163,06
30: R\$ 166,32 45: R\$ 169,65 60: R\$ 173,04

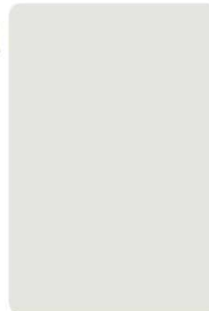

PLASTICO POLASEAL OFI 222X336MM 05 100X1

Código: Fábrica: Unidade:
20787 PLASTIFIX CE/100
F1 F4

UN: R\$ 1,20 AV: R\$ 119,71 15: R\$ 122,20
30: R\$ 124,65 45: R\$ 127,14 60: R\$ 129,68



PLASTICO POLASEAL OFI 226X340MM 05 100X1

Código: Fábrica: Unidade:
47214 MASTERPRINT CE/100
F1 F4

UN: R\$ 0,17 AV: R\$ 16,96 15: R\$ 17,32
30: R\$ 17,66 45: R\$ 18,02 60: R\$ 18,38



PLASTICO POLASEAL RG 79X108MM 05 100X1

Código: Fábrica: Unidade:
22613 MASTERPRINT CE/100
F1 F4

UN: R\$ 0,17 AV: R\$ 16,96 15: R\$ 17,32
30: R\$ 17,66 45: R\$ 18,02 60: R\$ 18,38

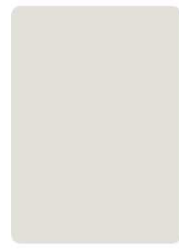

PLASTICO POLASEAL RG 80X110MM 05 100X1

Código: Fábrica: Unidade:
20785 MASTERPRINT CE/100
F1 F4

UN: R\$ 0,60 AV: R\$ 59,89 15: R\$ 61,14
30: R\$ 62,36 45: R\$ 63,61 60: R\$ 64,88



PLASTICO POLASEAL 1/2 OF 170X226MM 100X1

Código: Fábrica: Unidade:
28213 MASTERPRINT CE/100
F1 F4

UN: R\$ 678,90 AV: R\$ 678,90 15: R\$ 693,05
30: R\$ 706,91 45: R\$ 721,04 60: R\$ 735,47



PLASTICO PP CRISTAL 0,10X1380MMX50MTS

Código: Fábrica: Unidade:
42030 PLAST CO RL/1
F1 F4

UN: R\$ 1397,75 AV: R\$ 1397,75 15: R\$ 1426,87
30: R\$ 1455,41 45: R\$ 1484,52 60: R\$ 1514,21



PLASTICO PP CRISTAL 0,20X1380MMX50MTS

Código: Fábrica: Unidade:
42032 PLAST CO RL/1
F1 F4

UN: R\$ 0,40 AV: R\$ 39,93 15: R\$ 40,76
30: R\$ 41,57 45: R\$ 42,40 60: R\$ 43,25

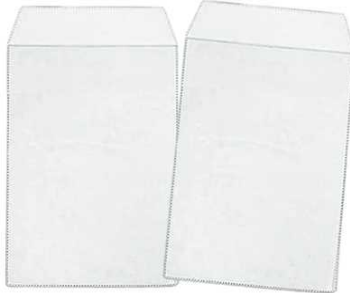

PLASTICO PROT IDENTIDADE 10X7,4CM 100X1

Código: Fábrica: Unidade:
26708 PLADL CE/100
F1 F4

UN: R\$ 19,96 AV: R\$ 19,96 15: R\$ 20,37
30: R\$ 20,78 45: R\$ 21,20 60: R\$ 21,62



PORTA CANETAS TRIPLO CRISTAL 240X70X80MM

Código: Fábrica: Unidade:
42739 DELLO UN/1
F1 F4

UN: R\$ 19,96 AV: R\$ 19,96 15: R\$ 20,37
30: R\$ 20,78 45: R\$ 21,20 60: R\$ 21,62



PORTA CANETAS TRIPLO FUME 240X70X80MM

Código: Fábrica: Unidade:
42740 DELLO UN/1
F1 F4

UN: R\$ 19,52 AV: R\$ 19,52 15: R\$ 19,93
30: R\$ 20,32 45: R\$ 20,73 60: R\$ 21,15



PORTA CARIMBOS ACRIL CRISTAL 6 LUG 3060

Código: Fábrica: Unidade:
46005 ACRINIL UN/1
F1 F4

UN: R\$ 19,52 AV: R\$ 19,52 15: R\$ 19,93
30: R\$ 20,32 45: R\$ 20,73 60: R\$ 21,15



PORTA CARIMBOS ACRIL FUME 6 LUG 3061

Código: Fábrica: Unidade:
46006 ACRINIL UN/1
F1 F4

UN: R\$ 42,92 AV: R\$ 42,92 15: R\$ 43,82
30: R\$ 44,69 45: R\$ 45,59 60: R\$ 46,50



PORTA CARIMBOS GIRATORIO SLUGA METAL 165

Código: Fábrica: Unidade:
43748 CARBRINK UN/1
F1 F4

UN: R\$ 7,49 AV: R\$ 7,49 15: R\$ 7,64
30: R\$ 7,80 45: R\$ 7,95 60: R\$ 8,11

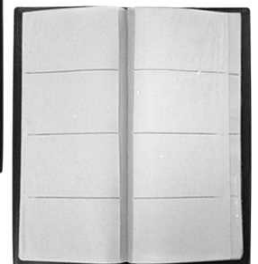

PORTA CARTOES TELEFONICO 10 PLASTICOS

Código: Fábrica: Unidade:
7052 DAC. UN/1
F1 F4

UN: R\$ 4,98 AV: R\$ 4,98 15: R\$ 5,09
30: R\$ 5,19 45: R\$ 5,29 60: R\$ 5,40



PORTA CLIPS ACR FUME MAGNET 42X62MM 7123
Código: Fábrika: Unidade:
42811 YIN'S PAPER UN/1
F1 F4

UN: R\$ 7,98 AV: R\$ 7,98 15: R\$ 8,14
30: R\$ 8,31 45: R\$ 8,47 60: R\$ 8,64



PORTA CLIPS 42MMX62MM 2041
Código: Fábrika: Unidade:
42064 MASTERPRINT UN/1
F1 F4

UN: R\$ 0,77 AV: R\$ 0,77 15: R\$ 0,78
30: R\$ 0,80 45: R\$ 0,82 60: R\$ 0,83



PORTA CRACHA PLAST PRETO UN
Código: Fábrika: Unidade:
44274 ITALY'S UN/1
F1 F4

UN: R\$ 0,77 AV: R\$ 0,77 15: R\$ 0,78
30: R\$ 0,80 45: R\$ 0,82 60: R\$ 0,83

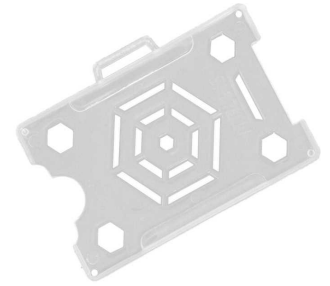

PORTA CRACHA PLAST TRANSPARENTE UN
Código: Fábrika: Unidade:
44273 ITALY'S UN/1
F1 F4

UN: R\$ 19,96 AV: R\$ 19,96 15: R\$ 20,37
30: R\$ 20,78 45: R\$ 21,20 60: R\$ 21,62



PORTA LAPIS ACRIL DUPLO CRISTAL 939.3
Código: Fábrika: Unidade:
40883 ACRIMET UN/1
F1 F4

UN: R\$ 49,91 AV: R\$ 49,91 15: R\$ 50,95
30: R\$ 51,97 45: R\$ 53,01 60: R\$ 54,07



PORTA LAPIS CARROS 00952
Código: Fábrika: Unidade:
48589 WIN PAPER UN/1
F1 F4

UN: R\$ 9,97 AV: R\$ 9,97 15: R\$ 10,18
30: R\$ 10,39 45: R\$ 10,59 60: R\$ 10,81



PORTA LAPIS CRISTAL JOY 22CM AMARE 21974
Código: Fábrika: Unidade:
46116 ACP UN/1
F1 F4

UN: R\$ 9,97 AV: R\$ 9,97 15: R\$ 10,18
30: R\$ 10,39 45: R\$ 10,59 60: R\$ 10,81



PORTA LAPIS CRISTAL JOY 22CM LARA 21974
Código: Fábrika: Unidade:
46118 ACP UN/1
F1 F4

UN: R\$ 9,97 AV: R\$ 9,97 15: R\$ 10,18
30: R\$ 10,39 45: R\$ 10,59 60: R\$ 10,81



PORTA LAPIS CRISTAL JOY 22CM PINK 21974
Código: Fábrika: Unidade:
46117 ACP UN/1
F1 F4

UN: R\$ 24,95 AV: R\$ 24,95 15: R\$ 25,47
30: R\$ 25,98 45: R\$ 26,50 60: R\$ 27,03



PORTA LAPIS GAME 00948
Código: Fábrika: Unidade:
48587 WIN PAPER UN/1
F1 F4

UN: R\$ 16,99 AV: R\$ 16,99 15: R\$ 16,99
30: R\$ 16,99 45: R\$ 16,99 60: R\$ 16,99



PORTA LAPIS INF BRANCA DE NEVE ES4629
Código: Fábrika: Unidade:
49027 PONTO VERDE UN/1
F1 F4

UN: R\$ 20,96 AV: R\$ 20,96 15: R\$ 21,39
30: R\$ 21,82 45: R\$ 22,26 60: R\$ 22,70



PORTA LAPIS INF FEM BEE FRIENDS ES4805
Código: Fábrika: Unidade:
49073 PONTO VERDE UN/1
F1 F4

UN: R\$ 17,36 AV: R\$ 17,36 15: R\$ 17,72
30: R\$ 18,08 45: R\$ 18,44 60: R\$ 18,81



PORTA LAPIS INF FEM CANDY GIRL ES4609
Código: Fábrika: Unidade:
49198 PONTO VERDE UN/1
F1 F4

UN: R\$ 36,93 AV: R\$ 36,93 15: R\$ 37,70
30: R\$ 38,45 45: R\$ 39,22 60: R\$ 40,01



PORTA LAPIS INF FEM FAMILY SHARK 4193
Código: Fábrika: Unidade:
44051 PONTO VERDE UN/1
F1 F4

UN: R\$ 20,96 AV: R\$ 20,96 15: R\$ 21,39
30: R\$ 21,82 45: R\$ 22,26 60: R\$ 22,70



PORTA LAPIS INF FEM RAINBOW ES4962
Código: Fábrika: Unidade:
49075 PONTO VERDE UN/1
F1 F4

UN: R\$ 20,96 AV: R\$ 20,96 15: R\$ 21,39
30: R\$ 21,82 45: R\$ 22,26 60: R\$ 22,70



PORTA LAPIS INF FEM SEREIA ES4811
Código: Fábrika: Unidade:
49076 PONTO VERDE UN/1
F1 F4

UN: R\$ 20,96 AV: R\$ 20,96 15: R\$ 21,39
30: R\$ 21,82 45: R\$ 22,26 60: R\$ 22,70



PORTA LAPIS INF FEM 3 PRINCESAS ES4827

Código: Fábrica: Unidade:
49071 PONTO VERDE UN/1
F1 F4

UN: R\$ 20,96 AV: R\$ 20,96 15: R\$ 21,39
30: R\$ 21,82 45: R\$ 22,26 60: R\$ 22,70



PORTA LAPIS INF KIDS PLAY ES4821

Código: Fábrica: Unidade:
49074 PONTO VERDE UN/1
F1 F4

UN: R\$ 20,96 AV: R\$ 20,96 15: R\$ 21,39
30: R\$ 21,82 45: R\$ 22,26 60: R\$ 22,70



PORTA LAPIS INF LINHA SETINADO ES4875

Código: Fábrica: Unidade:
49029 PONTO VERDE UN/1
F1 F4

UN: R\$ 20,96 AV: R\$ 20,96 15: R\$ 21,39
30: R\$ 21,82 45: R\$ 22,26 60: R\$ 22,70



PORTA LAPIS INF MASC BATTLE ES4849

Código: Fábrica: Unidade:
49072 PONTO VERDE UN/1
F1 F4

UN: R\$ 24,95 AV: R\$ 24,95 15: R\$ 25,47
30: R\$ 25,98 45: R\$ 26,50 60: R\$ 27,03



PORTA LAPIS INF MASC BLOCK GAME ES4853

Código: Fábrica: Unidade:
49026 PONTO VERDE UN/1
F1 F4

UN: R\$ 33,94 AV: R\$ 33,94 15: R\$ 34,64
30: R\$ 35,34 45: R\$ 36,04 60: R\$ 36,76



PORTA LAPIS INF MASC BLOCK GAME 4188

Código: Fábrica: Unidade:
44052 PONTO VERDE UN/1
F1 F4

UN: R\$ 28,94 AV: R\$ 28,94 15: R\$ 29,55
30: R\$ 30,14 45: R\$ 30,74 60: R\$ 31,36



PORTA LAPIS INF MASC GUARDIAN NIGHT 4179

Código: Fábrica: Unidade:
44406 PONTO VERDE UN/1
F1 F4

UN: R\$ 24,95 AV: R\$ 24,95 15: R\$ 25,47
30: R\$ 25,98 45: R\$ 26,50 60: R\$ 27,03



PORTA LAPIS INF MASC KARKS KIDS ES4669

Código: Fábrica: Unidade:
48987 PONTO VERDE UN/1
F1 F4

UN: R\$ 16,99 AV: R\$ 16,99 15: R\$ 16,99
30: R\$ 16,99 45: R\$ 16,99 60: R\$ 16,99



PORTA LAPIS INF MASC SPEED WEB ES4649

Código: Fábrica: Unidade:
48988 PONTO VERDE UN/1
F1 F4

UN: R\$ 31,94 AV: R\$ 31,94 15: R\$ 32,60
30: R\$ 33,26 45: R\$ 33,92 60: R\$ 34,60



PORTA LAPIS INF PRINCESS EVA 3D ES5041

Código: Fábrica: Unidade:
49028 PONTO VERDE UN/1
F1 F4

UN: R\$ 21,95 AV: R\$ 21,95 15: R\$ 22,41
30: R\$ 22,86 45: R\$ 23,32 60: R\$ 23,78



PORTA LAPIS INF SEREIA ES4619

Código: Fábrica: Unidade:
49030 PONTO VERDE UN/1
F1 F4

UN: R\$ 30,94 AV: R\$ 30,94 15: R\$ 31,59
30: R\$ 32,22 45: R\$ 32,86 60: R\$ 33,52



PORTA LAPIS JUVENIL FEM ES4289

Código: Fábrica: Unidade:
48955 PONTO VERDE UN/1
F1 F4

UN: R\$ 27,81 AV: R\$ 27,81 15: R\$ 28,38
30: R\$ 28,95 45: R\$ 29,53 60: R\$ 30,12



PORTA LAPIS JUVENIL FEM MH 4321

Código: Fábrica: Unidade:
44027 PONTO VERDE UN/1
F1 F4

UN: R\$ 33,94 AV: R\$ 33,94 15: R\$ 34,64
30: R\$ 35,34 45: R\$ 36,04 60: R\$ 36,76



PORTA LAPIS JUVENIL FEM TOP MODEL TM28ES

Código: Fábrica: Unidade:
48958 PONTO VERDE UN/1
F1 F4

UN: R\$ 34,93 AV: R\$ 34,93 15: R\$ 35,66
30: R\$ 36,38 45: R\$ 37,10 60: R\$ 37,84



PORTA LAPIS JUVENIL FEM VKG ES4299

Código: Fábrica: Unidade:
49180 PONTO VERDE UN/1
F1 F4

UN: R\$ 31,94 AV: R\$ 31,94 15: R\$ 32,60
30: R\$ 33,26 45: R\$ 33,92 60: R\$ 34,60



PORTA LAPIS JUVENIL FEM VKG 4261ES

Código: Fábrica: Unidade:
48959 PONTO VERDE UN/1
F1 F4

UN: R\$ 33,94 AV: R\$ 33,94 15: R\$ 34,64
30: R\$ 35,34 45: R\$ 36,04 60: R\$ 36,76



PORTA LAPIS JUVENIL FEM VKG 4262ES
Código: Fábrica: Unidade:
48957 PONTO VERDE UN/1
F1 F4

UN: R\$ 48,91 AV: R\$ 48,91 15: R\$ 49,93
30: R\$ 50,93 45: R\$ 51,95 60: R\$ 52,99



PORTA LAPIS JUVENIL FEM VKG 4310
Código: Fábrica: Unidade:
44399 PONTO VERDE UN/1
F1 F4

UN: R\$ 24,95 AV: R\$ 24,95 15: R\$ 25,47
30: R\$ 25,98 45: R\$ 26,50 60: R\$ 27,03



PORTA LAPIS JUVENIL SUPER HOT SBC ES3440
Código: Fábrica: Unidade:
34221 SBC UN/1
F1 F4

UN: R\$ 25,95 AV: R\$ 25,95 15: R\$ 26,49
30: R\$ 27,02 45: R\$ 27,56 60: R\$ 28,11



PORTA LAPIS JUVENIL WOOKEY ES3467
Código: Fábrica: Unidade:
34233 SBC UN/1
F1 F4

UN: R\$ 24,95 AV: R\$ 24,95 15: R\$ 25,47
30: R\$ 25,98 45: R\$ 26,50 60: R\$ 27,03



PORTA LAPIS JUVENIL WOOKEY ES3696
Código: Fábrica: Unidade:
34224 SBC UN/1
F1 F4

UN: R\$ 10,77 AV: R\$ 10,77 15: R\$ 11,00
30: R\$ 11,22 45: R\$ 11,44 60: R\$ 11,67



PORTA LAPIS LIGHTS TEEN 22CM AMARE 21966
Código: Fábrica: Unidade:
46112 ACP UN/1
F1 F4

UN: R\$ 10,77 AV: R\$ 10,77 15: R\$ 11,00
30: R\$ 11,22 45: R\$ 11,44 60: R\$ 11,67



PORTA LAPIS LIGHTS TEEN 22CM LARAN 21966
Código: Fábrica: Unidade:
46113 ACP UN/1
F1 F4

UN: R\$ 10,77 AV: R\$ 10,77 15: R\$ 11,00
30: R\$ 11,22 45: R\$ 11,44 60: R\$ 11,67



PORTA LAPIS LIGHTS TEEN 22CM PINK 21966
Código: Fábrica: Unidade:
46115 ACP UN/1
F1 F4

UN: R\$ 10,77 AV: R\$ 10,77 15: R\$ 11,00
30: R\$ 11,22 45: R\$ 11,44 60: R\$ 11,67



PORTA LAPIS LIGHTS TEEN 22CM VERDE 21966
Código: Fábrica: Unidade:
46114 ACP UN/1
F1 F4

UN: R\$ 14,97 AV: R\$ 14,97 15: R\$ 15,28
30: R\$ 15,58 45: R\$ 15,90 60: R\$ 16,21



PORTA LAPIS LONA C/VIVO GDE AZUL BCO
Código: Fábrica: Unidade:
30523 JC UN/1
F1 F4

UN: R\$ 14,97 AV: R\$ 14,97 15: R\$ 15,28
30: R\$ 15,58 45: R\$ 15,90 60: R\$ 16,21



PORTA LAPIS LONA C/VIVO GDE PTO BCO
Código: Fábrica: Unidade:
30522 JC UN/1
F1 F4

UN: R\$ 25,95 AV: R\$ 25,95 15: R\$ 26,49
30: R\$ 27,02 45: R\$ 27,56 60: R\$ 28,11



PORTA LAPIS LONA ESTAMP 1 DIV 146
Código: Fábrica: Unidade:
46700 AC BAG UN/1
F1 F4

UN: R\$ 36,93 AV: R\$ 36,93 15: R\$ 37,70
30: R\$ 38,45 45: R\$ 39,22 60: R\$ 40,01



PORTA LAPIS LONA ESTAMP 2 DIV 147
Código: Fábrica: Unidade:
46701 AC BAG UN/1
F1 F4

UN: R\$ 6,98 AV: R\$ 6,98 15: R\$ 7,12
30: R\$ 7,27 45: R\$ 7,41 60: R\$ 7,56



PORTA LAPIS LONA LISO 1 DIV 149/132
Código: Fábrica: Unidade:
46702 AC BAG UN/1
F1 F4

UN: R\$ 24,95 AV: R\$ 24,95 15: R\$ 25,47
30: R\$ 25,98 45: R\$ 26,50 60: R\$ 27,03



PORTA LAPIS LONA PRETO 125004
Código: Fábrica: Unidade:
37792 BAD BOY UN/1
F1 F4

UN: R\$ 29,94 AV: R\$ 29,94 15: R\$ 30,57
30: R\$ 31,18 45: R\$ 31,80 60: R\$ 32,44



PORTA LAPIS LONA PRETO 125204
Código: Fábrica: Unidade:
37791 BAD BOY UN/1
F1 F4

UN: R\$ 27,95 AV: R\$ 27,95 15: R\$ 28,53
30: R\$ 29,10 45: R\$ 29,68 60: R\$ 30,27



PORTA LAPIS LONA PRETO 125304

Código: Fábrika: Unidade:
37790 BAD BOY UN/1
F1 F4

UN: R\$ 27,95 AV: R\$ 27,95 15: R\$ 28,53
30: R\$ 29,10 45: R\$ 29,68 60: R\$ 30,27



PORTA LAPIS LONA PRETO 125504

Código: Fábrika: Unidade:
37793 BAD BOY UN/1
F1 F4

UN: R\$ 8,24 AV: R\$ 8,24 15: R\$ 8,41
30: R\$ 8,58 45: R\$ 8,75 60: R\$ 8,92



PORTA LAPIS LONA 1 DIV CAMUFLADO

Código: Fábrika: Unidade:
21403 KADU UN/1
F1 F4

UN: R\$ 8,24 AV: R\$ 8,24 15: R\$ 8,41
30: R\$ 8,58 45: R\$ 8,75 60: R\$ 8,92



PORTA LAPIS LONA 1 DIV CORES

Código: Fábrika: Unidade:
30514 KADU UN/1
F1 F4

UN: R\$ 14,97 AV: R\$ 14,97 15: R\$ 15,28
30: R\$ 15,58 45: R\$ 15,90 60: R\$ 16,21



PORTA LAPIS LONA 2 DIV ATLETICO

Código: Fábrika: Unidade:
28051 KADU UN/1
F1 F4

UN: R\$ 14,97 AV: R\$ 14,97 15: R\$ 15,28
30: R\$ 15,58 45: R\$ 15,90 60: R\$ 16,21



PORTA LAPIS LONA 2 DIV BARBIE

Código: Fábrika: Unidade:
23373 KADU UN/1
F1 F4

UN: R\$ 14,97 AV: R\$ 14,97 15: R\$ 15,28
30: R\$ 15,58 45: R\$ 15,90 60: R\$ 16,21



PORTA LAPIS LONA 2 DIV BAT MAN

Código: Fábrika: Unidade:
21523 KADU UN/1
F1 F4

UN: R\$ 14,97 AV: R\$ 14,97 15: R\$ 15,28
30: R\$ 15,58 45: R\$ 15,90 60: R\$ 16,21



PORTA LAPIS LONA 2 DIV BEN 10

Código: Fábrika: Unidade:
23369 KADU UN/1
F1 F4

UN: R\$ 14,97 AV: R\$ 14,97 15: R\$ 15,28
30: R\$ 15,58 45: R\$ 15,90 60: R\$ 16,21



PORTA LAPIS LONA 2 DIV CARROS

Código: Fábrika: Unidade:
26644 KADU UN/1
F1 F4

UN: R\$ 14,97 AV: R\$ 14,97 15: R\$ 15,28
30: R\$ 15,58 45: R\$ 15,90 60: R\$ 16,21



PORTA LAPIS LONA 2 DIV CRUZEIRO

Código: Fábrika: Unidade:
29819 KADU UN/1
F1 F4

UN: R\$ 14,97 AV: R\$ 14,97 15: R\$ 15,28
30: R\$ 15,58 45: R\$ 15,90 60: R\$ 16,21



PORTA LAPIS LONA 2 DIV FEM LILO & STITCH

Código: Fábrika: Unidade:
49262 KADU UN/1
F1 F4

UN: R\$ 14,97 AV: R\$ 14,97 15: R\$ 15,28
30: R\$ 15,58 45: R\$ 15,90 60: R\$ 16,21



PORTA LAPIS LONA 2 DIV FEM PATRULH CANIN

Código: Fábrika: Unidade:
49257 KADU UN/1
F1 F4

UN: R\$ 14,97 AV: R\$ 14,97 15: R\$ 15,28
30: R\$ 15,58 45: R\$ 15,90 60: R\$ 16,21



PORTA LAPIS LONA 2 DIV FEM UNICORNIO

Código: Fábrika: Unidade:
49260 KADU UN/1
F1 F4

UN: R\$ 14,97 AV: R\$ 14,97 15: R\$ 15,28
30: R\$ 15,58 45: R\$ 15,90 60: R\$ 16,21



PORTA LAPIS LONA 2 DIV FLAMENGO

Código: Fábrika: Unidade:
46927 KADU UN/1
F1 F4

UN: R\$ 14,97 AV: R\$ 14,97 15: R\$ 15,28
30: R\$ 15,58 45: R\$ 15,90 60: R\$ 16,21



PORTA LAPIS LONA 2 DIV FROZEN

Código: Fábrika: Unidade:
49258 KADU UN/1
F1 F4

UN: R\$ 14,97 AV: R\$ 14,97 15: R\$ 15,28
30: R\$ 15,58 45: R\$ 15,90 60: R\$ 16,21



PORTA LAPIS LONA 2 DIV HOMEM ARANHA

Código: Fábrika: Unidade:
23370 KADU UN/1
F1 F4

UN: R\$ 14,97 AV: R\$ 14,97 15: R\$ 15,28
30: R\$ 15,58 45: R\$ 15,90 60: R\$ 16,21



PORTA LAPIS LONA 2 DIV HOT WHEELS

Código: Fábrica: Unidade:
23371 KADU UN/1
F1 F4

UN: R\$ 14,97 AV: R\$ 14,97 15: R\$ 15,28
30: R\$ 15,58 45: R\$ 15,90 60: R\$ 16,21



PORTA LAPIS LONA 2 DIV LIGA DA JUSTICA

Código: Fábrica: Unidade:
21524 KADU UN/1
F1 F4

UN: R\$ 14,97 AV: R\$ 14,97 15: R\$ 15,28
30: R\$ 15,58 45: R\$ 15,90 60: R\$ 16,21



PORTA LAPIS LONA 2 DIV LOL

Código: Fábrica: Unidade:
49259 KADU UN/1
F1 F4

UN: R\$ 14,97 AV: R\$ 14,97 15: R\$ 15,28
30: R\$ 15,58 45: R\$ 15,90 60: R\$ 16,21



PORTA LAPIS LONA 2 DIV MARIE

Código: Fábrica: Unidade:
24749 KADU UN/1
F1 F4

UN: R\$ 14,97 AV: R\$ 14,97 15: R\$ 15,28
30: R\$ 15,58 45: R\$ 15,90 60: R\$ 16,21



PORTA LAPIS LONA 2 DIV MARIO

Código: Fábrica: Unidade:
49248 KADU UN/1
F1 F4

UN: R\$ 14,97 AV: R\$ 14,97 15: R\$ 15,28
30: R\$ 15,58 45: R\$ 15,90 60: R\$ 16,21



PORTA LAPIS LONA 2 DIV MASC COLOR

Código: Fábrica: Unidade:
31801 KADU UN/1
F1 F4

UN: R\$ 14,97 AV: R\$ 14,97 15: R\$ 15,28
30: R\$ 15,58 45: R\$ 15,90 60: R\$ 16,21



PORTA LAPIS LONA 2 DIV MASC DIVERTIDAMEN

Código: Fábrica: Unidade:
49378 KADU UN/1
F1 F4

UN: R\$ 14,97 AV: R\$ 14,97 15: R\$ 15,28
30: R\$ 15,58 45: R\$ 15,90 60: R\$ 16,21



PORTA LAPIS LONA 2 DIV MASC PATRULHA CAN

Código: Fábrica: Unidade:
49252 KADU UN/1
F1 F4

UN: R\$ 14,97 AV: R\$ 14,97 15: R\$ 15,28
30: R\$ 15,58 45: R\$ 15,90 60: R\$ 16,21



PORTA LAPIS LONA 2 DIV MASC STITCH

Código: Fábrica: Unidade:
49251 KADU UN/1
F1 F4

UN: R\$ 14,97 AV: R\$ 14,97 15: R\$ 15,28
30: R\$ 15,58 45: R\$ 15,90 60: R\$ 16,21



PORTA LAPIS LONA 2 DIV MASC YUGIOH

Código: Fábrica: Unidade:
49253 KADU UN/1
F1 F4

UN: R\$ 14,97 AV: R\$ 14,97 15: R\$ 15,28
30: R\$ 15,58 45: R\$ 15,90 60: R\$ 16,21



PORTA LAPIS LONA 2 DIV MINECRAFT

Código: Fábrica: Unidade:
49246 KADU UN/1
F1 F4

UN: R\$ 14,97 AV: R\$ 14,97 15: R\$ 15,28
30: R\$ 15,58 45: R\$ 15,90 60: R\$ 16,21



PORTA LAPIS LONA 2 DIV MINNIE

Código: Fábrica: Unidade:
49256 KADU UN/1
F1 F4

UN: R\$ 14,97 AV: R\$ 14,97 15: R\$ 15,28
30: R\$ 15,58 45: R\$ 15,90 60: R\$ 16,21



PORTA LAPIS LONA 2 DIV MORANGUINHO

Código: Fábrica: Unidade:
23377 KADU UN/1
F1 F4

UN: R\$ 14,97 AV: R\$ 14,97 15: R\$ 15,28
30: R\$ 15,58 45: R\$ 15,90 60: R\$ 16,21



PORTA LAPIS LONA 2 DIV NARUTO

Código: Fábrica: Unidade:
23372 KADU UN/1
F1 F4

UN: R\$ 14,97 AV: R\$ 14,97 15: R\$ 15,28
30: R\$ 15,58 45: R\$ 15,90 60: R\$ 16,21



PORTA LAPIS LONA 2 DIV PEQUENA SEREIA

Código: Fábrica: Unidade:
49254 KADU UN/1
F1 F4

UN: R\$ 14,97 AV: R\$ 14,97 15: R\$ 15,28
30: R\$ 15,58 45: R\$ 15,90 60: R\$ 16,21



PORTA LAPIS LONA 2 DIV PJ MASK

Código: Fábrica: Unidade:
21534 KADU UN/1
F1 F4

UN: R\$ 14,97 AV: R\$ 14,97 15: R\$ 15,28
30: R\$ 15,58 45: R\$ 15,90 60: R\$ 16,21



PORTA LAPIS LONA 2 DIV POKEMON

Código: Fábrica: Unidade:
25549 KADU UN/1
F1 F4

UN: R\$ 14,97 AV: R\$ 14,97 15: R\$ 15,28
30: R\$ 15,58 45: R\$ 15,90 60: R\$ 16,21



PORTA LAPIS LONA 2 DIV PRINCESAS

Código: Fábrica: Unidade:
21525 KADU UN/1
F1 F4

UN: R\$ 14,97 AV: R\$ 14,97 15: R\$ 15,28
30: R\$ 15,58 45: R\$ 15,90 60: R\$ 16,21



PORTA LAPIS LONA 2 DIV PRINCESINHA SOFIA

Código: Fábrica: Unidade:
49261 KADU UN/1
F1 F4

UN: R\$ 14,97 AV: R\$ 14,97 15: R\$ 15,28
30: R\$ 15,58 45: R\$ 15,90 60: R\$ 16,21



PORTA LAPIS LONA 2 DIV SONIC

Código: Fábrica: Unidade:
49249 KADU UN/1
F1 F4

UN: R\$ 14,97 AV: R\$ 14,97 15: R\$ 15,28
30: R\$ 15,58 45: R\$ 15,90 60: R\$ 16,21



PORTA LAPIS LONA 2 DIV SUPER MAN

Código: Fábrica: Unidade:
21668 KADU UN/1
F1 F4

UN: R\$ 14,97 AV: R\$ 14,97 15: R\$ 15,28
30: R\$ 15,58 45: R\$ 15,90 60: R\$ 16,21



PORTA LAPIS LONA 2 DIV VINGADORES

Código: Fábrica: Unidade:
49250 KADU UN/1
F1 F4

UN: R\$ 14,97 AV: R\$ 14,97 15: R\$ 15,28
30: R\$ 15,58 45: R\$ 15,90 60: R\$ 16,21



PORTA LAPIS LONA 2 DIV WANDINHA

Código: Fábrica: Unidade:
49255 KADU UN/1
F1 F4

UN: R\$ 14,97 AV: R\$ 14,97 15: R\$ 15,28
30: R\$ 15,58 45: R\$ 15,90 60: R\$ 16,21



PORTA LAPIS LONA 3 DIV CAMUFLADO

Código: Fábrica: Unidade:
23415 KADU UN/1
F1 F4

UN: R\$ 14,97 AV: R\$ 14,97 15: R\$ 15,28
30: R\$ 15,58 45: R\$ 15,90 60: R\$ 16,21



PORTA LAPIS LONA 3 DIV FEM COLOR

Código: Fábrica: Unidade:
23413 KADU UN/1
F1 F4

UN: R\$ 14,97 AV: R\$ 14,97 15: R\$ 15,28
30: R\$ 15,58 45: R\$ 15,90 60: R\$ 16,21



PORTA LAPIS LONA 3 DIV MASC

Código: Fábrica: Unidade:
31800 KADU UN/1
F1 F4

UN: R\$ 34,44 AV: R\$ 34,44 15: R\$ 35,16
30: R\$ 35,87 45: R\$ 36,58 60: R\$ 37,31



PORTA LAPIS MASC PATCHES 20021

Código: Fábrica: Unidade:
45945 WINTH TEEN UN/1
F1 F4

UN: R\$ 4,08 AV: R\$ 4,08 15: R\$ 4,17
30: R\$ 4,25 45: R\$ 4,34 60: R\$ 4,42



PORTA LAPIS MINI PU 692

Código: Fábrica: Unidade:
44806 WIN PAPER UN/1
F1 F4

UN: R\$ 4,08 AV: R\$ 4,08 15: R\$ 4,17
30: R\$ 4,25 45: R\$ 4,34 60: R\$ 4,42



PORTA LAPIS MINI PU 694

Código: Fábrica: Unidade:
44807 WIN PAPER UN/1
F1 F4

UN: R\$ 24,95 AV: R\$ 24,95 15: R\$ 25,47
30: R\$ 25,98 45: R\$ 26,50 60: R\$ 27,03



PORTA LAPIS NYLON 00953

Código: Fábrica: Unidade:
48585 WIN PAPER UN/1
F1 F4

UN: R\$ 8,98 AV: R\$ 8,98 15: R\$ 9,16
30: R\$ 9,35 45: R\$ 9,53 60: R\$ 9,72



PORTA LAPIS NYLON 22CM AZUL 21975AZ

Código: Fábrica: Unidade:
46119 ACP UN/1
F1 F4

UN: R\$ 8,98 AV: R\$ 8,98 15: R\$ 9,16
30: R\$ 9,35 45: R\$ 9,53 60: R\$ 9,72



PORTA LAPIS NYLON 22CM PRETO 21975PT

Código: Fábrica: Unidade:
46120 ACP UN/1
F1 F4

UN: R\$ 10,16 AV: R\$ 10,16 15: R\$ 10,38
30: R\$ 10,58 45: R\$ 10,79 60: R\$ 11,01



PORTA LAPIS PVC AZUL 55042UP-AZ
Código: 47702 Fábrica: LUXCEL Unidade: UN/1
F1 F4

UN: R\$ 7,98 AV: R\$ 7,98 15: R\$ 8,14
30: R\$ 8,31 45: R\$ 8,47 60: R\$ 8,64



PORTA LAPIS PVC NEON COLOR 27099
Código: 43449 Fábrica: CONVOY Unidade: UN/1
F1 F4

UN: R\$ 10,16 AV: R\$ 10,16 15: R\$ 10,38
30: R\$ 10,58 45: R\$ 10,79 60: R\$ 11,01



PORTA LAPIS PVC PRATA 55042UP-PR
Código: 47704 Fábrica: LUXCEL Unidade: UN/1
F1 F4

UN: R\$ 10,16 AV: R\$ 10,16 15: R\$ 10,38
30: R\$ 10,58 45: R\$ 10,79 60: R\$ 11,01



PORTA LAPIS PVC ROSA 55042UP-RA
Código: 47703 Fábrica: LUXCEL Unidade: UN/1
F1 F4

UN: R\$ 29,60 AV: R\$ 29,60 15: R\$ 30,22
30: R\$ 30,82 45: R\$ 31,44 60: R\$ 32,07



PORTA LAPIS SILICONE 20CM AZUL 21976AZ
Código: 46108 Fábrica: ACP Unidade: UN/1
F1 F4

UN: R\$ 29,60 AV: R\$ 29,60 15: R\$ 30,22
30: R\$ 30,82 45: R\$ 31,44 60: R\$ 32,07



PORTA LAPIS SILICONE 20CM LARANJA 21976L
Código: 46111 Fábrica: ACP Unidade: UN/1
F1 F4

UN: R\$ 29,60 AV: R\$ 29,60 15: R\$ 30,22
30: R\$ 30,82 45: R\$ 31,44 60: R\$ 32,07



PORTA LAPIS SILICONE 20CM PINK 21976PK
Código: 46109 Fábrica: ACP Unidade: UN/1
F1 F4

UN: R\$ 29,60 AV: R\$ 29,60 15: R\$ 30,22
30: R\$ 30,82 45: R\$ 31,44 60: R\$ 32,07



PORTA LAPIS SILICONE 20CM VERDE 21976VD
Código: 46110 Fábrica: ACP Unidade: UN/1
F1 F4

UN: R\$ 24,95 AV: R\$ 24,95 15: R\$ 25,47
30: R\$ 25,98 45: R\$ 26,50 60: R\$ 27,03



PORTA LAPIS SPORT 00955
Código: 48584 Fábrica: WIN PAPER Unidade: UN/1
F1 F4

UN: R\$ 24,95 AV: R\$ 24,95 15: R\$ 25,47
30: R\$ 25,98 45: R\$ 26,50 60: R\$ 27,03



PORTA LAPIS SPORTS 00946
Código: 48586 Fábrica: WIN PAPER Unidade: UN/1
F1 F4

UN: R\$ 11,57 AV: R\$ 11,57 15: R\$ 11,81
30: R\$ 12,05 45: R\$ 12,29 60: R\$ 12,54



PORTA LAPIS TEEN CAIRO 20CM AZUL 21964
Código: 46122 Fábrica: ACP Unidade: UN/1
F1 F4

UN: R\$ 11,57 AV: R\$ 11,57 15: R\$ 11,81
30: R\$ 12,05 45: R\$ 12,29 60: R\$ 12,54



PORTA LAPIS TEEN CAIRO 20CM LILAS 21964
Código: 46123 Fábrica: ACP Unidade: UN/1
F1 F4

UN: R\$ 11,57 AV: R\$ 11,57 15: R\$ 11,81
30: R\$ 12,05 45: R\$ 12,29 60: R\$ 12,54



PORTA LAPIS TEEN CAIRO 20CM ROSA 21964
Código: 46124 Fábrica: ACP Unidade: UN/1
F1 F4

UN: R\$ 11,57 AV: R\$ 11,57 15: R\$ 11,81
30: R\$ 12,05 45: R\$ 12,29 60: R\$ 12,54



PORTA LAPIS TEEN CAIRO 20CM VERDE 21964
Código: 46125 Fábrica: ACP Unidade: UN/1
F1 F4

UN: R\$ 9,97 AV: R\$ 9,97 15: R\$ 10,18
30: R\$ 10,39 45: R\$ 10,59 60: R\$ 10,81



PORTA LAPIS TEEN SINT AZUL 19949
Código: 35695 Fábrica: ACP Unidade: UN/1
F1 F4

UN: R\$ 9,97 AV: R\$ 9,97 15: R\$ 10,18
30: R\$ 10,39 45: R\$ 10,59 60: R\$ 10,81



PORTA LAPIS TEEN SINT BEGE 19955
Código: 35690 Fábrica: ACP Unidade: UN/1
F1 F4

UN: R\$ 5,98 AV: R\$ 5,98 15: R\$ 6,11
30: R\$ 6,23 45: R\$ 6,35 60: R\$ 6,48



PORTA LAPIS 1Z TELA 552
Código: Fábrica: Unidade:
44804 WINTH UN/1
F1 F4

UN: R\$ 12,97 AV: R\$ 12,97 15: R\$ 13,24
30: R\$ 13,50 45: R\$ 13,77 60: R\$ 14,05



PORTA LAPIS 2 DIV JEANS FEM EST DET COR
Código: Fábrica: Unidade:
34385 LITA UN/1
F1 F4

UN: R\$ 13,97 AV: R\$ 13,97 15: R\$ 14,26
30: R\$ 14,54 45: R\$ 14,83 60: R\$ 15,13



PORTA LAPIS 2 DIV LONA COLOR LISO 801
Código: Fábrica: Unidade:
26984 LITA UN/1
F1 F4

UN: R\$ 12,97 AV: R\$ 12,97 15: R\$ 13,24
30: R\$ 13,50 45: R\$ 13,77 60: R\$ 14,05



PORTA LAPIS 2 DIV LONA C/VIVO
Código: Fábrica: Unidade:
21402 JC UN/1
F1 F4

UN: R\$ 13,97 AV: R\$ 13,97 15: R\$ 14,26
30: R\$ 14,54 45: R\$ 14,83 60: R\$ 15,13



PORTA LAPIS 2 DIV LONA C/VIVO FEM PERS
Código: Fábrica: Unidade:
30515 JC UN/1
F1 F4

UN: R\$ 13,97 AV: R\$ 13,97 15: R\$ 14,26
30: R\$ 14,54 45: R\$ 14,83 60: R\$ 15,13



PORTA LAPIS 2 DIV LONA C/VIVO MASC PERS
Código: Fábrica: Unidade:
30516 JC UN/1
F1 F4

UN: R\$ 9,97 AV: R\$ 9,97 15: R\$ 10,18
30: R\$ 10,39 45: R\$ 10,59 60: R\$ 10,81



PORTA LAPIS 9CM ARAMADO RED PRETO 8244PT
Código: Fábrica: Unidade:
46334 KAZ UN/1
F1 F4

UN: R\$ 7,88 AV: R\$ 7,88 15: R\$ 8,04
30: R\$ 8,20 45: R\$ 8,37 60: R\$ 8,53



PORTA OBJETOS PLAST 10X8CM PRETO 289
Código: Fábrica: Unidade:
50157 CARBRINK UN/1
F1 F4

UN: R\$ 37,93 AV: R\$ 37,93 15: R\$ 38,72
30: R\$ 39,49 45: R\$ 40,28 60: R\$ 41,09



PORTA REVISTAS 25X8,5X30CM CRISTAL 046
Código: Fábrica: Unidade:
44681 MAXCRIL UN/1
F1 F4

UN: R\$ 5,98 AV: R\$ 5,98 15: R\$ 6,11
30: R\$ 6,23 45: R\$ 6,35 60: R\$ 6,48



POST-IT BL ADES 37X50MM 100FLS NEON 4X1
Código: Fábrica: Unidade:
42799 INTERPONTE PT/1
F1 F4

UN: R\$ 0,07 AV: R\$ 6,58 15: R\$ 6,72
30: R\$ 6,85 45: R\$ 6,99 60: R\$ 7,13



POST-IT BL ADES 37,5X50MM NEO 100FL 4X1
Código: Fábrica: Unidade:
46069 MASTERPRINT PT/100
F1 F4

UN: R\$ 0,06 AV: R\$ 5,68 15: R\$ 5,80
30: R\$ 5,92 45: R\$ 6,03 60: R\$ 6,15



POST-IT BL ADES 37,5X50MM 100FL AMAR 4X1
Código: Fábrica: Unidade:
42891 MASTERPRINT PT/100
F1 F4

UN: R\$ 5,39 AV: R\$ 5,39 15: R\$ 5,50
30: R\$ 5,61 45: R\$ 5,73 60: R\$ 5,84

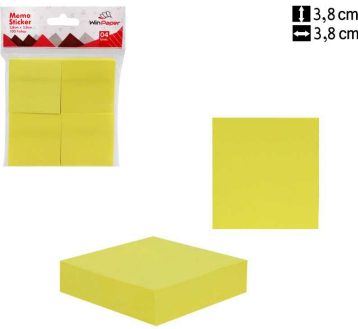

POST-IT BL ADES 38X38MM 100F 4X1
Código: Fábrica: Unidade:
40320 WINCY PT/1
F1 F4

UN: R\$ 6,98 AV: R\$ 6,98 15: R\$ 7,12
30: R\$ 7,27 45: R\$ 7,41 60: R\$ 7,56



POST-IT BL ADES 38X38MM 85406 4X1
Código: Fábrica: Unidade:
42800 INTERPONTE PT/1
F1 F4

UN: R\$ 2,37 AV: R\$ 9,47 15: R\$ 9,67
30: R\$ 9,87 45: R\$ 10,06 60: R\$ 10,26



POST-IT BL ADES 38X50MM 100FLS ROSA 4X1
Código: Fábrica: Unidade:
46372 JOCAROFFICE PT/4
F1 F4

UN: R\$ 2,37 AV: R\$ 9,47 15: R\$ 9,67
30: R\$ 9,87 45: R\$ 10,06 60: R\$ 10,26



POST-IT BL ADES 38X50MM 100FLS VERDE 4X1
Código: Fábrica: Unidade:
46371 JOCAROFFICE PT/4
F1 F4

UN: R\$ 1,63 AV: R\$ 6,54 15: R\$ 6,68
30: R\$ 6,81 45: R\$ 6,95 60: R\$ 7,08



POST-IT BL ADES 38X50MM 100FLS 4X1
Código: Fábrika: Unidade:
44106 FUTURO PT/4
F1 F4

UN: R\$ 1,66 AV: R\$ 6,65 15: R\$ 6,79
30: R\$ 6,92 45: R\$ 7,06 60: R\$ 7,20



POST-IT BL ADES 38X50MM 100FLS 4X1
Código: Fábrika: Unidade:
45227 JOCAROFFICE PT/4
F1 F4

UN: R\$ 1,61 AV: R\$ 6,43 15: R\$ 6,56
30: R\$ 6,69 45: R\$ 6,83 60: R\$ 6,97



POST-IT BL ADES 38X50MM 100FLS 4X1
Código: Fábrika: Unidade:
43090 PLANETA PT/4
F1 F4

UN: R\$ 1,84 AV: R\$ 7,38 15: R\$ 7,53
30: R\$ 7,68 45: R\$ 7,84 60: R\$ 7,99



POST-IT BL ADES 38X50MM 100FLS 4X1
Código: Fábrika: Unidade:
41945 OFF PAPER PT/4
F1 F4

UN: R\$ 0,01 AV: R\$ 4,14 15: R\$ 4,23
30: R\$ 4,31 45: R\$ 4,40 60: R\$ 4,49



POST-IT BL ADES 38X50MM 3CORES 400FLS
Código: Fábrika: Unidade:
48327 BAZZE PT/400
F1 F4

UN: R\$ 1,25 AV: R\$ 4,98 15: R\$ 5,09
30: R\$ 5,19 45: R\$ 5,29 60: R\$ 5,40



POST-IT BL ADES 38X51MM 100F 3801 4X1
Código: Fábrika: Unidade:
34129 BRW PT/4
F1 F4

UN: R\$ 0,97 AV: R\$ 3,88 15: R\$ 3,96
30: R\$ 4,04 45: R\$ 4,12 60: R\$ 4,21



POST-IT BL ADES 38X51MM 50FL 3850 4X1
Código: Fábrika: Unidade:
38014 BRW PT/4
F1 F4

UN: R\$ 1,26 AV: R\$ 6,28 15: R\$ 6,41
30: R\$ 6,54 45: R\$ 6,67 60: R\$ 6,80



POST-IT BL ADES 50X50MM 250FL 5050 5X1
Código: Fábrika: Unidade:
46828 BRW PT/5
F1 F4

UN: R\$ 2,55 AV: R\$ 10,18 15: R\$ 10,40
30: R\$ 10,60 45: R\$ 10,82 60: R\$ 11,03



POST-IT BL ADES 50X50MM 400FL COSMOS 4X1
Código: Fábrika: Unidade:
49500 TRIS PT/4
F1 F4

UN: R\$ 1,74 AV: R\$ 6,98 15: R\$ 7,12
30: R\$ 7,27 45: R\$ 7,41 60: R\$ 7,56

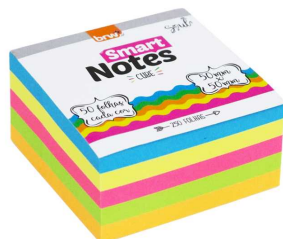

POST-IT BL ADES 50X50MM 400FL KRAFT 4X1
Código: Fábrika: Unidade:
49499 TRIS PT/4
F1 F4

UN: R\$ 2,99 AV: R\$ 2,99 15: R\$ 3,05
30: R\$ 3,11 45: R\$ 3,17 60: R\$ 3,23



POST-IT BL ADES 75X75MM 100FL AMARE 2010
Código: Fábrika: Unidade:
45122 MASTERPRINT UN/1
F1 F4

UN: R\$ 2,99 AV: R\$ 2,99 15: R\$ 3,05
30: R\$ 3,11 45: R\$ 3,17 60: R\$ 3,23



POST-IT BL ADES 75X75MM 100FL AZUL 2013
Código: Fábrika: Unidade:
47209 MASTERPRINT UN/1
F1 F4

UN: R\$ 2,99 AV: R\$ 2,99 15: R\$ 3,05
30: R\$ 3,11 45: R\$ 3,17 60: R\$ 3,23



POST-IT BL ADES 75X75MM 100FL ROSA 2011
Código: Fábrika: Unidade:
47210 MASTERPRINT UN/1
F1 F4

UN: R\$ 2,99 AV: R\$ 2,99 15: R\$ 3,05
30: R\$ 3,11 45: R\$ 3,17 60: R\$ 3,23



POST-IT BL ADES 75X75MM 100FL VERDE 2012
Código: Fábrika: Unidade:
47211 MASTERPRINT UN/1
F1 F4

UN: R\$ 25,95 AV: R\$ 25,95 15: R\$ 26,49
30: R\$ 27,02 45: R\$ 27,56 60: R\$ 28,11



POST-IT BL ADES 75X75MM 495FLS 53105
Código: Fábrika: Unidade:
46445 INTERPONTE PT/1
F1 F4

UN: R\$ 2,99 AV: R\$ 2,99 15: R\$ 3,05
30: R\$ 3,11 45: R\$ 3,17 60: R\$ 3,23



POST-IT BL ADES 75X75MM 50FL TRANSP 584
Código: Fábrika: Unidade:
49504 TRIS PT/1
F1 F4

UN: R\$ 4,45 AV: R\$ 4,45 15: R\$ 4,55
30: R\$ 4,64 45: R\$ 4,73 60: R\$ 4,82



POST-IT BL ADES 75X75MM 50FLS TRANSP 415
Código: Fábrica: Unidade:
46443 INTERPONTE PT/1
F1 F4

UN: R\$ 0,04 AV: R\$ 3,58 15: R\$ 3,66
30: R\$ 3,73 45: R\$ 3,81 60: R\$ 3,88



POST-IT BL ADES 76X102MM AMARELO 100FLS
Código: Fábrica: Unidade:
48328 BAZZE PT/100
F1 F4

UN: R\$ 7,98 AV: R\$ 7,98 15: R\$ 8,14
30: R\$ 8,31 45: R\$ 8,47 60: R\$ 8,64



POST-IT BL ADES 76X102MM 100FLS
Código: Fábrica: Unidade:
41904 LIKE UN/1
F1 F4

UN: R\$ 7,88 AV: R\$ 7,88 15: R\$ 8,04
30: R\$ 8,20 45: R\$ 8,37 60: R\$ 8,53



POST-IT BL ADES 76X102MM 100FLS
Código: Fábrica: Unidade:
46373 JOCAROFFICE UN/1
F1 F4

UN: R\$ 4,28 AV: R\$ 4,28 15: R\$ 4,37
30: R\$ 4,46 45: R\$ 4,55 60: R\$ 4,64



POST-IT BL ADES 76X102MM 100FLS 2020
Código: Fábrica: Unidade:
45121 MASTERPRINT UN/1
F1 F4

UN: R\$ 6,25 AV: R\$ 6,25 15: R\$ 6,38
30: R\$ 6,51 45: R\$ 6,64 60: R\$ 6,77



POST-IT BL ADES 76X127MM 100FLS CORES
Código: Fábrica: Unidade:
46442 INTERPONTE PT/1
F1 F4

UN: R\$ 0,03 AV: R\$ 2,99 15: R\$ 3,05
30: R\$ 3,11 45: R\$ 3,17 60: R\$ 3,23



POST-IT BL ADES 76X76MM AMARELO 100FLS
Código: Fábrica: Unidade:
48326 BAZZE PT/100
F1 F4

UN: R\$ 0,04 AV: R\$ 8,98 15: R\$ 9,16
30: R\$ 9,35 45: R\$ 9,53 60: R\$ 9,72



POST-IT BL ADES 76X76MM 200FLS 7601
Código: Fábrica: Unidade:
46829 BRW PT/200
F1 F4

UN: R\$ 0,03 AV: R\$ 13,73 15: R\$ 14,01
30: R\$ 14,29 45: R\$ 14,58 60: R\$ 14,87



POST-IT BL ADES 76X76MM 4CORES 400FLS
Código: Fábrica: Unidade:
48325 BAZZE PT/400
F1 F4

UN: R\$ 0,02 AV: R\$ 2,39 15: R\$ 2,44
30: R\$ 2,48 45: R\$ 2,53 60: R\$ 2,59



POST-IT MARCA PAG NEON RETO 25F 2030 5X1
Código: Fábrica: Unidade:
42245 MASTERPRINT PT/125
F1 F4

UN: R\$ 0,48 AV: R\$ 2,39 15: R\$ 2,44
30: R\$ 2,48 45: R\$ 2,53 60: R\$ 2,59



POST-IT MARCA PAG NEON SETA 25F 2031 5X1
Código: Fábrica: Unidade:
43615 MASTERPRINT PT/5
F1 F4

UN: R\$ 4,98 AV: R\$ 4,98 15: R\$ 5,09
30: R\$ 5,19 45: R\$ 5,29 60: R\$ 5,40



POST-IT MARCA PAG SETA NEON 125F 12X44MM
Código: Fábrica: Unidade:
43196 BRW CR/1
F1 F4

UN: R\$ 2,20 AV: R\$ 2,20 15: R\$ 2,24
30: R\$ 2,29 45: R\$ 2,33 60: R\$ 2,38



POST-IT MARCA PAG SETA 125F 4.4X1,2CM
Código: Fábrica: Unidade:
50965 IMPORIENTE CR/1
F1 F4

UN: R\$ 9,97 AV: R\$ 9,97 15: R\$ 10,18
30: R\$ 10,39 45: R\$ 10,59 60: R\$ 10,81



POST-IT MARCA PAG SETA 15F 91128 10X1
Código: Fábrica: Unidade:
46374 JOCAROFFICE CR/1
F1 F4

UN: R\$ 3,58 AV: R\$ 3,58 15: R\$ 3,66
30: R\$ 3,73 45: R\$ 3,81 60: R\$ 3,88



POST-IT MARCA PAG SETA 25F 49032 6X1
Código: Fábrica: Unidade:
46251 IMPORIENTE CR/1
F1 F4

UN: R\$ 1,07 AV: R\$ 5,35 15: R\$ 5,46
30: R\$ 5,57 45: R\$ 5,68 60: R\$ 5,80



POST-IT MARCA PAG 20FLS 5X1
Código: Fábrica: Unidade:
43091 PLANETA PT/5
F1 F4

UN: R\$ 5,35 AV: R\$ 5,35 15: R\$ 5,46
30: R\$ 5,57 45: R\$ 5,68 60: R\$ 5,80



POST-IT MARCA PAG 25X76MM 100FLS 4X1
Código: Fábrica: Unidade:
42801 INTERPONTE PT/1
F1 F4

UN: R\$ 1,34 AV: R\$ 5,34 15: R\$ 5,45
30: R\$ 5,56 45: R\$ 5,67 60: R\$ 5,79



POST-IT MARCA PAGINAS AD 19X76MM 4X1
Código: Fábrica: Unidade:
42409 BRW PT/4
F1 F4

UN: R\$ 0,05 AV: R\$ 8,78 15: R\$ 8,96
30: R\$ 9,14 45: R\$ 9,32 60: R\$ 9,51



POST-IT MARCA PAG+REGUA 12X44MM 02 175X1
Código: Fábrica: Unidade:
36115 BRW PT/175
F1 F4

UN: R\$ 0,02 AV: R\$ 4,98 15: R\$ 5,09
30: R\$ 5,19 45: R\$ 5,29 60: R\$ 5,40



POST-IT MARCA PAG+REGUA 12X45MM 8X25
Código: Fábrica: Unidade:
48142 YIN'S PAPER PT/200
F1 F4

UN: R\$ 18,32 AV: R\$ 18,32 15: R\$ 18,70
30: R\$ 19,08 45: R\$ 19,46 60: R\$ 19,85



PRANCHETA ACR A4 CRISTAL PREND METAL 120
Código: Fábrica: Unidade:
43211 ACRINIL UN/1
F1 F4

UN: R\$ 22,96 AV: R\$ 22,96 15: R\$ 23,44
30: R\$ 23,91 45: R\$ 24,39 60: R\$ 24,88



PRANCHETA ACR A4 POP PREND PLAST 131
Código: Fábrica: Unidade:
37441 ACRIMET UN/1
F1 F4

UN: R\$ 22,46 AV: R\$ 22,46 15: R\$ 22,93
30: R\$ 23,39 45: R\$ 23,86 60: R\$ 24,34



PRANCHETA ACR A4 PREND METAL 131
Código: Fábrica: Unidade:
21130 NOVACR/ACRIM UN/1
F1 F4

UN: R\$ 18,96 AV: R\$ 18,96 15: R\$ 19,35
30: R\$ 19,74 45: R\$ 20,14 60: R\$ 20,54



PRANCHETA ACR OF CRISTAL PREND MET 930.3
Código: Fábrica: Unidade:
40478 MAXCRIL UN/1
F1 F4

UN: R\$ 23,95 AV: R\$ 23,95 15: R\$ 24,45
30: R\$ 24,94 45: R\$ 25,44 60: R\$ 25,95



PRANCHETA ACR OF CRISTAL PREND PLAST
Código: Fábrica: Unidade:
41965 CARBRINK UN/1
F1 F4

UN: R\$ 18,96 AV: R\$ 18,96 15: R\$ 19,35
30: R\$ 19,74 45: R\$ 20,14 60: R\$ 20,54



PRANCHETA ACR OF FUME PREND METAL 930.1
Código: Fábrica: Unidade:
40479 MAXCRIL UN/1
F1 F4

UN: R\$ 11,97 AV: R\$ 11,97 15: R\$ 12,22
30: R\$ 12,46 45: R\$ 12,71 60: R\$ 12,97



PRANCHETA ACR OF PRETA PREND PLAST C/RE
Código: Fábrica: Unidade:
42411 CARBRINK UN/1
F1 F4

UN: R\$ 17,22 AV: R\$ 17,22 15: R\$ 17,58
30: R\$ 17,93 45: R\$ 18,29 60: R\$ 18,66



PRANCHETA ACR OF PRETA PREND PLAST 5038
Código: Fábrica: Unidade:
41796 CARBRINK UN/1
F1 F4

UN: R\$ 16,87 AV: R\$ 16,87 15: R\$ 17,22
30: R\$ 17,57 45: R\$ 17,92 60: R\$ 18,28



PRANCHETA ACR 1/2 OF CRISTAL P METAL 130
Código: Fábrica: Unidade:
46004 ACRINIL UN/1
F1 F4

UN: R\$ 19,97 AV: R\$ 19,97 15: R\$ 20,38
30: R\$ 20,79 45: R\$ 21,21 60: R\$ 21,63



PRANCHETA ACR 1/2 OF FUME P METAL 920.1
Código: Fábrica: Unidade:
40879 ACRIMET UN/1
F1 F4

UN: R\$ 7,98 AV: R\$ 7,98 15: R\$ 8,14
30: R\$ 8,31 45: R\$ 8,47 60: R\$ 8,64



PRANCHETA EUCATEX OF PREND METAL
Código: Fábrica: Unidade:
42186 BACCHI UN/1
F1 F4

UN: R\$ 7,12 AV: R\$ 7,12 15: R\$ 7,27
30: R\$ 7,41 45: R\$ 7,56 60: R\$ 7,71



PRANCHETA EUCATEX OF PREND METAL 501
Código: Fábrica: Unidade:
49833 CAVIA UN/1
F1 F4

UN: R\$ 6,08 AV: R\$ 6,08 15: R\$ 6,21
30: R\$ 6,33 45: R\$ 6,46 60: R\$ 6,59



PRANCHETA EUCATEX 1/2 OF PREND METAL 502
Código: Fábrika: Unidade:
49832 CAVIA UN/1
F1 F4

UN: R\$ 8,98 AV: R\$ 8,98 15: R\$ 9,16
30: R\$ 9,35 45: R\$ 9,53 60: R\$ 9,72



PRANCHETA INF CANET+PAPEL 16X23CM 603397
Código: Fábrika: Unidade:
32579 MAX PING UN/1
F1 F4

UN: R\$ 7,98 AV: R\$ 7,98 15: R\$ 8,14
30: R\$ 8,31 45: R\$ 8,47 60: R\$ 8,64



PRANCHETA MDF CRU OF PREND METAL 8289
Código: Fábrika: Unidade:
44671 STALO UN/1
F1 F4

UN: R\$ 14,20 AV: R\$ 14,20 15: R\$ 14,49
30: R\$ 14,78 45: R\$ 15,08 60: R\$ 15,38



PRANCHETA PLAST A4 PRETA PREND METAL 050
Código: Fábrika: Unidade:
50155 CARBRINK UN/1
F1 F4

UN: R\$ 8,74 AV: R\$ 8,74 15: R\$ 8,92
30: R\$ 9,10 45: R\$ 9,28 60: R\$ 9,46



PRANCHETA POLIONDA CRISTAL
Código: Fábrika: Unidade:
46076 ALAPLAST UN/1
F1 F4

UN: R\$ 8,74 AV: R\$ 8,74 15: R\$ 8,92
30: R\$ 9,10 45: R\$ 9,28 60: R\$ 9,46



PRANCHETA POLIONDA FUME
Código: Fábrika: Unidade:
46078 ALAPLAST UN/1
F1 F4

UN: R\$ 8,74 AV: R\$ 8,74 15: R\$ 8,92
30: R\$ 9,10 45: R\$ 9,28 60: R\$ 9,46



PRANCHETA POLIONDA PRETA
Código: Fábrika: Unidade:
46077 ALAPLAST UN/1
F1 F4

UN: R\$ 15,96 AV: R\$ 15,96 15: R\$ 16,30
30: R\$ 16,62 45: R\$ 16,96 60: R\$ 17,29



PRANCHETA PS A4 CRISTAL PREND METAL 8358
Código: Fábrika: Unidade:
48149 YIN'S PAPER UN/1
F1 F4

UN: R\$ 15,96 AV: R\$ 15,96 15: R\$ 16,30
30: R\$ 16,62 45: R\$ 16,96 60: R\$ 17,29



PRANCHETA PS A4 FUME PREND METAL 8356
Código: Fábrika: Unidade:
48150 YIN'S PAPER UN/1
F1 F4

UN: R\$ 5,08 AV: R\$ 60,95 15: R\$ 62,22
30: R\$ 63,47 45: R\$ 64,74 60: R\$ 66,03



PRENDEDOR ZINCADO P/PAPEL 75MM 175 12X1
Código: Fábrika: Unidade:
49834 CAVIA PT/12
F1 F4

UN: R\$ 7,49 AV: R\$ 89,85 15: R\$ 91,72
30: R\$ 93,55 45: R\$ 95,42 60: R\$ 97,33



PRENDEDOR ZINCADO P/PAPEL 75MM 192 12X1
Código: Fábrika: Unidade:
45415 CARBRINK PT/12
F1 F4

UN: R\$ 12,31 AV: R\$ 147,76 15: R\$ 150,84
30: R\$ 153,86 45: R\$ 156,94 60: R\$ 160,07



PRENDEDOR ZINCADO P/PAPEL 95MM 190 12X1
Código: Fábrika: Unidade:
45414 CARBRINK PT/12
F1 F4

UN: R\$ 22,21 AV: R\$ 22,21 15: R\$ 22,68
30: R\$ 23,13 45: R\$ 23,59 60: R\$ 24,07



PRIMER P/METAL/PET/VIDR 100 ML 519 BCO
Código: Fábrika: Unidade:
44113 ACRILEX UN/1
F1 F4

UN: R\$ 5,49 AV: R\$ 109,81 15: R\$ 112,10
30: R\$ 114,34 45: R\$ 116,63 60: R\$ 118,96



PROTETOR ACRILICO P/RG 0,050MM 20X1
Código: Fábrika: Unidade:
44604 MAXIPLASTICO PT/20
F1 F4

UN: R\$ 3,00 AV: R\$ 29,95 15: R\$ 30,58
30: R\$ 31,19 45: R\$ 31,81 60: R\$ 32,45



PROTETOR ACRILICO RIGIDO CNH 10X1
Código: Fábrika: Unidade:
30085 MP PT/10
F1 F4

UN: R\$ 0,65 AV: R\$ 12,97 15: R\$ 13,24
30: R\$ 13,50 45: R\$ 13,77 60: R\$ 14,05



PROTETOR A1 P/CRACHA CRISTAL 10X7CM 20X1
Código: Fábrika: Unidade:
41975 VMP PT/20
F1 F4

UN: R\$ 0,70 AV: R\$ 6,98 15: R\$ 7,12
30: R\$ 7,27 45: R\$ 7,41 60: R\$ 7,56



PROTETOR PLAST P/CD 13X13CM P-17 10X1

Código: 46176 Fábrica: ACP Unidade: PT/10 F1 F4

UN: R\$ 0,48 AV: R\$ 47,91 15: R\$ 48,91
30: R\$ 49,89 45: R\$ 50,89 60: R\$ 51,91



PROTETOR PORTA DOCUMENT 70X105CM P7 100X1

Código: 46203 Fábrica: ACP Unidade: PT/100 F1 F4

UN: R\$ 0,36 AV: R\$ 35,84 15: R\$ 36,59
30: R\$ 37,32 45: R\$ 38,07 60: R\$ 38,83



PROTETOR PORTA DOCUMENT 65X90CM P6 100X1

Código: 46202 Fábrica: ACP Unidade: PT/100 F1 F4

UN: R\$ 11,97 AV: R\$ 11,97 15: R\$ 12,22
30: R\$ 12,46 45: R\$ 12,71 60: R\$ 12,97



PROTETOR PORTIF A4 10 PLAST PRETO

Código: 44595 Fábrica: MAXIPLASTICO Unidade: UN/1 F1 F4

UN: R\$ 17,47 AV: R\$ 17,47 15: R\$ 17,84
30: R\$ 18,19 45: R\$ 18,56 60: R\$ 18,93



PROTETOR PORTIF A4 30 PLAST PRETO

Código: 44596 Fábrica: MAXIPLASTICO Unidade: UN/1 F1 F4

UN: R\$ 19,96 AV: R\$ 19,96 15: R\$ 20,37
30: R\$ 20,78 45: R\$ 21,20 60: R\$ 21,62



PROTETOR PORTIF A4 50 PLAST PRETO

Código: 44597 Fábrica: MAXIPLASTICO Unidade: UN/1 F1 F4

UN: R\$ 21,95 AV: R\$ 21,95 15: R\$ 22,41
30: R\$ 22,86 45: R\$ 23,32 60: R\$ 23,78



PROTETOR PORTIF A4 50 PLAST VERMELHO

Código: 44601 Fábrica: MAXIPLASTICO Unidade: UN/1 F1 F4

UN: R\$ 29,94 AV: R\$ 29,94 15: R\$ 30,57
30: R\$ 31,18 45: R\$ 31,80 60: R\$ 32,44



PROTETOR PORTIF A4 100 PLAST PRETO

Código: 44598 Fábrica: MAXIPLASTICO Unidade: UN/1 F1 F4

UN: R\$ 5,99 AV: R\$ 119,80 15: R\$ 122,29
30: R\$ 124,74 45: R\$ 127,23 60: R\$ 129,78



PROTOTETOR ACRILICO P/DUT 0,050MM 20X1

Código: 44602 Fábrica: MAXIPLASTICO Unidade: PT/20 F1 F4

UN: R\$ 1,99 AV: R\$ 23,84 15: R\$ 24,34
30: R\$ 24,83 45: R\$ 25,32 60: R\$ 25,83



PURPURINA 3 GRS DOURADO 12X1

Código: 15075 Fábrica: CITY BRILHO Unidade: CX/12 F1 F4

UN: R\$ 1,99 AV: R\$ 23,84 15: R\$ 24,34
30: R\$ 24,83 45: R\$ 25,32 60: R\$ 25,83



PURPURINA 3 GRS PRATA 12X1

Código: 15076 Fábrica: CITY BRILHO Unidade: CX/12 F1 F4

UN: R\$ 109,81 AV: R\$ 109,81 15: R\$ 112,10
30: R\$ 114,34 45: R\$ 116,63 60: R\$ 118,96



PURPURINA 500 GRS DOURADO

Código: 44253 Fábrica: TOK BIJOUXS Unidade: PT/1 F1 F4

UN: R\$ 109,81 AV: R\$ 109,81 15: R\$ 112,10
30: R\$ 114,34 45: R\$ 116,63 60: R\$ 118,96



PURPURINA 500 GRS PRATA

Código: 44254 Fábrica: TOK BIJOUXS Unidade: PT/1 F1 F4

UN: R\$ 219,64 AV: R\$ 219,64 15: R\$ 224,21
30: R\$ 228,70 45: R\$ 233,27 60: R\$ 237,94



QUADRO AVISO CORTIC ALUM A 120X90CM 8213

Código: 45817 Fábrica: STALO Unidade: UN/1 F1 F4

UN: R\$ 244,60 AV: R\$ 244,60 15: R\$ 249,69
30: R\$ 254,69 45: R\$ 259,78 60: R\$ 264,98



QUADRO AVISO CORTIC ALUM 120X90CM

Código: 42601 Fábrica: STALO Unidade: UN/1 F1 F4

UN: R\$ 181,93 AV: R\$ 181,93 15: R\$ 185,72
30: R\$ 189,43 45: R\$ 193,22 60: R\$ 197,09



QUADRO AVISO CORTIC ALUM 120X90CM 2012

Código: 46803 Fábrica: CORTIARTE Unidade: UN/1 F1 F4

UN: R\$ 139,77 AV: R\$ 139,77 15: R\$ 142,68
30: R\$ 145,53 45: R\$ 148,44 60: R\$ 151,41



QUADRO AVISO CORTIC ALUM 90X60CM 9329
Código: Fábrica: Unidade:
42600 STALO UN/1
F1 F4

UN: R\$ 109,81 AV: R\$ 109,81 15: R\$ 112,10
30: R\$ 114,34 45: R\$ 116,63 60: R\$ 118,96

↑ 70 cm
↔ 100 cm



QUADRO AVISO CORTIC MAD 100X70CM
Código: Fábrica: Unidade:
42853 STALO UN/1
F1 F4

UN: R\$ 419,32 AV: R\$ 419,32 15: R\$ 428,05
30: R\$ 436,61 45: R\$ 445,35 60: R\$ 454,25

↔ 200 cm
↑ 120 cm



QUADRO AVISO CORTIC MAD 120X200CM 1024
Código: Fábrica: Unidade:
49218 CORTIARTE UN/1
F1 F4

UN: R\$ 174,71 AV: R\$ 174,71 15: R\$ 178,35
30: R\$ 181,92 45: R\$ 185,56 60: R\$ 189,27

↔ 90 cm
↑ 120 cm



QUADRO AVISO CORTIC MAD 120X90CM 1021
Código: Fábrica: Unidade:
45635 CORTIARTE UN/1
F1 F4

UN: R\$ 178,70 AV: R\$ 178,70 15: R\$ 182,43
30: R\$ 186,08 45: R\$ 189,80 60: R\$ 193,59

↑ 90 cm
↔ 120 cm

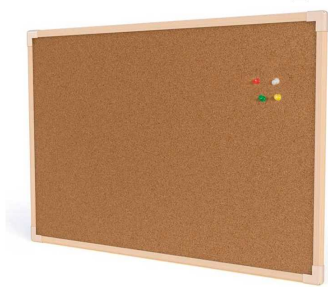

QUADRO AVISO CORTIC MAD 120X90CM 9341
Código: Fábrica: Unidade:
41954 STALO UN/1
F1 F4

UN: R\$ 62,40 AV: R\$ 62,40 15: R\$ 63,70
30: R\$ 64,97 45: R\$ 66,27 60: R\$ 67,60

↑ 40 cm
↔ 60 cm



QUADRO AVISO CORTIC MAD 60X40CM 9333
Código: Fábrica: Unidade:
44150 STALO UN/1
F1 F4

UN: R\$ 89,85 AV: R\$ 89,85 15: R\$ 91,72
30: R\$ 93,55 45: R\$ 95,42 60: R\$ 97,33

↑ 60 cm
↔ 90 cm



QUADRO AVISO CORTIC MAD 90X60CM
Código: Fábrica: Unidade:
42084 STALO UN/1
F1 F4

UN: R\$ 66,39 AV: R\$ 66,39 15: R\$ 67,78
30: R\$ 69,13 45: R\$ 70,52 60: R\$ 71,93

↑ 40 cm
↔ 60 cm



QUADRO AVISO CORTIC MDF ALUM 060X040CM
Código: Fábrica: Unidade:
44146 STALO UN/1
F1 F4

UN: R\$ 78,52 AV: R\$ 78,52 15: R\$ 80,16
30: R\$ 81,76 45: R\$ 83,40 60: R\$ 85,07

↑ 50 cm
↔ 70 cm



QUADRO AVISO CORTIC MDF ALUM 070X050CM
Código: Fábrica: Unidade:
44148 STALO UN/1
F1 F4

UN: R\$ 103,82 AV: R\$ 103,82 15: R\$ 105,99
30: R\$ 108,11 45: R\$ 110,27 60: R\$ 112,47



QUADRO AVISO CORTIC MDF ALUM 090X060CM
Código: Fábrica: Unidade:
42602 STALO UN/1
F1 F4

UN: R\$ 166,73 AV: R\$ 166,73 15: R\$ 170,21
30: R\$ 173,61 45: R\$ 177,08 60: R\$ 180,62

↑ 70 cm
↔ 100 cm



QUADRO AVISO CORTIC MDF ALUM 100X70CM
Código: Fábrica: Unidade:
44145 STALO UN/1
F1 F4

UN: R\$ 229,62 AV: R\$ 229,62 15: R\$ 234,41
30: R\$ 239,09 45: R\$ 243,88 60: R\$ 248,75

↑ 90 cm
↔ 120 cm

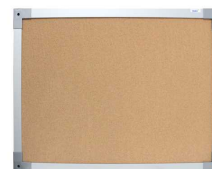

QUADRO AVISO CORTIC MDF ALUM 120X90CM
Código: Fábrica: Unidade:
44153 STALO UN/1
F1 F4

UN: R\$ 95,84 AV: R\$ 95,84 15: R\$ 97,83
30: R\$ 99,79 45: R\$ 101,79 60: R\$ 103,82

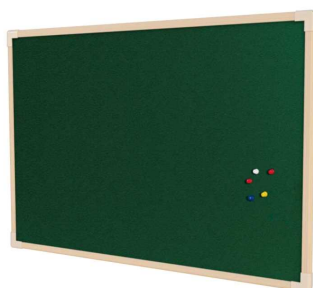

QUADRO AVISO FELTRO MAD 90X60CM
Código: Fábrica: Unidade:
43005 STALO UN/1
F1 F4

UN: R\$ 215,75 AV: R\$ 215,75 15: R\$ 220,25
30: R\$ 224,65 45: R\$ 229,15 60: R\$ 233,73

↔ 120 cm
↑ 90 cm

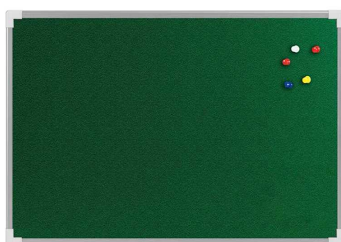

QUADRO AVISO FELTRO MDF AL 120X90CM 5095
Código: Fábrica: Unidade:
50158 STALO UN/1
F1 F4

UN: R\$ 115,17 AV: R\$ 115,17 15: R\$ 117,56
30: R\$ 119,92 45: R\$ 122,31 60: R\$ 124,76

↑ 60 cm
↔ 90 cm



QUADRO AVISO FELTRO STD ALUM 90X60CM
Código: Fábrica: Unidade:
45637 CORTIARTE UN/1
F1 F4

UN: R\$ 314,23 AV: R\$ 314,23 15: R\$ 320,77
30: R\$ 327,19 45: R\$ 333,73 60: R\$ 340,41

↑ 90 cm
↔ 120 cm

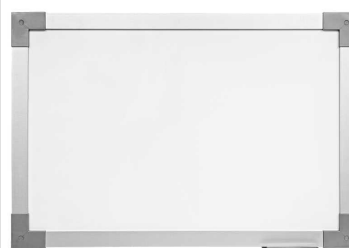

QUADRO BCO MAGN MDF ALUM 120X90CM 4062
Código: Fábrica: Unidade:
44673 STALO UN/1
F1 F4

UN: R\$ 499,19 AV: R\$ 499,19 15: R\$ 509,59
30: R\$ 519,78 45: R\$ 530,18 60: R\$ 540,78

150cm
120cm

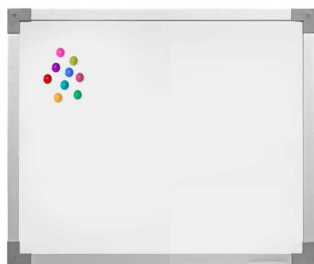

QUADRO BCO MAGN MDF ALUM 150X120CM 4243

Código: Fábrica: Unidade:
50159 STALO UN/1
F1 F4

UN: R\$ 151,73 AV: R\$ 151,73 15: R\$ 154,89
30: R\$ 157,99 45: R\$ 161,15 60: R\$ 164,37

60cm
90cm



QUADRO BCO MAGN MDF ALUM 90X60CM 4061

Código: Fábrica: Unidade:
44672 STALO UN/1
F1 F4

UN: R\$ 79,86 AV: R\$ 79,86 15: R\$ 81,53
30: R\$ 83,16 45: R\$ 84,82 60: R\$ 86,52



QUADRO BCO PLANEJ MENSAL MAD 90X60CM

Código: Fábrica: Unidade:
50335 SOUZA UN/1
F1 F4

UN: R\$ 236,61 AV: R\$ 236,61 15: R\$ 241,54
30: R\$ 246,37 45: R\$ 251,30 60: R\$ 256,32

200cm
120cm



QUADRO BRANCO MADEIRA 200X120CM 1323

Código: Fábrica: Unidade:
49472 CORTIARTE UN/1
F1 F4

UN: R\$ 312,63 AV: R\$ 312,63 15: R\$ 319,14
30: R\$ 325,52 45: R\$ 332,04 60: R\$ 338,68

60cm
90cm



QUADRO BRANCO MAG POP ALUM 120X90CM 64

Código: Fábrica: Unidade:
49131 CORTIARTE UN/1
F1 F4

UN: R\$ 121,94 AV: R\$ 121,94 15: R\$ 124,49
30: R\$ 126,97 45: R\$ 129,51 60: R\$ 132,10

90cm
120cm



QUADRO BRANCO POP ALUM 120X90CM 2321

Código: Fábrica: Unidade:
46802 CORTIARTE UN/1
F1 F4

UN: R\$ 277,12 AV: R\$ 277,12 15: R\$ 282,89
30: R\$ 288,55 45: R\$ 294,32 60: R\$ 300,20

120cm
200cm



QUADRO BRANCO POP ALUM 200X120CM 2327

Código: Fábrica: Unidade:
45636 CORTIARTE UN/1
F1 F4

UN: R\$ 127,79 AV: R\$ 127,79 15: R\$ 130,45
30: R\$ 133,06 45: R\$ 135,72 60: R\$ 138,43

70 cm
100 cm



QUADRO BRANCO UV ALUM 100X70CM 9123

Código: Fábrica: Unidade:
44144 STALO UN/1
F1 F4

UN: R\$ 139,77 AV: R\$ 139,77 15: R\$ 142,68
30: R\$ 145,53 45: R\$ 148,44 60: R\$ 151,41

90 cm
120 cm



QUADRO BRANCO UV ALUM 120X090CM 9124

Código: Fábrica: Unidade:
44152 STALO UN/1
F1 F4

UN: R\$ 349,43 AV: R\$ 349,43 15: R\$ 356,71
30: R\$ 363,84 45: R\$ 371,12 60: R\$ 378,54

120 cm
200 cm



QUADRO BRANCO UV ALUM 200X120CM 8365

Código: Fábrica: Unidade:
44143 STALO UN/1
F1 F4

UN: R\$ 35,48 AV: R\$ 35,48 15: R\$ 36,22
30: R\$ 36,95 45: R\$ 37,69 60: R\$ 38,44

30 cm
40 cm



QUADRO BRANCO UV ALUM 40X30CM 9120

Código: Fábrica: Unidade:
50193 STALO UN/1
F1 F4

UN: R\$ 37,93 AV: R\$ 37,93 15: R\$ 38,72
30: R\$ 39,49 45: R\$ 40,28 60: R\$ 41,09

30 cm
40 cm



QUADRO BRANCO UV ALUM 40X30CM 9120

Código: Fábrica: Unidade:
44142 STALO UN/1
F1 F4

UN: R\$ 69,39 AV: R\$ 69,39 15: R\$ 70,83
30: R\$ 72,25 45: R\$ 73,70 60: R\$ 75,17

40 cm
60 cm



QUADRO BRANCO UV ALUM 60X40CM 9121

Código: Fábrica: Unidade:
44147 STALO UN/1
F1 F4

UN: R\$ 83,86 AV: R\$ 83,86 15: R\$ 85,60
30: R\$ 87,31 45: R\$ 89,06 60: R\$ 90,84

50 cm
70 cm



QUADRO BRANCO UV ALUM 70X50CM 9125

Código: Fábrica: Unidade:
44151 STALO UN/1
F1 F4

UN: R\$ 109,81 AV: R\$ 109,81 15: R\$ 112,10
30: R\$ 114,34 45: R\$ 116,63 60: R\$ 118,96

60 cm
90 cm



QUADRO BRANCO UV ALUM 90X60CM 9122

Código: Fábrica: Unidade:
44149 STALO UN/1
F1 F4

UN: R\$ 59,89 AV: R\$ 59,89 15: R\$ 61,14
30: R\$ 62,36 45: R\$ 63,61 60: R\$ 64,88

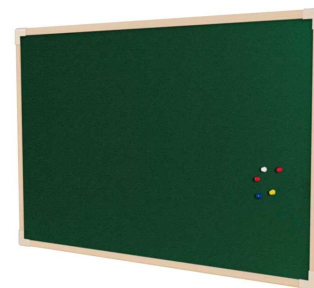

QUADRO BRANCO UV MAD 90X60CM 9329

Código: Fábrica: Unidade:
43006 STALO UN/1
F1 F4

UN: R\$ 321,98 AV: R\$ 321,98 15: R\$ 328,69
30: R\$ 335,27 45: R\$ 341,97 60: R\$ 348,81

120cm
200cm

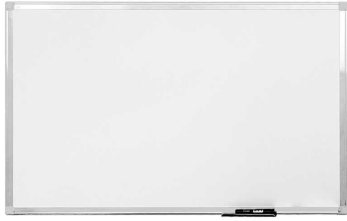

QUADRO BRANCO UV MDF ALUM 200X120CM 4019

Código: Fábrika: Unidade:
45622 STALO UN/1
F1 F4

UN: R\$ 199,85 AV: R\$ 199,85 15: R\$ 204,01
30: R\$ 208,09 45: R\$ 212,26 60: R\$ 216,50

60cm
90cm



QUADRO FELTRO POP ALUM 120X90CM 1141

Código: Fábrika: Unidade:
49128 CORTIARTE UN/1
F1 F4

UN: R\$ 8,99 AV: R\$ 8,99 15: R\$ 9,17
30: R\$ 9,36 45: R\$ 9,54 60: R\$ 9,73



QUADRO PP A4 0,40MM MULTI USO CRISTAL

Código: Fábrika: Unidade:
34128 PLASCONY UN/1
F1 F4

UN: R\$ 12,23 AV: R\$ 12,23 15: R\$ 12,49
30: R\$ 12,73 45: R\$ 12,99 60: R\$ 13,25



QUADRO VERDE (LOUSA) 25X35CM 260

Código: Fábrika: Unidade:
13173 P A SOUZA UN/1
F1 F4

UN: R\$ 15,96 AV: R\$ 15,96 15: R\$ 16,30
30: R\$ 16,62 45: R\$ 16,96 60: R\$ 17,29



QUADRO VERDE (LOUSA) 35X45CM 261

Código: Fábrika: Unidade:
36392 P A SOUZA UN/1
F1 F4

UN: R\$ 21,72 AV: R\$ 21,72 15: R\$ 22,17
30: R\$ 22,61 45: R\$ 23,06 60: R\$ 23,52



QUADRO VERDE (LOUSA) 37X50CM 262

Código: Fábrika: Unidade:
6834 P A SOUZA UN/1
F1 F4

UN: R\$ 2,30 AV: R\$ 45,93 15: R\$ 46,88
30: R\$ 47,82 45: R\$ 48,78 60: R\$ 49,75



RECIBO SERVICO TAXI 105X150MM 50FLS 20X1

Código: Fábrika: Unidade:
39291 TAMOIO PT/20
F1 F4

UN: R\$ 1,90 AV: R\$ 18,96 15: R\$ 19,35
30: R\$ 19,74 45: R\$ 20,14 60: R\$ 20,54



REFIL APAGADOR QUADRO BCO MAGN 10X1

Código: Fábrika: Unidade:
45633 CORTIARTE PT/10
F1 F4

UN: R\$ 3,58 AV: R\$ 3,58 15: R\$ 3,66
30: R\$ 3,73 45: R\$ 3,81 60: R\$ 3,88



REFIL P/ MARCADOR QUADRO BCO AZUL 1001

Código: Fábrika: Unidade:
34131 BRW UN/1
F1 F4

UN: R\$ 2,99 AV: R\$ 2,99 15: R\$ 3,05
30: R\$ 3,11 45: R\$ 3,17 60: R\$ 3,23



REFIL P/ MARCADOR QUADRO BCO AZUL 991006

Código: Fábrika: Unidade:
48190 JOCAROFFICE UN/1
F1 F4

UN: R\$ 2,99 AV: R\$ 2,99 15: R\$ 3,05
30: R\$ 3,11 45: R\$ 3,17 60: R\$ 3,23



REFIL P/ MARCADOR QUADRO BCO PRET 991006

Código: Fábrika: Unidade:
48191 JOCAROFFICE UN/1
F1 F4

UN: R\$ 3,58 AV: R\$ 3,58 15: R\$ 3,66
30: R\$ 3,73 45: R\$ 3,81 60: R\$ 3,88



REFIL P/ MARCADOR QUADRO BCO PRETO 1002

Código: Fábrika: Unidade:
34130 BRW UN/1
F1 F4

UN: R\$ 2,99 AV: R\$ 2,99 15: R\$ 3,05
30: R\$ 3,11 45: R\$ 3,17 60: R\$ 3,23



REFIL P/ MARCADOR QUADRO BCO VERM 991006

Código: Fábrika: Unidade:
48192 JOCAROFFICE UN/1
F1 F4

UN: R\$ 3,98 AV: R\$ 3,98 15: R\$ 4,07
30: R\$ 4,15 45: R\$ 4,23 60: R\$ 4,32



REFIL P/ MARCADOR QUADRO BCO VERMEL 1003

Código: Fábrika: Unidade:
44161 BRW UN/1
F1 F4



UN: R\$ 6,75 AV: R\$ 6,75 15: R\$ 6,96
30: R\$ 7,17 45: R\$ 7,38 60: R\$ 7,61



REFIL P/FICHARIO 96 FLS BRANCO

Código: Fábrika: Unidade:
19581 TILIBRA UN/1
F1 F4

UN: R\$ 7,49 AV: R\$ 74,87 15: R\$ 76,43
30: R\$ 77,96 45: R\$ 79,52 60: R\$ 81,11

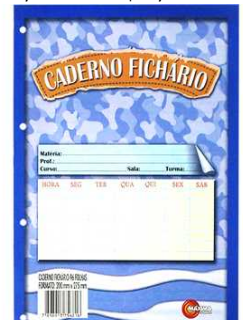

REFIL P/FICHARIO 96 FLS BRANCO 10X1

Código: Fábrika: Unidade:
33257 MAXIMA PT/10
F1 F4

UN: R\$ 8,98 AV: R\$ 89,85 15: R\$ 91,72
30: R\$ 93,55 45: R\$ 95,42 60: R\$ 97,33

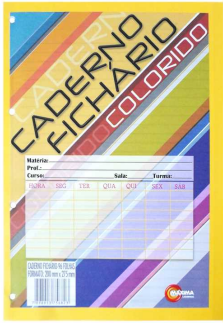

REFIL P/FICHARIO 96 FLS COLORIDO 10X1

Código: Fábrika: Unidade:
15285 MAXIMA PT/10
F1 F4

UN: R\$ 2,99 AV: R\$ 29,89 15: R\$ 30,51
30: R\$ 31,13 45: R\$ 31,75 60: R\$ 32,38



REFIL 1/4 P/FICHARIO 96 FLS PEQ 10X1

Código: Fábrika: Unidade:
9647 SULAMERICANA PT/10
F1 F4

UN: R\$ 199,67 AV: R\$ 199,67 15: R\$ 203,83
30: R\$ 207,91 45: R\$ 212,06 60: R\$ 216,31



REFILADORA DE PAPEL A4/A5 10 FLS

Código: Fábrika: Unidade:
44123 YIN'S PAPER UN/1
F1 F4

UN: R\$ 17,96 AV: R\$ 17,96 15: R\$ 18,34
30: R\$ 18,70 45: R\$ 19,08 60: R\$ 19,46



REGUA DE PULSO 20 CM MARIA CLARA & JP

Código: Fábrika: Unidade:
50328 FIRST UN/1
F1 F4

UN: R\$ 3,74 AV: R\$ 3,74 15: R\$ 3,82
30: R\$ 3,90 45: R\$ 3,98 60: R\$ 4,06

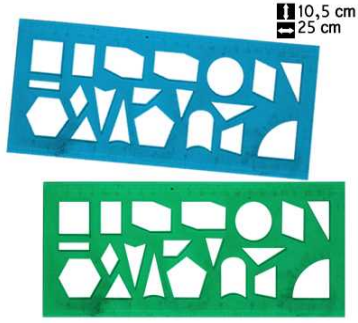

REGUA GEOMETRICA 10,5X25CM RG029

Código: Fábrika: Unidade:
33057 BUDEPLAST UN/1
F1 F4

UN: R\$ 4,78 AV: R\$ 4,78 15: R\$ 4,88
30: R\$ 4,98 45: R\$ 5,08 60: R\$ 5,18



REGUA MAGICA 10X21CM RG029/032

Código: Fábrika: Unidade:
33058 BUDEPLAST UN/1
F1 F4

UN: R\$ 22,95 AV: R\$ 22,95 15: R\$ 23,43
30: R\$ 23,90 45: R\$ 24,38 60: R\$ 24,87



REGUA 1 METRO MADEIRA C/PEGADOR

Código: Fábrika: Unidade:
45184 STALO/SOUSA UN/1
F1 F4

UN: R\$ 39,93 AV: R\$ 39,93 15: R\$ 40,76
30: R\$ 41,57 45: R\$ 42,40 60: R\$ 43,25



REGUA 1 METRO METAL ACO INOX ESCALA 300

Código: Fábrika: Unidade:
45079 NYBC UN/1
F1 F4

UN: R\$ 4,24 AV: R\$ 42,43 15: R\$ 43,32
30: R\$ 44,18 45: R\$ 45,07 60: R\$ 45,97

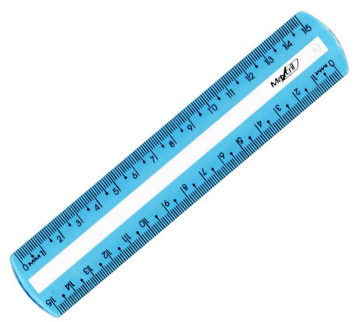

REGUA 15 CM GUIA LEITURA AZUL EMB IN10X1

Código: Fábrika: Unidade:
50763 MAXCRIL PT/10
F1 F4

UN: R\$ 0,69 AV: R\$ 24,96 15: R\$ 25,48
30: R\$ 25,99 45: R\$ 26,51 60: R\$ 27,04



REGUA 15 CM POWER RANGERS JUNGLE 36X1

Código: Fábrika: Unidade:
35684 TRIS C//36
F4

UN: R\$ 3,48 AV: R\$ 3,48 15: R\$ 3,56
30: R\$ 3,63 45: R\$ 3,70 60: R\$ 3,77



REGUA 20 CM FLEXIVEL COLOR 4567

Código: Fábrika: Unidade:
49114 LEO&LEO UN/1
F1 F4

UN: R\$ 2,45 AV: R\$ 24,46 15: R\$ 24,97
30: R\$ 25,47 45: R\$ 25,98 60: R\$ 26,50

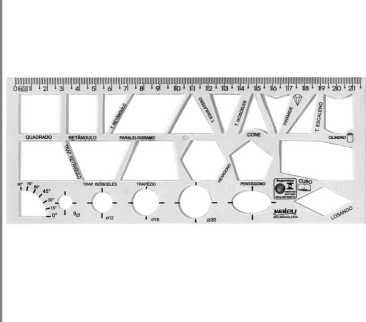

REGUA 21 CM GEOMETRICA CRISTAL 10X1

Código: Fábrika: Unidade:
21493 WALEU PT/10
F1 F4

UN: R\$ 4,44 AV: R\$ 4,44 15: R\$ 4,54
30: R\$ 4,63 45: R\$ 4,72 60: R\$ 4,81



REGUA 30 CM ALUMINIO 1002810

Código: Fábrika: Unidade:
43088 PLANETA UN/1
F1 F4

UN: R\$ 5,68 AV: R\$ 5,68 15: R\$ 5,80
30: R\$ 5,92 45: R\$ 6,03 60: R\$ 6,15



REGUA 30 CM ALUMINIO 101-014

Código: Fábrika: Unidade:
14678 LYKE UN/1
F1 F4

UN: R\$ 5,78 AV: R\$ 5,78 15: R\$ 5,90
30: R\$ 6,02 45: R\$ 6,14 60: R\$ 6,26



REGUA 30 CM BAIXA VISAO CRISTAL UN

Código: Fábrika: Unidade:
50767 MAXCRIL UN/1
F1 F4

UN: R\$ 5,78 AV: R\$ 57,81 15: R\$ 59,01
30: R\$ 60,19 45: R\$ 61,40 60: R\$ 62,62



REGUA 30 CM BAIXA VISAO CRISTAL 10X1

Código: Fábrika: Unidade:
50765 MAXCRIL PT/10
F1 F4

UN: R\$ 2,80 AV: R\$ 27,96 15: R\$ 28,54
30: R\$ 29,11 45: R\$ 29,69 60: R\$ 30,28



REGUA 30 CM BRANCA EMB IND 987.2 10X1

Código: Fábrica: Unidade:
40885 ACRIMET PT/10
F1 F4

UN: R\$ 2,50 AV: R\$ 24,96 15: R\$ 25,48
30: R\$ 25,99 45: R\$ 26,51 60: R\$ 27,04



REGUA 30 CM CRISTAL EMB IND 984 10X1

Código: Fábrica: Unidade:
37445 ACRIMET PT/10
F1 F4

UN: R\$ 3,97 AV: R\$ 95,35 15: R\$ 97,33
30: R\$ 99,28 45: R\$ 101,27 60: R\$ 103,29



REGUA 30 CM CRISTAL EMBAL IND 981 24X1

Código: Fábrica: Unidade:
32389 ACRIMET CX/24
F1 F4

UN: R\$ 2,59 AV: R\$ 25,95 15: R\$ 26,49
30: R\$ 27,02 45: R\$ 27,56 60: R\$ 28,11

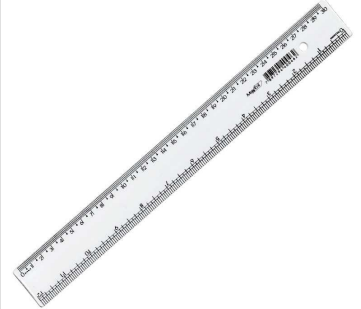

REGUA 30 CM CRISTAL SUPER 10X1

Código: Fábrica: Unidade:
22911 MAXCRIL PT/10
F1 F4

UN: R\$ 1,20 AV: R\$ 29,94 15: R\$ 30,57
30: R\$ 31,18 45: R\$ 31,80 60: R\$ 32,44



REGUA 30 CM CRISTAL 10270012 25X1

Código: Fábrica: Unidade:
215 MAXCRIL PT/25
F1 F4

UN: R\$ 1,00 AV: R\$ 99,83 15: R\$ 101,91
30: R\$ 103,95 45: R\$ 106,03 60: R\$ 108,15



REGUA 30 CM CRISTAL 10270086 100X1

Código: Fábrica: Unidade:
35737 MAXCRIL CX/100
F1 F4

UN: R\$ 2,00 AV: R\$ 19,97 15: R\$ 20,38
30: R\$ 20,79 45: R\$ 21,21 60: R\$ 21,63



REGUA 30 CM EMB IND BANG ON THE DOOR10X1

Código: Fábrica: Unidade:
38562 POLIBRAS PT/10
F1 F4

UN: R\$ 2,00 AV: R\$ 19,97 15: R\$ 20,38
30: R\$ 20,79 45: R\$ 21,21 60: R\$ 21,63



REGUA 30 CM EMB IND BARBIE 10X1

Código: Fábrica: Unidade:
38567 POLIBRAS PT/10
F1 F4

UN: R\$ 2,00 AV: R\$ 19,97 15: R\$ 20,38
30: R\$ 20,79 45: R\$ 21,21 60: R\$ 21,63



REGUA 30 CM EMB IND CHEVROLET 10X1

Código: Fábrica: Unidade:
38564 POLIBRAS PT/10
F4

UN: R\$ 2,33 AV: R\$ 27,96 15: R\$ 28,54
30: R\$ 29,11 45: R\$ 29,69 60: R\$ 30,28



REGUA 30 CM EMB IND HIGH SCHHOL MUS 12X1

Código: Fábrica: Unidade:
38568 SUMMIT PT/12
F1 F4

UN: R\$ 2,50 AV: R\$ 24,95 15: R\$ 25,47
30: R\$ 25,98 45: R\$ 26,50 60: R\$ 27,03



REGUA 30 CM EMB IND HOT WHEELS 10X1

Código: Fábrica: Unidade:
38563 POLIBRAS PT/10
F1 F4

UN: R\$ 2,00 AV: R\$ 19,97 15: R\$ 20,38
30: R\$ 20,79 45: R\$ 21,21 60: R\$ 21,63



REGUA 30 CM EMB IND POLLY 10X1

Código: Fábrica: Unidade:
38560 POLIBRAS PT/10
F1 F4

UN: R\$ 2,00 AV: R\$ 19,97 15: R\$ 20,38
30: R\$ 20,79 45: R\$ 21,21 60: R\$ 21,63



REGUA 30 CM EMB IND PRINCESAS 10X1

Código: Fábrica: Unidade:
38561 POLIBRAS PT/10
F1 F4

UN: R\$ 2,00 AV: R\$ 19,97 15: R\$ 20,38
30: R\$ 20,79 45: R\$ 21,21 60: R\$ 21,63



REGUA 30 CM EMB IND RUBY GLOOM 10X1

Código: Fábrica: Unidade:
38565 POLIBRAS PT/10
F1 F4

UN: R\$ 3,15 AV: R\$ 3,15 15: R\$ 3,21
30: R\$ 3,27 45: R\$ 3,34 60: R\$ 3,41

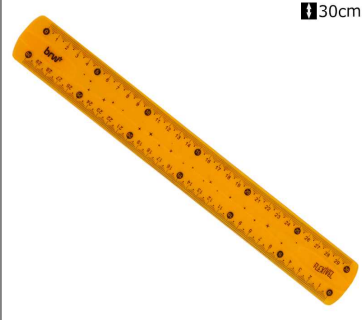

REGUA 30 CM FLEXIVEL COLOR 0001 UN

Código: Fábrica: Unidade:
46844 BRW UN/1
F1 F4

UN: R\$ 3,98 AV: R\$ 3,98 15: R\$ 4,07
30: R\$ 4,15 45: R\$ 4,23 60: R\$ 4,32



REGUA 30 CM FLEXIVEL COLOR 4365

Código: Fábrica: Unidade:
50647 LEO&LEO UN/1
F1 F4

UN: R\$ 5,99 AV: R\$ 59,89 15: R\$ 61,14
30: R\$ 62,36 45: R\$ 63,61 60: R\$ 64,88

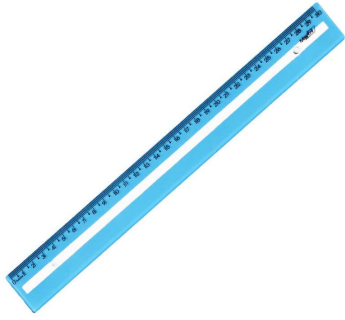

REGUA 30 CM GUIA LEITURA AZUL EMB IN10X1
Código: 50764 Fábrica: MAXCRIL Unidade: PT/10 F1 F4

UN: R\$ 5,98 AV: R\$ 5,98 15: R\$ 6,11
30: R\$ 6,23 45: R\$ 6,35 60: R\$ 6,48

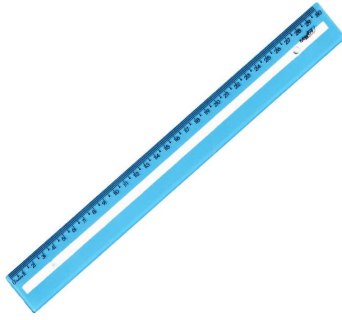

REGUA 30 CM GUIA LEITURA AZUL UN
Código: 50766 Fábrica: MAXCRIL Unidade: UN/1 F1 F4

UN: R\$ 8,98 AV: R\$ 89,85 15: R\$ 91,72
30: R\$ 93,55 45: R\$ 95,42 60: R\$ 97,33



REGUA 30 CM METAL ACO INOX ESCALA 10X1
Código: 49943 Fábrica: BAZZE Unidade: CX/10 F1 F4

UN: R\$ 5,98 AV: R\$ 5,98 15: R\$ 6,11
30: R\$ 6,23 45: R\$ 6,35 60: R\$ 6,48



REGUA 30 CM METAL ACO INOX ESCALA 7403
Código: 46943 Fábrica: YIN'S PAPER Unidade: UN/1 F1 F4

UN: R\$ 2,75 AV: R\$ 27,46 15: R\$ 28,03
30: R\$ 28,59 45: R\$ 29,16 60: R\$ 29,74



REGUA 30 CM NEW LINE CRISTAL EMB IND10X1
Código: 35738 Fábrica: MAXCRI/WALEU Unidade: PT/10 F1 F4

UN: R\$ 2,75 AV: R\$ 2,75 15: R\$ 2,80
30: R\$ 2,86 45: R\$ 2,92 60: R\$ 2,97



REGUA 30 CM NEW LINE CRISTAL UN
Código: 18924 Fábrica: MAXCRIL Unidade: UN/1 F1 F4

UN: R\$ 2,19 AV: R\$ 2,19 15: R\$ 2,23
30: R\$ 2,28 45: R\$ 2,32 60: R\$ 2,37

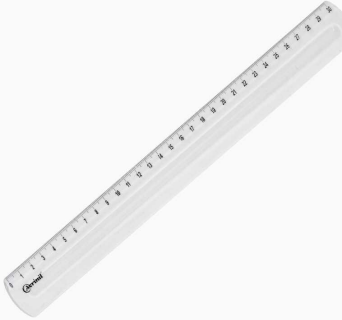

REGUA 30 CM PLAST CRISTAL 300
Código: 43219 Fábrica: ACRINIL Unidade: UN/1 F1 F4

UN: R\$ 2,29 AV: R\$ 2,29 15: R\$ 2,33
30: R\$ 2,38 45: R\$ 2,43 60: R\$ 2,48

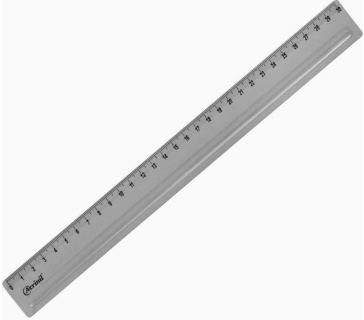

REGUA 30 CM PLAST PRATA 305
Código: 43218 Fábrica: ACRINIL Unidade: UN/1 F1 F4

UN: R\$ 2,29 AV: R\$ 2,29 15: R\$ 2,33
30: R\$ 2,38 45: R\$ 2,43 60: R\$ 2,48



REGUA 30 CM PLAST PRETA 306
Código: 43217 Fábrica: ACRINIL Unidade: UN/1 F1 F4

UN: R\$ 2,29 AV: R\$ 2,29 15: R\$ 2,33
30: R\$ 2,38 45: R\$ 2,43 60: R\$ 2,48



REGUA 30 CM PLAST TRANSP FUME 301
Código: 43216 Fábrica: ACRINIL Unidade: UN/1 F1 F4

UN: R\$ 2,29 AV: R\$ 2,29 15: R\$ 2,33
30: R\$ 2,38 45: R\$ 2,43 60: R\$ 2,48



REGUA 30 CM PLAST TRANSP ROSA 3098
Código: 43212 Fábrica: ACRINIL Unidade: UN/1 F1 F4

UN: R\$ 2,29 AV: R\$ 2,29 15: R\$ 2,33
30: R\$ 2,38 45: R\$ 2,43 60: R\$ 2,48



REGUA 30 CM PLAST TRANSP VERDE 303
Código: 43214 Fábrica: ACRINIL Unidade: UN/1 F1 F4

UN: R\$ 2,29 AV: R\$ 2,29 15: R\$ 2,33
30: R\$ 2,38 45: R\$ 2,43 60: R\$ 2,48



REGUA 30 CM PLAST TRANSP VERMELHO 304
Código: 43213 Fábrica: ACRINIL Unidade: UN/1 F1 F4

UN: R\$ 2,80 AV: R\$ 27,96 15: R\$ 28,54
30: R\$ 29,11 45: R\$ 29,69 60: R\$ 30,28



REGUA 30 CM PRETO EMB IND 987.7 10X1
Código: 40886 Fábrica: ACRIMET Unidade: PT/10 F1 F4

UN: R\$ 2,80 AV: R\$ 27,96 15: R\$ 28,54
30: R\$ 29,11 45: R\$ 29,69 60: R\$ 30,28

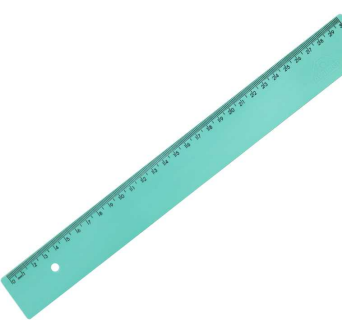

REGUA 30 CM VERDE EMB IND 987.4 10X1
Código: 40887 Fábrica: ACRIMET Unidade: PT/10 F1 F4

UN: R\$ 4,29 AV: R\$ 42,92 15: R\$ 43,82
30: R\$ 44,69 45: R\$ 45,59 60: R\$ 46,50

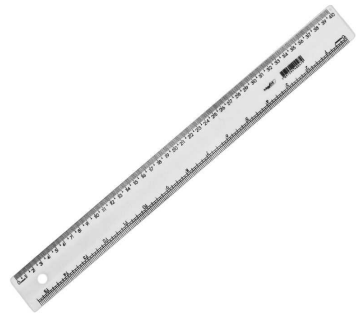

REGUA 40 CM CRISTAL SUPER 10X1
Código: 49200 Fábrica: MAXCRIL Unidade: PT/10 F1 F4

UN: R\$ 12,97 AV: R\$ 12,97 15: R\$ 13,24
30: R\$ 13,50 45: R\$ 13,77 60: R\$ 14,05



REGUA 50 CM ACR CRISTAL 515
Código: 43533 Fábrica: ACRIMET Unidade: UN/1 F1 F4

UN: R\$ 12,97 AV: R\$ 12,97 15: R\$ 13,24
30: R\$ 13,50 45: R\$ 13,77 60: R\$ 14,05



REGUA 50 CM ALUMINIO 10270125
Código: 50762 Fábrica: MAXCRIL Unidade: UN/1 F1 F4

UN: R\$ 16,96 AV: R\$ 16,96 15: R\$ 17,32
30: R\$ 17,66 45: R\$ 18,02 60: R\$ 18,38



REGUA 60 CM ACR CRISTAL 516
Código: 43532 Fábrica: ACRIMET Unidade: UN/1 F1 F4

UN: R\$ 19,96 AV: R\$ 19,96 15: R\$ 20,37
30: R\$ 20,78 45: R\$ 21,20 60: R\$ 21,62



REGUA 60 CM METAL ACO INOX 300
Código: 45077 Fábrica: NYBC Unidade: UN/1 F1 F4

UN: R\$ 0,71 AV: R\$ 35,44 15: R\$ 36,18
30: R\$ 36,91 45: R\$ 37,64 60: R\$ 38,40



RIFA GRANDE CTL C/50 NOMES 6011 50X1
Código: 10299 Fábrica: TAMOIO Unidade: PT/50 F1 F4

UN: R\$ 0,30 AV: R\$ 14,97 15: R\$ 15,28
30: R\$ 15,58 45: R\$ 15,90 60: R\$ 16,21



RIFA GRANDE CTL NUMEROS 1A100 6015 50X1
Código: 37042 Fábrica: TAMOIO Unidade: PT/50 F1 F4

UN: R\$ 6,83 AV: R\$ 34,15 15: R\$ 34,86
30: R\$ 35,55 45: R\$ 36,26 60: R\$ 36,99



ROLETE BICOLOR P/MAQUINA CALCULAR 5X1
Código: 38247 Fábrica: MASTERPRINT Unidade: CR/5 F1 F4

UN: R\$ 11,97 AV: R\$ 11,97 15: R\$ 12,22
30: R\$ 12,46 45: R\$ 12,71 60: R\$ 12,97



ROLINHO MINI 3,5CM C/ESPUMA+4REFI 971950
Código: 51102 Fábrica: CONDOR Unidade: PT/1 F1 F4

UN: R\$ 24,95 AV: R\$ 24,95 15: R\$ 25,47
30: R\$ 25,98 45: R\$ 26,50 60: R\$ 27,03



SACO PAPEL KRAFT MIX 0,5 KG 500X1
Código: 41443 Fábrica: SACOPEL Unidade: PT/1 F1 F4

UN: R\$ 34,74 AV: R\$ 34,74 15: R\$ 35,47
30: R\$ 36,18 45: R\$ 36,90 60: R\$ 37,64



SACO PAPEL KRAFT MIX 1 KG 500X1
Código: 41444 Fábrica: SACOPEL Unidade: PT/1 F1 F4

UN: R\$ 0,25 AV: R\$ 124,80 15: R\$ 127,40
30: R\$ 129,95 45: R\$ 132,55 60: R\$ 135,20



SACO PAPEL KRAFT MIX 10 KG 500X1
Código: 48668 Fábrica: SACOPEL Unidade: PT/500 F1 F4

UN: R\$ 52,42 AV: R\$ 52,42 15: R\$ 53,51
30: R\$ 54,58 45: R\$ 55,67 60: R\$ 56,78



SACO PAPEL KRAFT MIX 2 KG 500X1
Código: 46270 Fábrica: SACOPEL Unidade: PT/1 F1 F4

UN: R\$ 0,23 AV: R\$ 114,82 15: R\$ 117,21
30: R\$ 119,55 45: R\$ 121,94 60: R\$ 124,38



SACO PAPEL KRAFT MIX 7,5 KG 500X1
Código: 48667 Fábrica: SACOPEL Unidade: PT/500 F1 F4

UN: R\$ 0,06 AV: R\$ 30,94 15: R\$ 31,59
30: R\$ 32,22 45: R\$ 32,86 60: R\$ 33,52

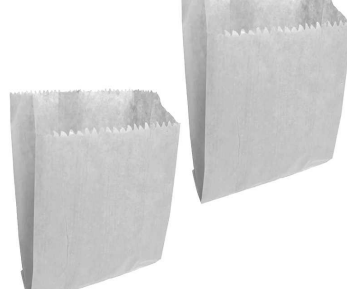

SACO PAPEL PIPOCA BRANCO 12X12CM 500X1
Código: 47261 Fábrica: STRONG Unidade: PT/500 F1 F4

UN: R\$ 16,96 AV: R\$ 16,96 15: R\$ 17,32
30: R\$ 17,66 45: R\$ 18,02 60: R\$ 18,38



SACO PAPEL PIPOCA 2 7,5X12CM 500X1
Código: 31026 Fábrica: STRONG Unidade: PT/1 F1 F4

UN: R\$ 22,95 AV: R\$ 22,95 15: R\$ 23,43
30: R\$ 23,90 45: R\$ 24,38 60: R\$ 24,87



SACO PAPEL PIPOCA 3 7,5X15,5CM 500X1
Código: 31027 Fábrica: STRONG Unidade: PT/1 F1 F4

UN: R\$ 0,06 AV: R\$ 27,95 15: R\$ 28,53
30: R\$ 29,10 45: R\$ 29,68 60: R\$ 30,27



SACO PAPEL PIPOCA 4 7,5X17,5CM 500X1

Código: Fábrika: Unidade:
31651 STRONG PT/500
F1 F4

UN: R\$ 0,06 AV: R\$ 31,94 15: R\$ 32,60
30: R\$ 33,26 45: R\$ 33,92 60: R\$ 34,60



SACO PAPEL PIPOCA 5 10,5X15CM 500X1

Código: Fábrika: Unidade:
35938 STRONG PT/500
F1 F4

UN: R\$ 0,02 AV: R\$ 15,96 15: R\$ 16,30
30: R\$ 16,62 45: R\$ 16,96 60: R\$ 17,29



SACO PLAST 5X23CM CHUP CHUP 1000X1

Código: Fábrika: Unidade:
31028 SILVANI/KROM PT/1000
F1 F4

UN: R\$ 0,02 AV: R\$ 16,96 15: R\$ 17,32
30: R\$ 17,66 45: R\$ 18,02 60: R\$ 18,38



SACO PLAST 6X24CM CHUP CHUP 1000X1

Código: Fábrika: Unidade:
47892 SILVANI PT/1000
F1 F4

UN: R\$ 0,03 AV: R\$ 25,95 15: R\$ 26,49
30: R\$ 27,02 45: R\$ 27,56 60: R\$ 28,11



SACO PLAST 8X25CM P/TALHER 1000X1

Código: Fábrika: Unidade:
44378 KROMASA PT/1000
F1 F4

UN: R\$ 24,86 AV: R\$ 24,86 15: R\$ 25,38
30: R\$ 25,89 45: R\$ 26,40 60: R\$ 26,93



SACO PLAST BOB 16X30CM PICOTADO 500X1

Código: Fábrika: Unidade:
44295 ECO ROLL RL/1
F1 F4

UN: R\$ 0,36 AV: R\$ 35,93 15: R\$ 36,68
30: R\$ 37,41 45: R\$ 38,16 60: R\$ 38,93



SACO PLAST TRANSP 25X37CM 100X1

Código: Fábrika: Unidade:
41919 COPLAMIX PT/100
F1 F4

UN: R\$ 0,02 AV: R\$ 17,47 15: R\$ 17,84
30: R\$ 18,19 45: R\$ 18,56 60: R\$ 18,93



SACO PLAST 10X15CM TRANSP 1000X1

Código: Fábrika: Unidade:
47893 SILVANI PT/1000
F1 F4

UN: R\$ 0,03 AV: R\$ 25,21 15: R\$ 25,73
30: R\$ 26,25 45: R\$ 26,77 60: R\$ 27,31



SACO PLAST 12X18CM TRANSP 1000X1

Código: Fábrika: Unidade:
47894 SILVANI PT/1000
F1 F4

UN: R\$ 39,93 AV: R\$ 39,93 15: R\$ 40,76
30: R\$ 41,57 45: R\$ 42,40 60: R\$ 43,25



SACO PLAST 15X30CM TRANSP 05 1 KG

Código: Fábrika: Unidade:
48890 DIFFATTO KG/1
F1 F4

UN: R\$ 0,02 AV: R\$ 21,47 15: R\$ 21,91
30: R\$ 22,35 45: R\$ 22,80 60: R\$ 23,25



SACO PLAST 20X10CM HOT DOG 1000X1

Código: Fábrika: Unidade:
47896 SILVANI PT/1000
F1 F4

UN: R\$ 0,03 AV: R\$ 29,94 15: R\$ 30,57
30: R\$ 31,18 45: R\$ 31,80 60: R\$ 32,44



SACO PLAST 20X14CM HAMBURGER 1000X1

Código: Fábrika: Unidade:
47895 SILVANI PT/1000
F1 F4

UN: R\$ 0,03 AV: R\$ 14,97 15: R\$ 15,28
30: R\$ 15,58 45: R\$ 15,90 60: R\$ 16,21



SACO PLAST 20X14CM HAMBURGUER 500X1

Código: Fábrika: Unidade:
46995 KROMASA PT/500
F1 F4

UN: R\$ 39,93 AV: R\$ 39,93 15: R\$ 40,76
30: R\$ 41,57 45: R\$ 42,40 60: R\$ 43,25



SACO PLAST 20X30CM 06 TRANSP 1KG

Código: Fábrika: Unidade:
46980 DIFFATTO KG/1
F1 F4

UN: R\$ 34,94 AV: R\$ 34,94 15: R\$ 35,67
30: R\$ 36,39 45: R\$ 37,11 60: R\$ 37,86



SACO PLAST 22X48CM 0,6 TRANSP KG

Código: Fábrika: Unidade:
45067 KROMASA KG/1
F1 F4

UN: R\$ 39,84 AV: R\$ 39,84 15: R\$ 40,67
30: R\$ 41,48 45: R\$ 42,31 60: R\$ 43,16



SACO PLAST 25X35CM TRANSP BOBINA PICOT

Código: Fábrika: Unidade:
44297 HIPERROLL RL/1
F1 F4

UN: R\$ 42,92 AV: R\$ 42,92 15: R\$ 43,82
30: R\$ 44,69 45: R\$ 45,59 60: R\$ 46,50



SACO PLAST 25X35CM TRANSP 06 1KG

Código: 48895 Fábrica: DIFFATTO Unidade: KG/1
F1 F4

UN: R\$ 39,93 AV: R\$ 39,93 15: R\$ 40,76
30: R\$ 41,57 45: R\$ 42,40 60: R\$ 43,25



SACO PLAST 30X40CM TRANSP 06 1KG

Código: 48896 Fábrica: DIFFATTO Unidade: KG/1
F1 F4

UN: R\$ 39,93 AV: R\$ 39,93 15: R\$ 40,76
30: R\$ 41,57 45: R\$ 42,40 60: R\$ 43,25



SACO PLAST 35X45CM 06 TRANSP 1 KG

Código: 48897 Fábrica: DIFFATTO Unidade: KG/1
F1 F4

UN: R\$ 39,93 AV: R\$ 39,93 15: R\$ 40,76
30: R\$ 41,57 45: R\$ 42,40 60: R\$ 43,25



SACO PLAST 40X60CM TRANSP 1 KG

Código: 48898 Fábrica: DIFFATTO Unidade: KG/1
F1 F4

UN: R\$ 0,35 AV: R\$ 34,94 15: R\$ 35,67
30: R\$ 36,39 45: R\$ 37,11 60: R\$ 37,86



SACO PLAST 40X60CM TRANSP 100X1

Código: 31029 Fábrica: KROMASA Unidade: PT/100
F1 F4

UN: R\$ 0,07 AV: R\$ 6,98 15: R\$ 7,12
30: R\$ 7,27 45: R\$ 7,41 60: R\$ 7,56



SACO PP 4X4X3CM AUTOCOLANTE 100X1

Código: 26912 Fábrica: RDE Unidade: PT/100
F1 F4

UN: R\$ 0,09 AV: R\$ 8,98 15: R\$ 9,16
30: R\$ 9,35 45: R\$ 9,53 60: R\$ 9,72



SACO PP 4X7X3CM AUTOCOLANTE 100X1

Código: 26913 Fábrica: RDE Unidade: PT/100
F1 F4

UN: R\$ 0,16 AV: R\$ 16,47 15: R\$ 16,82
30: R\$ 17,15 45: R\$ 17,50 60: R\$ 17,85



SACO PP 5X12X3CM AUTOCOLANTE 100X1

Código: 26915 Fábrica: RDE Unidade: PT/100
F1 F4

UN: R\$ 0,18 AV: R\$ 17,96 15: R\$ 18,34
30: R\$ 18,70 45: R\$ 19,08 60: R\$ 19,46



SACO PP 5X22X3CM AUTOCOLANTE 10X1

Código: 34953 Fábrica: RDE Unidade: PT/100
F1 F4

UN: R\$ 0,12 AV: R\$ 12,08 15: R\$ 12,33
30: R\$ 12,58 45: R\$ 12,83 60: R\$ 13,09



SACO PP 5X7X3CM AUTOCOLANTE 100X1

Código: 26914 Fábrica: RDE Unidade: PT/100
F1 F4

UN: R\$ 0,18 AV: R\$ 18,19 15: R\$ 18,57
30: R\$ 18,94 45: R\$ 19,32 60: R\$ 19,71



SACO PP 6X12X3CM AUTOCOLANTE 100X1

Código: 26253 Fábrica: RDE Unidade: PT/100
F1 F4

UN: R\$ 0,17 AV: R\$ 17,07 15: R\$ 17,43
30: R\$ 17,78 45: R\$ 18,13 60: R\$ 18,50



SACO PP 6,5X9X3CM AUTOCOLANTE 100X1

Código: 26328 Fábrica: RDE Unidade: PT/100
F1 F4

UN: R\$ 0,18 AV: R\$ 18,47 15: R\$ 18,86
30: R\$ 19,23 45: R\$ 19,62 60: R\$ 20,01



SACO PP 7X12X3CM AUTOCOLANTE 100X1

Código: 32559 Fábrica: RDE Unidade: PT/100
F1 F4

UN: R\$ 0,14 AV: R\$ 14,23 15: R\$ 14,52
30: R\$ 14,81 45: R\$ 15,11 60: R\$ 15,41



SACO PP 7X7X3CM AUTOCOLANTE 100X1

Código: 26916 Fábrica: RDE Unidade: PT/100
F1 F4

UN: R\$ 0,20 AV: R\$ 19,96 15: R\$ 20,37
30: R\$ 20,78 45: R\$ 21,20 60: R\$ 21,62



SACO PP 7,5X13CM AUTOCOLANTE 100X1

Código: 23058 Fábrica: RDE Unidade: PT/100
F1 F4

UN: R\$ 0,20 AV: R\$ 19,96 15: R\$ 20,37
30: R\$ 20,78 45: R\$ 21,20 60: R\$ 21,62



SACO PP 8X25X3CM AUTOCOLANTE 100X1

Código: 26918 Fábrica: RDE Unidade: PT/100
F1 F4

UN: R\$ 0,24 AV: R\$ 23,95 15: R\$ 24,45
30: R\$ 24,94 45: R\$ 25,44 60: R\$ 25,95



SACO PP 9X13X3CM AUTOCOLANTE 100X1
Código: 26919 Fábrica: RDE Unidade: PT/100
F1 F4

UN: R\$ 0,22 AV: R\$ 11,17 15: R\$ 11,40
30: R\$ 11,63 45: R\$ 11,87 60: R\$ 12,10



SACO PP N2 15X22CM TRANSP CRISTAL 50X1
Código: 41969 Fábrica: VMP Unidade: PT/50
F1 F4

UN: R\$ 0,52 AV: R\$ 25,95 15: R\$ 26,49
30: R\$ 27,02 45: R\$ 27,56 60: R\$ 28,11



SACO PP N6 25X37CM TRANSP CRISTAL 50X1
Código: 41971 Fábrica: VMP Unidade: PT/50
F1 F4

UN: R\$ 0,76 AV: R\$ 37,83 15: R\$ 38,62
30: R\$ 39,39 45: R\$ 40,18 60: R\$ 40,98



SACO PP N8 30X45CM TRANSP CRISTAL 50X1
Código: 41972 Fábrica: VMP Unidade: PT/50
F1 F4

UN: R\$ 0,07 AV: R\$ 6,98 15: R\$ 7,12
30: R\$ 7,27 45: R\$ 7,41 60: R\$ 7,56



SACO PP TRANSP 10X14CM INCOLOR 100X1
Código: 41978 Fábrica: CROMUS Unidade: PT/100
F1 F4

UN: R\$ 0,30 AV: R\$ 29,94 15: R\$ 30,57
30: R\$ 31,18 45: R\$ 31,80 60: R\$ 32,44



SACO PP TRANSP 20X29CM INCOLOR 100X1
Código: 41976 Fábrica: CROMUS Unidade: PT/100
F1 F4

UN: R\$ 1,60 AV: R\$ 39,93 15: R\$ 40,76
30: R\$ 41,57 45: R\$ 42,40 60: R\$ 43,25



SACO PP TRANSP 45X59CM INCOLOR 25X1
Código: 44380 Fábrica: CROMUS Unidade: PT/25
F1 F4

UN: R\$ 0,27 AV: R\$ 26,65 15: R\$ 27,20
30: R\$ 27,75 45: R\$ 28,30 60: R\$ 28,87



SACO PP 10X15CM AUTOCOLANTE 100X1
Código: 32553 Fábrica: RDE Unidade: PT/100
F1 F4

UN: R\$ 0,06 AV: R\$ 2,99 15: R\$ 3,05
30: R\$ 3,11 45: R\$ 3,17 60: R\$ 3,23



SACO PP 10X15CM TRANSP INCOLOR 50X1
Código: 33859 Fábrica: NOVO TEMPO Unidade: PT/50
F1 F4

UN: R\$ 0,09 AV: R\$ 4,48 15: R\$ 4,58
30: R\$ 4,67 45: R\$ 4,76 60: R\$ 4,86



SACO PP 11X20CM TRANSP INCOLOR 50X1
Código: 33860 Fábrica: NOVO TEM/EMB Unidade: PT/50
F1 F4

UN: R\$ 0,40 AV: R\$ 39,93 15: R\$ 40,76
30: R\$ 41,57 45: R\$ 42,40 60: R\$ 43,25



SACO PP 15X20X3CM AUTOCOLANTE 100X1
Código: 26921 Fábrica: RDE Unidade: PT/100
F1 F4

UN: R\$ 0,30 AV: R\$ 14,97 15: R\$ 15,28
30: R\$ 15,58 45: R\$ 15,90 60: R\$ 16,21



SACO PP 15X22CM AUTOCOLANTE 50X1
Código: 41632 Fábrica: CG PACK Unidade: PT/50
F1 F4

UN: R\$ 0,17 AV: R\$ 8,44 15: R\$ 8,61
30: R\$ 8,78 45: R\$ 8,96 60: R\$ 9,14



SACO PP 15X22CM TRANSP INCOLOR 50X1
Código: 33861 Fábrica: NOVO TEMPO Unidade: PT/50
F1 F4

UN: R\$ 0,19 AV: R\$ 9,46 15: R\$ 9,66
30: R\$ 9,86 45: R\$ 10,05 60: R\$ 10,25



SACO PP 15X30CM TRANSP INCOLOR 50X1
Código: 33862 Fábrica: NOVO TEMPO Unidade: PT/50
F1 F4

UN: R\$ 0,58 AV: R\$ 57,90 15: R\$ 59,10
30: R\$ 60,29 45: R\$ 61,49 60: R\$ 62,72



SACO PP 18X25X3CM AUTOCOLANTE 100X1
Código: 26922 Fábrica: RDE Unidade: PT/100
F1 F4

UN: R\$ 0,40 AV: R\$ 39,93 15: R\$ 40,76
30: R\$ 41,57 45: R\$ 42,40 60: R\$ 43,25



SACO PP 20X20X3CM AUTOCOLANTE 100X1
Código: 26923 Fábrica: RDE Unidade: PT/100
F1 F4

UN: R\$ 0,32 AV: R\$ 15,96 15: R\$ 16,30
30: R\$ 16,62 45: R\$ 16,96 60: R\$ 17,29



SACO PP 20X30CM AUTOCOLANTE 50X1
Código: 41627 Fábrica: CG PACK Unidade: PT/50 F1 F4

UN: R\$ 0,16 AV: R\$ 15,96 15: R\$ 16,30
30: R\$ 16,62 45: R\$ 16,96 60: R\$ 17,29



SACO PP 20X30CM TRANSP INCOLOR 100X1
Código: 48787 Fábrica: KROMASA Unidade: PT/100 F1 F4

UN: R\$ 0,26 AV: R\$ 12,97 15: R\$ 13,24
30: R\$ 13,50 45: R\$ 13,77 60: R\$ 14,05



SACO PP 20X30CM TRANSP INCOLOR 50X1
Código: 41970 Fábrica: NOVO TEMPO Unidade: PT/50 F1 F4

UN: R\$ 0,50 AV: R\$ 49,91 15: R\$ 50,95
30: R\$ 51,97 45: R\$ 53,01 60: R\$ 54,07



SACO PP 25X35X3CM AUTOCOLANTE 100X1
Código: 26924 Fábrica: CG PACK Unidade: PT/100 F1 F4

UN: R\$ 0,39 AV: R\$ 19,36 15: R\$ 19,76
30: R\$ 20,16 45: R\$ 20,56 60: R\$ 20,97



SACO PP 25X36CM TRANSP INCOLOR 50X1
Código: 31640 Fábrica: NOVO TEMPO Unidade: PT/50 F1 F4

UN: R\$ 0,64 AV: R\$ 15,96 15: R\$ 16,30
30: R\$ 16,62 45: R\$ 16,96 60: R\$ 17,29

44 cm
30 cm



SACO PP 30X44CM TRANSP INCOLOR 25X1
Código: 43582 Fábrica: CROMUS Unidade: PT/25 F1 F4

UN: R\$ 0,56 AV: R\$ 27,93 15: R\$ 28,51
30: R\$ 29,08 45: R\$ 29,66 60: R\$ 30,25



SACO PP 30X45CM TRANSP INCOLOR 50X1
Código: 33865 Fábrica: NOVO TEMPO Unidade: PT/50 F1 F4

UN: R\$ 0,79 AV: R\$ 39,69 15: R\$ 40,51
30: R\$ 41,32 45: R\$ 42,15 60: R\$ 42,99



SACO PP 35X54CM TRANSP INCOLOR 50X1
Código: 41158 Fábrica: NOVO TEMPO Unidade: PT/50 F1 F4

UN: R\$ 2,64 AV: R\$ 65,88 15: R\$ 67,26
30: R\$ 68,60 45: R\$ 69,97 60: R\$ 71,37



SACO PP 60X89CM TRANSP 25X1
Código: 33867 Fábrica: EMBALE Unidade: PT/25 F1 F4

UN: R\$ 2,04 AV: R\$ 51,12 15: R\$ 52,18
30: R\$ 53,23 45: R\$ 54,29 60: R\$ 55,38

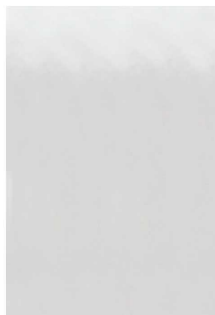

SACO PP 60X90CM TRANSP 25X1
Código: 41159 Fábrica: CROMUS Unidade: PT/25 F1 F4

UN: R\$ 1,92 AV: R\$ 47,91 15: R\$ 48,91
30: R\$ 49,89 45: R\$ 50,89 60: R\$ 51,91



SACO PP 60X90CM TRANSP 25X1
Código: 41630 Fábrica: CG PACK Unidade: PT/25 F1 F4

UN: R\$ 1,28 AV: R\$ 31,95 15: R\$ 32,61
30: R\$ 33,27 45: R\$ 33,93 60: R\$ 34,61



SACO PP 70X89CM TRANSP 25X1
Código: 33868 Fábrica: EMBALE Unidade: PT/25 F1 F4

UN: R\$ 1,48 AV: R\$ 36,94 15: R\$ 37,71
30: R\$ 38,46 45: R\$ 39,23 60: R\$ 40,02



SACO PP 80X89CM TRANSP 25X1
Código: 33869 Fábrica: EMBALE Unidade: PT/25 F1 F4

UN: R\$ 1,69 AV: R\$ 16,87 15: R\$ 17,22
30: R\$ 17,57 45: R\$ 17,92 60: R\$ 18,28



SACO PRES 8X10CM VELUDO PRETO 10X1
Código: 36620 Fábrica: SOLIDER Unidade: PT/10 F1 F4

UN: R\$ 1,60 AV: R\$ 15,96 15: R\$ 16,30
30: R\$ 16,62 45: R\$ 16,96 60: R\$ 17,29



SACO PRES 8X10CM VELUDO VERMELHO 10X1
Código: 36595 Fábrica: SOLIDER Unidade: PT/10 F1 F4

UN: R\$ 8,16 AV: R\$ 8,16 15: R\$ 8,33
30: R\$ 8,49 45: R\$ 8,66 60: R\$ 8,84



SACO PRES 8X8CM CASUAL AUT COLAN 100X1
Código: 44046 Fábrica: CROMUS Unidade: UN/1 F1 F4

UN: R\$ 3,68 AV: R\$ 3,68 15: R\$ 3,76
30: R\$ 3,84 45: R\$ 3,91 60: R\$ 3,99



SACO PRES 10X14CM FEM METAL 50X1
Código: Fábrica: Unidade:
37676 VILLA PACK UN/1
F1 F4

UN: R\$ 0,07 AV: R\$ 3,68 15: R\$ 3,76
30: R\$ 3,84 45: R\$ 3,91 60: R\$ 3,99



SACO PRES 10X14CM INF METAL 50X1
Código: Fábrica: Unidade:
37675 VILLA PACK PT/50
F1 F4

UN: R\$ 0,80 AV: R\$ 7,98 15: R\$ 8,14
30: R\$ 8,31 45: R\$ 8,47 60: R\$ 8,64



SACO PRES 10X15CM ORGANZA OURO 10X1
Código: Fábrica: Unidade:
36589 SOLIDER PT/10
F1 F4

UN: R\$ 0,80 AV: R\$ 7,98 15: R\$ 8,14
30: R\$ 8,31 45: R\$ 8,47 60: R\$ 8,64



SACO PRES 10X15CM ORGANZA PRATA 10X1
Código: Fábrica: Unidade:
36590 SOLIDER PT/10
F1 F4

UN: R\$ 0,08 AV: R\$ 3,98 15: R\$ 4,07
30: R\$ 4,15 45: R\$ 4,23 60: R\$ 4,32



SACO PRES 11X20CM FEM METAL 50X1
Código: Fábrica: Unidade:
33854 EMBALE PT/50
F1 F4

UN: R\$ 0,90 AV: R\$ 8,98 15: R\$ 9,16
30: R\$ 9,35 45: R\$ 9,53 60: R\$ 9,72



SACO PRES 15X18CM ORGANZA PRATA 10X1
Código: Fábrica: Unidade:
36602 SOLIDER PT/10
F1 F4

UN: R\$ 0,90 AV: R\$ 8,98 15: R\$ 9,16
30: R\$ 9,35 45: R\$ 9,53 60: R\$ 9,72



SACO PRES 15X18CM ORGANZA AZUL/DOUR 10X1
Código: Fábrica: Unidade:
36605 SOLIDER PT/10
F1 F4

UN: R\$ 0,90 AV: R\$ 8,98 15: R\$ 9,16
30: R\$ 9,35 45: R\$ 9,53 60: R\$ 9,72



SACO PRES 15X18CM ORGANZA DOURADO 10X1
Código: Fábrica: Unidade:
36606 SOLIDER PT/10
F1 F4

UN: R\$ 0,22 AV: R\$ 10,97 15: R\$ 11,20
30: R\$ 11,43 45: R\$ 11,65 60: R\$ 11,89



SACO PRES 15X22CM CAS VIBE SORT MET 50X1
Código: Fábrica: Unidade:
43565 CROMUS PT/50
F1 F4

UN: R\$ 0,22 AV: R\$ 10,97 15: R\$ 11,20
30: R\$ 11,43 45: R\$ 11,65 60: R\$ 11,89



SACO PRES 15X22CM CASUAL SORT 0037 50X1
Código: Fábrica: Unidade:
43568 CROMUS PT/50
F1 F4

UN: R\$ 0,17 AV: R\$ 8,28 15: R\$ 8,45
30: R\$ 8,62 45: R\$ 8,79 60: R\$ 8,97



SACO PRES 15X22CM INF METAL 50X1
Código: Fábrica: Unidade:
23419 VMP PT/50
F1 F4

UN: R\$ 0,24 AV: R\$ 11,97 15: R\$ 12,22
30: R\$ 12,46 45: R\$ 12,71 60: R\$ 12,97



SACO PRES 15X22CM LISO COLOR MET 50X1
Código: Fábrica: Unidade:
45794 CROMUS PT/50
F1 F4

UN: R\$ 0,20 AV: R\$ 9,97 15: R\$ 10,18
30: R\$ 10,39 45: R\$ 10,59 60: R\$ 10,81

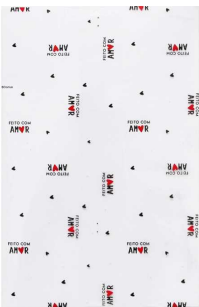

SACO PRES 15X22CM TRANSP STARS 50X1
Código: Fábrica: Unidade:
45795 GALA PT/50
F1 F4

UN: R\$ 0,36 AV: R\$ 17,87 15: R\$ 18,24
30: R\$ 18,61 45: R\$ 18,98 60: R\$ 19,36



SACO PRES 15X29CM BEBE MET/PER 50X1
Código: Fábrica: Unidade:
45798 CROMUS PT/50
F1 F4

UN: R\$ 0,32 AV: R\$ 15,96 15: R\$ 16,30
30: R\$ 16,62 45: R\$ 16,96 60: R\$ 17,29



SACO PRES 15X29CM CAS LISO COLO MET 50X1
Código: Fábrica: Unidade:
43570 CROMUS PT/50
F1 F4

UN: R\$ 0,28 AV: R\$ 13,97 15: R\$ 14,26
30: R\$ 14,54 45: R\$ 14,83 60: R\$ 15,13

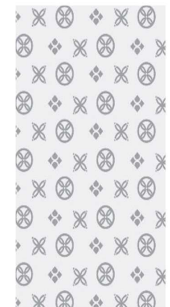

SACO PRES 15X29CM CAS MET 50X1
Código: Fábrica: Unidade:
46190 GALA PT/50
F1 F4

UN: R\$ 0,30 AV: R\$ 14,97 15: R\$ 15,28
30: R\$ 15,58 45: R\$ 15,90 60: R\$ 16,21



22 cm
15 cm



SACO PRES 15X29CM CAS VIBE SORT MET 50X1
Código: 43569 Fábrica: CROMUS Unidade: PT/50 F1 F4

UN: R\$ 0,28 AV: R\$ 13,97 15: R\$ 14,26
30: R\$ 14,54 45: R\$ 14,83 60: R\$ 15,13

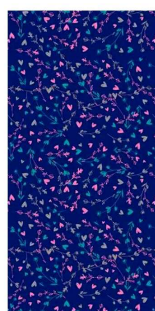

SACO PRES 15X29CM FEM MET 50X1
Código: 46189 Fábrica: GALA Unidade: PT/50 F1 F4

UN: R\$ 0,28 AV: R\$ 13,97 15: R\$ 14,26
30: R\$ 14,54 45: R\$ 14,83 60: R\$ 15,13



SACO PRES 15X29CM INF MET 50X1
Código: 46191 Fábrica: GALA Unidade: PT/50 F1 F4

UN: R\$ 0,36 AV: R\$ 17,87 15: R\$ 18,24
30: R\$ 18,61 45: R\$ 18,98 60: R\$ 19,36



SACO PRES 15X29CM JUV MET/PER 50X1
Código: 45797 Fábrica: CROMUS Unidade: PT/50 F1 F4

UN: R\$ 0,22 AV: R\$ 10,97 15: R\$ 11,20
30: R\$ 11,43 45: R\$ 11,65 60: R\$ 11,89



SACO PRES 15X30CM FEM METAL 50X1
Código: 27476 Fábrica: EMBALE Unidade: PT/50 F1 F4

UN: R\$ 0,50 AV: R\$ 24,90 15: R\$ 25,42
30: R\$ 25,93 45: R\$ 26,45 60: R\$ 26,97



SACO PRES 15X44CM LISO MET SORT 50X1
Código: 45804 Fábrica: CROMUS Unidade: PT/50 F1 F4

UN: R\$ 1,00 AV: R\$ 9,97 15: R\$ 10,18
30: R\$ 10,39 45: R\$ 10,59 60: R\$ 10,81



SACO PRES 17X30CM ORGANZA COLOR 10X1
Código: 36593 Fábrica: SOLIDER Unidade: PT/10 F1 F4

UN: R\$ 1,10 AV: R\$ 10,97 15: R\$ 11,20
30: R\$ 11,43 45: R\$ 11,65 60: R\$ 11,89



SACO PRES 18X25CM ORGANZA PRATA 10X1
Código: 36592 Fábrica: SOLIDER Unidade: PT/10 F1 F4

UN: R\$ 0,40 AV: R\$ 19,96 15: R\$ 20,37
30: R\$ 20,78 45: R\$ 21,20 60: R\$ 21,62



SACO PRES 20X29CM CASUAL METAL 50X1
Código: 27571 Fábrica: NOVO TEMPO Unidade: PT/50 F1 F4

UN: R\$ 0,50 AV: R\$ 24,82 15: R\$ 25,34
30: R\$ 25,84 45: R\$ 26,36 60: R\$ 26,89



SACO PRES 20X29CM FEM MET/PER 50X1
Código: 33568 Fábrica: GALA Unidade: PT/50 F1 F4

UN: R\$ 0,40 AV: R\$ 19,96 15: R\$ 20,37
30: R\$ 20,78 45: R\$ 21,20 60: R\$ 21,62



SACO PRES 20X30CM FEM METAL 50X1
Código: 30725 Fábrica: NOVO TEMPO Unidade: PT/50 F1 F4

UN: R\$ 0,40 AV: R\$ 19,96 15: R\$ 20,37
30: R\$ 20,78 45: R\$ 21,20 60: R\$ 21,62

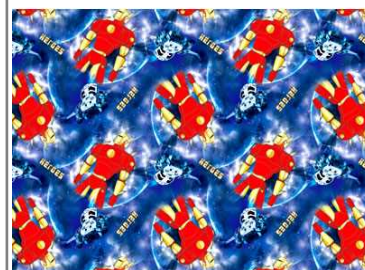

SACO PRES 20X30CM INF METAL 50X1
Código: 30722 Fábrica: VMP/NOVOTEMP Unidade: PT/50 F1 F4

UN: R\$ 0,40 AV: R\$ 19,96 15: R\$ 20,37
30: R\$ 20,78 45: R\$ 21,20 60: R\$ 21,62



SACO PRES 20X30CM LISO COLOR METAL 50X1
Código: 45803 Fábrica: NOVO TEMPO Unidade: PT/50 F1 F4

UN: R\$ 0,46 AV: R\$ 22,95 15: R\$ 23,43
30: R\$ 23,90 45: R\$ 24,38 60: R\$ 24,87

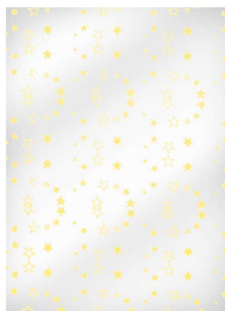

SACO PRES 20X30CM TRANSP ESTRELA AM 50X1
Código: 50021 Fábrica: MHP Unidade: PT/50 F1 F4

UN: R\$ 0,46 AV: R\$ 22,95 15: R\$ 23,43
30: R\$ 23,90 45: R\$ 24,38 60: R\$ 24,87

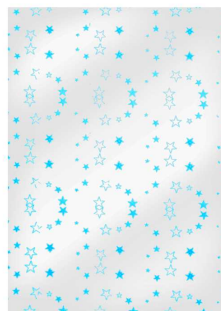

SACO PRES 20X30CM TRANSP ESTRELA AZ 50X1
Código: 50771 Fábrica: MHP Unidade: PT/50 F1 F4

UN: R\$ 0,46 AV: R\$ 22,95 15: R\$ 23,43
30: R\$ 23,90 45: R\$ 24,38 60: R\$ 24,87

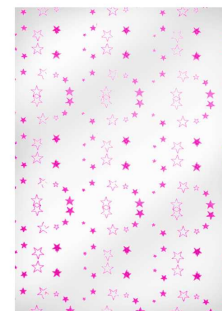

SACO PRES 20X30CM TRANSP ESTRELA RS 50X1
Código: 50025 Fábrica: MHP Unidade: PT/50 F1 F4

UN: R\$ 0,46 AV: R\$ 22,95 15: R\$ 23,43
30: R\$ 23,90 45: R\$ 24,38 60: R\$ 24,87

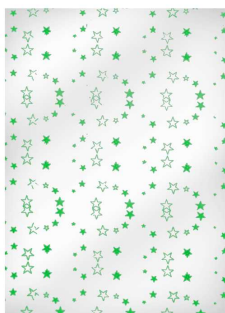

SACO PRES 20X30CM TRANSP ESTRELA VD 50X1
Código: Fábrika: Unidade:
50026 MHP PT/50
F1 F4

UN: R\$ 0,46 AV: R\$ 22,95 15: R\$ 23,43
30: R\$ 23,90 45: R\$ 24,38 60: R\$ 24,87

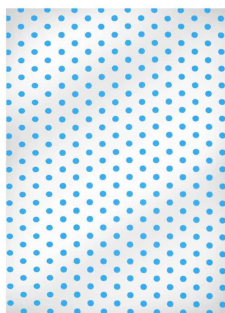

SACO PRES 20X30CM TRANSP POA AZ CL 50X1
Código: Fábrika: Unidade:
50022 MHP PT/50
F1 F4

UN: R\$ 0,46 AV: R\$ 22,95 15: R\$ 23,43
30: R\$ 23,90 45: R\$ 24,38 60: R\$ 24,87

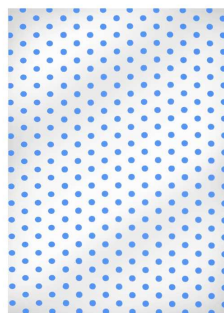

SACO PRES 20X30CM TRANSP POA AZ ES 50X1
Código: Fábrika: Unidade:
50023 MHP PT/50
F1 F4

UN: R\$ 0,46 AV: R\$ 22,95 15: R\$ 23,43
30: R\$ 23,90 45: R\$ 24,38 60: R\$ 24,87

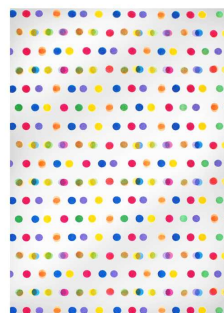

SACO PRES 20X30CM TRANSP POA COLOR 50X1
Código: Fábrika: Unidade:
50024 MHP PT/50
F1 F4

UN: R\$ 0,46 AV: R\$ 22,95 15: R\$ 23,43
30: R\$ 23,90 45: R\$ 24,38 60: R\$ 24,87

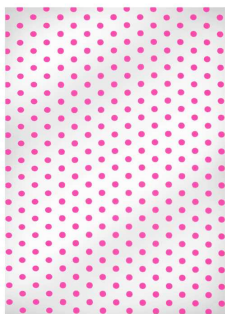

SACO PRES 20X30CM TRANSP POA ROSA 50X1
Código: Fábrika: Unidade:
50117 MHP PT/50
F1 F4

UN: R\$ 0,60 AV: R\$ 29,94 15: R\$ 30,57
30: R\$ 31,18 45: R\$ 31,80 60: R\$ 32,44

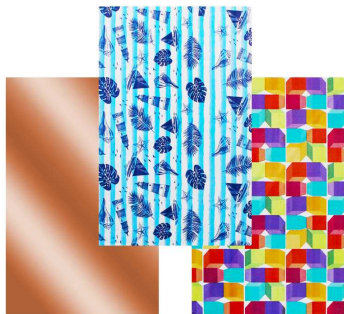

SACO PRES 25X36CM CAS METAL 50X1
Código: Fábrika: Unidade:
49675 NOVO TEMPO PT/50
F1 F4

UN: R\$ 0,60 AV: R\$ 29,94 15: R\$ 30,57
30: R\$ 31,18 45: R\$ 31,80 60: R\$ 32,44



SACO PRES 25X36CM FEM METAL 50X1
Código: Fábrika: Unidade:
27478 NOVO TEMPO PT/50
F1 F4

UN: R\$ 0,60 AV: R\$ 29,94 15: R\$ 30,57
30: R\$ 31,18 45: R\$ 31,80 60: R\$ 32,44



SACO PRES 25X36CM INF METAL 50X1
Código: Fábrika: Unidade:
30462 NOVO TEMPO PT/50
F1 F4

UN: R\$ 0,60 AV: R\$ 29,94 15: R\$ 30,57
30: R\$ 31,18 45: R\$ 31,80 60: R\$ 32,44



SACO PRES 25X36CM LISO COLOR METAL 50X1
Código: Fábrika: Unidade:
45805 NOVO TEMPO PT/50
F1 F4

UN: R\$ 0,43 AV: R\$ 21,42 15: R\$ 21,86
30: R\$ 22,30 45: R\$ 22,75 60: R\$ 23,20

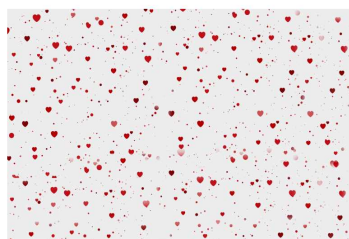

SACO PRES 25X36CM TRANSP DEC 50X1
Código: Fábrika: Unidade:
13129 NOVO TEMPO PT/50
F1 F4

UN: R\$ 0,74 AV: R\$ 36,93 15: R\$ 37,70
30: R\$ 38,45 45: R\$ 39,22 60: R\$ 40,01



SACO PRES 25X37CM SORT MET 50X1
Código: Fábrika: Unidade:
45806 CROMUS PT/50
F1 F4

UN: R\$ 0,60 AV: R\$ 29,94 15: R\$ 30,57
30: R\$ 31,18 45: R\$ 31,80 60: R\$ 32,44



SACO PRES 25X40CM COPA METAL 50X1
Código: Fábrika: Unidade:
39573 VMP PT/50
F1 F4

UN: R\$ 1,00 AV: R\$ 49,91 15: R\$ 50,95
30: R\$ 51,97 45: R\$ 53,01 60: R\$ 54,07

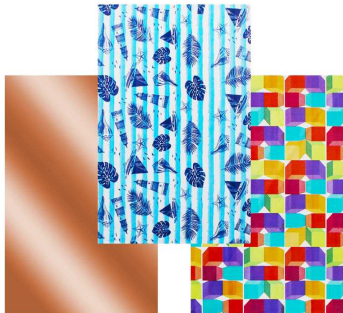

SACO PRES 30X45CM CAS METAL 50X1
Código: Fábrika: Unidade:
41633 NOVO TEMPO PT/50
F1 F4

UN: R\$ 1,00 AV: R\$ 49,91 15: R\$ 50,95
30: R\$ 51,97 45: R\$ 53,01 60: R\$ 54,07



SACO PRES 30X45CM FEM METAL 50X1
Código: Fábrika: Unidade:
22438 NOVO TEMPO PT/50
F1 F4

UN: R\$ 1,00 AV: R\$ 49,91 15: R\$ 50,95
30: R\$ 51,97 45: R\$ 53,01 60: R\$ 54,07



SACO PRES 30X45CM INF METAL 50X1
Código: Fábrika: Unidade:
22436 NOVO TEMPO PT/50
F1 F4

UN: R\$ 1,40 AV: R\$ 69,88 15: R\$ 71,33
30: R\$ 72,76 45: R\$ 74,22 60: R\$ 75,70



SACO PRES 35X53CM INF TRANSP 50X1
Código: Fábrika: Unidade:
46196 GALA PT/50
F1 F4

UN: R\$ 1,40 AV: R\$ 69,88 15: R\$ 71,33
30: R\$ 72,76 45: R\$ 74,22 60: R\$ 75,70



SACO PRES 35X53CM TRANSP STARS 50X1
Código: Fábrica: Unidade:
49670 GALA PT/50
F1 F4

UN: R\$ 1,46 AV: R\$ 72,87 15: R\$ 74,39
30: R\$ 75,88 45: R\$ 77,40 60: R\$ 78,94



SACO PRES 35X54CM BEBE MET/PER SORT 50X1
Código: Fábrica: Unidade:
45812 CROMUS PT/50
F1 F4

UN: R\$ 1,40 AV: R\$ 69,88 15: R\$ 71,33
30: R\$ 72,76 45: R\$ 74,22 60: R\$ 75,70



SACO PRES 35X54CM FEM MET 50X1
Código: Fábrica: Unidade:
30052 NOVO TEMPO PT/50
F1 F4

UN: R\$ 1,40 AV: R\$ 69,88 15: R\$ 71,33
30: R\$ 72,76 45: R\$ 74,22 60: R\$ 75,70



SACO PRES 35X54CM LISO COLOR METAL 50X1
Código: Fábrica: Unidade:
45813 NOVO TEMPO PT/50
F1 F4

UN: R\$ 1,40 AV: R\$ 69,88 15: R\$ 71,33
30: R\$ 72,76 45: R\$ 74,22 60: R\$ 75,70



SACO PRES 35X54CM NATAL METAL 50X1
Código: Fábrica: Unidade:
40092 NOVO TEMPO PT/50
F1 F4

UN: R\$ 1,42 AV: R\$ 70,89 15: R\$ 72,36
30: R\$ 73,81 45: R\$ 75,29 60: R\$ 76,79



SACO PRES 45X60CM FEM METAL 50X1
Código: Fábrica: Unidade:
22437 VMP PT/50
F1 F4

UN: R\$ 2,40 AV: R\$ 119,80 15: R\$ 122,29
30: R\$ 124,74 45: R\$ 127,23 60: R\$ 129,78



SACO PRES 50X69CM FEM MET 50X1
Código: Fábrica: Unidade:
46199 GALA PT/50
F1 F4

UN: R\$ 2,40 AV: R\$ 119,80 15: R\$ 122,29
30: R\$ 124,74 45: R\$ 127,23 60: R\$ 129,78



SACO PRES 50X69CM INF MET 50X1
Código: Fábrica: Unidade:
46198 GALA PT/50
F1 F4

UN: R\$ 3,35 AV: R\$ 83,86 15: R\$ 85,60
30: R\$ 87,31 45: R\$ 89,06 60: R\$ 90,84



SACO PRES 50X70CM DOURADO LISO MET 25X1
Código: Fábrica: Unidade:
43797 CROMUS PT/25
F1 F4

UN: R\$ 2,99 AV: R\$ 74,87 15: R\$ 76,43
30: R\$ 77,96 45: R\$ 79,52 60: R\$ 81,11



SACO PRES 50X70CM FEM FLORAL 25X1
Código: Fábrica: Unidade:
44048 CROMUS PT/25
F1 F4

UN: R\$ 3,19 AV: R\$ 79,86 15: R\$ 81,53
30: R\$ 83,16 45: R\$ 84,82 60: R\$ 86,52



SACO PRES 50X70CM FEM/ROM MET/PEROL 25X1
Código: Fábrica: Unidade:
40111 CROMUS PT/25
F1 F4

UN: R\$ 3,35 AV: R\$ 83,86 15: R\$ 85,60
30: R\$ 87,31 45: R\$ 89,06 60: R\$ 90,84

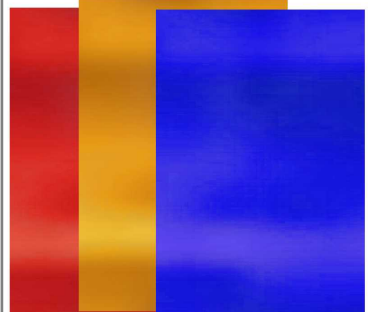

SACO PRES 50X70CM LISO SORT MET 25X1
Código: Fábrica: Unidade:
40090 CROMUS PT/25
F1 F4

UN: R\$ 3,29 AV: R\$ 82,24 15: R\$ 83,95
30: R\$ 85,63 45: R\$ 87,34 60: R\$ 89,09



SACO PRES 50X70CM POA MET 25X1
Código: Fábrica: Unidade:
44999 CROMUS PT/25
F1 F4

UN: R\$ 3,59 AV: R\$ 89,85 15: R\$ 91,72
30: R\$ 93,55 45: R\$ 95,42 60: R\$ 97,33



SACO PRES 50X70CM SORT MET 25X1
Código: Fábrica: Unidade:
40112 CROMUS PT/25
F1 F4

UN: R\$ 3,00 AV: R\$ 149,75 15: R\$ 152,87
30: R\$ 155,93 45: R\$ 159,05 60: R\$ 162,23

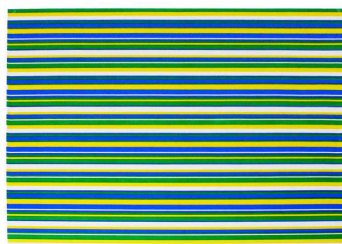

SACO PRES 50X74CM PRATA METAL 50X1
Código: Fábrica: Unidade:
39575 VMP PT/50
F1 F4

UN: R\$ 3,99 AV: R\$ 99,83 15: R\$ 101,91
30: R\$ 103,95 45: R\$ 106,03 60: R\$ 108,15

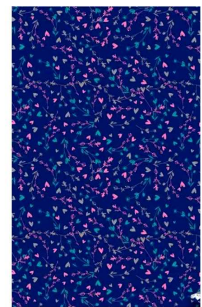

SACO PRES 58X89CM FEM MET 25X1
Código: Fábrica: Unidade:
46192 GALA PT/25
F1 F4

UN: R\$ 3,99 AV: R\$ 99,83 15: R\$ 101,91
30: R\$ 103,95 45: R\$ 106,03 60: R\$ 108,15



SACO PRES 58X89CM INF MET 25X1

Código: 46194 Fábrica: GALA Unidade: PT/25 F1 F4

UN: R\$ 3,99 AV: R\$ 99,83 15: R\$ 101,91
30: R\$ 103,95 45: R\$ 106,03 60: R\$ 108,15



SACO PRES 58X89CM INF TRANSP 25X1

Código: 46195 Fábrica: GALA Unidade: PT/25 F1 F4

UN: R\$ 4,79 AV: R\$ 119,80 15: R\$ 122,29
30: R\$ 124,74 45: R\$ 127,23 60: R\$ 129,78



90 cm
60 cm

SACO PRES 60X90CM FEM MET 25X1

Código: 40520 Fábrica: CROMUS Unidade: PT/25 F1 F4

UN: R\$ 3,79 AV: R\$ 94,84 15: R\$ 96,81
30: R\$ 98,75 45: R\$ 100,73 60: R\$ 102,74



SACO PRES 60X90CM FEM METAL 25X1

Código: 41628 Fábrica: CG PACK Unidade: PT/25 F1 F4

UN: R\$ 3,99 AV: R\$ 99,83 15: R\$ 101,91
30: R\$ 103,95 45: R\$ 106,03 60: R\$ 108,15



SACO PRES 60X90CM FEM METAL 25X1

Código: 40097 Fábrica: CROMUS Unidade: PT/25 F1 F4

UN: R\$ 3,79 AV: R\$ 94,84 15: R\$ 96,81
30: R\$ 98,75 45: R\$ 100,73 60: R\$ 102,74



SACO PRES 60X90CM INF METAL 25X1

Código: 42736 Fábrica: CG PACK Unidade: PT/25 F1 F4

UN: R\$ 5,19 AV: R\$ 129,78 15: R\$ 132,49
30: R\$ 135,14 45: R\$ 137,84 60: R\$ 140,60

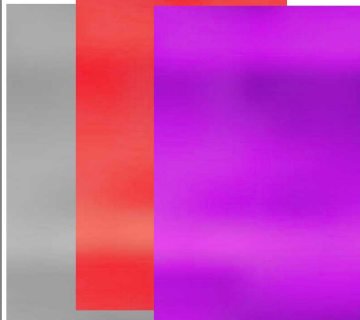

SACO PRES 60X90CM LISO SORT MET 25X1

Código: 40095 Fábrica: CROMUS Unidade: PT/25 F1 F4

UN: R\$ 4,79 AV: R\$ 119,80 15: R\$ 122,29
30: R\$ 124,74 45: R\$ 127,23 60: R\$ 129,78



90 cm
60 cm

SACO PRES 60X90CM SORT MET 25X1

Código: 40521 Fábrica: CROMUS Unidade: PT/25 F1 F4

UN: R\$ 9,58 AV: R\$ 239,61 15: R\$ 244,60
30: R\$ 249,49 45: R\$ 254,48 60: R\$ 259,57



SACO PRES 89X1,20M BEBE/INF/JUV MET 25X1

Código: 45810 Fábrica: CROMUS Unidade: PT/25 F1 F4

UN: R\$ 9,58 AV: R\$ 239,61 15: R\$ 244,60
30: R\$ 249,49 45: R\$ 254,48 60: R\$ 259,57



1,20 m
89 cm

SACO PRES 89X1,20M FEM METAL 25X1

Código: 21047 Fábrica: CROMUS Unidade: PT/25 F1 F4

UN: R\$ 8,79 AV: R\$ 219,64 15: R\$ 224,21
30: R\$ 228,70 45: R\$ 233,27 60: R\$ 237,94



SACO PRES 90X1,18M CASUAL METAL 25X1

Código: 42734 Fábrica: CG PACK Unidade: PT/25 F1 F4

UN: R\$ 2,90 AV: R\$ 2,90 15: R\$ 2,96
30: R\$ 3,01 45: R\$ 3,08 60: R\$ 3,14

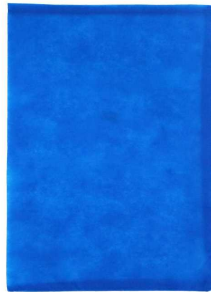

SACO TNT LISO 25X35CM UN

Código: 46749 Fábrica: ALINE Unidade: UN/1 F1 F4

UN: R\$ 1,10 AV: R\$ 10,97 15: R\$ 11,20
30: R\$ 11,43 45: R\$ 11,65 60: R\$ 11,89



SACOLA KRAFT 13,5X8X16CM 1116 10X1

Código: 41684 Fábrica: SCRITY Unidade: PT/10 F1 F4

16cm
13,5cm
8cm

UN: R\$ 2,81 AV: R\$ 33,70 15: R\$ 34,40
30: R\$ 35,09 45: R\$ 35,79 60: R\$ 36,50



SACOLA PAP PRES 18X23CM FITA 625 12X1

Código: 45951 Fábrica: WINMAX Unidade: PT/12 F1 F4

18cm
23cm

UN: R\$ 10,00 AV: R\$ 120,01 15: R\$ 122,51
30: R\$ 124,96 45: R\$ 127,46 60: R\$ 130,01



SACOLA PAP PRES 26X32CM FITA 626 12X1

Código: 45953 Fábrica: WINMAX Unidade: PT/12 F1 F4

32cm
26cm

UN: R\$ 12,39 AV: R\$ 148,66 15: R\$ 151,76
30: R\$ 154,79 45: R\$ 157,89 60: R\$ 161,05



SACOLA PAP PRES 30X41,5CM FITA 627 12X1

Código: 45954 Fábrica: WINMAX Unidade: PT/12 F1 F4

41,5cm
30cm

UN: R\$ 244,61 AV: R\$ 244,61 15: R\$ 249,70
30: R\$ 254,70 45: R\$ 259,79 60: R\$ 264,99

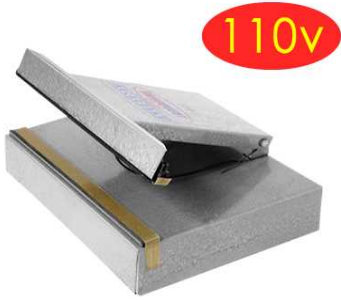

110v

SELADORA MESA P/PLASTICO 30CM L 110V
Código: Fábrika: Unidade:
32225 BRASQUENT UN/1
F1 F4

UN: R\$ 0,40 AV: R\$ 9,98 15: R\$ 10,19
30: R\$ 10,40 45: R\$ 10,60 60: R\$ 10,82

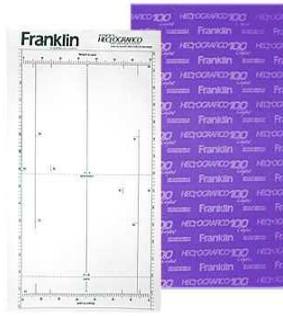

STENCIL ROXO 25X1
Código: Fábrika: Unidade:
4302 FRANKLIN C//25
F1 F4

UN: R\$ 21,95 AV: R\$ 21,95 15: R\$ 22,41
30: R\$ 22,86 45: R\$ 23,32 60: R\$ 23,78



SUPORTE DISPLAY DE PAREDE A4/OF 227
Código: Fábrika: Unidade:
50156 ACRINIL UN/1
F1 F4

UN: R\$ 24,95 AV: R\$ 24,95 15: R\$ 25,47
30: R\$ 25,98 45: R\$ 26,50 60: R\$ 27,03



SUPORTE FITA ADESIVA GDE PRETO 526
Código: Fábrika: Unidade:
41802 CARBRINK UN/1
F1 F4

UN: R\$ 44,92 AV: R\$ 44,92 15: R\$ 45,85
30: R\$ 46,77 45: R\$ 47,71 60: R\$ 48,66



SUPORTE FITA ADESIVA GDE 19,5CM PRETO
Código: Fábrika: Unidade:
38255 MAXCRIL CX/1
F1 F4

UN: R\$ 19,96 AV: R\$ 19,96 15: R\$ 20,37
30: R\$ 20,78 45: R\$ 21,20 60: R\$ 21,62



SUPORTE FITA ADESIVA PEQ 12CM AZUL 1011
Código: Fábrika: Unidade:
44058 MAXCRIL CX/1
F1 F4

UN: R\$ 19,96 AV: R\$ 19,96 15: R\$ 20,37
30: R\$ 20,78 45: R\$ 21,20 60: R\$ 21,62



SUPORTE FITA ADESIVA PEQ 12CM PRETO 1009
Código: Fábrika: Unidade:
50760 MAXCRIL CX/1
F1 F4

UN: R\$ 34,93 AV: R\$ 34,93 15: R\$ 35,66
30: R\$ 36,38 45: R\$ 37,10 60: R\$ 37,84



SUPORTE METAL FITA LACRADORA 901
Código: Fábrika: Unidade:
39786 MASTERPRINT UN/1
F1 F4

UN: R\$ 128,79 AV: R\$ 128,79 15: R\$ 131,48
30: R\$ 134,11 45: R\$ 136,79 60: R\$ 139,52



SUPORTE P/BOBINA 40CM
Código: Fábrika: Unidade:
33499 STALO UN/1
F1 F4

UN: R\$ 352,75 AV: R\$ 352,75 15: R\$ 360,10
30: R\$ 367,31 45: R\$ 374,65 60: R\$ 382,15



SUPORTE P/BOBINA 60CM
Código: Fábrika: Unidade:
33500 SAO JOAO UN/1
F1 F4

UN: R\$ 1,85 AV: R\$ 1,85 15: R\$ 1,89
30: R\$ 1,92 45: R\$ 1,96 60: R\$ 2,00



TABELA PERIODICA ATUALIZADA
Código: Fábrika: Unidade:
48482 BRASILEITURA UN/1
F1 F4

UN: R\$ 2,00 AV: R\$ 59,87 15: R\$ 61,12
30: R\$ 62,34 45: R\$ 63,59 60: R\$ 64,86

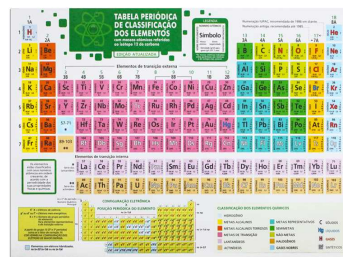

TABUADA COMPLETA 10X15CM 16 PAG 30X1
Código: Fábrika: Unidade:
29636 PARRKE PT/30
F1 F4

UN: R\$ 3,12 AV: R\$ 62,50 15: R\$ 63,80
30: R\$ 65,08 45: R\$ 66,38 60: R\$ 67,71



TALAO COMANDO 2 CORPOS NUM 100FLS 20X1
Código: Fábrika: Unidade:
17966 PARRKE PT/20
F1 F4

UN: R\$ 17,57 AV: R\$ 87,85 15: R\$ 89,68
30: R\$ 91,47 45: R\$ 93,30 60: R\$ 95,17



TALAO CONTRATO LOCAAO 100FLS 5X1
Código: Fábrika: Unidade:
12553 PARRKE PT/5
F1 F4

UN: R\$ 8,93 AV: R\$ 44,63 15: R\$ 45,56
30: R\$ 46,47 45: R\$ 47,40 60: R\$ 48,35



TALAO MOVIMENTO CX 100FLS 5X1
Código: Fábrika: Unidade:
14431 PARRKE PT/5
F1 F4

UN: R\$ 15,97 AV: R\$ 79,86 15: R\$ 81,53
30: R\$ 83,16 45: R\$ 84,82 60: R\$ 86,52



TALAO MOVIMENTO CX 100FLS 215X315MM 5X1
Código: Fábrika: Unidade:
14432 PARRKE PT/5
F1 F4

UN: R\$ 1,80 AV: R\$ 35,91 15: R\$ 36,66
30: R\$ 37,39 45: R\$ 38,14 60: R\$ 38,90



TALAO NOTA NEUTRA 1/36 C/COPIA 25X2 20X1
Código: Fábrica: Unidade:
17123 PARRKE PT/20
F1 F4

UN: R\$ 1,80 AV: R\$ 35,91 15: R\$ 36,66
30: R\$ 37,39 45: R\$ 38,14 60: R\$ 38,90



TALAO NOTA NEUTRA 1/36 S/COP 50FLS 20X1
Código: Fábrica: Unidade:
17512 PARRKE PT/20
F1 F4

UN: R\$ 1,50 AV: R\$ 29,94 15: R\$ 30,57
30: R\$ 31,18 45: R\$ 31,80 60: R\$ 32,44

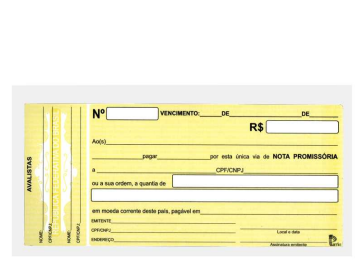

TALAO NOTA PROMISSORIA MINI 50 FLS 20X1
Código: Fábrica: Unidade:
12551 PARRKE PT/20
F1 F4

UN: R\$ 2,35 AV: R\$ 46,91 15: R\$ 47,89
30: R\$ 48,85 45: R\$ 49,83 60: R\$ 50,82



TALAO NOTA PROMISSORIA 50FLS 20X1
Código: Fábrica: Unidade:
12550 PARRKE PT/20
F1 F4

UN: R\$ 1,85 AV: R\$ 36,93 15: R\$ 37,70
30: R\$ 38,45 45: R\$ 39,22 60: R\$ 40,01

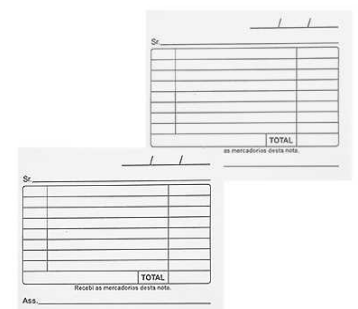

TALAO NOTINHA 1/72 100FLS 7,5X10,5 20X1
Código: Fábrica: Unidade:
17965 PARRKE PT/20
F1 F4

UN: R\$ 3,56 AV: R\$ 71,27 15: R\$ 72,75
30: R\$ 74,21 45: R\$ 75,69 60: R\$ 77,20

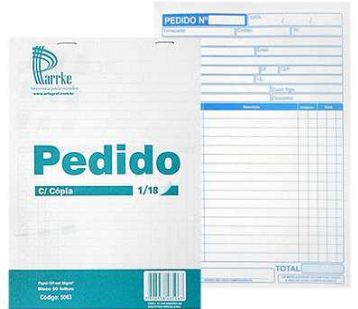

TALAO PEDIDO 1/18 25X2 FL 15X21 C/C 20X1
Código: Fábrica: Unidade:
12546 PARRKE PT/20
F1 F4

UN: R\$ 3,56 AV: R\$ 71,27 15: R\$ 72,75
30: R\$ 74,21 45: R\$ 75,69 60: R\$ 77,20



TALAO PEDIDO 1/18 50FLS 15X21 S/C 20X1
Código: Fábrica: Unidade:
19007 PARRKE PT/20
F1 F4

UN: R\$ 6,89 AV: R\$ 68,88 15: R\$ 70,31
30: R\$ 71,72 45: R\$ 73,16 60: R\$ 74,62

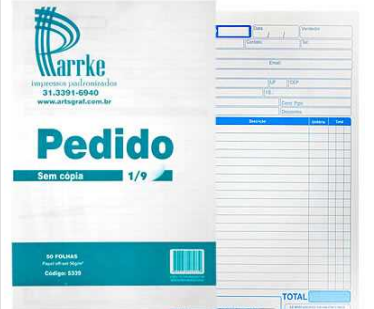

TALAO PEDIDO 1/9 S/COPIA 50FLS 10X1
Código: Fábrica: Unidade:
12549 PARRKE PT/10
F1 F4

UN: R\$ 6,34 AV: R\$ 63,40 15: R\$ 64,72
30: R\$ 66,01 45: R\$ 67,33 60: R\$ 68,68



TALAO PEDIDO 1/9 25X2 210X310MM 10X1
Código: Fábrica: Unidade:
12548 PARRKE PT/10
F1 F4

UN: R\$ 2,45 AV: R\$ 48,91 15: R\$ 49,93
30: R\$ 50,93 45: R\$ 51,95 60: R\$ 52,99



TALAO RECIBO ALUGUEL 50FLS C/CANHO 20X1
Código: Fábrica: Unidade:
14420 PARRKE PT/20
F1 F4

UN: R\$ 2,37 AV: R\$ 47,42 15: R\$ 48,41
30: R\$ 49,38 45: R\$ 50,37 60: R\$ 51,38



TALAO RECIBO COMERCIAL C/CANH 50FLS 20X1
Código: Fábrica: Unidade:
6136 PARRKE PT/20
F1 F4

UN: R\$ 1,85 AV: R\$ 36,93 15: R\$ 37,70
30: R\$ 38,45 45: R\$ 39,22 60: R\$ 40,01



TALAO RECIBO COMERCIAL S/CANH 50FLS 20X1
Código: Fábrica: Unidade:
12552 PARRKE PT/20
F1 F4

UN: R\$ 1,60 AV: R\$ 31,94 15: R\$ 32,60
30: R\$ 33,26 45: R\$ 33,92 60: R\$ 34,60



TALAO RECIBO CONDOMINIO C/CANH 50FL 20X1
Código: Fábrica: Unidade:
14421 PARRKE PT/20
F1 F4

UN: R\$ 2,45 AV: R\$ 48,91 15: R\$ 49,93
30: R\$ 50,93 45: R\$ 51,95 60: R\$ 52,99



TALAO RECIBO PGTO EMPREG DOMEST 50FLS
Código: Fábrica: Unidade:
14419 PARRKE PT/20
F1 F4

UN: R\$ 3,00 AV: R\$ 59,90 15: R\$ 61,15
30: R\$ 62,38 45: R\$ 63,62 60: R\$ 64,90

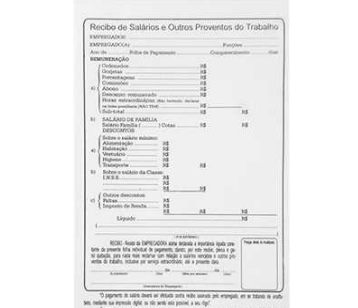

TALAO RECIBO SALARIOS OUTR PROV 50F 20X1
Código: Fábrica: Unidade:
14422 MINASPEL PT/20
F1 F4

UN: R\$ 2,64 AV: R\$ 26,41 15: R\$ 26,96
30: R\$ 27,50 45: R\$ 28,05 60: R\$ 28,61



TALAO TRANSF VEICULO DOC DE CADAST DET
Código: Fábrica: Unidade:
14430 PARRKE PT/10
F1 F4

UN: R\$ 0,59 AV: R\$ 11,77 15: R\$ 12,15
30: R\$ 12,51 45: R\$ 12,89 60: R\$ 13,27



TALAO VALE C/CANHOTO 50 FLS 20X1
Código: 14417 Fábrica: PARRKE Unidade: PT/20 F1 F4

UN: R\$ 1,10 AV: R\$ 10,98 15: R\$ 11,21
30: R\$ 11,44 45: R\$ 11,66 60: R\$ 11,90



TALAO VALE S/CANHOTO C/AZUREE 50 FLS 10X1
Código: 6138 Fábrica: SAO DOMINGOS Unidade: PT/10 F1 F4

UN: R\$ 1,02 AV: R\$ 20,47 15: R\$ 20,89
30: R\$ 21,31 45: R\$ 21,74 60: R\$ 22,17



TALAO VALE S/CANHOTO 50 FLS 20X1
Código: 12545 Fábrica: PARRKE Unidade: PT/20 F1 F4

UN: R\$ 42,92 AV: R\$ 42,92 15: R\$ 43,82
30: R\$ 44,69 45: R\$ 45,59 60: R\$ 46,50



TECLADO USB DESIGN A PROVA D'ÁGUA 74327
Código: 35800 Fábrica: LETRON Unidade: UN/1 F1 F4

UN: R\$ 499,19 AV: R\$ 499,19 15: R\$ 509,59
30: R\$ 519,78 45: R\$ 530,18 60: R\$ 540,78



TELA JUTA ABERTA P9 1000MM 25MTS
Código: 42029 Fábrica: PLAST CO Unidade: RL/1 F1 F4

UN: R\$ 21,94 AV: R\$ 1097,24 15: R\$ 1120,10
30: R\$ 1142,50 45: R\$ 1165,35 60: R\$ 1188,65



TELA JUTA NATURAL P9 50MTS
Código: 50951 Fábrica: ABL Unidade: RL/50 F1 F4

UN: R\$ 9,28 AV: R\$ 9,28 15: R\$ 9,47
30: R\$ 9,66 45: R\$ 9,85 60: R\$ 10,05



TELA PINTURA C/CHASSI MDF 16X22CM 001
Código: 46319 Fábrica: PAPER TOYS Unidade: UN/1 F1 F4

UN: R\$ 16,56 AV: R\$ 16,56 15: R\$ 16,91
30: R\$ 17,25 45: R\$ 17,59 60: R\$ 17,94



TELA PINTURA C/CHASSI MDF 30X30CM 004
Código: 46316 Fábrica: PAPER TOYS Unidade: UN/1 F1 F4

UN: R\$ 19,43 AV: R\$ 19,43 15: R\$ 19,83
30: R\$ 20,23 45: R\$ 20,63 60: R\$ 21,05



TELA PINTURA C/CHASSI MDF 30X40CM 005
Código: 46315 Fábrica: PAPER TOYS Unidade: UN/1 F1 F4

UN: R\$ 28,04 AV: R\$ 28,04 15: R\$ 28,62
30: R\$ 29,19 45: R\$ 29,78 60: R\$ 30,37



TELA PINTURA C/CHASSI MDF 40X50CM 006
Código: 46314 Fábrica: PAPER TOYS Unidade: UN/1 F1 F4

UN: R\$ 8,68 AV: R\$ 8,68 15: R\$ 8,86
30: R\$ 9,03 45: R\$ 9,21 60: R\$ 9,40



TELA P/PINTURA 15X22CM 4758
Código: 49326 Fábrica: STALO Unidade: UN/1 F1 F4

UN: R\$ 9,73 AV: R\$ 9,73 15: R\$ 9,94
30: R\$ 10,14 45: R\$ 10,34 60: R\$ 10,55



TELA P/PINTURA 18X24CM 4818
Código: 50775 Fábrica: STALO Unidade: UN/1 F1 F4

UN: R\$ 10,97 AV: R\$ 10,97 15: R\$ 11,20
30: R\$ 11,43 45: R\$ 11,65 60: R\$ 11,89



TELA P/PINTURA 20X20CM 4760/8626
Código: 49327 Fábrica: STALO Unidade: UN/1 F1 F4

UN: R\$ 14,97 AV: R\$ 14,97 15: R\$ 15,28
30: R\$ 15,58 45: R\$ 15,90 60: R\$ 16,21



TELA P/PINTURA 20X29CM PAPEL 010060
Código: 47885 Fábrica: RIDET Unidade: UN/1 F1 F4

UN: R\$ 12,32 AV: R\$ 12,32 15: R\$ 12,58
30: R\$ 12,83 45: R\$ 13,09 60: R\$ 13,35



TELA P/PINTURA 20X30CM 8167/8604
Código: 45634 Fábrica: STALO Unidade: UN/1 F1 F4

UN: R\$ 14,93 AV: R\$ 14,93 15: R\$ 15,24
30: R\$ 15,54 45: R\$ 15,85 60: R\$ 16,17



TELA P/PINTURA 30X30CM 8627
Código: 49328 Fábrica: CORTIARTE Unidade: UN/1 F1 F4

UN: R\$ 17,30 AV: R\$ 17,30 15: R\$ 17,66
30: R\$ 18,02 45: R\$ 18,38 60: R\$ 18,74

30cm
40cm



TELA P/PINTURA 30X40CM 8606

Código: 49329 Fábrica: CORTIARTE Unidade: UN/1 F1 F4

UN: R\$ 54,36 AV: R\$ 54,36 15: R\$ 55,50
30: R\$ 56,61 45: R\$ 57,74 60: R\$ 58,89



TELA P/PINTURA 50X70CM 8627/9584

Código: 50149 Fábrica: STALO/CORTIA Unidade: UN/1 F1 F4

UN: R\$ 10,67 AV: R\$ 10,67 15: R\$ 10,90
30: R\$ 11,11 45: R\$ 11,34 60: R\$ 11,56



TERMOLINA LEITOSA 100 ML 16510

Código: 44820 Fábrica: ACRILEX Unidade: UN/1 F1 F4

UN: R\$ 21,47 AV: R\$ 21,47 15: R\$ 21,91
30: R\$ 22,35 45: R\$ 22,80 60: R\$ 23,25



TERMOLINA LEITOSA 250 ML 16525

Código: 44817 Fábrica: ACRILEX Unidade: UN/1 F1 F4

UN: R\$ 57,90 AV: R\$ 57,90 15: R\$ 59,10
30: R\$ 60,29 45: R\$ 61,49 60: R\$ 62,72



TERMOLINA LEITOSA 500 ML

Código: 47876 Fábrica: ACRILEX Unidade: UN/1 F1 F4

UN: R\$ 2,19 AV: R\$ 26,24 15: R\$ 26,78
30: R\$ 27,32 45: R\$ 27,87 60: R\$ 28,42



TESOURA ESC ACO GALV 13CM 2199 CTL 12X1

Código: 44118 Fábrica: PLANETA Unidade: CR/12 F1 F4

UN: R\$ 2,66 AV: R\$ 159,73 15: R\$ 163,06
30: R\$ 166,32 45: R\$ 169,65 60: R\$ 173,04



TESOURA ESC CB PLAST PTO 13CM 4195 60X1

Código: 45228 Fábrica: LEO&LEO Unidade: CX/60 F1 F4

UN: R\$ 5,98 AV: R\$ 5,98 15: R\$ 6,11
30: R\$ 6,23 45: R\$ 6,35 60: R\$ 6,48



TESOURA ESC INOX S/PON CB PRETO CTL 4592

Código: 24963 Fábrica: LEO&LEO Unidade: CR/1 F1 F4

UN: R\$ 3,33 AV: R\$ 79,86 15: R\$ 81,53
30: R\$ 83,16 45: R\$ 84,82 60: R\$ 86,52



TESOURA ESC INOX 13CM BLACK EMB IND 24X1

Código: 40917 Fábrica: LEO&LEO Unidade: CX/24 F1 F4

UN: R\$ 3,74 AV: R\$ 89,85 15: R\$ 91,72
30: R\$ 93,55 45: R\$ 95,42 60: R\$ 97,33



TESOURA ESC INOX 13CM CLUB COLOR 24X1

Código: 48318 Fábrica: BAZZE Unidade: CX/24 F1 F4

UN: R\$ 3,14 AV: R\$ 3,14 15: R\$ 3,21
30: R\$ 3,27 45: R\$ 3,34 60: R\$ 3,41



TESOURA ESC 13CM CAB PLAST PONTA RED SOL

Código: 48594 Fábrica: WIN PAPER Unidade: UN/1 F1 F4

UN: R\$ 2,91 AV: R\$ 69,88 15: R\$ 71,33
30: R\$ 72,76 45: R\$ 74,22 60: R\$ 75,70



TESOURA ESC 13CM CB COLOR 501 24X1

Código: 42239 Fábrica: MASTERPRINT Unidade: CX/24 F1 F4

UN: R\$ 2,91 AV: R\$ 69,88 15: R\$ 71,33
30: R\$ 72,76 45: R\$ 74,22 60: R\$ 75,70



TESOURA ESC 13CM CB COLOR 503 24X1

Código: 51050 Fábrica: MASTERPRINT Unidade: CX/24 F1 F4

UN: R\$ 3,16 AV: R\$ 189,69 15: R\$ 193,64
30: R\$ 197,51 45: R\$ 201,46 60: R\$ 205,49



TESOURA ESC 13CM CB PLAST 103 60X1

Código: 42456 Fábrica: GATTE Unidade: CX/60 F1 F4

UN: R\$ 2,91 AV: R\$ 69,88 15: R\$ 71,33
30: R\$ 72,76 45: R\$ 74,22 60: R\$ 75,70



TESOURA ESC 13CM CB PRETO 502 24X1

Código: 42238 Fábrica: MASTERPRINT Unidade: CX/24 F1 F4

UN: R\$ 5,48 AV: R\$ 5,48 15: R\$ 5,60
30: R\$ 5,71 45: R\$ 5,82 60: R\$ 5,94



TESOURA ESC 13CM PIC CORTE CRIATIV 15127

Código: 33752 Fábrica: WIN PAPER Unidade: UN/1 F1 F4

UN: R\$ 3,98 AV: R\$ 3,98 15: R\$ 4,07
30: R\$ 4,15 45: R\$ 4,23 60: R\$ 4,32



TESOURA ESC 16,5CM 6,5" CB PLAST 13717

Código: Fábrica: Unidade:
41446 MABEL UN/1
F1 F4

UN: R\$ 7,98 AV: R\$ 7,98 15: R\$ 8,14
30: R\$ 8,31 45: R\$ 8,47 60: R\$ 8,64



TESOURA INOX ESC COLOR 11,5CM 167M

Código: Fábrica: Unidade:
44099 MUNDIAL UN/1
F1 F4

UN: R\$ 7,98 AV: R\$ 7,98 15: R\$ 8,14
30: R\$ 8,31 45: R\$ 8,47 60: R\$ 8,64



TESOURA INOX ESC PRETA 11,5CM 167BK

Código: Fábrica: Unidade:
44100 MUNDIAL UN/1
F1 F4

UN: R\$ 4,58 AV: R\$ 4,58 15: R\$ 4,68
30: R\$ 4,77 45: R\$ 4,87 60: R\$ 4,96



TESOURA INOX ESCOLAR PUMAX 10,5CM ' 900

Código: Fábrica: Unidade:
41615 MUNDIAL UN/1
F1 F4

UN: R\$ 44,92 AV: R\$ 44,92 15: R\$ 45,85
30: R\$ 46,77 45: R\$ 47,71 60: R\$ 48,66



TESOURA INOX MULTIUSO PROF 23,5CM 91018

Código: Fábrica: Unidade:
48360 LEO&LEO CR/1
F1 F4

UN: R\$ 6,65 AV: R\$ 6,65 15: R\$ 6,79
30: R\$ 6,92 45: R\$ 7,06 60: R\$ 7,20



TESOURA INOX 13,5CM PONTA RETA CTL 15006

Código: Fábrica: Unidade:
48357 WIN PAPER CR/1
F1 F4

UN: R\$ 8,48 AV: R\$ 8,48 15: R\$ 8,65
30: R\$ 8,83 45: R\$ 9,00 60: R\$ 9,18



TESOURA INOX 20 CM MULTIUSO SOL 2413015

Código: Fábrica: Unidade:
41096 ONDA UN/1
F1 F4

UN: R\$ 9,48 AV: R\$ 9,48 15: R\$ 9,68
30: R\$ 9,88 45: R\$ 10,07 60: R\$ 10,28



TESOURA INOX 21 CM MULTIUSO 61

Código: Fábrica: Unidade:
45392 NOX CR/1
F1 F4

UN: R\$ 9,78 AV: R\$ 9,78 15: R\$ 9,99
30: R\$ 10,19 45: R\$ 10,39 60: R\$ 10,60



TESOURA INOX 21 CM MULTIUSO 720

Código: Fábrica: Unidade:
40888 JOCAROFFICE CR/1
F1 F4

UN: R\$ 8,59 AV: R\$ 8,59 15: R\$ 8,77
30: R\$ 8,94 45: R\$ 9,12 60: R\$ 9,30



TESOURA PIC CORTE CRIATIVO CTL 141204

Código: Fábrica: Unidade:
46383 FUTURO UN/1
F1 F4

UN: R\$ 9,83 AV: R\$ 9,83 15: R\$ 10,04
30: R\$ 10,24 45: R\$ 10,44 60: R\$ 10,65



TESOURA PICO CORTE CRIATIVO ZIG ZAG 1001

Código: Fábrica: Unidade:
9556 BRW UN/1
F1 F4

UN: R\$ 6,90 AV: R\$ 82,86 15: R\$ 84,58
30: R\$ 86,28 45: R\$ 88,00 60: R\$ 89,76



TESOURA PICOTAR INOX 13CM 2299 12X1

Código: Fábrica: Unidade:
40788 PLANETA CX/12
F1 F4

UN: R\$ 99,83 AV: R\$ 99,83 15: R\$ 101,91
30: R\$ 103,95 45: R\$ 106,03 60: R\$ 108,15



TESOURA PICOTAR INOX 23CM ONDA 1418 9"

Código: Fábrica: Unidade:
43855 LIKE CR/1
F1 F4

UN: R\$ 67,88 AV: R\$ 67,88 15: R\$ 69,30
30: R\$ 70,68 45: R\$ 72,09 60: R\$ 73,54



TESOURA PICOTAR INOX 9" 23CM ONDA 513

Código: Fábrica: Unidade:
42241 MASTERPRINT CR/1
F1 F4

UN: R\$ 69,88 AV: R\$ 69,88 15: R\$ 71,33
30: R\$ 72,76 45: R\$ 74,22 60: R\$ 75,70



TESOURA PICOTAR 24CM CTL 4375

Código: Fábrica: Unidade:
31535 LEO&LEO CR/1
F1 F4

UN: R\$ 4,16 AV: R\$ 49,91 15: R\$ 50,95
30: R\$ 51,97 45: R\$ 53,01 60: R\$ 54,07



TESOURINHA DOBRAVEL 12X1

Código: Fábrica: Unidade:
3253 NYBC CX/12
F1 F4

UN: R\$ 14,61 AV: R\$ 87,66 15: R\$ 89,49
30: R\$ 91,28 45: R\$ 93,10 60: R\$ 94,96



TINTA A OLEO P/TELA 20ML SORTIDO 6X1

Código: 49307 Fábrica: ACRILEX Unidade: CX/6
F1 F4

UN: R\$ 14,61 AV: R\$ 87,66 15: R\$ 89,49
30: R\$ 91,28 45: R\$ 93,10 60: R\$ 94,96



TINTA A OLEO P/TELA 20ML 304 AMARELO 6X1

Código: 48223 Fábrica: ACRILEX Unidade: CX/6
F1 F4

UN: R\$ 14,61 AV: R\$ 87,66 15: R\$ 89,49
30: R\$ 91,28 45: R\$ 93,10 60: R\$ 94,96



TINTA A OLEO P/TELA 20ML 307 ALARANJ 6X1

Código: 48224 Fábrica: ACRILEX Unidade: CX/6
F1 F4

UN: R\$ 14,61 AV: R\$ 87,66 15: R\$ 89,49
30: R\$ 91,28 45: R\$ 93,10 60: R\$ 94,96



TINTA A OLEO P/TELA 20ML 309 AZUL CE 6X1

Código: 48225 Fábrica: ACRILEX Unidade: CX/6
F1 F4

UN: R\$ 14,61 AV: R\$ 87,66 15: R\$ 89,49
30: R\$ 91,28 45: R\$ 93,10 60: R\$ 94,96



TINTA A OLEO P/TELA 20ML 312 VERMELH 6X1

Código: 48226 Fábrica: ACRILEX Unidade: CX/6
F1 F4

UN: R\$ 14,61 AV: R\$ 87,66 15: R\$ 89,49
30: R\$ 91,28 45: R\$ 93,10 60: R\$ 94,96



TINTA A OLEO P/TELA 20ML 313 VERMELH 6X1

Código: 48227 Fábrica: ACRILEX Unidade: CX/6
F1 F4

UN: R\$ 14,61 AV: R\$ 87,66 15: R\$ 89,49
30: R\$ 91,28 45: R\$ 93,10 60: R\$ 94,96



TINTA A OLEO P/TELA 20ML 316 ROSA ES 6X1

Código: 48228 Fábrica: ACRILEX Unidade: CX/6
F1 F4

UN: R\$ 14,61 AV: R\$ 87,66 15: R\$ 89,49
30: R\$ 91,28 45: R\$ 93,10 60: R\$ 94,96



TINTA A OLEO P/TELA 20ML 319 BRANCO 6X1

Código: 48229 Fábrica: ACRILEX Unidade: CX/6
F1 F4

UN: R\$ 14,61 AV: R\$ 87,66 15: R\$ 89,49
30: R\$ 91,28 45: R\$ 93,10 60: R\$ 94,96



TINTA A OLEO P/TELA 20ML 320 PRETO 6X1

Código: 48230 Fábrica: ACRILEX Unidade: CX/6
F1 F4

UN: R\$ 14,61 AV: R\$ 87,66 15: R\$ 89,49
30: R\$ 91,28 45: R\$ 93,10 60: R\$ 94,96



TINTA A OLEO P/TELA 20ML 321 VIOLETA 6X1

Código: 48231 Fábrica: ACRILEX Unidade: CX/6
F1 F4

UN: R\$ 14,61 AV: R\$ 87,66 15: R\$ 89,49
30: R\$ 91,28 45: R\$ 93,10 60: R\$ 94,96



TINTA A OLEO P/TELA 20ML 322 VERDE M 6X1

Código: 48232 Fábrica: ACRILEX Unidade: CX/6
F1 F4

UN: R\$ 14,61 AV: R\$ 87,66 15: R\$ 89,49
30: R\$ 91,28 45: R\$ 93,10 60: R\$ 94,96



TINTA A OLEO P/TELA 20ML 323 AMARELO 6X1

Código: 48233 Fábrica: ACRILEX Unidade: CX/6
F1 F4

UN: R\$ 14,61 AV: R\$ 87,66 15: R\$ 89,49
30: R\$ 91,28 45: R\$ 93,10 60: R\$ 94,96



TINTA A OLEO P/TELA 20ML 363 AZUL TU 6X1

Código: 48234 Fábrica: ACRILEX Unidade: CX/6
F1 F4

UN: R\$ 69,88 AV: R\$ 69,88 15: R\$ 71,33
30: R\$ 72,76 45: R\$ 74,22 60: R\$ 75,70



TINTA ACRILICA 250ML BRILHANTE 513 VERDE

Código: 50360 Fábrica: ACRILEX Unidade: UN/1
F1 F4

UN: R\$ 69,88 AV: R\$ 69,88 15: R\$ 71,33
30: R\$ 72,76 45: R\$ 74,22 60: R\$ 75,70



TINTA ACRILICA 250ML BRILHANTE 519 BRANC

Código: 50359 Fábrica: ACRILEX Unidade: UN/1
F1 F4

UN: R\$ 49,91 AV: R\$ 49,91 15: R\$ 50,95
30: R\$ 51,97 45: R\$ 53,01 60: R\$ 54,07



TINTA ACRILICA 250ML FOSCA 501 AZUL TURQU

Código: 50361 Fábrica: ACRILEX Unidade: UN/1
F1 F4

UN: R\$ 49,91 AV: R\$ 49,91 15: R\$ 50,95
30: R\$ 51,97 45: R\$ 53,01 60: R\$ 54,07



TINTA ACRILICA 250ML FOSCA 507 VERMELHO
Código: 50363 Fábrica: ACRILEX Unidade: UN/1
F1 F4

UN: R\$ 49,91 AV: R\$ 49,91 15: R\$ 50,95
30: R\$ 51,97 45: R\$ 53,01 60: R\$ 54,07



TINTA ACRILICA 250ML FOSCA 516 VIOLETA
Código: 50364 Fábrica: ACRILEX Unidade: UN/1
F1 F4

UN: R\$ 49,91 AV: R\$ 49,91 15: R\$ 50,95
30: R\$ 51,97 45: R\$ 53,01 60: R\$ 54,07



TINTA ACRILICA 250ML FOSCA 517 LARANJA
Código: 50366 Fábrica: ACRILEX Unidade: UN/1
F1 F4

UN: R\$ 49,91 AV: R\$ 49,91 15: R\$ 50,95
30: R\$ 51,97 45: R\$ 53,01 60: R\$ 54,07



TINTA ACRILICA 250ML FOSCA 520 PRETO
Código: 50362 Fábrica: ACRILEX Unidade: UN/1
F1 F4

UN: R\$ 49,91 AV: R\$ 49,91 15: R\$ 50,95
30: R\$ 51,97 45: R\$ 53,01 60: R\$ 54,07



TINTA ACRILICA 250ML FOSCA 531 MARROM
Código: 50365 Fábrica: ACRILEX Unidade: UN/1
F1 F4

UN: R\$ 10,97 AV: R\$ 10,97 15: R\$ 11,20
30: R\$ 11,43 45: R\$ 11,65 60: R\$ 11,89



TINTA AQUARELA 12 CORES C/PINCEL
Código: 49273 Fábrica: COLORARE Unidade: UN/1
F1 F4

UN: R\$ 14,55 AV: R\$ 14,55 15: R\$ 14,85
30: R\$ 15,15 45: R\$ 15,45 60: R\$ 15,76



TINTA ARTES 100ML FOSCA 501 AZUL TURQUES
Código: 40926 Fábrica: ACRILEX Unidade: UN/1
F1 F4

UN: R\$ 14,55 AV: R\$ 14,55 15: R\$ 14,85
30: R\$ 15,15 45: R\$ 15,45 60: R\$ 15,76



TINTA ARTES 100ML FOSCA 503 AZUL CELESTE
Código: 48410 Fábrica: ACRILEX Unidade: UN/1
F1 F4

UN: R\$ 14,55 AV: R\$ 14,55 15: R\$ 14,85
30: R\$ 15,15 45: R\$ 15,45 60: R\$ 15,76



TINTA ARTES 100ML FOSCA 505 AMARELO OURO
Código: 48413 Fábrica: ACRILEX Unidade: UN/1
F1 F4

UN: R\$ 14,55 AV: R\$ 14,55 15: R\$ 14,85
30: R\$ 15,15 45: R\$ 15,45 60: R\$ 15,76



TINTA ARTES 100ML FOSCA 507 VERMELHO FOG
Código: 48412 Fábrica: ACRILEX Unidade: UN/1
F1 F4

UN: R\$ 14,55 AV: R\$ 14,55 15: R\$ 14,85
30: R\$ 15,15 45: R\$ 15,45 60: R\$ 15,76



TINTA ARTES 100ML FOSCA 510 VERDE FOLHA
Código: 48414 Fábrica: ACRILEX Unidade: UN/1
F1 F4

UN: R\$ 14,55 AV: R\$ 14,55 15: R\$ 14,85
30: R\$ 15,15 45: R\$ 15,45 60: R\$ 15,76



TINTA ARTES 100ML FOSCA 511 VERDE BANDEI
Código: 48415 Fábrica: ACRILEX Unidade: UN/1
F1 F4

UN: R\$ 14,55 AV: R\$ 14,55 15: R\$ 14,85
30: R\$ 15,15 45: R\$ 15,45 60: R\$ 15,76



TINTA ARTES 100ML FOSCA 516 VIOLETA
Código: 48416 Fábrica: ACRILEX Unidade: UN/1
F1 F4

UN: R\$ 14,55 AV: R\$ 14,55 15: R\$ 14,85
30: R\$ 15,15 45: R\$ 15,45 60: R\$ 15,76



TINTA ARTES 100ML FOSCA 517 LARANJA
Código: 40927 Fábrica: ACRILEX Unidade: UN/1
F1 F4

UN: R\$ 14,55 AV: R\$ 14,55 15: R\$ 14,85
30: R\$ 15,15 45: R\$ 15,45 60: R\$ 15,76



TINTA ARTES 100ML FOSCA 519 BRANCO
Código: 48411 Fábrica: ACRILEX Unidade: UN/1
F1 F4

UN: R\$ 14,55 AV: R\$ 14,55 15: R\$ 14,85
30: R\$ 15,15 45: R\$ 15,45 60: R\$ 15,76



TINTA ARTES 100ML FOSCA 520 PRETO
Código: 48418 Fábrica: ACRILEX Unidade: UN/1
F1 F4

UN: R\$ 14,55 AV: R\$ 14,55 15: R\$ 14,85
30: R\$ 15,15 45: R\$ 15,45 60: R\$ 15,76



TINTA ARTES 100ML FOSCA 531 MARROM
Código: 48417 Fábrica: ACRILEX Unidade: UN/1 F1 F4

UN: R\$ 14,55 AV: R\$ 14,55 15: R\$ 14,85
30: R\$ 15,15 45: R\$ 15,45 60: R\$ 15,76



TINTA ARTES 100ML FOSCA 537 ROSA
Código: 40928 Fábrica: ACRILEX Unidade: UN/1 F1 F4

UN: R\$ 14,55 AV: R\$ 14,55 15: R\$ 14,85
30: R\$ 15,15 45: R\$ 15,45 60: R\$ 15,76



TINTA ARTESANATO 100ML FOSCA
Código: 40930 Fábrica: ACRILEX Unidade: UN/1 F1 F4

UN: R\$ 7,94 AV: R\$ 7,94 15: R\$ 8,10
30: R\$ 8,26 45: R\$ 8,43 60: R\$ 8,60

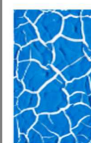

TINTA CRAQUELEX 37ML 501 AZUL TURQUESA
Código: 44832 Fábrica: ACRILEX Unidade: UN/1 F1 F4

UN: R\$ 7,94 AV: R\$ 7,94 15: R\$ 8,10
30: R\$ 8,26 45: R\$ 8,43 60: R\$ 8,60



TINTA CRAQUELEX 37ML 505 AMARELO OURO
Código: 44835 Fábrica: ACRILEX Unidade: UN/1 F1 F4

UN: R\$ 7,94 AV: R\$ 7,94 15: R\$ 8,10
30: R\$ 8,26 45: R\$ 8,43 60: R\$ 8,60



TINTA CRAQUELEX 37ML 507 VERMELHO FOGO
Código: 44834 Fábrica: ACRILEX Unidade: UN/1 F1 F4

UN: R\$ 7,94 AV: R\$ 7,94 15: R\$ 8,10
30: R\$ 8,26 45: R\$ 8,43 60: R\$ 8,60

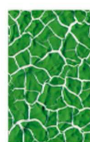

TINTA CRAQUELEX 37ML 513 VERDE MUSGO
Código: 44833 Fábrica: ACRILEX Unidade: UN/1 F1 F4

UN: R\$ 7,94 AV: R\$ 7,94 15: R\$ 8,10
30: R\$ 8,26 45: R\$ 8,43 60: R\$ 8,60



TINTA CRAQUELEX 37ML 519 BRANCO
Código: 44830 Fábrica: ACRILEX Unidade: UN/1 F1 F4

UN: R\$ 7,94 AV: R\$ 7,94 15: R\$ 8,10
30: R\$ 8,26 45: R\$ 8,43 60: R\$ 8,60



TINTA CRAQUELEX 37ML 520 PRETO
Código: 44831 Fábrica: ACRILEX Unidade: UN/1 F1 F4

UN: R\$ 7,94 AV: R\$ 7,94 15: R\$ 8,10
30: R\$ 8,26 45: R\$ 8,43 60: R\$ 8,60



TINTA CRAQUELEX 37ML 531 MARROM
Código: 44836 Fábrica: ACRILEX Unidade: UN/1 F1 F4

UN: R\$ 6,98 AV: R\$ 6,98 15: R\$ 7,12
30: R\$ 7,27 45: R\$ 7,41 60: R\$ 7,56



TINTA DIMENSIONAL 35ML BRILLIAN 501 AZUL
Código: 44825 Fábrica: ACRILEX Unidade: UN/1 F1 F4

UN: R\$ 6,98 AV: R\$ 6,98 15: R\$ 7,12
30: R\$ 7,27 45: R\$ 7,41 60: R\$ 7,56



TINTA DIMENSIONAL 35ML BRILLIAN 505 AMAR
Código: 44828 Fábrica: ACRILEX Unidade: UN/1 F1 F4

UN: R\$ 6,98 AV: R\$ 6,98 15: R\$ 7,12
30: R\$ 7,27 45: R\$ 7,41 60: R\$ 7,56



TINTA DIMENSIONAL 35ML BRILLIAN 507 VERM
Código: 44829 Fábrica: ACRILEX Unidade: UN/1 F1 F4

UN: R\$ 6,98 AV: R\$ 6,98 15: R\$ 7,12
30: R\$ 7,27 45: R\$ 7,41 60: R\$ 7,56



TINTA DIMENSIONAL 35ML BRILLIAN 513 VERD
Código: 44827 Fábrica: ACRILEX Unidade: UN/1 F1 F4

UN: R\$ 6,98 AV: R\$ 6,98 15: R\$ 7,12
30: R\$ 7,27 45: R\$ 7,41 60: R\$ 7,56



TINTA DIMENSIONAL 35ML BRILLIAN 519 BCO
Código: 44823 Fábrica: ACRILEX Unidade: UN/1 F1 F4

UN: R\$ 6,98 AV: R\$ 6,98 15: R\$ 7,12
30: R\$ 7,27 45: R\$ 7,41 60: R\$ 7,56



TINTA DIMENSIONAL 35ML BRILLIAN 520 PTO
Código: 44824 Fábrica: ACRILEX Unidade: UN/1 F1 F4

UN: R\$ 6,98 AV: R\$ 6,98 15: R\$ 7,12
30: R\$ 7,27 45: R\$ 7,41 60: R\$ 7,56



TINTA DIMENSIONAL 35ML BRILLIAN 531 MARR
Código: 44826 Fábrica: ACRILEX Unidade: UN/1 F1 F4

UN: R\$ 5,58 AV: R\$ 5,58 15: R\$ 5,70
30: R\$ 5,81 45: R\$ 5,93 60: R\$ 6,05



TINTA FACIAL 15 ML AMARELO 1002
Código: 46557 Fábrica: COR&ARTE Unidade: UN/1 F1 F4

UN: R\$ 5,58 AV: R\$ 5,58 15: R\$ 5,70
30: R\$ 5,81 45: R\$ 5,93 60: R\$ 6,05



TINTA FACIAL 15 ML AZUL CLARO 1007
Código: 46558 Fábrica: COR&ARTE Unidade: UN/1 F1 F4

UN: R\$ 5,58 AV: R\$ 5,58 15: R\$ 5,70
30: R\$ 5,81 45: R\$ 5,93 60: R\$ 6,05



TINTA FACIAL 15 ML AZUL 1004
Código: 46550 Fábrica: COR&ARTE Unidade: UN/1 F1 F4

UN: R\$ 5,58 AV: R\$ 5,58 15: R\$ 5,70
30: R\$ 5,81 45: R\$ 5,93 60: R\$ 6,05



TINTA FACIAL 15 ML BRANCA 1001
Código: 46549 Fábrica: COR&ARTE Unidade: UN/1 F1 F4

UN: R\$ 5,58 AV: R\$ 5,58 15: R\$ 5,70
30: R\$ 5,81 45: R\$ 5,93 60: R\$ 6,05



TINTA FACIAL 15 ML LARANJA 1009
Código: 46551 Fábrica: COR&ARTE Unidade: UN/1 F1 F4

UN: R\$ 7,27 AV: R\$ 7,27 15: R\$ 7,42
30: R\$ 7,57 45: R\$ 7,72 60: R\$ 7,87



TINTA FACIAL 15 ML LILAS LAVANDA 1022
Código: 46559 Fábrica: COR&ARTE Unidade: UN/1 F1 F4

UN: R\$ 5,58 AV: R\$ 5,58 15: R\$ 5,70
30: R\$ 5,81 45: R\$ 5,93 60: R\$ 6,05



TINTA FACIAL 15 ML MARRRON 1008
Código: 46552 Fábrica: COR&ARTE Unidade: UN/1 F1 F4

UN: R\$ 7,27 AV: R\$ 7,27 15: R\$ 7,42
30: R\$ 7,57 45: R\$ 7,72 60: R\$ 7,87



TINTA FACIAL 15 ML PINK FLUOR 1016
Código: 46553 Fábrica: COR&ARTE Unidade: UN/1 F1 F4

UN: R\$ 5,58 AV: R\$ 5,58 15: R\$ 5,70
30: R\$ 5,81 45: R\$ 5,93 60: R\$ 6,05



TINTA FACIAL 15 ML PRETO 1005
Código: 46554 Fábrica: COR&ARTE Unidade: UN/1 F1 F4

UN: R\$ 5,58 AV: R\$ 5,58 15: R\$ 5,70
30: R\$ 5,81 45: R\$ 5,93 60: R\$ 6,05



TINTA FACIAL 15 ML VERDE 1006
Código: 46555 Fábrica: COR&ARTE Unidade: UN/1 F1 F4

UN: R\$ 5,58 AV: R\$ 5,58 15: R\$ 5,70
30: R\$ 5,81 45: R\$ 5,93 60: R\$ 6,05



TINTA FACIAL 15 ML VERMELHO 1003
Código: 46556 Fábrica: COR&ARTE Unidade: UN/1 F1 F4

UN: R\$ 49,91 AV: R\$ 49,91 15: R\$ 50,95
30: R\$ 51,97 45: R\$ 53,01 60: R\$ 54,07



TINTA FACIAL 15 ML 6 CORES+PINCEL+GLITER
Código: 46546 Fábrica: COR&ARTE Unidade: CJ/1 F1 F4

UN: R\$ 36,62 AV: R\$ 36,62 15: R\$ 37,38
30: R\$ 38,13 45: R\$ 38,89 60: R\$ 39,67



TINTA FACIAL 15 ML 6 CORES+PINCEL+GLITER
Código: 44637 Fábrica: COR&ARTE Unidade: CJ/1 F1 F4

UN: R\$ 3,95 AV: R\$ 19,77 15: R\$ 20,18
30: R\$ 20,58 45: R\$ 21,00 60: R\$ 21,42



TINTA FACIAL 4 GR GLITER CREMOS 4011 5X1
Código: 46548 Fábrica: COR&ARTE Unidade: CJ/5 F1 F4

UN: R\$ 1,16 AV: R\$ 6,98 15: R\$ 7,12
30: R\$ 7,27 45: R\$ 7,41 60: R\$ 7,56



TINTA GUACHE 15ML 6 CORES SORT 6X1
Código: 19150 Fábrica: MAXCRIL Unidade: CX/6 F1 F4

UN: R\$ 1,02 AV: R\$ 12,23 15: R\$ 12,49
30: R\$ 12,73 45: R\$ 12,99 60: R\$ 13,25



TINTA GUACHE 15ML AMARELO 12X1
Código: **5929** Fábrica: MARIPEL Unidade: DZ/12 F1 F4

UN: R\$ 1,02 AV: R\$ 12,23 15: R\$ 12,49
30: R\$ 12,73 45: R\$ 12,99 60: R\$ 13,25



TINTA GUACHE 15ML AZUL CLARO 12X1
Código: **5816** Fábrica: MARIPEL Unidade: DZ/12 F1 F4

UN: R\$ 1,02 AV: R\$ 12,23 15: R\$ 12,49
30: R\$ 12,73 45: R\$ 12,99 60: R\$ 13,25



TINTA GUACHE 15ML AZUL ESCURO 12X1
Código: **19035** Fábrica: MARIPEL Unidade: DZ/12 F1 F4

UN: R\$ 1,02 AV: R\$ 12,23 15: R\$ 12,49
30: R\$ 12,73 45: R\$ 12,99 60: R\$ 13,25



TINTA GUACHE 15ML BRANCO 12X1
Código: **5818** Fábrica: MARIPEL Unidade: DZ/12 F1 F4

UN: R\$ 1,02 AV: R\$ 12,23 15: R\$ 12,49
30: R\$ 12,73 45: R\$ 12,99 60: R\$ 13,25



TINTA GUACHE 15ML LARANJA 12X1
Código: **15283** Fábrica: MARIPEL Unidade: DZ/12 F1 F4

UN: R\$ 1,02 AV: R\$ 12,23 15: R\$ 12,49
30: R\$ 12,73 45: R\$ 12,99 60: R\$ 13,25



TINTA GUACHE 15ML MARROM 12X1
Código: **10033** Fábrica: MARIPEL Unidade: DZ/12 F1 F4

UN: R\$ 1,02 AV: R\$ 12,23 15: R\$ 12,49
30: R\$ 12,73 45: R\$ 12,99 60: R\$ 13,25



TINTA GUACHE 15ML PESSEGO 12X1
Código: **5820** Fábrica: MARIPEL Unidade: DZ/12 F1 F4

UN: R\$ 1,02 AV: R\$ 12,23 15: R\$ 12,49
30: R\$ 12,73 45: R\$ 12,99 60: R\$ 13,25



TINTA GUACHE 15ML PRETO 12X1
Código: **19199** Fábrica: MARIPEL Unidade: DZ/12 F1 F4

UN: R\$ 1,02 AV: R\$ 12,23 15: R\$ 12,49
30: R\$ 12,73 45: R\$ 12,99 60: R\$ 13,25



TINTA GUACHE 15ML ROSA 12X1
Código: **21879** Fábrica: MARIPEL Unidade: DZ/12 F1 F4

UN: R\$ 1,02 AV: R\$ 12,23 15: R\$ 12,49
30: R\$ 12,73 45: R\$ 12,99 60: R\$ 13,25



TINTA GUACHE 15ML VERDE BAND 12X1
Código: **5823** Fábrica: MARIPEL Unidade: DZ/12 F1 F4

UN: R\$ 1,02 AV: R\$ 12,23 15: R\$ 12,49
30: R\$ 12,73 45: R\$ 12,99 60: R\$ 13,25



TINTA GUACHE 15ML VERDE CLARO 12X1
Código: **5824** Fábrica: MARIPEL Unidade: DZ/12 F1 F4

UN: R\$ 1,02 AV: R\$ 12,23 15: R\$ 12,49
30: R\$ 12,73 45: R\$ 12,99 60: R\$ 13,25



TINTA GUACHE 15ML VERMELHO 12X1
Código: **7429** Fábrica: MARIPEL Unidade: DZ/12 F1 F4

UN: R\$ 1,02 AV: R\$ 12,23 15: R\$ 12,49
30: R\$ 12,73 45: R\$ 12,99 60: R\$ 13,25



TINTA GUACHE 15ML 12 CORES SORT 12X1
Código: **50519** Fábrica: MARIPEL Unidade: DZ/12 F1 F4

UN: R\$ 1,08 AV: R\$ 6,48 15: R\$ 6,61
30: R\$ 6,75 45: R\$ 6,88 60: R\$ 7,02



TINTA GUACHE 15ML 6 CORES SORT 6X1 K04
Código: **45145** Fábrica: COLA MAIS Unidade: CX/6 F1 F4

UN: R\$ 1,16 AV: R\$ 6,98 15: R\$ 7,12
30: R\$ 7,27 45: R\$ 7,41 60: R\$ 7,56



TINTA GUACHE 30ML 6 CORES SORT 6X1
Código: **14667** Fábrica: MARIPEL Unidade: CX/6 F1 F4

UN: R\$ 1,16 AV: R\$ 6,98 15: R\$ 7,12
30: R\$ 7,27 45: R\$ 7,41 60: R\$ 7,56



TINTA GUACHE PINTURA DEDO 6 CORES SORT
Código: **14673** Fábrica: MARIPEL Unidade: CX/6 F1 F4

UN: R\$ 5,99 AV: R\$ 5,99 15: R\$ 5,99
30: R\$ 5,99 45: R\$ 5,99 60: R\$ 5,99



TINTA GUACHE 250ML AMARELO
Código: **45149** Fábrica: COLA MAIS Unidade: UN/1
F1 F4

UN: R\$ 5,99 AV: R\$ 5,99 15: R\$ 5,99
30: R\$ 5,99 45: R\$ 5,99 60: R\$ 5,99



TINTA GUACHE 250ML AZUL
Código: **45147** Fábrica: COLA MAIS Unidade: UN/1
F1 F4

UN: R\$ 9,47 AV: R\$ 9,47 15: R\$ 9,67
30: R\$ 9,87 45: R\$ 10,06 60: R\$ 10,26



TINTA GUACHE 250ML AZUL CELESTE
Código: **33046** Fábrica: EVIDENT Unidade: UN/1
F1 F4

UN: R\$ 5,99 AV: R\$ 5,99 15: R\$ 5,99
30: R\$ 5,99 45: R\$ 5,99 60: R\$ 5,99



TINTA GUACHE 250ML AZUL CELESTE
Código: **39914** Fábrica: VMP Unidade: UN/1
F1 F4

UN: R\$ 5,99 AV: R\$ 5,99 15: R\$ 5,99
30: R\$ 5,99 45: R\$ 5,99 60: R\$ 5,99



TINTA GUACHE 250ML AZUL ESCURO
Código: **50842** Fábrica: MARIPEL Unidade: UN/1
F1 F4

UN: R\$ 5,99 AV: R\$ 5,99 15: R\$ 5,99
30: R\$ 5,99 45: R\$ 5,99 60: R\$ 5,99



TINTA GUACHE 250ML AZUL TURQUEZA
Código: **39915** Fábrica: VMP Unidade: UN/1
F1 F4

UN: R\$ 5,99 AV: R\$ 5,99 15: R\$ 5,99
30: R\$ 5,99 45: R\$ 5,99 60: R\$ 5,99



TINTA GUACHE 250ML BRANCO
Código: **45146** Fábrica: COLA MAIS Unidade: UN/1
F1 F4

UN: R\$ 5,99 AV: R\$ 5,99 15: R\$ 5,99
30: R\$ 5,99 45: R\$ 5,99 60: R\$ 5,99



TINTA GUACHE 250ML LARANJA
Código: **39917** Fábrica: VMP Unidade: UN/1
F1 F4

UN: R\$ 5,99 AV: R\$ 5,99 15: R\$ 5,99
30: R\$ 5,99 45: R\$ 5,99 60: R\$ 5,99



TINTA GUACHE 250ML MARRON
Código: **39922** Fábrica: COLA MAIS Unidade: UN/1
F1 F4

UN: R\$ 9,47 AV: R\$ 9,47 15: R\$ 9,67
30: R\$ 9,87 45: R\$ 10,06 60: R\$ 10,26



TINTA GUACHE 250ML PRETO
Código: **39921** Fábrica: EVIDENT Unidade: UN/1
F1 F4

UN: R\$ 5,99 AV: R\$ 5,99 15: R\$ 5,99
30: R\$ 5,99 45: R\$ 5,99 60: R\$ 5,99



TINTA GUACHE 250ML ROSA
Código: **39918** Fábrica: VMP Unidade: UN/1
F1 F4

UN: R\$ 5,99 AV: R\$ 5,99 15: R\$ 5,99
30: R\$ 5,99 45: R\$ 5,99 60: R\$ 5,99



TINTA GUACHE 250ML ROSA
Código: **49176** Fábrica: COLA MAIS Unidade: UN/1
F1 F4

UN: R\$ 5,99 AV: R\$ 5,99 15: R\$ 5,99
30: R\$ 5,99 45: R\$ 5,99 60: R\$ 5,99



TINTA GUACHE 250ML VERDE BANDEIRA
Código: **39919** Fábrica: VMP Unidade: UN/1
F1 F4

UN: R\$ 9,48 AV: R\$ 9,48 15: R\$ 9,68
30: R\$ 9,88 45: R\$ 10,07 60: R\$ 10,27



TINTA GUACHE 250ML VERDE BANDEIRA
Código: **33313** Fábrica: EVIDENT Unidade: UN/1
F1 F4

UN: R\$ 5,99 AV: R\$ 5,99 15: R\$ 5,99
30: R\$ 5,99 45: R\$ 5,99 60: R\$ 5,99



TINTA GUACHE 250ML VERDE ESCURO
Código: **45150** Fábrica: MARIPEL/COLA Unidade: UN/1
F1 F4

UN: R\$ 5,99 AV: R\$ 5,99 15: R\$ 5,99
30: R\$ 5,99 45: R\$ 5,99 60: R\$ 5,99



TINTA GUACHE 250ML VERMELHO
Código: **45151** Fábrica: COLA MAIS Unidade: UN/1
F1 F4

UN: R\$ 5,99 AV: R\$ 5,99 15: R\$ 5,99
30: R\$ 5,99 45: R\$ 5,99 60: R\$ 5,99



TINTA GUACHE 250ML VERMELHO ESC
Código: 49175 Fábrica: COLA MAIS Unidade: UN/1 F1 F4

UN: R\$ 9,97 AV: R\$ 9,97 15: R\$ 10,18
30: R\$ 10,39 45: R\$ 10,59 60: R\$ 10,81



TINTA GUACHE 250ML 501 AZUL TURQUESA
Código: 45038 Fábrica: ACRILEX Unidade: UN/1 F1 F4

UN: R\$ 9,97 AV: R\$ 9,97 15: R\$ 10,18
30: R\$ 10,39 45: R\$ 10,59 60: R\$ 10,81



TINTA GUACHE 250ML 503 AZUL CELESTE
Código: 45040 Fábrica: ACRILEX Unidade: UN/1 F1 F4

UN: R\$ 9,97 AV: R\$ 9,97 15: R\$ 10,18
30: R\$ 10,39 45: R\$ 10,59 60: R\$ 10,81



TINTA GUACHE 250ML 504 AMARELO LIMAO
Código: 45044 Fábrica: ACRILEX Unidade: UN/1 F1 F4

UN: R\$ 9,97 AV: R\$ 9,97 15: R\$ 10,18
30: R\$ 10,39 45: R\$ 10,59 60: R\$ 10,81



TINTA GUACHE 250ML 505 AMARELO OURO
Código: 45045 Fábrica: ACRILEX Unidade: UN/1 F1 F4

UN: R\$ 9,97 AV: R\$ 9,97 15: R\$ 10,18
30: R\$ 10,39 45: R\$ 10,59 60: R\$ 10,81



TINTA GUACHE 250ML 507 VERMELHO FOGO
Código: 45042 Fábrica: ACRILEX Unidade: UN/1 F1 F4

UN: R\$ 9,97 AV: R\$ 9,97 15: R\$ 10,18
30: R\$ 10,39 45: R\$ 10,59 60: R\$ 10,81



TINTA GUACHE 250ML 510 VERDE FOLHA
Código: 45051 Fábrica: ACRILEX Unidade: UN/1 F1 F4

UN: R\$ 9,97 AV: R\$ 9,97 15: R\$ 10,18
30: R\$ 10,39 45: R\$ 10,59 60: R\$ 10,81



TINTA GUACHE 250ML 511 VERDE BANDEIRA
Código: 45043 Fábrica: ACRILEX Unidade: UN/1 F1 F4

UN: R\$ 9,97 AV: R\$ 9,97 15: R\$ 10,18
30: R\$ 10,39 45: R\$ 10,59 60: R\$ 10,81



TINTA GUACHE 250ML 516 VIOLETA
Código: 45052 Fábrica: ACRILEX Unidade: UN/1 F1 F4

UN: R\$ 9,97 AV: R\$ 9,97 15: R\$ 10,18
30: R\$ 10,39 45: R\$ 10,59 60: R\$ 10,81



TINTA GUACHE 250ML 517 LARANJA
Código: 45053 Fábrica: ACRILEX Unidade: UN/1 F1 F4

UN: R\$ 9,97 AV: R\$ 9,97 15: R\$ 10,18
30: R\$ 10,39 45: R\$ 10,59 60: R\$ 10,81



TINTA GUACHE 250ML 519 BRANCO
Código: 45037 Fábrica: ACRILEX Unidade: UN/1 F1 F4

UN: R\$ 9,97 AV: R\$ 9,97 15: R\$ 10,18
30: R\$ 10,39 45: R\$ 10,59 60: R\$ 10,81



TINTA GUACHE 250ML 520 PRETO
Código: 45039 Fábrica: ACRILEX Unidade: UN/1 F1 F4

UN: R\$ 9,97 AV: R\$ 9,97 15: R\$ 10,18
30: R\$ 10,39 45: R\$ 10,59 60: R\$ 10,81



TINTA GUACHE 250ML 528 LILAS
Código: 45049 Fábrica: ACRILEX Unidade: UN/1 F1 F4

UN: R\$ 9,97 AV: R\$ 9,97 15: R\$ 10,18
30: R\$ 10,39 45: R\$ 10,59 60: R\$ 10,81



TINTA GUACHE 250ML 531 MARROM
Código: 45047 Fábrica: ACRILEX Unidade: UN/1 F1 F4

UN: R\$ 9,97 AV: R\$ 9,97 15: R\$ 10,18
30: R\$ 10,39 45: R\$ 10,59 60: R\$ 10,81



TINTA GUACHE 250ML 537 ROSA
Código: 45054 Fábrica: ACRILEX Unidade: UN/1 F1 F4

UN: R\$ 9,97 AV: R\$ 9,97 15: R\$ 10,18
30: R\$ 10,39 45: R\$ 10,59 60: R\$ 10,81



TINTA GUACHE 250ML 538 AMARELO PESSEGO
Código: 45046 Fábrica: ACRILEX Unidade: UN/1 F1 F4

UN: R\$ 9,97 AV: R\$ 9,97 15: R\$ 10,18
30: R\$ 10,39 45: R\$ 10,59 60: R\$ 10,81



TINTA GUACHE 250ML 549 MAGENTA
Código: Fábrika: Unidade:
45050 ACRILEX UN/1
F1 F4

UN: R\$ 9,97 AV: R\$ 9,97 15: R\$ 10,18
30: R\$ 10,39 45: R\$ 10,59 60: R\$ 10,81



TINTA GUACHE 250ML 559 AZUL
Código: Fábrika: Unidade:
45041 ACRILEX UN/1
F1 F4

UN: R\$ 9,97 AV: R\$ 9,97 15: R\$ 10,18
30: R\$ 10,39 45: R\$ 10,59 60: R\$ 10,81



TINTA GUACHE 250ML 565 VINHO
Código: Fábrika: Unidade:
45048 ACRILEX UN/1
F1 F4

UN: R\$ 9,97 AV: R\$ 9,97 15: R\$ 10,18
30: R\$ 10,39 45: R\$ 10,59 60: R\$ 10,81



TINTA GUACHE 250ML 933 CINZA
Código: Fábrika: Unidade:
45055 ACRILEX UN/1
F1 F4

UN: R\$ 8,28 AV: R\$ 8,28 15: R\$ 8,45
30: R\$ 8,62 45: R\$ 8,79 60: R\$ 8,97



TINTA IMP CANON REFIL 100ML BK
Código: Fábrika: Unidade:
42236 MASTERPRINT UN/1
F1 F4

UN: R\$ 22,21 AV: R\$ 22,21 15: R\$ 22,68
30: R\$ 23,13 45: R\$ 23,59 60: R\$ 24,07



TINTA IMP EPSON REFIL 70ML BK 544120
Código: Fábrika: Unidade:
44196 MAXPRINT UN/1
F1 F4

UN: R\$ 22,21 AV: R\$ 22,21 15: R\$ 22,68
30: R\$ 23,13 45: R\$ 23,59 60: R\$ 24,07



TINTA IMP EPSON REFIL 70ML CIANO 544220
Código: Fábrika: Unidade:
44197 MAXPRINT UN/1
F1 F4

UN: R\$ 22,21 AV: R\$ 22,21 15: R\$ 22,68
30: R\$ 23,13 45: R\$ 23,59 60: R\$ 24,07



TINTA IMP EPSON REFIL 70ML MAGEN 544320
Código: Fábrika: Unidade:
44198 MAXPRINT UN/1
F1 F4

UN: R\$ 8,49 AV: R\$ 8,49 15: R\$ 8,66
30: R\$ 8,84 45: R\$ 9,01 60: R\$ 9,19



TINTA IMP EPSON REFIL 70ML 504/544 CYAN
Código: Fábrika: Unidade:
45116 MASTERPRINT UN/1
F1 F4

UN: R\$ 8,49 AV: R\$ 8,49 15: R\$ 8,66
30: R\$ 8,84 45: R\$ 9,01 60: R\$ 9,19



TINTA IMP EPSON REFIL 70ML 504/544 MAG
Código: Fábrika: Unidade:
45118 MASTERPRINT UN/1
F1 F4

UN: R\$ 8,49 AV: R\$ 8,49 15: R\$ 8,66
30: R\$ 8,84 45: R\$ 9,01 60: R\$ 9,19



TINTA IMP EPSON REFIL 70ML 504/544 YELL
Código: Fábrika: Unidade:
45117 MASTERPRINT UN/1
F1 F4

UN: R\$ 6,98 AV: R\$ 6,98 15: R\$ 7,12
30: R\$ 7,27 45: R\$ 7,41 60: R\$ 7,56



TINTA IMP EPSON REFIL 100ML BK 664/672/6
Código: Fábrika: Unidade:
38242 MASTERPRINT UN/1
F1 F4

UN: R\$ 8,98 AV: R\$ 8,98 15: R\$ 9,16
30: R\$ 9,35 45: R\$ 9,53 60: R\$ 9,72



TINTA IMP EPSON REFIL 100ML CYA
Código: Fábrika: Unidade:
41737 MASTERPRINT UN/1
F1 F4

UN: R\$ 6,98 AV: R\$ 6,98 15: R\$ 7,12
30: R\$ 7,27 45: R\$ 7,41 60: R\$ 7,56



TINTA IMP EPSON REFIL 100ML CYA 664/673
Código: Fábrika: Unidade:
38241 MASTERPRINT UN/1
F1 F4

UN: R\$ 6,98 AV: R\$ 6,98 15: R\$ 7,12
30: R\$ 7,27 45: R\$ 7,41 60: R\$ 7,56



TINTA IMP EPSON REFIL 100ML MAG 664/673
Código: Fábrika: Unidade:
38240 MASTERPRINT UN/1
F1 F4

UN: R\$ 8,24 AV: R\$ 8,24 15: R\$ 8,41
30: R\$ 8,58 45: R\$ 8,75 60: R\$ 8,92



TINTA IMP EPSON REFIL 100ML MAG 673
Código: Fábrika: Unidade:
45119 MASTERPRINT UN/1
F1 F4

UN: R\$ 6,98 AV: R\$ 6,98 15: R\$ 7,12
30: R\$ 7,27 45: R\$ 7,41 60: R\$ 7,56



TINTA IMP EPSON REFIL 100ML YEL 664/673

Código: 38239 Fábrica: MASTERPRINT Unidade: UN/1 F1 F4

UN: R\$ 10,85 AV: R\$ 10,85 15: R\$ 11,08
30: R\$ 11,30 45: R\$ 11,53 60: R\$ 11,76



TINTA IMP EPSON REFIL 127ML 504/544 BK

Código: 45120 Fábrica: MASTERPRINT Unidade: UN/1 F1 F4

UN: R\$ 35,93 AV: R\$ 35,93 15: R\$ 36,68
30: R\$ 37,41 45: R\$ 38,16 60: R\$ 38,93



TINTA IMP EPSON 1 LT UNIVER BK

Código: 38246 Fábrica: MASTERPRINT Unidade: UN/1 F1 F4

UN: R\$ 37,62 AV: R\$ 37,62 15: R\$ 38,40
30: R\$ 39,17 45: R\$ 39,96 60: R\$ 40,75



TINTA IMP EPSON 1 LT UNIVER CYAN

Código: 38245 Fábrica: MASTERPRINT Unidade: UN/1 F1 F4

UN: R\$ 37,62 AV: R\$ 37,62 15: R\$ 38,40
30: R\$ 39,17 45: R\$ 39,96 60: R\$ 40,75



TINTA IMP EPSON 1 LT UNIVER MAGENTA

Código: 38243 Fábrica: MASTERPRINT Unidade: UN/1 F1 F4

UN: R\$ 37,62 AV: R\$ 37,62 15: R\$ 38,40
30: R\$ 39,17 45: R\$ 39,96 60: R\$ 40,75



TINTA IMP EPSON 1 LT UNIVER YELLOW

Código: 38244 Fábrica: MASTERPRINT Unidade: UN/1 F1 F4

UN: R\$ 7,98 AV: R\$ 7,98 15: R\$ 8,14
30: R\$ 8,31 45: R\$ 8,47 60: R\$ 8,64



TINTA IMP HP REFIL 100ML UNIVER BK

Código: 46177 Fábrica: MASTERPRINT Unidade: UN/1 F1 F4

UN: R\$ 7,98 AV: R\$ 7,98 15: R\$ 8,14
30: R\$ 8,31 45: R\$ 8,47 60: R\$ 8,64



TINTA IMP HP REFIL 100ML UNIVER CYAN

Código: 46178 Fábrica: MASTERPRINT Unidade: UN/1 F1 F4

UN: R\$ 7,98 AV: R\$ 7,98 15: R\$ 8,14
30: R\$ 8,31 45: R\$ 8,47 60: R\$ 8,64



TINTA IMP HP REFIL 100ML UNIVER MAGENTA

Código: 46179 Fábrica: MASTERPRINT Unidade: UN/1 F1 F4

UN: R\$ 7,98 AV: R\$ 7,98 15: R\$ 8,14
30: R\$ 8,31 45: R\$ 8,47 60: R\$ 8,64



TINTA IMP HP REFIL 100ML UNIVER YELLOW

Código: 46180 Fábrica: MASTERPRINT Unidade: UN/1 F1 F4

UN: R\$ 61,90 AV: R\$ 61,90 15: R\$ 63,19
30: R\$ 64,45 45: R\$ 65,74 60: R\$ 67,06



TINTA IMP HP 1 LT UNIVERSAL BK

Código: 40889 Fábrica: MASTERPRINT Unidade: UN/1 F1 F4

UN: R\$ 6,28 AV: R\$ 6,28 15: R\$ 6,41
30: R\$ 6,54 45: R\$ 6,67 60: R\$ 6,80



TINTA P/CARIMBO 40 ML AZUL 132 UN

Código: 41959 Fábrica: CARBRINK Unidade: UN/1 F1 F4

UN: R\$ 6,28 AV: R\$ 6,28 15: R\$ 6,41
30: R\$ 6,54 45: R\$ 6,67 60: R\$ 6,80



TINTA P/CARIMBO 40 ML PRETO 133 UN

Código: 41958 Fábrica: CARBRINK Unidade: UN/1 F1 F4

UN: R\$ 6,24 AV: R\$ 74,88 15: R\$ 76,44
30: R\$ 77,97 45: R\$ 79,53 60: R\$ 81,12



TINTA P/CARIMBO 40 ML PRETO 133 12X1

Código: 12583 Fábrica: CARBRINK Unidade: DZ/12 F1 F4

UN: R\$ 6,28 AV: R\$ 6,28 15: R\$ 6,41
30: R\$ 6,54 45: R\$ 6,67 60: R\$ 6,80



TINTA P/CARIMBO 40 ML VERMELHO 134 UN

Código: 41960 Fábrica: CARBRI/RADEX Unidade: UN/1 F1 F4

UN: R\$ 4,58 AV: R\$ 4,58 15: R\$ 4,68
30: R\$ 4,77 45: R\$ 4,87 60: R\$ 4,96



TINTA PINCEL MARC PERM 20ML AZUL UN

Código: 47139 Fábrica: BRW Unidade: UN/1 F1 F4

UN: R\$ 4,16 AV: R\$ 49,91 15: R\$ 50,95
30: R\$ 51,97 45: R\$ 53,01 60: R\$ 54,07



TINTA PINCEL MARC PERM 20ML AZUL 12X1
Código: Fábrika: Unidade:
23188 BRW DZ/12
F1 F4

UN: R\$ 4,58 AV: R\$ 4,58 15: R\$ 4,68
30: R\$ 4,77 45: R\$ 4,87 60: R\$ 4,96



TINTA PINCEL MARC PERM 20ML PRETO UN
Código: Fábrika: Unidade:
47172 BRW UN/1
F1 F4

UN: R\$ 4,16 AV: R\$ 49,91 15: R\$ 50,95
30: R\$ 51,97 45: R\$ 53,01 60: R\$ 54,07



TINTA PINCEL MARC PERM 20ML PRETO 12X1
Código: Fábrika: Unidade:
12584 BRW DZ/12
F1 F4

UN: R\$ 4,16 AV: R\$ 49,91 15: R\$ 50,95
30: R\$ 51,97 45: R\$ 53,01 60: R\$ 54,07



TINTA PINCEL MARC PERM 20ML VERDE 12X1
Código: Fábrika: Unidade:
44997 BRW DZ/12
F1 F4

UN: R\$ 4,16 AV: R\$ 49,91 15: R\$ 50,95
30: R\$ 51,97 45: R\$ 53,01 60: R\$ 54,07



TINTA PINCEL MARC PERM 20ML VERMEL 12X1
Código: Fábrika: Unidade:
19881 BRW DZ/12
F1 F4

UN: R\$ 4,58 AV: R\$ 4,58 15: R\$ 4,68
30: R\$ 4,77 45: R\$ 4,87 60: R\$ 4,96



TINTA PINCEL MARC PERM 20ML VERMELHO UN
Código: Fábrika: Unidade:
47140 BRW UN/1
F1 F4

UN: R\$ 8,43 AV: R\$ 8,43 15: R\$ 8,60
30: R\$ 8,77 45: R\$ 8,95 60: R\$ 9,13



TINTA PINCEL MARC PERM 40ML AZUL UN
Código: Fábrika: Unidade:
45141 CARBRINK UN/1
F1 F4

UN: R\$ 5,74 AV: R\$ 68,84 15: R\$ 70,27
30: R\$ 71,68 45: R\$ 73,11 60: R\$ 74,58



TINTA PINCEL MARC QDO BCO 20ML AZU 12X1
Código: Fábrika: Unidade:
33683 BRW DZ/12
F1 F4

UN: R\$ 5,74 AV: R\$ 68,84 15: R\$ 70,27
30: R\$ 71,68 45: R\$ 73,11 60: R\$ 74,58



TINTA PINCEL MARC QDO BCO 20ML PTO 12X1
Código: Fábrika: Unidade:
33682 BRW DZ/12
F1 F4

UN: R\$ 5,74 AV: R\$ 68,84 15: R\$ 70,27
30: R\$ 71,68 45: R\$ 73,11 60: R\$ 74,58



TINTA PINCEL MARC QDO BCO 20ML VD 12X1
Código: Fábrika: Unidade:
44998 BRW DZ/12
F1 F4

UN: R\$ 5,74 AV: R\$ 68,84 15: R\$ 70,27
30: R\$ 71,68 45: R\$ 73,11 60: R\$ 74,58



TINTA PINCEL MARC QDO BCO 20ML VM 12X1
Código: Fábrika: Unidade:
38015 BRW DZ/12
F1 F4

UN: R\$ 82,19 AV: R\$ 82,19 15: R\$ 83,90
30: R\$ 85,58 45: R\$ 87,29 60: R\$ 89,04



TINTA PINCEL MARC QDO BCO 500ML AZUL UN
Código: Fábrika: Unidade:
44157 BRW UN/1
F1 F4

UN: R\$ 82,19 AV: R\$ 82,19 15: R\$ 83,90
30: R\$ 85,58 45: R\$ 87,29 60: R\$ 89,04



TINTA PINCEL MARC QDO BCO 500ML PRETO UN
Código: Fábrika: Unidade:
44158 BRW UN/1
F1 F4

UN: R\$ 82,19 AV: R\$ 82,19 15: R\$ 83,90
30: R\$ 85,58 45: R\$ 87,29 60: R\$ 89,04



TINTA PINCEL MARC QDO BCO 500ML VERM UN
Código: Fábrika: Unidade:
44159 BRW UN/1
F1 F4

UN: R\$ 3,64 AV: R\$ 43,74 15: R\$ 44,65
30: R\$ 45,54 45: R\$ 46,46 60: R\$ 47,38



TINTA PINCEL MARC QDO BCO 5,5ML AZU 12X1
Código: Fábrika: Unidade:
47479 BRW CX/12
F1 F4

UN: R\$ 3,64 AV: R\$ 43,74 15: R\$ 44,65
30: R\$ 45,54 45: R\$ 46,46 60: R\$ 47,38



TINTA PINCEL MARC QDO BCO 5,5ML PTO 12X1
Código: Fábrika: Unidade:
47785 BRW CX/12
F1 F4

UN: R\$ 3,64 AV: R\$ 43,74 15: R\$ 44,65
30: R\$ 45,54 45: R\$ 46,46 60: R\$ 47,38



TINTA PINCEL MARC QDO BCO 5,5ML VM 12X1
Código: Fábrika: Unidade:
47506 BRW CX/12
F1 F4

UN: R\$ 1,30 AV: R\$ 7,78 15: R\$ 7,94
30: R\$ 8,10 45: R\$ 8,26 60: R\$ 8,43



TINTA PINTURA DEPO 15ML 6 CORES SORT
Código: Fábrika: Unidade:
45498 ACRILEX CX/6
F1 F4

UN: R\$ 4,07 AV: R\$ 24,40 15: R\$ 24,91
30: R\$ 25,41 45: R\$ 25,92 60: R\$ 26,43



TINTA PINTURA FACIAL 4GR COR CREMOSA 6X1
Código: Fábrika: Unidade:
50761 MARIPEL CR/6
F1 F4

UN: R\$ 5,98 AV: R\$ 5,98 15: R\$ 6,11
30: R\$ 6,23 45: R\$ 6,35 60: R\$ 6,48



TINTA PVA 37ML FOSCA 501 AZUL TURQUESA
Código: Fábrika: Unidade:
48237 ACRILEX UN/1
F1 F4

UN: R\$ 5,98 AV: R\$ 5,98 15: R\$ 6,11
30: R\$ 6,23 45: R\$ 6,35 60: R\$ 6,48



TINTA PVA 37ML FOSCA 503 AZUL CELESTE
Código: Fábrika: Unidade:
48238 ACRILEX UN/1
F1 F4

UN: R\$ 5,98 AV: R\$ 5,98 15: R\$ 6,11
30: R\$ 6,23 45: R\$ 6,35 60: R\$ 6,48



TINTA PVA 37ML FOSCA 504 AMARELO LIMAO
Código: Fábrika: Unidade:
48239 ACRILEX UN/1
F1 F4

UN: R\$ 5,98 AV: R\$ 5,98 15: R\$ 6,11
30: R\$ 6,23 45: R\$ 6,35 60: R\$ 6,48



TINTA PVA 37ML FOSCA 505 AMARELO OURO
Código: Fábrika: Unidade:
48240 ACRILEX UN/1
F1 F4

UN: R\$ 5,98 AV: R\$ 5,98 15: R\$ 6,11
30: R\$ 6,23 45: R\$ 6,35 60: R\$ 6,48



TINTA PVA 37ML FOSCA 507 VERMELHO FOGO
Código: Fábrika: Unidade:
48241 ACRILEX UN/1
F1 F4

UN: R\$ 5,98 AV: R\$ 5,98 15: R\$ 6,11
30: R\$ 6,23 45: R\$ 6,35 60: R\$ 6,48



TINTA PVA 37ML FOSCA 508 VERMELHO ESCAR
Código: Fábrika: Unidade:
48242 ACRILEX UN/1
F1 F4

UN: R\$ 5,98 AV: R\$ 5,98 15: R\$ 6,11
30: R\$ 6,23 45: R\$ 6,35 60: R\$ 6,48



TINTA PVA 37ML FOSCA 510 VERDE FOLHA
Código: Fábrika: Unidade:
48243 ACRILEX UN/1
F1 F4

UN: R\$ 5,98 AV: R\$ 5,98 15: R\$ 6,11
30: R\$ 6,23 45: R\$ 6,35 60: R\$ 6,48



TINTA PVA 37ML FOSCA 511 VERDE BANDEIRA
Código: Fábrika: Unidade:
48244 ACRILEX UN/1
F1 F4

UN: R\$ 5,98 AV: R\$ 5,98 15: R\$ 6,11
30: R\$ 6,23 45: R\$ 6,35 60: R\$ 6,48



TINTA PVA 37ML FOSCA 513 VERDE MUSGO
Código: Fábrika: Unidade:
48245 ACRILEX UN/1
F1 F4

UN: R\$ 5,98 AV: R\$ 5,98 15: R\$ 6,11
30: R\$ 6,23 45: R\$ 6,35 60: R\$ 6,48



TINTA PVA 37ML FOSCA 516 VIOLETA
Código: Fábrika: Unidade:
48246 ACRILEX UN/1
F1 F4

UN: R\$ 5,98 AV: R\$ 5,98 15: R\$ 6,11
30: R\$ 6,23 45: R\$ 6,35 60: R\$ 6,48



TINTA PVA 37ML FOSCA 517 LARANJA
Código: Fábrika: Unidade:
48247 ACRILEX UN/1
F1 F4

UN: R\$ 5,98 AV: R\$ 5,98 15: R\$ 6,11
30: R\$ 6,23 45: R\$ 6,35 60: R\$ 6,48



TINTA PVA 37ML FOSCA 519 BRANCO
Código: Fábrika: Unidade:
48235 ACRILEX UN/1
F1 F4

UN: R\$ 5,98 AV: R\$ 5,98 15: R\$ 6,11
30: R\$ 6,23 45: R\$ 6,35 60: R\$ 6,48



TINTA PVA 37ML FOSCA 520 PRETO
Código: Fábrika: Unidade:
48262 ACRILEX UN/1
F1 F4

UN: R\$ 5,98 AV: R\$ 5,98 15: R\$ 6,11
30: R\$ 6,23 45: R\$ 6,35 60: R\$ 6,48



TINTA PVA 37ML FOSCA 528 LILAS
Código: Fábrica: Unidade:
48248 ACRILEX UN/1
F1 F4

UN: R\$ 5,98 AV: R\$ 5,98 15: R\$ 6,11
30: R\$ 6,23 45: R\$ 6,35 60: R\$ 6,48



TINTA PVA 37ML FOSCA 531 MARROM
Código: Fábrica: Unidade:
48249 ACRILEX UN/1
F1 F4

UN: R\$ 5,98 AV: R\$ 5,98 15: R\$ 6,11
30: R\$ 6,23 45: R\$ 6,35 60: R\$ 6,48



TINTA PVA 37ML FOSCA 535 AZUL MAR
Código: Fábrica: Unidade:
48250 ACRILEX UN/1
F1 F4

UN: R\$ 5,98 AV: R\$ 5,98 15: R\$ 6,11
30: R\$ 6,23 45: R\$ 6,35 60: R\$ 6,48



TINTA PVA 37ML FOSCA 537 ROSA
Código: Fábrica: Unidade:
48251 ACRILEX UN/1
F1 F4

UN: R\$ 5,98 AV: R\$ 5,98 15: R\$ 6,11
30: R\$ 6,23 45: R\$ 6,35 60: R\$ 6,48



TINTA PVA 37ML FOSCA 538 AMARELO PESSEG
Código: Fábrica: Unidade:
48252 ACRILEX UN/1
F1 F4

UN: R\$ 5,98 AV: R\$ 5,98 15: R\$ 6,11
30: R\$ 6,23 45: R\$ 6,35 60: R\$ 6,48



TINTA PVA 37ML FOSCA 541 VERMELHO VIVO
Código: Fábrica: Unidade:
48253 ACRILEX UN/1
F1 F4

UN: R\$ 5,98 AV: R\$ 5,98 15: R\$ 6,11
30: R\$ 6,23 45: R\$ 6,35 60: R\$ 6,48



TINTA PVA 37ML FOSCA 542 ROSA ESCURO
Código: Fábrica: Unidade:
48254 ACRILEX UN/1
F1 F4

UN: R\$ 5,98 AV: R\$ 5,98 15: R\$ 6,11
30: R\$ 6,23 45: R\$ 6,35 60: R\$ 6,48



TINTA PVA 37ML FOSCA 549 MAGENTA
Código: Fábrica: Unidade:
48255 ACRILEX UN/1
F1 F4

UN: R\$ 5,98 AV: R\$ 5,98 15: R\$ 6,11
30: R\$ 6,23 45: R\$ 6,35 60: R\$ 6,48



TINTA PVA 37ML FOSCA 565 VINHO
Código: Fábrica: Unidade:
48256 ACRILEX UN/1
F1 F4

UN: R\$ 5,98 AV: R\$ 5,98 15: R\$ 6,11
30: R\$ 6,23 45: R\$ 6,35 60: R\$ 6,48



TINTA PVA 37ML FOSCA 567 ROSA CHA
Código: Fábrica: Unidade:
48406 ACRILEX UN/1
F1 F4

UN: R\$ 5,98 AV: R\$ 5,98 15: R\$ 6,11
30: R\$ 6,23 45: R\$ 6,35 60: R\$ 6,48



TINTA PVA 37ML FOSCA 574 CINZA LUNAR
Código: Fábrica: Unidade:
48405 ACRILEX UN/1
F1 F4

UN: R\$ 5,98 AV: R\$ 5,98 15: R\$ 6,11
30: R\$ 6,23 45: R\$ 6,35 60: R\$ 6,48



TINTA PVA 37ML FOSCA 577 TURQUESA
Código: Fábrica: Unidade:
48257 ACRILEX UN/1
F1 F4

UN: R\$ 5,98 AV: R\$ 5,98 15: R\$ 6,11
30: R\$ 6,23 45: R\$ 6,35 60: R\$ 6,48



TINTA PVA 37ML FOSCA 813 ROSA BB
Código: Fábrica: Unidade:
48258 ACRILEX UN/1
F1 F4

UN: R\$ 5,98 AV: R\$ 5,98 15: R\$ 6,11
30: R\$ 6,23 45: R\$ 6,35 60: R\$ 6,48



TINTA PVA 37ML FOSCA 817 AREIA
Código: Fábrica: Unidade:
48259 ACRILEX UN/1
F1 F4

UN: R\$ 5,98 AV: R\$ 5,98 15: R\$ 6,11
30: R\$ 6,23 45: R\$ 6,35 60: R\$ 6,48











TINTA PVA 37ML FOSCA 829 FLAMINGO
Código: Fábrica: Unidade:
48260 ACRILEX UN/1
F1 F4

UN: R\$ 24,95 AV: R\$ 24,95 15: R\$ 25,47
30: R\$ 25,98 45: R\$ 26,50 60: R\$ 27,03



TINTA SPRAY 350ML 250G ALUMINIO
Código: Fábrica: Unidade:
42226 TEK BOND UN/1
F1 F4

<p>UN: R\$ 22,12 AV: R\$ 22,12 15: R\$ 22,59 30: R\$ 23,04 45: R\$ 23,50 60: R\$ 23,97</p>  <p>TINTA SPRAY 350ML 250G AMARELO</p> <p>Código: Fábrica: Unidade: 42220 TEK BOND UN/1 F1 F4</p>	<p>UN: R\$ 22,12 AV: R\$ 22,12 15: R\$ 22,59 30: R\$ 23,04 45: R\$ 23,50 60: R\$ 23,97</p>  <p>TINTA SPRAY 350ML 250G AZUL</p> <p>Código: Fábrica: Unidade: 42222 TEK BOND UN/1 F1 F4</p>	<p>UN: R\$ 22,12 AV: R\$ 22,12 15: R\$ 22,59 30: R\$ 23,04 45: R\$ 23,50 60: R\$ 23,97</p>  <p>TINTA SPRAY 350ML 250G BRANCO BRILHANTE</p> <p>Código: Fábrica: Unidade: 42214 TEK BOND UN/1 F1 F4</p>	<p>UN: R\$ 22,12 AV: R\$ 22,12 15: R\$ 22,59 30: R\$ 23,04 45: R\$ 23,50 60: R\$ 23,97</p>  <p>TINTA SPRAY 350ML 250G BRANCO FOSCO</p> <p>Código: Fábrica: Unidade: 42215 TEK BOND UN/1 F1 F4</p>
<p>UN: R\$ 34,93 AV: R\$ 34,93 15: R\$ 35,66 30: R\$ 36,38 45: R\$ 37,10 60: R\$ 37,84</p>  <p>TINTA SPRAY 350ML 250G DOURADO</p> <p>Código: Fábrica: Unidade: 42218 TEK BOND UN/1 F1 F4</p>	<p>UN: R\$ 22,12 AV: R\$ 22,12 15: R\$ 22,59 30: R\$ 23,04 45: R\$ 23,50 60: R\$ 23,97</p>  <p>TINTA SPRAY 350ML 250G GELO</p> <p>Código: Fábrica: Unidade: 48646 TEK BOND UN/1 F1 F4</p>	<p>UN: R\$ 22,12 AV: R\$ 22,12 15: R\$ 22,59 30: R\$ 23,04 45: R\$ 23,50 60: R\$ 23,97</p>  <p>TINTA SPRAY 350ML 250G GRAFITE</p> <p>Código: Fábrica: Unidade: 48645 TEK BOND UN/1 F1 F4</p>	<p>UN: R\$ 22,12 AV: R\$ 22,12 15: R\$ 22,59 30: R\$ 23,04 45: R\$ 23,50 60: R\$ 23,97</p>  <p>TINTA SPRAY 350ML 250G LARANJA</p> <p>Código: Fábrica: Unidade: 42224 TEK BOND UN/1 F1 F4</p>
<p>UN: R\$ 22,12 AV: R\$ 22,12 15: R\$ 22,59 30: R\$ 23,04 45: R\$ 23,50 60: R\$ 23,97</p>  <p>TINTA SPRAY 350ML 250G PLATINA</p> <p>Código: Fábrica: Unidade: 48647 TEK BOND UN/1 F1 F4</p>	<p>UN: R\$ 22,12 AV: R\$ 22,12 15: R\$ 22,59 30: R\$ 23,04 45: R\$ 23,50 60: R\$ 23,97</p>  <p>TINTA SPRAY 350ML 250G PREMIER FUNDO</p> <p>Código: Fábrica: Unidade: 42227 TEK BOND UN/1 F1 F4</p>	<p>UN: R\$ 22,12 AV: R\$ 22,12 15: R\$ 22,59 30: R\$ 23,04 45: R\$ 23,50 60: R\$ 23,97</p>  <p>TINTA SPRAY 350ML 250G PRETO BRILHANTE</p> <p>Código: Fábrica: Unidade: 42216 TEK BOND UN/1 F1 F4</p>	<p>UN: R\$ 22,12 AV: R\$ 22,12 15: R\$ 22,59 30: R\$ 23,04 45: R\$ 23,50 60: R\$ 23,97</p>  <p>TINTA SPRAY 350ML 250G PRETO FOSCO</p> <p>Código: Fábrica: Unidade: 42217 TEK BOND UN/1 F1 F4</p>
<p>UN: R\$ 22,12 AV: R\$ 22,12 15: R\$ 22,59 30: R\$ 23,04 45: R\$ 23,50 60: R\$ 23,97</p>  <p>TINTA SPRAY 350ML 250G ROSA</p> <p>Código: Fábrica: Unidade: 42225 TEK BOND UN/1 F1 F4</p>	<p>UN: R\$ 24,95 AV: R\$ 24,95 15: R\$ 25,47 30: R\$ 25,98 45: R\$ 26,50 60: R\$ 27,03</p>  <p>TINTA SPRAY 350ML 250G VERDE</p> <p>Código: Fábrica: Unidade: 42223 TEK BOND UN/1 F1 F4</p>	<p>UN: R\$ 24,95 AV: R\$ 24,95 15: R\$ 25,47 30: R\$ 25,98 45: R\$ 26,50 60: R\$ 27,03</p>  <p>TINTA SPRAY 350ML 250G VERMELHO</p> <p>Código: Fábrica: Unidade: 42219 TEK BOND UN/1 F1 F4</p>	<p>UN: R\$ 9,97 AV: R\$ 9,97 15: R\$ 10,18 30: R\$ 10,39 45: R\$ 10,59 60: R\$ 10,81</p>  <p>TINTA TECIDO 35ML ACRIPUFF 501 AZUL TUR</p> <p>Código: Fábrica: Unidade: 44838 ACRILEX UN/1 F1 F4</p>

UN: R\$ 9,97 AV: R\$ 9,97 15: R\$ 10,18
30: R\$ 10,39 45: R\$ 10,59 60: R\$ 10,81



TINTA TECIDO 35ML ACRIPUFF 505 AMARELO
Código: 44840 Fábrica: ACRILEX Unidade: UN/1 F1 F4

UN: R\$ 9,97 AV: R\$ 9,97 15: R\$ 10,18
30: R\$ 10,39 45: R\$ 10,59 60: R\$ 10,81



TINTA TECIDO 35ML ACRIPUFF 507 VERMELHO
Código: 44841 Fábrica: ACRILEX Unidade: UN/1 F1 F4

UN: R\$ 9,97 AV: R\$ 9,97 15: R\$ 10,18
30: R\$ 10,39 45: R\$ 10,59 60: R\$ 10,81



TINTA TECIDO 35ML ACRIPUFF 513 VERDE MU
Código: 44845 Fábrica: ACRILEX Unidade: UN/1 F1 F4

UN: R\$ 9,97 AV: R\$ 9,97 15: R\$ 10,18
30: R\$ 10,39 45: R\$ 10,59 60: R\$ 10,81



TINTA TECIDO 35ML ACRIPUFF 519 BRANCO
Código: 44837 Fábrica: ACRILEX Unidade: UN/1 F1 F4

UN: R\$ 9,97 AV: R\$ 9,97 15: R\$ 10,18
30: R\$ 10,39 45: R\$ 10,59 60: R\$ 10,81



TINTA TECIDO 35ML ACRIPUFF 520 PRETO
Código: 44839 Fábrica: ACRILEX Unidade: UN/1 F1 F4

UN: R\$ 9,97 AV: R\$ 9,97 15: R\$ 10,18
30: R\$ 10,39 45: R\$ 10,59 60: R\$ 10,81



TINTA TECIDO 35ML ACRIPUFF 531 MARROM
Código: 44842 Fábrica: ACRILEX Unidade: UN/1 F1 F4

UN: R\$ 9,97 AV: R\$ 9,97 15: R\$ 10,18
30: R\$ 10,39 45: R\$ 10,59 60: R\$ 10,81



TINTA TECIDO 35ML ACRIPUFF 537 ROSA
Código: 44843 Fábrica: ACRILEX Unidade: UN/1 F1 F4

UN: R\$ 9,97 AV: R\$ 9,97 15: R\$ 10,18
30: R\$ 10,39 45: R\$ 10,59 60: R\$ 10,81



TINTA TECIDO 35ML ACRIPUFF 540 VIOLETA
Código: 44844 Fábrica: ACRILEX Unidade: UN/1 F1 F4

UN: R\$ 4,48 AV: R\$ 4,48 15: R\$ 4,58
30: R\$ 4,67 45: R\$ 4,76 60: R\$ 4,86



TINTA TECIDO 37ML AMARELO SOL
Código: 48632 Fábrica: TEK BOND Unidade: UN/1 F1 F4

UN: R\$ 4,48 AV: R\$ 4,48 15: R\$ 4,58
30: R\$ 4,67 45: R\$ 4,76 60: R\$ 4,86



TINTA TECIDO 37ML AZUL CARIBE
Código: 50727 Fábrica: TEK BOND Unidade: UN/1 F1 F4

UN: R\$ 4,48 AV: R\$ 4,48 15: R\$ 4,58
30: R\$ 4,67 45: R\$ 4,76 60: R\$ 4,86



TINTA TECIDO 37ML AZUL ROYAL
Código: 48636 Fábrica: TEK BOND Unidade: UN/1 F1 F4

UN: R\$ 4,48 AV: R\$ 4,48 15: R\$ 4,58
30: R\$ 4,67 45: R\$ 4,76 60: R\$ 4,86



TINTA TECIDO 37ML BRANCO
Código: 48629 Fábrica: TEK BOND Unidade: UN/1 F1 F4

UN: R\$ 4,48 AV: R\$ 4,48 15: R\$ 4,58
30: R\$ 4,67 45: R\$ 4,76 60: R\$ 4,86



TINTA TECIDO 37ML LILAS
Código: 48637 Fábrica: TEK BOND Unidade: UN/1 F1 F4

UN: R\$ 4,48 AV: R\$ 4,48 15: R\$ 4,58
30: R\$ 4,67 45: R\$ 4,76 60: R\$ 4,86



TINTA TECIDO 37ML MARROM
Código: 48635 Fábrica: TEK BOND Unidade: UN/1 F1 F4

UN: R\$ 4,48 AV: R\$ 4,48 15: R\$ 4,58
30: R\$ 4,67 45: R\$ 4,76 60: R\$ 4,86



TINTA TECIDO 37ML PINK
Código: 48638 Fábrica: TEK BOND Unidade: UN/1 F1 F4

UN: R\$ 4,48 AV: R\$ 4,48 15: R\$ 4,58
30: R\$ 4,67 45: R\$ 4,76 60: R\$ 4,86



TINTA TECIDO 37ML PRETO
Código: 48630 Fábrica: TEK BOND Unidade: UN/1 F1 F4

UN: R\$ 4,48 AV: R\$ 4,48 15: R\$ 4,58
30: R\$ 4,67 45: R\$ 4,76 60: R\$ 4,86



TINTA TECIDO 37ML ROSA CRUSH

Código: 50732 Fábrica: TEK BOND Unidade: UN/1 F1 F4

UN: R\$ 4,48 AV: R\$ 4,48 15: R\$ 4,58
30: R\$ 4,67 45: R\$ 4,76 60: R\$ 4,86



TINTA TECIDO 37ML ROXO

Código: 48633 Fábrica: TEK BOND Unidade: UN/1 F1 F4

UN: R\$ 4,48 AV: R\$ 4,48 15: R\$ 4,58
30: R\$ 4,67 45: R\$ 4,76 60: R\$ 4,86



TINTA TECIDO 37ML VERDE FLORESTA

Código: 48634 Fábrica: TEK BOND Unidade: UN/1 F1 F4

UN: R\$ 4,48 AV: R\$ 4,48 15: R\$ 4,58
30: R\$ 4,67 45: R\$ 4,76 60: R\$ 4,86



TINTA TECIDO 37ML VERDE GRAMA

Código: 50729 Fábrica: TEK BOND Unidade: UN/1 F1 F4

UN: R\$ 4,48 AV: R\$ 4,48 15: R\$ 4,58
30: R\$ 4,67 45: R\$ 4,76 60: R\$ 4,86



TINTA TECIDO 37ML VERMELHO

Código: 48631 Fábrica: TEK BOND Unidade: UN/1 F1 F4

UN: R\$ 4,48 AV: R\$ 4,48 15: R\$ 4,58
30: R\$ 4,67 45: R\$ 4,76 60: R\$ 4,86



TINTA TECIDO 37ML VERMELHO AMOR

Código: 50724 Fábrica: TEK BOND Unidade: UN/1 F1 F4

UN: R\$ 4,48 AV: R\$ 4,48 15: R\$ 4,58
30: R\$ 4,67 45: R\$ 4,76 60: R\$ 4,86



TINTA TECIDO 37ML VERMELHO CARMESIM

Código: 50730 Fábrica: TEK BOND Unidade: UN/1 F1 F4

UN: R\$ 4,48 AV: R\$ 4,48 15: R\$ 4,58
30: R\$ 4,67 45: R\$ 4,76 60: R\$ 4,86



TINTA TECIDO 37ML VERMELHO PIMENTA

Código: 50726 Fábrica: TEK BOND Unidade: UN/1 F1 F4

UN: R\$ 4,48 AV: R\$ 4,48 15: R\$ 4,58
30: R\$ 4,67 45: R\$ 4,76 60: R\$ 4,86



TINTA TECIDO 37ML VERMELHO SANGUE

Código: 50725 Fábrica: TEK BOND Unidade: UN/1 F1 F4

UN: R\$ 4,48 AV: R\$ 4,48 15: R\$ 4,58
30: R\$ 4,67 45: R\$ 4,76 60: R\$ 4,86



TINTA TECIDO 37ML VERMELHO TELHA

Código: 50731 Fábrica: TEK BOND Unidade: UN/1 F1 F4

UN: R\$ 5,98 AV: R\$ 5,98 15: R\$ 6,11
30: R\$ 6,23 45: R\$ 6,35 60: R\$ 6,48



TINTA TECIDO 37ML 500 CLAREADOR

Código: 44854 Fábrica: ACRILEX Unidade: UN/1 F1 F4

UN: R\$ 5,98 AV: R\$ 5,98 15: R\$ 6,11
30: R\$ 6,23 45: R\$ 6,35 60: R\$ 6,48



TINTA TECIDO 37ML 501 AZUL TURQUESA

Código: 45022 Fábrica: ACRILEX Unidade: UN/1 F1 F4

UN: R\$ 5,98 AV: R\$ 5,98 15: R\$ 6,11
30: R\$ 6,23 45: R\$ 6,35 60: R\$ 6,48



TINTA TECIDO 37ML 502 AZUL COBALTO

Código: 44937 Fábrica: ACRILEX Unidade: UN/1 F1 F4

UN: R\$ 5,98 AV: R\$ 5,98 15: R\$ 6,11
30: R\$ 6,23 45: R\$ 6,35 60: R\$ 6,48



TINTA TECIDO 37ML 503 AZUL CELESTE

Código: 44856 Fábrica: ACRILEX Unidade: UN/1 F1 F4

UN: R\$ 5,98 AV: R\$ 5,98 15: R\$ 6,11
30: R\$ 6,23 45: R\$ 6,35 60: R\$ 6,48



TINTA TECIDO 37ML 504 AMARELO LIMAO

Código: 44893 Fábrica: ACRILEX Unidade: UN/1 F1 F4

UN: R\$ 5,98 AV: R\$ 5,98 15: R\$ 6,11
30: R\$ 6,23 45: R\$ 6,35 60: R\$ 6,48



TINTA TECIDO 37ML 505 AMARELO OURO

Código: 44896 Fábrica: ACRILEX Unidade: UN/1 F1 F4

UN: R\$ 5,98 AV: R\$ 5,98 15: R\$ 6,11
30: R\$ 6,23 45: R\$ 6,35 60: R\$ 6,48



TINTA TECIDO 37ML 506 CERAMICA

Código: 44952 Fábrica: ACRILEX Unidade: UN/1 F1 F4

UN: R\$ 5,98 AV: R\$ 5,98 15: R\$ 6,11
30: R\$ 6,23 45: R\$ 6,35 60: R\$ 6,48



TINTA TECIDO 37ML 507 VERMELHO FOGO

Código: 44920 Fábrica: ACRILEX Unidade: UN/1 F1 F4

UN: R\$ 5,98 AV: R\$ 5,98 15: R\$ 6,11
30: R\$ 6,23 45: R\$ 6,35 60: R\$ 6,48



TINTA TECIDO 37ML 508 VERMELHO ESCARLAT

Código: 44912 Fábrica: ACRILEX Unidade: UN/1 F1 F4

UN: R\$ 5,98 AV: R\$ 5,98 15: R\$ 6,11
30: R\$ 6,23 45: R\$ 6,35 60: R\$ 6,48



TINTA TECIDO 37ML 509 VERMELHO CARMIN

Código: 44913 Fábrica: ACRILEX Unidade: UN/1 F1 F4

UN: R\$ 5,98 AV: R\$ 5,98 15: R\$ 6,11
30: R\$ 6,23 45: R\$ 6,35 60: R\$ 6,48



TINTA TECIDO 37ML 510 VERDE FOLHA

Código: 44933 Fábrica: ACRILEX Unidade: UN/1 F1 F4

UN: R\$ 5,98 AV: R\$ 5,98 15: R\$ 6,11
30: R\$ 6,23 45: R\$ 6,35 60: R\$ 6,48



TINTA TECIDO 37ML 511 VERDE BANDEIRA

Código: 44930 Fábrica: ACRILEX Unidade: UN/1 F1 F4

UN: R\$ 5,98 AV: R\$ 5,98 15: R\$ 6,11
30: R\$ 6,23 45: R\$ 6,35 60: R\$ 6,48



TINTA TECIDO 37ML 512 VERDE VERONESE

Código: 44961 Fábrica: ACRILEX Unidade: UN/1 F1 F4

UN: R\$ 5,98 AV: R\$ 5,98 15: R\$ 6,11
30: R\$ 6,23 45: R\$ 6,35 60: R\$ 6,48



TINTA TECIDO 37ML 513 VERDE MUSGO

Código: 44935 Fábrica: ACRILEX Unidade: UN/1 F1 F4

UN: R\$ 5,98 AV: R\$ 5,98 15: R\$ 6,11
30: R\$ 6,23 45: R\$ 6,35 60: R\$ 6,48



TINTA TECIDO 37ML 514 TERRA QUEI

Código: 44964 Fábrica: ACRILEX Unidade: UN/1 F1 F4

UN: R\$ 5,98 AV: R\$ 5,98 15: R\$ 6,11
30: R\$ 6,23 45: R\$ 6,35 60: R\$ 6,48



TINTA TECIDO 37ML 516 VIOLETA

Código: 44874 Fábrica: ACRILEX Unidade: UN/1 F1 F4

UN: R\$ 5,98 AV: R\$ 5,98 15: R\$ 6,11
30: R\$ 6,23 45: R\$ 6,35 60: R\$ 6,48



TINTA TECIDO 37ML 517 LARANJA

Código: 44942 Fábrica: ACRILEX Unidade: UN/1 F1 F4

UN: R\$ 5,98 AV: R\$ 5,98 15: R\$ 6,11
30: R\$ 6,23 45: R\$ 6,35 60: R\$ 6,48



TINTA TECIDO 37ML 518 SALMAO

Código: 44885 Fábrica: ACRILEX Unidade: UN/1 F1 F4

UN: R\$ 5,98 AV: R\$ 5,98 15: R\$ 6,11
30: R\$ 6,23 45: R\$ 6,35 60: R\$ 6,48



TINTA TECIDO 37ML 519 BRANCO

Código: 44851 Fábrica: ACRILEX Unidade: UN/1 F1 F4

UN: R\$ 5,98 AV: R\$ 5,98 15: R\$ 6,11
30: R\$ 6,23 45: R\$ 6,35 60: R\$ 6,48



TINTA TECIDO 37ML 520 PRETO

Código: 44852 Fábrica: ACRILEX Unidade: UN/1 F1 F4

UN: R\$ 5,98 AV: R\$ 5,98 15: R\$ 6,11
30: R\$ 6,23 45: R\$ 6,35 60: R\$ 6,48



TINTA TECIDO 37ML 525 CAMURCA

Código: 44870 Fábrica: ACRILEX Unidade: UN/1 F1 F4

UN: R\$ 5,98 AV: R\$ 5,98 15: R\$ 6,11
30: R\$ 6,23 45: R\$ 6,35 60: R\$ 6,48



TINTA TECIDO 37ML 527 ROSA PINK

Código: 44903 Fábrica: ACRILEX Unidade: UN/1 F1 F4

UN: R\$ 5,98 AV: R\$ 5,98 15: R\$ 6,11
30: R\$ 6,23 45: R\$ 6,35 60: R\$ 6,48



TINTA TECIDO 37ML 528 LILAS
Código: 44888 Fábrica: ACRILEX Unidade: UN/1 F1 F4

UN: R\$ 5,98 AV: R\$ 5,98 15: R\$ 6,11
30: R\$ 6,23 45: R\$ 6,35 60: R\$ 6,48



TINTA TECIDO 37ML 529 MARFIM
Código: 44891 Fábrica: ACRILEX Unidade: UN/1 F1 F4

UN: R\$ 5,98 AV: R\$ 5,98 15: R\$ 6,11
30: R\$ 6,23 45: R\$ 6,35 60: R\$ 6,48



TINTA TECIDO 37ML 531 MARROM
Código: 44882 Fábrica: ACRILEX Unidade: UN/1 F1 F4

UN: R\$ 5,98 AV: R\$ 5,98 15: R\$ 6,11
30: R\$ 6,23 45: R\$ 6,35 60: R\$ 6,48



TINTA TECIDO 37ML 535 AZUL MAR
Código: 45023 Fábrica: ACRILEX Unidade: UN/1 F1 F4

UN: R\$ 5,98 AV: R\$ 5,98 15: R\$ 6,11
30: R\$ 6,23 45: R\$ 6,35 60: R\$ 6,48



TINTA TECIDO 37ML 536 AMARELO CADMIO
Código: 44898 Fábrica: ACRILEX Unidade: UN/1 F1 F4

UN: R\$ 5,98 AV: R\$ 5,98 15: R\$ 6,11
30: R\$ 6,23 45: R\$ 6,35 60: R\$ 6,48



TINTA TECIDO 37ML 537 ROSA
Código: 44901 Fábrica: ACRILEX Unidade: UN/1 F1 F4

UN: R\$ 5,98 AV: R\$ 5,98 15: R\$ 6,11
30: R\$ 6,23 45: R\$ 6,35 60: R\$ 6,48



TINTA TECIDO 37ML 538 AMARELO PESSEGO
Código: 44895 Fábrica: ACRILEX Unidade: UN/1 F1 F4

UN: R\$ 5,98 AV: R\$ 5,98 15: R\$ 6,11
30: R\$ 6,23 45: R\$ 6,35 60: R\$ 6,48



TINTA TECIDO 37ML 539 SIENA NATURAL
Código: 44965 Fábrica: ACRILEX Unidade: UN/1 F1 F4

UN: R\$ 5,98 AV: R\$ 5,98 15: R\$ 6,11
30: R\$ 6,23 45: R\$ 6,35 60: R\$ 6,48



TINTA TECIDO 37ML 540 VIOLETA COBALTO
Código: 44958 Fábrica: ACRILEX Unidade: UN/1 F1 F4

UN: R\$ 5,98 AV: R\$ 5,98 15: R\$ 6,11
30: R\$ 6,23 45: R\$ 6,35 60: R\$ 6,48



TINTA TECIDO 37ML 541 VERMELHO VIVO
Código: 44915 Fábrica: ACRILEX Unidade: UN/1 F1 F4

UN: R\$ 5,98 AV: R\$ 5,98 15: R\$ 6,11
30: R\$ 6,23 45: R\$ 6,35 60: R\$ 6,48



TINTA TECIDO 37ML 542 ROSA ESCURO
Código: 44906 Fábrica: ACRILEX Unidade: UN/1 F1 F4

UN: R\$ 5,98 AV: R\$ 5,98 15: R\$ 6,11
30: R\$ 6,23 45: R\$ 6,35 60: R\$ 6,48



TINTA TECIDO 37ML 543 AZUL ULTRAMAR
Código: 44940 Fábrica: ACRILEX Unidade: UN/1 F1 F4

UN: R\$ 5,98 AV: R\$ 5,98 15: R\$ 6,11
30: R\$ 6,23 45: R\$ 6,35 60: R\$ 6,48



TINTA TECIDO 37ML 544 AZUL MARINHO
Código: 44865 Fábrica: ACRILEX Unidade: UN/1 F1 F4

UN: R\$ 5,98 AV: R\$ 5,98 15: R\$ 6,11
30: R\$ 6,23 45: R\$ 6,35 60: R\$ 6,48



TINTA TECIDO 37ML 545 VERDE OLIVA
Código: 44934 Fábrica: ACRILEX Unidade: UN/1 F1 F4

UN: R\$ 5,98 AV: R\$ 5,98 15: R\$ 6,11
30: R\$ 6,23 45: R\$ 6,35 60: R\$ 6,48



TINTA TECIDO 37ML 546 VERDE PINHEIRO
Código: 44947 Fábrica: ACRILEX Unidade: UN/1 F1 F4

UN: R\$ 5,98 AV: R\$ 5,98 15: R\$ 6,11
30: R\$ 6,23 45: R\$ 6,35 60: R\$ 6,48



TINTA TECIDO 37ML 549 MAGENTA
Código: 44910 Fábrica: ACRILEX Unidade: UN/1 F1 F4

UN: R\$ 5,98 AV: R\$ 5,98 15: R\$ 6,11
30: R\$ 6,23 45: R\$ 6,35 60: R\$ 6,48



TINTA TECIDO 37ML 550 VERMELHO PURPURA
Código: 44917 Fábrica: ACRILEX Unidade: UN/1 F1 F4

UN: R\$ 5,98 AV: R\$ 5,98 15: R\$ 6,11
30: R\$ 6,23 45: R\$ 6,35 60: R\$ 6,48



TINTA TECIDO 37ML 551 SEPIA
Código: 44869 Fábrica: ACRILEX Unidade: UN/1 F1 F4

UN: R\$ 5,98 AV: R\$ 5,98 15: R\$ 6,11
30: R\$ 6,23 45: R\$ 6,35 60: R\$ 6,48



TINTA TECIDO 37ML 552 VERDE GLACIAL
Código: 44931 Fábrica: ACRILEX Unidade: UN/1 F1 F4

UN: R\$ 5,98 AV: R\$ 5,98 15: R\$ 6,11
30: R\$ 6,23 45: R\$ 6,35 60: R\$ 6,48



TINTA TECIDO 37ML 560 AZUL CARIBE
Código: 44859 Fábrica: ACRILEX Unidade: UN/1 F1 F4

UN: R\$ 5,98 AV: R\$ 5,98 15: R\$ 6,11
30: R\$ 6,23 45: R\$ 6,35 60: R\$ 6,48



TINTA TECIDO 37ML 565 VINHO
Código: 44954 Fábrica: ACRILEX Unidade: UN/1 F1 F4

UN: R\$ 5,98 AV: R\$ 5,98 15: R\$ 6,11
30: R\$ 6,23 45: R\$ 6,35 60: R\$ 6,48



TINTA TECIDO 37ML 566 PESSEGO
Código: 44957 Fábrica: ACRILEX Unidade: UN/1 F1 F4

UN: R\$ 5,98 AV: R\$ 5,98 15: R\$ 6,11
30: R\$ 6,23 45: R\$ 6,35 60: R\$ 6,48



TINTA TECIDO 37ML 567 ROSA CHA
Código: 44904 Fábrica: ACRILEX Unidade: UN/1 F1 F4

UN: R\$ 5,98 AV: R\$ 5,98 15: R\$ 6,11
30: R\$ 6,23 45: R\$ 6,35 60: R\$ 6,48



TINTA TECIDO 37ML 568 AZUL CERULEO
Código: 44858 Fábrica: ACRILEX Unidade: UN/1 F1 F4

UN: R\$ 5,98 AV: R\$ 5,98 15: R\$ 6,11
30: R\$ 6,23 45: R\$ 6,35 60: R\$ 6,48



TINTA TECIDO 37ML 569 CARAMELO
Código: 45002 Fábrica: ACRILEX Unidade: UN/1 F1 F4

UN: R\$ 5,98 AV: R\$ 5,98 15: R\$ 6,11
30: R\$ 6,23 45: R\$ 6,35 60: R\$ 6,48



TINTA TECIDO 37ML 570 VERDE PISTA
Código: 44936 Fábrica: ACRILEX Unidade: UN/1 F1 F4

UN: R\$ 5,98 AV: R\$ 5,98 15: R\$ 6,11
30: R\$ 6,23 45: R\$ 6,35 60: R\$ 6,48



TINTA TECIDO 37ML 572 VERDE ABACATE
Código: 44932 Fábrica: ACRILEX Unidade: UN/1 F1 F4

UN: R\$ 5,98 AV: R\$ 5,98 15: R\$ 6,11
30: R\$ 6,23 45: R\$ 6,35 60: R\$ 6,48



TINTA TECIDO 37ML 573 OCRE OURO
Código: 44899 Fábrica: ACRILEX Unidade: UN/1 F1 F4

UN: R\$ 5,98 AV: R\$ 5,98 15: R\$ 6,11
30: R\$ 6,23 45: R\$ 6,35 60: R\$ 6,48



TINTA TECIDO 37ML 574 CINZA LUNAR
Código: 44867 Fábrica: ACRILEX Unidade: UN/1 F1 F4

UN: R\$ 5,98 AV: R\$ 5,98 15: R\$ 6,11
30: R\$ 6,23 45: R\$ 6,35 60: R\$ 6,48



TINTA TECIDO 37ML 576 CENOURA
Código: 44949 Fábrica: ACRILEX Unidade: UN/1 F1 F4

UN: R\$ 5,98 AV: R\$ 5,98 15: R\$ 6,11
30: R\$ 6,23 45: R\$ 6,35 60: R\$ 6,48



TINTA TECIDO 37ML 577 TURQUESA
Código: 44863 Fábrica: ACRILEX Unidade: UN/1 F1 F4

UN: R\$ 5,98 AV: R\$ 5,98 15: R\$ 6,11
30: R\$ 6,23 45: R\$ 6,35 60: R\$ 6,48



TINTA TECIDO 37ML 579 AZUL HORTENSIA
Código: 44857 Fábrica: ACRILEX Unidade: UN/1 F1 F4

UN: R\$ 5,98 AV: R\$ 5,98 15: R\$ 6,11
30: R\$ 6,23 45: R\$ 6,35 60: R\$ 6,48



TINTA TECIDO 37ML 581 ROSA CICLAME
Código: 44968 Fábrica: ACRILEX Unidade: UN/1 F1 F4

UN: R\$ 5,98 AV: R\$ 5,98 15: R\$ 6,11
30: R\$ 6,23 45: R\$ 6,35 60: R\$ 6,48



TINTA TECIDO 37ML 582 VERDE GRAMA
Código: 44929 Fábrica: ACRILEX Unidade: UN/1 F1 F4

UN: R\$ 5,98 AV: R\$ 5,98 15: R\$ 6,11
30: R\$ 6,23 45: R\$ 6,35 60: R\$ 6,48



TINTA TECIDO 37ML 583 VERMELHO TOMATE
Código: 44960 Fábrica: ACRILEX Unidade: UN/1 F1 F4

UN: R\$ 5,98 AV: R\$ 5,98 15: R\$ 6,11
30: R\$ 6,23 45: R\$ 6,35 60: R\$ 6,48



TINTA TECIDO 37ML 584 AZUL INVERNO
Código: 44855 Fábrica: ACRILEX Unidade: UN/1 F1 F4

UN: R\$ 5,98 AV: R\$ 5,98 15: R\$ 6,11
30: R\$ 6,23 45: R\$ 6,35 60: R\$ 6,48



TINTA TECIDO 37ML 586 CORAL
Código: 44956 Fábrica: ACRILEX Unidade: UN/1 F1 F4

UN: R\$ 5,98 AV: R\$ 5,98 15: R\$ 6,11
30: R\$ 6,23 45: R\$ 6,35 60: R\$ 6,48



TINTA TECIDO 37ML 587 LAVANDA
Código: 44890 Fábrica: ACRILEX Unidade: UN/1 F1 F4

UN: R\$ 5,98 AV: R\$ 5,98 15: R\$ 6,11
30: R\$ 6,23 45: R\$ 6,35 60: R\$ 6,48



TINTA TECIDO 37ML 588 VERMELHO QU
Código: 44969 Fábrica: ACRILEX Unidade: UN/1 F1 F4

UN: R\$ 5,98 AV: R\$ 5,98 15: R\$ 6,11
30: R\$ 6,23 45: R\$ 6,35 60: R\$ 6,48



TINTA TECIDO 37ML 589 AMARELO CANÁRIO
Código: 44894 Fábrica: ACRILEX Unidade: UN/1 F1 F4

UN: R\$ 5,98 AV: R\$ 5,98 15: R\$ 6,11
30: R\$ 6,23 45: R\$ 6,35 60: R\$ 6,48



TINTA TECIDO 37ML 593 MOSTARDA
Código: 44872 Fábrica: ACRILEX Unidade: UN/1 F1 F4

UN: R\$ 5,98 AV: R\$ 5,98 15: R\$ 6,11
30: R\$ 6,23 45: R\$ 6,35 60: R\$ 6,48



TINTA TECIDO 37ML 594 VERDE SECO
Código: 44928 Fábrica: ACRILEX Unidade: UN/1 F1 F4

UN: R\$ 5,98 AV: R\$ 5,98 15: R\$ 6,11
30: R\$ 6,23 45: R\$ 6,35 60: R\$ 6,48



TINTA TECIDO 37ML 596 AZUL PETRÓLEO
Código: 44860 Fábrica: ACRILEX Unidade: UN/1 F1 F4

UN: R\$ 5,98 AV: R\$ 5,98 15: R\$ 6,11
30: R\$ 6,23 45: R\$ 6,35 60: R\$ 6,48



TINTA TECIDO 37ML 627 CINZA CLARO
Código: 44950 Fábrica: ACRILEX Unidade: UN/1 F1 F4

UN: R\$ 5,98 AV: R\$ 5,98 15: R\$ 6,11
30: R\$ 6,23 45: R\$ 6,35 60: R\$ 6,48



TINTA TECIDO 37ML 629 CINZA ONIX
Código: 44866 Fábrica: ACRILEX Unidade: UN/1 F1 F4

UN: R\$ 5,98 AV: R\$ 5,98 15: R\$ 6,11
30: R\$ 6,23 45: R\$ 6,35 60: R\$ 6,48



TINTA TECIDO 37ML 630 VERDE MAR
Código: 44922 Fábrica: ACRILEX Unidade: UN/1 F1 F4

UN: R\$ 5,98 AV: R\$ 5,98 15: R\$ 6,11
30: R\$ 6,23 45: R\$ 6,35 60: R\$ 6,48



TINTA TECIDO 37ML 631 PAPAYA
Código: 44884 Fábrica: ACRILEX Unidade: UN/1 F1 F4

UN: R\$ 5,98 AV: R\$ 5,98 15: R\$ 6,11
30: R\$ 6,23 45: R\$ 6,35 60: R\$ 6,48



TINTA TECIDO 37ML 632 VERMELHO PROFUNDO
Código: 44921 Fábrica: ACRILEX Unidade: UN/1 F1 F4

UN: R\$ 5,98 AV: R\$ 5,98 15: R\$ 6,11
30: R\$ 6,23 45: R\$ 6,35 60: R\$ 6,48



TINTA TECIDO 37ML 633 LILAS SECO
Código: Fábrica: Unidade:
44887 ACRILEX UN/1
F1 F4

UN: R\$ 5,98 AV: R\$ 5,98 15: R\$ 6,11
30: R\$ 6,23 45: R\$ 6,35 60: R\$ 6,48



TINTA TECIDO 37ML 634 ROSTINHO BONECA
Código: Fábrica: Unidade:
44908 ACRILEX UN/1
F1 F4

UN: R\$ 5,98 AV: R\$ 5,98 15: R\$ 6,11
30: R\$ 6,23 45: R\$ 6,35 60: R\$ 6,48



TINTA TECIDO 37ML 635 ROSA CANDY
Código: Fábrica: Unidade:
44900 ACRILEX UN/1
F1 F4

UN: R\$ 5,98 AV: R\$ 5,98 15: R\$ 6,11
30: R\$ 6,23 45: R\$ 6,35 60: R\$ 6,48



TINTA TECIDO 37ML 636 ROSA INGLES
Código: Fábrica: Unidade:
44902 ACRILEX UN/1
F1 F4

UN: R\$ 5,98 AV: R\$ 5,98 15: R\$ 6,11
30: R\$ 6,23 45: R\$ 6,35 60: R\$ 6,48



TINTA TECIDO 37ML 638 FLOR MALV
Código: Fábrica: Unidade:
44889 ACRILEX UN/1
F1 F4

UN: R\$ 5,98 AV: R\$ 5,98 15: R\$ 6,11
30: R\$ 6,23 45: R\$ 6,35 60: R\$ 6,48



TINTA TECIDO 37ML 639 MAUVE
Código: Fábrica: Unidade:
44879 ACRILEX UN/1
F1 F4

UN: R\$ 5,98 AV: R\$ 5,98 15: R\$ 6,11
30: R\$ 6,23 45: R\$ 6,35 60: R\$ 6,48



TINTA TECIDO 37ML 640 PITAYA
Código: Fábrica: Unidade:
44911 ACRILEX UN/1
F1 F4

UN: R\$ 5,98 AV: R\$ 5,98 15: R\$ 6,11
30: R\$ 6,23 45: R\$ 6,35 60: R\$ 6,48



TINTA TECIDO 37ML 643 TIJOLO
Código: Fábrica: Unidade:
45001 ACRILEX UN/1
F1 F4

UN: R\$ 5,98 AV: R\$ 5,98 15: R\$ 6,11
30: R\$ 6,23 45: R\$ 6,35 60: R\$ 6,48



TINTA TECIDO 37ML 800 VERMELHO BEBE
Código: Fábrica: Unidade:
44914 ACRILEX UN/1
F1 F4

UN: R\$ 5,98 AV: R\$ 5,98 15: R\$ 6,11
30: R\$ 6,23 45: R\$ 6,35 60: R\$ 6,48



TINTA TECIDO 37ML 801 VERMELHO TANGERIN
Código: Fábrica: Unidade:
44919 ACRILEX UN/1
F1 F4

UN: R\$ 5,98 AV: R\$ 5,98 15: R\$ 6,11
30: R\$ 6,23 45: R\$ 6,35 60: R\$ 6,48



TINTA TECIDO 37ML 802 VERDE MACA
Código: Fábrica: Unidade:
44925 ACRILEX UN/1
F1 F4

UN: R\$ 5,98 AV: R\$ 5,98 15: R\$ 6,11
30: R\$ 6,23 45: R\$ 6,35 60: R\$ 6,48



TINTA TECIDO 37ML 803 ACQUA MARINA
Código: Fábrica: Unidade:
44943 ACRILEX UN/1
F1 F4

UN: R\$ 5,98 AV: R\$ 5,98 15: R\$ 6,11
30: R\$ 6,23 45: R\$ 6,35 60: R\$ 6,48



TINTA TECIDO 37ML 804 FUCHSIA
Código: Fábrica: Unidade:
44876 ACRILEX UN/1
F1 F4

UN: R\$ 5,98 AV: R\$ 5,98 15: R\$ 6,11
30: R\$ 6,23 45: R\$ 6,35 60: R\$ 6,48



TINTA TECIDO 37ML 805 VERMELHO GOIABA Q
Código: Fábrica: Unidade:
44918 ACRILEX UN/1
F1 F4

UN: R\$ 5,98 AV: R\$ 5,98 15: R\$ 6,11
30: R\$ 6,23 45: R\$ 6,35 60: R\$ 6,48



TINTA TECIDO 37ML 807 JACARANDA
Código: Fábrica: Unidade:
44953 ACRILEX UN/1
F1 F4

UN: R\$ 5,98 AV: R\$ 5,98 15: R\$ 6,11
30: R\$ 6,23 45: R\$ 6,35 60: R\$ 6,48



TINTA TECIDO 37ML 808 AMARELO BEBE
Código: Fábrica: Unidade:
44892 ACRILEX UN/1
F1 F4

UN: R\$ 5,98 AV: R\$ 5,98 15: R\$ 6,11
30: R\$ 6,23 45: R\$ 6,35 60: R\$ 6,48



TINTA TECIDO 37ML 809 LILAS

Código: 44938 Fábrica: ACRILEX Unidade: UN/1 F1 F4

UN: R\$ 5,98 AV: R\$ 5,98 15: R\$ 6,11
30: R\$ 6,23 45: R\$ 6,35 60: R\$ 6,48



TINTA TECIDO 37ML 810 VERDE BEBE

Código: 44926 Fábrica: ACRILEX Unidade: UN/1 F1 F4

UN: R\$ 5,98 AV: R\$ 5,98 15: R\$ 6,11
30: R\$ 6,23 45: R\$ 6,35 60: R\$ 6,48



TINTA TECIDO 37ML 811 AZUL BEBE

Código: 44861 Fábrica: ACRILEX Unidade: UN/1 F1 F4

UN: R\$ 5,98 AV: R\$ 5,98 15: R\$ 6,11
30: R\$ 6,23 45: R\$ 6,35 60: R\$ 6,48



TINTA TECIDO 37ML 812 SALMAO BEBE

Código: 44945 Fábrica: ACRILEX Unidade: UN/1 F1 F4

UN: R\$ 5,98 AV: R\$ 5,98 15: R\$ 6,11
30: R\$ 6,23 45: R\$ 6,35 60: R\$ 6,48



TINTA TECIDO 37ML 813 ROSA BEBE

Código: 44966 Fábrica: ACRILEX Unidade: UN/1 F1 F4

UN: R\$ 5,98 AV: R\$ 5,98 15: R\$ 6,11
30: R\$ 6,23 45: R\$ 6,35 60: R\$ 6,48



TINTA TECIDO 37ML 814 CHOCOLATE

Código: 44941 Fábrica: ACRILEX Unidade: UN/1 F1 F4

UN: R\$ 5,98 AV: R\$ 5,98 15: R\$ 6,11
30: R\$ 6,23 45: R\$ 6,35 60: R\$ 6,48



TINTA TECIDO 37ML 815 CASTANHO

Código: 44878 Fábrica: ACRILEX Unidade: UN/1 F1 F4

UN: R\$ 5,98 AV: R\$ 5,98 15: R\$ 6,11
30: R\$ 6,23 45: R\$ 6,35 60: R\$ 6,48



TINTA TECIDO 37ML 817 AREIA

Código: 44877 Fábrica: ACRILEX Unidade: UN/1 F1 F4

UN: R\$ 5,98 AV: R\$ 5,98 15: R\$ 6,11
30: R\$ 6,23 45: R\$ 6,35 60: R\$ 6,48



TINTA TECIDO 37ML 822 VERDE COUNTRY

Código: 44923 Fábrica: ACRILEX Unidade: UN/1 F1 F4

UN: R\$ 5,98 AV: R\$ 5,98 15: R\$ 6,11
30: R\$ 6,23 45: R\$ 6,35 60: R\$ 6,48



TINTA TECIDO 37ML 825 AZUL COUNTRY

Código: 44862 Fábrica: ACRILEX Unidade: UN/1 F1 F4

UN: R\$ 5,98 AV: R\$ 5,98 15: R\$ 6,11
30: R\$ 6,23 45: R\$ 6,35 60: R\$ 6,48



TINTA TECIDO 37ML 828 ROSA ANTIGO

Código: 44905 Fábrica: ACRILEX Unidade: UN/1 F1 F4

UN: R\$ 5,98 AV: R\$ 5,98 15: R\$ 6,11
30: R\$ 6,23 45: R\$ 6,35 60: R\$ 6,48



TINTA TECIDO 37ML 829 FLAMINGO

Código: 44909 Fábrica: ACRILEX Unidade: UN/1 F1 F4

UN: R\$ 5,98 AV: R\$ 5,98 15: R\$ 6,11
30: R\$ 6,23 45: R\$ 6,35 60: R\$ 6,48



TINTA TECIDO 37ML 833 AMARELO GEMA

Código: 44897 Fábrica: ACRILEX Unidade: UN/1 F1 F4

UN: R\$ 5,98 AV: R\$ 5,98 15: R\$ 6,11
30: R\$ 6,23 45: R\$ 6,35 60: R\$ 6,48



TINTA TECIDO 37ML 834 PALHA

Código: 44951 Fábrica: ACRILEX Unidade: UN/1 F1 F4

UN: R\$ 5,98 AV: R\$ 5,98 15: R\$ 6,11
30: R\$ 6,23 45: R\$ 6,35 60: R\$ 6,48



TINTA TECIDO 37ML 860 VERDE PANTANO

Código: 44924 Fábrica: ACRILEX Unidade: UN/1 F1 F4

UN: R\$ 5,98 AV: R\$ 5,98 15: R\$ 6,11
30: R\$ 6,23 45: R\$ 6,35 60: R\$ 6,48



TINTA TECIDO 37ML 895 MELAO

Código: 44873 Fábrica: ACRILEX Unidade: UN/1 F1 F4

UN: R\$ 5,98 AV: R\$ 5,98 15: R\$ 6,11
30: R\$ 6,23 45: R\$ 6,35 60: R\$ 6,48



TINTA TECIDO 37ML 896 RUSTICO

Código: 44871 Fábrica: ACRILEX Unidade: UN/1 F1 F4

UN: R\$ 5,98 AV: R\$ 5,98 15: R\$ 6,11
30: R\$ 6,23 45: R\$ 6,35 60: R\$ 6,48



TINTA TECIDO 37ML 897 VERDE SOFT

Código: 44927 Fábrica: ACRILEX Unidade: UN/1 F1 F4

UN: R\$ 5,98 AV: R\$ 5,98 15: R\$ 6,11
30: R\$ 6,23 45: R\$ 6,35 60: R\$ 6,48



TINTA TECIDO 37ML 909 TUTTI FRUTTI

Código: 44907 Fábrica: ACRILEX Unidade: UN/1 F1 F4

UN: R\$ 5,98 AV: R\$ 5,98 15: R\$ 6,11
30: R\$ 6,23 45: R\$ 6,35 60: R\$ 6,48



TINTA TECIDO 37ML 926 VERDE MUSGO

Código: 44970 Fábrica: ACRILEX Unidade: UN/1 F1 F4

UN: R\$ 5,98 AV: R\$ 5,98 15: R\$ 6,11
30: R\$ 6,23 45: R\$ 6,35 60: R\$ 6,48



TINTA TECIDO 37ML 932 TELHA

Código: 44959 Fábrica: ACRILEX Unidade: UN/1 F1 F4

UN: R\$ 5,98 AV: R\$ 5,98 15: R\$ 6,11
30: R\$ 6,23 45: R\$ 6,35 60: R\$ 6,48



TINTA TECIDO 37ML 933 CINZA

Código: 44868 Fábrica: ACRILEX Unidade: UN/1 F1 F4

UN: R\$ 5,98 AV: R\$ 5,98 15: R\$ 6,11
30: R\$ 6,23 45: R\$ 6,35 60: R\$ 6,48



TINTA TECIDO 37ML 953 MARROM

Código: 44883 Fábrica: ACRILEX Unidade: UN/1 F1 F4

UN: R\$ 5,98 AV: R\$ 5,98 15: R\$ 6,11
30: R\$ 6,23 45: R\$ 6,35 60: R\$ 6,48



TINTA TECIDO 37ML 984 VERMELHO NATAL

Código: 44916 Fábrica: ACRILEX Unidade: UN/1 F1 F4

UN: R\$ 5,98 AV: R\$ 5,98 15: R\$ 6,11
30: R\$ 6,23 45: R\$ 6,35 60: R\$ 6,48



TINTA TECIDO 37ML 985 VERDE KIWI

Código: 44962 Fábrica: ACRILEX Unidade: UN/1 F1 F4

UN: R\$ 5,98 AV: R\$ 5,98 15: R\$ 6,11
30: R\$ 6,23 45: R\$ 6,35 60: R\$ 6,48



TINTA TECIDO 37ML 986 CAQUI

Código: 44948 Fábrica: ACRILEX Unidade: UN/1 F1 F4

UN: R\$ 5,98 AV: R\$ 5,98 15: R\$ 6,11
30: R\$ 6,23 45: R\$ 6,35 60: R\$ 6,48



TINTA TECIDO 37ML 988 ROSE

Código: 44946 Fábrica: ACRILEX Unidade: UN/1 F1 F4

UN: R\$ 5,98 AV: R\$ 5,98 15: R\$ 6,11
30: R\$ 6,23 45: R\$ 6,35 60: R\$ 6,48



TINTA TECIDO 37ML 989 ERVA DOCE

Código: 44955 Fábrica: ACRILEX Unidade: UN/1 F1 F4

UN: R\$ 5,98 AV: R\$ 5,98 15: R\$ 6,11
30: R\$ 6,23 45: R\$ 6,35 60: R\$ 6,48



TINTA TECIDO 37ML 990 MENTA

Código: 44967 Fábrica: ACRILEX Unidade: UN/1 F1 F4

UN: R\$ 5,98 AV: R\$ 5,98 15: R\$ 6,11
30: R\$ 6,23 45: R\$ 6,35 60: R\$ 6,48



TINTA TECIDO 37ML 992 AZUL SOFT

Código: 44864 Fábrica: ACRILEX Unidade: UN/1 F1 F4

UN: R\$ 5,98 AV: R\$ 5,98 15: R\$ 6,11
30: R\$ 6,23 45: R\$ 6,35 60: R\$ 6,48



TINTA TECIDO 37ML 993 AZUL ARDOSIA

Código: 44939 Fábrica: ACRILEX Unidade: UN/1 F1 F4

UN: R\$ 5,98 AV: R\$ 5,98 15: R\$ 6,11
30: R\$ 6,23 45: R\$ 6,35 60: R\$ 6,48



TINTA TECIDO 37ML 994 CINZA CHUMBO

Código: 44944 Fábrica: ACRILEX Unidade: UN/1 F1 F4

UN: R\$ 5,98 AV: R\$ 5,98 15: R\$ 6,11
30: R\$ 6,23 45: R\$ 6,35 60: R\$ 6,48



TINTA TECIDO 37ML 995 VUA
Código: 44875 Fábrica: ACRILEX Unidade: UN/1 F1 F4

UN: R\$ 5,98 AV: R\$ 5,98 15: R\$ 6,11
30: R\$ 6,23 45: R\$ 6,35 60: R\$ 6,48



TINTA TECIDO 37ML 996 BERINJELA
Código: 44963 Fábrica: ACRILEX Unidade: UN/1 F1 F4

UN: R\$ 5,98 AV: R\$ 5,98 15: R\$ 6,11
30: R\$ 6,23 45: R\$ 6,35 60: R\$ 6,48



TINTA TECIDO 37ML 997 JATOBA
Código: 44881 Fábrica: ACRILEX Unidade: UN/1 F1 F4

UN: R\$ 5,98 AV: R\$ 5,98 15: R\$ 6,11
30: R\$ 6,23 45: R\$ 6,35 60: R\$ 6,48



TINTA TECIDO 37ML 998 AMORA
Código: 44886 Fábrica: ACRILEX Unidade: UN/1 F1 F4

UN: R\$ 29,94 AV: R\$ 29,94 15: R\$ 30,57
30: R\$ 31,18 45: R\$ 31,80 60: R\$ 32,44



TINTA TECIDO 250ML AMARELO SOL
Código: 48623 Fábrica: TEK BOND Unidade: UN/1 F1 F4

UN: R\$ 29,94 AV: R\$ 29,94 15: R\$ 30,57
30: R\$ 31,18 45: R\$ 31,80 60: R\$ 32,44



TINTA TECIDO 250ML AZUL ROYAL
Código: 48621 Fábrica: TEK BOND Unidade: UN/1 F1 F4

UN: R\$ 29,94 AV: R\$ 29,94 15: R\$ 30,57
30: R\$ 31,18 45: R\$ 31,80 60: R\$ 32,44



TINTA TECIDO 250ML BRANCO
Código: 48619 Fábrica: TEK BOND Unidade: UN/1 F1 F4

UN: R\$ 29,94 AV: R\$ 29,94 15: R\$ 30,57
30: R\$ 31,18 45: R\$ 31,80 60: R\$ 32,44



TINTA TECIDO 250ML LILAS
Código: 48625 Fábrica: TEK BOND Unidade: UN/1 F1 F4

UN: R\$ 29,94 AV: R\$ 29,94 15: R\$ 30,57
30: R\$ 31,18 45: R\$ 31,80 60: R\$ 32,44



TINTA TECIDO 250ML MARROM
Código: 48624 Fábrica: TEK BOND Unidade: UN/1 F1 F4

UN: R\$ 29,94 AV: R\$ 29,94 15: R\$ 30,57
30: R\$ 31,18 45: R\$ 31,80 60: R\$ 32,44



TINTA TECIDO 250ML PINK
Código: 48626 Fábrica: TEK BOND Unidade: UN/1 F1 F4

UN: R\$ 29,94 AV: R\$ 29,94 15: R\$ 30,57
30: R\$ 31,18 45: R\$ 31,80 60: R\$ 32,44



TINTA TECIDO 250ML PRETO
Código: 48620 Fábrica: TEK BOND Unidade: UN/1 F1 F4

UN: R\$ 29,94 AV: R\$ 29,94 15: R\$ 30,57
30: R\$ 31,18 45: R\$ 31,80 60: R\$ 32,44



TINTA TECIDO 250ML ROXO
Código: 48627 Fábrica: TEK BOND Unidade: UN/1 F1 F4

UN: R\$ 29,94 AV: R\$ 29,94 15: R\$ 30,57
30: R\$ 31,18 45: R\$ 31,80 60: R\$ 32,44



TINTA TECIDO 250ML VERDE FLORESTA
Código: 48628 Fábrica: TEK BOND Unidade: UN/1 F1 F4

UN: R\$ 29,94 AV: R\$ 29,94 15: R\$ 30,57
30: R\$ 31,18 45: R\$ 31,80 60: R\$ 32,44



TINTA TECIDO 250ML VERMELHO
Código: 48622 Fábrica: TEK BOND Unidade: UN/1 F1 F4

UN: R\$ 35,93 AV: R\$ 35,93 15: R\$ 36,68
30: R\$ 37,41 45: R\$ 38,16 60: R\$ 38,93



TINTA TECIDO 250ML 501 AZUL TURQUESA
Código: 45004 Fábrica: ACRILEX Unidade: UN/1 F1 F4

UN: R\$ 35,93 AV: R\$ 35,93 15: R\$ 36,68
30: R\$ 37,41 45: R\$ 38,16 60: R\$ 38,93



TINTA TECIDO 250ML 503 AZUL CELESTE
Código: 45005 Fábrica: ACRILEX Unidade: UN/1 F1 F4

UN: R\$ 35,93 AV: R\$ 35,93 15: R\$ 36,68
30: R\$ 37,41 45: R\$ 38,16 60: R\$ 38,93



TINTA TECIDO 250ML 505 AMARELO OURO
Código: Fábrika: Unidade:
45006 ACRILEX UN/1
F1 F4

UN: R\$ 35,93 AV: R\$ 35,93 15: R\$ 36,68
30: R\$ 37,41 45: R\$ 38,16 60: R\$ 38,93



TINTA TECIDO 250ML 507 VERMELHO FOGO
Código: Fábrika: Unidade:
45007 ACRILEX UN/1
F1 F4

UN: R\$ 35,93 AV: R\$ 35,93 15: R\$ 36,68
30: R\$ 37,41 45: R\$ 38,16 60: R\$ 38,93



TINTA TECIDO 250ML 510 VERDE FOLHA
Código: Fábrika: Unidade:
50959 ACRILEX UN/1
F1 F4

UN: R\$ 35,93 AV: R\$ 35,93 15: R\$ 36,68
30: R\$ 37,41 45: R\$ 38,16 60: R\$ 38,93



TINTA TECIDO 250ML 511 VERDE BANDEIRA
Código: Fábrika: Unidade:
45008 ACRILEX UN/1
F1 F4

UN: R\$ 35,93 AV: R\$ 35,93 15: R\$ 36,68
30: R\$ 37,41 45: R\$ 38,16 60: R\$ 38,93



TINTA TECIDO 250ML 516 VIOLETA
Código: Fábrika: Unidade:
45009 ACRILEX UN/1
F1 F4

UN: R\$ 35,93 AV: R\$ 35,93 15: R\$ 36,68
30: R\$ 37,41 45: R\$ 38,16 60: R\$ 38,93



TINTA TECIDO 250ML 517 LARANJA
Código: Fábrika: Unidade:
45010 ACRILEX UN/1
F1 F4

UN: R\$ 35,93 AV: R\$ 35,93 15: R\$ 36,68
30: R\$ 37,41 45: R\$ 38,16 60: R\$ 38,93



TINTA TECIDO 250ML 519 BRANCO
Código: Fábrika: Unidade:
45003 ACRILEX UN/1
F1 F4

UN: R\$ 35,93 AV: R\$ 35,93 15: R\$ 36,68
30: R\$ 37,41 45: R\$ 38,16 60: R\$ 38,93



TINTA TECIDO 250ML 520 PRETO
Código: Fábrika: Unidade:
45011 ACRILEX UN/1
F1 F4

UN: R\$ 35,93 AV: R\$ 35,93 15: R\$ 36,68
30: R\$ 37,41 45: R\$ 38,16 60: R\$ 38,93



TINTA TECIDO 250ML 528 LILAS
Código: Fábrika: Unidade:
47455 ACRILEX UN/1
F1 F4

UN: R\$ 35,93 AV: R\$ 35,93 15: R\$ 36,68
30: R\$ 37,41 45: R\$ 38,16 60: R\$ 38,93



TINTA TECIDO 250ML 529 MARFIM
Código: Fábrika: Unidade:
47459 ACRILEX UN/1
F1 F4

UN: R\$ 35,93 AV: R\$ 35,93 15: R\$ 36,68
30: R\$ 37,41 45: R\$ 38,16 60: R\$ 38,93



TINTA TECIDO 250ML 531 MARROM
Código: Fábrika: Unidade:
45012 ACRILEX UN/1
F1 F4

UN: R\$ 35,93 AV: R\$ 35,93 15: R\$ 36,68
30: R\$ 37,41 45: R\$ 38,16 60: R\$ 38,93



TINTA TECIDO 250ML 537 ROSA
Código: Fábrika: Unidade:
45013 ACRILEX UN/1
F1 F4

UN: R\$ 35,93 AV: R\$ 35,93 15: R\$ 36,68
30: R\$ 37,41 45: R\$ 38,16 60: R\$ 38,93



TINTA TECIDO 250ML 538 AMARELO PES
Código: Fábrika: Unidade:
45036 ACRILEX UN/1
F1 F4

UN: R\$ 35,93 AV: R\$ 35,93 15: R\$ 36,68
30: R\$ 37,41 45: R\$ 38,16 60: R\$ 38,93



TINTA TECIDO 250ML 541 VERMELHO
Código: Fábrika: Unidade:
51224 ACRILEX UN/1
F1 F4

UN: R\$ 35,93 AV: R\$ 35,93 15: R\$ 36,68
30: R\$ 37,41 45: R\$ 38,16 60: R\$ 38,93



TINTA TECIDO 250ML 546 VERDE PINHEIRO
Código: Fábrika: Unidade:
47457 ACRILEX UN/1
F1 F4

UN: R\$ 35,93 AV: R\$ 35,93 15: R\$ 36,68
30: R\$ 37,41 45: R\$ 38,16 60: R\$ 38,93



TINTA TECIDO 250ML 584 AZUL INVERNO
Código: Fábrika: Unidade:
47454 ACRILEX UN/1
F1 F4

UN: R\$ 35,93 AV: R\$ 35,93 15: R\$ 36,68
30: R\$ 37,41 45: R\$ 38,16 60: R\$ 38,93



TINTA TECIDO 250ML 586 CORAL

Código: 47460 Fábrica: ACRILEX Unidade: UN/1
F1 F4

UN: R\$ 449,27 AV: R\$ 449,27 15: R\$ 458,63
30: R\$ 467,80 45: R\$ 477,16 60: R\$ 486,70

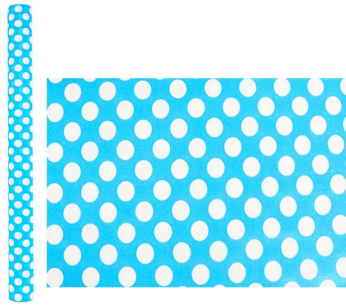

TNT 50 MTS EST 1,40 MTSX40GRS CHAPADO A

Código: 45180 Fábrica: SUPPER Unidade: RL/1
F1 F4

UN: R\$ 449,27 AV: R\$ 449,27 15: R\$ 458,63
30: R\$ 467,80 45: R\$ 477,16 60: R\$ 486,70



TNT 50 MTS EST 1,40 MTSX40GRS FORMATURA

Código: 45170 Fábrica: SUPPER Unidade: RL/1
F1 F4

UN: R\$ 449,27 AV: R\$ 449,27 15: R\$ 458,63
30: R\$ 467,80 45: R\$ 477,16 60: R\$ 486,70

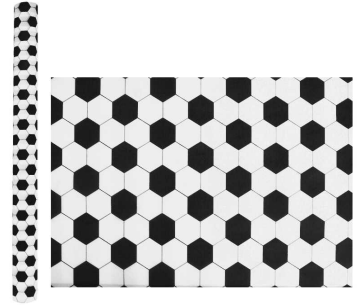

TNT 50 MTS EST 1,40 MTSX40GRS G FUTEBOL

Código: 45171 Fábrica: SUPPER Unidade: RL/1
F1 F4

UN: R\$ 449,27 AV: R\$ 449,27 15: R\$ 458,63
30: R\$ 467,80 45: R\$ 477,16 60: R\$ 486,70

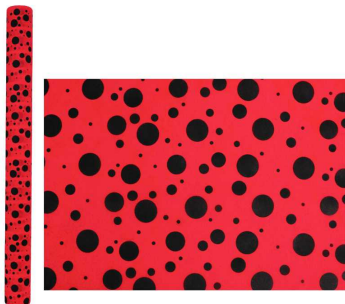

TNT 50 MTS EST 1,40 MTSX40GRS POA VERM

Código: 45175 Fábrica: SUPPER Unidade: RL/1
F1 F4

UN: R\$ 449,27 AV: R\$ 449,27 15: R\$ 458,63
30: R\$ 467,80 45: R\$ 477,16 60: R\$ 486,70



TNT 50 MTS EST 1,40 MTSX40GRS TEIAS

Código: 45177 Fábrica: SUPPER Unidade: RL/1
F1 F4

UN: R\$ 2,20 AV: R\$ 109,81 15: R\$ 112,10
30: R\$ 114,34 45: R\$ 116,63 60: R\$ 118,96



TNT 50 MTS 1,40 MTSX40GRS AMARELO

Código: 41620 Fábrica: SANTA FE Unidade: RL/50
F1 F4

UN: R\$ 2,20 AV: R\$ 109,81 15: R\$ 112,10
30: R\$ 114,34 45: R\$ 116,63 60: R\$ 118,96

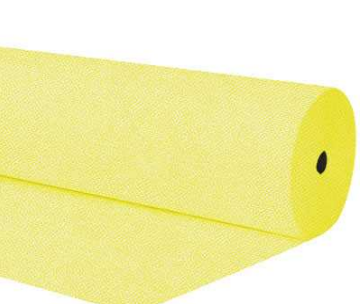

TNT 50 MTS 1,40 MTSX40GRS AMARELO CLARO

Código: 27307 Fábrica: SANTA FE Unidade: RL/50
F1 F4

UN: R\$ 2,20 AV: R\$ 109,81 15: R\$ 112,10
30: R\$ 114,34 45: R\$ 116,63 60: R\$ 118,96



TNT 50 MTS 1,40 MTSX40GRS AMARELO PADRA

Código: 39810 Fábrica: SANTA FE Unidade: RL/50
F1 F4

UN: R\$ 2,20 AV: R\$ 109,81 15: R\$ 112,10
30: R\$ 114,34 45: R\$ 116,63 60: R\$ 118,96



TNT 50 MTS 1,40 MTSX40GRS AZUL ANIL

Código: 30056 Fábrica: SANTA FE Unidade: RL/50
F1 F4

UN: R\$ 2,20 AV: R\$ 109,81 15: R\$ 112,10
30: R\$ 114,34 45: R\$ 116,63 60: R\$ 118,96



TNT 50 MTS 1,40 MTSX40GRS AZUL CELESTE

Código: 30058 Fábrica: SANTA FE Unidade: RL/50
F1 F4

UN: R\$ 2,20 AV: R\$ 109,81 15: R\$ 112,10
30: R\$ 114,34 45: R\$ 116,63 60: R\$ 118,96



TNT 50 MTS 1,40 MTSX40GRS AZUL CLARO

Código: 41622 Fábrica: GATE 72 Unidade: RL/50
F1 F4

UN: R\$ 2,20 AV: R\$ 109,81 15: R\$ 112,10
30: R\$ 114,34 45: R\$ 116,63 60: R\$ 118,96



TNT 50 MTS 1,40 MTSX40GRS AZUL IBIZA

Código: 39807 Fábrica: SANTA FE Unidade: RL/50
F1 F4

UN: R\$ 2,20 AV: R\$ 109,81 15: R\$ 112,10
30: R\$ 114,34 45: R\$ 116,63 60: R\$ 118,96



TNT 50 MTS 1,40 MTSX40GRS AZUL MARINHO

Código: 33716 Fábrica: SANTA FE Unidade: RL/50
F1 F4

UN: R\$ 2,20 AV: R\$ 109,81 15: R\$ 112,10
30: R\$ 114,34 45: R\$ 116,63 60: R\$ 118,96



TNT 50 MTS 1,40 MTSX40GRS AZUL OCEANO

Código: 39819 Fábrica: SANTA FE Unidade: RL/50
F1 F4

UN: R\$ 2,20 AV: R\$ 109,81 15: R\$ 112,10
30: R\$ 114,34 45: R\$ 116,63 60: R\$ 118,96



TNT 50 MTS 1,40 MTSX40GRS AZUL PADRAO

Código: 39808 Fábrica: SANTA FE Unidade: RL/50
F1 F4

UN: R\$ 2,20 AV: R\$ 109,81 15: R\$ 112,10
30: R\$ 114,34 45: R\$ 116,63 60: R\$ 118,96



TNT 50 MTS 1,40 MTSX40GRS AZUL ROYAL
Código: 27309 Fábrica: SANTA FE Unidade: RL/50 F1 F4

UN: R\$ 2,20 AV: R\$ 109,81 15: R\$ 112,10
30: R\$ 114,34 45: R\$ 116,63 60: R\$ 118,96



TNT 50 MTS 1,40 MTSX40GRS BEGE CLARO
Código: 39811 Fábrica: SANTA FE Unidade: RL/50 F1 F4

UN: R\$ 2,20 AV: R\$ 109,81 15: R\$ 112,10
30: R\$ 114,34 45: R\$ 116,63 60: R\$ 118,96



TNT 50 MTS 1,40 MTSX40GRS BEGE PADRAO
Código: 39812 Fábrica: SANTA FE Unidade: RL/50 F1 F4

UN: R\$ 2,20 AV: R\$ 109,81 15: R\$ 112,10
30: R\$ 114,34 45: R\$ 116,63 60: R\$ 118,96



TNT 50 MTS 1,40 MTSX40GRS BRANCO
Código: 27306 Fábrica: SANTA FE Unidade: RL/50 F1 F4

UN: R\$ 2,20 AV: R\$ 109,81 15: R\$ 112,10
30: R\$ 114,34 45: R\$ 116,63 60: R\$ 118,96

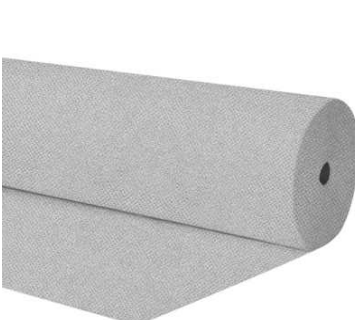

TNT 50 MTS 1,40 MTSX40GRS CINZA
Código: 33175 Fábrica: SANTA FE Unidade: RL/50 F1 F4

UN: R\$ 2,20 AV: R\$ 109,81 15: R\$ 112,10
30: R\$ 114,34 45: R\$ 116,63 60: R\$ 118,96



TNT 50 MTS 1,40 MTSX40GRS CINZA ESC
Código: 39806 Fábrica: SANTA FE Unidade: RL/50 F1 F4

UN: R\$ 2,20 AV: R\$ 109,81 15: R\$ 112,10
30: R\$ 114,34 45: R\$ 116,63 60: R\$ 118,96



TNT 50 MTS 1,40 MTSX40GRS GOIABA
Código: 39817 Fábrica: SANTA FE Unidade: RL/50 F1 F4

UN: R\$ 2,20 AV: R\$ 109,81 15: R\$ 112,10
30: R\$ 114,34 45: R\$ 116,63 60: R\$ 118,96



TNT 50 MTS 1,40 MTSX40GRS LARANJA
Código: 27312 Fábrica: SANTA FE Unidade: RL/50 F1 F4

UN: R\$ 2,20 AV: R\$ 109,81 15: R\$ 112,10
30: R\$ 114,34 45: R\$ 116,63 60: R\$ 118,96



TNT 50 MTS 1,40 MTSX40GRS LILAS
Código: 27308 Fábrica: SANTA FE Unidade: RL/50 F1 F4

UN: R\$ 2,20 AV: R\$ 109,81 15: R\$ 112,10
30: R\$ 114,34 45: R\$ 116,63 60: R\$ 118,96



TNT 50 MTS 1,40 MTSX40GRS MARRON
Código: 27311 Fábrica: SANTA FE Unidade: RL/50 F1 F4

UN: R\$ 2,20 AV: R\$ 109,81 15: R\$ 112,10
30: R\$ 114,34 45: R\$ 116,63 60: R\$ 118,96



TNT 50 MTS 1,40 MTSX40GRS PALHA PADRAO
Código: 39813 Fábrica: SANTA FE Unidade: RL/50 F1 F4

UN: R\$ 2,20 AV: R\$ 109,81 15: R\$ 112,10
30: R\$ 114,34 45: R\$ 116,63 60: R\$ 118,96



TNT 50 MTS 1,40 MTSX40GRS PRETO
Código: 27304 Fábrica: SANTA FE Unidade: RL/50 F1 F4

UN: R\$ 2,20 AV: R\$ 109,81 15: R\$ 112,10
30: R\$ 114,34 45: R\$ 116,63 60: R\$ 118,96



TNT 50 MTS 1,40 MTSX40GRS ROSA
Código: 27314 Fábrica: SANTA FE Unidade: RL/50 F1 F4

UN: R\$ 2,20 AV: R\$ 109,81 15: R\$ 112,10
30: R\$ 114,34 45: R\$ 116,63 60: R\$ 118,96



TNT 50 MTS 1,40 MTSX40GRS ROSA BB
Código: 41621 Fábrica: GATE 72 Unidade: RL/50 F1 F4

UN: R\$ 2,20 AV: R\$ 109,81 15: R\$ 112,10
30: R\$ 114,34 45: R\$ 116,63 60: R\$ 118,96



TNT 50 MTS 1,40 MTSX40GRS ROSA PADRAO
Código: 39809 Fábrica: SANTA FE Unidade: RL/50 F1 F4

UN: R\$ 2,20 AV: R\$ 109,81 15: R\$ 112,10
30: R\$ 114,34 45: R\$ 116,63 60: R\$ 118,96



TNT 50 MTS 1,40 MTSX40GRS ROSA PINK
Código: 33174 Fábrica: SANTA FE Unidade: RL/50 F1 F4

UN: R\$ 2,20 AV: R\$ 109,81 15: R\$ 112,10
30: R\$ 114,34 45: R\$ 116,63 60: R\$ 118,96



TNT 50 MTS 1,40 MTSX40GRS SALMAO
Código: 39816 Fábrica: SANTA FE Unidade: RL/50 F1 F4

UN: R\$ 2,20 AV: R\$ 109,81 15: R\$ 112,10
30: R\$ 114,34 45: R\$ 116,63 60: R\$ 118,96



TNT 50 MTS 1,40 MTSX40GRS VERDE
Código: 27310 Fábrica: SANTA FE Unidade: RL/50 F1 F4

UN: R\$ 2,20 AV: R\$ 109,81 15: R\$ 112,10
30: R\$ 114,34 45: R\$ 116,63 60: R\$ 118,96



TNT 50 MTS 1,40 MTSX40GRS VERDE BILHAR
Código: 39815 Fábrica: SANTA FE Unidade: RL/50 F1 F4

UN: R\$ 2,20 AV: R\$ 109,81 15: R\$ 112,10
30: R\$ 114,34 45: R\$ 116,63 60: R\$ 118,96



TNT 50 MTS 1,40 MTSX40GRS VERDE CLARO
Código: 30057 Fábrica: SANTA FE Unidade: RL/50 F1 F4

UN: R\$ 2,20 AV: R\$ 109,81 15: R\$ 112,10
30: R\$ 114,34 45: R\$ 116,63 60: R\$ 118,96



TNT 50 MTS 1,40 MTSX40GRS VERDE LIMAO
Código: 30054 Fábrica: SANTA FE Unidade: RL/50 F1 F4

UN: R\$ 2,20 AV: R\$ 109,81 15: R\$ 112,10
30: R\$ 114,34 45: R\$ 116,63 60: R\$ 118,96



TNT 50 MTS 1,40 MTSX40GRS VERDE MUSGO
Código: 39814 Fábrica: SANTA FE Unidade: RL/50 F1 F4

UN: R\$ 2,20 AV: R\$ 109,81 15: R\$ 112,10
30: R\$ 114,34 45: R\$ 116,63 60: R\$ 118,96



TNT 50 MTS 1,40 MTSX40GRS VERMELHO
Código: 27313 Fábrica: SANTA FE Unidade: RL/50 F1 F4

UN: R\$ 2,20 AV: R\$ 109,81 15: R\$ 112,10
30: R\$ 114,34 45: R\$ 116,63 60: R\$ 118,96



TNT 50 MTS 1,40 MTSX40GRS VINHO
Código: 39805 Fábrica: SANTA FE Unidade: RL/50 F1 F4

UN: R\$ 2,20 AV: R\$ 109,81 15: R\$ 112,10
30: R\$ 114,34 45: R\$ 116,63 60: R\$ 118,96



TNT 50 MTS 1,40 MTSX40GRS VIOLETA
Código: 39818 Fábrica: SANTA FE Unidade: RL/50 F1 F4

UN: R\$ 399,35 AV: R\$ 399,35 15: R\$ 407,67
30: R\$ 415,82 45: R\$ 424,14 60: R\$ 432,62



TNT EST LAM 50MTX1,40 MTX40GRS XADR AZUL
Código: 42725 Fábrica: SANTA FE Unidade: RL/1 F1 F4

UN: R\$ 399,35 AV: R\$ 399,35 15: R\$ 407,67
30: R\$ 415,82 45: R\$ 424,14 60: R\$ 432,62



TNT EST LAM 50MTX1,40 MTX40GRS XADR PTO
Código: 42726 Fábrica: SANTA FE Unidade: RL/1 F1 F4

UN: R\$ 399,35 AV: R\$ 399,35 15: R\$ 407,67
30: R\$ 415,82 45: R\$ 424,14 60: R\$ 432,62



TNT EST LAM 50MTX1,40 MTX40GRS XADR VERD
Código: 42723 Fábrica: SANTA FE Unidade: RL/1 F1 F4

UN: R\$ 399,35 AV: R\$ 399,35 15: R\$ 407,67
30: R\$ 415,82 45: R\$ 424,14 60: R\$ 432,62



TNT EST LAM 50MTX1,40 MTX40GRS XADR VERM
Código: 42724 Fábrica: SANTA FE Unidade: RL/1 F1 F4

UN: R\$ 1,40 AV: R\$ 13,97 15: R\$ 14,26
30: R\$ 14,54 45: R\$ 14,83 60: R\$ 15,13

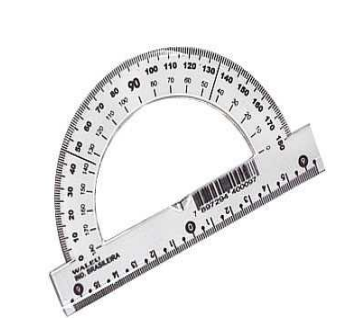

TRANSFERIDOR CHANFRADO 180 GRAUS 10X1
Código: 14481 Fábrica: WALEU Unidade: PT/10 F1 F4

UN: R\$ 1,73 AV: R\$ 17,32 15: R\$ 17,68
30: R\$ 18,04 45: R\$ 18,40 60: R\$ 18,77

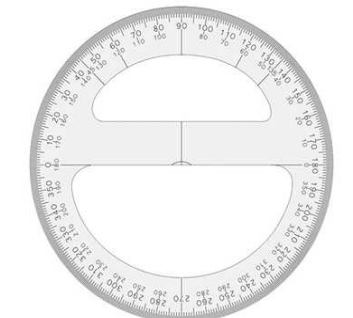

TRANSFERIDOR CHANFRADO 360 GRAUS 10X1
Código: 453 Fábrica: WALEU Unidade: PT/10 F1 F4

UN: R\$ 19,96 AV: R\$ 19,96 15: R\$ 20,37
30: R\$ 20,78 45: R\$ 21,20 60: R\$ 21,62

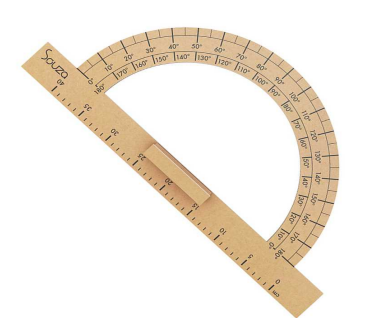

TRANSFERIDOR MDF 180 GRAUS
Código: 49904 Fábrica: SOUZA Unidade: UN/1 F1 F4

UN: R\$ 20,96 AV: R\$ 20,96 15: R\$ 21,39
30: R\$ 21,82 45: R\$ 22,26 60: R\$ 22,70



TRIO DE MESA ACR QUAD CRISTAL 550

Código: Fábrika: Unidade:
41962 CARBRINK UN/1
F1 F4

UN: R\$ 20,96 AV: R\$ 20,96 15: R\$ 21,39
30: R\$ 21,82 45: R\$ 22,26 60: R\$ 22,70



TRIO DE MESA ACR QUAD FUME 551

Código: Fábrika: Unidade:
41961 CARBRINK UN/1
F1 F4

UN: R\$ 11,43 AV: R\$ 11,43 15: R\$ 11,67
30: R\$ 11,90 45: R\$ 12,14 60: R\$ 12,38



TRIO DE MESA PLAST QUAD PRETO 555

Código: Fábrika: Unidade:
45413 CARBRINK UN/1
F1 F4

UN: R\$ 15,24 AV: R\$ 15,24 15: R\$ 15,55
30: R\$ 15,86 45: R\$ 16,18 60: R\$ 16,51



TRIO PORTA CANETAS CLIPS LEMBRETES CRIST

Código: Fábrika: Unidade:
47592 MAXCRIL UN/1
F1 F4

UN: R\$ 15,24 AV: R\$ 15,24 15: R\$ 15,55
30: R\$ 15,86 45: R\$ 16,18 60: R\$ 16,51



TRIO PORTA CANETAS CLIPS LEMBRETES FUME

Código: Fábrika: Unidade:
29763 MAXCRIL UN/1
F1 F4

UN: R\$ 2,74 AV: R\$ 2,74 15: R\$ 2,79
30: R\$ 2,85 45: R\$ 2,91 60: R\$ 2,96



UMEDecedor MOLHA DEDOS ESPUMA 01

Código: Fábrika: Unidade:
43328 CARBRINK UN/1
F1 F4

UN: R\$ 2,39 AV: R\$ 2,39 15: R\$ 2,44
30: R\$ 2,48 45: R\$ 2,53 60: R\$ 2,59



UMIDIFICADOR DEDOS 12 GRs (CREMA) 206

Código: Fábrika: Unidade:
22994 CARBRINK UN/1
F1 F4

UN: R\$ 0,55 AV: R\$ 109,81 15: R\$ 112,10
30: R\$ 114,34 45: R\$ 116,63 60: R\$ 118,96



VARETA P/PASTA SUSPENSA 200UN

Código: Fábrika: Unidade:
47193 POLYCART PT/200
F1 F4

UN: R\$ 13,95 AV: R\$ 13,95 15: R\$ 14,24
30: R\$ 14,52 45: R\$ 14,81 60: R\$ 15,11



VERNIZ ACRILICO BRILHANTE 100ML 15010

Código: Fábrika: Unidade:
41952 ACRILEX UN/1
F1 F4

UN: R\$ 29,94 AV: R\$ 29,94 15: R\$ 30,57
30: R\$ 31,18 45: R\$ 31,80 60: R\$ 32,44



VERNIZ GERAL 100ML 16010

Código: Fábrika: Unidade:
45818 ACRILEX UN/1
F1 F4

UN: R\$ 22,95 AV: R\$ 22,95 15: R\$ 23,43
30: R\$ 23,90 45: R\$ 24,38 60: R\$ 24,87



VERNIZ SPRAY 350ML 250G BRILHANTE

Código: Fábrika: Unidade:
42228 TEK BOND UN/1
F1 F4

UN: R\$ 29,94 AV: R\$ 29,94 15: R\$ 30,57
30: R\$ 31,18 45: R\$ 31,80 60: R\$ 32,44



VERNIZ SPRAY 350ML 250G FOSCO

Código: Fábrika: Unidade:
48648 TEK BOND UN/1
F1 F4

UN: R\$ 0,15 AV: R\$ 7,48 15: R\$ 7,63
30: R\$ 7,79 45: R\$ 7,94 60: R\$ 8,10



VISOR E ETIQ P/PASTA SUSPENSA 50X1

Código: Fábrika: Unidade:
42699 DELUCAS PT/50
F1 F4